

dix heures dix[®]

20 20

20 21



dix heures dix

ÉDITEUR FRANÇAIS DE LUMINAIRES DÉCORATIFS DIFFUSANT UNE BELLE LUMIÈRE.
DESIGNER AND MANUFACTURER OF BEAUTIFUL LIGHTING FORMS.
FRANZÖSISCHE MANUFAKTUR FÜR DEKORATIVES STIMMUNGSLICHT.

Conception et fabrication en France.

CÉLESTE
04



IRIS
16



ZIGOUZI
34



COLONNE
44



APHRODITE
52



JOSEPH
58



PERLES
08



ZIG
38



PARAVENT
50



LA SUSPENSION
54

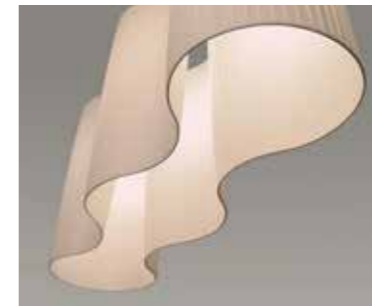

NATURE
60



CHARLESTON
30

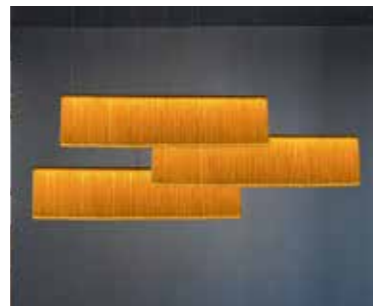

LA RONDE
40

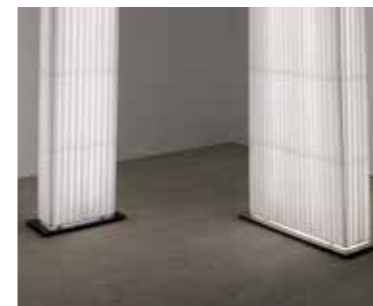

ÉTOILE
56



RUBAN
62



CÉLESTE

design Fabrice Berrux

"L'idée de cette suspension m'est venue quand des amis m'ont demandé de réfléchir à un éclairage adapté à la grande table de repas circulaire de leur appartement haussmannien. La hauteur du plafond incitait à concevoir un éclairage coiffant, léger et aérien.

Céleste est conçue comme un élément architectural suspendu. **C'est une voûte lumineuse.** Elle couvre d'une lumière douce et protectrice l'espace du repas.

Depuis, je l'imaginé dans différentes tailles et dans un format ovale plus adapté à des tables rectangulaires."

"The idea for this range of hanging lamps came to me naturally when friends asked me to think about a pendant suitable for the big, circular table meal from their Hausmannian apartment. The height of the ceiling prompted the design of a styling but lightweight and airy hanging light.

Céleste is conceived as a suspended architectural element. **It's a luminous vault.**

It covers the dining space with a soft and protective light. Since then, I imagined it in different sizes and in an oval format more suitable for rectangular tables."

Fabrice BERRUX

01
réf. H647 Céleste Ø 100 cm noir



01



03



04

CÉLESTE. Trois dimensions de suspensions en aluminium anodisé noir ou or et éclairage LED.
Three dimensions of pendants in black or gold anodised aluminium. Warm white LED lighting.

02
réf H646 Céleste Ø 80 cm noir
réf H647 Céleste Ø 100 cm noir
réf H648 Céleste Ø 120 cm noir

03 / 04
réf H647 Céleste Ø 100 cm noir

PERLES design Fabrice Berrux

"Quand j'ai commencé à dessiner cette collection, j'ai fait le parallèle entre le plaisir de choisir un luminaire et celui d'un homme ou d'une femme d'accessoiriser sa tenue vestimentaire d'un **bijou** (un bracelet, une bague, un collier ou une broche).

La collection PERLES est constituée de colliers, bagues, bracelets, pendentifs pour illuminer les intérieurs. Elle bénéficie du savoir faire décoratif d'Atelier Sedap dans l'art du moulage ainsi que de l'apport de nouvelles finitions métallisées dignes de l'univers de la joaillerie."

*"When I started drawing this news range of luminaires, I drew the parallel between the pleasure in choosing lighting that accessorizes a dining table, desk, sofa and that of a man or woman who decides to accessorize his dress code with a piece of **jewelry** (a bracelet, a ring, necklace or brooch).*

This art of bringing a bit of femininity into elegance (of one's daily life), I tried to play it in imagining the PERLES collection for dix heures dix.

The PERLES collection consists of necklaces, rings, bracelets, pendants to illuminate interiors.

It benefits from Atelier Sedap's decorative know-how in the art of casting as well as the addition of new metallic finishes derived from the world of Jewelry."

Fabrice BERRUX

01
réf. H703 Perles Ø 80 cm noir mat



01



02

PERLES. Suspensions en composite minéral et éclairage LED direct.
 Pendants in mineral composite.
 Warm white, direct LED lighting.

02

réf. H704 Perles Ø 100 cm or-laiton
réf. H703 Perles Ø 80 cm or-laiton
réf. H702 Perles Ø 65 cm or-laiton



Fabrice Berrux

Fondée par le designer Fabrice Berrux, dix heures dix est une marque française de luminaires fabriqués en France qui, depuis 20 ans, développe des collections dont la principale ambition est de diffuser « une belle lumière ».

Dix heures dix se singularise par l'exigence d'un design créatif et d'un savoir-faire artisanal français.

Founded by designer and creator Fabrice Berrux, dix heures dix is a French brand of lighting fixtures made in France which, for 20 years, develop collections whose main ambition is to spread "a beautiful light".

The balance between a rigorous approach of industrial design and the wealth of artisanal know-how allows the company to offer an innovative and high-end offer.



La fabrication

Issue d'une nouvelle technique de moulage d'un composite minéral, la collection PERLES profite du savoir-faire Atelier Sedap pour dix heures dix. Depuis les dessins du designer, les PERLES sont passées par la conception 3D, du prototypage sur machine-outil cinq axes pour finalement naître tous les jours entre les mains expertes de notre équipe de moulage.

Based on a new molding technique for a mineral composite, the PERLES collection takes advantage of Atelier Sedap know-how for dix heures dix.

From the designer's drawings, the PERLES collection brilliantly passed the stages of 3D design, prototyping on a five-axis machine tool and technical / aesthetic validation, to be born every day in the white plaster hands of our molding teams...



PERLES. Suspensions verticales en composite minéral et éclairage LED direct.
Pendants in mineral composite. Warm white, direct LED lighting.

03
réf. H705 Perles blanc

PERLES. Suspensions horizontales en composite minéral et éclairage LED direct.
Pendants in mineral composite.

04
réf. H706 Perles or-laiton



03



04



05

PERLES. Appliques en composite minéral et éclairage LED indirect.
Wall lamps in mineral composite. Warm white, indirect LED lighting.

05
réf. H710 Perles 63 cm or-laiton

PERLES. Lampadaire en composite minéral et éclairage LED direct.
Floor lamp in mineral composite. Warm white, direct LED lighting.

06
réf. H700 Perles 180 cm noir mat



06



IRIS

design Fabrice Berrux

Iris est un soleil d'intérieur.

Sa lumière est puissante, douce et diffuse à la manière d'un astre.

Au cours de ces trois dernières années la gamme Iris s'est bien développée avec différentes versions de lampadaires, de suspensions, d'appliques et de lampes à poser.

Iris is an interior sun.

Its light is powerful, soft and diffuse.

While using a linear LED source, the light of Iris seems radiating like a star.

During for the past three years, the Iris range has expanded with different versions of floor lamps, pendant lights, wall lights and table lamps.

01
réf. H590 Iris Ø 80cm ivoire

01



02



03



04

IRIS. Lampadaire en ruban blanc ou ivoire et éclairage LED.
Piètement en métal noir grainé.
Interrupteur/variateur à pied.
Floor lamps in white or ivory ribbon. Warm white LED lighting. Foot dimmer switch.

02
réf. **H591 Iris** Ø 60cm ivoire

03
réf. **H590 Iris** Ø 80cm ivoire
réf. **H591 Iris** Ø 60cm ivoire

04
réf. **H590 Iris** Ø 80cm blanc



05

IRIS. Liseuse en ruban blanc ou ivoire et éclairage LED variable.
Reading lamp in white or ivory ribbon.
Warm white dimmable LED lighting.

05
réf. H628 Iris Ø50 cm ivoire



La conception

"Depuis des années mon rôle privilégié de designer conseiller artistique de dix heures dix me permet de faire exister des idées au fil de mon inspiration. Iris est le fruit de ce « Work In Progress ». C'est une synthèse poétique et fonctionnelle des savoir-faire actuels de dix heures dix : le travail de confection textile et les structures cintrées en aluminium."

"For years, my privileged role of designer + artistic advisor for dix heures dix allows me to experiment with ideas thread of my inspiration. Iris is the fruit of this permanent "Work In Progress". It's a poetic and functional synthesis for some of the dix heures dix know-how: textile wrapping work and bent aluminum structures."

Fabrice BERRUX

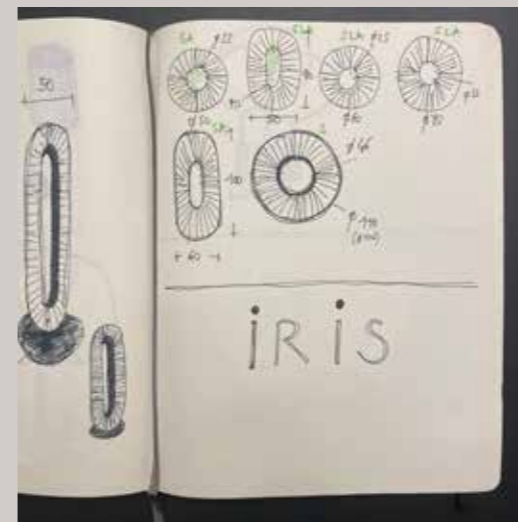

La fabrication

Après de minutieuses étapes notamment de cintrage aluminium et de soudure, les IRIS finissent par prendre vie entre les mains de nos couturières grâce à un enrubannage méticuleux.

After the meticulous steps of bending aluminum to the millimeter, welding with a magnifying glass and assembling the structures with the correct balance, the IRIS finally come to life in the hands of our seamstresses by a textile wrapping as meticulous as time-consuming... Based near Nantes (France), the dix heures dix young production team, overwhelmingly female, makes the entire collection by hand.





06



07



08

IRIS. Lampe à poser en ruban blanc ou ivoire et éclairage LED variable.
Table lamps in white or ivory ribbon. Warm white dimmable LED lighting.

06

réf. H626 Iris Ø50 cm ivoire

07

réf. H625 Iris Ø40 cm blanc

IRIS. Lampe de chevet orientable en ruban blanc ou ivoire et éclairage LED variable.
Swivel bedside lamp in white or ivory ribbon. Warm white dimmable LED lighting.

08

réf. H627 Iris Ø40 cm ivoire



09



10



11



12

IRIS. Suspensions verticales
en ruban blanc ou ivoire et
éclairage LED.
*Vertical pendants in white or
ivory ribbon.*

09
réf. H593 Iris Ø80 cm ivoire
réf. H594 Iris Ø60 cm ivoire

12
réf. H649 Iris Ø40 cm ivoire

**IRIS. Suspensions horizon-
tales** en ruban blanc ou ivoire
et éclairage LED.
*Horizontal pendants in white or
ivory ribbon.*

10
réf. H596 Iris Ø80 cm blanc

11
réf. H650 Iris Ø40 cm blanc



13

IRIS DELTA. Suspension horizontale en ruban blanc ou ivoire et éclairage LED.
Horizontal pendant in white or ivory ribbon.

13/14
réf. **H668 Iris delta** 3 x Ø60 cm blanc



14



15

IRIS. Appliques en ruban blanc ou ivoire et éclairage LED.
Wall lamps in white or ivory ribbon. Warm white LED lighting.

15
réf. H599 Iris Ø80 cm ivoire

16
réf. H600 Iris Ø60 cm blanc



16



17

IRIS. Plafonnier en ruban blanc ou ivoire et éclairage LED.
Ceiling light in white or ivory ribbon. Warm white LED lighting.

17
réf.H621 Iris Ø 80cm blanc

18
réf.H620 Iris Ø 60cm blanc



18

CHARLESTON

design Fabrice Berrux

"J'aime considérer **la lumière comme une présence**.

D'ailleurs, j'ai souvent développé des luminaires qui pouvaient s'apparenter à des silhouettes ou plus précisément à des corps lumineux. En utilisant les nouvelles sources d'éclairage LED, je cherche à sublimer le rayonnement lumineux. Les franges de la collection CHARLESTON donnent vie à la lumière par un léger mouvement, une vibration."

"I like to think of **light as presence**.

Besides, I often developed lights that could be compared to silhouettes or more precisely to luminous bodies. While fully exploiting the benefits of the new lighting sources, I'm trying to make visible the rays of light. This is the exercise in which I delivered myself with the Iris range with wrapped rings evoking a Sun. With the CHARLESTON collection, fringes allow me to materialize light and bring it to life by a slight movement, a vibration."

Fabrice BERRUX



01

CHARLESTON. Suspensions en franges or ou blanc éclairage LED.
Pendants in white or gold fringes and warm white LED lighting.

01
réf. **H658 Charleston** 150 cm blanc

CHARLESTON. Suspensions en franges or ou blanc éclairage LED.
Pendants in white or gold fringes and warm white LED lighting.

02
réf. **H657 Charleston** 120 cm or

02



CHARLESTON. Suspensions en franges blanc/blanc ou blanc/or et éclairage LED.
Pendants in white/white or white/gold fringes and warm white LED lighting.

04
réf. H654 Charleston Ø65 cm
blanc/blanc

05
réf. H653 Charleston Ø80 cm
blanc/or



04



05



ZIGOUZI design Fabrice Berrux

"Tout est parti d'un dessin, **une ligne continue tracée avec indolence**. Un geste que j'aurais pu faire avec une lampe torche, et que j'aurais photographié avec un temps de pose adapté.

Et puis ce dessin est devenu une volute fine, légère et lumineuse que j'ai suspendu dans un espace.

ZIGOUZI était né.

Cette suspension existe dans 4 dimensions. Les deux plus petites reprennent la géométrie d'un trèfle à 3 feuilles en plan, et les deux plus grandes celle d'un trèfle à 4 feuilles. Bien entendu, les 4 modèles portent bonheur et diffusent une belle lumière."

*"It all started with a drawing, **a continuous line drawn indolently**. A gesture that I could have done with a flashlight, and that I would have photographed with an appropriate exposure time.*

And then this drawing became a fine, light and luminous volute that I hung in a space.

ZIGOUZI was born.

This hanging light exists in 4 dimensions.

The two smaller ones take the geometry of a 3-leaf clover in plan, and the two larger ones that of a 4-leaf clover. Of course, the 4 models bring good luck and diffuse a beautiful diffused light."

Fabrice Berrux

ZIGOUZI. Quatre dimensions de suspensions en aluminium anodisé noir ou or et éclairage LED.

Four dimensions of pendants in black or gold anodised aluminium.

Warm white LED lighting.

01

réf. H635 Zigouzi Ø 120 cm noir



02

ZIGOUZI. Quatre dimensions de suspensions en aluminium anodisé noir ou or et éclairage LED.
Four dimensions of pendants in black or gold anodised aluminium. Warm white LED lighting.

02
réf. H633 Zigouzi Ø 70 cm noir

03
 détail

04
réf. H633 Zigouzi Ø 70 cm or



03



04



ZIG

design Fabrice Berrux



02



03

ZIG. Quatre dimensions de suspensions en aluminium anodisé noir ou or et éclairage LED direct/indirect.
Four dimensions of pendants in black or gold anodised aluminium. Warm white, direct/indirect LED lighting.

01
réf. H643 Zig 150 cm noir

02/03
réf. H644 Zig 100 cm or

01

LA RONDE design Fabrice Berrux

"Depuis longtemps je cherchais à développer une collection de luminaires interprétant de manière contemporaine le thème de l'abat jour. Pour la gamme RONDE, j'ai imaginé un abat jour évidé qui évoque **la légèreté des ronds de fumée**. Les suspensions RONDE sont à la fois décoratives et minimalistes. Leur géométrie simple habille l'espace. Leur finesse et leur sobriété incite à réaliser des compositions aériennes avec les trois dimensions disponibles."

*"I have been looking for a long time to develop a collection of lights with a contemporary interpretation of the theme of the lampshade. For LA ROUND, I imagined a hollow lampshade that evokes **the lightness of smoke rings**. LA RONDE pendant lights are both decorative and minimalist. Their simple geometry dresses the space. Their finesse and sobriety invite you to create aerial compositions with the three dimensions available."*

Fabrice BERRUX

01
réf. H631 La Ronde Ø80 cm ivoire

01





02

LA RONDE. Suspensions en ruban blanc ou ivoire et éclairage LED.
Pendants in white or ivory ribbon. Warm white LED lighting.

02
réf. H630 La Ronde Ø 65 cm blanc

03
réf. H660 La Ronde Ø 50 cm ivoire



03



04

LA RONDE. Lampadaire en ruban blanc ou ivoire et éclairage LED.
 Interrupteur/variateur à pied.
Floor lamp in white or ivory ribbon. Warm white LED lighting. Foot dimmer switch.

04
réf. H642 La Ronde Ø 80cm blanc

COLONNE

design Fabrice Berrux

"Colonne est la première gamme complète de luminaires que j'ai créée. Je souhaitais qu'elle s'inspire du savoir faire traditionnel des abat jour en tissu plissé. Autant les lampadaires que les suspensions ou même les appliques, tous revendiquent une présence décorative aussi bien éteints qu'allumés. Leur **intemporalité** permet je l'espère de se projeter dans un avenir lumineux avec eux."

"Colonne is the first full range of lights that I created. I wanted it inspired from the traditional know-how of lampshades in pleated fabric. As floor-,table-, wall-, hanging lights, all lamps claim a decorative presence as well OFF than ON. Their **timelessness** allows I hope to project into a bright future with them."

Fabrice BERRUX

01
réf. H168 Colonne 165 cm blanc

01

dix heures dix





02



03

COLONNE. Lampadaires en ruban. Socle en métal gris ou noir grainé, en inox brossé ou en marbre.

Floor lamps and table lamp in ribbon. Metal foot, brushed stainless steel or marble foot.

02

réf. H161 Colonne 190 cm ivoire

03

réf. H198 Colonne 240 cm rouge

réf. H199 Colonne 280 cm blanc

04

Détail socle marbre de Carrare.
Marble foot.



04



05



06

COLONNE. Suspensions de 62 cm à 190 cm en ruban. Hauteur réglable. Câble d'alimentation transparent. Option: alimentation par le bas avec interrupteur ou variateur.
Pendants in ribbon. Adjustable height. Transparent power cable. Optional: bottom power supply.

05

réf. H672 Colonne LED 62 cm blanc
réf. H673 Colonne LED 90 cm ivoire
réf. H674 Colonne LED 120 cm rouge

06

réf. H672 Colonne LED 62 cm blanc



PARAVENT design Fabrice Berrux



02

PARAVENT. Lampadaires en ruban. Socle en métal noir grainé, en inox brossé ou en marbre.
Floor lamps in ribbon.
Black metal, brushed stainless steel or marble foot.

01
réf. H188 Paravent 60 cm LED

02
réf. H189 Paravent 30 cm LED
réf. H188 Paravent 60 cm LED

03
réf. H180 Paravent 90 cm E14



03

APHRODITE ARTEMIS ATHENA design Fabrice Berrux

Lampadaires en tissu stretch sur structure acier.
Socle en acier noir grainé ou en inox brossé.
Textile déhoussable et lavable.
*Floor lamps in stretch with steel structure.
Black metal foot or brushed stainless steel foot.
Removable stretch cover, suitable for washing.*

01
réf. H314 Aphrodite 195 cm
réf. H313 Athéna 218 cm
réf. H315 Artémis 167 cm



01

LA SUSPENSION design Fabrice Berrux



01

LA SUSPENSION. Deux dimensions de **suspension** en ruban.
Two dimensions of pendants in ribbon.

01/02
réf. H412 **La Suspension** blanc



02



01

ÉTOILE

design Fabrice Berrux



02

ÉTOILE. Suspension en ruban.
Option avec diffusant en PMMA
satiné.
*Pendant in ribbon. Option with a
diffusing disc in frosted PMMA.*

01
réf. H410 Étoile noir

02
réf. H410 Étoile noir avec option
diffusant inférieur



01

JOSEPH. Trois dimensions de **suspensions** en feutre.
Three dimensions of pendants in felt textile.

01
réf. H445 Joseph Ø 70 cm camaïeu de gris

02
réf. H446 Joseph Ø 45 cm gris anthracite

03
réf. H447 Joseph Ø 20 cm gris anthracite

JOSEPH design Ludovic Roth



02



03

La conception

Hommage discret à Joseph Beuys, cette collection de suspensions est réalisée en feutre à partir du même emporte pièce. Le luminaire joue de la multiplication d'un seul élément constituant l'abat-jour, permettant d'augmenter ou de réduire ses dimensions en fonction du nombre de pièces cousues ensemble et ainsi créer une collection.

Discreet tribute to Joseph Beuys, the JOSEPH collection of hanging lamps is made of felt shaped from the same cookie cutter. The light plays on the multiplication of a single element creating the lampshade, allowing increase or decrease its dimensions depending on the number of pieces sewn together and thus creating a collection of sizes.

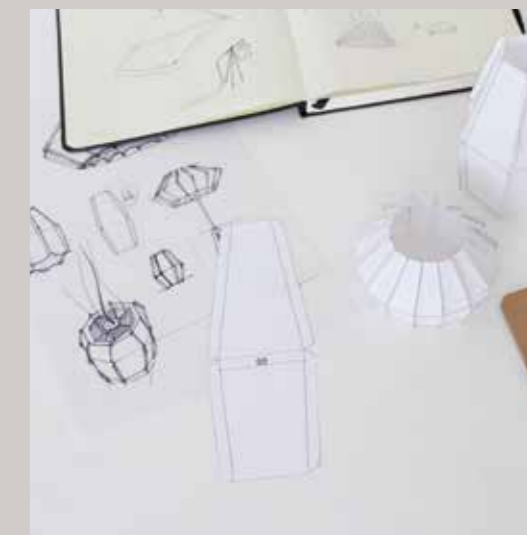

NATURE design Fabrice Berrux



01

NATURE. Trois dimensions de lampadaires en tissu stretch blanc sur structure acier.
Textile déhoussable et lavable.
Three dimensions of floor lamps in white stretch with steel structure. Removable stretch cover, suitable for washing.

01
réf. H481 Nature 200 cm
réf. H482 Nature 185 cm
réf. H483 Nature 170 cm

02
réf. H482 Nature 185 cm

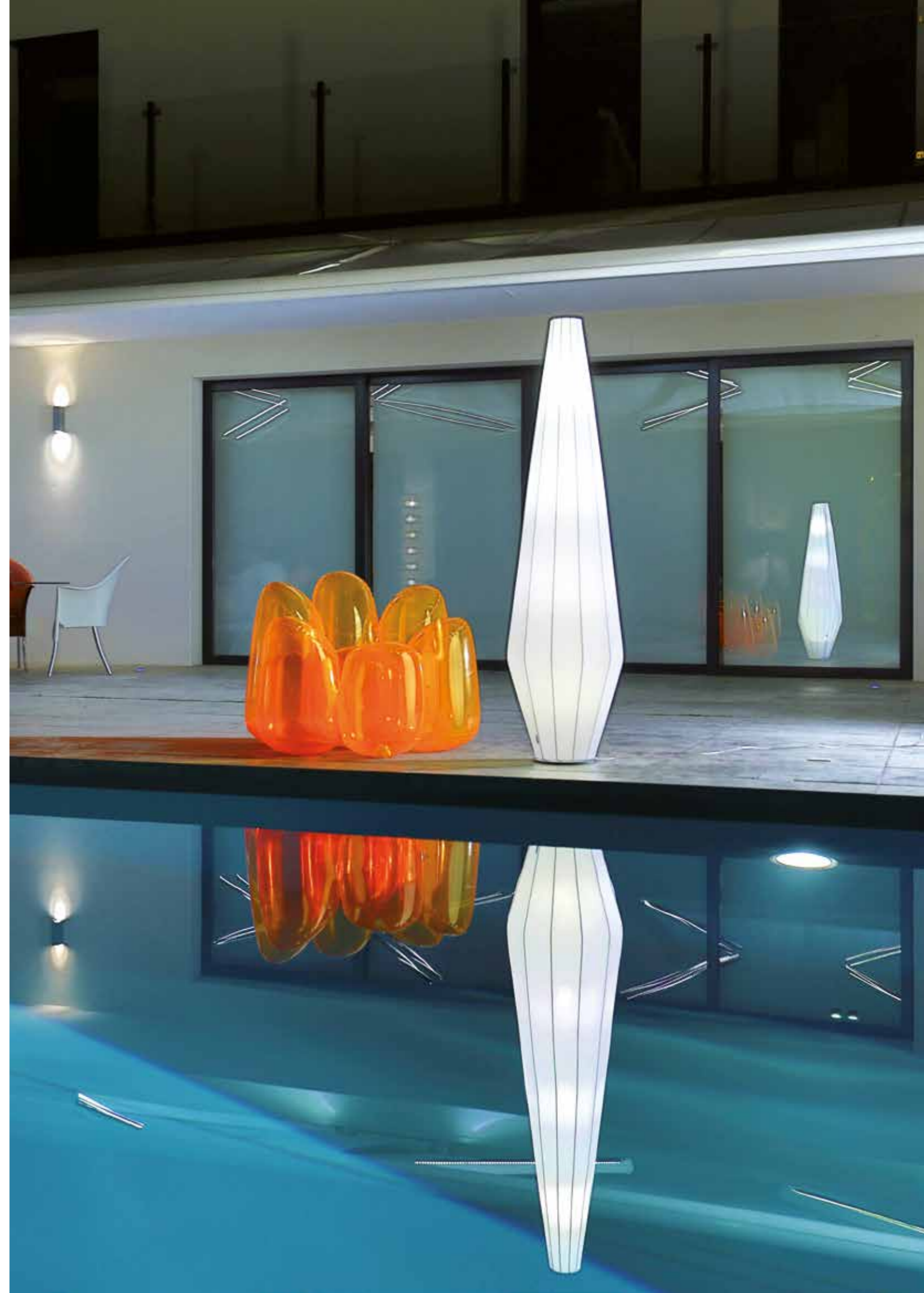

02



RUBAN design Fabrice Berrux



02



03

RUBAN. Trois dimensions de suspensions en ruban.
Three dimensions of pendants in ribbon.

01
réf. H268 Ruban Ø 70 cm

02
réf. H267 Ruban Ø 90 cm

03
réf. H269 Ruban Ø 45 cm

04
réf. H268 Ruban Ø 70 cm rouge



04

INFORMATIONS TECHNIQUES

Charleston suspensions linéaires

Suspensions en franges blanc ou or et éclairage LED direct.
Alimentation ON/OFF 0-10V. Câble d'alimentation transparent.

Pendants in white or gold fringes. Warm white LED lighting (ON/OFF 0-10V dimming). Transparent power cable.

RÉF.	DIMENSIONS	SOURCES	CERTIFICATIONS
H655	H. 22-30 CM L 60 CM	LEDs - 27W - 2 700 °K - 2 000 Lm*	IP 20 CE UL standard compatible
H656	H. 22-30 CM L 90 CM	LEDs - 40W - 2 700 °K - 3 000 Lm*	IP 20 CE UL standard compatible
H657	H. 22-30 CM L 120 CM	LEDs - 53W - 2 700 °K - 4 000 Lm*	IP 20 CE UL standard compatible
H658	H. 22-30 CM L 150 CM	LEDs - 66W - 2 700 °K - 5 000 Lm*	IP 20 CE UL standard compatible

Option dimmable H655/H656/H657/H658 : variation DALI - Triac

FINITION FRANGES/FRINGES/FRAENSEN

blanc/white or/gold

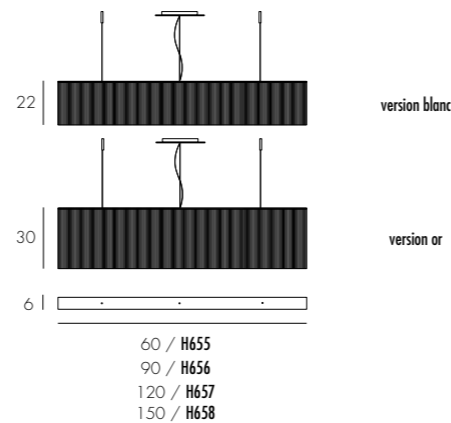

Charleston suspensions circulaires

Suspensions en franges blanc ou blanc/or et éclairage LED direct.
Alimentation ON/OFF 0-10V. Câble d'alimentation transparent.

Pendants in white or white/gold fringes. Warm white LED lighting (ON/OFF 0-10V dimming). Transparent power cable.

RÉF.	DIMENSIONS	SOURCES	CERTIFICATIONS
H654	H. 22-30 CM Ø 65 CM - 4 KG	LEDs - 55W - 2 700 °K - 3 800 Lm*	IP 20 CE UL standard compatible
H653	H. 22-30 CM Ø 80 CM - 4 KG	LEDs - 70W - 2 700 °K - 5 000 Lm*	IP 20 CE UL standard compatible

Option dimmable H654 : variation DALI - Triac

Option dimmable H653 : variation DALI

FINITION FRANGES/FRINGES/FRAENSEN

blanc/white or/gold

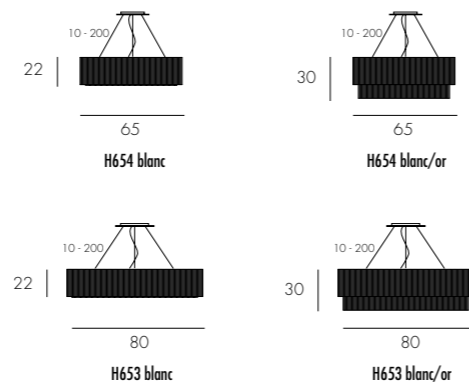

Céleste suspensions

Suspensions en aluminium anodisé noir ou or et éclairage LED.
Alimentation ON/OFF 0-10V. Câble d'alimentation transparent.

Pendants in black or gold anodised aluminium. Warm white LED lighting (ON/OFF 0-10V dimming). Transparent power cable.

RÉF.	DIMENSIONS	SOURCES	CERTIFICATIONS
H646	H. 14 Ø. 80 CM - 2,9 KG	LEDs - 70W - 2 700 °K - 6 370 Lm*	IP 20 CE UL standard compatible
H647	H. 18 Ø. 100 CM - 3,2 KG	LEDs - 90W - 2 700 °K - 8 180 Lm*	IP 20 CE UL standard compatible
H648	H. 21 Ø. 120 CM - 3,5 KG	LEDs - 110W - 2 700 °K - 9 800 Lm*	IP 20 CE UL standard compatible
H679	160 x 80 CM H. 17 CM - 4 KG	LEDs - 120W - 2 700 °K - 10 800 Lm*	IP 20 CE UL standard compatible

Option dimmable H646/H647/H648/H679 : variation DALI

Option dimmable H646 : variation DALI - Triac

FINITION ALUMINIUM

noir/black or/gold

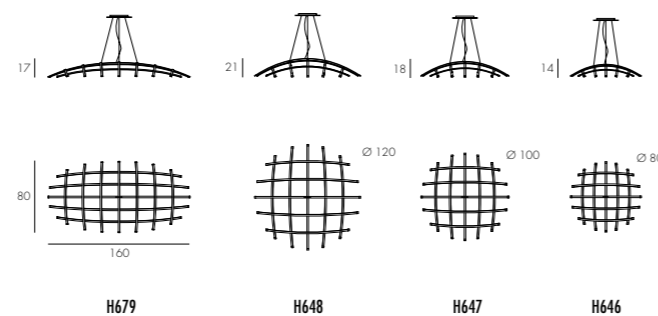

Ronde suspensions

Suspensions en ruban blanc ou ivoire et éclairage LED.
Alimentation ON/OFF 0-10V. Câble d'alimentation transparent.

Pendants in white or ivory ribbon. Warm white LED lighting (ON/OFF 0-10V dimming). Transparent power cable.

RÉF.	DIMENSIONS	SOURCES	CERTIFICATIONS
H660	H. 16 Ø. 50 CM - 2,9 KG	LEDs - 50W - 2 700 °K - 3 400 Lm*	IP 20 CE UL standard compatible
H630	H. 16 Ø. 60 CM - 2,9 KG	LEDs - 54W - 2 700 °K - 4 625 Lm*	IP 20 CE UL standard compatible
H631	H. 16 Ø. 80 CM - 3,2 KG	LEDs - 73W - 2 700 °K - 6 250 Lm*	IP 20 CE UL standard compatible

Option H660/H630/H631 : variation Dali ou Triac

FINITION RUBAN/RIBBON/STOFFBAND

blanc/white ivoire/ivory

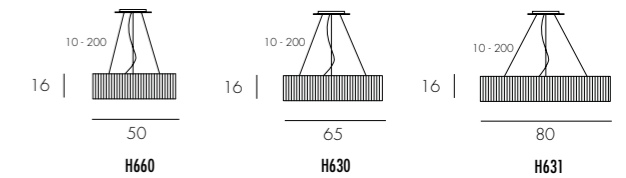

Ronde lampadaire

Lampadaire en ruban blanc ou ivoire et éclairage LED.
Interrupteur/variateur à pied. Piètement en métal laqué noir.

Floor Lamp in white or ivory ribbon. Warm white LED lighting. Foot dimmer switch. Black metal structure.

RÉF.	DIMENSIONS	SOURCES	CERTIFICATIONS
H642	H. 200 Ø. 80 CM	Flex LEDs - 73W - 2 700 °K - 6 250 Lm*	IP 20 CE UL standard compatible

FINITION RUBAN/RIBBON/STOFFBAND

blanc/white ivoire/ivory

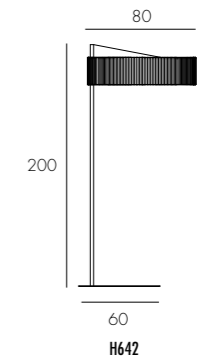

Zigouzi suspensions

Suspensions en aluminium anodisé noir ou or et éclairage LED.
Alimentation ON/OFF 0-10V. Câble d'alimentation transparent.

Pendants in black or gold anodised aluminium. Warm white LED lighting (ON/OFF 0-10V dimming). Transparent power cable.

RÉF.	DIMENSIONS	SOURCES	CERTIFICATIONS
H633	H. 25 Ø. 70 CM - 2,9 KG	LEDs - 44W - 2 700 °K - 3 000 Lm*	IP 20 CE UL standard compatible
H634	H. 30 Ø. 100 CM - 3,2 KG	LEDs - 62W - 2 700 °K - 4 300 Lm*	IP 20 CE UL standard compatible
H635	H. 35 Ø. 120 CM - 3,5 KG	LEDs - 90W - 2 700 °K - 6 200 Lm*	IP 20 CE UL standard compatible
H637	H. 40 Ø. 150 CM - 3,5 KG	LEDs - 110W - 2 700 °K - 7 480 Lm*	IP 20 CE UL standard compatible

Option dimmable H635/H637 : variation DALI

Option dimmable H634/H633 : variation DALI - Triac

FINITION ALUMINIUM

noir/black or/gold

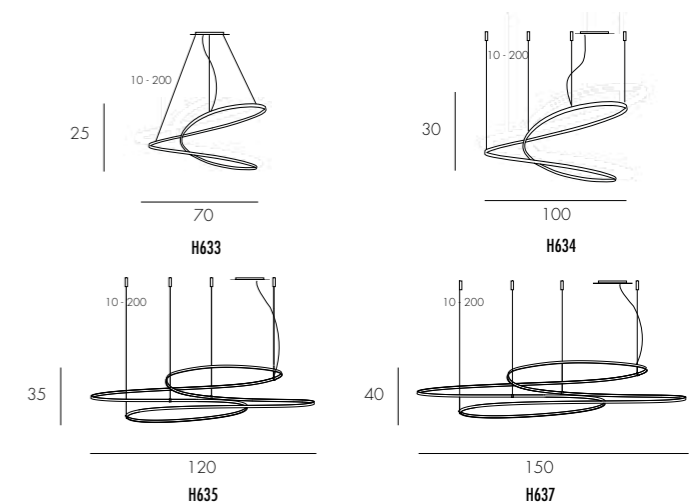

Zig suspensions

Suspension en aluminium anodisé noir ou or et éclairage LED direct (écran diffusant) et indirect (écran transparent).
Alimentation ON/OFF 0-10V. Câble d'alimentation transparent.

Pendant in black or gold anodised aluminium. Warm white LED direct and indirect lighting (ON/OFF 0-10V dimming). Transparent power cable.

RÉF.	DIMENSIONS	SOURCES	CERTIFICATIONS
H645	L. 50 H. 1 CM	LEDs - 22W - 2 700 °K - 1 000 Lm*/500 Lm*	IP 20 CE UL standard compatible
H644	L. 100 H. 1 CM	LEDs - 42W - 2 700 °K - 1 900 Lm*/950 Lm*	IP 20 CE UL standard compatible
H643	L. 150 H. 1 CM	LEDs - 65W - 2 700 °K - 2 900 Lm*/1 450 Lm*	IP 20 CE UL standard compatible
H643	L. 200 H. 1 CM	LEDs - 85W - 2 700 °K - 4 000 Lm*/2 000 Lm*	IP 20 CE UL standard compatible

Option dimmable H636/H645 : variation DALI

Option dimmable H643/H644 : variation DALI - Triac

FINITION ALUMINIUM

noir/black or/gold

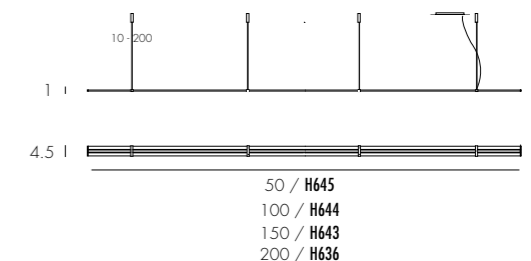

* Émission source

* Émission source

Iris lampadaires et liseuse

Lampadaires et liseuse en ruban blanc ou ivoire et éclairage LED (single flux ou double flux). Interrupteur/variateur. Piètement en métal noir grainé. Finition identique recto/verso.

Floor Lamps and reading light in white or ivory ribbon. Warm white LED lighting (single flux or double flux). Dimmer switch. Black metal structure. Identical finish on both sides.

RÉF.	DIMENSIONS	SOURCES	CERTIFICATIONS
H628.SF	H. 140 Ø. 50 CM	LEDs - 28W - 2 700 °K - 2 800 Lm*	IP 20 CE UL standard compatible
H628.DF	H. 140 Ø. 50 CM	LEDs - 32W - 2 700 °K - 2 200 Lm*	IP 20 CE UL standard compatible
H591.SF	H. 165 Ø. 60 CM	LEDs - 40W - 2 700 °K - 3 750 Lm*	IP 20 CE UL standard compatible
H591.DF	H. 165 Ø. 60 CM	LEDs - 50W - 2 700 °K - 5 200 Lm*	IP 20 CE UL standard compatible
H590.SF	H. 180 Ø. 80 CM	LEDs - 52W - 2 700 °K - 5 000 Lm*	IP 20 CE UL standard compatible
H590.DF	H. 180 Ø. 80 CM	LEDs - 66W - 2 700 °K - 6 900 Lm*	IP 20 CE UL standard compatible
H629 RGBW	H. 180 Ø. 80 CM	LEDs 65W RGB - White - 2 700 °K	IP 20 CE UL standard compatible

FINITION RUBAN/RIBBON/STOFFBAND

blanc/white ivoire/ivory

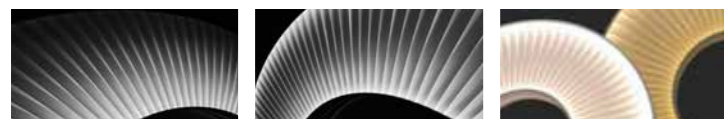

Single Flux SF

Double Flux DF

Ruban blanc

Ruban ivoire

Iris lampes à poser

Lampe à poser en ruban blanc ou ivoire et éclairage LED (single flux ou double flux). Interrupteur/variateur sur socle en métal noir grainé. Finition identique recto/verso.

Table lamp in white or ivory ribbon. Warm white LED lighting (single flux or double flux). Switch-dimmer on the black metal structure. Identical finish on both sides.

RÉF.	DIMENSIONS	SOURCES	CERTIFICATIONS
H625.SF	H. 55 Ø. 40 CM	LEDs - 24W - 2 700 °K - 2 500 Lm*	IP 20 CE UL standard compatible
H625.DF	H. 55 Ø. 40 CM	LEDs - 28W - 2 700 °K - 2 100 Lm*	IP 20 CE UL standard compatible
H626.SF	H. 75 Ø. 50 CM	LEDs - 28W - 2 700 °K - 2 800 Lm*	IP 20 CE UL standard compatible
H626.DF	H. 75 Ø. 50 CM	LEDs - 32W - 2 700 °K - 2 200 Lm*	IP 20 CE UL standard compatible
H627.SF	H. 61 Ø. 40 CM	LEDs - 24W - 2 700 °K - 2 500 Lm*	IP 20 CE UL standard compatible
H627.DF	H. 61 Ø. 40 CM	LEDs - 28W - 2 700 °K - 2 100 Lm*	IP 20 CE UL standard compatible

FINITION RUBAN/RIBBON/STOFFBAND

blanc/white ivoire/ivory



Iris suspensions verticales

Suspensions verticales en ruban blanc ou ivoire et éclairage LED (single flux ou double flux). Alimentation ON/OFF 0-10V. Câble d'alimentation transparent.

Vertical pendants in white or ivory ribbon. Warm white LED lighting (single flux or double flux). ON/OFF 0-10V dimming. Transparent power cable.

RÉF.	DIMENSIONS	SOURCES	CERTIFICATIONS
H649.SF	Ø. 40 CM - 2 KG	LEDs - 24W - 2 700 °K - 2 500 Lm*	IP 20 CE UL standard compatible
H649.DF	Ø. 40 CM - 2 KG	LEDs - 28W - 2 700 °K - 2 100 Lm*	IP 20 CE UL standard compatible
H604.SF	Ø. 50 CM - 2,5 KG	LEDs - 28W - 2 700 °K - 2 800 Lm*	IP 20 CE UL standard compatible
H604.DF	Ø. 50 CM - 2,5 KG	LEDs - 32W - 2 700 °K - 2 200 Lm*	IP 20 CE UL standard compatible
H594.SF	Ø. 60 CM - 2,8 KG	LEDs - 40W - 2 700 °K - 3 750 Lm*	IP 20 CE UL standard compatible
H594.DF	Ø. 60 CM - 2,8 KG	LEDs - 50W - 2 700 °K - 5 200 Lm*	IP 20 CE UL standard compatible
H593.SF	Ø. 80 CM - 3 KG	LEDs - 52W - 2 700 °K - 5 000 Lm*	IP 20 CE UL standard compatible
H593.DF	Ø. 80 CM - 3 KG	LEDs - 66W - 2 700 °K - 6 900 Lm*	IP 20 CE UL standard compatible
H603.SF	Ø. 160 CM - 4,5 KG	LEDs - 150W - 2 700 °K - 14 000 Lm*	IP 20 CE UL standard compatible

Option dimmable H649/H604/H594/H593/H603 : DALI - Triac

FINITION RUBAN/RIBBON/STOFFBAND

blanc/white ivoire/ivory



* Émission source

Iris suspensions horizontales

Suspensions horizontales en ruban blanc ou ivoire et éclairage LED (single flux ou double flux). Alimentation ON/OFF 0-10V. Câble d'alimentation transparent.

Horizontal pendants in white or ivory ribbon. Warm white LED lighting (single flux or double flux). ON/OFF 0-10V dimming. Transparent power cable.

RÉF.	DIMENSIONS	SOURCES	CERTIFICATIONS
H650.SF	Ø. 40 CM - 2,5 KG	LEDs - 24W - 2 700 °K - 2 500 Lm*	IP 20 CE UL standard compatible
H650.DF	Ø. 40 CM - 2,5 KG	LEDs - 28W - 2 700 °K - 2 100 Lm*	IP 20 CE UL standard compatible
H608.SF	Ø. 50 CM - 2,5 KG	LEDs - 28W - 2 700 °K - 2 800 Lm*	IP 20 CE UL standard compatible
H608.DF	Ø. 50 CM - 2,5 KG	LEDs - 32W - 2 700 °K - 2 200 Lm*	IP 20 CE UL standard compatible
H597.SF	Ø. 60 CM - 2,8 KG	LEDs - 40W - 2 700 °K - 3 750 Lm*	IP 20 CE UL standard compatible
H597.DF	Ø. 60 CM - 2,8 KG	LEDs - 50W - 2 700 °K - 5 200 Lm*	IP 20 CE UL standard compatible
H596.SF	Ø. 80 CM - 3 KG	LEDs - 52W - 2 700 °K - 5 000 Lm*	IP 20 CE UL standard compatible
H596.DF	Ø. 80 CM - 3 KG	LEDs - 66W - 2 700 °K - 6 900 Lm*	IP 20 CE UL standard compatible
H606.SF	Ø. 106 CM - 4,5 KG	LEDs - 150W - 2 700 °K - 14 000 Lm*	IP 20 CE UL standard compatible
H668.SF	3 x Ø. 60 CM - 10 KG	LEDs - 90W - 2 700 °K - 9 000 Lm*	IP 20 CE UL standard compatible
H668.DF	3 x Ø. 60 CM - 10 KG	LEDs - 90W - 2 700 °K - 9 500 Lm*	IP 20 CE UL standard compatible

Option dimmable H650/H608/H597/H596/H606/H668 : variation DALI - Triac

FINITION RUBAN/RIBBON/STOFFBAND

blanc/white ivoire/ivory

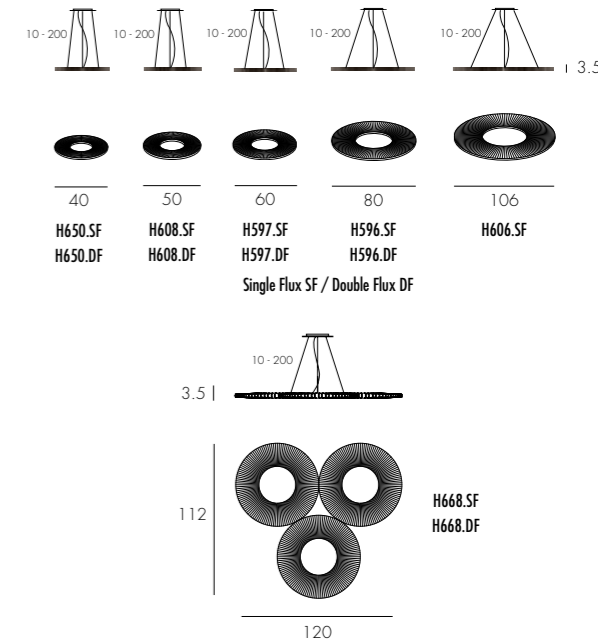
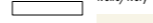

Iris appliques

Appliques en ruban blanc ou ivoire et éclairage LED (single flux ou double flux). Alimentation ON/OFF 0-10V.

Wall lamps in white or ivory ribbon. Warm white LED lighting (single flux or double flux). ON/OFF 0-10V dimming.

RÉF.	DIMENSIONS	SOURCES	CERTIFICATIONS
H600.SF	Ø 60 CM	LEDs - 40W - 2 700 °K - 3 750 Lm*	IP 20 CE UL standard compatible
H600.DF	Ø 60 CM	LEDs - 50W - 2 700 °K - 5 200 Lm*	IP 20 CE UL standard compatible
H599.SF	Ø 80 CM	LEDs - 52W - 2 700 °K - 5 000 Lm*	IP 20 CE UL standard compatible
H599.DF	Ø 80 CM	LEDs - 66W - 2 700 °K - 6 900 Lm*	IP 20 CE UL standard compatible

Option dimmable : variation DALI - Triac

FINITION RUBAN/RIBBON/STOFFBAND

blanc/white ivoire/ivory



Iris appliques/plafonniers

Appliques - plafonniers en ruban blanc ou ivoire et éclairage LED (single flux ou double flux). Alimentation ON/OFF 0-10V. Centre en métal blanc. Option pour pose applique: centre en miroir.

Ceiling - wall lamps in white or ivory ribbon. Warm white LED lighting (single flux or double flux). ON/OFF 0-10V dimming. Center in white metal. Optional for mounting only : central mirror.

RÉF.	DIMENSIONS	SOURCES	CERTIFICATIONS
H609.SF	Ø 50 CM	LEDs - 28W - 2 700 °K - 2 800 Lm*	IP 20 CE UL standard compatible
H609.DF	Ø 50 CM	LEDs - 32W - 2 700 °K - 2 200 Lm*	IP 20 CE UL standard compatible
H620.SF	Ø 60 CM	LEDs - 40W - 2 700 °K - 3 750 Lm*	IP 20 CE UL standard compatible
H620.DF	Ø 60 CM	LEDs - 50W - 2 700 °K - 5 200 Lm*	IP 20 CE UL standard compatible
H621.SF	Ø 80 CM	LEDs - 52W - 2 700 °K - 5 000 Lm*	IP 20 CE UL standard compatible
H621.DF	Ø 80 CM	LEDs - 66W - 2 700 °K - 6 900 Lm*	IP 20 CE UL standard compatible
H619	Ø 80 CM	LEDs RGB - White - 65W - Pilotage télécommande	IP 20 CE UL standard compatible

Option dimmable H609/H620/H621 : variation DALI - Triac

FINITION RUBAN/RIBBON/STOFFBAND

blanc/white ivoire/ivory



* Émission source

Colonne lampadaires et lampe à poser

Lampadaires et lampe à poser en ruban.

Socle en métal grainé, en inox brossé ou en marbre.

H161/H162/H198/H199/H163 Interrupteur à pied.

H160/H168 Éclairage LED blanc chaud. Interrupteur/variateur à pied.

H160 RGBW/H168 RGBW Éclairage trichromatique plus blanc

constitué de LEDs avec contrôle par télécommande à fonctions multiples (on/off, couleurs préréglées, variation en boucle contin

Floor lamps and table lamp in ribbon.

Metal foot, brushed stainless steel or marble foot.

H161/H162/H198/H199/H163 Foot switch.

H160/H168 Warm white LED lighting. Foot dimmer switch.

H160 RGBW/H168 RGBW Three-colour Flex + white LED lighting

with a remote control (on/off, pre-selected colours, fading and independent settings for each colour and warm white).

RÉF.	DIMENSIONS	SOURCES	CERTIFICATIONS
H199	H. 280 Socle 42 x 42 CM	7 x 60W / E27 - Variateur en option	IP 20 CE UL standard compatible
H198	H. 240 Socle 42 x 42 CM	5 x 60W / E27 - Variateur en option	IP 20 CE UL standard compatible
H161	H. 190 Socle 32 x 32 CM	4 x 60W / E27 - Variateur en option	IP 20 CE UL standard compatible
H162	H. 165 Socle 25 x 25 CM	3 x 60W / E27 - Variateur en option	IP 20 CE UL standard compatible
H163	H. 66 Socle 18 x 18 CM	1 x 60W / E27	IP 20 CE UL standard compatible
H160	H. 190 Socle 32 x 32 CM	LEDs - 80W - 2 700 °K - 5 400 Lm*	IP 20 CE UL standard compatible
H168	H. 165 Socle 25 x 25 CM	LEDs - 65W - 2 700 °K - 4 500 Lm*	IP 20 CE UL standard compatible
H680	H. 66 Socle 18 x 18 CM	LEDs - 25W - 2 700 °K - 1 740 Lm*	IP 20 CE UL standard compatible
H160 RGBW	H. 190 Socle 32 x 32 CM	LEDs 80W RGB - White - 2 700 °K	IP 20 CE UL standard compatible
H168 RGBW	H. 165 Socle 25 x 25 CM	LEDs 65W RGB - White - 2 700 °K	IP 20 CE UL standard compatible

FINITION RUBAN/RIBBON/STOFFBAND - H160 RGBW/H168 RGBW

blanc/white



FINITION RUBAN/RIBBON/STOFFBAND - H161/H162/H198/H199/H163/H160/H168/H680

blanc/white ivoire/ivory clémentine rouge/red ondé/gray



FINITION SOCLE/FEET/SOCKEL - H163/H199/H198/H680

inox brossé acier gris grainé acier noir grainé



FINITION SOCLE/FEET/SOCKEL - H161/H162/H160/H168/H160 RGBW/H168 RGBW

inox brossé acier gris grainé acier noir grainé Carrare Marquina



Colonne suspensions

Suspensions de 62 cm à 190 cm en ruban. Hauteur réglable.

Câble d'alimentation transparent.

Option: alimentation par le bas avec interrupteur ou variateur.

Pendants in ribbon. Adjustable height. Transparent power cable.

Optional: bottom power supply.

RÉF.	DIMENSIONS	SOURCES	CERTIFICATIONS
H251	H. 62 Ø 16 CM / 0,7 KG	1 x 60W / E27	IP 20 CE UL standard compatible
H252	H. 90 Ø 19 CM / 1 KG	2 x 60W / E27	IP 20 CE UL standard compatible
H253	H. 120 Ø 20 CM / 1,5 KG	2 x 60W / E27	IP 20 CE UL standard compatible
H254	H. 160 Ø 18 CM / 2 KG	3 x 60W / E27	IP 20 CE UL standard compatible
H255	H. 190 Ø 21 CM / 3 KG	4 x 60W / E27	IP 20 CE UL standard compatible
H672	H. 62 Ø 16 CM / 0,7 KG	LEDs - 25W - 2 700 °K - 1 740 Lm*	IP 20 CE UL standard compatible
H673	H. 90 Ø 19 CM / 1 KG	LEDs - 33W - 2 700 °K - 2 250 Lm*	IP 20 CE UL standard compatible
H674	H. 120 Ø 20 CM / 1,5 KG	LEDs - 46W - 2 700 °K - 3 180 Lm*	IP 20 CE UL standard compatible
H675	H. 160 Ø 18 CM / 2 KG	LEDs - 65W - 2 700 °K - 4 500 Lm*	IP 20 CE UL standard compatible
H676	H. 190 Ø 21 CM / 3 KG	LEDs - 80W - 2 700 °K - 5 400 Lm*	IP 20 CE UL standard compatible

FINITION RUBAN/RIBBON/STOFFBAND

blanc/white ivoire/ivory clémentine rouge/red ondé/gray

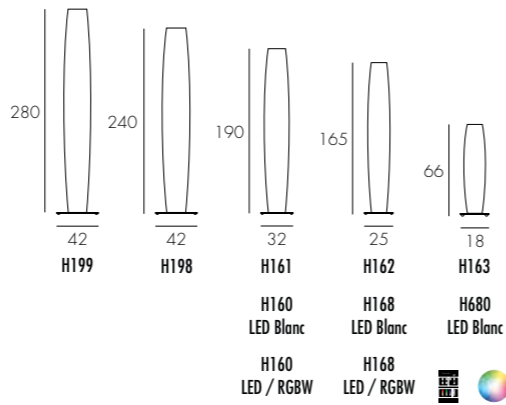

Perles suspensions

Suspensions en composite minéral finition blanc mat ou couleurs, et éclairage LED direct. Dimmable DALI - Push Dim.

Hanging lamps in mat white or coloured finished mineral composite, and direct LED lighting. Dimmable DALI - Push Dim.

RÉF.	DIMENSIONS	SOURCES	CERTIFICATIONS
H702	Ø 65 CM H. 7 CM / 7 KG	LEDs - 48W - 2 700 °K - 8 000 Lm*	IP 20 CE UL standard compatible
H703	Ø 80 CM H. 7 CM / 8 KG	LEDs - 54W - 2 700 °K - 9 600 Lm*	IP 20 CE UL standard compatible
H704	Ø 100 CM H. 7 CM / 10 KG	LEDs - 70W - 2 700 °K - 10 000 Lm*	IP 20 CE UL standard compatible
H705_32	H. 63 CM L. 7 CM / 5 KG	LEDs - 16W - 2 700 °K - 2 680 Lm*	IP 20 CE UL standard compatible
H706_32	L. 63 CM H. 7 CM / 5 KG	LEDs - 16W - 2 700 °K - 2 680 Lm*	IP 20 CE UL standard compatible

Option Kelvin H705/H706 : 3 000 °K (_31) ou 4 000 °K (_33)

FINITION

blanc/white



or laiton titane canon de fusil cuivre or or rosé



jaune fluo rose fluo vert fluo orange fluo rouge fluo noir mat

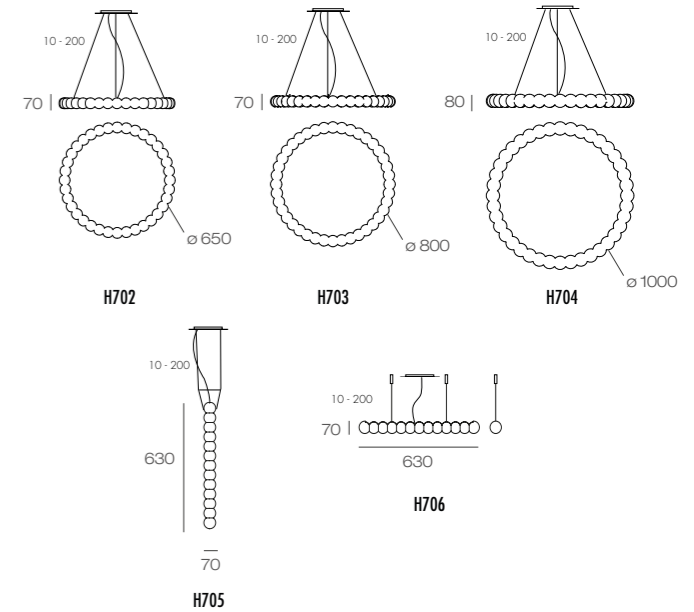

Perles appliquées

Appliques en composite minéral finition blanc mat ou couleurs, et éclairage LED indirect.

Wall lamps in mat white or coloured finished mineral composite, and indirect LED lighting.

RÉF.	DIMENSIONS	SOURCES	CERTIFICATIONS
H709_32	L. 37 CM H. 7 CM / 1 KG	LEDs - 8W - 2 700 °K - 1 250 Lm*	IP 20 CE UL standard compatible
H710_32	L. 63 CM H. 7 CM / 1,5 KG	LEDs - 16W - 2 700 °K - 2 500 Lm*	IP 20 CE UL standard compatible

Option dimmable H709 : variation DALI - PUSH DIM

Option dimmable H710 : variation 0-10V - DALI - PUSH DIM

Option Kelvin H709/H710 : 3 000 °K (_31) ou 4 000 °K (_33)

FINITION

blanc/white



or laiton titane canon de fusil cuivre or or rosé



jaune fluo rose fluo vert fluo orange fluo rouge fluo noir mat

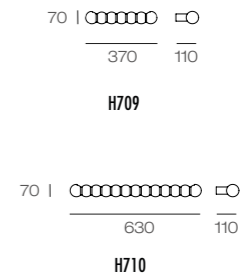

Perles lampadaire

Lampadaire en composite minéral finition blanc mat ou couleurs, et éclairage LED. Interrupteur/variateur. Socle en métal noir grainé.

Option : socle de la couleur du lampadaire.

Floor lamp in mat white or coloured finished mineral composite, and LED lighting. Dimmer switch. Black metal base. Option : coloured metal base.

RÉF.	DIMENSIONS	SOURCES	CERTIFICATIONS
H700	H. 180 Ø 30 CM / 10 KG	LEDs - 47W - 2 700 °K - 4 500 Lm*	IP 20 CE UL standard compatible

FINITION

blanc/white



or laiton titane canon de fusil cuivre or or rosé



jaune fluo rose fluo vert fluo orange fluo rouge fluo noir mat

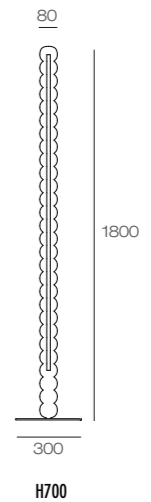

* Émission source

1/2 Colonne appliques

Appliques 1/2 colonnes 62 cm & 100 cm en ruban avec éclairage LED. Installation possible en plafonnier.

Half-columns wall lamps in ribbon with LED lighting. Possible mounting as a ceiling lamp.

RÉF.	DIMENSIONS	SOURCES	CERTIFICATIONS
H677	H. 100 Ø 20 CM	LEDs - 29W - 2.700 °K - 2.000 Lm* - Dali Push-Dim	IP 20 CE
H678	H. 62 Ø 15 CM	LEDs - 17W - 2.700 °K - 1.200 Lm* - Dali Push-Dim	IP 20 CE

FINITION RUBAN/RIBBON/STOFFBAND

blanc/white ivoire/ivory clémentine rouge/red ondé/grey

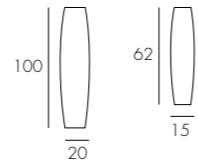

H677 LED Blanc H678 LED Blanc

Étoile

Suspension en ruban. Câble d'alimentation transparent. Option avec diffusant en PMMA satiné.

Pendant in ribbon. Transparent power cable. Option with a diffusing disc in frosted PMMA.

RÉF.	DIMENSIONS	SOURCES	CERTIFICATIONS
H410	H. 45 Ø 90 CM / 4 KG	3 x 60W / E27	IP 20 CE UL standard compatible

Option diffuseur inférieur en PMMA

FINITION RUBAN/RIBBON/STOFFBAND

blanc/white ivoire/ivory clémentine rouge/red ondé/grey noir/black

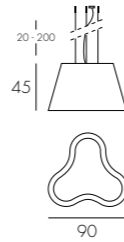

H410

La Suspension

Suspensions en ruban. Câble d'alimentation transparent.

Pendants in ribbon. Transparent power cable.

RÉF.	DIMENSIONS	SOURCES	CERTIFICATIONS
H411	H. 40 L. 75 CM / 3 KG	2 x 60W / E27	IP 20 CE UL standard compatible
H412	H. 45 L. 124 CM / 4 KG	3 x 60W / E27	IP 20 CE UL standard compatible

FINITION RUBAN/RIBBON/STOFFBAND

blanc/white ivoire/ivory clémentine rouge/red ondé/grey noir/black

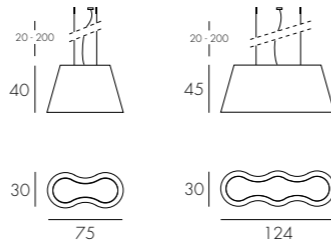

H411

H412

Joseph

Suspensions en feutre.

Pendants in felt textile.

RÉF.	DIMENSIONS	SOURCES	CERTIFICATIONS
H445	H. 30 Ø 70 CM	1 x 60W / E27	IP 20 CE UL standard compatible
H446	H. 35 Ø 45 CM	1 x 60W / E27	IP 20 CE UL standard compatible
H447	H. 40 Ø 20 CM	1 x 60W / E27	IP 20 CE UL standard compatible

FINITION ABAT-JOUR/SHADE/SCHIRM

gris clair gris brun gris anthracite carneau de gris

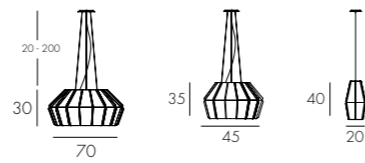

H445

H446

H447

Nature

Lampadaires en tissu stretch blanc sur structure acier. Textile déhoussable et lavable à froid. Câble d'alimentation transparent.

Floor lamps in white stretch with steel structure. Removable stretch cover, suitable for cold water wash. Transparent power cable.

RÉF.	DIMENSIONS	SOURCES	CERTIFICATIONS
H481	H. 200 Ø 35 CM	5 x 60W / E27 - Variateur en option	IP 20 CE UL standard compatible
H482	H. 185 Ø 40 CM	5 x 60W / E27 - Variateur en option	IP 20 CE UL standard compatible
H483	H. 170 Ø 45 CM	4 x 60W / E27 - Variateur en option	IP 20 CE UL standard compatible

FINITION TISSU STRETCH/STRETCH FABRIC/STRETCHSTOFF

blanc/white ivoire/ivory

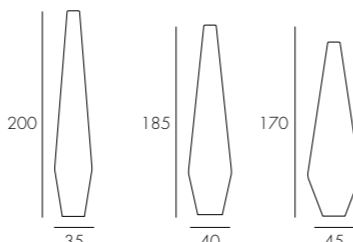

H481

H482

H483

Paravent lampadaires

Lampadaires en ruban.

Socle en métal noir grainé, en inox brossé ou en marbre.

H180/H181/H182 Interrupteur à pied.

H188/H189 Interrupteur/variateur à pied.

H189 RGB Éclairage trichromatique plus blanc constitué de LEDs avec contrôle par télécommande à fonctions multiples (on/off, couleurs pré-réglées, variation en boucle continue, réglages indépendants de chaque couleur et blanc chaud).

Floor lamps in ribbon. Black metal, brushed stainless steel or marble foot.

H180/H181/H182 Foot switch.

H188/H189 Foot dimmer switch.

H189 RGB Three-colour Flex + white LED lighting with a remote control (on/off, pre-selected colours, fading and independent settings for each colour and warm white).

RÉF.	DIMENSIONS	SOURCES	CERTIFICATIONS
H180	H. 195 Socle 98 x 23 CM	12 x 40W / E27 - Variateur en option	IP 20 CE UL standard compatible
H181	H. 195 Socle 68 x 23 CM	8 x 40W / E27 - Variateur en option	IP 20 CE UL standard compatible
H182	H. 195 Socle 37 x 23 CM	4 x 40W / E27 - Variateur en option	IP 20 CE UL standard compatible
H188	H. 195 Socle 68 x 23 CM	LEDs - 75W - 2.700 °K - 5.400 Lm*	IP 20 CE UL standard compatible
H189	H. 195 Socle 37 x 23 CM	LEDs - 80W - 2.700 °K - 5.400 Lm*	IP 20 CE UL standard compatible
H189 RGBW	H. 195 Socle 37 x 23 CM	LEDs - 80W RGB - White - 2.700 °K	IP 20 CE UL standard compatible

FINITION RUBAN/RIBBON/STOFFBAND - H189 RGBW

blanc/white



FINITION RUBAN/RIBBON/STOFFBAND - H180/H181/H182/H188/H189

blanc/white ivoire/ivory clémentine rouge/red

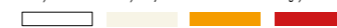

FINITION SOCLE/FEET/SOCKEL - H180

inox brossé métal peint noir



FINITION SOCLE/FEET/SOCKEL - H181/H182/H188/H189/H189RGBW

inox brossé métal peint noir Carrare Marquina

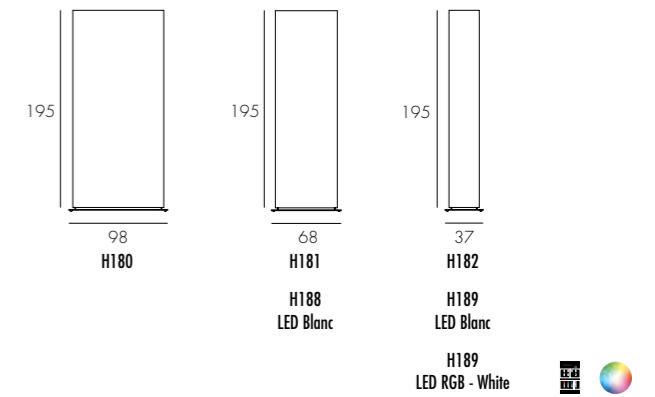

Aphrodite, Artémis & Athéna

Lampadaires en tissu stretch sur structure acier.

Socle en acier noir grainé ou en inox brossé.

Textile déhoussable et lavable. Câble d'alimentation transparent.

Floor lamps in stretch with steel structure. Black metal foot or brushed stainless steel foot. Removable stretch cover, suitable for washing. Transparent power cable.

RÉF.	DIMENSIONS	SOURCES	CERTIFICATIONS
H313	H. 218 Ø 32 CM	6 x 60W / E27 - Variateur en option	IP 20 CE UL standard compatible
H314	H. 195 Ø 41 CM	5 x 60W / E27 - Variateur en option	IP 20 CE UL standard compatible
H315	H. 167 Ø 40 CM	4 x 60W / E27 - Variateur en option	IP 20 CE UL standard compatible
H316	H. 167 Ø 35 CM	4 x 60W / E27 - Variateur en option	IP 20 CE UL standard compatible
H317	H. 225 Ø 47 CM	6 x 60W / E27 - Variateur en option	IP 20 CE UL standard compatible

FINITION TISSU STRETCH/STRETCH FABRIC/STRETCHSTOFF

blanc/white ivoire/ivory



FINITION SOCLE/FEET/SOCKEL

métal peint noir inox brossé

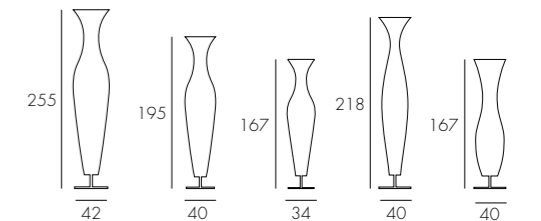

H317 APHRODITE

H314 APHRODITE

H316 APHRODITE

H313 ATHENA

H315 ARTEMIS

Ruban suspensions

Suspensions en ruban. Câble d'alimentation transparent.

Pendants in ribbon. Transparent power cable.

RÉF.	DIMENSIONS	SOURCES	CERTIFICATIONS
H267	H. 44 Ø 90 CM / 5 KG	1 x 60W / E27	IP 20 CE UL standard compatible
H268	H. 34 Ø 70 CM / 4 KG	1 x 60W / E27	IP 20 CE UL standard compatible
H269	H. 45 Ø 45 CM / 1,5 KG	1 x 60W / E27	IP 20 CE UL standard compatible

FINITION RUBAN/RIBBON/STOFFBAND

blanc/white ivoire/ivory clémentine rouge/red ondé/grey noir/black

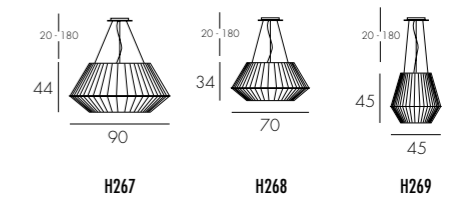

H267

H268

H269



@fabriceberrux #celeste

#charleston #suspensions

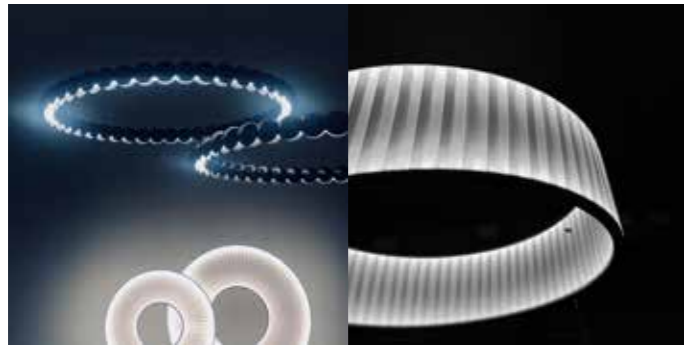

#perles #iris

#ronde



@ludovicroth #joseph

@fabriceberrux #perles



#perles #suspension

#zigouzi #iris #planetes



#iris #composition

#zigouzi #workinprogress

WWW.DIXHEURES.DIX.COM

Pages 02-04-05-16-17-19-41-72
 Remerciements au CNVA
 Pages 2ième de couverture-02-07-18-20-23-38-46
 Remerciements à Magali et à Romain
 Pages 03- 57-61 Remerciements à Marie-Luce et à Michel
 Pages 03- 54-58 Remerciements à Nicoletta et à Maurizio
 Pages 23-51 Remerciements à Olivia
 Page 44-45 Remerciements à Bénédicte et à Jean-Marie
 Page 50 Remerciements à Stéphanie et à Nicolas

Fabrice Berrux
 direction artistique / art direction

Julie Figueroa
 design graphique / graphic design

Dix heures dix se réserve le droit d'apporter toutes modifications aux produits présentés dans ce catalogue. Photos non contractuelles.
 © Copyright. Tous droits réservés.

Dix heures dix is entitled to modify the products shows in this catalogue.
 Photos and colours may vary to the actual item.
 © Copyright. All rights reserved.

dix heures dix

3 avenue du Professeur Jean Bouxel
44481 CARQUEFOU Cedex - FRANCE
Tél. +33 2 40 99 85 25
Fax +33 2 40 35 26 22
Email : info@dixheuresdix.com
www.dixheuresdix.com