

17/18

DESIGN  
LIVING

MOLTO LUCE®

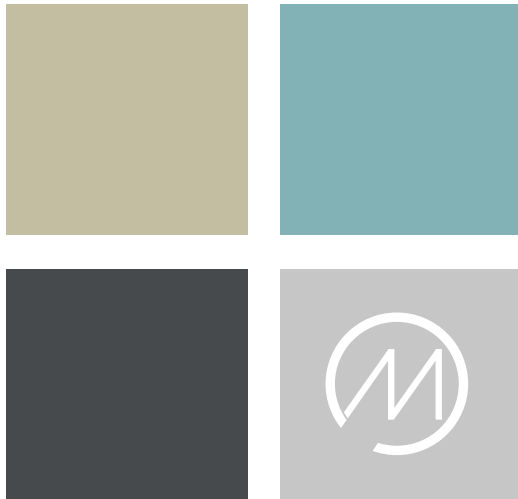

1

## DESIGN

Was verstehen Sie unter „gutem“ Design und was erwarten Sie davon?

Stellt man diese Frage 100 Personen, so wird man als Ergebnis ein breites Feld an möglichen Antworten erhalten. Schöne Form, edle Materialien, kreative Umsetzung, Alleinstellung, Zeitlosigkeit, Beständigkeit, Stil.... Jeder hat seine persönlichen Vorstellungen, jeder seine individuelle Erwartungshaltung. Menschen sind eben unterschiedlich und genauso unterschiedlich ist auch Ihr Design-Anspruch.

2

## DER SICHTBARE CHARAKTER

In der Entwicklung innovativer Leuchtenserien legt Molto Luce seit Anbeginn großen Wert auf eine klare, designorientierte Formensprache der Produkte. Wir sehen Design als den sichtbaren Charakter einer Leuchte, der sich als formale Hülle schützend über ein Gesamtpaket von Funktionalität legt. Design von Molto Luce steht für Schlichtheit, Reduktion und Zeitlosigkeit. Für uns darf Design nicht kurzlebige Mode und hipper Trend sein. Funktionale Ästhetik, die längerfristig Gültigkeit hat, ist uns ein Anliegen.

Gutes Design ist unsere Leidenschaft, darum dürfen Sie Licht in seiner schönsten Form von uns erwarten. Licht, das in Materialität, Form und Farbgebung den hohen Ansprüchen moderner Architektur entspricht.

Molto Luce schafft Lichtlösungen für Menschen, die Wert legen auf funktionale Individualität.

## RAUM UND LICHT

Dieser Katalog bringt anspruchsvolles Lichtdesign ins Spiel, er ist für alle Liebhaber formschöner Leuchten gemacht. Der Katalog bietet eine Vielfalt gelungener State-of-the-Art Beleuchtung sowohl für den privaten Wohnraum als auch für die Anwendung im Objekt.

Immer ist es die Raumarchitektur, die einen determinierenden Rahmen vorgibt, innerhalb dessen sich die jeweiligen Gestaltungselemente zu bewegen haben. Architektur, Möbel und Licht müssen miteinander harmonieren und gehen letztlich eine fruchtbare Symbiose ein. Durch den gekonnten Einsatz anspruchsvoller Beleuchtungslösungen wird der Raum in eine harmonische Lichtstimmung getaucht und das Interieur perfekt in den Fokus gerückt.

3

## DESIGN LIVING

Design Living ist der Ausdruck von Lichtlösungen mit außergewöhnlichem Design.

Das in diesem Katalog gezeigte Spektrum umfasst innovative Leuchten der Marke Molto Luce, welche durch eine interessante Selektion edler Beleuchtungsserien anderer Marken sinnvoll abgerundet wird. Produkte mit starkem Charakter, starker Performance, starker Wirkung.

Design Living bietet ein Mehr an Design.

4

# PENDELLEUCHTEN



AFTER 8

216-219



ALIVE

168-169



ANWAR

046-049



ARTIST

196-197



AVER

192-193



BISTRO

166-167



BLOW

164-165

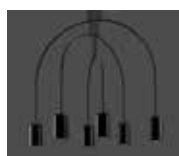

BOW

222-223



BROOKLYN  
ROUND

134-137



CANDLE

172-173



CHUNNEL

124-125



CLIO

146-149



CORAL

014-015



CORAL  
CAY

020-021



CORAL  
GALAXEA

024-025



CORAL  
REEF

022-023



CORAL  
SEA

018-019



CORAL  
SEAURCHIN

016-017



DASH L DC

128-129



DEE

198-199



DOMINO

108-109



EMITION

190-191



EMMA

150-151



EROCOSI

156-157



FLOAT

086-087



FUTURA

066-067



GEA

026-027



GILBERT

096-097



GLOBO

200-201



GOLDEN  
RING

138-141



I LUSTRI

202-205



ICS

226-227



IDEA

120-121



IDEATWIN

056-057



INVISIBLE

116-117



KITE

032-033

# INHALT



**KLUVI**

052-053



**LAMELLA**

188-189



**LASH**

092-093



**LOOK**

178



**LOON**

160-163



**LUMEN**

158-159



**MEGAVIDE**

094-095



**MOBY**

179



**MULTIPLO**

060-061



**NEOCHIC**

098-099



**OIL**

182-183



**OLIVIA**

152-153



**ONE**

126-127



**ONN**

042-043



**ORIGAMI**

112-113



**PALLA**

074-075



**PALLATRE**

072-073



**PHANTOM**

122-123



**PURE**

088-089



**RAGATTO**

100-101



**RIDE**

212-213



**RIDE LENS**

210-211



**RULO**

176-177



**SATURN**

224-225



**SILVER RING**

142-143



**SIXTIES**

206-207



**SOFT**

180-181



**SPECTER**

174-175



**STRAP**

194-195



**STRETTO**

214-215



**TINA**

080-083

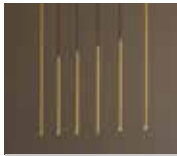

**TUBETTO**

170-171



**URA**

038-039



**UXI**

220-221



**VIISI**

208-209



**ZITA**

186-187



Produkte mit diesem Farbfeld sind Leuchtenfamilien

# WAND- / DECKENLEUCHTEN



AEON

310-311



AKON

288-289



ALEA

298-299



ALICA

272



ARIK

306



BO

274



BROOK

308



CARMEN

286-287



CARMI

307



CHUNNEL

124-125



CI

268-269



CLIP

270-271



COLLIDE

290-291



DASH L  
DASH

314-315



DASH L DC

130-131



DORSALE

236-237



FLOAT

086-087



FOAM

294-295



FUTURA

068-071



GATOR

296-297



GEA

030-031



GILBERT

096-097



GRID  
GRID LFO

318-325

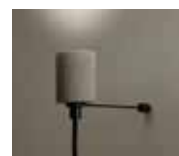

IDEACEMENTO

260-261



IDEATELAIO

058-059



INVISIBLE

116-119



KITE

034-035



KUBIK

276-277



KUBIK

292-293



LANCIA

280-281



LASH

092-093



LITIN

316-317



LOG OUT

334-335



MEGAVIDE

094-095



MOONLIGHT

278-279



MULTIPL0

062-063

# INHALT



NEOCHIC

098-099



NEWTON

242-243



NOVEL

275



OIPHORIQUE

232-233



ONE

126-127



ONN

044-045



PALLA

076-077



PHANTOM

122-123

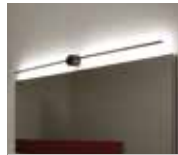

PIC

282-283



PLANUM

036-037



PURE

090-091



QANA

309



RAGATO

102-105



RIDE

332-333



RIDE BLIND

328-329



RIDE LENS

326-327



SILVER RING

144-145



SPOSA

284-285



TAKE

273



TIPERCINQUE

312-313



TOY

262-265



TUBA

304-305



TURN ON

302-303



U BRASS

300-301



VOLTO COPERTO

330-331



ZERO

266-267



Produkte mit diesem Farbfeld sind Leuchtenfamilien



# TISCH- / STEHLEUCHTEN



ALFIERE

254-255



ANWAR

050-051



DADDY

238-239



DOMINO

110-111



DORSALE

236-237



FUTURA

070-071



GEA

028-029



IDEA

120-121



INVISIBLE

118-119



IVEN

252-253



JACKIE

250-251



KLUVI

054-055



LASH

092-093



MULTIPLLO

064-065



NEWTON

242-243

# INHALT



OIPHORIQUE

230-231



ORIGAMI

114-115



PALLA

076-077



PALLATRE

078-079



PILI

256-257



PURE

090-091



SLIDE

246-247



STRING XL

234-235



TINA

084-085



TREPIE

248-249



URA

040-041



VIISI

208-209



WALLY

244-245



YORK

240-241



Produkte mit diesem Farbfeld sind Leuchtenfamilien



GUTES **DESIGN** IST DAS PLUS FÜR MEHR  
LEBENSQUALITÄT.



[www.alessi.com](http://www.alessi.com)

Foto: Stefan Kirchner



#### **SIMETECH® – patentiertes Material by ARTURO ALVAREZ**

Das vielfach ausgezeichnete Material SIMETECH wurde 2014 von Arturo Alvarez persönlich entwickelt. Es besteht aus einem feinem Edstahlgewebe, dass nach dem händischen Formen der Leuchte mit einem speziellen Silikon überzogen wird. Durch dieses Material gelingt es, spezielle Formensprachen bei Leuchten zu entwickeln und schafft somit eine sehr angenehme sowie einladende Lichtatmosphäre. Durch die händische Verarbeitung entstehen Leuchten, die optisch ident aber doch einzigartig in der Verarbeitung sind. Eine Vielzahl von Leuchten werden mit diesem Material, erhältlich in 5 verschiedenen Farben, hergestellt.

Erhältliche Farben: weiß, grau, beige, gelb oder orange







**arturo alvarez**  
emotional light

# CORAL

Hängeleuchte aus SIMETECH®, bestückt mit Edelstahl-Ringe. Erhältlich in drei Ausführungen und in fünf Farbvarianten.

A++ - E  
IP20  



### CORAL 3

3 x E27 | 230V | max. 77W

<b>385-co043b</b>	weiß
<b>385-co043g</b>	grau
<b>385-co043be</b>	beige
<b>385-co043a</b>	gelb
<b>385-co043na</b>	orange

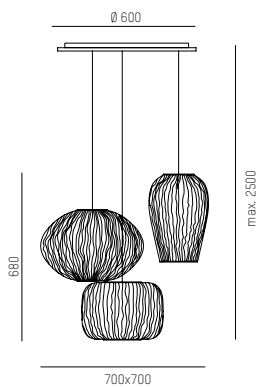

### CORAL 5

5 x E27 | 230V | max. 77W

<b>385-co045b</b>	weiß
<b>385-co045g</b>	grau
<b>385-co045be</b>	beige
<b>385-co045a</b>	gelb
<b>385-co045na</b>	orange

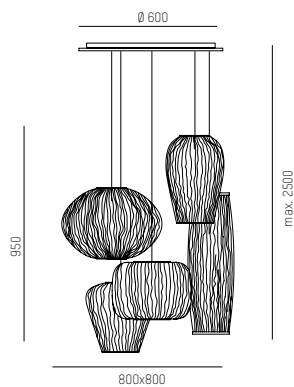

### CORAL 10

13 x E27 | 230V | max. 77W

<b>385-co0410b</b>	weiß
<b>385-co0410g</b>	grau
<b>385-co0410be</b>	beige
<b>385-co0410a</b>	gelb
<b>385-co0410na</b>	orange

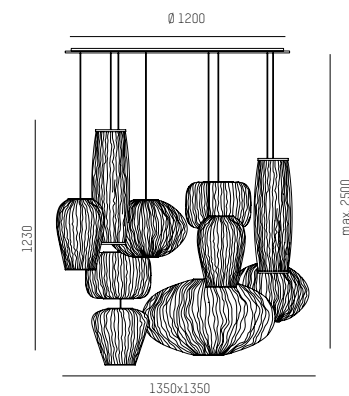





arturo alvarez  
emotional light

# CORAL

SEAUCHIN

Hängeleuchte aus SIMETECH®, bestückt mit Edelstahl-Ringe. Erhältlich in fünf Farbvarianten. LED Version mit integriertem dimmbarem LED-Konverter.

IP20 



### CORAL SEARCHIN LED

SYS 18,1W | 230V | 3000K  
1776lm | CRI>80  
Dimmbar Dali oder Switch Dim.

385-coau04ldb	weiß
385-coau04ldg	grau
385-coau04ldbe	beige
385-coau04lda	gelb
385-coau04ldna	orange

### CORAL SEARCHIN

1 x E27 | 230V | max. 77W

385-coau04b	weiß
385-coau04g	grau
385-coau04be	beige
385-coau04a	gelb
385-coau04na	orange

### CORAL SEARCHIN G

4 x E27 | 230V | max. 77W

385-coau04gb	weiß
385-coau04gg	grau
385-coau04gbe	beige
385-coau04ga	gelb
385-coau04gna	orange

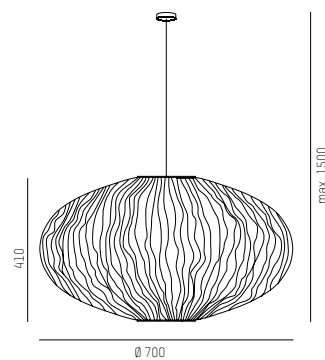
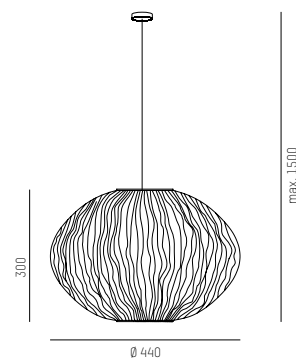
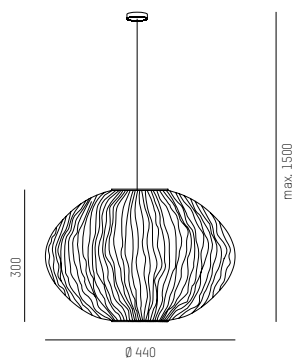



arturo alvarez  
emotional light

# CORAL SEA

Hängeleuchte aus SIMETECH®, bestückt mit Edelstahl-Ringe. Erhältlich in fünf Farbvarianten. LED Version mit integriertem dimmbarem LED-Konverter.

IP20 



### CORAL SEA LED

SYS 18,1W | 230V | 3000K  
1776lm | CRI>80  
Dimmbar Dali oder Switch Dim.

- 385-cose04ldb weiß
- 385-cose04ldg grau
- 385-cose04ldbe beige
- 385-cose04lda gelb
- 385-cose04ldna orange

### CORAL SEA

1 x E27 | 230V | max. 77W

- 385-cose04b weiß
- 385-cose04g grau
- 385-cose04be beige
- 385-cose04a gelb
- 385-cose04na orange

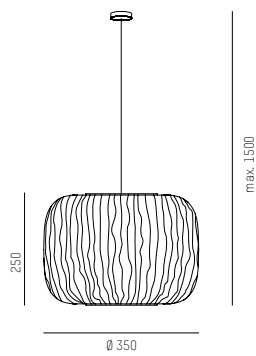
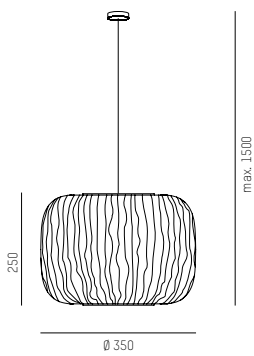



arturo alvarez  
emotional light

# CORAL

CAY

Hängeleuchte aus SIMETECH®, bestückt mit Edelstahl-Ringe. Erhältlich in fünf Farbvarianten. LED Version mit integriertem dimmbarem LED-Konverter.

IP20 



## CORAL CAY LED

SYS 18,1W | 230V | 3000K  
1776lm | CRI>80  
Dimmbar Dali oder Switch Dim.

- 385-cocy04ldb weiß
- 385-cocy04ldg grau
- 385-cocy04ldbe beige
- 385-cocy04lda gelb
- 385-cocy04ldna orange

## CORAL CAY

1 x E27 | 230V | max. 77W

- 385-cocy04b weiß
- 385-cocy04g grau
- 385-cocy04be beige
- 385-cocy04a gelb
- 385-cocy04na orange

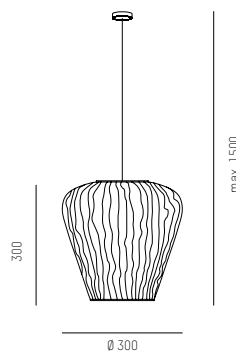
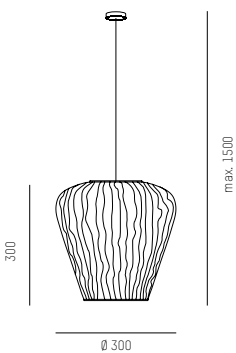



**arturo alvarez**  
emotional light

# CORAL REEF

Hängeleuchte aus SIMETECH®, bestückt mit Edelstahl-Ringe. Erhältlich in fünf Farbvarianten. LED Version mit integriertem dimmbarem LED-Konverter.

IP20 



## CORAL REEF LED

SYS 18,1W | 230V | 3000K  
1776lm | CRI>80  
Dimmbar Dali oder Switch Dim.

- 385-core04ldb weiß
- 385-core04ldg grau
- 385-core04ldbe beige
- 385-core04lda gelb
- 385-core04ldna orange

## CORAL REEF

1 x E27 | 230V | max. 77W

- 385-core04b weiß
- 385-core04g grau
- 385-core04be beige
- 385-core04a gelb
- 385-core04na orange

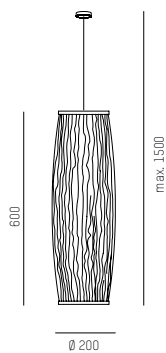
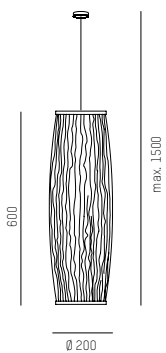





arturo alvarez  
emotional light

# CORAL

GALAXEA

Hängeleuchte aus SIMETECH®, bestückt mit Edelstahl-Ringe. Erhältlich in fünf Farbvarianten. LED Version mit integriertem dimmbarem LED-Konverter.

IP20 



### CORAL GALAXEA LED

SYS 18,1W | 230V | 3000K  
1776lm | CRI>80  
Dimmbar Dali oder Switch Dim.

- 385-coga04ldb weiß
- 385-coga04ldg grau
- 385-coga04ldbe beige
- 385-coga04lda gelb
- 385-coga04ldna orange

### CORAL GALAXEA

1 x E27 | 230V | max. 77W

- 385-coga04b weiß
- 385-coga04g grau
- 385-coga04be beige
- 385-coga04a gelb
- 385-coga04na orange

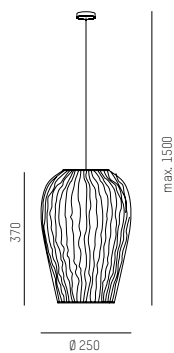
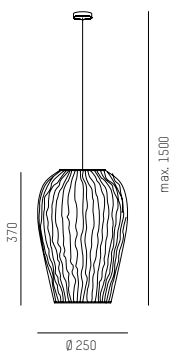



**arturo alvarez**  
emotional light

# GEA

Hängeleuchte aus SIMETECH®, bestückt mit Edelstahl-Ringe. Erhältlich in fünf Farbvarianten. LED Version mit integriertem dimmbarem LED-Konverter.

IP20 



## GEA LED

SYS 18,1W | 230V | 3000K  
1776lm | CRI>80  
Dimmbar Dali oder Switch Dim.

<b>385-ge04ldb</b>	weiß
<b>385-ge04ldg</b>	grau
<b>385-ge04ldbe</b>	beige
<b>385-ge04lda</b>	gelb
<b>385-ge04ldna</b>	orange

## GEA

1 x E27 | 230V | max. 77W

<b>385-ge04b</b>	weiß
<b>385-ge04g</b>	grau
<b>385-ge04be</b>	beige
<b>385-ge04a</b>	gelb
<b>385-ge04na</b>	orange

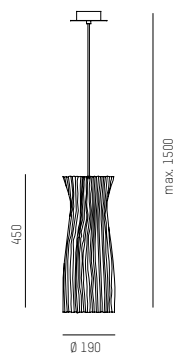
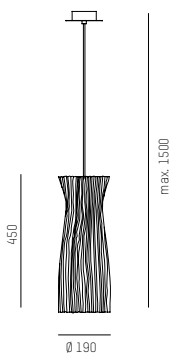



arturo alvarez  
emotional light

# GEA

Stehleuchte aus SIMETECH®, inkl. Fussdimmer. Erhältlich in fünf Farbvarianten.

A+ - E  
IP20 



**GEA**

5 x E27 | 230V | max. 77W

- 385-ge03b      weiß
- 385-ge03g      grau
- 385-ge03be    beige
- 385-ge03a      gelb
- 385-ge03na    orange

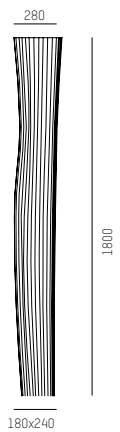

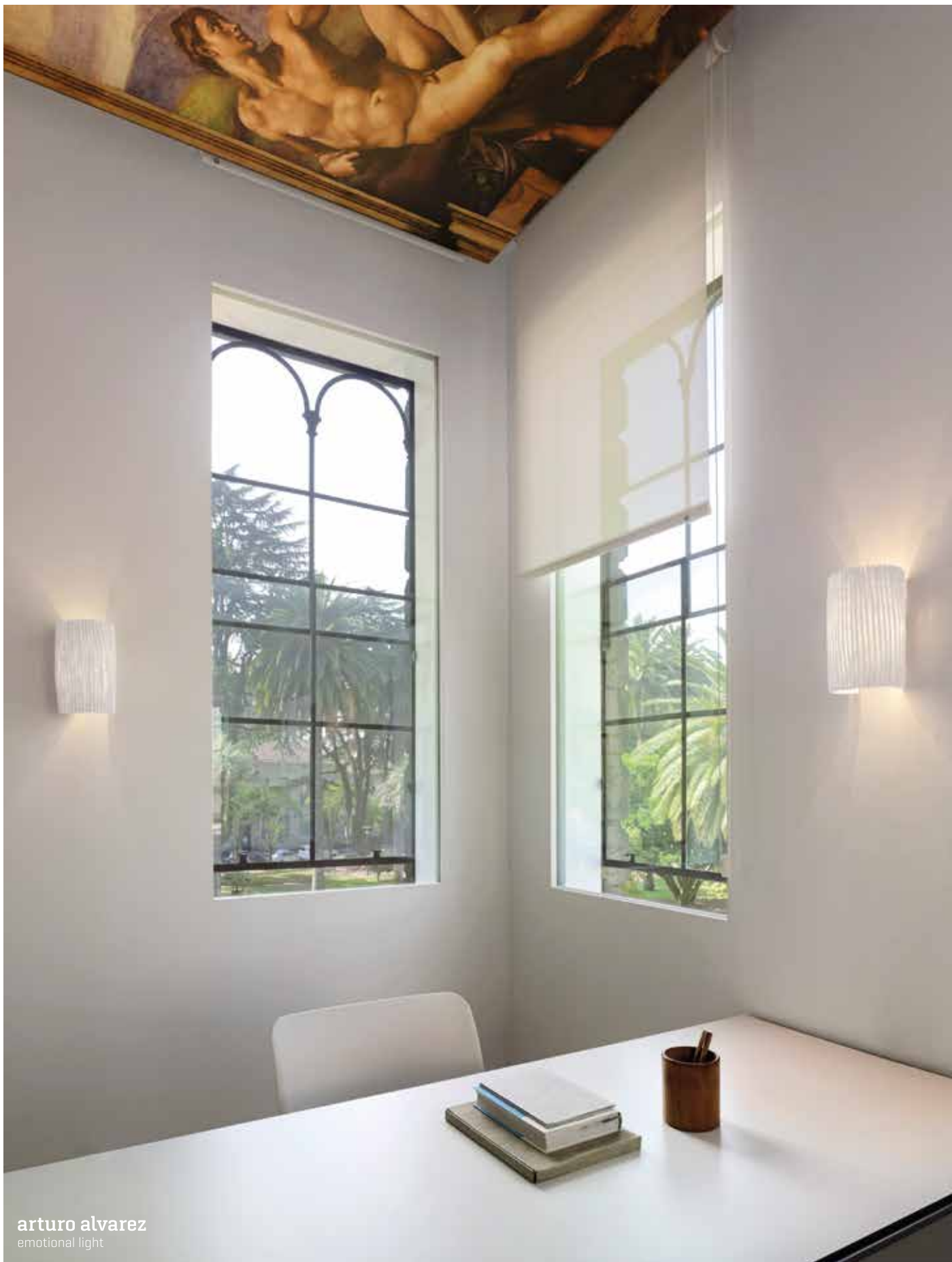

arturo alvarez  
emotional light

# GEA

Wandleuchte aus SIMETECH®.  
Erhältlich in fünf Farbvarianten.

A+ - E  
IP20  



## GEA

2 x 69 | 230V | max. 33W

- 385-ge06b weiß
- 385-ge06g grau
- 385-ge06be beige
- 385-ge06a gelb
- 385-ge06na orange

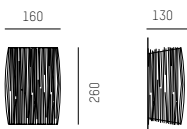





arturo alvarez  
emotional light

# KITE

Hängeleuchte aus SIMETECH®.  
Dimmbare Version mit integriertem dimmbarem EVG.  
Erhältlich in fünf Farbvarianten.

A → B  
IP20  



### KITE

1 x 26X13 | 230V | 55W

- 385-kt04b      weiß
- 385-kt04g      grau
- 385-kt04be    beige
- 385-kt04a      gelb
- 385-kt04na    orange

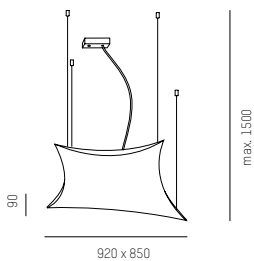

### KITE

1 x 26X13 | 230V | 55W  
Dimmbar Dali oder Switch Dim.

- 385-kt04db    weiß
- 385-kt04dg    grau
- 385-kt04dbe   beige
- 385-kt04da    gelb
- 385-kt04dna   orange

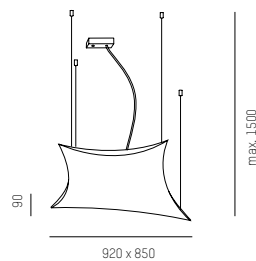

### KITE G

4 x 65 | 230V | 24W

- 385-kt04gb    weiß
- 385-kt04gg    grau
- 385-kt04gbe   beige
- 385-kt04ga    gelb
- 385-kt04gna   orange

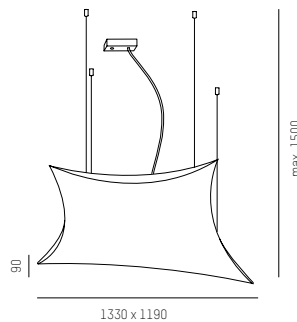

### KITE G

4 x 65 | 230V | 24W  
Dimmbar Dali oder Switch Dim.

- 385-kt04gdb    weiß
- 385-kt04gdg    grau
- 385-kt04gdbbe beige
- 385-kt04gda    gelb
- 385-kt04gdna   orange

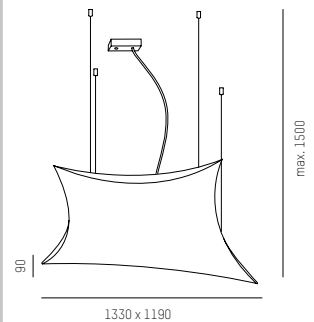



arturo alvarez  
emotional light

# KITE

Decken- /Wandleuchte aus SIMETECH®.  
Dimmbare Version mit integriertem dimmbaren EVG.  
Erhältlich in fünf Farbvarianten.

A+ → B  
IP20  



### KITE

1 x 26X13 | 230V | 55W

- 385-kt06b weiß
- 385-kt06g grau
- 385-kt06be beige
- 385-kt06a gelb
- 385-kt06na orange

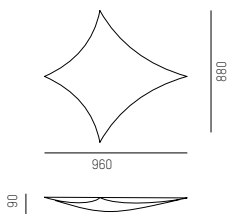

### KITE

1 x 26X13 | 230V | 55W  
Dimmbar Dali oder Switch Dim.

- 385-kt06db weiß
- 385-kt06dg grau
- 385-kt06dbe beige
- 385-kt06da gelb
- 385-kt06dna orange

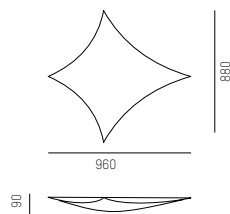

### KITE G

4 x G5 | 230V | 24W

- 385-kt06gb weiß
- 385-kt06gg grau
- 385-kt06gbe beige
- 385-kt06ga gelb
- 385-kt06gna orange

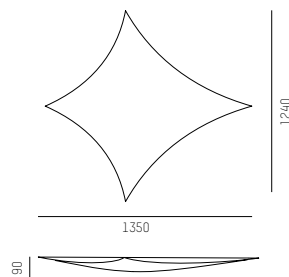

### KITE G

4 x G5 | 230V | 24W  
Dimmbar Dali oder Switch Dim.

- 385-kt06gdb weiß
- 385-kt06gdg grau
- 385-kt06gdbe beige
- 385-kt06gda gelb
- 385-kt06gdna orange

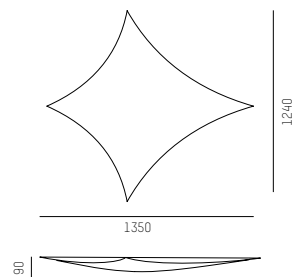



arturo alvarez  
emotional light

# PLANUM

Decken-/Wandleuchte aus SIMETECH®.  
Erhältlich in fünf Farbvarianten.

IP20  



## PLANUM R

4 x 65 | 230V | 24W

<b>385-pm06rb</b>	weiß
<b>385-pm06rg</b>	grau
<b>385-pm06rbe</b>	beige
<b>385-pm06ra</b>	gelb
<b>385-pm06rna</b>	orange

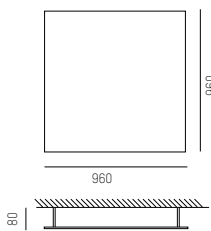

A\* - B

## PLANUM R LED

SYS 73,6W | 230V | 3000K  
9600lm | CRI>80  
Dimmbar Dali oder Switch Dim.

<b>385-pm06rldb</b>	weiß
<b>385-pm06rldg</b>	grau
<b>385-pm06rldbe</b>	beige
<b>385-pm06rlda</b>	gelb
<b>385-pm06rldna</b>	orange

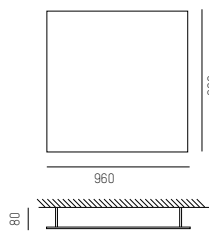

A\* - A

## PLANUM PR

2 x 65 | 230V | 24W

<b>385-pm06prb</b>	weiß
<b>385-pm06prg</b>	grau
<b>385-pm06prbe</b>	beige
<b>385-pm06pra</b>	gelb
<b>385-pm06prna</b>	orange

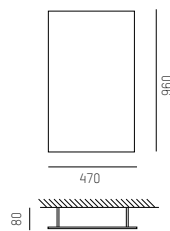

A\* - B

## PLANUM PR LED

SYS 36,8W | 230V | 3000K  
4800lm | CRI>80  
Dimmbar Dali oder Switch Dim.

<b>385-pm06prldb</b>	weiß
<b>385-pm06prldg</b>	grau
<b>385-pm06prldbe</b>	beige
<b>385-pm06prlda</b>	gelb
<b>385-pm06prldna</b>	orange

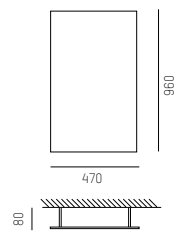



A\* - A



**arturo alvarez**  
emotional light

# URA

Hängeleuchten aus lackiertem Edestahl-Metallgeflecht in drei Farbvarianten. LED Version mit integriertem dimmbarem LED-Konverter.

A++ - A LED   
A++ - E E27   
 IP20 



### URA 1 LED

SYS 18,1W | 230V | 3000K  
1776lm | CRI>80  
Dimmbar Dali oder Switch Dim.

**385-ur104ldb** weiß  
**385-ur104ldv** grün  
**385-ur104ldo** ocker

### URA 2 LED

SYS 18,1W | 230V | 3000K  
1776lm | CRI>80  
Dimmbar Dali oder Switch Dim.

**385-ur204ldb** weiß  
**385-ur204ldv** grün  
**385-ur204ldo** ocker

### URA 3 LED

SYS 18,1W | 230V | 3000K  
1776lm | CRI>80  
Dimmbar Dali oder Switch Dim.

**385-ur304ldb** weiß  
**385-ur304ldv** grün  
**385-ur304ldo** ocker

### URA 1

1 x E27 | 230V | max. 77W

**385-ur104b** weiß  
**385-ur104v** grün  
**385-ur104o** ocker



### URA 2

1 x E27 | 230V | max. 77W

**385-ur204b** weiß  
**385-ur204v** grün  
**385-ur204o** ocker

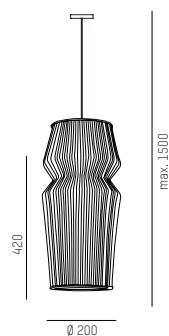

### URA 3

1 x E27 | 230V | max. 77W

**385-ur304b** weiß  
**385-ur304v** grün  
**385-ur304o** ocker

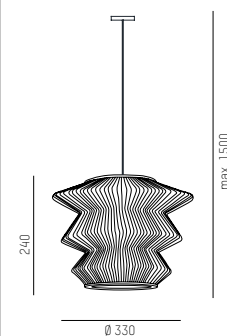





**arturo alvarez**  
emotional light

# URA

Tisch- und Stehleuchte aus lackiertem Edelstahl-Metallgeflecht, inkl. Fussdimmer. Füße aus Edelstahl. Nur in weiss erhältlich.

A+ - E  
IP20  



**URA TL**

1 x E27 | 230V | max. 77W

**385-ur01b**      weiß

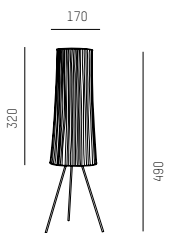

**URA STL**

3 x E27 | 230V | max. 77W

**385-ur03b**      weiß

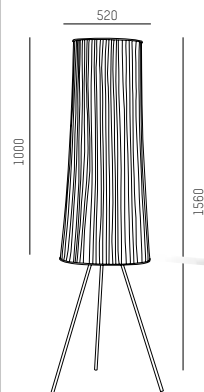



**arturo alvarez**  
emotional light

# ONN

Hängeleuchten aus lackiertem Edelstahl-Metallgeflecht. Erhältlich in drei Farbvarianten. LED Version mit integriertem dimmbarem LED-Konverter.

IP20 



### ONN LED

SYS 18,1W | 230V | 3000K  
1776lm | CRI>80  
Dimmbar Dali oder Switch Dim.

**385-on04ldb** weiß  
**385-on04ldv** grün  
**385-on04ldo** ocker

### ONN

1 x E27 | 230V | max. 77W

**385-on04b** weiß  
**385-on04v** grün  
**385-on04o** ocker

### ONN G LED

SYS 18,1W | 230V | 3000K  
1776lm | CRI>80  
Dimmbar Dali oder Switch Dim.

**385-on04glb** weiß  
**385-on04glv** grün  
**385-on04gldo** ocker

### ONN G

3 x E27 | 230V | max. 77W

**385-on04gb** weiß  
**385-on04gv** grün  
**385-on04go** ocker

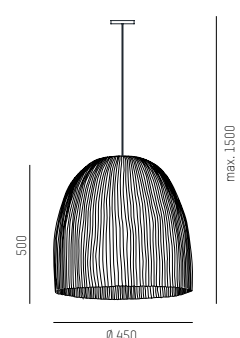
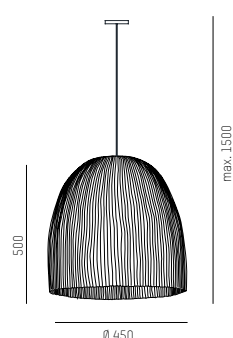
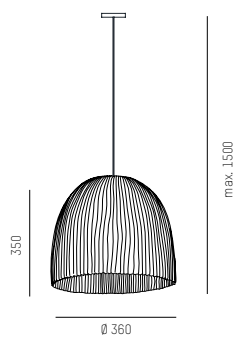
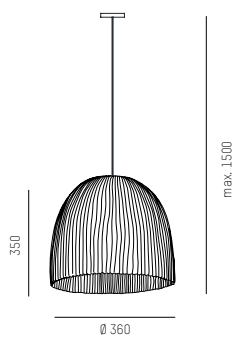



arturo alvarez  
emotional light

# ONN

Wandleuchte aus lackiertem Edelstahl-Metallgeflecht. Nur in weiss erhältlich.

A++ E  
IP20  



## ONN

1 x E27 | 230V | max. 77W

**385-on06b**      weiß

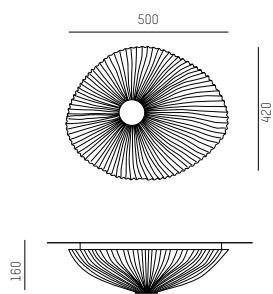

## ONN G

3 x E27 | 230V | max. 77W

**385-on06gb**      weiß

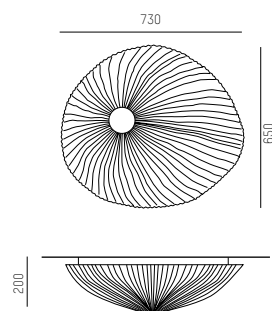

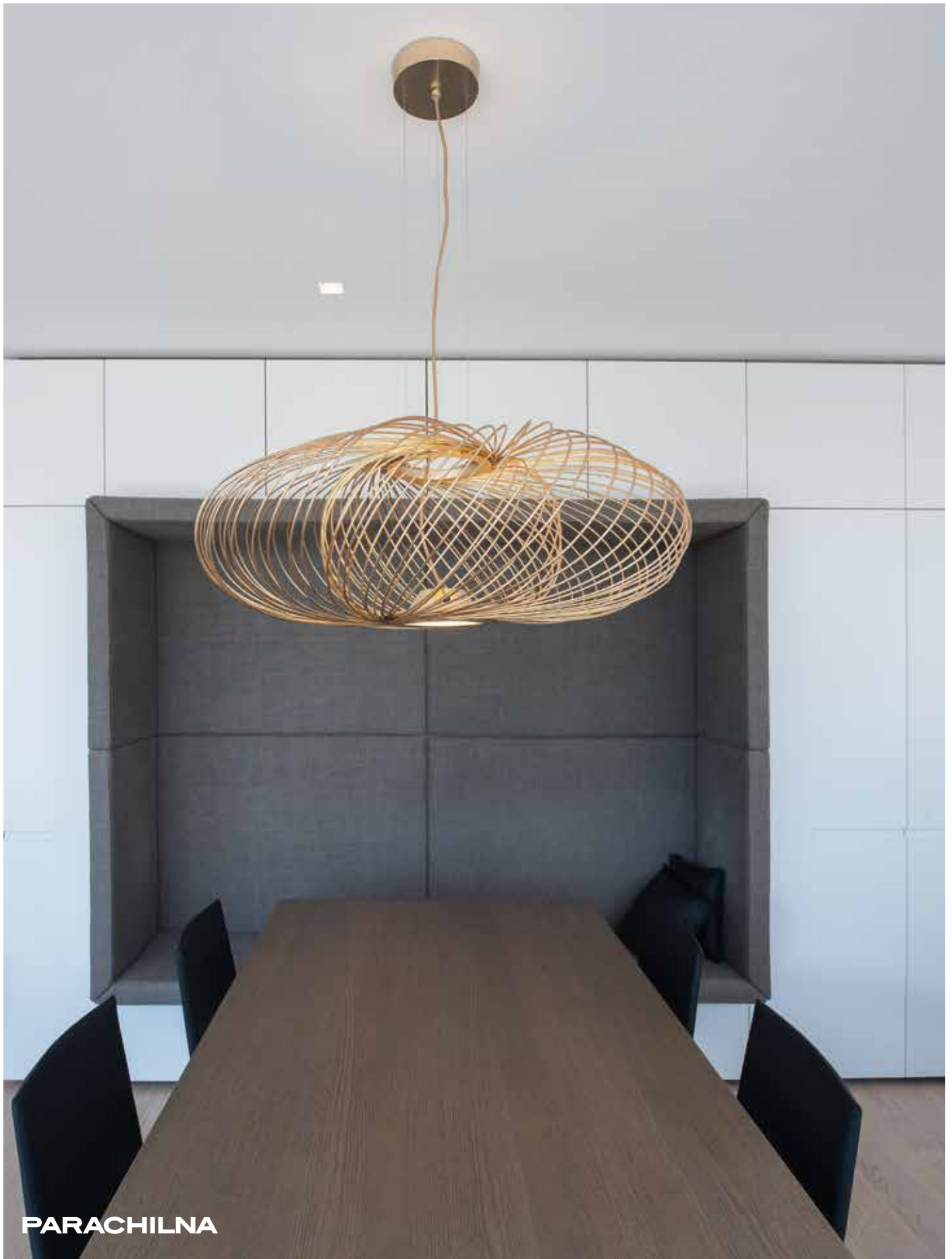

PARACHILNA

# ANWAR







**PARACHILNA**

Design: Stephen Burks

# ANWAR

Hängeleuchten mit Schirm aus Metall, in drei Modellen und drei Farbvarianten verfügbar. ANWAR kann auch individuell konfiguriert werden, direkt-/ indirekt strahlend, inkl. LED Konverter

A++ - A  
IP20  

## ANWAR T30

### EINZELLEUCHE

SYS 34W | 230V | 2700K | 2600lm

456-102000600006 schwarz  
456-102000600007 gold  
456-102000600008 kupfer

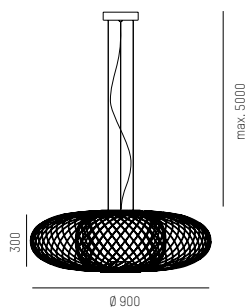

## ANWAR T45

### EINZELLEUCHE

SYS 34W | 230V | 2700K | 2600lm

456-101000600006 schwarz  
456-101000600007 gold  
456-101000600008 kupfer

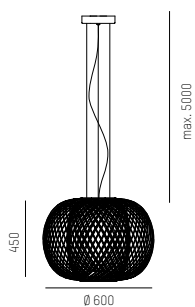

## ANWAR T90

### EINZELLEUCHE

SYS 34W | 230V | 2700K | 2600lm

456-103000600006 schwarz  
456-103000600007 gold  
456-103000600008 kupfer

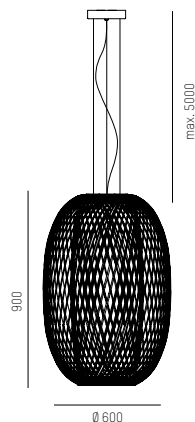

## ANWAR T STRUKTUR

### KONFIGURATIONSLEUCHE

SYS 34W | 230V | 2700K | 2600lm

456-701000700006 schwarz  
456-701000700007 gold  
456-701000700008 kupfer

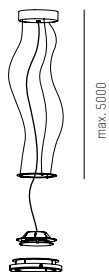

Struktur ohne Schirm  
[separat ordern]

## ANWAR 30 SCHIRM

separat ordern

Passend zu ANWAR T Struktur

456-802000000006 schwarz  
456-802000000007 gold  
456-802000000008 kupfer

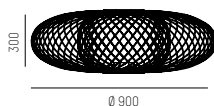

## ANWAR 45 SCHIRM

separat ordern

Passend zu ANWAR T Struktur

456-801000000006 schwarz  
456-801000000007 gold  
456-801000000008 kupfer

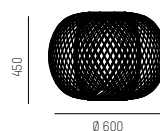

## ANWAR 90 SCHIRM

separat ordern

Passend zu ANWAR T Struktur

456-803000000006 schwarz  
456-803000000007 gold  
456-803000000008 kupfer

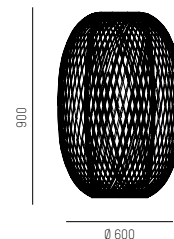

## KONFIGURATIONSBEISPIELE

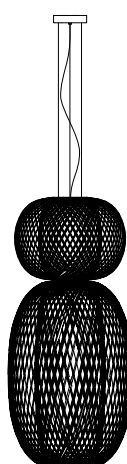
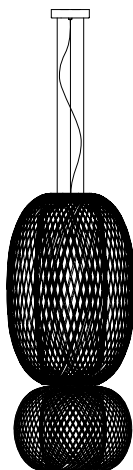
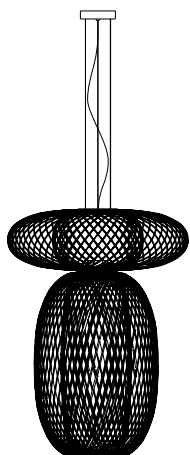



**PARACHILNA**

Design: Stephen Burks

# ANWAR

Stehleuchten mit Schirm aus Metall, in zwei Modellen und drei Farbvarianten verfügbar. ANWAR kann auch individuell konfiguriert werden, inkl. LED Konverter

A++ - A  
IP20  

## ANWAR P45

### EINZELLEUCHE

SYS 17W | 230V | 2700K | 1300lm

456-304000700006 schwarz  
456-304000700007 gold  
456-304000700008 kupfer

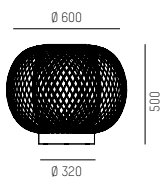

## ANWAR P90

### EINZELLEUCHE

SYS 17W | 230V | 2700K | 1300lm

456-305000700006 schwarz  
456-305000700007 gold  
456-305000700008 kupfer

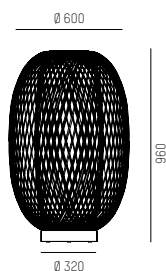

## ANWAR P45

### KONFIGURATIONSLEUCHE

2 x SYS 17W | 230V | 2700K  
2 x 1300lm

456-704000000006 schwarz  
456-704000000007 gold  
456-704000000008 kupfer

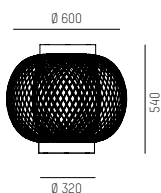

## ANWAR 30 SCHIRM

separat ordern  
Passend zu ANWAR P Leuchte

456-802000000006 schwarz  
456-802000000007 gold  
456-802000000008 kupfer



## ANWAR 45 SCHIRM

separat ordern  
Passend zu ANWAR P Leuchte

456-801000000006 schwarz  
456-801000000007 gold  
456-801000000008 kupfer

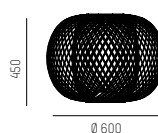

## ANWAR 90 SCHIRM

separat ordern  
Passend zu ANWAR P Leuchte

456-803000000006 schwarz  
456-803000000007 gold  
456-803000000008 kupfer

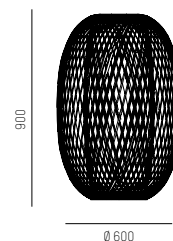

## ANWAR P90

### KONFIGURATIONSLEUCHE

2 x SYS 17W | 230V | 2700K  
2 x 1300lm

456-705000000006 schwarz  
456-705000000007 gold  
456-705000000008 kupfer

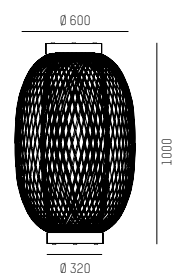

### KONFIGURATIONSBEISPIELE

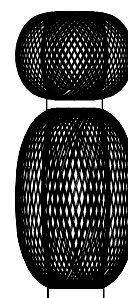
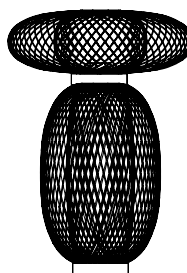
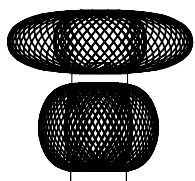



selène®

# KLUVI

Hängeleuchtenkollektion in drei verschiedenen Größen aus Metall mit einer Kugel aus opalem, geblasenem Glas. Die Ausführungen sind Chrom oder glänzendes Kupfer.

A++ - E  
IP20  



### KLUVI S

1 x G9 | 230V | max. 33W

**383-1093002** chrom  
**383-1093025** kupfer

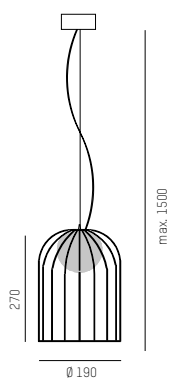

### KLUVI M

1 x E14 | 230V | max. 42W

**383-1094002** chrom  
**383-1094025** kupfer

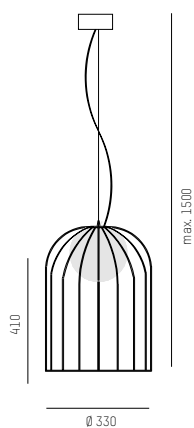

### KLUVI L

1 x E27 | 230V | max. 42W

**383-1095002** chrom  
**383-1095025** kupfer

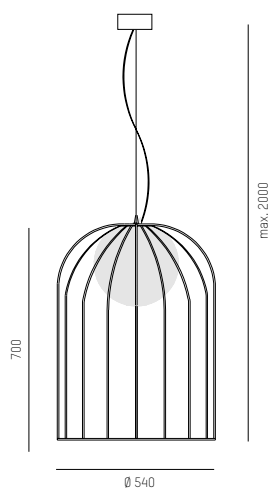



selène®

# KLUVI

Tischleuchtenkollektion in drei verschiedenen Größen aus Metall mit einer Kugel aus opalem, geblasenen Glas. Die Ausführungen sind Chrom oder glänzendes Kupfer.

A+ - E  
IP 20  



### KLUVI S

1 x G9 | 230V | max. 33W

**383-1096002** chrom  
**383-1096025** kupfer

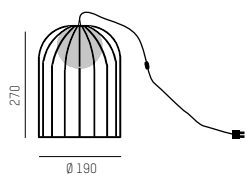

### KLUVI M

1 x E14 | 230V | max. 42W

**383-1097002** chrom  
**383-1097025** kupfer

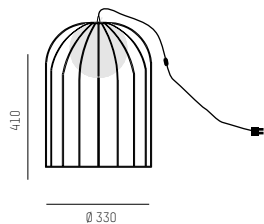

### KLUVI L

1 x E27 | 230V | max. 42W

**383-1098002** chrom  
**383-1098025** kupfer

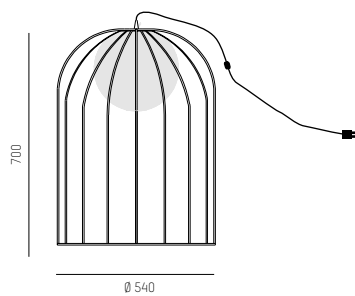





Vesoi

# IDEATWIN

Pendelleuchte aus Metall in den Farben weiß, schwarz, Altmessing oder chrom. Stoffkabel schwarz.  
Bei Variante weiß: Stoffkabel weiß

A++ - E  
IP20  



## IDEATWIN HL

2 x E27 | 230V | max. 42W

264-so00417	weiß
264-so00418	schwarz
264-so00419	chrom
264-so00944	Altmessing

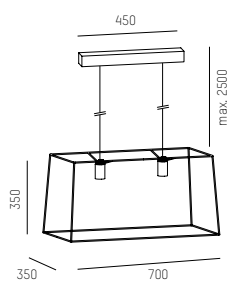



Vesoi

# IDEATELAIO

Deckenleuchten aus  
Metall, in weiß, schwarz  
oder chrom erhältlich

A++ - E  
IP20 



### IDEATELAIO 35 PL CONO

1 x E27 | 230V | max. 42W

264-pl01591 weiß  
 264-pl01592 schwarz  
 264-pl01594 chrom



### IDEATELAIO 50 PL CONO

1 x E27 | 230V | max. 42W

264-pl01600 weiß  
 264-pl01601 schwarz  
 264-pl01599 chrom

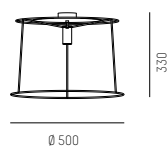

### IDEATELAIO 35 PL CUBO

1 x E27 | 230V | max. 42W

264-pl01579 weiß  
 264-pl01580 schwarz  
 264-pl01582 chrom



### IDEATELAIO 50 PL CUBO

1 x E27 | 230V | max. 42W

264-pl01587 weiß  
 264-pl01588 schwarz  
 264-pl01590 chrom

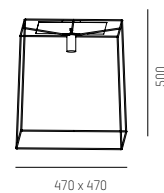

### IDEATELAIO 35 PL 110 CONO

1 x E27 | 230V | max. 42W

264-pl01596 weiß  
 264-pl01597 schwarz  
 264-pl01595 chrom

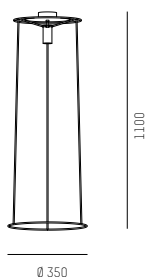

### IDEATELAIO 50 PL 110 CONO

1 x E27 | 230V | max. 42W

264-pl01604 weiß  
 264-pl01605 schwarz  
 264-pl01603 chrom

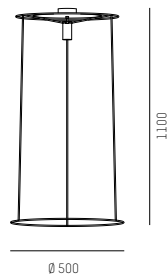

### IDEATELAIO 35 PL 110 CUBO

1 x E27 | 230V | max. 42W

264-pl01575 weiß  
 264-pl01576 schwarz  
 264-pl01578 chrom

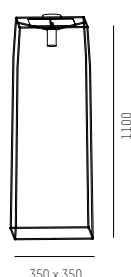

### IDEATELAIO 50 PL 110 CUBO

1 x E27 | 230V | max. 42W

264-pl01584 weiß  
 264-pl01585 schwarz  
 264-pl01583 chrom

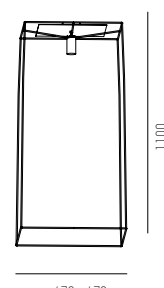





Vesoi

# MULTIPLLO

Hängeleuchten aus Metall Messing  
lackiert mit Glaskugel satiniert, in  
verschiedenen Größen erhältlich

A++ - E  
IP20  

## MULTIPLIO 24 SO VERTICALE

1 x G9 | 230V | max. 33W

264-so01368 Messing/weiß  
264-so01370 Messing/schwarz

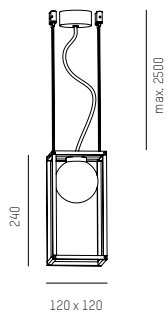

## MULTIPLIO 40 SO VERTICALE

1 x G9 | 230V | max. 33W

264-so01376 Messing/weiß  
264-so01378 Messing/schwarz

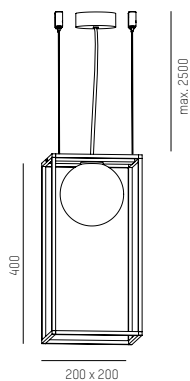

## MULTIPLIO 80 SO VERTICALE

1 x E27 | 230V | max. 42W

264-so01384 Messing/weiß  
264-so01386 Messing/schwarz

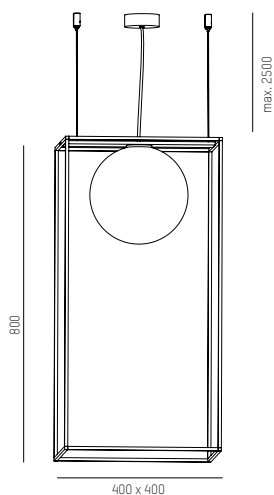

## MULTIPLIO 24 SO HORIZONTALE

2 x G9 | 230V | max. 33W

264-so01364 Messing/weiß  
264-so01366 Messing/schwarz

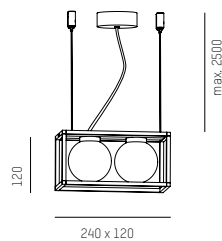

## MULTIPLIO 40 SO HORIZONTALE

2 x G9 | 230V | max. 33W

264-so01372 Messing/weiß  
264-so01374 Messing/schwarz

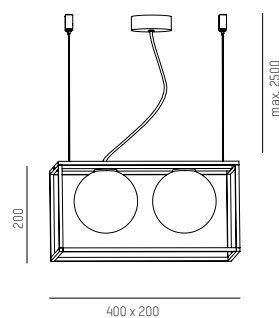

## MULTIPLIO 80 SO HORIZONTALE

2 x E27 | 230V | max. 42W

264-so01380 Messing/weiß  
264-so01382 Messing/schwarz

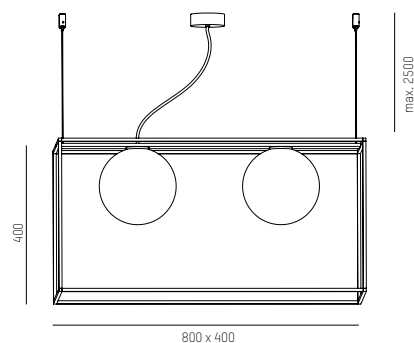



Vesoi

# MULTIPLO

Wand-/ Deckenleuchten aus  
Metall mit Glaskugel satiniert, in  
verschiedenen Größen erhältlich

A++ - E  
IP20 

## MULTIPLO 24 SP VERTICALE

1 x G9 | 230V | max. 33W

264-sp00107 Messing/weiß  
264-sp00109 Messing/schwarz

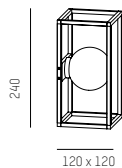

## MULTIPLO 40 SP VERTICALE

1 x G9 | 230V | max. 33W

264-sp00115 Messing/weiß  
264-sp00117 Messing/schwarz

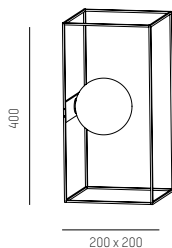

## MULTIPLO 80 SP VERTICALE

1 x E27 | 230V | max. 42W

264-sp00123 Messing/weiß  
264-sp00125 Messing/schwarz

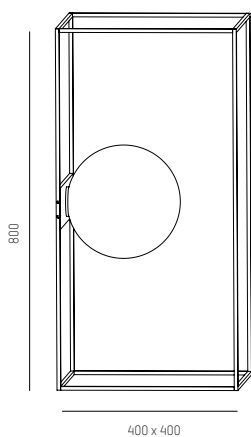

## MULTIPLO 24 SP HORIZONTALE

2 x G9 | 230V | max. 33W

264-sp00103 Messing/weiß  
264-sp00105 Messing/schwarz

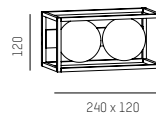

## MULTIPLO 40 SP HORIZONTALE

2 x G9 | 230V | max. 33W

264-sp00111 Messing/weiß  
264-sp00113 Messing/schwarz

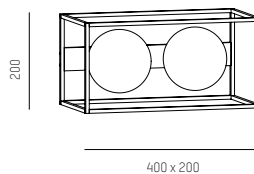

## MULTIPLO 80 SP HORIZONTALE

2 x E27 | 230V | max. 42W

264-sp00119 Messing/weiß  
264-sp00121 Messing/schwarz

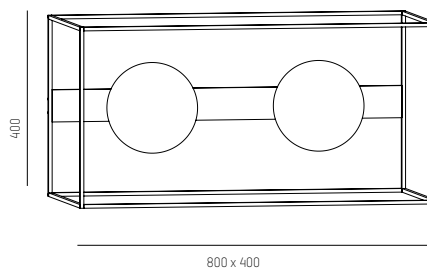





Vesoi

# MULTIPLO

Tisch- / Bodenleuchten aus Metall  
Messing lackiert mit Glaskugel  
satinert, in verschiedenen Größen  
erhältlich

A++ - E  
IP20  

## MULTIPLO 24 LP VERTICALE

1 x G9 | 230V | max. 33W

264-lp00294    Messing/weiß  
264-lp00296    Messing/schwarz

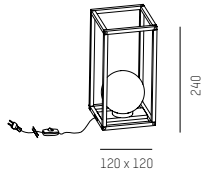

## MULTIPLO 40 LP VERTICALE

1 x G9 | 230V | max. 33W

264-lp00302    Messing/weiß  
264-lp00304    Messing/schwarz

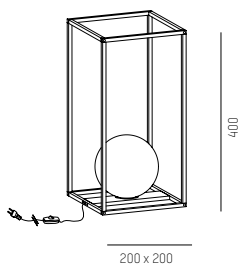

## MULTIPLO 80 LP VERTICALE

1 x E27 | 230V | max. 42W

264-lp00310    Messing/weiß  
264-lp00312    Messing/schwarz

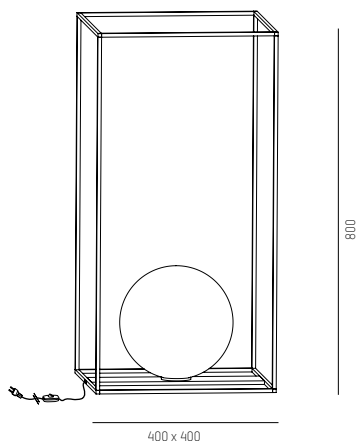

## MULTIPLO 24 LP HORIZONTALE

2 x G9 | 230V | max. 33W

264-lp00290    Messing/weiß  
264-lp00292    Messing/schwarz

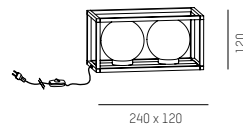

## MULTIPLO 40 LP HORIZONTALE

2 x G9 | 230V | max. 33W

264-lp00298    Messing/weiß  
264-lp00300    Messing/schwarz

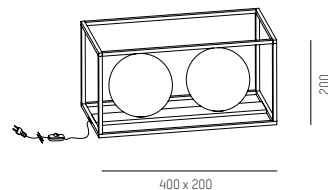

## MULTIPLO 80 LP HORIZONTALE

2 x E27 | 230V | max. 42W

264-lp00306    Messing/weiß  
264-lp00308    Messing/schwarz

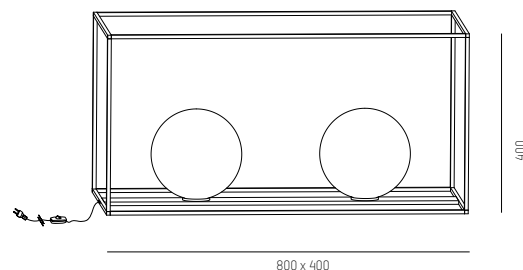



Design: Hangar Design Group

# FUTURA

Leuchtenserie mit mundgeblasenen Gläsern in drei Farben, Ring aus Metall in den Oberflächen anthrazithgrau, antikbraun oder Bronze. Amaturen in anthrazithgrau

A++ - E  
IP20  



## FUTURA SP G

1 x E27 | 230V | max. 77W

	<b>Glas / Struktur</b>
<b>64-10102</b>	kristall / grau
<b>64-10103</b>	kristall / braun
<b>64-10104</b>	kristall / bronze
<b>64-10105</b>	rauchgrau / grau
<b>64-10106</b>	rauchgrau / braun
<b>64-10107</b>	rauchgrau / bronze
<b>64-10108</b>	topas / grau
<b>64-10109</b>	topas / braun
<b>64-10110</b>	topas / bronze

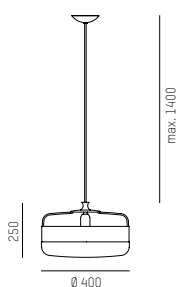

## FUTURA SP M

1 x E27 | 230V | max. 77W

	<b>Glas / Struktur</b>
<b>64-10111</b>	kristall / grau
<b>64-10112</b>	kristall / braun
<b>64-10113</b>	kristall / bronze
<b>64-10114</b>	rauchgrau / grau
<b>64-10115</b>	rauchgrau / braun
<b>64-10116</b>	rauchgrau / bronze
<b>64-10117</b>	topas / grau
<b>64-10118</b>	topas / braun
<b>64-10119</b>	topas / bronze

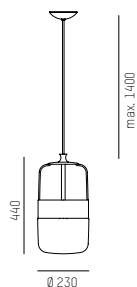

## FUTURA SP P

1 x E27 | 230V | max. 77W

	<b>Glas / Struktur</b>
<b>64-10120</b>	kristall / grau
<b>64-10121</b>	kristall / braun
<b>64-10122</b>	kristall / bronze
<b>64-10123</b>	rauchgrau / grau
<b>64-10124</b>	rauchgrau / braun
<b>64-10125</b>	rauchgrau / bronze
<b>64-10126</b>	topas / grau
<b>64-10127</b>	topas / braun
<b>64-10128</b>	topas / bronze

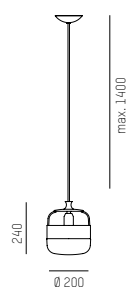



Design: Hangar Design Group

# FUTURA

Leuchtenserie mit mundgeblasenen Gläsern in drei Farben, Ring aus Metall in den Oberflächen anthrazithgrau, antikbraun oder Bronze. Amaturen in anthrazithgrau

A++ - E  
IP20 



## FUTURA PL G

1 x E27 | 230V | max. 77W

### Glas / Struktur

- 64-20033 kristall / grau
- 64-20034 kristall / braun
- 64-20035 kristall / bronze
  
- 64-20036 rauchgrau / grau
- 64-20037 rauchgrau / braun
- 64-20038 rauchgrau / bronze
  
- 64-20039 topas / grau
- 64-20040 topas / braun
- 64-20041 topas / bronze

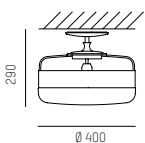



Design: Hangar Design Group

# FUTURA

Leuchtenserie mit mundgeblasenen Gläsern in drei Farben, Ring aus Metall in den Oberflächen anthrazithgrau, antikbraun oder Bronze. Amaturen in anthrazithgrau

A++ - E  
IP20  



## FUTURA AP P

1 x E27 | 230V | max. 77W

	Glas / Struktur
64-30014	kristall / grau
64-30015	kristall / braun
64-30016	kristall / bronze
64-30017	rauchgrau / grau
64-30018	rauchgrau / braun
64-30019	rauchgrau / bronze
64-30020	topas / grau
64-30021	topas / braun
64-30022	topas / bronze

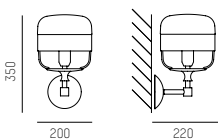

## FUTURA LT P

1 x E27 | 230V | max. 77W

	Glas / Struktur
64-40011	kristall / grau
64-40012	kristall / braun
64-40013	kristall / bronze
64-40014	rauchgrau / grau
64-40015	rauchgrau / braun
64-40016	rauchgrau / bronze
64-40017	topas / grau
64-40018	topas / braun
64-40019	topas / bronze

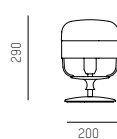

## FUTURA PT P

1 x E27 | 230V | max. 77W

	Glas / Struktur
64-50013	kristall / grau
64-50014	kristall / braun
64-50015	kristall / bronze
64-50016	rauchgrau / grau
64-50017	rauchgrau / braun
64-50018	rauchgrau / bronze
64-50019	topas / grau
64-50020	topas / braun
64-50021	topas / bronze

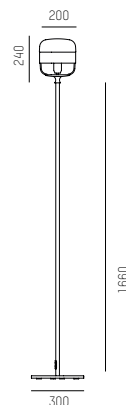





Vesoi

# PALLATRE

Hängeleuchte aus Metall mit  
Glaskugel satiniert, Höhenver-  
stellbar

A++ - E  
IP20  



### PALLATRE 30 SO

1 x E27 | 230V | max. 42W

**264-so01154** Messing / Kabel schwarz  
**264-so01165** Messing / Kabel weiß

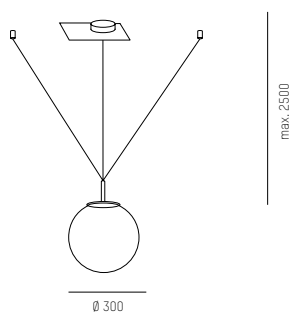

### PALLATRE 40 SO

1 x E27 | 230V | max. 42W

**264-so01158** Messing / Kabel schwarz  
**264-so01166** Messing / Kabel weiß

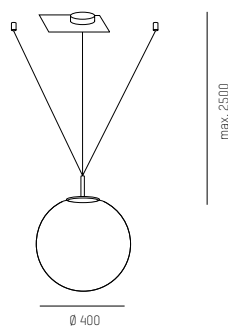

### PALLATRE 50 SO

1 x E27 | 230V | max. 42W

**264-so01161** Messing / Kabel schwarz  
**264-so01167** Messing / Kabel weiß

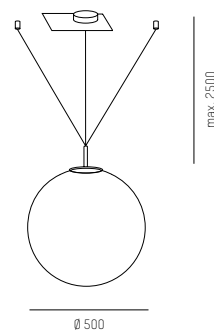





Vesoi

# PALLA

Hängeleuchten aus Metall mit  
Glaskugel satiniert, wahlweise mit  
Dezentralisierung

A++ - E  
IP20  



### PALLA 30 SO

1 x E27 | 230V | max. 42W

264-so00512 chrom  
 264-so00875 schwarz  
 264-so01117 Messing

### PALLA 30 SO DEC

1 x E27 | 230V | max. 42W

inkl. Dezentralisierung

264-so00862 chrom  
 264-so00877 schwarz  
 264-so01118 Messing

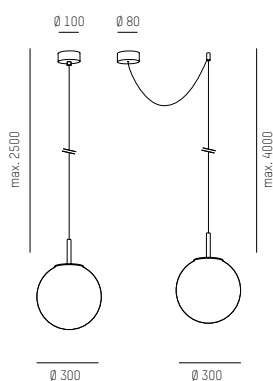

### PALLA 40 SO

1 x E27 | 230V | max. 42W

264-so00515 chrom  
 264-so00879 schwarz  
 264-so01119 Messing

### PALLA 40 SO DEC

1 x E27 | 230V | max. 42W

inkl. Dezentralisierung

264-so00863 chrom  
 264-so00881 schwarz  
 264-so01120 Messing

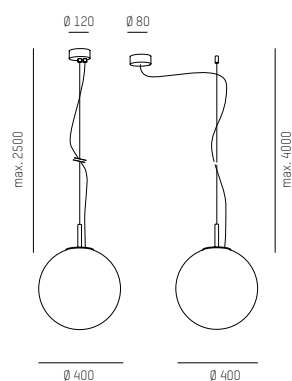

### PALLA 50 SO

1 x E27 | 230V | max. 42W

264-so00518 chrom  
 264-so00883 schwarz  
 264-so01121 Messing

### PALLA 50 SO DEC

1 x E27 | 230V | max. 42W

inkl. Dezentralisierung

264-so00520 chrom  
 264-so00885 schwarz  
 264-so01122 Messing

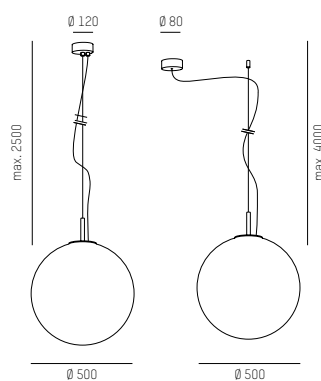

### PALLA 60 SO

1 x E27 | 230V | max. 42W

264-so00522 chrom  
 264-so00887 schwarz  
 264-so01123 Messing

### PALLA 60 SO DEC

1 x E27 | 230V | max. 42W

inkl. Dezentralisierung

264-so00524 chrom  
 264-so00889 schwarz  
 264-so01124 Messing

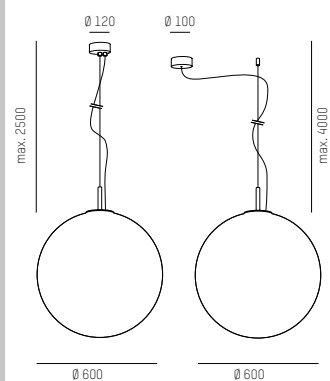



Vesoi

# PALLA

Decken- oder Tischleuchte aus  
Metall mit Glaskugel satiniert

A++ - E  
IP20 



### PALLA 25 SP

1 x E27 | 230V | max. 42W

264-sp00132 weiß  
 264-sp00134 schwarz  
 264-sp00133 Messing

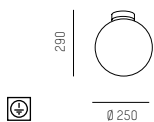

### PALLA 25 LP

1 x E27 | 230V | max. 42W

264-lp00187 chrom  
 264-lp00240 schwarz  
 264-lp00223 Messing

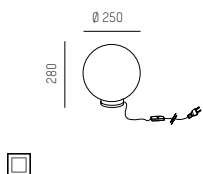

### PALLA 30 SP

1 x E27 | 230V | max. 42W

264-sp00136 weiß  
 264-sp00138 schwarz  
 264-sp00137 Messing

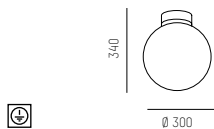

### PALLA 30 LP

1 x E27 | 230V | max. 42W

264-lp00188 chrom  
 264-lp00241 schwarz  
 264-lp00224 Messing

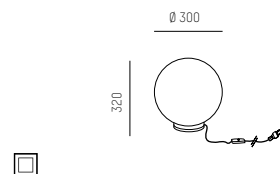

### PALLA 40 SP

1 x E27 | 230V | max. 42W

264-sp00140 weiß  
 264-sp00142 schwarz  
 264-sp00141 Messing

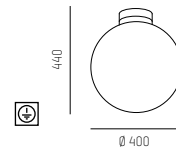

### PALLA 40 LP

1 x E27 | 230V | max. 42W

264-lp00136 chrom  
 264-lp00226 schwarz  
 264-lp00225 Messing

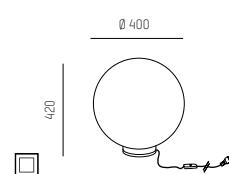





Vesoi

# PALLATRE

Tisch- oder Stehleuchten aus  
Metall mit Glaskugel satiniert

A++ - E  
IP20  



### PALLATRE 25 LP

1 x E27 | 230V | max. 42W

- 264-lp00665 weiß / Kabel weiß
- 264-lp00666 schwarz / Kabel schwarz
- 264-lp00668 Messing / Kabel schwarz

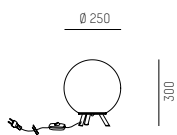

### PALLATRE 40 PH

1 x E27 | 230V | max. 42W

- 264-ph00305 weiß / Kabel weiß
- 264-ph00306 schwarz / Kabel schwarz
- 264-ph00307 Messing / Kabel schwarz

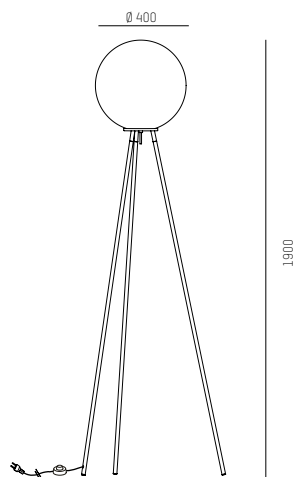

### PALLATRE 50 PH

1 x E27 | 230V | max. 42W

- 264-ph00309 weiß / Kabel weiß
- 264-ph00310 schwarz / Kabel schwarz
- 264-ph00312 Messing / Kabel schwarz

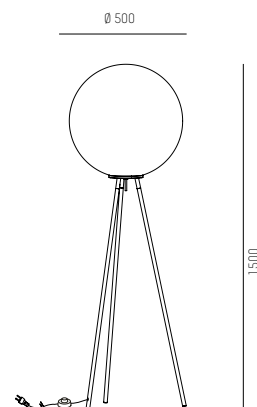





arturo alvarez  
emotional light

# TINA

Hängeleuchten aus Polypropylen-Streifen. LED Version mit integriertem dimmbarem LED-Konverter.

IP20 



### TINA LED

SYS 18,1W | 230V | 3000K  
1776lm | CRI>80  
Dimmbar Dali oder Switch Dim.

**385-tn04ldb**      weiß

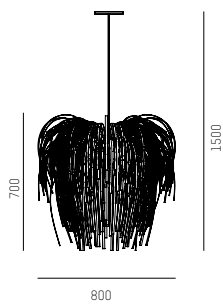

### TINA

1 x E27 | 230V | max. 77W

**385-tn04b**      weiß

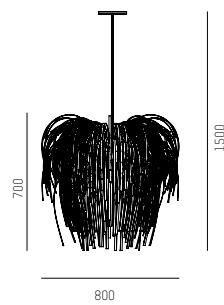

### TINA G LED

SYS 18,1W | 230V | 3000K  
1776lm | CRI>80  
Dimmbar Dali oder Switch Dim.

**385-tn04gldb**      weiß

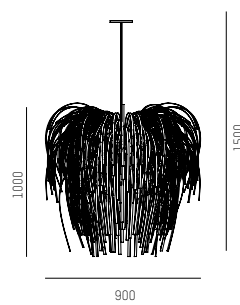

### TINA G

1 x E27 | 230V | max. 77W

**385-tn04gb**      weiß

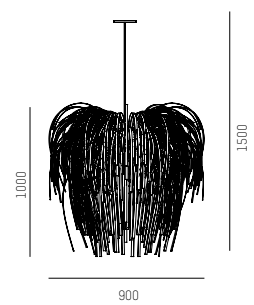



arturo alvarez  
emotional light

# TINA

Hängeleuchte aus Polypropylen-Streifen.

A++ E  
IP20  



## TINA

5 x E27 | 230V | max. 77W

385-tn045b      weiß

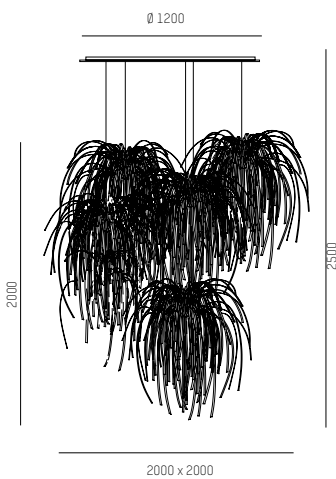

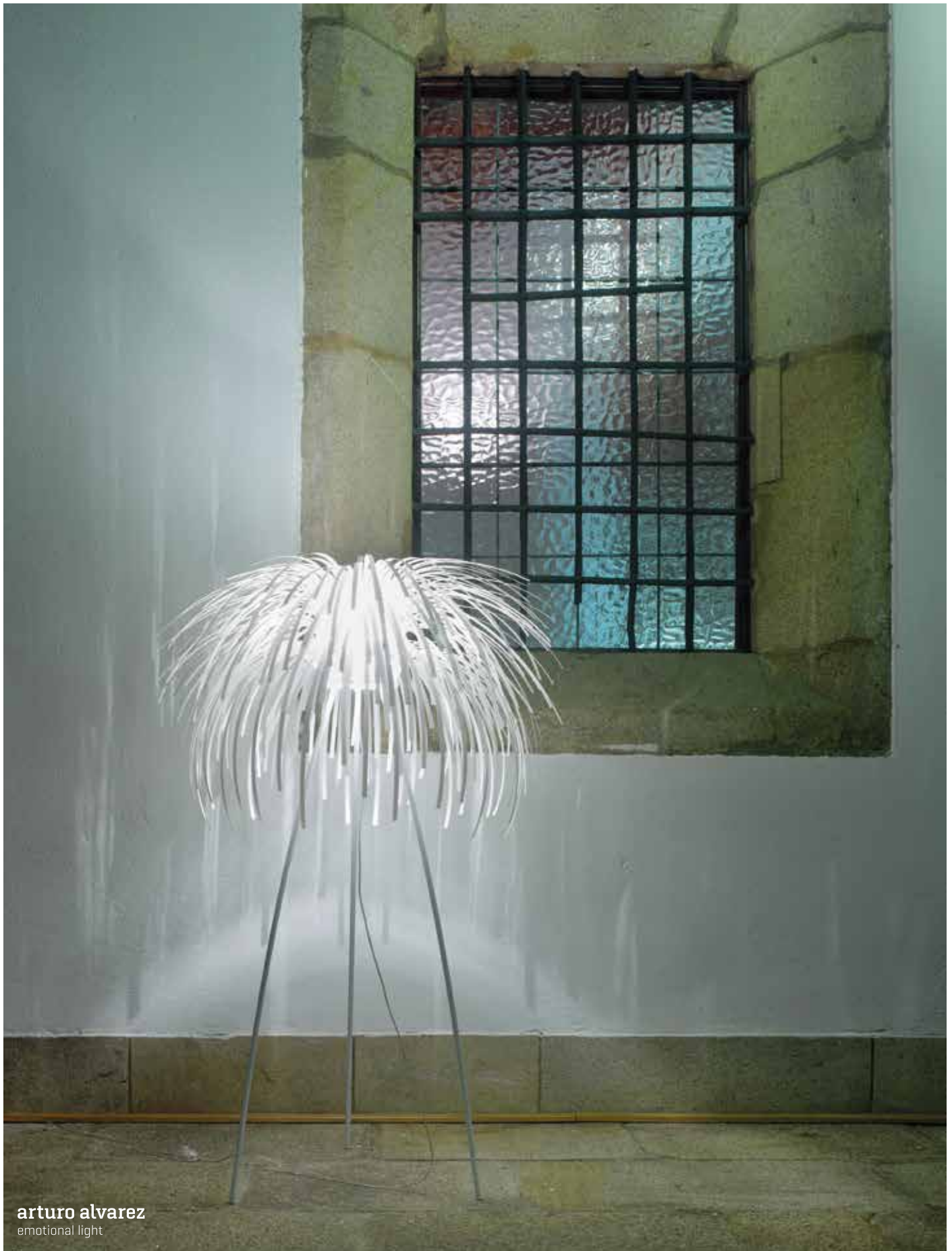

arturo alvarez  
emotional light

# TINA

Stehleuchte aus Polypropylen-Streifen.

IP20  



## TINA

1 x E27 | 230V | max. 77W

385-tn03b      weiß

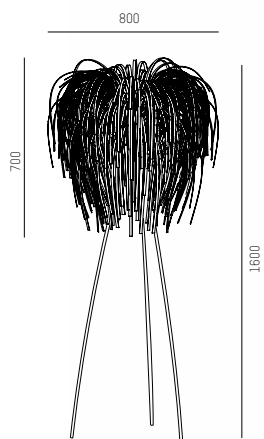



# FLOAT

Hänge/- Wandleuchten in drei verschiedenen Größen, Schirm aus Edelstahl, Kupfer gebürstet oder aus weißem Opalglas mit Applikationen aus geöltem Walnussholz. Stoffkabel in schwarz bzw. weiß.

A++ - E  
IP20  



### FLOAT 18

1 x E27 | 230V | max. 42W

- 302-78203001** Glas opal
- 302-78203030** Kupfer
- 302-78203032** Edelstahl

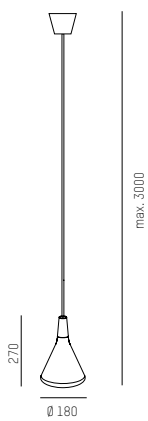

### FLOAT 27

1 x E27 | 230V | max. 42W

- 302-78213001** Glas opal
- 302-78213030** Kupfer
- 302-78213032** Edelstahl

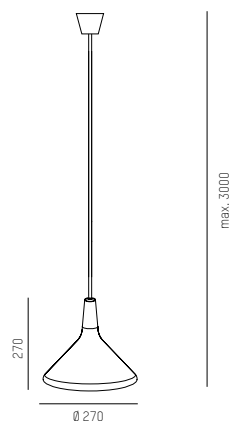

### FLOAT 39

1 x E27 | 230V | max. 42W

- 302-78223030** Kupfer
- 302-78223032** Edelstahl

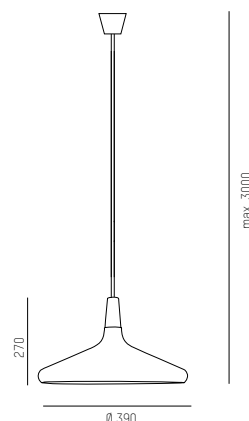

### FLOAT WALL

1 x GU10 | 230V | max. 42W

- 302-83001030** Kupfer
- 302-83001032** Edelstahl

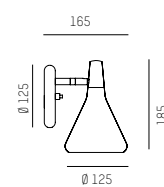







# PURE

Hängeleuchten mit Schirm aus Metall in den Farben schwarz, grau oder weiß lackiert mit Applikation aus geöltem Walnussholz. Stoffkabel in schwarz bzw. weiß.

A++ - E  
IP20  



## PURE

1 x E27 | 230V | max. 28W

302-78283001 weiß  
302-78283003 schwarz  
302-78283011 grau

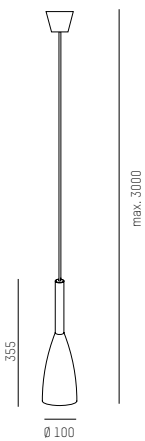



# PURE

Wand-, und Stehleuchtenserie aus Metall in den  
Farben schwarz, grau oder weiß lackiert mit  
Applikation aus geöltem Walnussholz, inkl. 180 cm Kabel

A++ - D  
IP20  



## PURE WALL

1 x GU10 | 230V | max. 8W LED

302-78271001 weiß  
 302-78271003 schwarz  
 302-78271011 grau

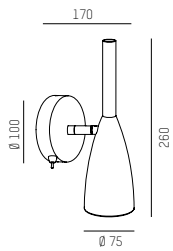

## PURE FLOOR

1 x GU10 | 230V | max. 8W LED

302-78294001 weiß  
 302-78294003 schwarz  
 302-78294011 grau

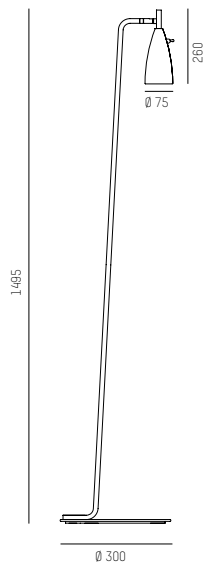



MOLTO LUCE®

Design: Serge Cornelissen

# LASH

Organisch geformte LED Leuchtenserie mit Opal-Diffusor aus rotationsgegossenem Polyethylen, hochwertige dunkelchrome Endkappen

A++ - A  
IP20 



## LASH HL

SYS 50W | 230V | 3000K | 5100lm | CRI>80

**660-10195** weiß opal / dunkelchrom

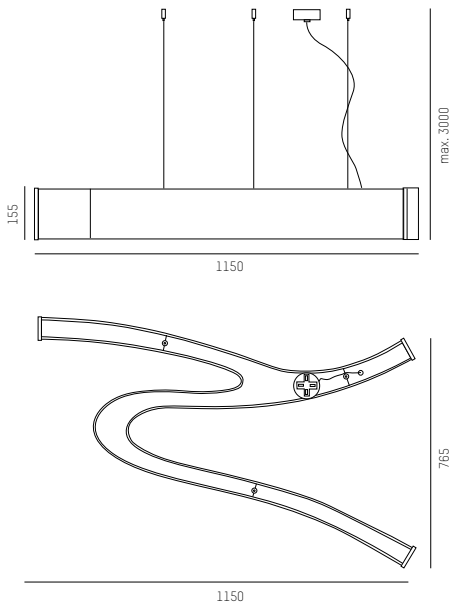

## LASH WL

SYS 50W | 230V | 3000K | 5100lm | CRI>80

**660-30195** weiß opal / dunkelchrom

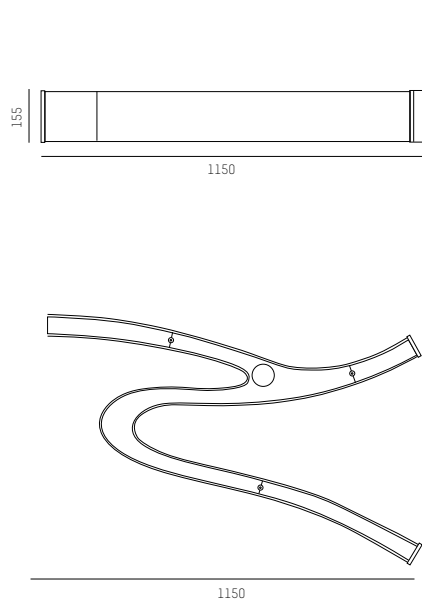

## LASH STL

SYS 50W | 230V | 3000K | 5100lm | CRI>80  
Push dimmbar

**660-50195d** weiß opal / dunkelchrom

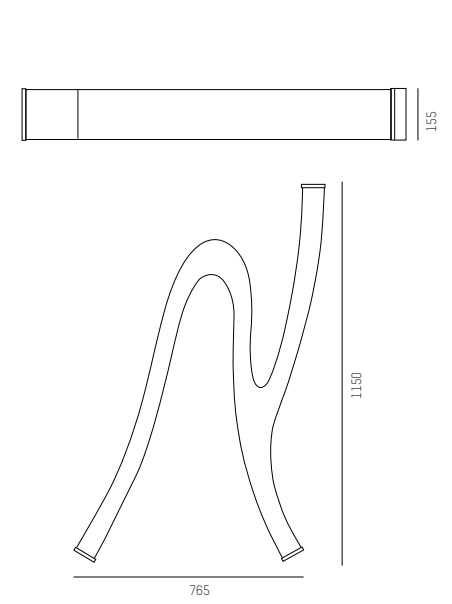





EGOLUCE

Design: Serge Cornelissen

# MEGAVIDE

Pendel- oder Deckenleuchten mit Struktur und modulare Elemente des Schirms aus weiß lackiertem Aluminium. Inkl. Konverter.

A++ - A  
IP20  



### MEGAVIDE HL S

SYS 22,5W | 230V | 3000K | 2895lm

68-153001ww weiß

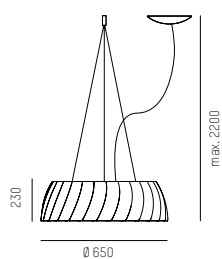

### MEGAVIDE HL M

SYS 33W | 230V | 3000K | 4246lm

68-153101ww weiß

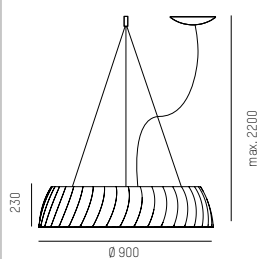

### MEGAVIDE HL L

SYS 45W | 230V | 3000K | 5790lm

68-153201ww weiß

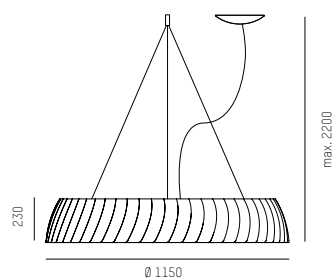

### MEGAVIDE DL S

SYS 22,5W | 230V | 3000K | 2895lm

68-553601ww weiß

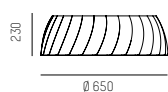

### MEGAVIDE DL M

SYS 33W | 230V | 3000K | 4246lm

68-553701ww weiß

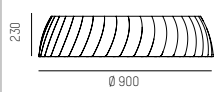





# GILBERT

Leuchtenfamilie besteht aus Hänge- oder Deckenleuchte aus weiß-satiniertem mundgeblasenem Glas und Abdeckung aus weiß lackiertem Metall.

A++ - A  
IP20  



### GILBERT HL 220

SYS 11W | 230V | 3000K  
996lm | CRI>80

140-l065010220101 weiß opal

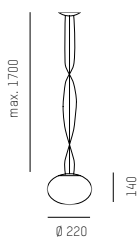

### GILBERT HL 370

SYS 27W | 230V | 3000K  
2762lm | CRI>80

140-l065010370101 weiß opal

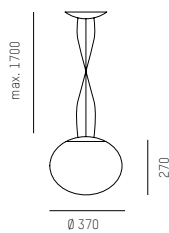

### GILBERT HL 450

SYS 27W | 230V | 3000K  
2762lm | CRI>80

140-l065010450101 weiß opal

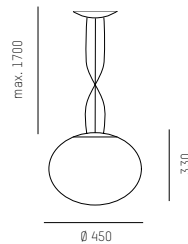

### GILBERT DL 370

SYS 27W | 230V | 3000K  
2762lm | CRI>80

140-p065010370101 weiß opal

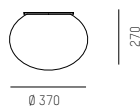

### GILBERT DL 450

SYS 27W | 230V | 3000K  
2762lm | CRI>80

140-p065010450101 weiß opal

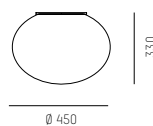



Design: Chiamonte & Marin

# NEOCHIC

Hängeleuchte aus mundgeblasenem, weiß  
satiertem Glas und weiß lackierter Struktur.  
Hängeleuchtenversion mit Dezentralisierung  
inkl. 3000mm Kabel.

A++ - E  
IP20  



### NEOCHIC SP P

1 x E27 | 230V | max. 77W

- 64-10133 opalweiß
- 64-10134 opalweiß/dezentral.

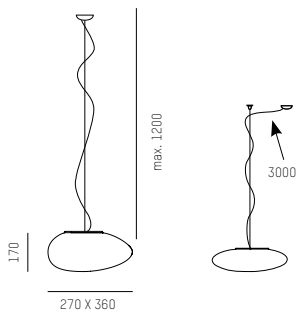

### NEOCHIC SP M

2 x E27 | 230V | max. 77W

- 64-10131 opalweiß
- 64-10132 opalweiß/dezentral.

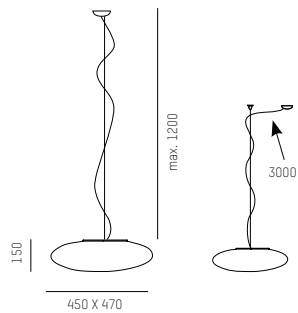

### NEOCHIC SP G

2 x E27 | 230V | max. 77W

- 64-10129 opalweiß
- 64-10130 opalweiß/dezentral.

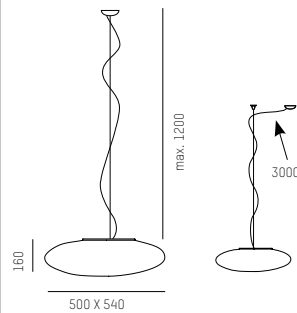

### NEOCHIC PP P

1 x E27 | 230V | max. 77W

- 64-20044 opalweiß

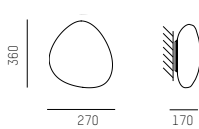

### NEOCHIC PP M

2 x E27 | 230V | max. 77W

- 64-20043 opalweiß

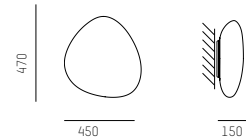

### NEOCHIC PP G

2 x E27 | 230V | max. 77W

- 64-20042 opalweiß

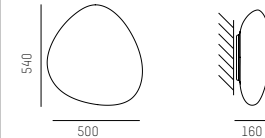

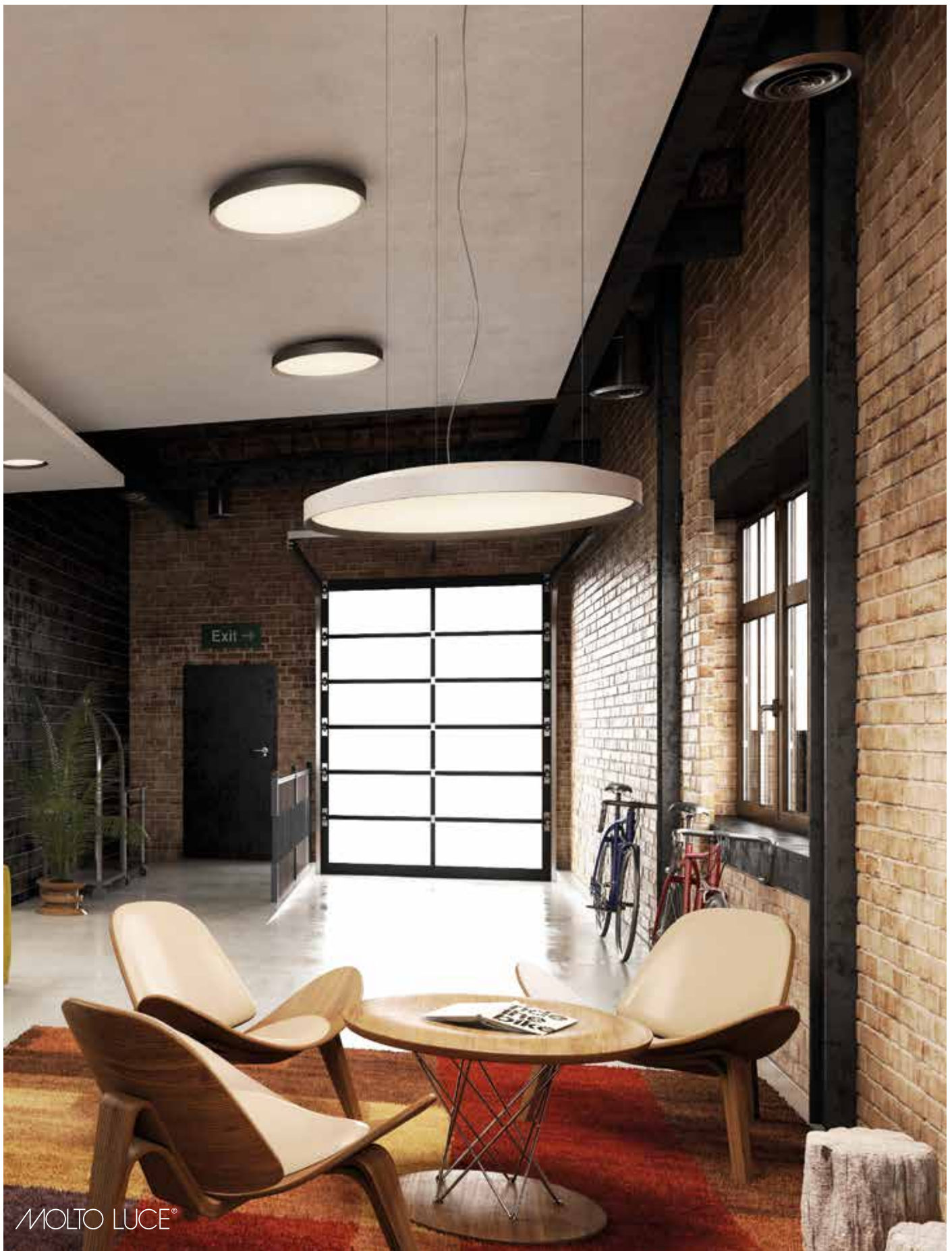



MOLTO LUCE®

Design: Serge Cornelissen

# RAGATO

Runde LED Hängeleuchte in 2 Größen, Schräg nach innen verlaufender Dekorring weiß oder schwarz, Abdeckung als zurückversetzter Opal-Diffusor

A++ - A  
IP20  



## RAGATO 600 HL

SYS 54W | 230V | 3000K | 4930lm | CRI>90

<b>603-3202955</b>	weiß / weiß
<b>603-3202956</b>	weiß / schwarz
<b>603-3202946</b>	silber matt / schwarz
<b>603-3202965</b>	schwarz / weiß
<b>603-3202966</b>	schwarz / schwarz

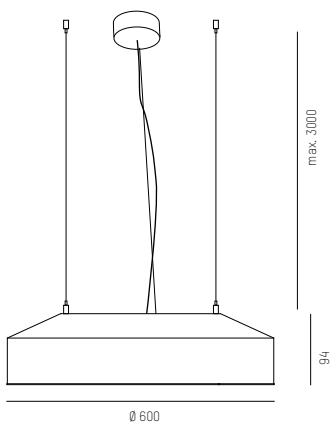

## RAGATO 900 HL

SYS 108W | 230V | 3000K | 10490lm | CRI>90

<b>603-3302955</b>	weiß / weiß
<b>603-3302956</b>	weiß / schwarz
<b>603-3302946</b>	silber matt / schwarz
<b>603-3302965</b>	schwarz / weiß
<b>603-3302966</b>	schwarz / schwarz

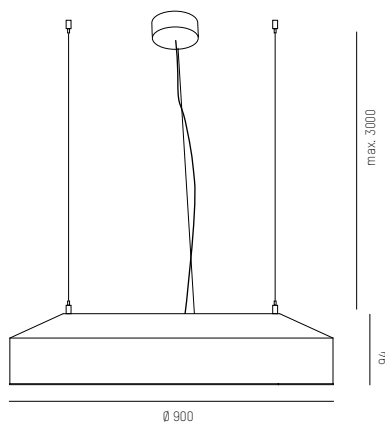

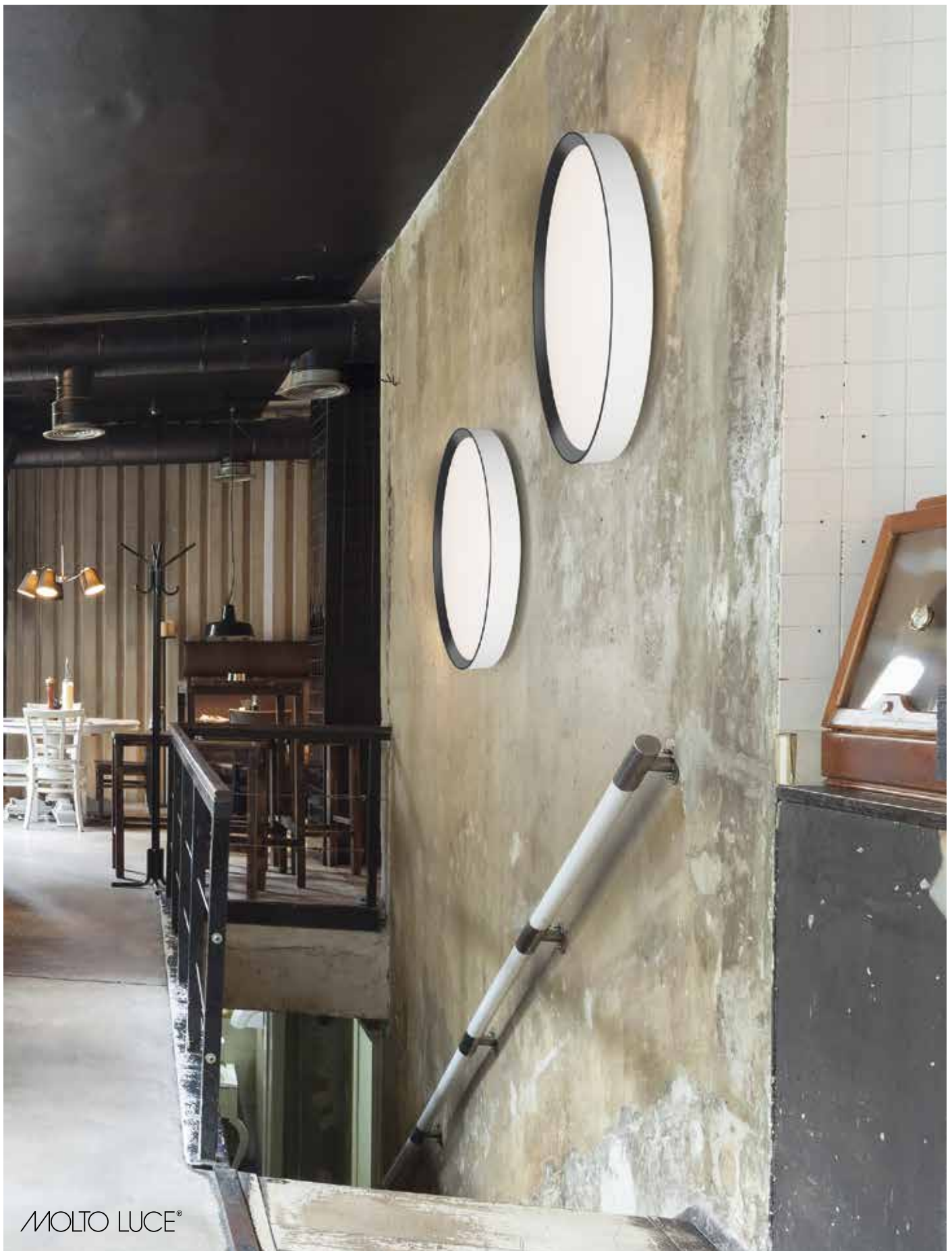

MOLTO LUCE®

Design: Serge Cornelissen

# RAGATO

Runde LED Wand-/ Deckenleuchte in 3 Größen,  
Schräg nach innen verlaufender Dekorring weiß  
oder schwarz, Abdeckung als zurückversetzter  
Opal-Diffusor

A++ - A  
IP20  



### RAGATO 350 WL/DL

SYS 15W | 230V | 3000K | 1370lm | CRI>90

603-1102955	weiß / weiß
603-1102956	weiß / schwarz
603-1102946	silber matt / schwarz
603-1102965	schwarz / weiß
603-1102966	schwarz / schwarz

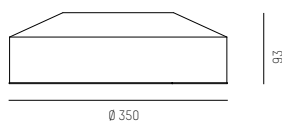

### RAGATO 600 WL/DL

SYS 54W | 230V | 3000K | 4930lm | CRI>90

603-1202955	weiß / weiß
603-1202956	weiß / schwarz
603-1202946	silber matt / schwarz
603-1202965	schwarz / weiß
603-1202966	schwarz / schwarz

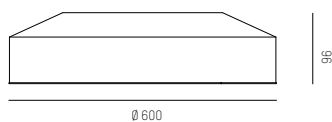

### RAGATO 900 WL/DL

SYS 108W | 230V | 3000K | 10490lm | CRI>90

603-1302955	weiß / weiß
603-1302956	weiß / schwarz
603-1302946	silber matt / schwarz
603-1302965	schwarz / weiß
603-1302966	schwarz / schwarz

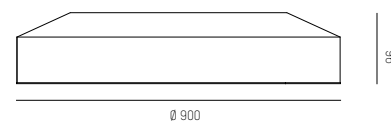





MOLTO LUCE®

Design: Serge Cornelissen

# RAGATO

Runde LED Einbauleuchte in 3 Größen,  
Schräg nach innen verlaufender Dekorring weiß  
oder schwarz, Abdeckung als zurückversetzter  
Opal-Diffusor

A++ → A  
IP20  



### RAGATO 350 EBL

SYS 15W | 230V | 3000K | 1370lm | CRI>90

603-2102955 weiß  
603-2102956 schwarz

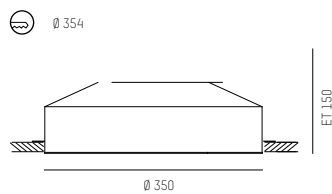

### RAGATO 600 EBL

SYS 54W | 230V | 3000K | 4930lm | CRI>90

603-2202955 weiß  
603-2202956 schwarz

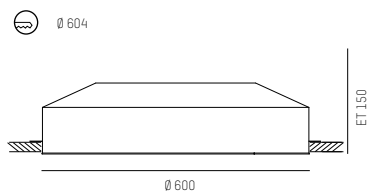

### RAGATO 600 EBL

SYS 108W | 230V | 3000K | 10490lm | CRI>90

603-2302955 weiß  
603-2302956 schwarz

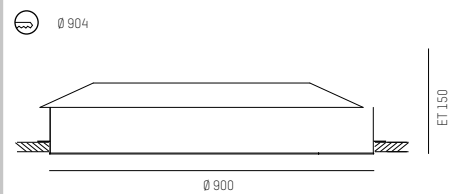



GUTES **DESIGN** HÄLT UNS FRISCH  
UND MUNTER.







selène®

# DOMINO

Hängeleuchten mit Schirm aus mundgeblasenem Glas mit Wabenmuster, in vier Modellen und drei Farbvarianten verfügbar.

A++ - E  
IP20  

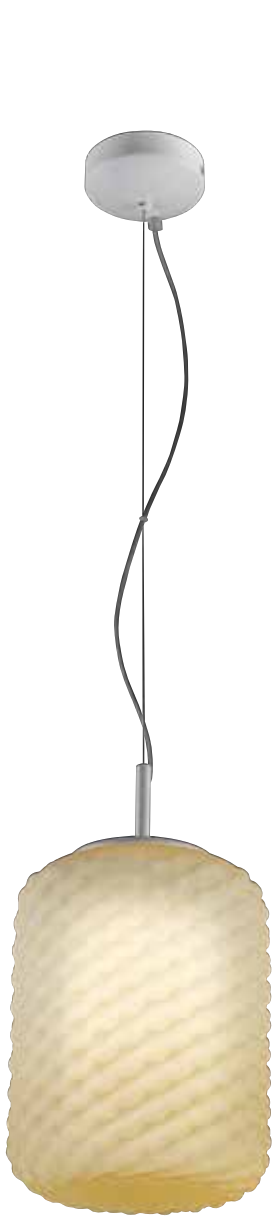

### DOMINO I M

1 x E27 | 230V | max. 77W

**383-2770011** weiß  
**383-2770024** amber  
**383-2770030** rauchgrau

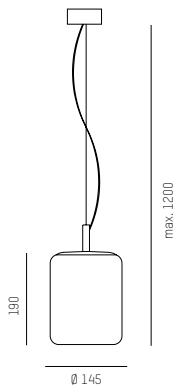

### DOMINO I G

1 x E27 | 230V | max. 77W

**383-2771011** weiß  
**383-2771024** amber  
**383-2771030** rauchgrau

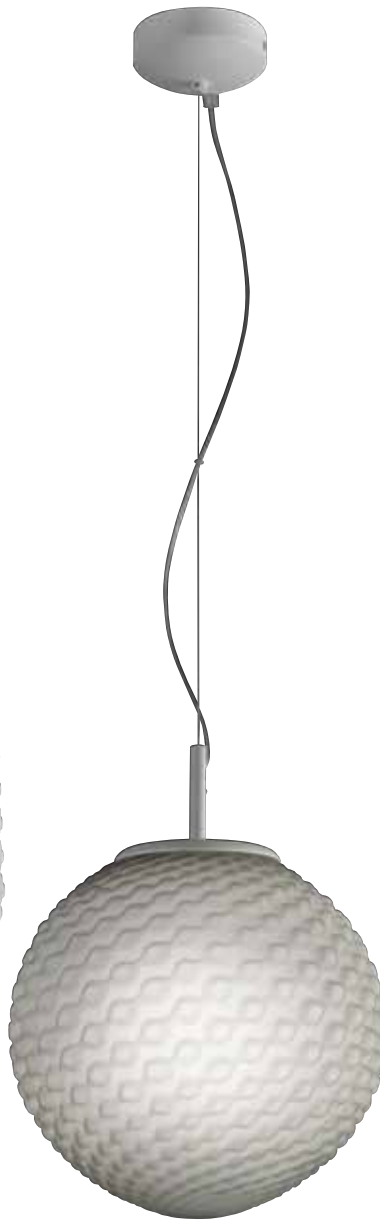
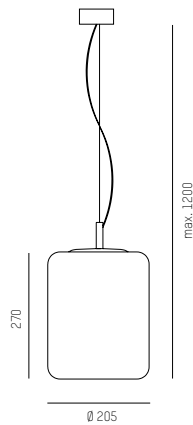

### DOMINO II

1 x E27 | 230V | max. 77W

**383-2772011** weiß  
**383-2772024** amber  
**383-2772030** rauchgrau

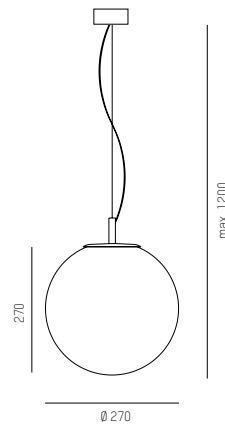

### DOMINO III M

3 x E27 | 230V | max. 77W

**383-27703011** weiß  
**383-27703024** amber  
**383-27703030** rauchgrau

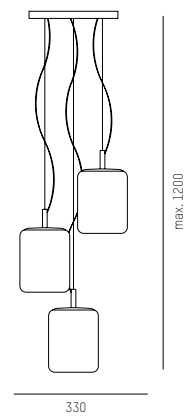



selène®

# DOMINO

Tischleuchten mit Schirm aus mundgeblasenem Glas mit Wabenmuster, in drei Farbvarianten verfügbar.

A++ - E  
IP20  

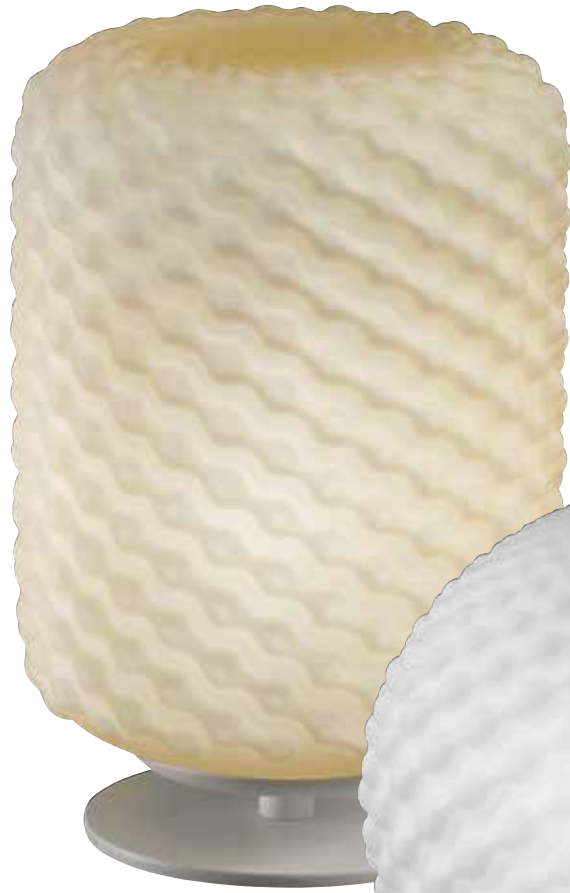

### DOMINO I M

1 x E27 | 230V | max. 42W

**383-2775011** weiß  
**383-2775024** amber  
**383-2775030** rauchgrau

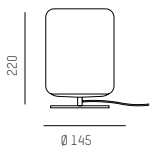

### DOMINO I G

1 x E27 | 230V | max. 42W

**383-2776011** weiß  
**383-2776024** amber  
**383-2776030** rauchgrau

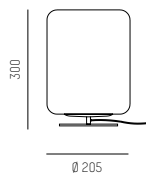

### DOMINO II

1 x E27 | 230V | max. 42W

**383-2777011** weiß  
**383-2777024** amber  
**383-2777030** rauchgrau

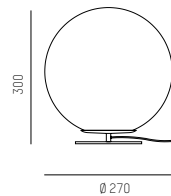





selène®

# ORIGAMI

Hängeleuchten mit Schirm aus mundgeblasenem Glas mit Struktur, in fünf Farbvarianten verfügbar.

A++ - E  
IP20  



## ORIGAMI

1 x E27 | 230V | max. 42W

- 383-2781011 weiß
- 383-2781013 blau
- 383-2781023 transparent
- 383-2781024 amber
- 383-2781063 braun

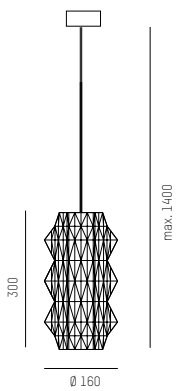



selène®

# ORIGAMI

Tischleuchten mit Schirm aus mund-  
geblasenem Glas mit Struktur,  
in fünf Farbvarianten verfügbar.

A++ - E  
IP20  



## ORIGAMI

1 x E27 | 230V | max. 42W

383-2782011	weiß
383-2782013	blau
383-2782023	transparent
383-2782024	amber
383-2782063	braun

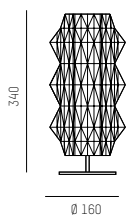



Design: Francesc Vilaro

# INVISIBLE

Hänge- und Deckenleuchten aus Metall  
schwarz lackiert und mattiertem  
PMMA Diffuser, inkl. LED Konverter

A++ - A

IP20  



### INVISIBLE HL

SYS 9W | 230V | 3000K  
765lm | CRI>80

105-0056930505 schwarz

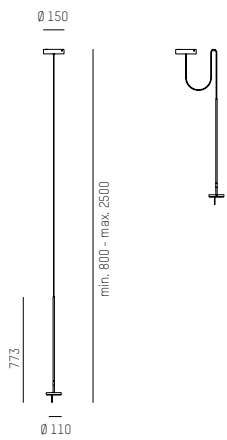

### INVISIBLE DL

SYS 9W | 230V | 3000K  
765lm | CRI>80

105-0056940505 schwarz

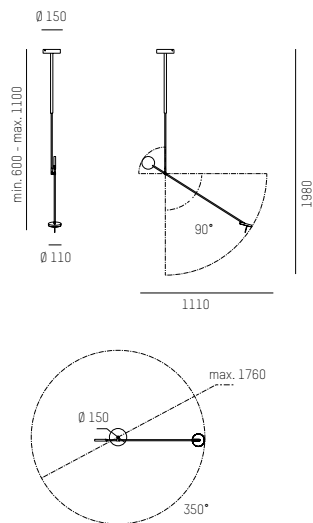

### INVISIBLE DL

3 x SYS 9W | 230V | 3000K  
3 x 765lm | CRI>80

105-0056960505 schwarz

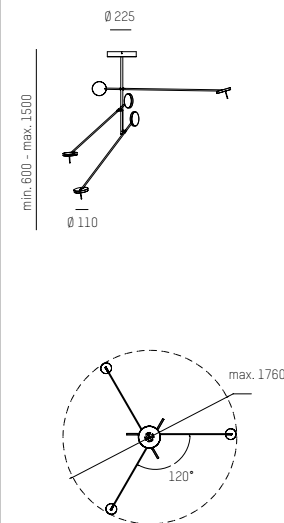



Design: Francesc Vilaro

# INVISIBLE

Wand,- Tisch- und Stehleuchten  
dreh- und schwenkbar aus Metall,  
mit mattiertem PMMA Diffuser

A++ - A  
IP20  

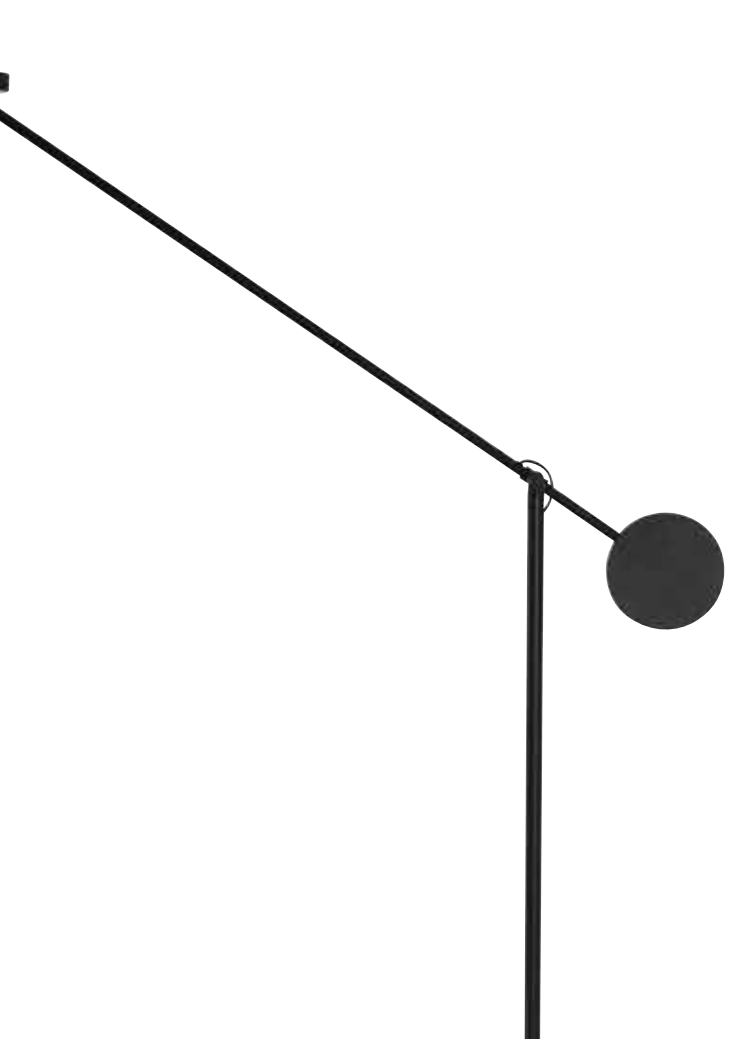

### INVISIBLE WL

SYS 9W | 230V | 3000K  
765lm | CRI>80

105-0556930505 schwarz

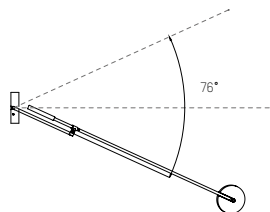
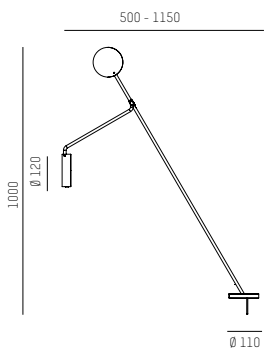

### INVISIBLE TL

SYS 9W | 230V | 3000K  
765lm | CRI>80

105-1056930505 schwarz

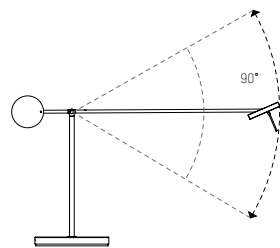
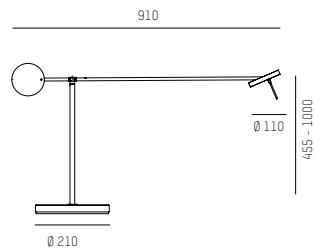

### INVISIBLE STL

SYS 9W | 230V | 3000K  
765lm | CRI>80

105-2556930505 schwarz

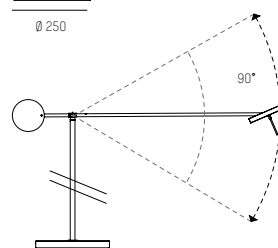
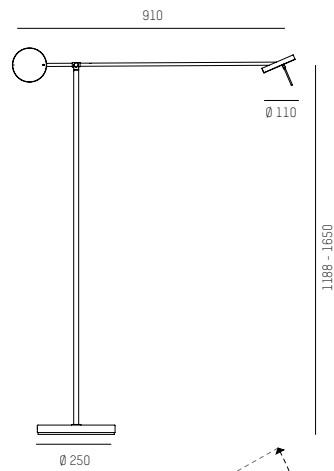







# IDEA

Steh- oder Hängeleuchte aus Metall in den Farben weiß oder schwarz, Messing lackiert, Altmessing matt, Altmessing gebürstet oder Altkupfer gebürstet. Stoffkabel schwarz.  
Bei Variante weiß: Stoffkabel weiß

A++ - E  
IP20  



Anwendungsbeispiel

### IDEA 10 SO

1 x E27 | 230V | max. 42W

264-so01444 Messing

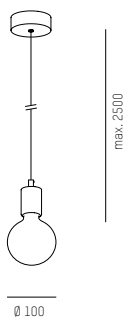

### IDEA 10 SO DEC

1 x E27 | 230V | max. 42W

264-so01445 Messing

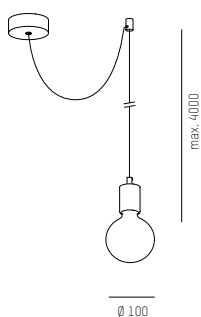

### IDEA 85 PH

1 x E27 | 230V | max. 42W

- 264-ph00143 weiß
- 264-ph00144 schwarz
- 264-ph00145 Messing
- 264-ph00146 Altmessing matt
- 264-ph00142 Altmessing gebürstet
- 264-ph00147 Altkupfer gebürstet

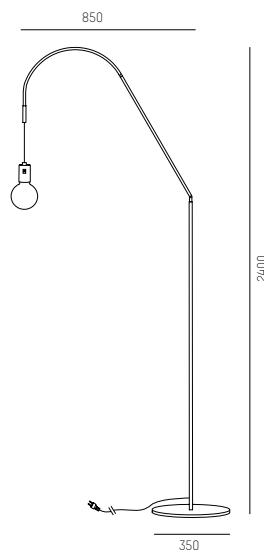

IDEA HL + DISCO LOOP  
(separat ordern)

### DISCO LOOP

Zubehör für IDEA HL mit magnetischer Fixierung

- 264-acc00542 Messing Ø 20cm
- 264-acc00544 Messing Ø 30cm







EGOLUCE

# PHANTOM

Pendel- sowie Deckenleuchten. Körper aus Aluminium, Seitenteile aus verchromtem Polycarbonat und Diffusor aus satiniertem Methacrylat.

A++ - A  
IP20  

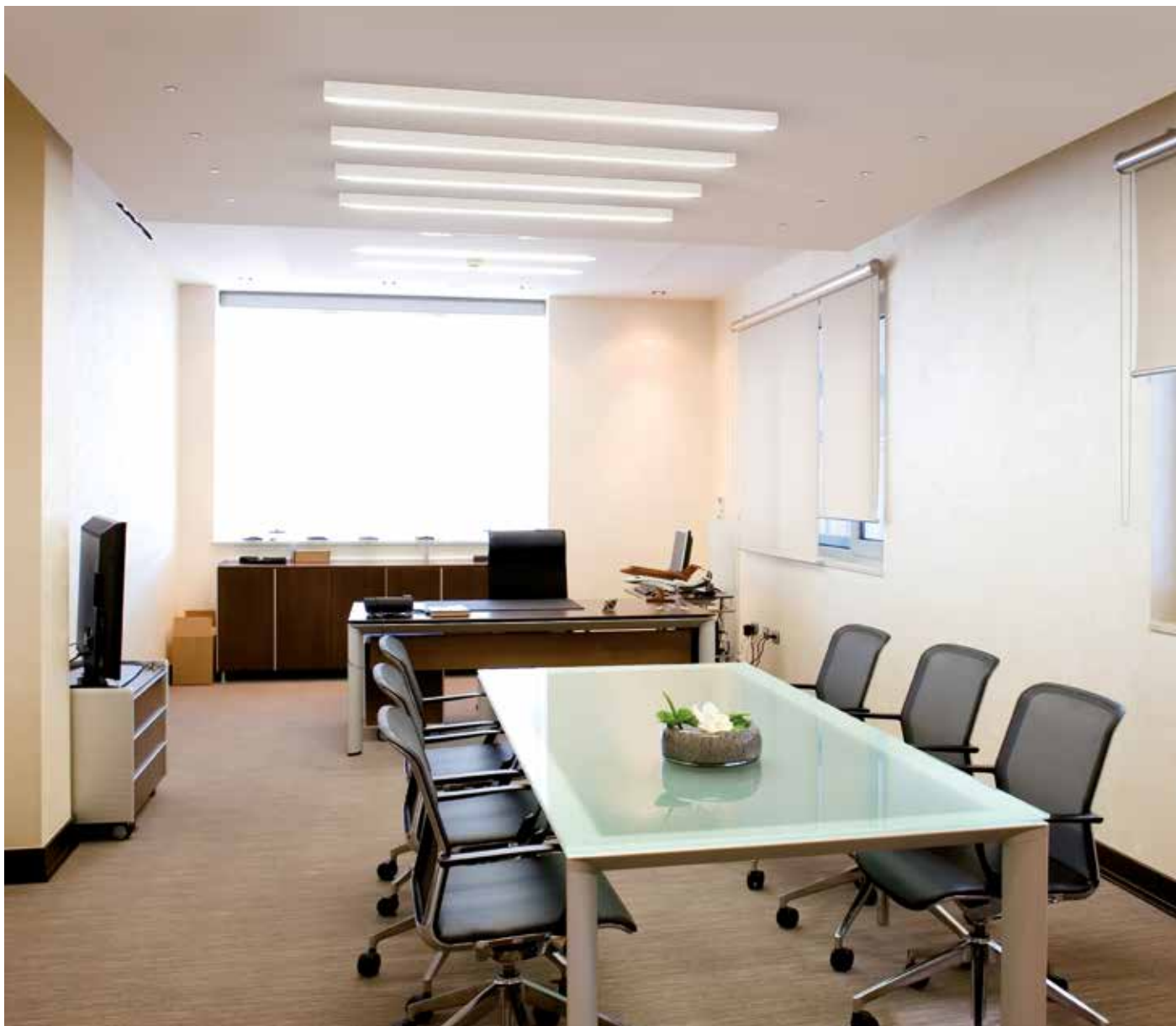

### PHANTOM HL S

SYS 18,7W | 230V | 3000K  
2250lm

68-152401ww weiß

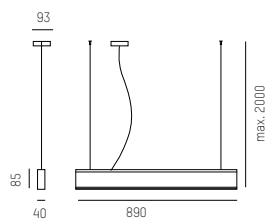

### PHANTOM HL M

SYS 25W | 230V | 3000K  
3000lm

68-152501ww weiß

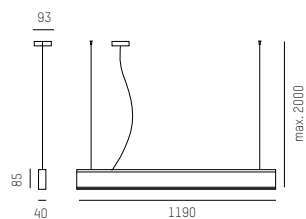

### PHANTOM DL S

SYS 18,7W | 230V | 3000K  
2250lm

68-523601ww weiß

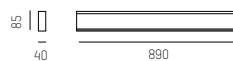

### PHANTOM DL M

SYS 25W | 230V | 3000K  
3000lm

68-523701ww weiß

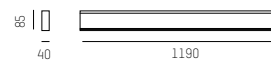



MOLTO LUCE®

Design: Serge & Robert Cornelissen

# CHUNNEL

LED Hänge- oder Deckenleuchte aus Aluminium mit Oberfläche schwarz oder weiß pulverbeschichtet, Direktabdeckung mit hochtransparenter Mikroprismenoptik, Abstrahlung Direkt- und Indirekt

A++ - A  
IP20  



### CHUNNEL 39 HL

SYS 39W | 230V | 3000K  
3700lm | CRI>80

- 569-104095ng1 weiß
- 569-104096ng1 schwarz
- 569-114096ng1 schwarz/weiß

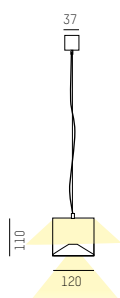
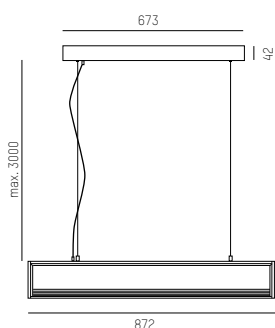

### CHUNNEL 65 HL

SYS 65W | 230V | 3000K  
6470lm | CRI>80

- 569-107095ng1 weiß
- 569-107096ng1 schwarz
- 569-117096ng1 schwarz/weiß

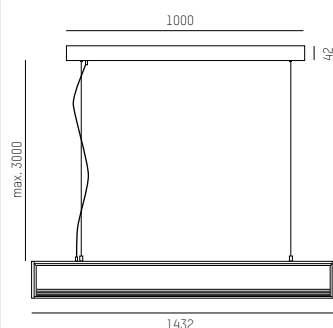

### CHUNNEL 39 DL

SYS 39W | 230V | 3000K  
3700lm | CRI>80

- 569-154095ng1 weiß
- 569-154096ng1 schwarz
- 569-164096ng1 schwarz/weiß

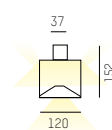
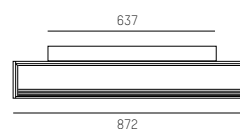

### CHUNNEL 65 DL

SYS 65W | 230V | 3000K  
6470lm | CRI>80

- 569-157095ng1 weiß
- 569-157096ng1 schwarz
- 569-167096ng1 schwarz/weiß

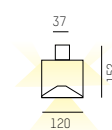
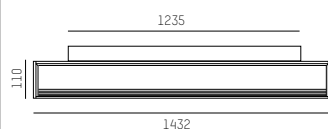



 PANZERI

# ONE

Hänge- oder Deckenleuchte aus Aluminium,  
Oberflächen in weiß oder Blattgold  
inkl. Konverter

A++ → A  
IP 40  



## ONE HL

SYS 15W | 230V | 3000K  
1097lm | CRI>80

**140-l037010000101** weiß  
**140-l037210000101** Blattgold

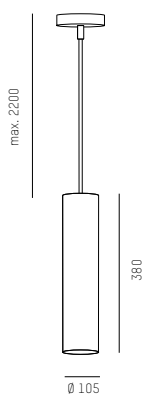

## ONE DL

SYS 15W | 230V | 3000K  
1097lm | CRI>80

**140-p037010000101** weiß  
**140-p037210000101** Blattgold

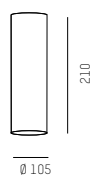





# DASH L

LED Hängeleuchte aus Aluminiumdruckguss mit Oberfläche schwarz oder weiß pulverbeschichtet, vakuumbedampfter Reflektor in 2 Ausstrahlwinkeln, verschiedene Farbvarianten mit Dekoring und Kabel

A++ - A  
IP20  

## DASH L DC HL

SYS 6W | 230V | 2700K | 590lm | PREMIUM CRI 90

### REFLEKTOR 20°

	1	2	3
599-86423666ng6	schwarz	schwarz	schwarz
599-86423633ng6	schwarz	gold	gold
599-86423636ng6	schwarz	gold	schwarz
599-86423555ng6	weiß	weiß	weiß
599-86423535ng6	weiß	gold	weiß
599-86423565ng6	weiß	schwarz	weiß

### REFLEKTOR 35°

	1	2	3
599-86453666ng6	schwarz	schwarz	schwarz
599-86453633ng6	schwarz	gold	gold
599-86453636ng6	schwarz	gold	schwarz
599-86453555ng6	weiß	weiß	weiß
599-86453535ng6	weiß	gold	weiß
599-86453565ng6	weiß	schwarz	weiß

SYS 6W | 230V | 3000K | 610lm | PREMIUM CRI 90

### REFLEKTOR 20°

	1	2	3
599-86429666ng6	schwarz	schwarz	schwarz
599-86429633ng6	schwarz	gold	gold
599-86429636ng6	schwarz	gold	schwarz
599-86429555ng6	weiß	weiß	weiß
599-86429535ng6	weiß	gold	weiß
599-86429565ng6	weiß	schwarz	weiß

### REFLEKTOR 35°

	1	2	3
599-86459666ng6	schwarz	schwarz	schwarz
599-86459633ng6	schwarz	gold	gold
599-86459636ng6	schwarz	gold	schwarz
599-86459555ng6	weiß	weiß	weiß
599-86459535ng6	weiß	gold	weiß
599-86459565ng6	weiß	schwarz	weiß

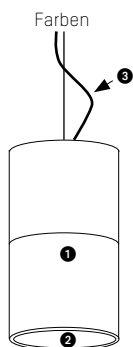

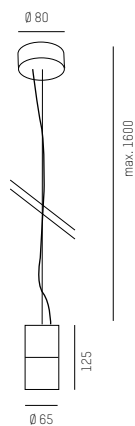

- 1 = Farbe aussen
- 2 = Farbe innen
- 3 = Gewebekabel

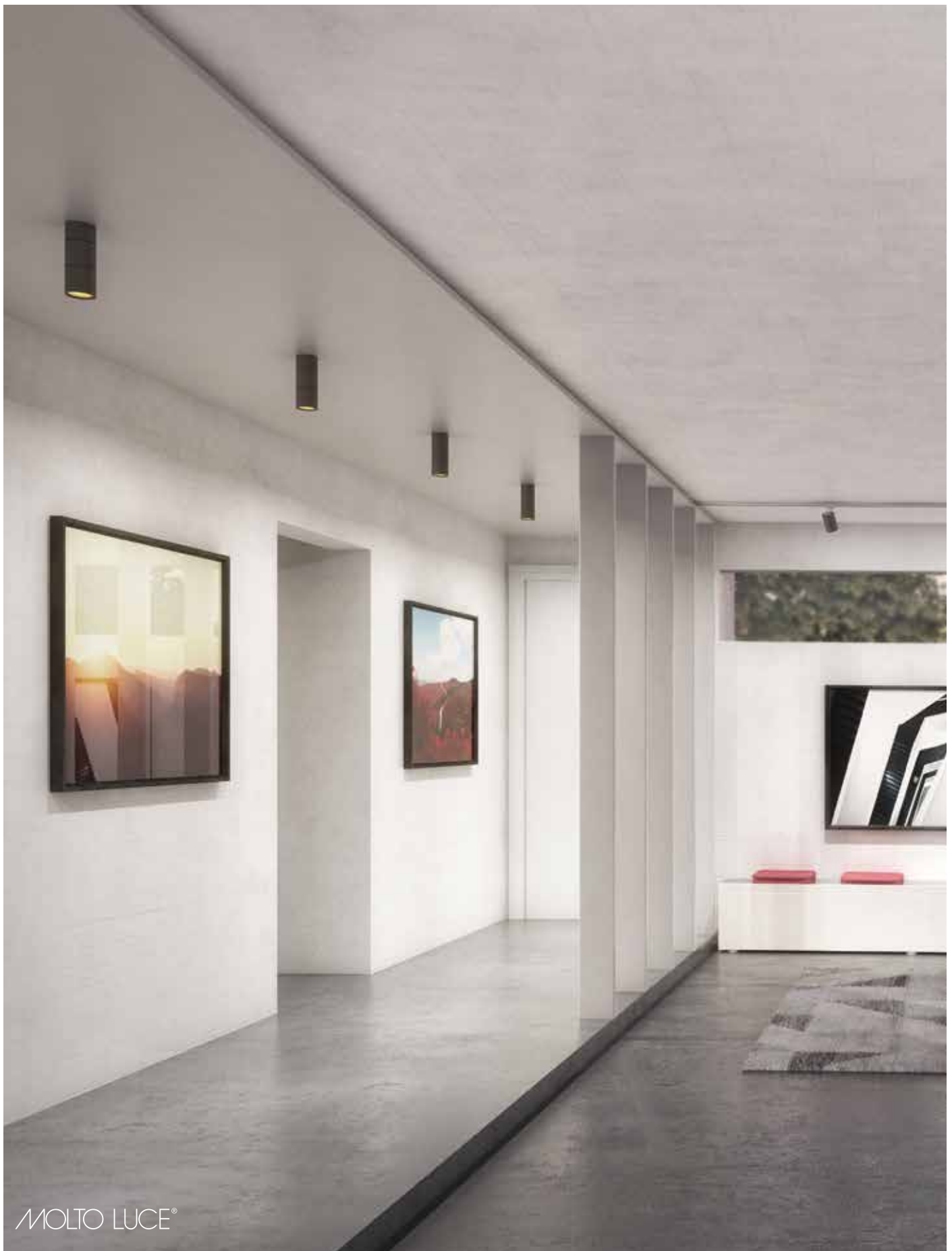



# DASH L

LED Deckenleuchte aus Aluminiumdruckguss mit Oberfläche schwarz oder weiß pulverbeschichtet, vakuumbedampfter Reflektor in 2 Ausstrahlwinkeln, verschiedene Farbvarianten mit Dekorring und Kabel

A++ - A  
IP20  

## DASH L DC DL

SYS 6W | 230V | 2700K | 590lm | PREMIUM CRI 90

### REFLEKTOR 20°

	1	2	3
599-76423666ng6	schwarz	schwarz	schwarz
599-76423633ng6	schwarz	gold	gold
599-76423636ng6	schwarz	gold	schwarz
599-76423555ng6	weiß	weiß	weiß
599-76423535ng6	weiß	gold	weiß
599-76423565ng6	weiß	schwarz	weiß

### REFLEKTOR 35°

	1	2	3
599-76453666ng6	schwarz	schwarz	schwarz
599-76453633ng6	schwarz	gold	gold
599-76453636ng6	schwarz	gold	schwarz
599-76453555ng6	weiß	weiß	weiß
599-76453535ng6	weiß	gold	weiß
599-76453565ng6	weiß	schwarz	weiß

SYS 6W | 230V | 3000K | 610lm | PREMIUM CRI 90

### REFLEKTOR 20°

	1	2	3
599-76429666ng6	schwarz	schwarz	schwarz
599-76429633ng6	schwarz	gold	gold
599-76429636ng6	schwarz	gold	schwarz
599-76429555ng6	weiß	weiß	weiß
599-76429535ng6	weiß	gold	weiß
599-76429565ng6	weiß	schwarz	weiß

### REFLEKTOR 38°

	1	2	3
599-76459666ng6	schwarz	schwarz	schwarz
599-76459633ng6	schwarz	gold	gold
599-76459636ng6	schwarz	gold	schwarz
599-76459555ng6	weiß	weiß	weiß
599-76459535ng6	weiß	gold	weiß
599-76459565ng6	weiß	schwarz	weiß

Farben

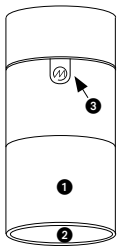

- 1 = Farbe aussen
- 2 = Farbe innen
- 3 = Clip

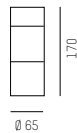

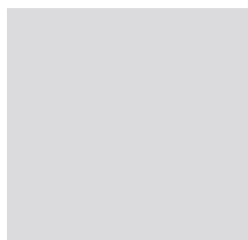

GUTES **DESIGN** BRINGT UNSERE  
PERSÖNLICHKEIT ZUM AUSDRUCK.



[www.lust-auf-schmuck.at](http://www.lust-auf-schmuck.at)

Foto: Schmuckwerkstatt Emmerstorfer, Wels



# BROOKLYN ROUND







 PANZERI

Design: Enzo Panzeri

# BROOKLYN ROUND

Pendelleuchten aus stranggepresstem und gebogenem Aluminium, Oberfläche weiß lackiert, inkl. DALI/Push dimmbarem LED Konverter.

A<sup>++</sup> → A  
IP20  



### BROOKLYN ROUND 100

SYS 56W | 230V | 3000K  
2130lm | CRI>80

140-l231013600102 weiß

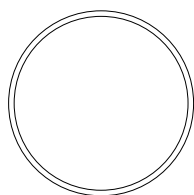
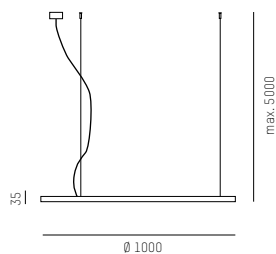

### BROOKLYN ROUND 100

SYS 29W | 230V | 3000K  
1065lm | CRI>80

140-l231011800102 weiß

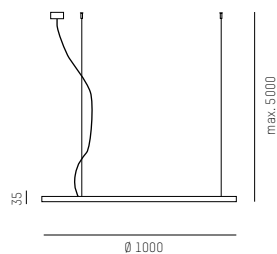

### BROOKLYN ROUND 195

SYS 109W | 230V | 3000K  
4260lm | CRI>80

140-l232013600102 weiß

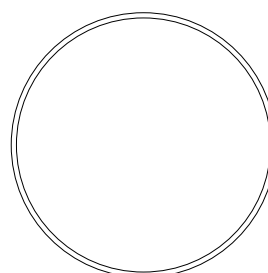
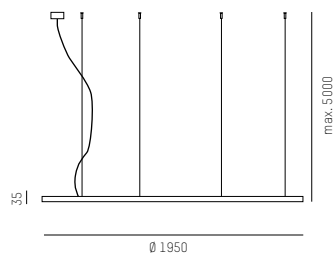

### BROOKLYN ROUND 195

SYS 56W | 230V | 3000K  
2130lm | CRI>80

140-l232011800102 weiß

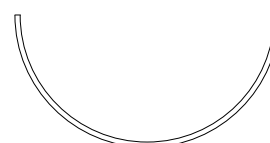
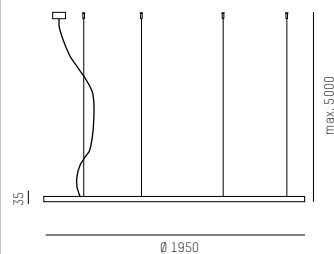

# GOLDEN RING





PANZERI

Design: Enzo Panzeri

# GOLDEN RING

Pendelleuchte aus Aluminium, in den Farben weiß, schwarz oder blattvergoldet erhältlich, direkt- / indirekt strahlend, Standardmäßig ist die Leuchte mit Baldachin und Seile mit Deckenbefestigungen ausgestattet, optional kann ein Baldachin für die direkte Aufnahme der Seile geordert werden



A++ - A

IP20  



## GOLDEN RING HL 800

SYS 48W | 230V | 3000K  
3421lm | CRI>80  
direkt strahlend

140-l081010800108 weiß  
140-l081020800108 schwarz  
140-l081210800108 Blattgold

SYS 96W | 230V | 3000K  
2 x 3421lm | CRI>80  
direkt- / indirekt strahlend  
dali/push dimm

140-l081010800102 weiß  
140-l081020800102 schwarz  
140-l081210800102 Blattgold

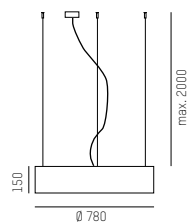

## GOLDEN RING HL 1200

SYS 160W | 230V | 3000K  
2 x 5865lm | CRI>80  
direkt- / indirekt strahlend  
dali/push dimm

140-l081011200102 weiß  
140-l081021200102 schwarz  
140-l081211200102 Blattgold

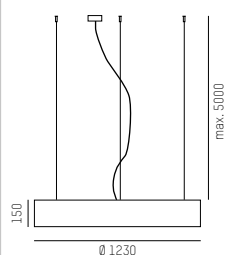

## DECKENBALDACHIN

zur direkten Montage von 3 Seilen in den Baldachin,  
für die Modelle 800, 1200 & 1800  
(separat ordern)

140-m81013 weiß  
140-m81023 schwarz  
140-m81213 Blattgold



## GOLDEN RING HL 1800

SYS 238W | 230V | 3000K  
2 x 8798lm | CRI>80  
direkt- / indirekt strahlend  
dali/push dimm

140-l081011800102 weiß  
140-l081021800102 schwarz  
140-l081211800102 Blattgold

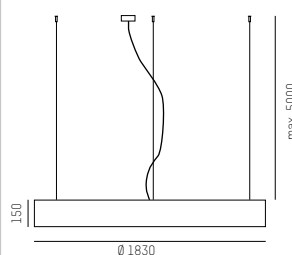

## GOLDEN RING HL 3000

SYS 398W | 230V | 3000K  
2 x 14663lm | CRI>80  
direkt- / indirekt strahlend  
dali/push dimm

140-l081013000102 weiß  
140-l081023000102 schwarz  
140-l081213000102 Blattgold

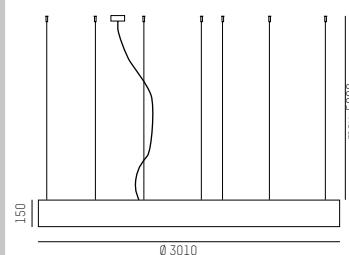

## DECKENBALDACHIN

zur direkten Montage von 6 Seilen in den Baldachin,  
für Modell 3000  
(separat ordern)

140-m81016 weiß  
140-m81026 schwarz  
140-m81216 Blattgold

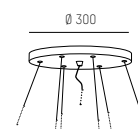



**PANZERI**

Design: Enzo Panzeri

# SILVER RING

Pendelleuchte aus Aluminium, in den Farben weiß, schwarz oder blattvergoldet erhältlich, direkt strahlend

A++ - A  
IP20  



## SILVER RING HL 800

SYS 48W | 230V | 3000K  
3421lm | CRI>80  
dali/push dimm

140-1082010800102 weiß  
140-1082020800102 schwarz  
140-1082210800102 Blattgold

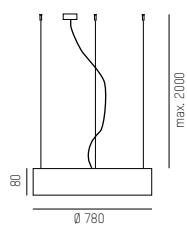

## SILVER RING HL 1200

SYS 81W | 230V | 3000K  
5865lm | CRI>80  
dali/push dimm

140-1082011200102 weiß  
140-1082021200102 schwarz  
140-1082211200102 Blattgold

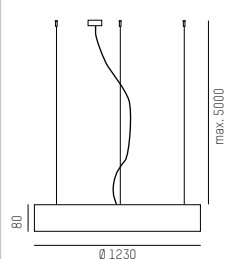

## SILVER RING HL 1800

SYS 120W | 230V | 3000K  
8798lm | CRI>80  
dali/push dimm

140-1082011800102 weiß  
140-1082021800102 schwarz  
140-1082211800102 Blattgold

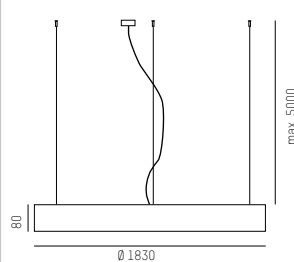





Design: Enzo Panzeri

# SILVER RING

Wand- / Deckenleuchte aus Aluminium, in den  
Farben weiß, schwarz oder blattvergoldet  
erhältlich, direkt strahlend

A++ - A  
IP20  



## SILVER RING WL 800

SYS 48W | 230V | 3000K  
3421lm | CRI>80  
dali/push dimm

140-p082010800102 weiß  
140-p082020800102 schwarz  
140-p082210800102 Blattgold

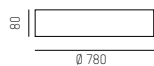

## SILVER RING WL 1200

SYS 81W | 230V | 3000K  
5865lm | CRI>80  
dali/push dimm

140-p082011200102 weiß  
140-p082021200102 schwarz  
140-p082211200102 Blattgold

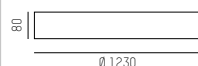

## SILVER RING WL 1800

SYS 120W | 230V | 3000K  
8798lm | CRI>80  
dali/push dimm

140-p082011800102 weiß  
140-p082021800102 schwarz  
140-p082211800102 Blattgold

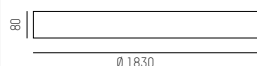

**OLIVIA  
EMMA  
CLIO**





PANZERI

Design: Silvia Poma

# CLIO

Pendelleuchten aus mundgeblasenem Glas mit Rippenausführung im Retro-Stil. Der Baldachin aus Metall ist in schwarz oder in glänzendem Kupfer lackiert erhältlich. Stoffkabel schwarz. Optional ist ein Baldachin erhältlich mit 8 Ausgängen (+1 in der Mitte), für die Komposition mehrerer Leuchten.

A++ - E  
IP20 



## CLIO EINZELHÄNGELEUCHE

### BALDACHIN SCHWARZ

inkl. 1 x LED RETROFIT | E27  
230V | 8W | 2700K | 1050lm  
nicht dimmbar

140-l094520000200	klar
140-l094550000200	bronze
140-l094540000200	amber
140-l094530000200	stahlgrau
140-l094560000200	tabak
140-l094570000200	grün

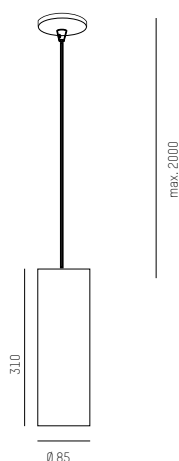

## CLIO EINZELHÄNGELEUCHE

### BALDACHIN KUPFER

inkl. 1 x LED RETROFIT | E27  
230V | 8W | 2700K | 1050lm  
nicht dimmbar

140-l094620000200	klar
140-l094650000200	bronze
140-l094640000200	amber
140-l094630000200	stahlgrau
140-l094660000200	tabak
140-l094670000200	grün

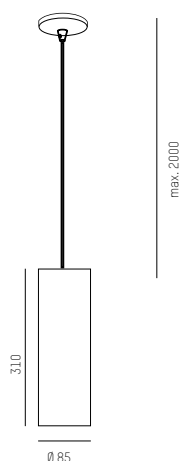

## CLIO FÜR KOMPOSITIONEN

### FÜR MEHRFACHBALDACHIN SCHWARZ (separat ordern)

inkl. 1 x LED RETROFIT | E27  
230V | 8W | 2700K | 1050lm  
nicht dimmbar

140-m094520000200	klar
140-m094550000200	bronze
140-m094540000200	amber
140-m094530000200	stahlgrau
140-m094560000200	tabak
140-m094570000200	grün

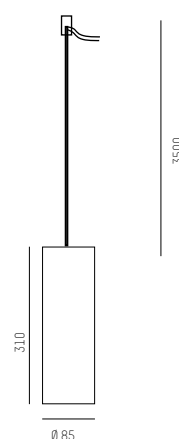

## CLIO FÜR KOMPOSITIONEN

### FÜR MEHRFACHBALDACHIN KUPFER (separat ordern)

inkl. 1 x LED RETROFIT | E27  
230V | 8W | 2700K | 1050lm  
nicht dimmbar

140-m094620000200	klar
140-m094650000200	bronze
140-m094640000200	amber
140-m094630000200	stahlgrau
140-m094660000200	tabak
140-m094670000200	grün

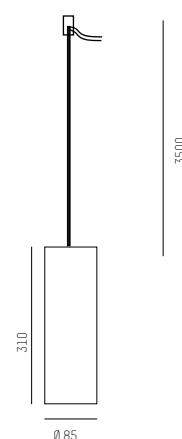

## BALDACHIN FÜR MEHRFACHKOMPOSITIONEN

MIT 8 AUSGÄNGEN SEITLICH + 1 AUSGANG IM ZENTRUM DES BALDACHINS  
FÜR BIS ZU 9 LEUCHTEN

140-m919402	schwarz
140-m919425	kupfer

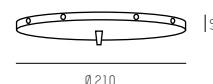

(Anwendungsbeispiele siehe Seite: 154-155)





PANZERI

Design: Silvia Poma

# EMMA

Pendelleuchten aus mundgeblasenem Glas mit Rippenausführung im Retro-Stil. Der Baldachin aus Metall ist in schwarz oder in glänzendem Kupfer lackiert erhältlich. Stoffkabel schwarz. Optional ist ein Baldachin erhältlich mit 8 Ausgängen (+1 in der Mitte), für die Komposition mehrerer Leuchten.

A++ - E  
IP20  



## EMMA EINZELHÄNGELEUCHE

### BALDACHIN SCHWARZ

inkl. 1 x LED RETROFIT | E27  
230V | 8W | 2700K | 1050lm  
nicht dimmbar

- 140-1091520000200 klar
- 140-1091550000200 bronze
- 140-1091540000200 amber
- 140-1091530000200 stahlgrau
- 140-1091560000200 tabak
- 140-1091570000200 grün

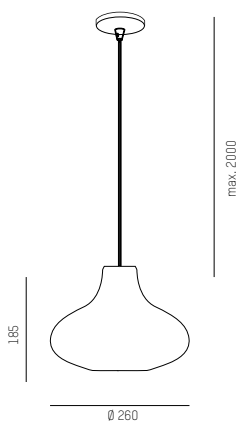

## EMMA EINZELHÄNGELEUCHE

### BALDACHIN KUPFER

inkl. 1 x LED RETROFIT | E27  
230V | 8W | 2700K | 1050lm  
nicht dimmbar

- 140-1091620000200 klar
- 140-1091650000200 bronze
- 140-1091640000200 amber
- 140-1091630000200 stahlgrau
- 140-1091660000200 tabak
- 140-1091670000200 grün

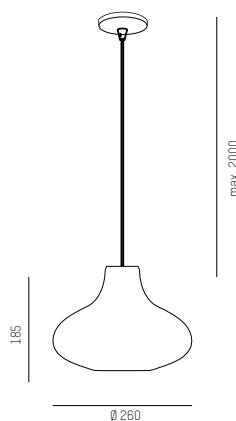

## EMMA FÜR KOMPOSITIONEN

### FÜR MEHRFACHBALDACHIN SCHWARZ (separat ordern)

inkl. 1 x LED RETROFIT | E27  
230V | 8W | 2700K | 1050lm  
nicht dimmbar

- 140-m091520000200 klar
- 140-m091550000200 bronze
- 140-m091540000200 amber
- 140-m091530000200 stahlgrau
- 140-m091560000200 tabak
- 140-m091570000200 grün

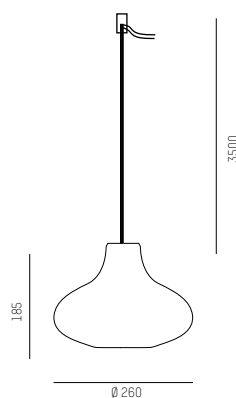

## EMMA FÜR KOMPOSITIONEN

### FÜR MEHRFACHBALDACHIN KUPFER (separat ordern)

inkl. 1 x LED RETROFIT | E27  
230V | 8W | 2700K | 1050lm  
nicht dimmbar

- 140-m091620000200 klar
- 140-m091650000200 bronze
- 140-m091640000200 amber
- 140-m091630000200 stahlgrau
- 140-m091660000200 tabak
- 140-m091670000200 grün

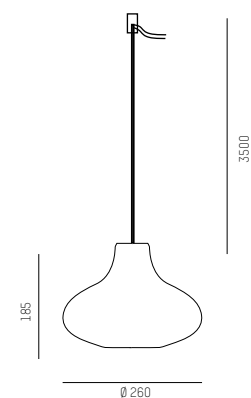

## BALDACHIN FÜR MEHRFACHKOMPOSITIONEN

MIT 8 AUSGÄNGEN SEITLICH + 1 AUSGANG IM ZENTRUM DES BALDACHINS  
FÜR BIS ZU 9 LEUCHTEN

- 140-m919402 schwarz
- 140-m919425 kupfer

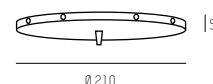

(Anwendungsbeispiele siehe Seite: 154-155)







PANZERI

Design: Silvia Poma

# OLIVIA

Pendelleuchten aus mundgeblasenem Glas mit Rippenausführung im Retro-Stil. Der Baldachin aus Metall ist in schwarz oder in glänzendem Kupfer lackiert erhältlich. Stoffkabel schwarz. Optional ist ein Baldachin erhältlich mit 8 Ausgängen (+1 in der Mitte), für die Komposition mehrerer Leuchten.

A++ - E  
IP20  



## OLIVIA EINZELHÄNGELEUCHTE

### BALDACHIN SCHWARZ

inkl. 1 x LED RETROFIT | E27  
230V | 8W | 2700K | 1050lm  
nicht dimmbar

- 140-l097520000200 klar
- 140-l097550000200 bronze
- 140-l097540000200 amber
- 140-l097530000200 stahlgrau
- 140-l097560000200 tabak
- 140-l097570000200 grün

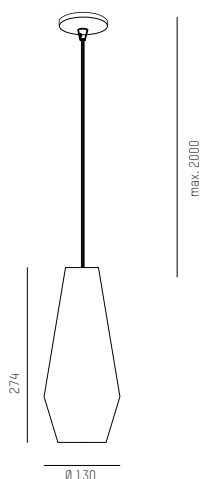

## OLIVIA EINZELHÄNGELEUCHTE

### BALDACHIN KUPFER

inkl. 1 x LED RETROFIT | E27  
230V | 8W | 2700K | 1050lm  
nicht dimmbar

- 140-l097620000200 klar
- 140-l097650000200 bronze
- 140-l097640000200 amber
- 140-l097630000200 stahlgrau
- 140-l097660000200 tabak
- 140-l097670000200 grün

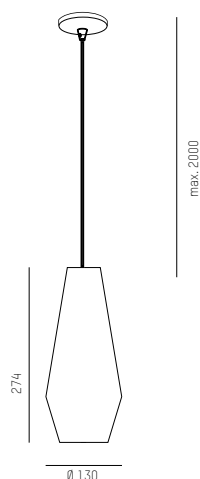

## OLIVIA FÜR KOMPOSITIONEN

### FÜR MEHRFACHBALDACHIN SCHWARZ (separat ordern)

inkl. 1 x LED RETROFIT | E27  
230V | 8W | 2700K | 1050lm  
nicht dimmbar

- 140-m097520000200 klar
- 140-m097550000200 bronze
- 140-m097540000200 amber
- 140-m097530000200 stahlgrau
- 140-m097560000200 tabak
- 140-m097570000200 grün

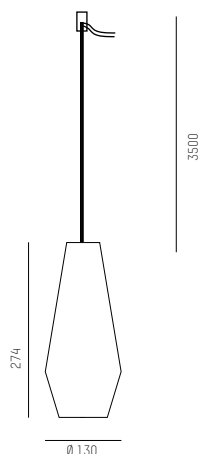

## OLIVIA FÜR KOMPOSITIONEN

### FÜR MEHRFACHBALDACHIN KUPFER (separat ordern)

inkl. 1 x LED RETROFIT | E27  
230V | 8W | 2700K | 1050lm  
nicht dimmbar

- 140-m097620000200 klar
- 140-m097650000200 bronze
- 140-m097640000200 amber
- 140-m097630000200 stahlgrau
- 140-m097660000200 tabak
- 140-m097670000200 grün

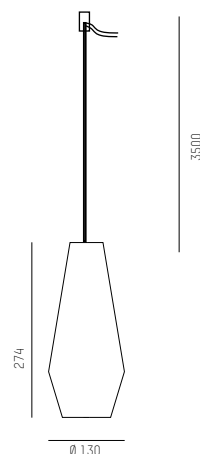

## BALDACHIN FÜR MEHRFACHKOMPOSITIONEN

MIT 8 AUSGÄNGEN SEITLICH + 1 AUSGANG IM ZENTRUM DES BALDACHINS  
FÜR BIS ZU 9 LEUCHTEN

- 140-m919402 schwarz
- 140-m919425 kupfer

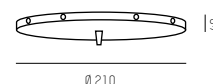

(Anwendungsbeispiele siehe Seite: 154-155)

# OLIVIA, EMMA & CLIO

Ausgestattet mit einem innovativem Mehrfach-Einhängesystem für die Beleuchtungskörper, wodurch vielfache Zusammenstellungen möglich sind

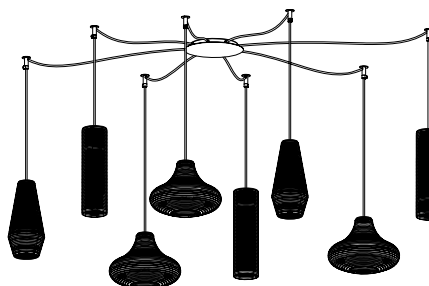
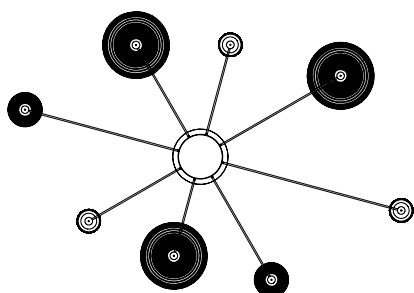
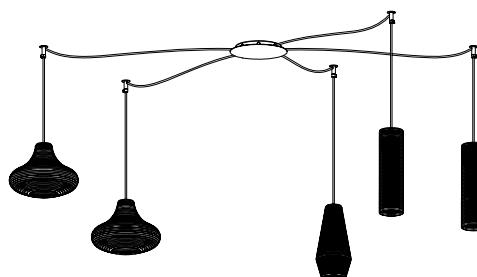
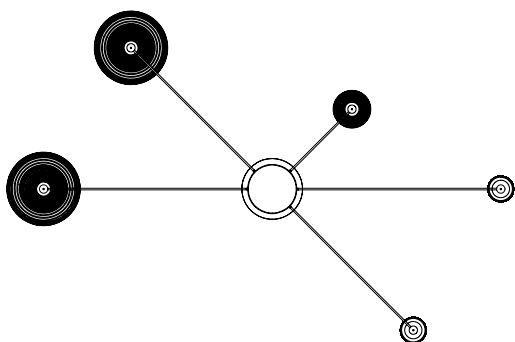
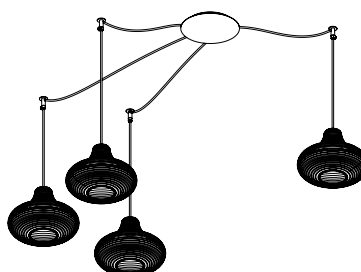
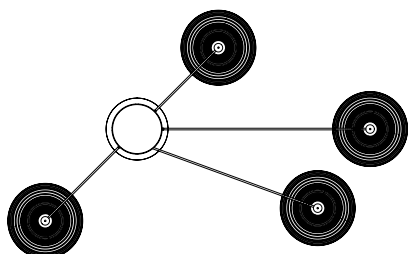

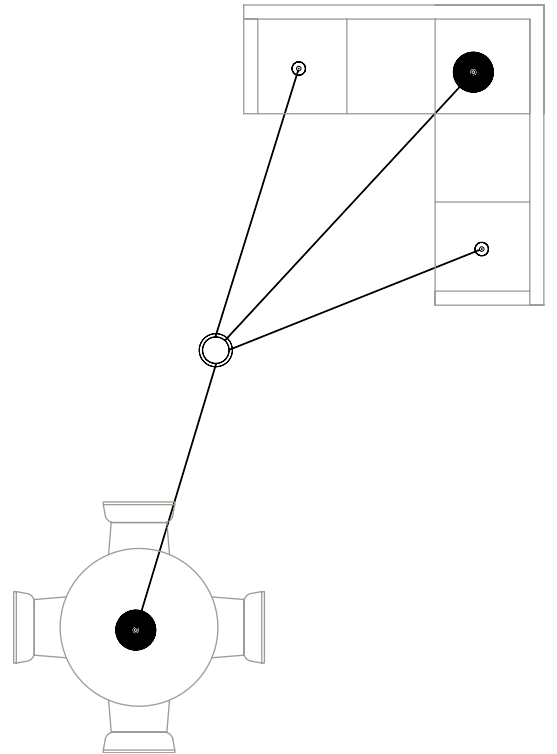
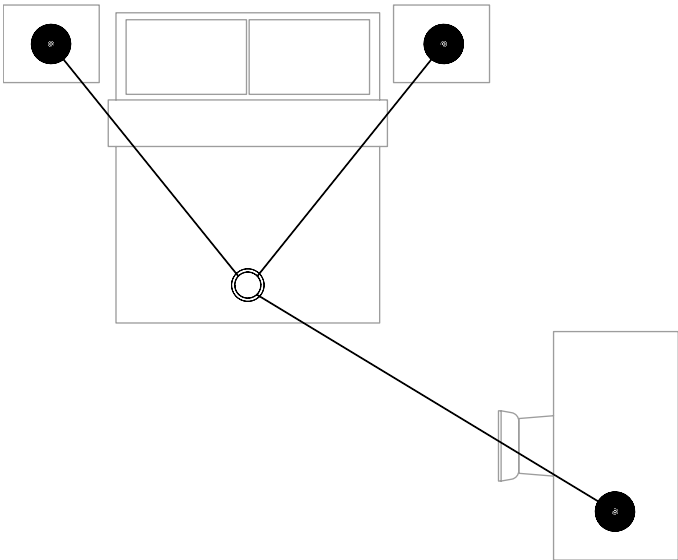
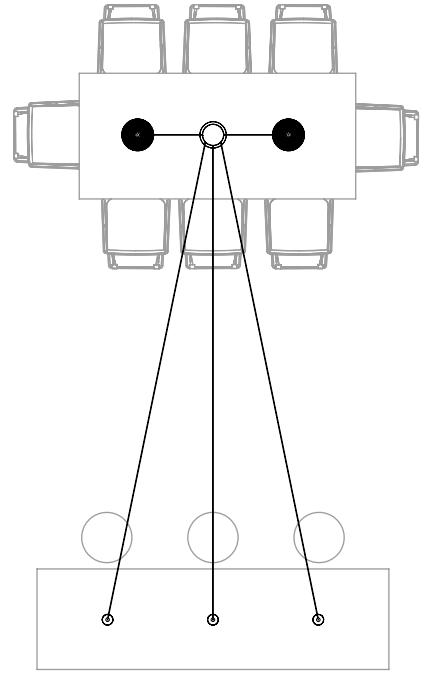
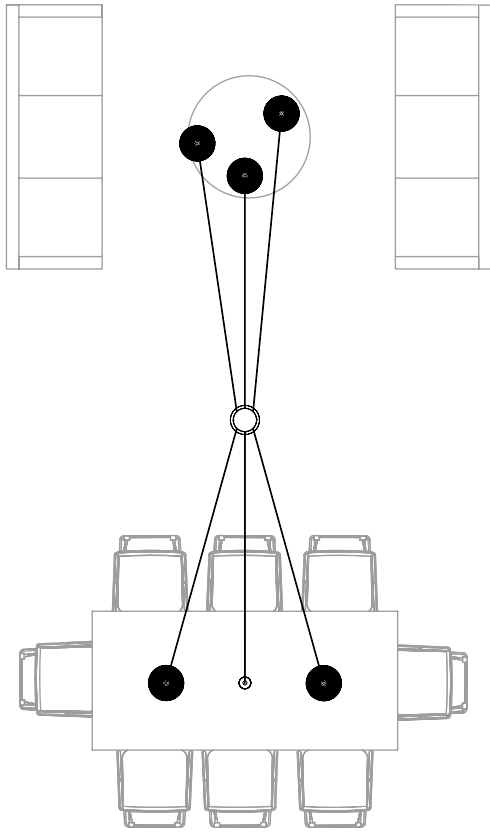



# EROCOSÌ

Pendelleuchte aus Altmessing mit  
schwarzem Stoffkabel

A++ - E  
IP20  



Anwendungsbeispiel

### EROCOSÌ 10 SO

1 x E27 | 230V | max. 42W

264-so01136 Altmessing



### EROCOSÌ 10 SO DEC

1 x E27 | 230V | max. 42W

264-so01137 Altmessing

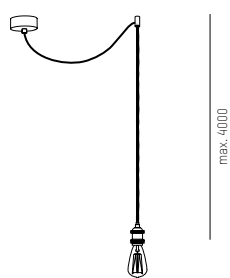

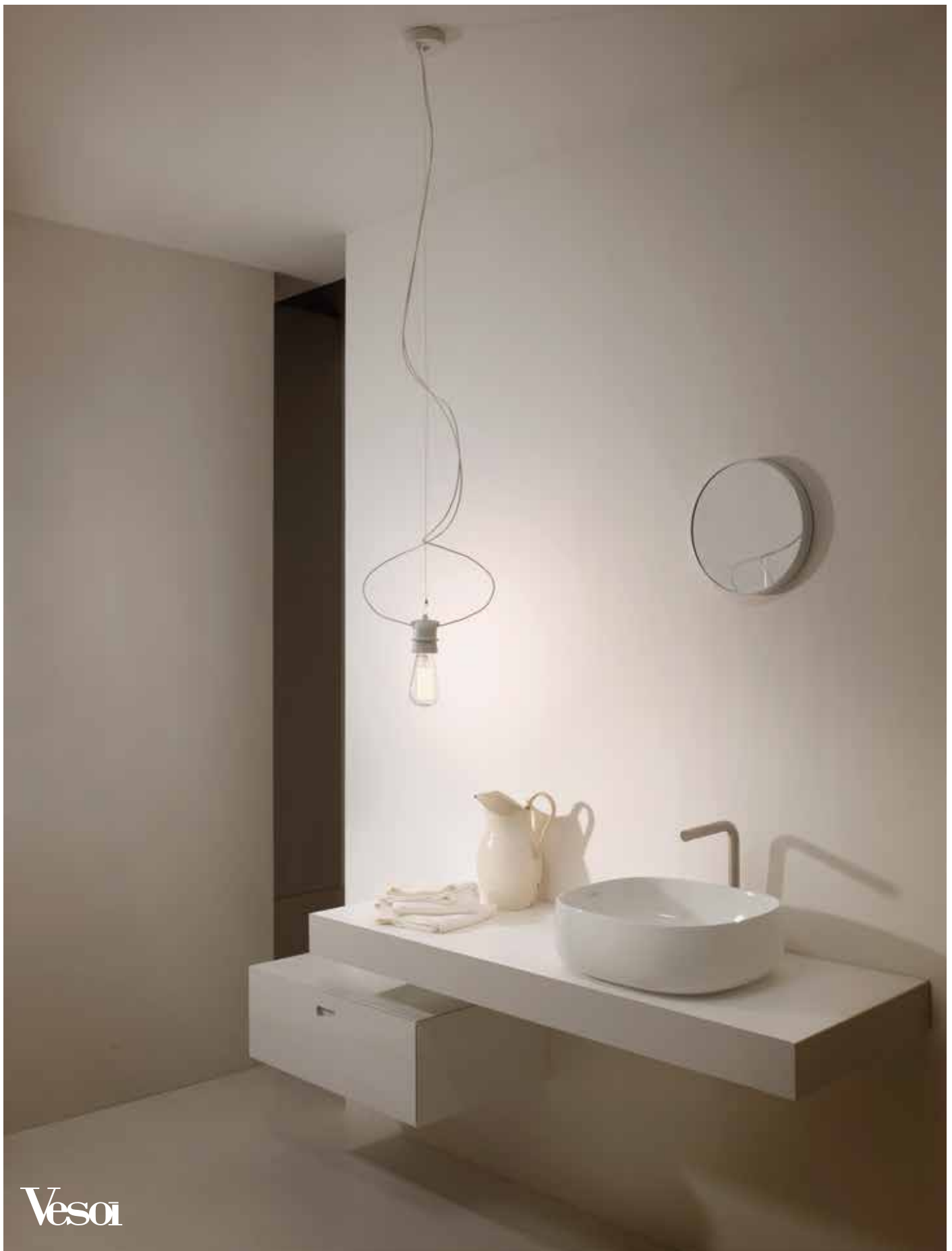

Vesoi

# LUMEN

Hängeleuchte aus Metall in den Farben  
weiß, schwarz oder Altmessing erhältlich.  
LED Version inkl. Konverter

IP20 



## LUMEN 12 SO

1 x E27 | 230V | max. 42W

- 264-so00437 weiß / Kabel weiß
- 264-so01125 schwarz / Kabel schwarz
- 264-so01126 Messing / Kabel schwarz

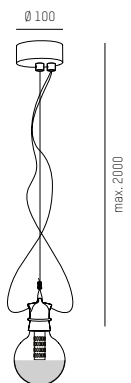

## LUMEN 12 SO LED

SYS 3,7W | 230V | 2700K  
380lm | CRI>80

- 264-so01127 weiß / Kabel weiß
- 264-so01128 schwarz / Kabel schwarz
- 264-so01129 Messing / Kabel schwarz

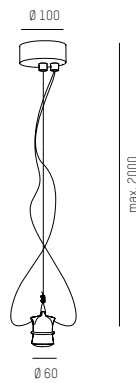







# LOON





# LOON

Dekorative Hängeleuchte im Retro-Design, hochwertige Glasschirme mundgeblasen in 3 Farben, Speziell konstruierte Fassung für bündigen Montage, Abhängung in 2 Farben erhältlich, Glasschirm separat ordern

A++ - E  
IP20  



## LOON PENDE

1 x E27 | 230V | max. 42W

636-1001  
636-1006

chrom  
schwarz

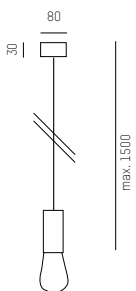

## LOON BALL GLAS

separat ordern

636-700g  
636-700a  
636-700b

grau  
amber  
braun

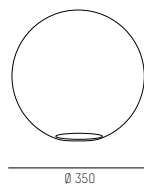

## LOON BEVEL GLAS

separat ordern

636-710g  
636-710a  
636-710b

grau  
amber  
braun



## LOON SOFT GLAS

separat ordern

636-720g  
636-720a  
636-720b

grau  
amber  
braun

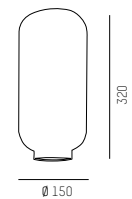



# BLOW

LED Hängeleuchten in zwei Größen,  
Schirm aus Glas in gold oder grau,  
Kabel aus schwarzem Stoff,  
inkl. TRIAC dimmbarem LED-Konverter.

A+ → A  
IP20  



## BLOW 17

SYS 12W | 230V | 3000K | 1050lm

302-84203010 Glas grau  
302-84203058 Glas gold

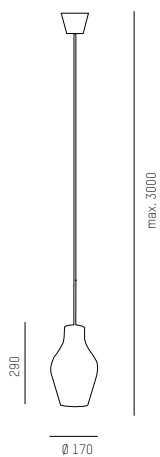

## BLOW 22

SYS 20W | 230V | 3000K | 1700lm

302-84213010 Glas grau  
302-84213058 Glas gold

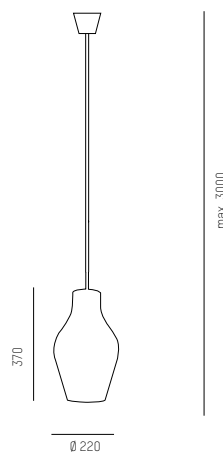



# BISTRO

Baldachin aus Metall, schwarz lackiert. Schirm aus transparentem, geblasenem und handgearbeitetem Glas. Mit schwarzem Stoffkabel

A++ - E  
IP20  



### BISTRO SQUARE SP1

1 x E27 | 230V | max. 42W

669-112305    Glas

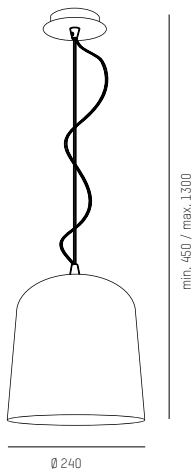

### BISTRO ROUND SP1

1 x E27 | 230V | max. 42W

669-120898    Glas

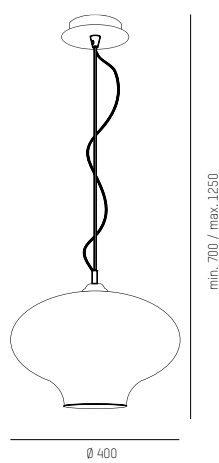

### BISTRO PLATE SP1

1 x E27 | 230V | max. 42W

669-112336    Glas

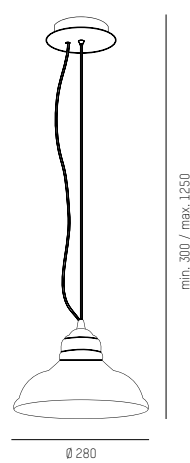





Design: Francesc Vilaro

# ALIVE

Hängeleuchten aus Metall verchromt oder weiß lackiert, Diffuser aus mattiertem Glas, inkl. LED Konverter

A++ - A

IP20  



**ALIVE**

SYS 7W | 230V | 2700K  
612lm | CRI>80

**105-0052842121** chrom  
**105-005284bwbw** weiß

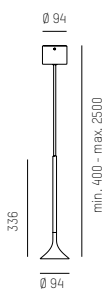

**ALIVE**

SYS 7W | 230V | 2700K  
612lm | CRI>80

**105-00528521f1** chrom  
**105-005285bwf1** weiß

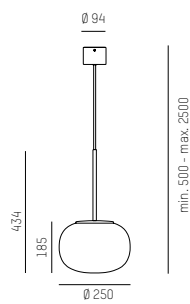

**ALIVE**

2 x SYS 7W | 230V | 2700K  
2 x 612lm | CRI>80

**105-00528721f1** chrom  
**105-005287bwf1** weiß

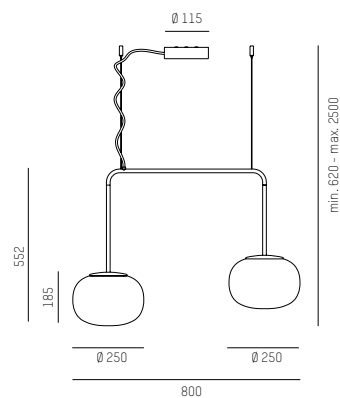



# TUBETTO

Pendelleuchte aus Metall in den Farben weiß, schwarz, Altmessing, chrom oder gelb. Stoffkabel schwarz.  
Bei Variante weiß: Stoffkabel weiß

A+ → A  
IP20  



### TUBETTO 50 SO

SYS 3W | 230V | 2700K  
180lm | CRI>80

- |                    |         |
|--------------------|---------|
| <b>264-so00971</b> | weiß    |
| <b>264-so00972</b> | schwarz |
| <b>264-so00973</b> | chrom   |
| <b>264-so00974</b> | messing |

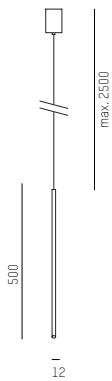

### TUBETTO 100 SO

SYS 3W | 230V | 2700K  
180lm | CRI>80

- |                    |         |
|--------------------|---------|
| <b>264-so00960</b> | weiß    |
| <b>264-so00961</b> | schwarz |
| <b>264-so00962</b> | chrom   |
| <b>264-so00963</b> | messing |

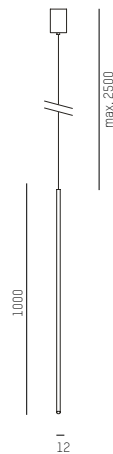

### TUBETTO 90 S6

SYS 6 x 3W | 230V | 2700K  
6 x 180lm | CRI>80

- |                    |      |
|--------------------|------|
| <b>264-so01173</b> | gelb |
|--------------------|------|

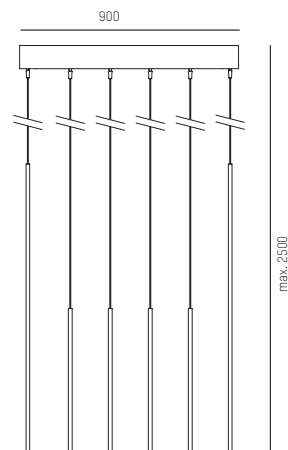

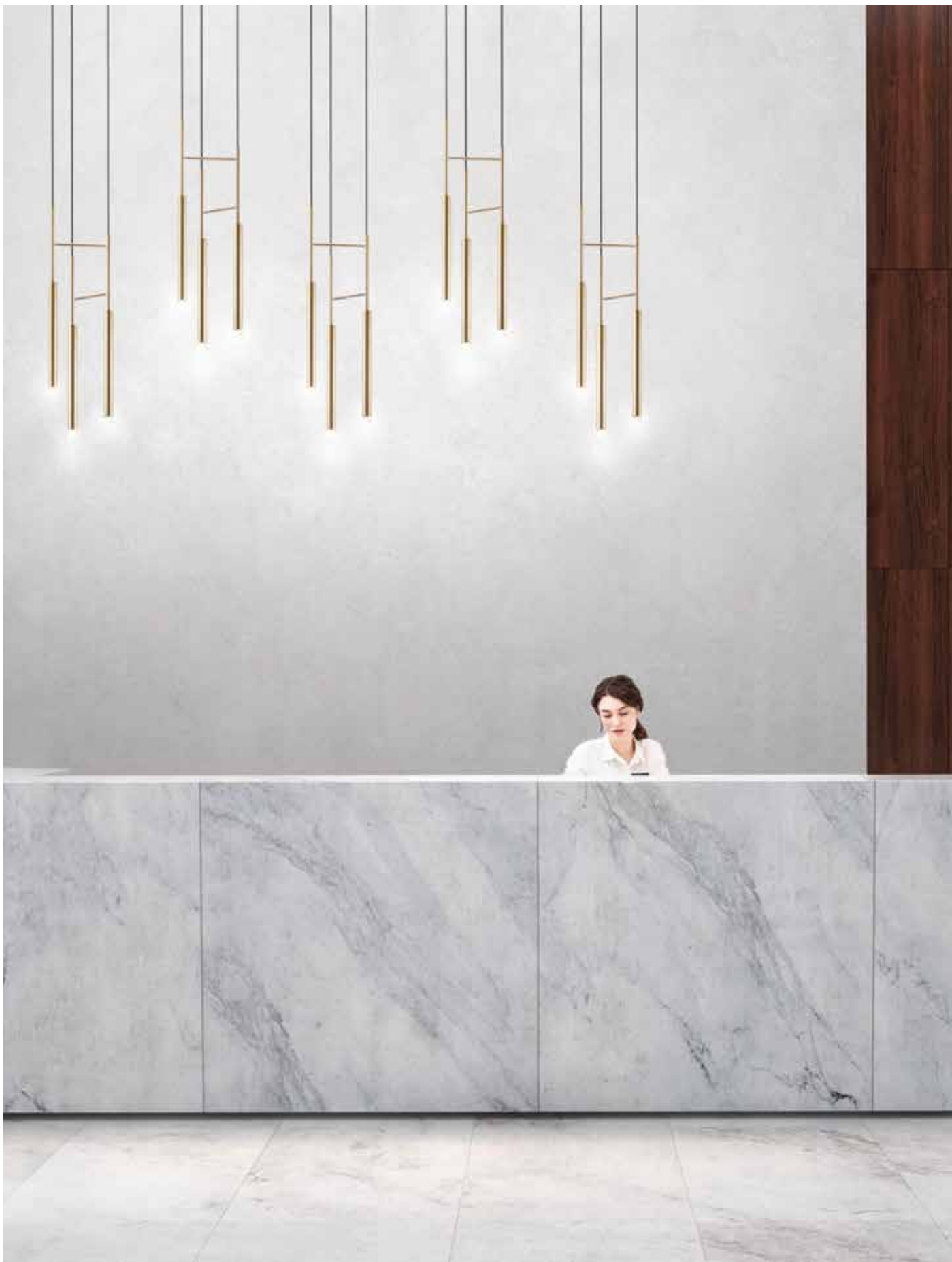



Design: Benedito Design

# CANDLE

Hängeleuchten aus Messing in drei Ausführungen, Diffuser aus mattiertem Glas, inkl. LED Konverter

A++ - A  
IP20  



### CANDLE AB

SYS 3W | 230V | 2700K  
174lm | CRI>80

105-0060172727 Messing

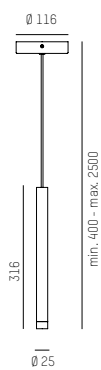

### CANDLE EB

SYS 3W | 230V | 2700K  
174lm | CRI>80

105-0060182727 Messing

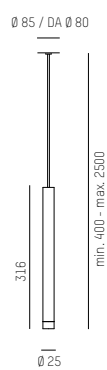

### CANDLE TRIPLEX

3 x SYS 3W | 230V | 2700K  
3 x 174lm | CRI>80

105-0060212727 Messing

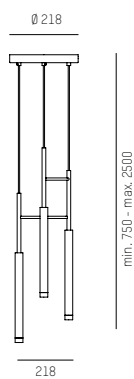

### CANDLE ZUBEHÖR

Scheibenaufsatz für Candle

105-7160222727 Messing

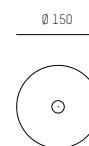



tossB

# SPECTER

Pendelleuchten aus Aluminium  
pulverbeschichtet in drei Größen,  
inkl. LED Konverter

A++ → A  
IP20  



### SPECTER S

SYS 9,3W | 230V | 2700K | 1080lm

699-t90h1dwl    weiß  
699-t90h1dzl    schwarz

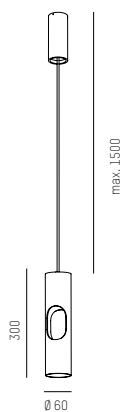

### SPECTER M

SYS 9,3W | 230V | 2700K | 1080lm

699-t90h2dwl    weiß  
699-t90h2dzl    schwarz

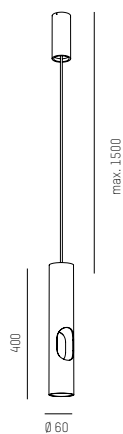

### SPECTER L

SYS 9,3W | 230V | 2700K | 1080lm

699-t90h3dwl    weiß  
699-t90h3dzl    schwarz

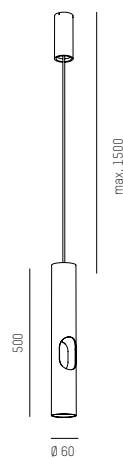





ECOLUCE

# RULO

Pendelleuchte aus weiß lackiertem Aluminium mit Lampenfassung GU10. Umhängebefestigung inbegriffen.

A++ - D  
IP20  



## RULO HL

1 x GU10 | 230V | max. 42W

68-151001 weiß

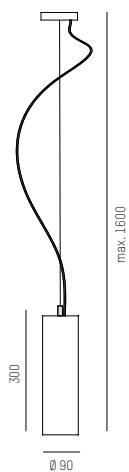

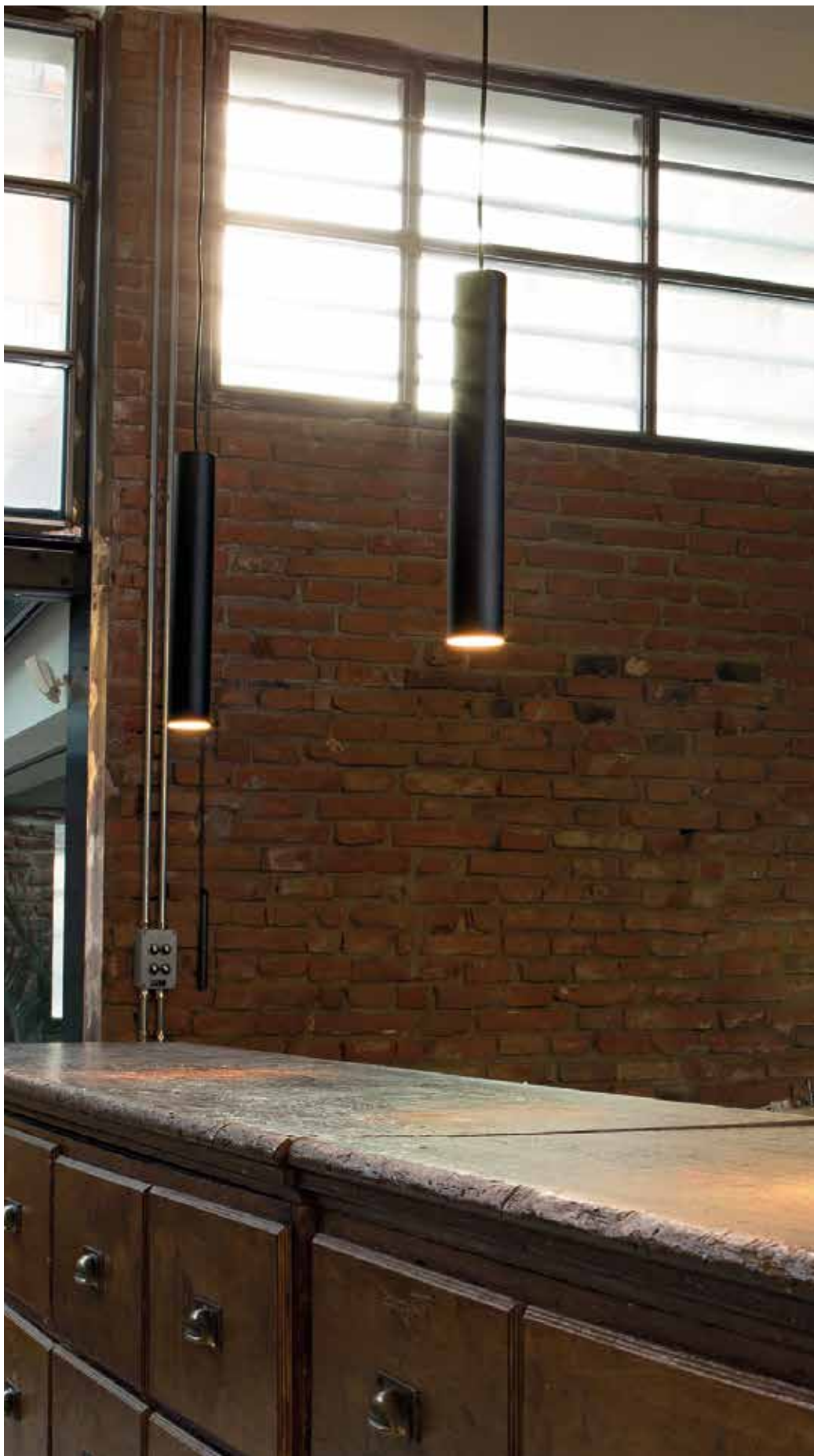

### LOOK SP1

1 x GU10 | 230V | max. 30W  
inkl. LM

- |            |         |
|------------|---------|
| 669-104928 | schwarz |
| 669-104935 | weiß    |
| 669-104942 | chrom   |

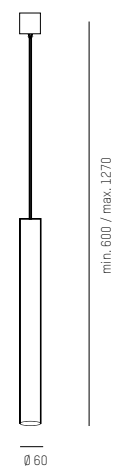

# LOOK

Baldachin und zylindrischer Schirm aus Metall.  
Erhältlich in chrom, matt weiß oder schwarz lackiert.



# MOBY

Baldachin und Schirm aus Metall. In Aluminium gebürstet, chrom, Kupfer matt, schwarz oder weiß lackiert erhältlich. Innen weiß lackiert.

A++ - E  
IP20 



## MOBY SP1

1 x E27 | 230V | max. 42W

669-093659	schwarz
669-102047	weiß
669-093680	chrom
669-102054	Aluminium
669-093697	Kupfer

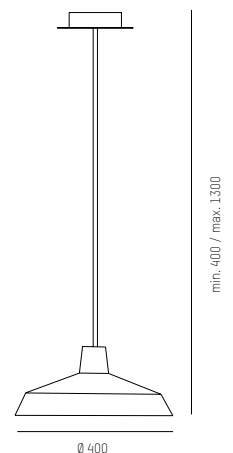



MOLTO LUCE®

Design: Rainer Mutsch

# SOFT

Organisch geformte Hängeleuchte aus Faserzement, traditionelle Fertigung - jedes Stück ist ein Unikat, Produktionsbedingt Abweichungen in der Oberfläche, Baldachin silber

A++ - E  
IP20  



### SOFT S

1 x E27 | 230V | max. 47W

588-100 Eternit

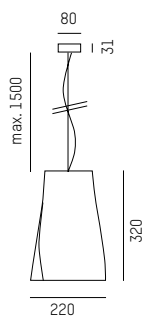

### SOFT L

1 x E27 | 230V | max. 47W

588-200 Eternit

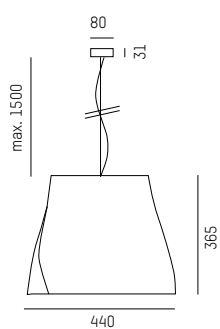



# OIL

Hängeleuchten mit Baldachin aus Metall in schwarz matt.  
Kabel aus schwarzem Stoff, Schirm aus Beton.  
Modell Oil-4 SP1 ist mit drei Haken und 6 Meter Kabel ausgestattet.

IP20  



### OIL-1 SP1

1 x E27 | 230V | max. 42W

669-110417 Zementgrau

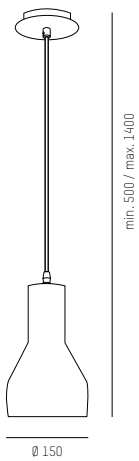

A\*\* - E

### OIL-2 SP1

1 x E27 | 230V | max. 42W

669-110424 Zementgrau

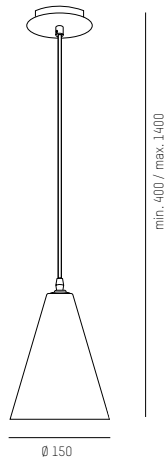

A\*\* - E

### OIL-3 SP1

1 x E27 | 230V | max. 42W

669-110431 Zementgrau

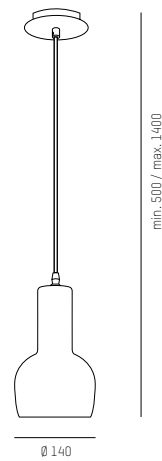

A\*\* - E

### OIL-4 SP1

1 x GU10 | 230V | max. 30W

669-110462 Zementgrau

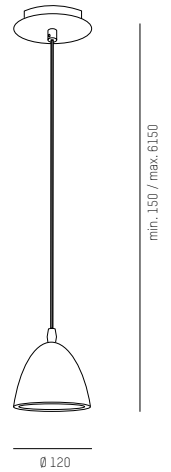

A\*\* - D





GUTES **DESIGN** MACHT DAS LEBEN BUNTER.





MOLTO LUCE®

Design: CEE-ID

# ZITA

Dekorative Hängeleuchte im Restostil, präzisionsgedrücktes Aluminium, Oberfläche lackiert, Lichtakzente durch seitliche Schlitze im Schirm, in 3 Größen und 3 Farbkombinationen erhältlich

A++ - E  
IP20  



## ZITA 20

1 x E27 | 230V | max. 57W

### Aussen / Innen

- 532-12005 weiß glänzend / melone
- 532-12055 weiß glänzend / weiß glänzend
- 532-12056 schwarz matt / weiß glänzend

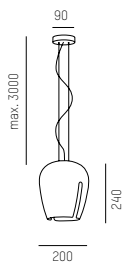

## ZITA 30

1 x E27 | 230V | max. 57W

### Aussen / Innen

- 532-13005 weiß glänzend / melone
- 532-13055 weiß glänzend / weiß glänzend
- 532-13056 schwarz matt / weiß glänzend

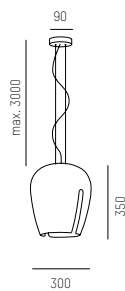

## ZITA 40

1 x E27 | 230V | max. 57W

### Aussen / Innen

- 532-14005 weiß glänzend / melone
- 532-14055 weiß glänzend / weiß glänzend
- 532-14056 schwarz matt / weiß glänzend

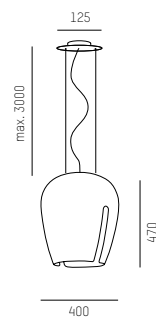



MOLTO LUCE®

Design: March Gut

# LAMELLA

Dekorative Hängeleuchte aus Aluminium in 3 Größen, Seidenmattlack in schwarz, weiß, goldbraun oder rot  
Baldachin weiß oder schwarz

IP20  



### LAMELLA FRAGOLA

1 x GU10 | 230V | max. 42W

- 592-11034 schwarz
- 592-1105 weiß
- 592-11033 graubeige
- 592-11038 rot

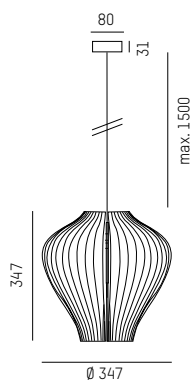

A\*\* - D

### LAMELLA PESCA

1 x E27 | 230V | max. 47W

- 592-14034 schwarz
- 592-1405 weiß
- 592-14033 graubeige
- 592-14038 rot

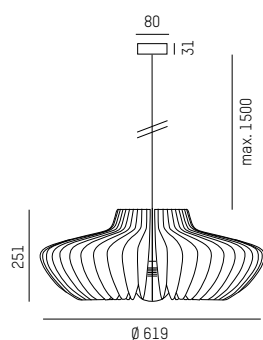

A\*\* - E

### LAMELLA MELA

1 x E27 | 230V | max. 47W

- 592-12034 schwarz
- 592-1205 weiß
- 592-12033 graubeige
- 592-12038 rot

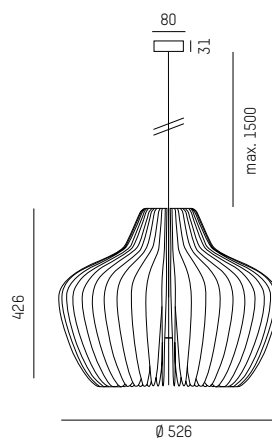



A\*\* - E



# EMITION

Hängeleuchten mit Schirm aus Metall in den  
Farben schwarz oder weiß lackiert.  
Stoffkabel in schwarz bzw. weiß.

A++ - E  
IP20  



### EMITON 17

1 x E14 | 230V | max. 28W

302-72743003 schwarz

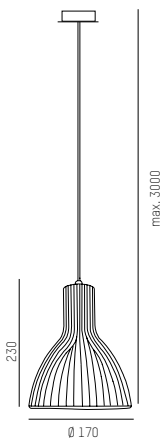

### EMITON 26

1 x E27 | 230V | max. 57W

302-72753001 weiß  
302-72753003 schwarz

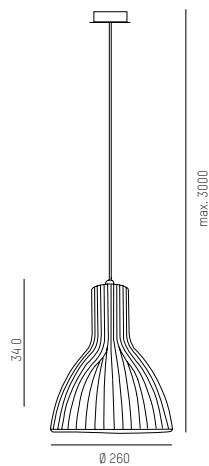







# AVER

Hängeleuchten in drei Größen,  
Schirm aus Metall schwarz lackiert,  
Kabel aus schwarzem Stoff.

A++ - E  
IP20  



### AVER 30

1 x E27 | 230V | max. 42W

302-84243003 schwarz

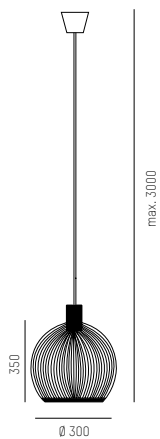

### AVER 40

1 x E27 | 230V | max. 42W

302-84253003 schwarz

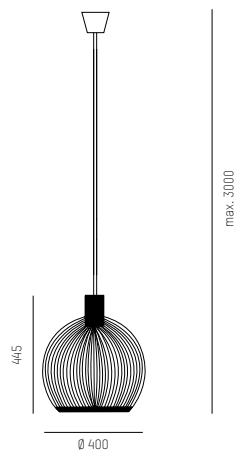

### AVER 50

1 x E27 | 230V | max. 42W

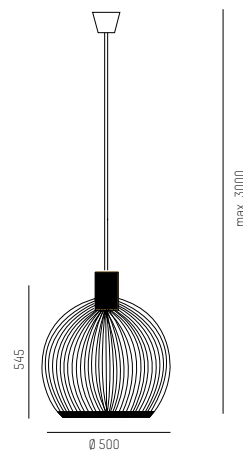

302-84263003 schwarz





# STRAP

Hängeleuchten in drei verschiedenen Größen. Schirm in Edelstahl gebürstet, schwarz lackiert oder Opalglas weiß. Inkl. 2 Stk. Lederriemen (braun und schwarz)

A++ - E  
IP20  



### STRAP 27

1 x E27 | 230V | max. 42W

302-84333001 weiß  
 302-84333003 schwarz  
 302-84333032 Edelstahl

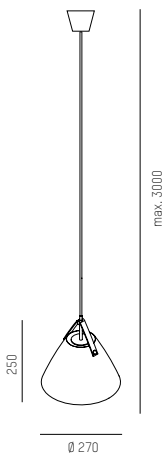

### STRAP 36

1 x E27 | 230V | max. 42W

302-84343001 weiß  
 302-84343003 schwarz  
 302-84343032 Edelstahl

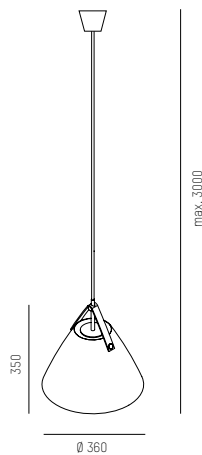

### STRAP 48

1 x E27 | 230V | max. 42W

302-84353001 weiß  
 302-84353003 schwarz  
 302-84353032 Edelstahl

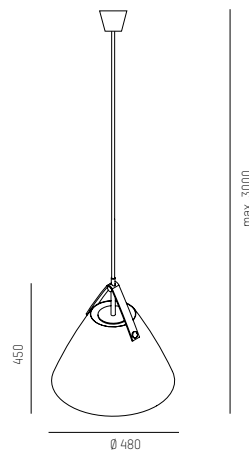

reddot award 2017  
 winner





# ARTIST

LED Hängeleuchten in zwei Größen,  
Schirm aus Metall in schwarz, weiß oder Kupfer ,  
Diffuser opalweiß, Stoffkabel in schwarz bzw. grau.  
inkl. TRIAC dimmbarem LED-Konverter.

A+ → A  
IP20  



## ARTIST 25

SYS 14W | 230V | 2700K | 1000lm | CRI>80

302-83083003 schwarz  
 302-83083010 grau  
 302-83083030 Kupfer

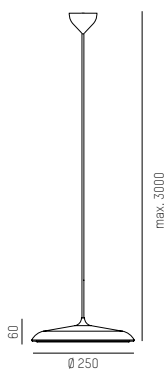

## ARTIST 40

SYS 24W | 230V | 2700K | 1460lm | CRI>80

302-83093003 schwarz  
 302-83093010 grau  
 302-83093030 Kupfer

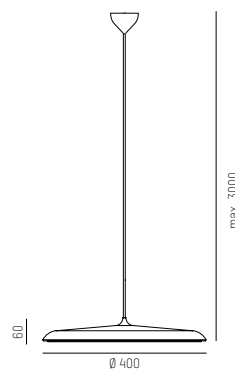



reddot award 2017  
 winner



# DEE

Hängeleuchte mit Schirm aus Metall schwarz oder weiß lackiert. Diffuser aus Kunststoff opal, Gewebekabel schwarz bzw. weiß.

A++ - E  
IP20  



## DEE

1 x E27 | 230V | max. 42W

302-84403003 schwarz  
302-84403001 weiß

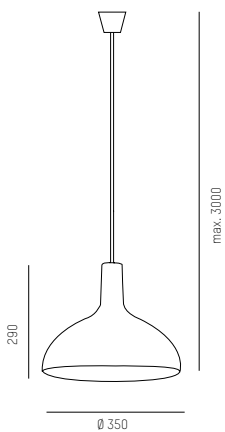





# GLOBO

Hängeleuchten aus Metall, weiß oder schwarz matt lackiert mit Klarglaseinsätzen. Lichtaustrittsöffnung justierbar

A++ - E  
IP20  



## GLOBO

1 x E27 | 230V | max. 52W

226-globm weiß matt  
226-glonm schwarz matt

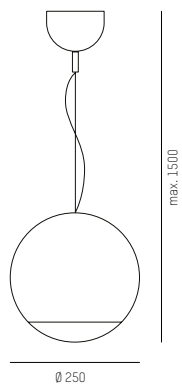



# I LUSTRI

Hängeleuchten aus Keramik, weiß oder schwarz matt lackiert. In 6 verschiedenen Formen erhältlich

A++ - E  
IP20  



### I LUSTRI L1

1 x E27 | 230V | max. 52W

226-l1bm weiß matt  
226-l1nm schwarz matt

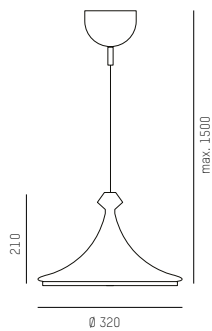

### I LUSTRI L2

1 x E27 | 230V | max. 52W

226-l2bm weiß matt  
226-l2nm schwarz matt

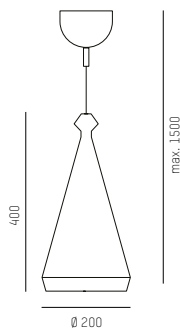

### I LUSTRI L3

1 x E27 | 230V | max. 52W

226-l3bm weiß matt  
226-l3nm schwarz matt

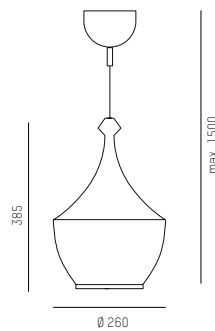



# I LUSTRI

Hängeleuchten aus Keramik, weiß oder schwarz matt lackiert. In 6 verschiedenen Formen erhältlich

A++ - E  
IP20  



### I LUSTRI L4

1 x E27 | 230V | max. 52W

226-l4bm weiß matt  
226-l4nm schwarz matt

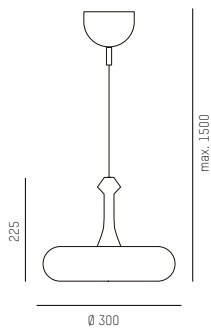

### I LUSTRI L5

1 x E27 | 230V | max. 52W

226-l5bm weiß matt  
226-l5nm schwarz matt

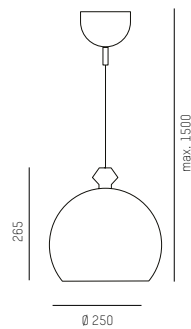

### I LUSTRI L6

1 x E27 | 230V | max. 52W

226-l6bm weiß matt  
226-l6nm schwarz matt

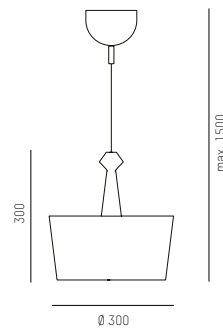



Design: Josep Patsi

# SIXTIES

Hängeleuchten aus Metall braun lackiert,  
inkl. LED Konverter

A++ - A  
IP20  



**SIXTIES**

SYS 11W | 230V | 3000K  
1050lm | CRI>80

**105-003689civ1** braun

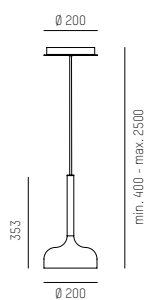

**SIXTIES**

SYS 11W | 230V | 3000K  
1050lm | CRI>80

**105-003688civ1** braun

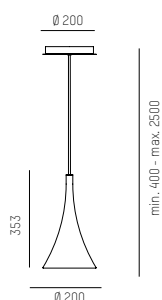

**SIXTIES**

SYS 11W | 230V | 3000K  
1050lm | CRI>80

**105-003687civ1** braun

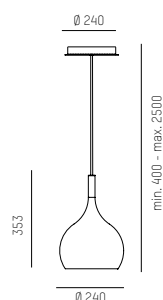

**SIXTIES**

3 x SYS 11W | 230V | 3000K  
3 x 1050lm | CRI>80

**105-003806civ1** braun

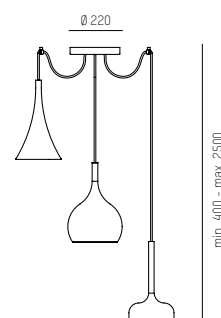





 PANZERI

Design: Minelli | Fossati

# VIISI

Fünfeckige Pendelleuchte aus gekantetem und gebogenem Aluminium, in zwei Längen erhältlich, mit direkt- oder indirekter Lichtverteilung. Hochwertige Polyacryl-Lackierung in schwarz oder weiß.

A++ - A  
IP 40 



## VIISI HL 120

SYS 23W | 230V | 3000K  
1502lm | CRI>80  
**direkt strahlend**  
**dali/push dimm**

140-l020011200102 weiß  
140-l020021200102 schwarz

SYS 23W | 230V | 3000K  
1502lm | CRI>80  
**indirekt strahlend**  
**dali/push dimm**

140-l021011200102 weiß  
140-l021021200102 schwarz

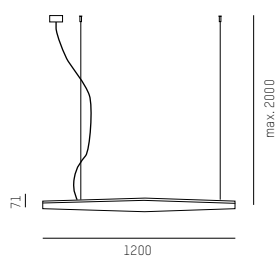

## VIISI HL 210

SYS 44W | 230V | 3000K  
3004lm | CRI>80  
**direkt strahlend**  
**dali/push dimm**

140-l020012100102 weiß  
140-l020022100102 schwarz

SYS 44W | 230V | 3000K  
3004lm | CRI>80  
**indirekt strahlend**  
**dali/push dimm**

140-l021012100102 weiß  
140-l021022100102 schwarz

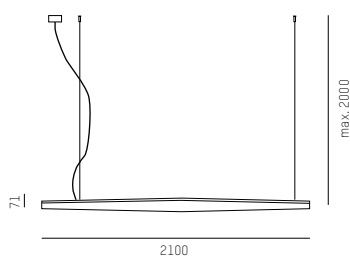

## VIISI STL

SYS 44W | 230V | 3000K  
3004lm | CRI>80  
**direkt strahlend**  
**dali/push dimm**

140-t020012100102 weiß  
140-t020022100102 schwarz

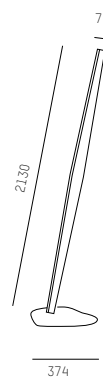



MOLTO LUCE®

# RIDE LENS

LED Pendelleuchte, Oberfläche eloxiert, weiß oder schwarz pulverbeschichtet, zurückversetzte Linsen mit verschiedenen Abstrahlwinkeln

A++ → A  
IP20  



## RIDE LENS HL

### REFLEKTOR 46° FLOOD

SYS 22W | 230V | 2700K  
1942lm direkt / 189lm indirekt | CRI>80

**634-042201335** weiß  
**634-042201336** schwarz eloxiert

SYS 22W | 230V | 3000K  
1942lm direkt / 194lm indirekt | CRI>80

**634-042201395** weiß  
**634-042201396** schwarz eloxiert



WEISS PULVERBESCHICHTET



SCHWARZ ELOXIERT

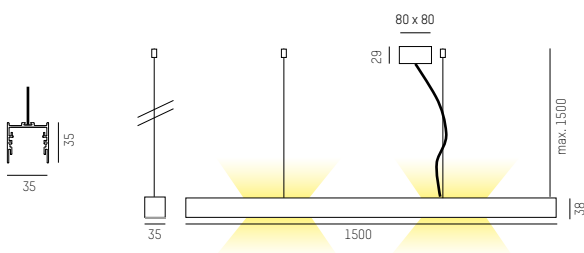

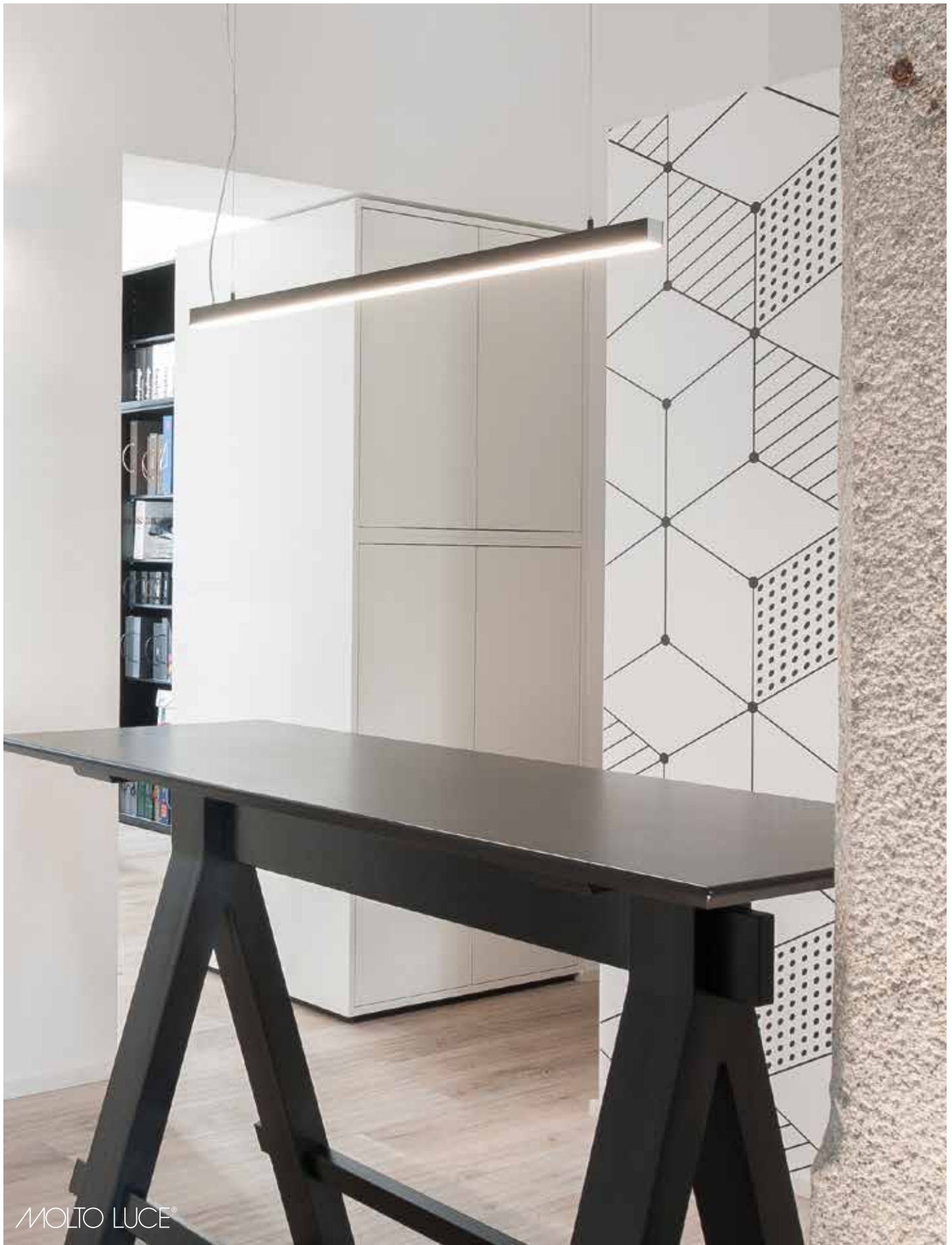

MOLTO LUCE®

# RIDE

LED Pendelleuchte aus stranggepresstem Aluminium mit Oberfläche eloxiert, weiß oder schwarz pulverbeschichtet, flache oder vorspringende kubische Abdeckung

A++ - A

IP20  

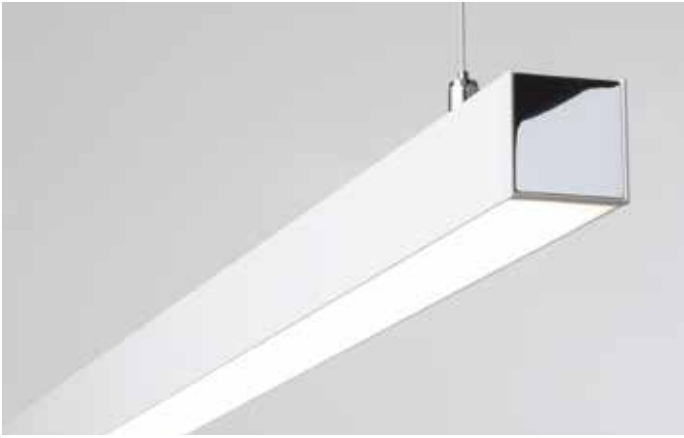

### RIDE 17W HL

#### ABDECKUNG KUBISCH

SYS 17W | 230V | 2700K  
1130lm | CRI>80

577-33021135 weiß  
577-33021136 schwarz  
577-33021138 Alu eloxiert

SYS 17W | 230V | 3000K  
1230lm | CRI>80

577-33021195 weiß  
577-33021196 schwarz  
577-33021198 Alu eloxiert

#### ABDECKUNG FLACH

SYS 17W | 230V | 2700K  
970lm | CRI>80

577-33020135 weiß  
577-33020136 schwarz  
577-33020138 Alu eloxiert

SYS 17W | 230V | 3000K  
1050lm | CRI>80

577-33020195 weiß  
577-33020196 schwarz  
577-33020198 Alu eloxiert

### RIDE 22W HL

#### ABDECKUNG KUBISCH

SYS 22W | 230V | 2700K  
1510lm | CRI>80

577-35021135 weiß  
577-35021136 schwarz  
577-35021138 Alu eloxiert

SYS 22W | 230V | 3000K  
1650lm | CRI>80

577-35021195 weiß  
577-35021196 schwarz  
577-35021198 Alu eloxiert

#### ABDECKUNG FLACH

SYS 22W | 230V | 2700K  
1290lm | CRI>80

577-35020135 weiß  
577-35020136 schwarz  
577-35020138 Alu eloxiert

SYS 22W | 230V | 3000K  
1400lm | CRI>80

577-35020195 weiß  
577-35020196 schwarz  
577-35020198 Alu eloxiert

### RIDE 27W HL

#### ABDECKUNG KUBISCH

SYS 27W | 230V | 2700K  
1890lm | CRI>80

577-36021135 weiß  
577-36021136 schwarz  
577-36021138 Alu eloxiert

SYS 27W | 230V | 3000K  
2060lm | CRI>80

577-36021195 weiß  
577-36021196 schwarz  
577-36021198 Alu eloxiert

#### ABDECKUNG FLACH

SYS 27W | 230V | 2700K  
1610lm | CRI>80

577-36020135 weiß  
577-36020136 schwarz  
577-36020138 Alu eloxiert

SYS 27W | 230V | 3000K  
1760lm | CRI>80

577-36020195 weiß  
577-36020196 schwarz  
577-36020198 Alu eloxiert

### RIDE 54 W HL

#### ABDECKUNG KUBISCH

SYS 54W | 230V | 2700K  
3780lm | CRI>80

577-37021135 weiß  
577-37021136 schwarz  
577-37021138 Alu eloxiert

SYS 54W | 230V | 3000K  
4120lm | CRI>80

577-37021195 weiß  
577-37021196 schwarz  
577-37021198 Alu eloxiert

#### ABDECKUNG FLACH

SYS 54W | 230V | 2700K  
3220lm | CRI>80

577-37020135 weiß  
577-37020136 schwarz  
577-37020138 Alu eloxiert

SYS 54W | 230V | 3000K  
3520lm | CRI>80

577-37020195 weiß  
577-37020196 schwarz  
577-37020198 Alu eloxiert

#### ABDECKUNG FLACH

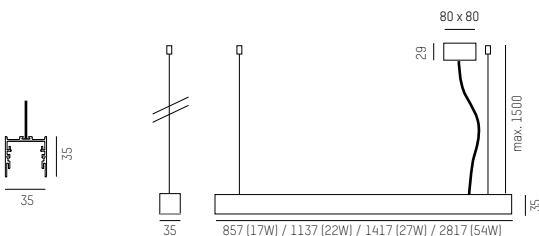

#### ABDECKUNG KUBISCH

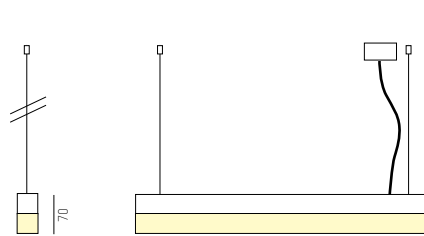

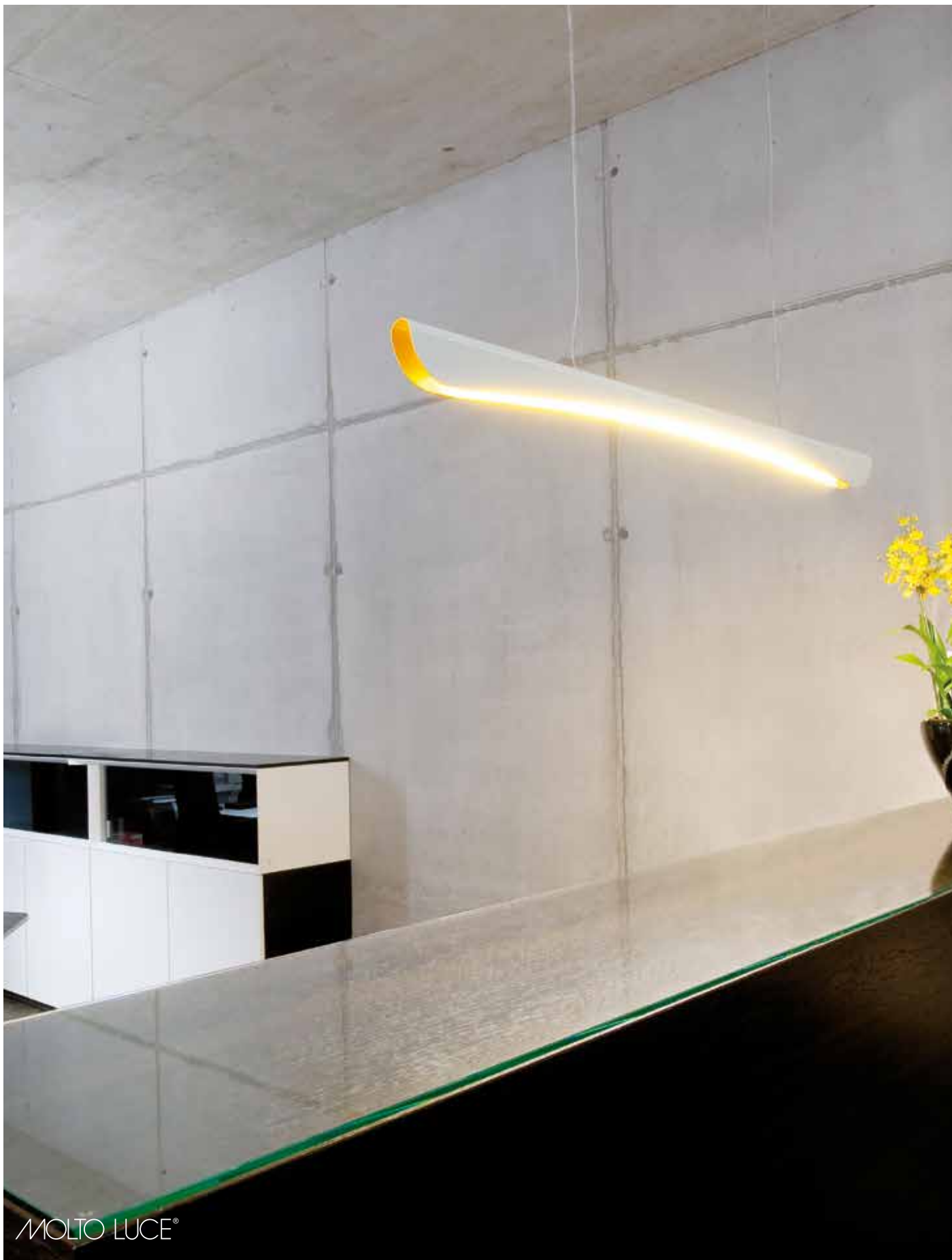

MOLTO LUCE®

Design: CEE-ID

# STRETTO

Schlanke Hängeleuchte aus gebogenem, lackiertem Aluminium in 3 Farbkombinationen erhältlich

IP20  



## STRETTO LED

SYS 18W | 230V | 2700K | 1690lm | CRI>80

- 530-2181305** Aussen / Innen  
weiß glänzend / melone  
**530-2181354** Alu poliert / weiß glänzend  
**530-2181355** weiß glänzend / weiß glänzend

SYS 18W | 230V | 3000K | 1725lm | CRI>80

- 530-2181905** Aussen / Innen  
weiß glänzend / melone  
**530-2181954** Alu poliert / weiß glänzend  
**530-2181955** weiß glänzend / weiß glänzend

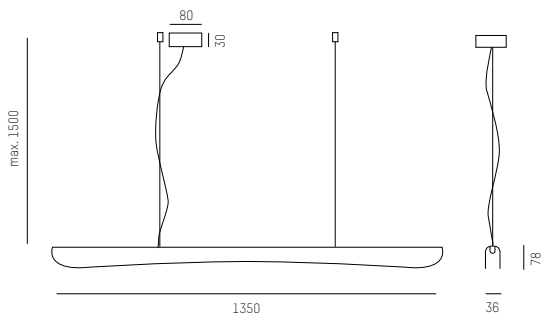

A+ → A

## STRETTO

1 x T16 | 230V | 28/54W Multiwatt

- 530-15405** Aussen / Innen  
weiß glänzend / melone  
**530-15444** Alu poliert / weiß glänzend  
**530-15455** weiß glänzend / weiß glänzend

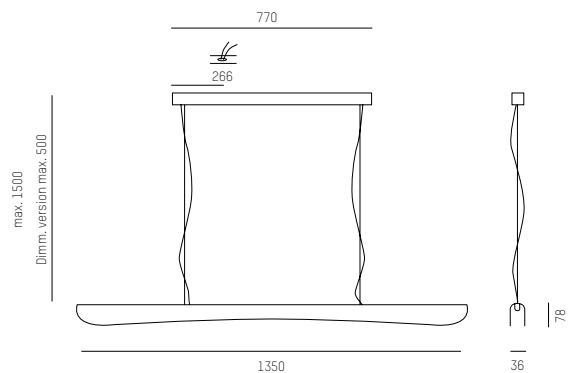

A+ → B





# AFTER 8



MOLTO LUCE®



MOLTO LUCE®

# AFTER 8

Extra schlanke LED Hängeleuchte mit nur 5mm Breite, Oberfläche eloxiert in schwarz oder coca, weiß lackiert, satinierte Abdeckung für homogenes Lichtbild, Abstrahlung mit Direkt- und Indirektanteil 70/30%

A++ - A  
IP20  



## AFTER 8

SYS 28W | 230V | 2700K  
1470lm | CRI>80

- 601-1035    weiß
- 601-10341    schwarz eloxiert
- 601-10342    coca eloxiert

SYS 28W | 230V | 3000K  
1520lm | CRI>80

- 601-1095    weiß
- 601-10941    schwarz eloxiert
- 601-10942    coca eloxiert



reddot award 2014  
winner

DESIGN PLUS  
powered by: light+building

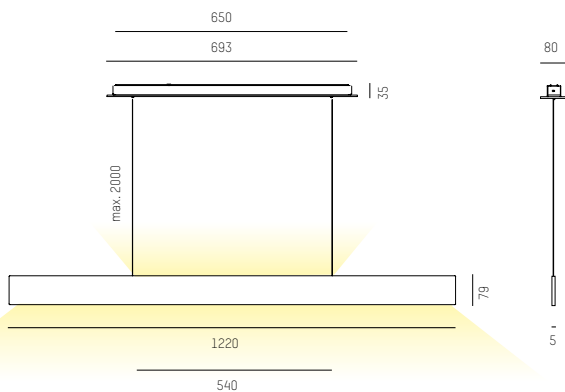





arturo alvarez  
emotional light

# UXI

Hängeleuchte aus Sperrholz, erhältlich in 3 Farbvarianten.  
Dimmbare Version mit integriertem dimmbarem EVG

A+ → B  
IP20  



## UXI

2 x G5 | 230V | 39W

385-ux04b      weiß  
 385-ux04we    wenge  
 385-ux04am    gelb

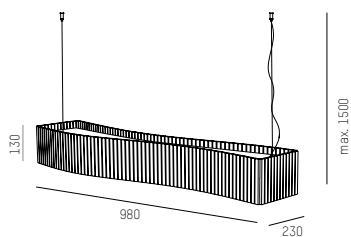

## UXI

2 x G5 | 230V | 39W  
 Dimmbar Dali oder Switch Dim.

385-ux04db    weiß  
 385-ux04dwe   wenge  
 385-ux04dam   gelb

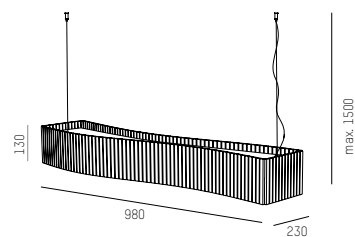

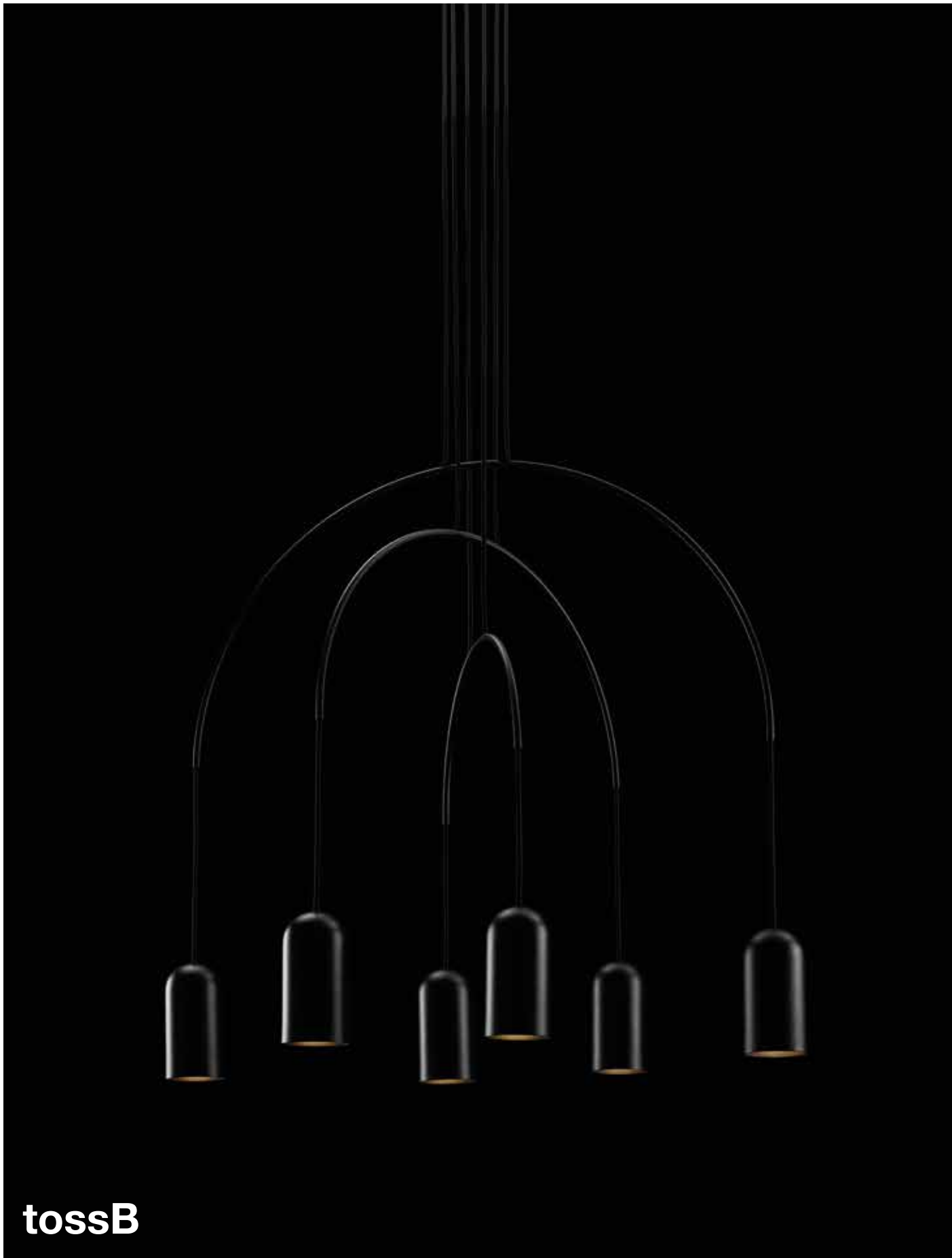



tossB

# BOW

Hängeleuchten aus Metall schwarz lackiert in vier Ausführungen  
2,- 4 - oder 6 flammig erhältlich.

A++ - E  
IP20  



**BOW I M**

2 x E27 | 230V | max. 42W

699-t97h2izl schwarz

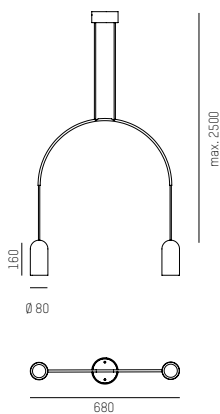

**BOW II M+ L**

4 x E27 | 230V | max. 42W

699-t97h6izl schwarz

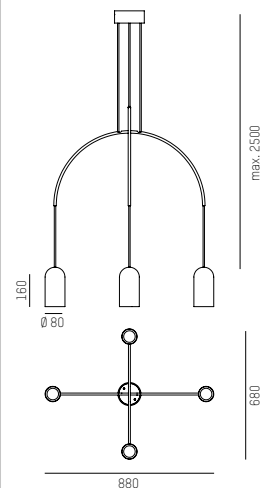

**BOW II S+L**

4 x E27 | 230V | max. 42W

699-t97h5izl schwarz

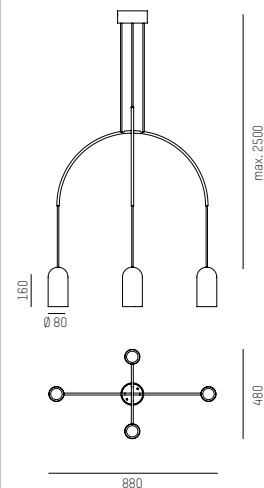

**BOW III S+M+L**

6 x E27 | 230V | max. 42W

699-t97h7izl schwarz

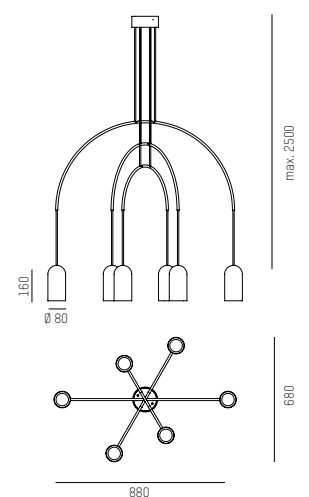







Design: Benedito Design

# SATURN

Hängeleuchten aus Kupfer Diffuser aus  
mattiertem PMMA, inkl. LED Konverter

A++ - A  
IP20  

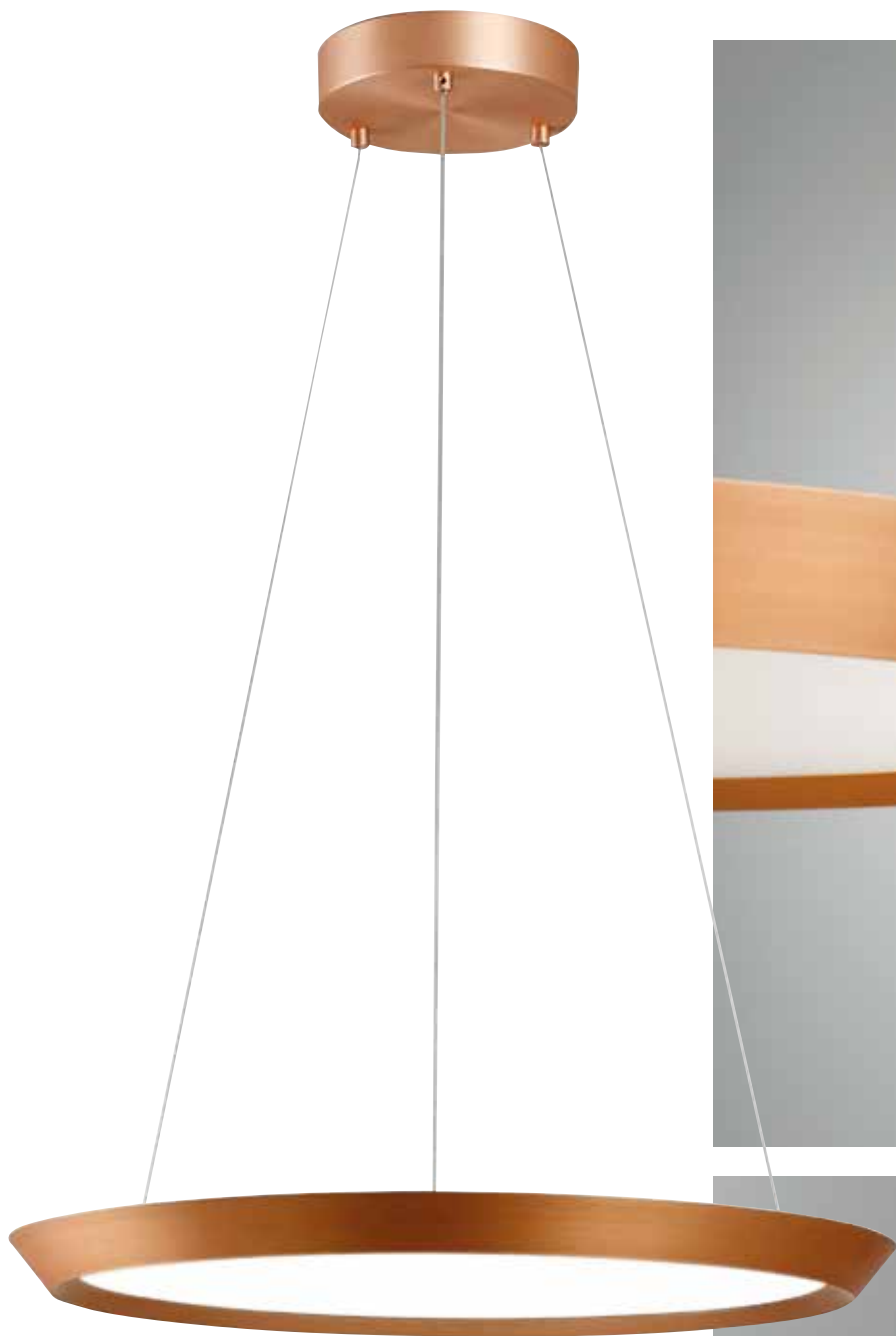

**SATURN**

SYS 13W | 230V | 2700K  
1300lm | CRI>80

105-00601506m1 Kupfer

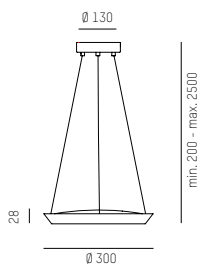

**SATURN**

SYS 40W | 230V | 2700K  
4000lm | CRI>80

105-00601406m1 Messing

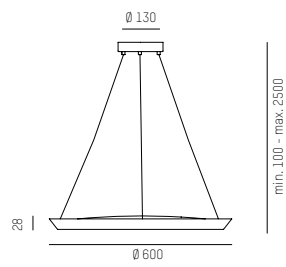





Vesoi

# ICS

Pendelleuchte aus Metall in den Farben weiß, schwarz oder Messing natur, Diffuser wahlweise aus opalem oder klarem Glas, In drei verschiedenen Größen erhältlich

A++ - E  
IP20  



## ICS 65 SO

4 x G9 | 230V | max. 33W

<b>264-so01352</b>	weiß / Glas klar
<b>264-so01353</b>	weiß / Glas opal
<b>264-so01324</b>	schwarz / Glas klar
<b>264-so01355</b>	schwarz / Glas opal
<b>264-so01356</b>	Messing / Glas klar
<b>264-so01357</b>	Messing / Glas opal

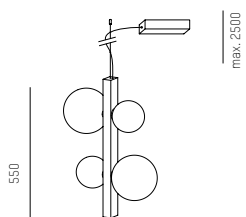

## ICS 90 SO

6 x G9 | 230V | max. 33W

<b>264-so01358</b>	weiß / Glas klar
<b>264-so01359</b>	weiß / Glas opal
<b>264-so01360</b>	schwarz / Glas klar
<b>264-so01361</b>	schwarz / Glas opal
<b>264-so01362</b>	Messing / Glas klar
<b>264-so01363</b>	Messing / Glas opal

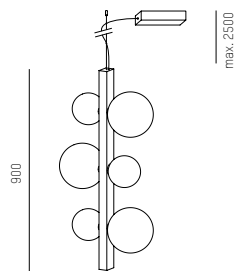

## ICS 145 SO

10 x G9 | 230V | max. 33W

<b>264-so01346</b>	weiß / Glas klar
<b>264-so01347</b>	weiß / Glas opal
<b>264-so01348</b>	schwarz / Glas klar
<b>264-so01349</b>	schwarz / Glas opal
<b>264-so01350</b>	Messing / Glas klar
<b>264-so01351</b>	Messing / Glas opal

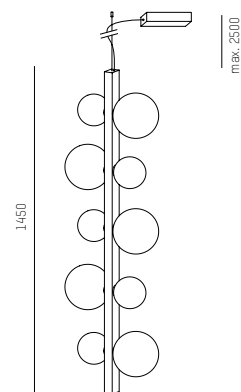



GUTES **DESIGN** LÄDT ZUM VERWEILEN EIN.





**PARACHILNA**

Design: atelier oi

# OIPHORIQUE

Stehleuchten aus  
Metall mit beweglichem  
Schirm aus Stoff. In  
zwei Farben und Größen  
verfügbar.

A' → B  
IP20  



## OIPHORIQUE P PE STRUKTUR

Schirm separat ordern  
2 x T16 | G5 | 230V | 39W

456-309000300000 Metall

## OIPHORIQUE T PE SCHIRM

Separat ordern

456-608000000020 dunkelgrau  
456-608000000027 hellgrau

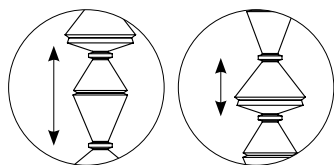
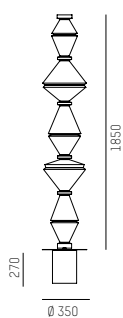

Durch in der Leuchte verbaute Motor ziehen sich die Schirmkomponenten auseinander und zusammen. Dadurch entsteht eine Bewegung in Wellenoptik.

## OIPHORIQUE P GR STRUKTUR

Schirm separat ordern  
2 x T16 | G5 | 230V | 54W

456-310000300000 Metall

## OIPHORIQUE T PE SCHIRM

Separat ordern

456-609000000020 dunkelgrau  
456-609000000027 hellgrau

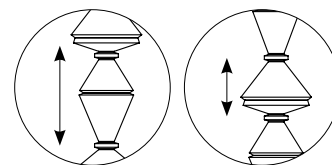
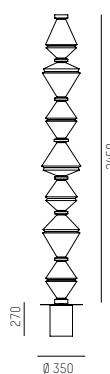

Durch in der Leuchte verbaute Motor ziehen sich die Schirmkomponenten auseinander und zusammen. Dadurch entsteht eine Bewegung in Wellenoptik.





**PARACHILNA**

Design: atelier oi

# OIPHORIQUE

Hängeleuchten aus Metall mit beweglichem Schirm aus Stoff. In zwei Farben und Größen verfügbar.

A' → B  
IP20  

## OIPHORIQUE T PE STRUKTUR

Schirm separat ordern  
2 x T16 | G5 | 230V | 39W

456-127000300000 Metall

## OIPHORIQUE T PE SCHIRM

Separat ordern

456-608000000020 dunkelgrau

456-608000000027 hellgrau

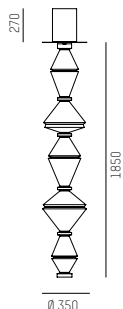

## OIPHORIQUE T GR STRUKTUR

Schirm separat ordern  
2 x T16 | G5 | 230V | 54W

456-128000300000 Metall

## OIPHORIQUE T PE SCHIRM

Separat ordern

456-609000000020 dunkelgrau

456-609000000027 hellgrau

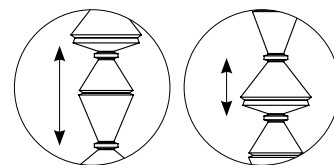
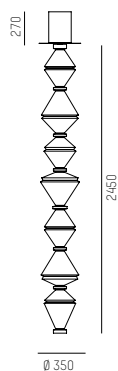

Durch in der Leuchte verbauten Motor ziehen sich die Schirmkomponenten auseinander und zusammen. Dadurch entsteht eine Bewegung in Wellenoptik.



Design: Dante Donegani, Giovanni Lauda

# STRING XL

Stehleuchten aus Metall. In den Farben weiß matt und champagner oder schwarz, Gummizug orange.

A+ → A  
IP20



## STRING XL

SYS 43W | 230V | 2700K | 3100lm

895-1srxl00143e0 silber  
895-1srxl00163e0 weiß matt  
895-1srxl00162e0 schwarz

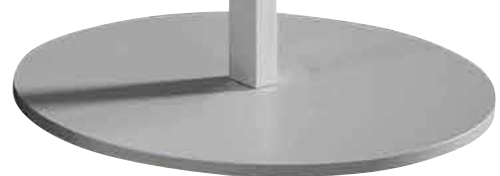
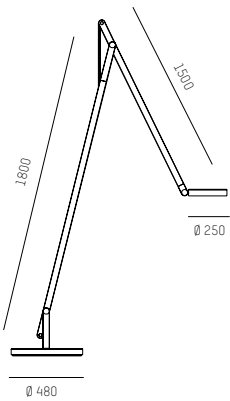



# DORSALE

Fuß aus Metall in chrom, matt weiß oder schwarz lackiert.  
Teleskoparm aus Vierkantrohr.  
Leuchtschirm aus PVC-Folie, chromfarbig, mit weißem oder schwarzem Stoff bezogen.

A+ - E  
IP 20 



### DORSALE PL1

1 x E27 | 230V | max. 42W

- 669-116051      schwarz
- 669-116075      weiß
- 669-116068      chrom

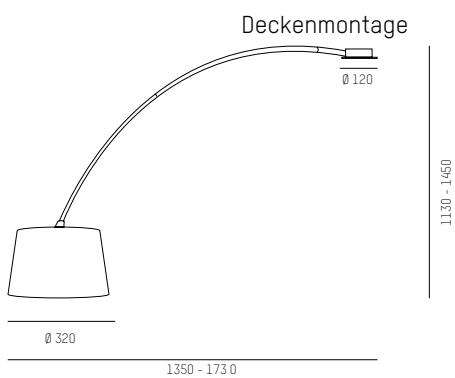

### DORSALE PT1

1 x E27 | 230V | max. 42W

- 669-014371      Schirm / Fuss  
schwarz/chrom
- 669-012605      weiß/chrom
- 669-005126      chrom/chrom
- 669-091983      schwarz/schwarz
- 669-095127      weiß/weiß

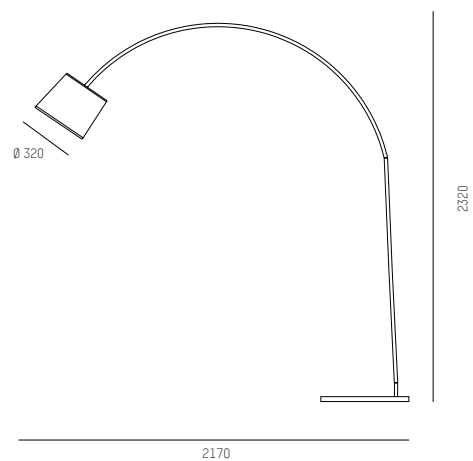



# DADDY

Struktur aus Metall. In schwarz und weiß matt erhältlich, Lampenschirm mit Stoff bezogen, oder aus PVC-Folie chrom halbtransparent.

A++ - E  
IP20  



**DADDY PT1**

1 x E27 | 230V | max. 42W

- 669-110363      schwarz
- 669-110356      weiß
- 669-110370      chrom

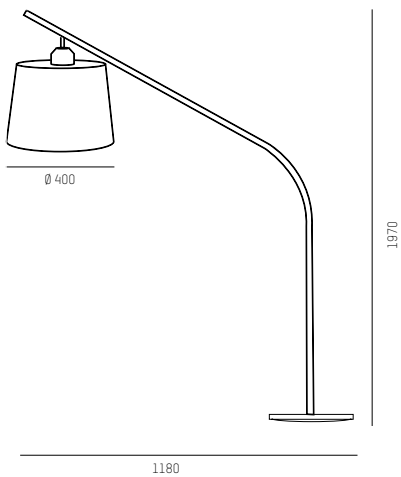





# YORK

Fuß aus Naturholz mit Metalldetails.  
Lampenschirm aus PVC-Folie mit weißem Stoff  
bezogen. Mit Stoffkabel inkl. Ein/Aus Schalter.

A++ - E  
IP20  



### YORK TABLE TL1

1 x E27 | 230V | max. 42W

- 669-121420 schwarz
- 669-121390 weiß
- 669-089799 Holz

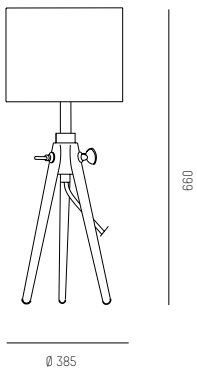

### YORK PT1

1 x E27 | 230V | max. 42W

- 669-121437 schwarz
- 669-121406 weiß
- 669-089805 Holz

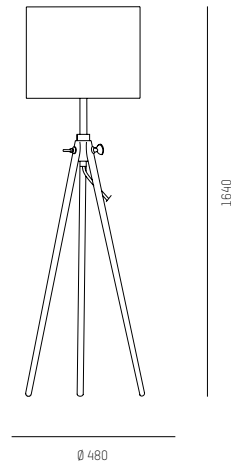



# NEWTON

Struktur und Schirm aus Metall.  
Erhältlich in nickel satin, brüniert oder  
schwarz matt lackiert. Arm und  
Schirm einstellbar, innen weiß lackiert.

A+ - E  
IP 20 



### NEWTON AP1

1 x E27 | 230V | max. 42W

- 669-016399**    Nickel satin
- 669-027876**    brüniert
- 669-027852**    schwarz

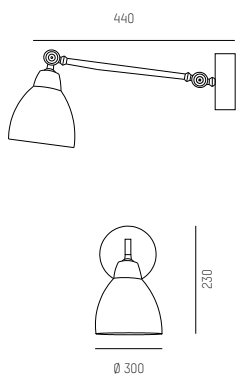

### NEWTON TL1

1 x E27 | 230V | max. 42W

- 669-012209**    Nickel satin
- 669-027869**    brüniert
- 669-003535**    schwarz

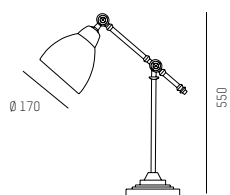

### NEWTON PT1

1 x E27 | 230V | max. 42W

- 669-015286**    Nickel satin
- 669-016375**    brüniert
- 669-003528**    schwarz

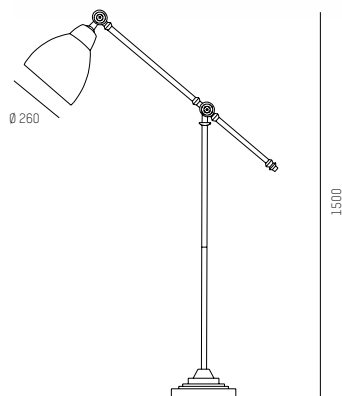



# WALLY

Tisch und Stehleuchte aus Metall verchromt oder lackiert. Arm mit Federgelenk, Schirm einstellbar.

A++ - E  
IP20  



## WALLY TABLE

1 x E27 | 230V | max. 42W

- 669-061191 schwarz
- 669-061177 silber
- 669-061184 chrom

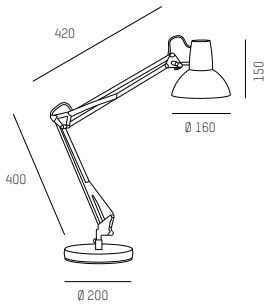

## WALLY FLOOR

1 x E27 | 230V | max. 42W

- 669-027036 schwarz
- 669-027050 silber
- 669-027043 chrom

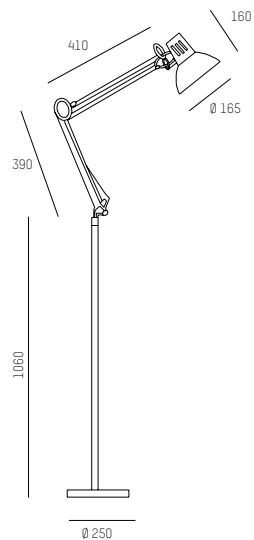





tossB

# SLIDE

Leuchterserie aus Aluminium weiß pulverbeschichtet und Eichenholz natur, als Tisch- und Stehleuchte verfügbar

A++ - D  
IP20  



**SLIDE TABLE**

1 x GU10 | 230V | max. 42W

**699-t83t1iwl** weiß/Eichenholz

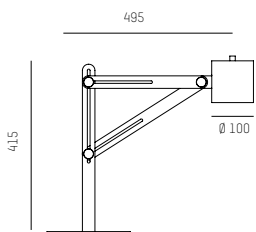

**SLIDE FLOOR**

1 x GU10 | 230V | max. 42W

**699-t83f1iwl** weiß/Eichenholz

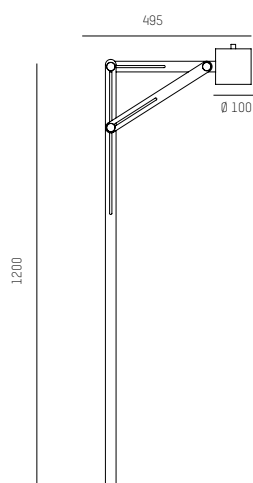





Vesoi

# TREPIÉ

Tisch- und Stehleuchten aus Metall, in den Farben weiß, schwarz und braun lackiert. Inkl. LED Konverter

A++ → A  
IP20  



## TREPIÉ 65 PH

SYS 23W | 230V | 3000K | 1800lm

264-ph00091 weiß  
 264-ph00092 schwarz  
 264-ph00093 braun

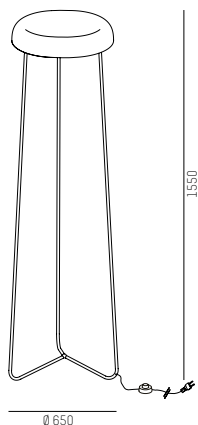

## TREPIÉ 50 LP

SYS 14W | 230V | 3000K | 1200lm

264-lp00211 weiß  
 264-lp00212 schwarz  
 264-lp00213 braun

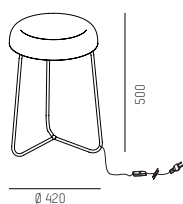



**PANZERI**

Design: Enzo Panzeri

# JACKIE

Steh- und Tischleuchte aus Aluminium,  
Titan eloxiert, weiß, rot oder schwarz  
pulverbeschichtet, Dreh- und schwenkbar,  
5-Stufen Touch-Dimmbar am Leuchtenkopf

A++ - A  
IP 40  



## JACKIE STL

SYS 10W | 230V | 3000K | 527lm  
CRI>90

- 140-t077010000409 weiß
- 140-t077020000409 schwarz
- 140-t077030000409 rot
- 140-t077300000409 titan

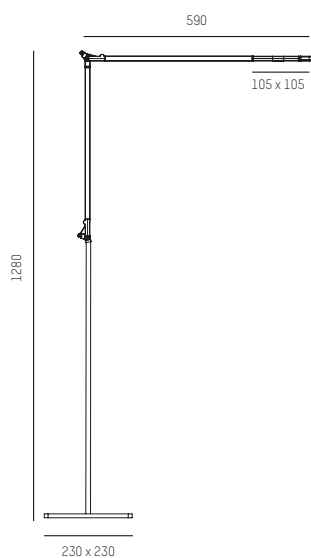

## JACKIE TL

SYS 10W | 230V | 3000K | 527lm  
CRI>90

- 140-c077010000409 weiß
- 140-c077020000409 schwarz
- 140-c077030000409 rot
- 140-c077300000409 titan

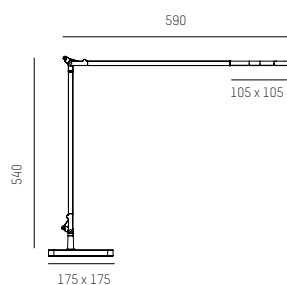



# IVEN

LED Tischleuchte aus Aluminium mit Oberfläche weiss pulverbeschichtet, Alu, rose-gold oder schwarz eloxiert, asymmetrischer mikrofacettierter Freiformflächenreflektor, Gleichmäßiges Licht mit sehr guter Längsentblendung, Direkt strahlend, 3-Stufen TOUCH dimmbar, RDB asymmetrischer Reflektor von Bartenbach

A+ → A  
IP20  



## IVEN TL

SYS 8W | 230V | 3000K  
445lm | CRI>80

**630-180195** weiß  
**630-1801941** schwarz eloxiert  
**630-180198** Alu eloxiert

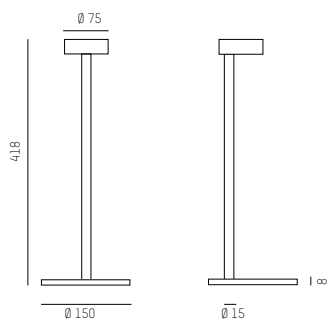

3-Stufen TOUCH dimmbar  
3-steps TOUCH dimmable





# ALFIERE

Struktur aus verchromten Metall.  
Leuchtschirm aus PVC-Folie in  
chrom halbtransparent.

A++ - E  
IP20  



### ALFIERE TL1 BIG

1 x E27 | 230V | max. 42W

669-032436 chrom

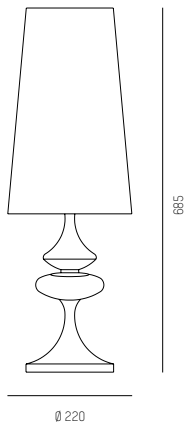

### ALFIERE TL1 SMALL

1 x E27 | 230V | max. 42W

669-032467 chrom

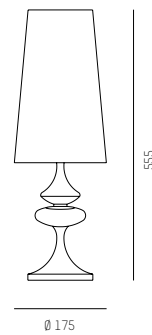





arturo alvarez  
emotional light

# PILI

Tischleuchte aus lackiertem Edelstahlfaden.  
Füsse aus Edelstahl. Nur in weiss erhältlich.

A++ - A  
IP20 



## PILI

SYS 4W | 230V | 2700K  
290lm | CRI>85

**385-pl01b**      weiß

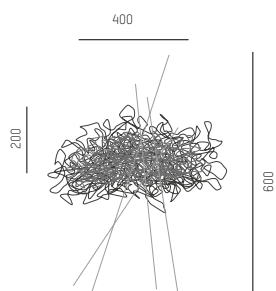



GUTES **DESIGN** BEHÄLT SEINE GÜLTIGKEIT,  
AUCH WENN DIE JAHRE VERGEHEN.





# IDEACEMENTO

Wandleuchten  
aus Beton,  
inkl. Konverter





### IDEACEMENTO 15 AP

Leuchtenkopf  
 SYS 3,7W | 230V | 2700K  
 380lm | CRI>80

+  
 Wandbaldachin  
 SYS 3W | 230V | 2700K  
 280lm | CRI>80

264-ap00773 Beton

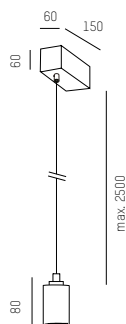

### IDEACEMENTO 15 AP DEC

Leuchtenkopf  
 SYS 3,7W | 230V | 2700K  
 380lm | CRI>80

+  
 Wandbaldachin  
 SYS 3W | 230V | 2700K  
 280lm | CRI>80

264-ap00774 Beton

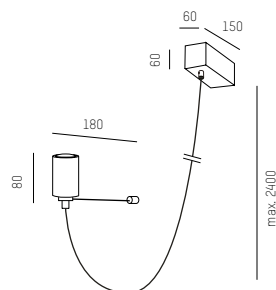



TOY







 PANZERI

# TOY

Wandleuchten aus Metall mit Glasdiffusor, direkt-/ indirekte Lichtverteilung, Leuchtenkörper wahlweise weiß lackiert, poliertem oder mattem Edelstahl oder Blattgold beschichtet.

A++ - A  
IP20  



### TOY WL 250

SYS 13W | 230V | 3000K  
938lm | CRI>80

- 140-a016010250101 weiß
- 140-a016210250101 Blattgold
- 140-a016370250101 Stahl pol.
- 140-a016390250101 Stahl matt



### TOY WL 610

SYS 35W | 230V | 3000K  
2814lm | CRI>80

- 140-a016010600101 weiß
- 140-a016210600101 Blattgold
- 140-a016370600101 Stahl pol.
- 140-a016390600101 Stahl matt



### TOY WL 900

SYS 45W | 230V | 3000K  
3752lm | CRI>80

- 140-a016010900101 weiß
- 140-a016210900101 Blattgold
- 140-a016370900101 Stahl pol.
- 140-a016390900101 Stahl matt



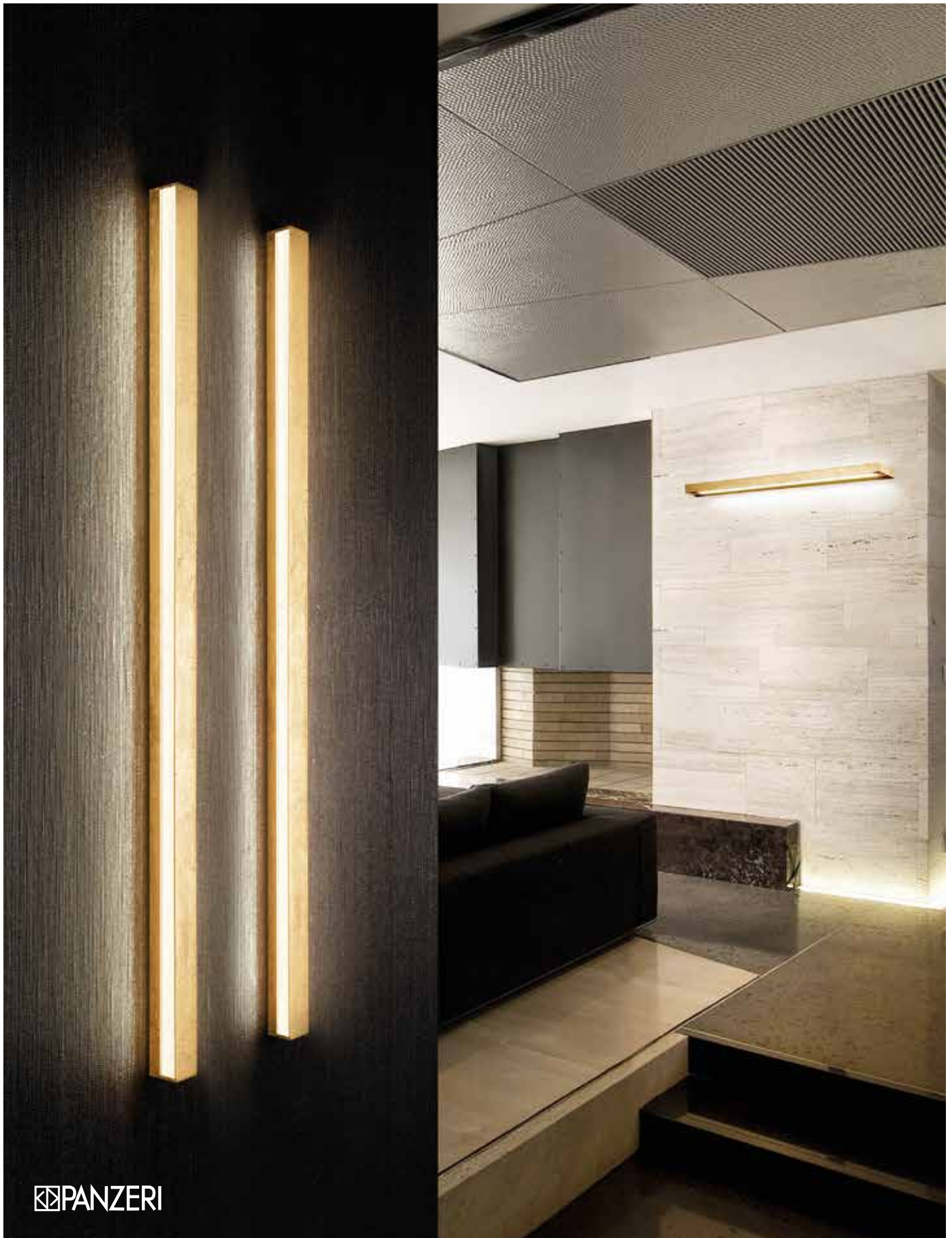

 PANZERI

# ZERO

Wandleuchten aus Metall mit Glasdiffusor, direkt-/ indirekte Lichtverteilung, Leuchtenkörper wahlweise weiß lackiert, verchromt, Blattgold, Blattsilber oder Blattkupfer beschichtet.

 A++ - A  
IP20  



## ZERO WL 500

SYS 11W | 230V | 3000K  
700lm | CRI>80

- 140-a035010500101 weiß
- 140-a035210500101 Blattgold
- 140-a035220500101 chrom
- 140-a035230500101 Blattsilber
- 140-a035240500101 Blattkupfer



## ZERO WL 1000

SYS 20W | 230V | 3000K  
1400lm | CRI>80

- 140-a035011000101 weiß
- 140-a035211000101 Blattgold
- 140-a035221000101 chrom
- 140-a035231000101 Blattsilber
- 140-a035241000101 Blattkupfer

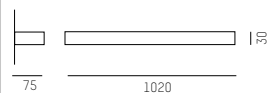

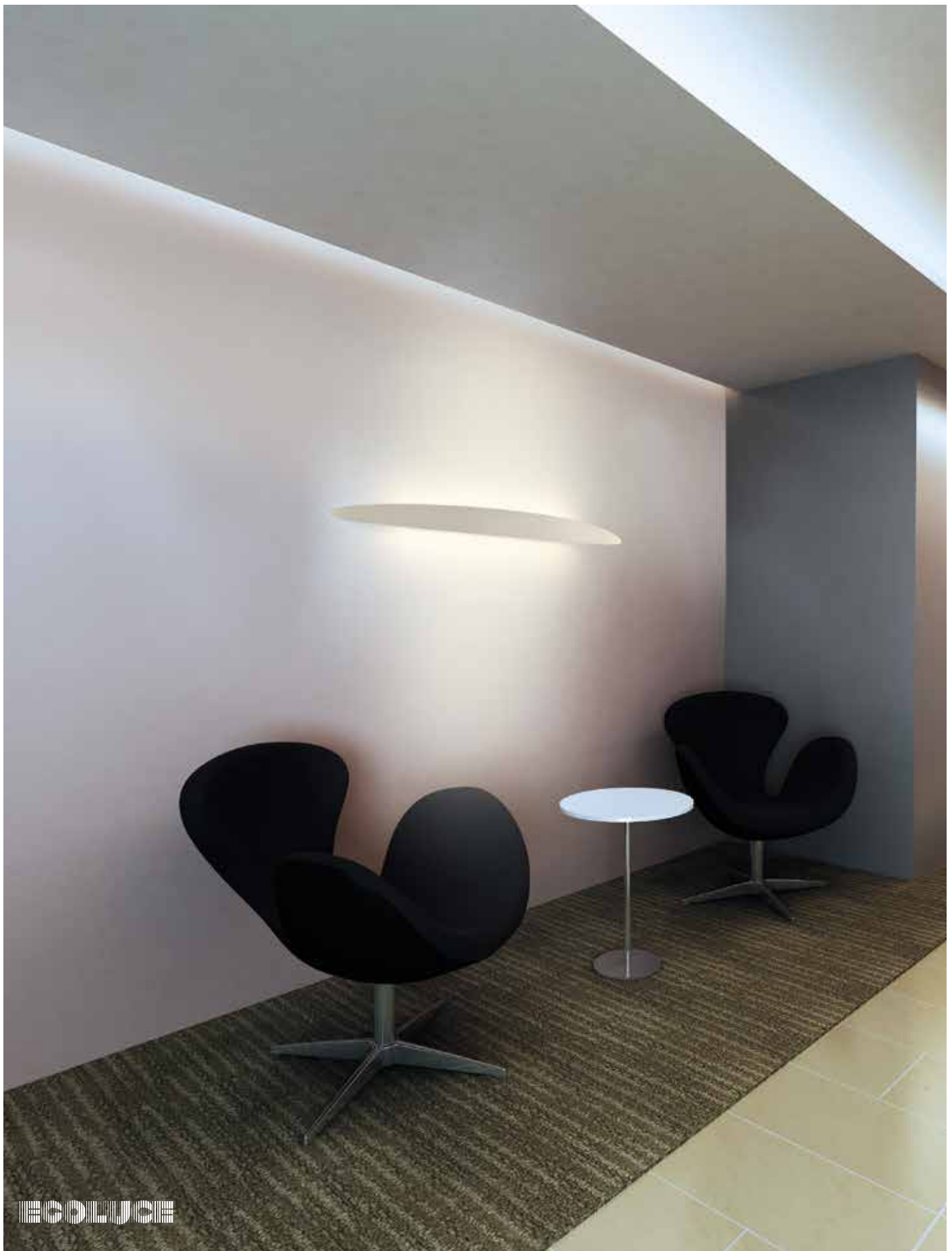



LEDLUS

CI

Serie großer Wandleuchten mit indirekter Lichtverteilung. Die Struktur aus Aluminium sind mit leistungsstarken linearen LED Modulen der neuesten Generation ausgestattet. inkl. integriertem LED-Konverter. Erhältlich in weiß oder schwarz.

A++ - A  
IP20  

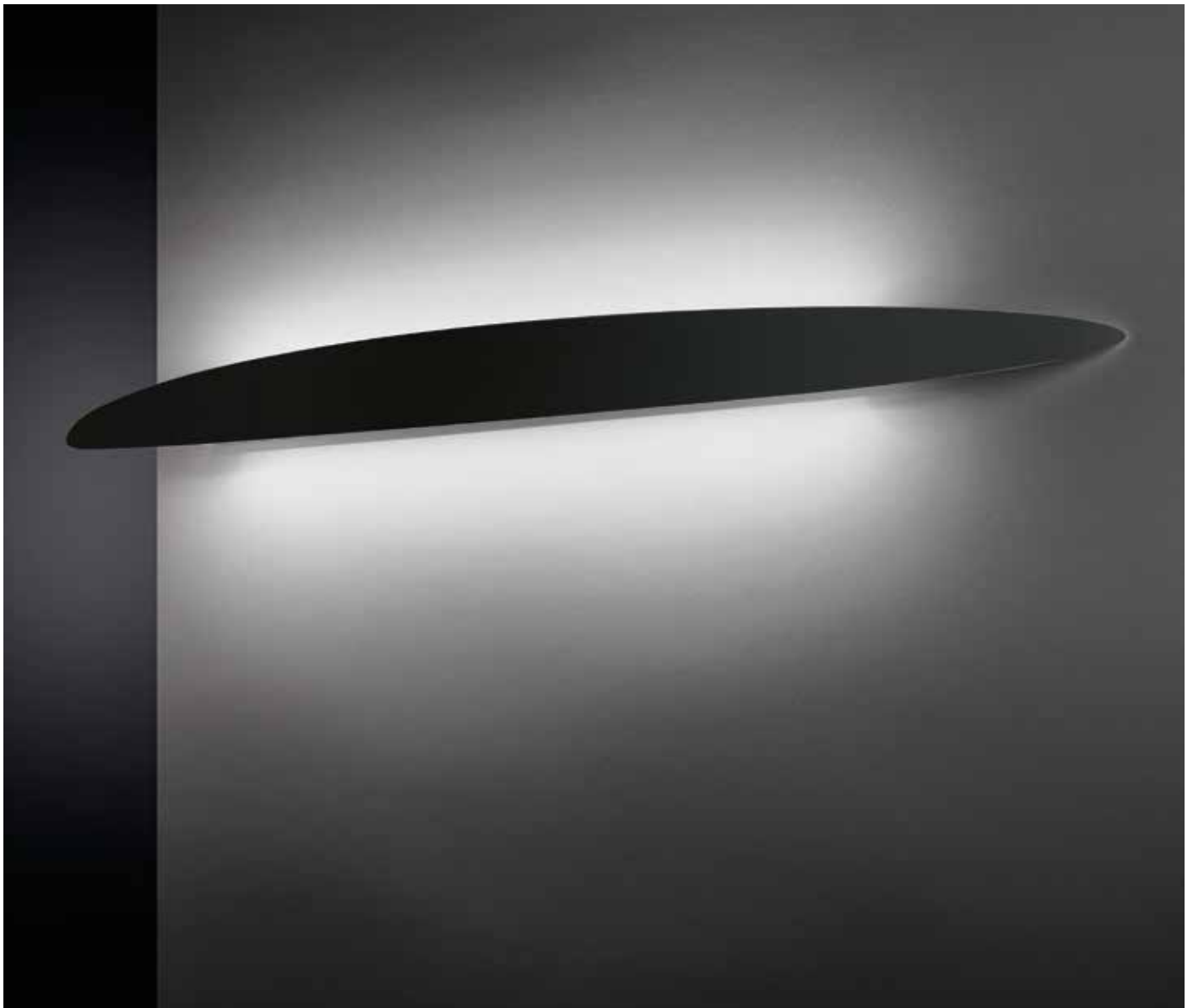

### CI S

SYS 12,5W | 230V | 3000K  
1502lm

**68-457401ww** weiß  
**68-457402ww** schwarz

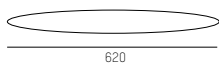

620



85

### CI M

SYS 25W | 230V | 3000K  
3004lm

**68-457501ww** weiß  
**68-457502ww** schwarz

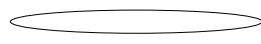

920



95

### CI L

SYS 37,5W | 230V | 3000K  
4506lm

**68-457601ww** weiß  
**68-457602ww** schwarz

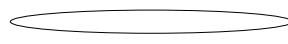

1220



100

### CI XL

SYS 50W | 230V | 3000K  
6008lm

**68-457701ww** weiß  
**68-457702ww** schwarz

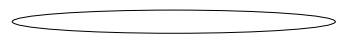

1520



110



# CLIP

Wandleuchte aus Metall,  
in verschiedenen Farben erhältlich.  
Mini-Version mit Diffuser aus Pirexglas  
sandgestrahlt.

A++ - E  
IP20  



## CLIP AP2 SMALL

2 x E27 | 230V | max. 42W

669-014166	weiß
669-031361	chrom
669-088266	gold
669-088273	silber

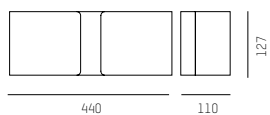

## CLIP AP2 MINI

2 x G9 | 230V | max. 28W | inkl. LM

669-049236	weiß
669-049229	chrom
669-091129	gold
669-091136	silber

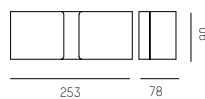





Brand  
MOLTO LUCE®

## ALICA

SYS 7W | 230V | 3000K | CRI>80

472-291017w	weiß	490lm
472-291017b	schwarz	260lm
472-291017bg	schwarz/gold	375lm
472-291017g	grau	310lm
472-291017a	Aluminium	390lm

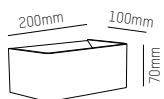

# ALICA

Wandleuchte, Aluminium, pulverbeschichtet oder lackiert, direkt/indirekt strahlend, inkl. Konverter

A++ → A  
IP20



## TAKE

1 x G9 | 230V | max. 33W

472-291009w	weiß
472-291009b	schwarz
472-291009s	grau
472-291009a	Aluminium

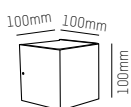

# TAKE

Wandleuchte, Aluminium, pulverbeschichtet oder lackiert, direkt/indirekt strahlend

A++ - E  
IP20  



Brand  
MOLTO LUCE®

## BO SINGLE

SYS 5,2W | 230V | 3000K | CRI>90

472-0080490003005 weiß 300lm  
472-0080490003006 schwarz 185lm

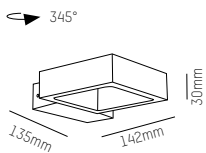

## BO DOUBLE

SYS 2 x 5,2W | 230V | 3000K | CRI>90

472-0090890003005 weiß 2 x 298lm  
472-0090890003006 schwarz 2 x 175lm

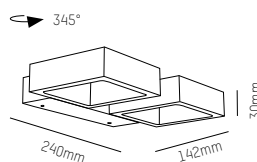

# BO

Wandleuchte, Aluminium, weiß oder schwarz pulverbeschichtet, direkt/indirekt strahlend, Leuchtenkopf 345° drehbar, inkl. Konverter

A+ → A  
IP20



## NOVEL

SYS 7,7W | 230V | 2700K | CRI>80 | TRIAC dimm.

472-29100427wtr	weiß	359lm
472-29100427btr	schwarz	132lm
472-29100427bgtr	schwarz/gold	189lm
472-29100427str	grau	168lm
472-29100427atr	Aluminium	263lm

SYS 7,7W | 230V | 3000K | CRI>80 | TRIAC dimm.

472-29100430wtr	weiß	399lm
472-29100430btr	schwarz	147lm
472-29100430bgtr	schwarz/gold	210lm
472-29100430str	grau	187lm
472-29100430atr	Aluminium	292lm

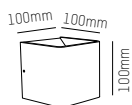

# NOVEL

Wandleuchte, Aluminium lackiert oder pulverbeschichtet, direkt/indirekt strahlend, inkl. Konverter TRIAC Dimmbar

A+ → A  
IP20  

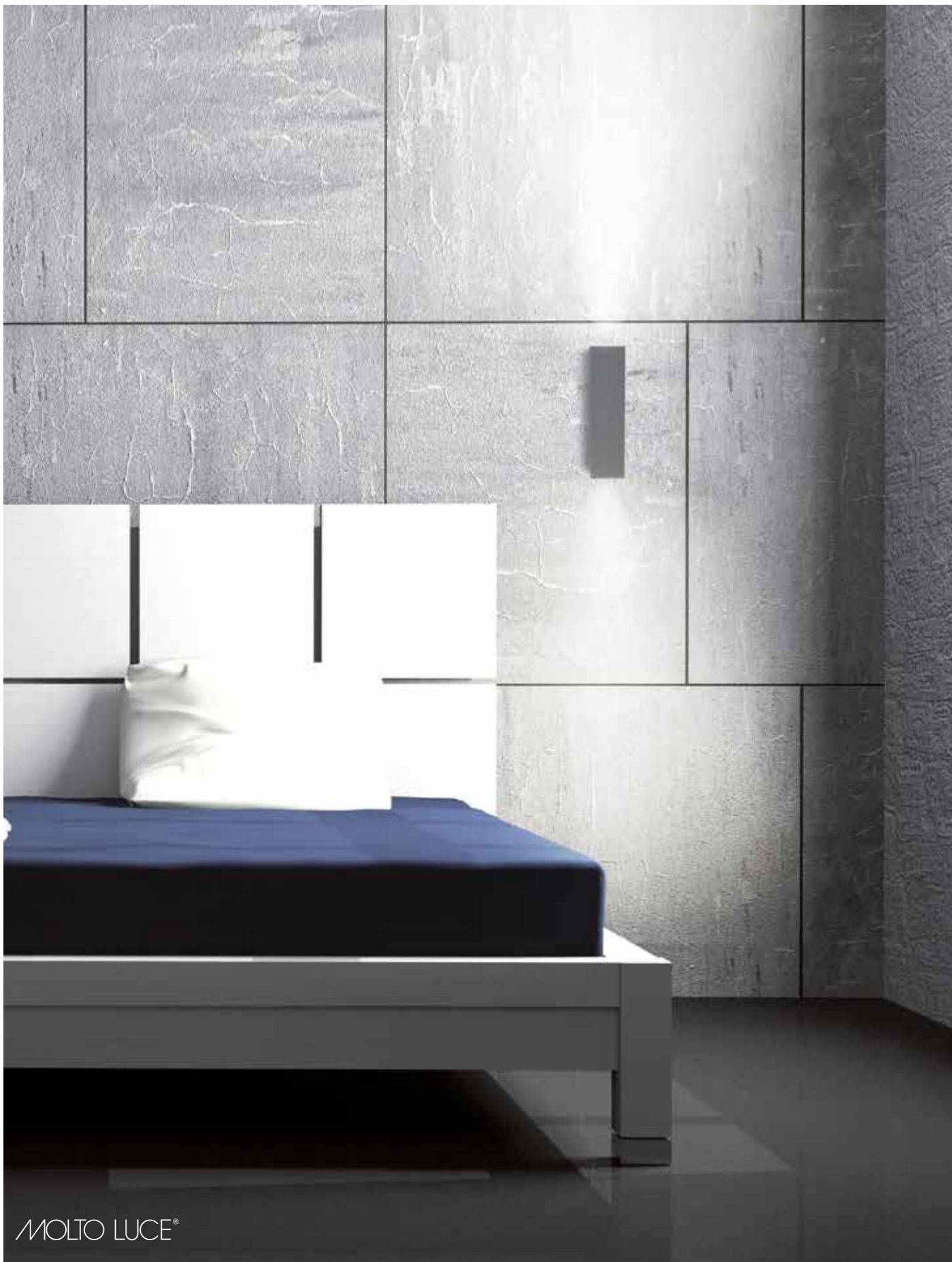

MOLTO LUCE®

# KUBIK

Kubische LED Wandleuchte aus Aluminium mit Oberfläche weiß oder perlchrom lackiert, hochwertige Glaslinsen 60° klar, Abstrahlung mit Direkt- und Indirektanteil. Auf Anfrage auch mit 12° oder 30° Glaslinse erhältlich.

A++ - A  
IP20  

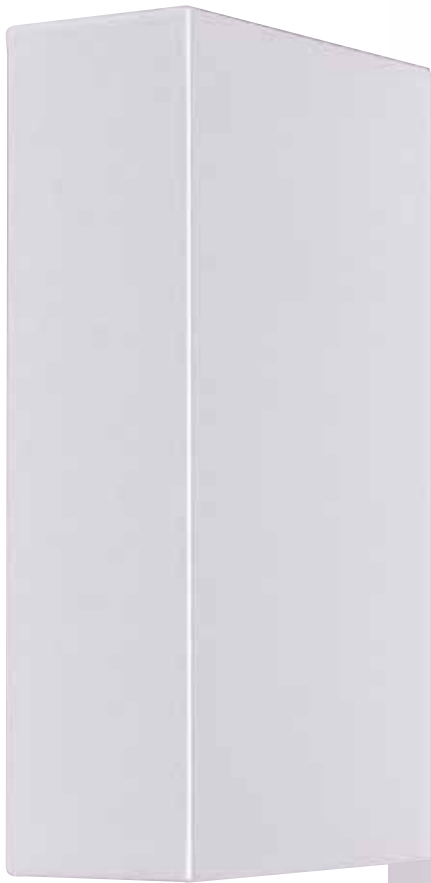

## KUBIK WL

SYS 4W | 230V | 3000K  
224lm | CRI>80

**56-4035ng1** Perlchrom  
**56-4036ng1** weiß

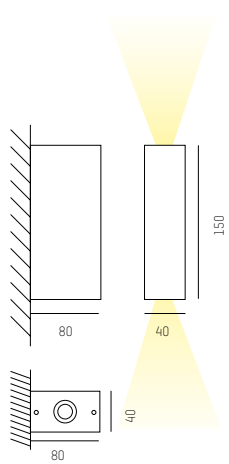



# MOONLIGHT

Wand- / Deckenleuchte mit indirektem Lichtaustritt. Die MDF-Scheibe kann mit Wand- und Deckenfarbe gestrichen werden. Gestell aus Aluminium, Innendiffusor aus opalen Polycarbonat.

A+ → A  
IP 40  

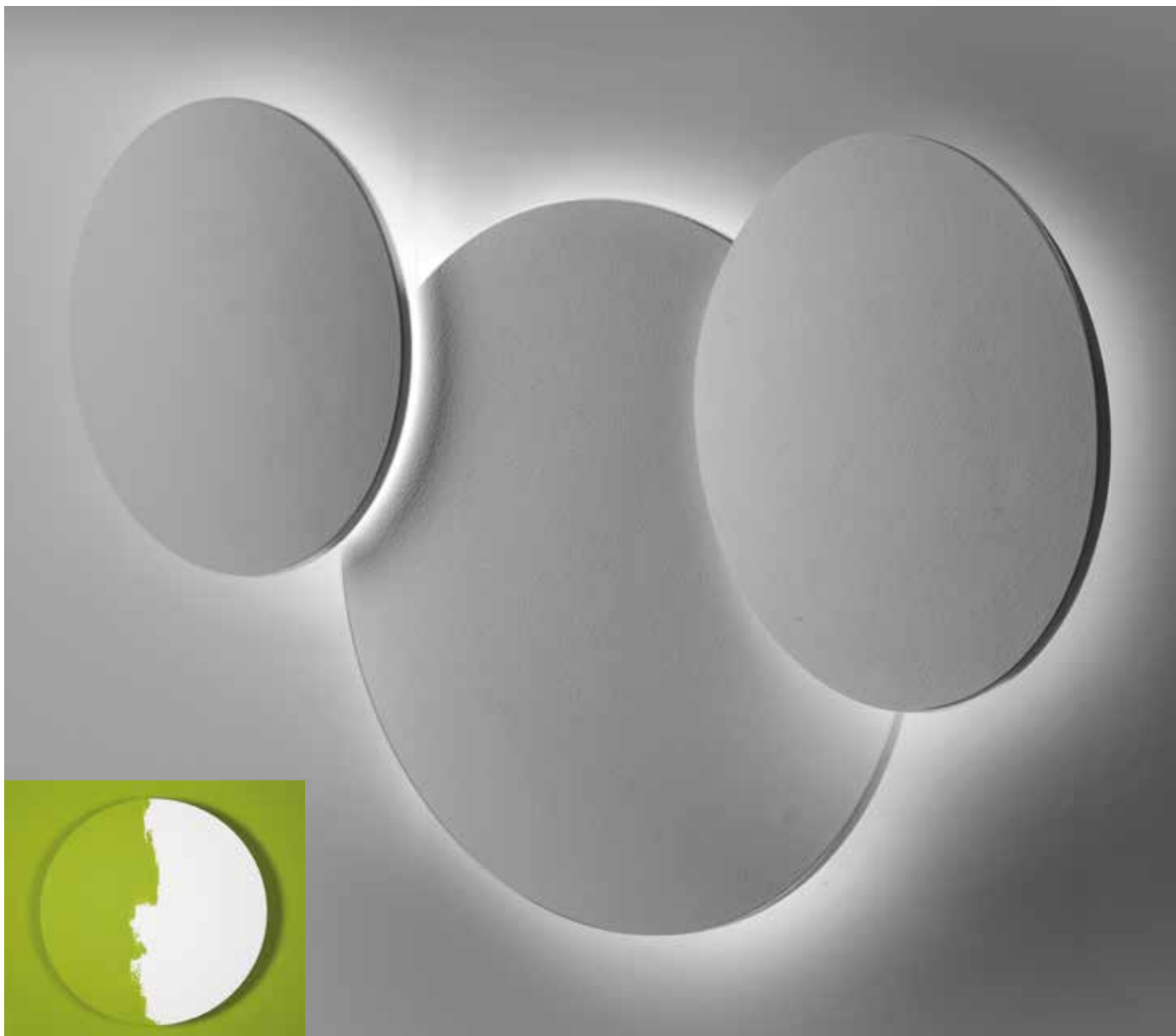

### MOONLIGHT S

SYS 18W | 230V | 3000K  
2380lm

**68-458201ww** weiß

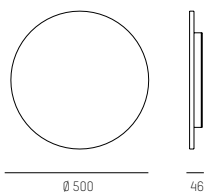

### MOONLIGHT L

SYS 28,5W | 230V | 3000K  
2895lm

**68-458301ww** weiß

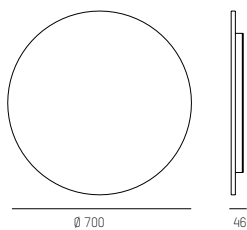

### MOONLIGHT KIT

für überlappende Anwendungen

**68-0963** weiß

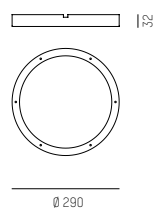







LEDUCE

# LANCIA

Ausrichtbare Wandleuchten mit Struktur aus weiß lackiertem Aluminium und Diffusor aus satiniertem Acrylglas. Ausgestattet mit CRI >90 LED-Modulen, um die optimale Farbwiedergabe bei der Beleuchtung von Bildern zu erzielen.

A+ → A  
IP20  



## LANCIA S

SYS 9W | 230V | 3000K | 1190lm  
CRI 90

68-456701ww    weiß  
68-456731ww    chrom

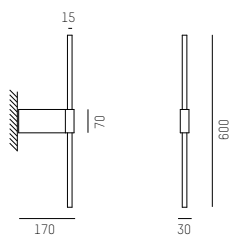

## LANCIA M

SYS 18W | 230V | 3000K | 2380lm  
CRI 90

68-456801ww    weiß  
68-456831ww    chrom

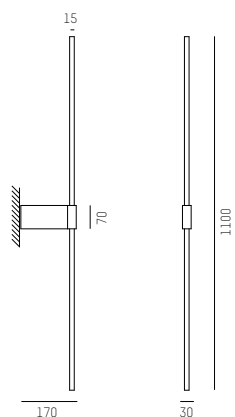

## LANCIA L

SYS 16,5W | 230V | 3000K | 2182lm  
CRI 90

68-456901ww    weiß  
68-456931ww    chrom

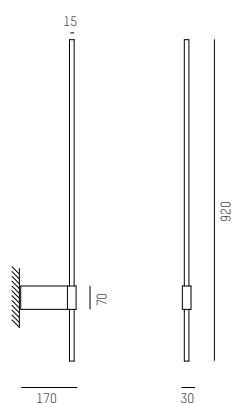



Vesoi

# PIC

Schwenkbare Wandleuchte in zwei verschiedenen Größen, Oberfläche weiß oder schwarz lackiert, inkl. LED Konverter

A++ → A  
IP44  



### PIC 45 SP

SYS 10W | 230V | 2700K  
720lm | CRI>80

264-sp00567    weiß  
264-sp00568    schwarz

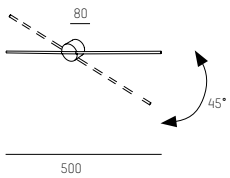

### PIC 90 SP

SYS 20W | 230V | 2700K  
1440lm | CRI>80

264-sp00571    weiß  
264-sp00572    schwarz

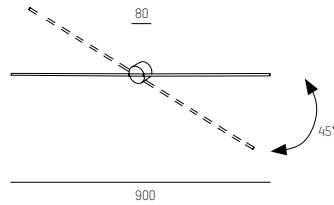



MOLTO LUCE®

Design: A. Storz

# SPOSA

Dekorative organisch geformte Aufbauleuchte mit Diffusor aus satiniertem Polycarbonat, Trägerprofil aus extrudiertem Aluminium, Variante in Schutzart IP44 geeignet für Nassräume

A++ - A

IP20/IP44  



## SPOSA

SYS 15W | 230V | 3000K  
1610lm | CRI>80

520-0698 weiß opal

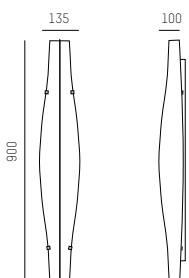

## SPOSA IP44

SYS 15W | 230V | 3000K  
1350lm | CRI>80

520-0598 weiß opal

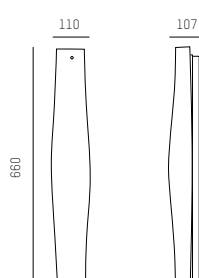

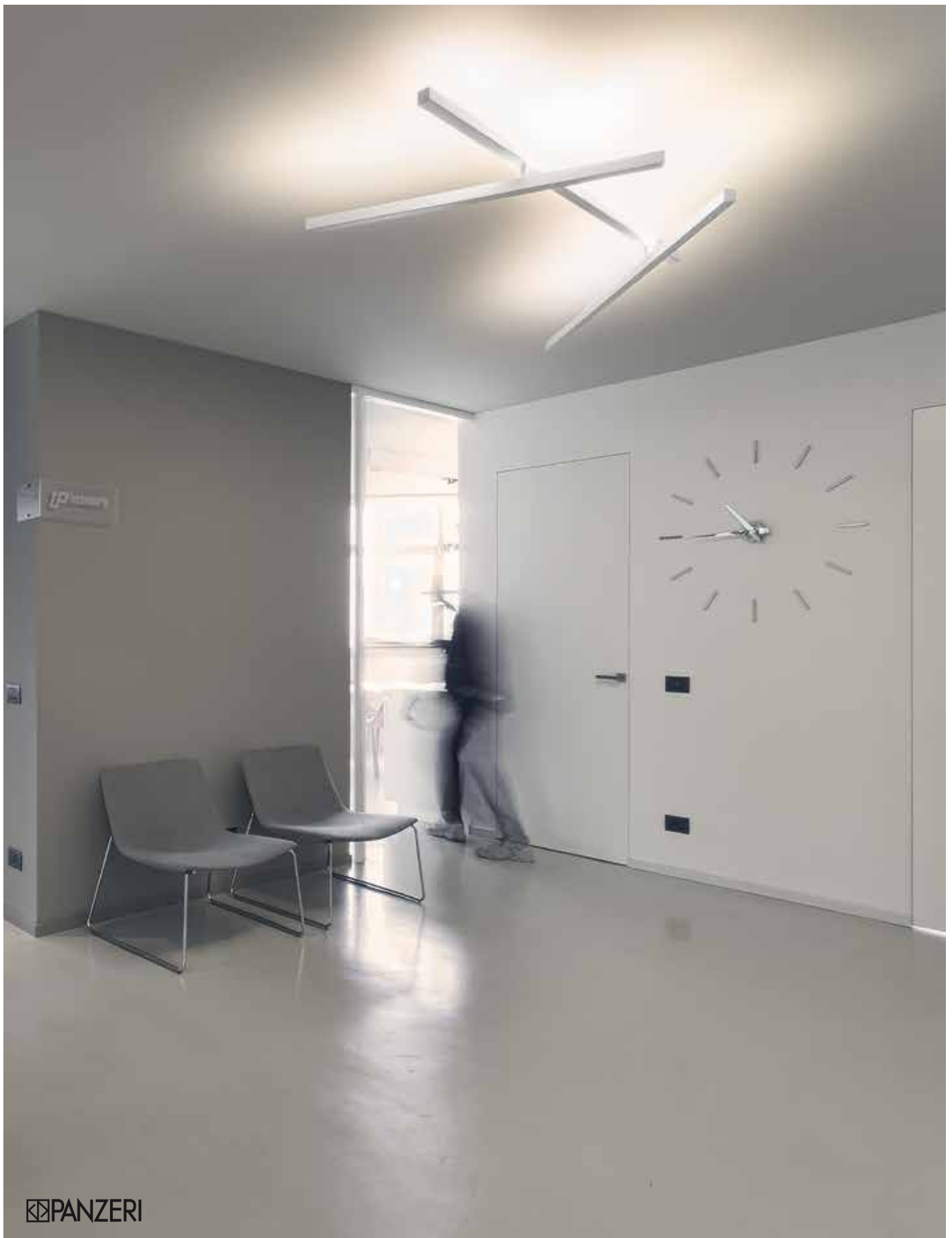



 PANZERI

Design: Carmen Ferrara

# CARMEN

Indirekt strahlende LED-Deckenleuchte aus Metall. Drei Leuchtenarme jeweils um 350° drehbar, in den Farben weiß oder schwarz verfügbar, inkl. Konverter

 A++ - A  
IP20  



Variationsbeispiele  
CARMEN DL:

### CARMEN DL

SYS 56W | 230V | 3000K  
5111lm | CRI>80  
1-10V/Push dimm.

**140-p064010030103** weiß  
**140-p064020030103** schwarz

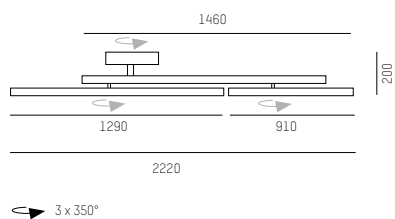

### CARMEN WL/DL

SYS 28,5W | 230V | 3000K  
2375lm | CRI>80

**140-p064010020101** weiß  
**140-p064020020101** schwarz

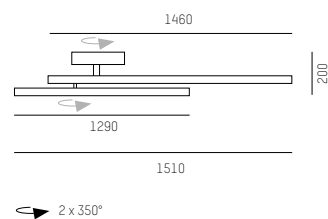

### CARMENCITA WL

SYS 13W | 230V | 3000K  
967lm | CRI>80

**140-a064010000101** weiß  
**140-a064020000101** schwarz

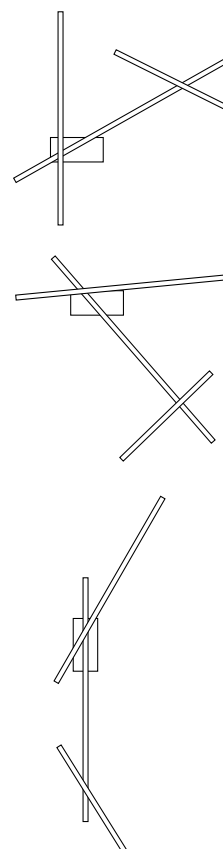
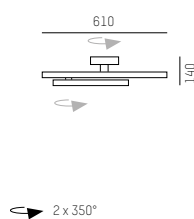



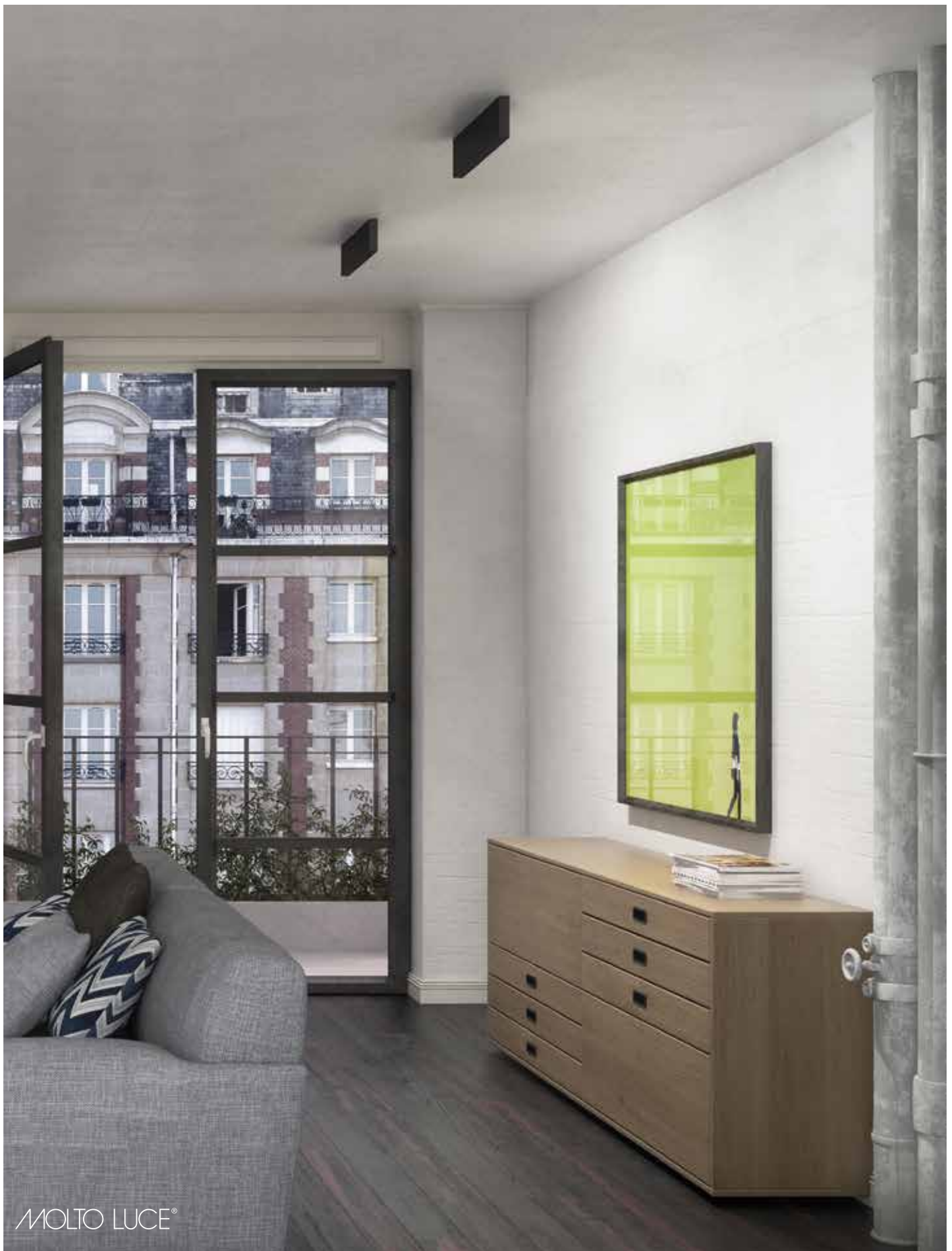

MOLTO LUCE®

# AKON

LED Aufbauleuchte aus Aluminium, eloxiert oder weiß oder schwarz pulverbeschichtet, asymmetrischer mikrofacettierter Freiformflächenreflektor, gleichmäßiges Licht mit sehr guter Längsentblendung, RDB asymmetrischer Reflektor von Bartenbach

A++ - A

IP20  



### AKON 1 WL/DL

SYS 9W | 230V | 2700K | 430lm | CRI>80

**661-1090135** weiß  
**661-1090136** schwarz

SYS 9W | 230V | 3000K | 453lm | CRI>80

**661-1090195** weiß  
**661-1090196** schwarz

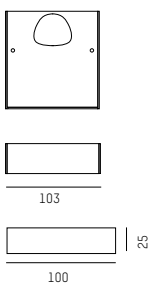

### AKON 2 WL/DL

SYS 15W | 230V | 2700K | 860lm | CRI>80

**661-2150135** weiß  
**661-2150136** schwarz

SYS 15W | 230V | 3000K | 906lm | CRI>80

**661-2150195** weiß  
**661-2150196** schwarz

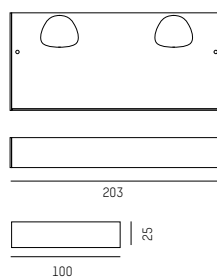

### AKON 4 WL/DL

SYS 28W | 230V | 2700K | 1720lm | CRI>80

**661-3280135** weiß  
**661-3280136** schwarz

SYS 28W | 230V | 3000K | 1812lm | CRI>80

**661-3280195** weiß  
**661-3280196** schwarz

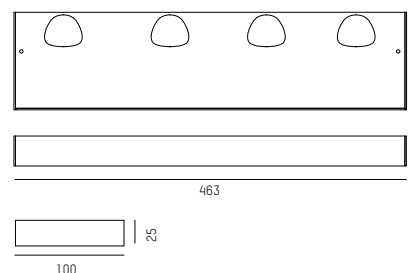

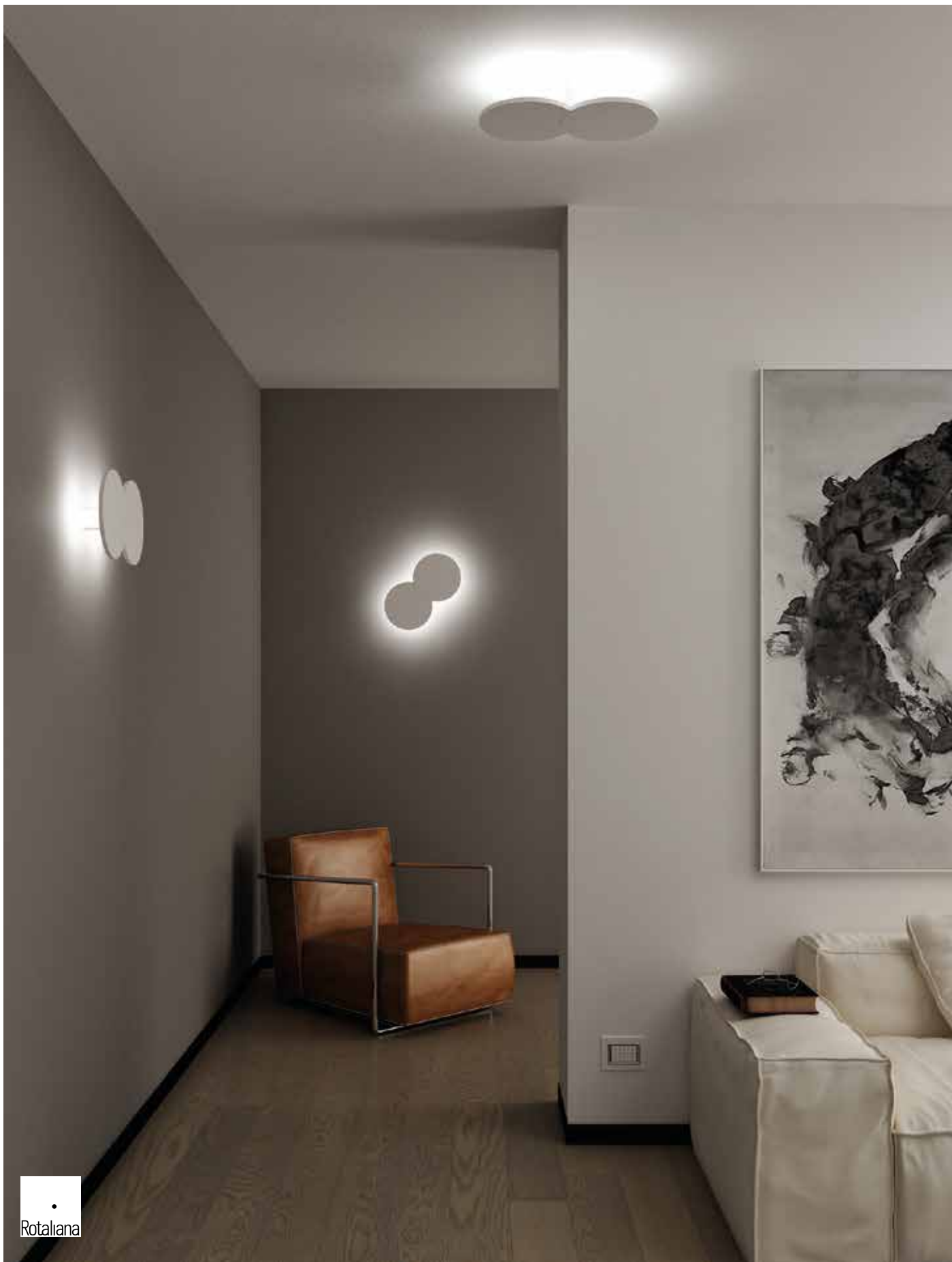

Design: Paolo Dell'Elce

# COLLIDE

Wand- / Deckenleuchten aus Metall. In den Farben weiß matt oder champagner

A++ - A  
IP20

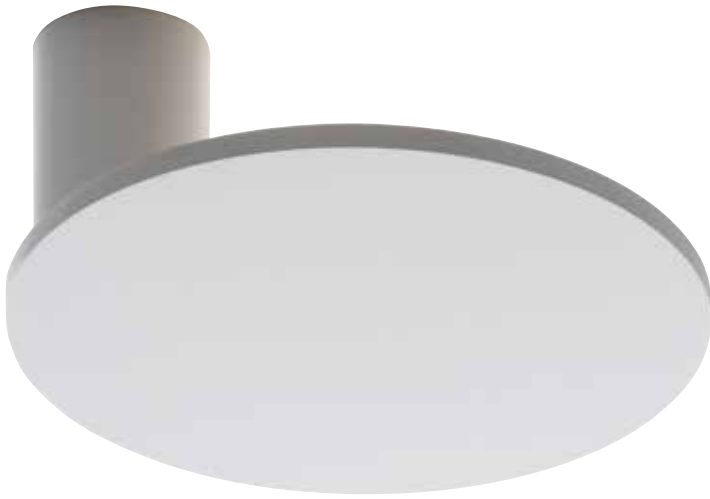

## COLLIDE I

SYS 18W | 230V | 1400lm

LED 2700K

**895-1cdh000063z11** weiß matt  
**895-1cdh000065z11** champagner

LED 3000K

**895-1cdh000063z10** weiß matt  
**895-1cdh000065z10** champagner

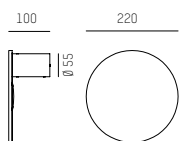

## COLLIDE II

SYS 35W | 230V | 2650lm

LED 2700K

**895-1cdh100063z11** weiß matt  
**895-1cdh100065z11** champagner

LED 3000K

**895-1cdh100063z10** weiß matt  
**895-1cdh100065z10** champagner

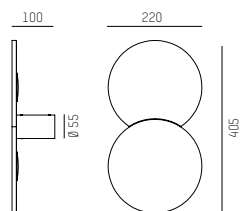



 PANZERI

# KUBIK

Wand- Deckenleuchten mit Struktur aus Aluminium  
in graumetallic und mundgeblasenem Glas opal,  
inkl. LED Konverter

A++ - A  
IP 40  



### KUBIK WL 110

SYS 9,5W | 230V | 3000K  
667lm | CRI>80

140-a070010110101 weiß opal

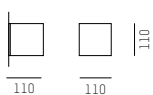

### KUBIK WL 140

SYS 13W | 230V | 3000K  
954lm | CRI>80

140-a070010140101 weiß opal

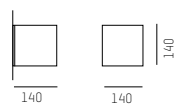



MOLTO LUCE®

Design: Serge & Robert Cornelissen

# FOAM

Organisch geformte dreiteilige LED Aufbauleuchte mit Diffusoren aus Polyethylen, Treiber-Abdeckung verchromt Wand- oder Deckenmontage möglich Kombination mehrerer Leuchten als kreative Variante Energieeffiziente LEDs, optional dimmbar

A+ → A  
IP20  



**FOAM**

SYS 33W | 230V | 3000K  
2070lm | CRI>80

598-110191 chrom/weiß opal

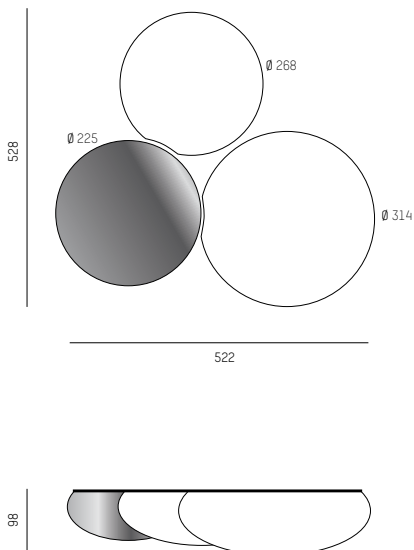



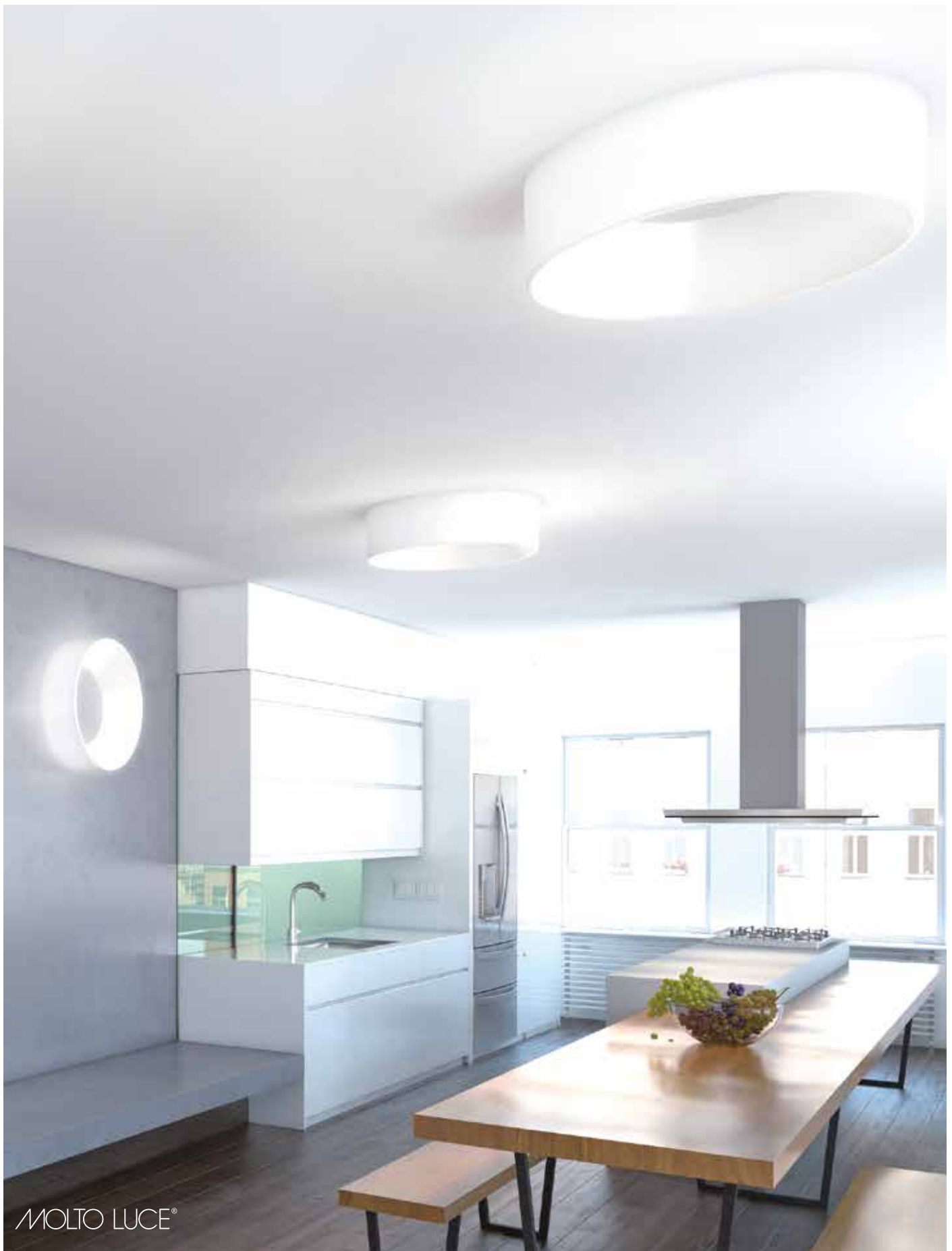

Design: Serge & Robert Cornelissen

# GATOR

Dekorative LED Aufbauleuchte in 2 Größen, Diffusoren aus Polyethylen, Dekoplatte aus Aluminium, Wand- oder Deckenmontage möglich, Dekoplatte in Wandfarbe lackierbar, Variante mit Spiegel

A++ - A  
IP20  



## GATOR S

SYS 22W | 230V | 3000K  
1790lm | CRI>80

**614-110195** weiß / weiß opal  
**614-110190** Spiegel / weiß opal

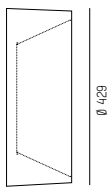

162

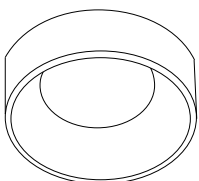

## GATOR M

SYS 34W | 230V | 3000K  
2720lm | CRI>80

**614-120195** weiß / weiß opal  
**614-120190** Spiegel / weiß opal

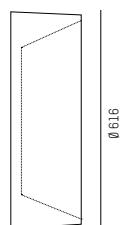

187

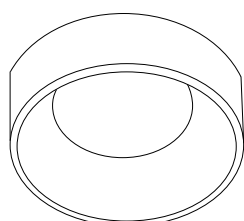





LEDLUCI

# ALEA

Wand- und Deckenleuchten aus Aluminium  
in verschiedenen Farben. inkl LED Konverter

A++ - A  
IP20  



## ALEA DL

SYS 6,5W | 230V | 2700K | 844lm

**68-556101xw** weiß  
**68-556102xw** schwarz

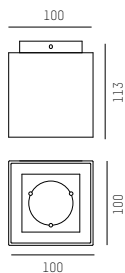

## ALEA WL

SYS 6,5W | 230V | 2700K | 844lm  
**direkt/indirekt strahlend**

**68-456101xw** weiß  
**68-45610229xw** schwarz/gold  
**68-456135xw** sand  
**68-45613101xw** chrom/weiß

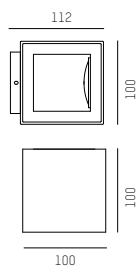

## ALEA WL ABDECKPLATTE

Einsatz für einseitigen Lichtaustritt  
(separat ordern)

**68-018201** weiß  
**68-018202** schwarz  
**68-018235** sand





# U BRASS

Wand-/ Deckenleuchte aus Metall,  
Messing oder Brüniert,  
inkl. LED Leuchtmittel, nicht dimmbar

A++ → A  
IP20 



### U BRASS 55 SP

1 x s14d | 6W | 230V | 2700K  
450lm | CRI>80

**264-sp00419** Altmessing  
**264-sp00420** brüniert

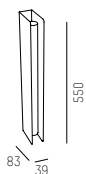

### U BRASS 105 SP

2 x s14d | 6W | 230V | 2700K  
450lm | CRI>80

**264-sp00416** Altmessing  
**264-sp00415** brüniert

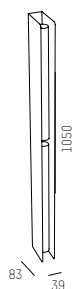





MOLTO LUCE®

# TURN ON

Runde LED Aufbauleuchte aus Aluminium mit Feinstrukturlack in schwarz oder weiß, satinierter zurückgesetzter Diffusor aus PMMA, Dekor-Innenring in schwarz, weiß oder gold

A++ - A  
IP20  



### TURN ON AC 110 DL

SYS 10W | 230V | 2700K | 400lm | CRI>80

	1	2
597-1101355	weiß	weiß
597-1101356	weiß	schwarz
597-1101353	weiß	gold
597-1101365	schwarz	weiß
597-1101366	schwarz	schwarz
597-1101363	schwarz	gold

SYS 10W | 230V | 3000K | 400lm | CRI>80

	1	2
597-1101955	weiß	weiß
597-1101956	weiß	schwarz
597-1101953	weiß	gold
597-1101965	schwarz	weiß
597-1101966	schwarz	schwarz
597-1101963	schwarz	gold

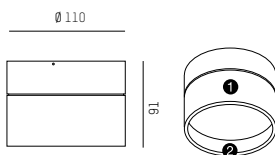

### TURN ON AC 150 DL

SYS 15W | 230V | 2700K | 710lm | CRI>80

	1	2
597-2201355	weiß	weiß
597-2201356	weiß	schwarz
597-2201353	weiß	gold
597-2201365	schwarz	weiß
597-2201366	schwarz	schwarz
597-2201363	schwarz	gold

SYS 15W | 230V | 3000K | 710lm | CRI>80

	1	2
597-2201955	weiß	weiß
597-2201956	weiß	schwarz
597-2201953	weiß	gold
597-2201965	schwarz	weiß
597-2201966	schwarz	schwarz
597-2201963	schwarz	gold

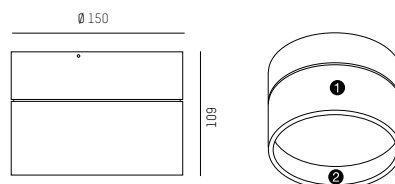



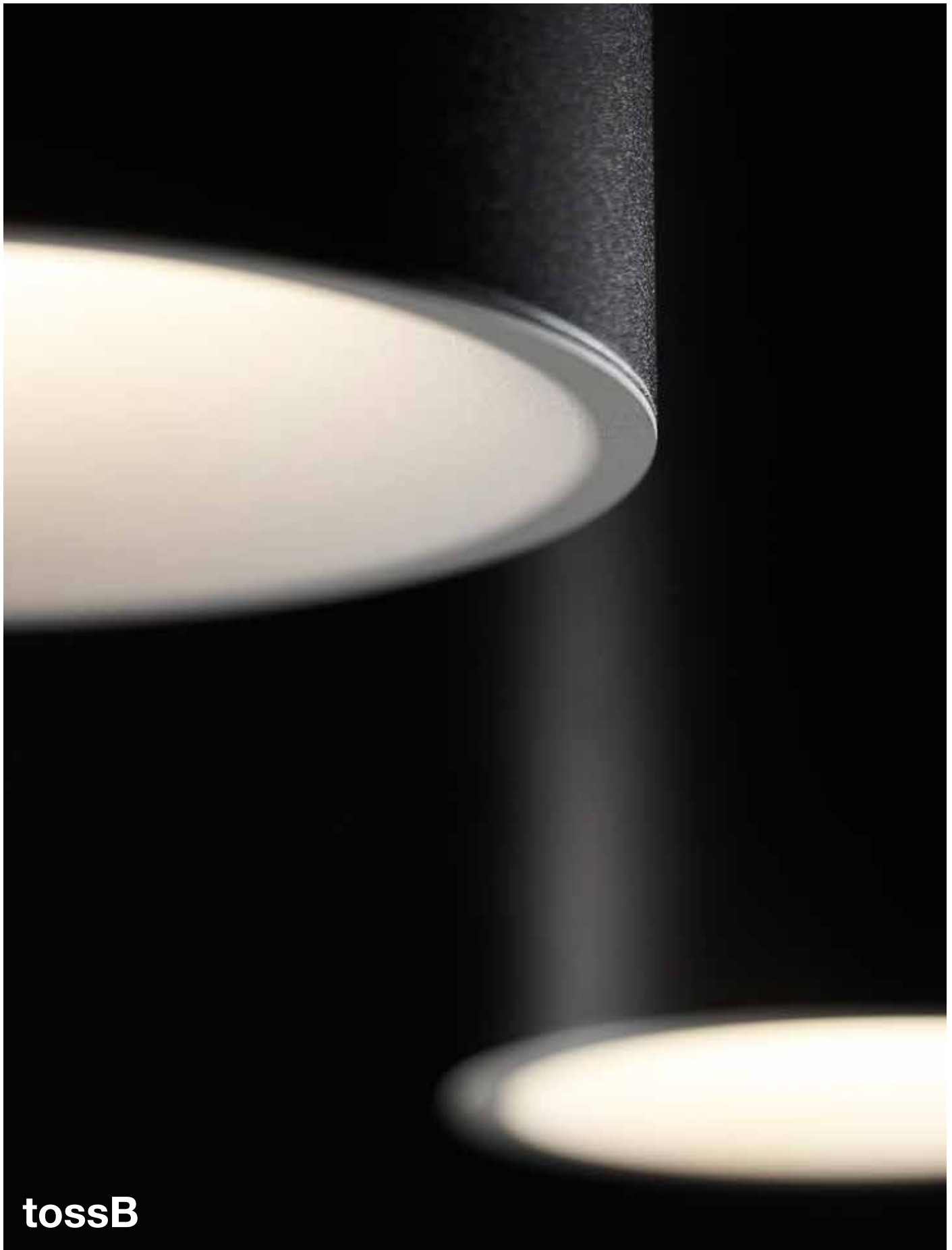

**tossB**

# TUBA

Deckenleuchten aus Aluminium pulverbeschichtet  
in drei Größen, opaler Diffuser, inkl. TRIAC dimmba-  
rem LED Konverter

A+ → A  
IP20  



### TUBA S

SYS 13W | 230V | 2700K | 984lm

699-t95c1dwl    weiß  
699-t95c1dzl    schwarz

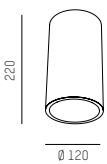

### TUBA M

SYS 13W | 230V | 2700K | 984lm

699-t95c2dwl    weiß  
699-t95c2dzl    schwarz

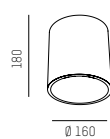

### TUBA L

SYS 13W | 230V | 2700K | 984lm

699-t95c3dwl    weiß  
699-t95c3dzl    schwarz

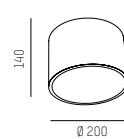



### ARIK SHORT

SYS 11W | 230V | 3000K  
360lm | CRI>80

472-260029 weiß  
472-260030 schwarz

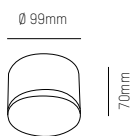

### ARIK LONG

SYS 11W | 230V | 3000K  
360lm | CRI>80

472-260031 weiß  
472-260032 schwarz

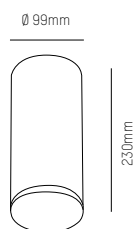

# ARIK

Aufbauleuchte, Aluminium gefräst, weiß oder schwarz pulverbeschichtet, zylindrisch, Acryldiffusor matt satiniert, inkl. Konverter

A+ → A  
IP20  



## CARMi AC

SYS 10W | 230V | 3000K | CRI>80

472-260039ng1	weiß/weiß	989lm
472-260040ng1	schwarz/schwarz	814lm
472-260041ng1	schwarz/gold	786lm

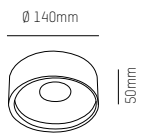

Brand  
MOLTO LUCE®

# CARMi

LED Aufbauleuchte, Aluminium gefräst,  
Oberflächen pulverbeschichtet, zylindrisch,  
AC-LED

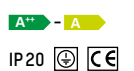



## BROOK SQUARE

### REFLEKTOR 38° FLOOD

SYS 11W | 230V | 3000K  
974lm | CRI>80

- 472-260036ng1 weiß/schwarz
- 472-260037ng1 schwarz/schwarz
- 472-260038ng1 schwarz/gold

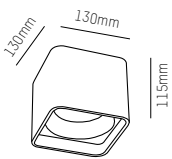

## BROOK ROUND

### REFLEKTOR 38° FLOOD

SYS 11W | 230V | 3000K  
930lm | CRI>80

- 472-260033ng1 weiß/schwarz
- 472-260034ng1 schwarz/schwarz
- 472-260035ng1 schwarz/gold

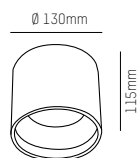

# BROOK

Aufbauleuchte aus Aluminium gefräst  
Weiß/schwarz, schwarz/schwarz oder  
schwarz/gold pulverbeschichtet,  
AC LED

A+ → A  
IP20  



### QANA BOX I

1 x GU10 | 230V | max. 35W

- 472-258951w weiß
- 472-258951b schwarz
- 472-258951s silber

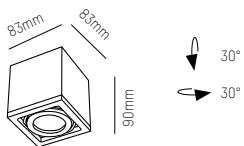

### QANA BOX II

2 x GU10 | 230V | max. 35W

- 472-258952w weiß
- 472-258952b schwarz
- 472-258952s silber

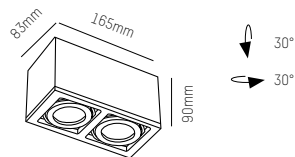

# QANA

Aufbauleuchte aus Aluminium,  
Dreh- und schwenkbar

A++ - D  
IP20



Brand  
**MOLTO LUCE®**

# AEON

Runde LED Aufbauleuchte aus Aluminium gefräst, weiß matt oder schwarz matt Feinstruktur pulverbeschichtet, inkl. Konverter  
Version AEON BIG: DALI dimmbar

A++ → A  
IP20  



## AEON SMALL SQUARE

### REFLEKTOR 45° FLOOD

SYS 6,2W | 230V | 2700K  
496lm | CRI>80

**305-602427w** weiß  
**305-602427b** schwarz

SYS 6,2W | 230V | 3000K  
522lm | CRI>80

**305-602430w** weiß  
**305-602430b** schwarz

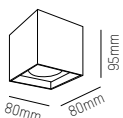

## AEON BIG SQUARE

### REFLEKTOR 50° FLOOD

SYS 15,3W | 230V | 2700K  
1280lm | CRI>80 | DALI Dimm.

**305-604427wddd** weiß  
**305-604427bddd** schwarz

SYS 15,3W | 230V | 3000K  
1350lm | CRI>80 | DALI Dimm.

**305-604430wddd** weiß  
**305-604430bddd** schwarz

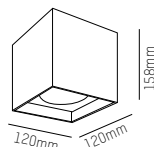

## AEON SMALL ROUND

### REFLEKTOR 45° FLOOD

SYS 6,2W | 230V | 2700K  
496lm | CRI>80

**305-602527w** weiß  
**305-602527b** schwarz

SYS 6,2W | 230V | 3000K  
522lm | CRI>80

**305-602530w** weiß  
**305-602530b** schwarz

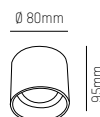

## AEON BIG ROUND

### REFLEKTOR 50° FLOOD

SYS 15,3W | 230V | 2700K  
1280lm | CRI>80 | DALI Dimm.

**305-604527wddd** weiß  
**305-604527bddd** schwarz

SYS 15,3W | 230V | 3000K  
1350lm | CRI>80 | DALI Dimm.

**305-604530wddd** weiß  
**305-604530bddd** schwarz

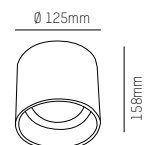





Vesoi

# TIPERCINQUE

Deckenleuchte aus Metall lackiert, mit schwenkbaren Armen

A++ - E  
IP20  



## TIPERCINQUE 60 PL

5 x E27 | 230V | max. 42W

264-pl01627 Messing/weiß

264-pl01629 Messing/schwarz

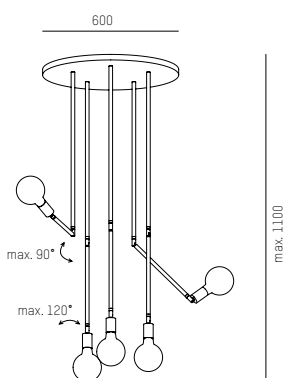

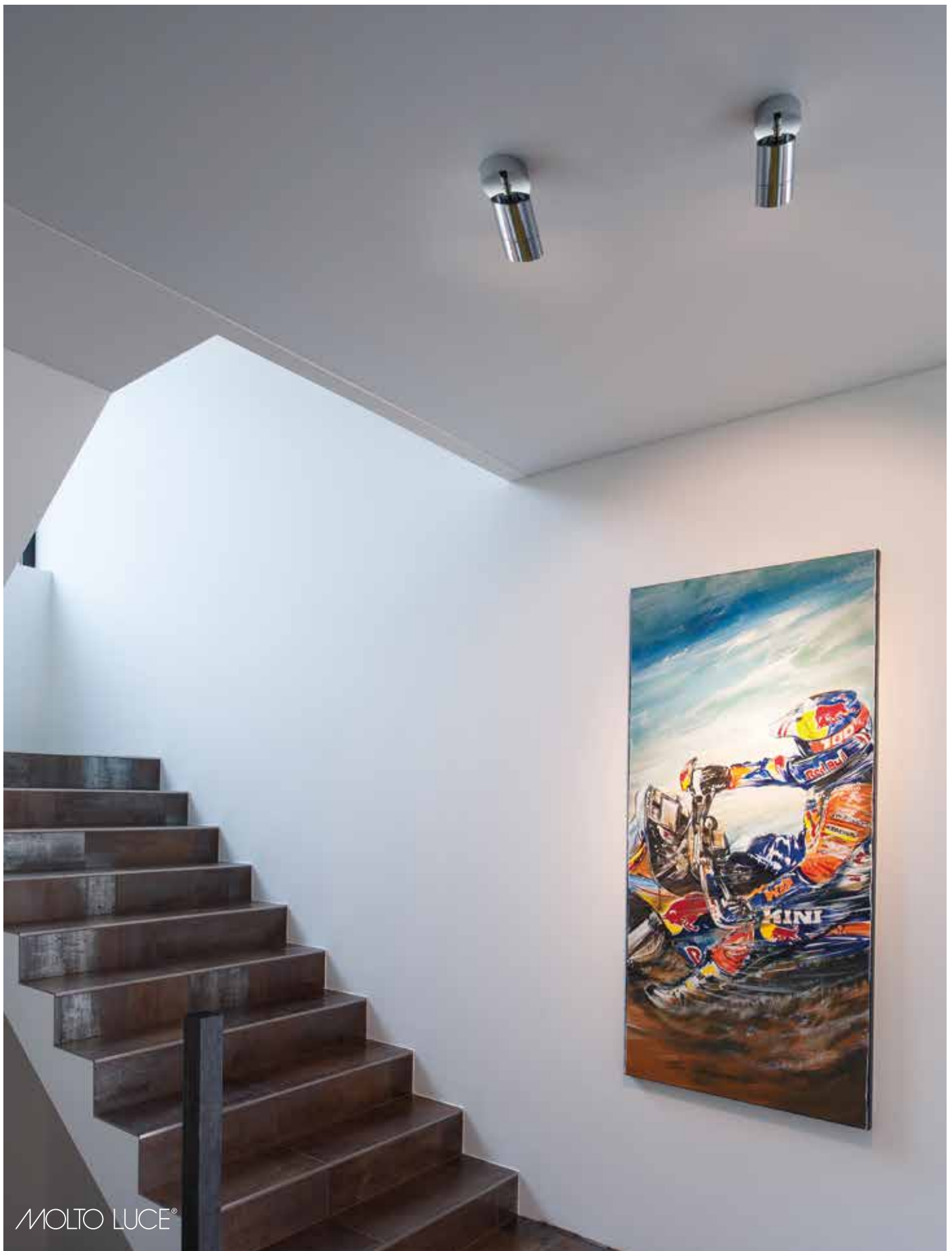



MOLTO LUCE®

# DASH L

HV-LED Strahler aus Aludruckguss mit Oberfläche in weiß, schwarz, silber matt oder chrom, vakuumbedampfter Alureflektor in 3 Ausstrahlwinkeln, Leuchtenkopf 350° drehbar und 90° schwenkbar, Dekorring in 3 Farben als Zubehör (DASH L)

A++ - A  
IP20  

## DASH L AC DL

SYS 11W | 230V | 2700K | 750lm | CRI>80  
Dekorring innen standard schwarz

### REFLEKTOR 20°

599-61401534ng2 silber matt  
599-61401535ng2 weiß  
599-61401536ng2 schwarz

### REFLEKTOR 38°

599-61401834ng2 silber matt  
599-61401835ng2 weiß  
599-61401836ng2 schwarz

SYS 11W | 230V | 3000K | 800lm | CRI>80

### REFLEKTOR 20°

599-61401594ng2 silber matt  
599-61401595ng2 weiß  
599-61401596ng2 schwarz

### REFLEKTOR 38°

599-61401894ng2 silber matt  
599-61401895ng2 weiß  
599-61401896ng2 schwarz

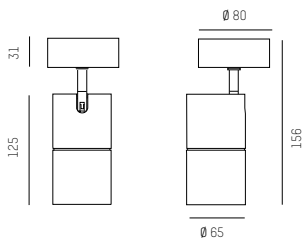

## DEKORRING FÜR DASH L

innenliegend, separat ordern

599-12 silber matt  
599-13 gold  
599-15 weiß

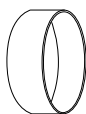

## DASH AC DL

SYS 11W | 230V | 2700K | 750lm | CRI>80

### REFLEKTOR 20°

599-31401531ng2 chrom  
599-31401534ng2 silber matt  
599-31401535ng2 weiß  
599-31401536ng2 schwarz

### REFLEKTOR 38°

599-31401831ng2 chrom  
599-31401834ng2 silber matt  
599-31401835ng2 weiß  
599-31401836ng2 schwarz

### REFLEKTOR 60°

599-31401931ng2 chrom  
599-31401934ng2 silber matt  
599-31401935ng2 weiß  
599-31401936ng2 schwarz

SYS 11W | 230V | 3000K | 800lm | CRI>80

### REFLEKTOR 20°

599-31401591ng2 chrom  
599-31401594ng2 silber matt  
599-31401595ng2 weiß  
599-31401596ng2 schwarz

### REFLEKTOR 38°

599-31401891ng2 chrom  
599-31401894ng2 silber matt  
599-31401895ng2 weiß  
599-31401896ng2 schwarz

### REFLEKTOR 60°

599-31401991ng2 chrom  
599-31401994ng2 silber matt  
599-31401995ng2 weiß  
599-31401996ng2 schwarz

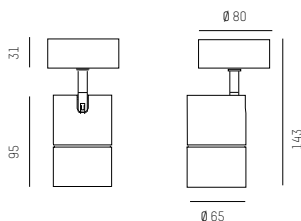

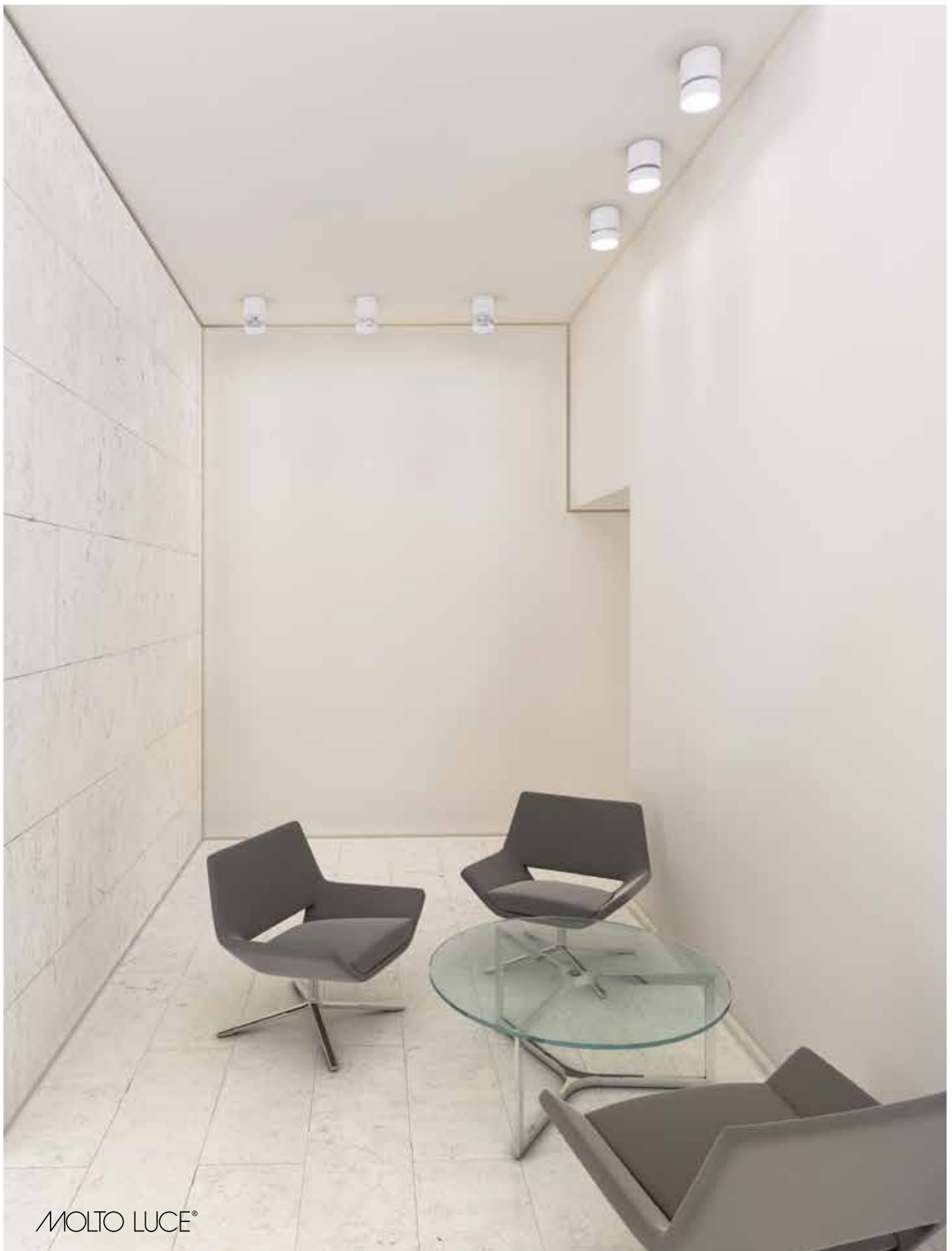

MOLTO LUCE®

# LITIN

Deckenaufbauleuchte aus Aludruckguss mit HV-LED mit Oberfläche in weiß, schwarz, silber matt oder chrom, satiniertes bündiger Diffusor aus PMMA, Leuchtenkopf 350° drehbar und 45° schwenkbar, Entblendungsring in zwei Ausführungen als Zubehör

A++ - A  
IP20  



## LITIN AC DL

SYS 10W | 230V | 2700K | 600lm | CRI>80

21-320131	chrom
21-320134	silber matt
21-320135	weiß
21-320136	schwarz

SYS 10W | 230V | 3000K | 600lm | CRI>80

21-320191	chrom
21-320194	silber matt
21-320195	weiß
21-320196	schwarz

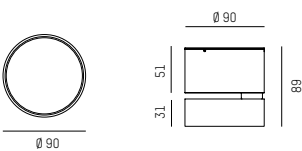

## ENTBLENDUNGSRING

schräg, mit Bajonettverschluss

21-42024	silber matt
21-42025	weiß
21-42026	schwarz

gerade, mit Bajonettverschluss

21-42014	silber matt
21-42015	weiß
21-42016	schwarz





MOLTO LUCE®

# GRID LFO

Einbauspot aus Aluminium, zurückversetzte Linsen mit verschiedenen Abstrahlwinkeln, Lichteinsatz mit Justierschrauben höhenverstellbar, LFO Linsentechnologie von Bartenbach

A++ → A  
IP20  



## GRID LFO EINBAUGEHÄUSE OHNE RAHMEN

Lichteinsatz separat ordern

**629-205** Rahmenlos

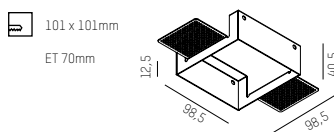

## GRID LFO EINBAUGEHÄUSE MIT RAHMEN

Lichteinsatz separat ordern

**629-105** weiß  
**629-106** schwarz

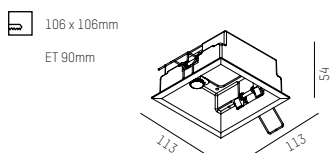

## GRID LFO LICHTEINSATZ

Konverter separat ordern

### REFLEKTOR 30° MEDIUM

LED 9W | 700mA | 2700K | 570lm | CRI>90

**629-3012435** weiß  
**629-3012436** schwarz

LED 9W | 700mA | 3000K | 570lm | CRI>90

**629-3012495** weiß  
**629-3012496** schwarz

### REFLEKTOR 55° FLOOD

LED 9W | 700mA | 2700K | 570lm | CRI>90

**629-3012535** weiß  
**629-3012536** schwarz

LED 9W | 700mA | 3000K | 570lm | CRI>90

**629-3012595** weiß  
**629-3012596** schwarz

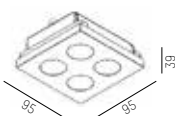

## LED KONVERTER

20W / 700mA Separat ordern

**24-122201** ① nicht dimm.  
**24-122400** ② 1 - 10V & PUSH dimm.  
**24-122403** ② DALI dimm.

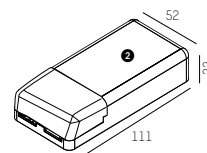
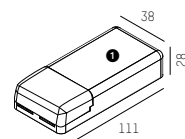





MOLTO LUCE®

# GRID

LED Einbauspots aus Aluminium mit Oberfläche schwarz oder weiß pulverbeschichtet, zurückversetzte Linsen mit verschiedenen Abstrahlwinkeln, perfekte Entblendung durch Hochglanzraster  
Lichteinsatz mit Justierschrauben höhenverstellbar

A++ → A  
IP20  



## GRID EINBAUGEHÄUSE OHNE RAHMEN

Lichteinsatz separat ordern

**629-205** Rahmenlos

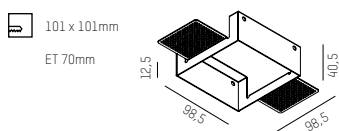

## GRID EINBAUGEHÄUSE MIT RAHMEN

Lichteinsatz separat ordern

**629-105** weiß  
**629-106** schwarz

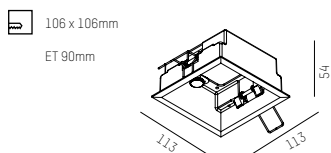

## GRID LICHEINSATZ

Konverter separat ordern

### REFLEKTOR 15° SPOT

LED 9W | 700mA | 2700K | 590lm | CRI>90

**629-3012135** weiß  
**629-3012136** schwarz

LED 9W | 700mA | 3000K | 590lm | CRI>90

**629-3012195** weiß  
**629-3012196** schwarz

### REFLEKTOR 30° MEDIUM

LED 9W | 700mA | 2700K | 570lm | CRI>90

**629-3012235** weiß  
**629-3012236** schwarz

LED 9W | 700mA | 3000K | 570lm | CRI>90

**629-3012295** weiß  
**629-3012296** schwarz

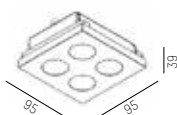

## LED KONVERTER

20W / 700mA Separat ordern

**24-122201** ① nicht dimm.  
**24-122400** ② 1 - 10V & PUSH dimm.  
**24-122403** ② DALI dimm.

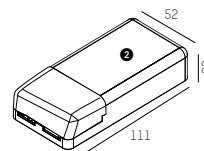
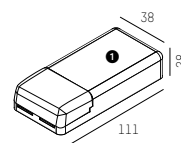



MOLTO LUCE®

# GRID LFO

Aufbauspot aus Aluminium, zurückversetzte  
Linsen mit verschiedenen Abstrahlwinkeln,  
LFO Linsentechnologie von Bartenbach

A+ → A  
IP20  

## GRID LFO DL

### REFLEKTOR 30° NEDIUM

SYS 10W | 230V | 2700K | 570lm | CRI>90

	1	2
629-50124355	weiß	weiß
629-50124356	weiß	schwarz
629-50124365	schwarz	weiß
629-50124366	schwarz	schwarz

SYS 10W | 230V | 3000K | 570lm | CRI>90

	1	2
629-50124955	weiß	weiß
629-50124956	weiß	schwarz
629-50124965	schwarz	weiß
629-50124966	schwarz	schwarz

### REFLEKTOR 55° FLOOD

SYS 10W | 230V | 2700K | 570lm | CRI>90

	1	2
629-50125355	weiß	weiß
629-50125356	weiß	schwarz
629-50125365	schwarz	weiß
629-50125366	schwarz	schwarz

SYS 10W | 230V | 3000K | 570lm | CRI>90

	1	2
629-50125955	weiß	weiß
629-50125956	weiß	schwarz
629-50125965	schwarz	weiß
629-50125966	schwarz	schwarz

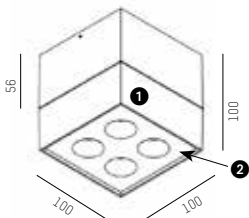



MOLTO LUCE®

# GRID

LED Aufbauspot aus Aluminium mit Oberfläche schwarz oder weiß pulverbeschichtet, zurückversetzte Linsen mit verschiedenen Abstrahlwinkeln, perfekte Entblendung durch Hochglanzraster

A+ → A  
IP20  



## GRID DL

### REFLEKTOR 15° SPOT

SYS 10W | 230V | 2700K | 590lm | CRI>90

	1	2
629-50121355	weiß	weiß
629-50121356	weiß	schwarz
629-50121365	schwarz	weiß
629-50121366	schwarz	schwarz

SYS 10W | 230V | 3000K | 590lm | CRI>90

	1	2
629-50121955	weiß	weiß
629-50121956	weiß	schwarz
629-50121965	schwarz	weiß
629-50121966	schwarz	schwarz

### REFLEKTOR 30° MEDIUM

SYS 10W | 230V | 2700K | 570lm | CRI>90

	1	2
629-50122355	weiß	weiß
629-50122356	weiß	schwarz
629-50122365	schwarz	weiß
629-50122366	schwarz	schwarz

SYS 10W | 230V | 3000K | 570lm | CRI>90

	1	2
629-50122955	weiß	weiß
629-50122956	weiß	schwarz
629-50122965	schwarz	weiß
629-50122966	schwarz	schwarz

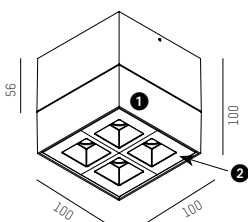

## GRID DL

### REFLEKTOR 15° SPOT

SYS 10W | 230V | 2700K | 590lm | CRI>90

	1	2
629-60121355	weiß	weiß
629-60121356	weiß	schwarz
629-60121365	schwarz	weiß
629-60121366	schwarz	schwarz

SYS 10W | 230V | 3000K | 590lm | CRI>90

	1	2
629-60121955	weiß	weiß
629-60121956	weiß	schwarz
629-60121965	schwarz	weiß
629-60121966	schwarz	schwarz

### REFLEKTOR 30° MEDIUM

SYS 10W | 230V | 2700K | 570lm | CRI>90

	1	2
629-60122355	weiß	weiß
629-60122356	weiß	schwarz
629-60122365	schwarz	weiß
629-60122366	schwarz	schwarz

SYS 10W | 230V | 3000K | 570lm | CRI>90

	1	2
629-60122955	weiß	weiß
629-60122956	weiß	schwarz
629-60122965	schwarz	weiß
629-60122966	schwarz	schwarz

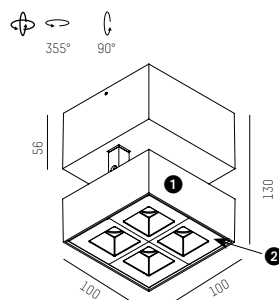



MOLTO LUCE®

# RIDE LENS

LED Einbauleuchte, Oberfläche eloxiert, weiß oder schwarz pulverbeschichtet, zurückversetzte Linsen mit verschiedenen Abstrahlwinkeln

A+ → A  
IP20  



## RIDE LENS 6W EBL

### REFLEKTOR 15° SPOT

SYS 6W | 500mA | 2700K | 570lm | CRI>80

**634-090601135** weiß  
**634-090601136** schwarz  
**634-090601138** Alu eloxiert

SYS 6W | 500mA | 3000K | 660lm | CRI>80

**634-090601195** weiß  
**634-090601196** schwarz  
**634-090601198** Alu eloxiert

### REFLEKTOR 46° FLOOD

SYS 6W | 500mA | 2700K | 570lm | CRI>80

**634-090601335** weiß  
**634-090601336** schwarz  
**634-090601338** Alu eloxiert

SYS 6W | 500mA | 3000K | 660lm | CRI>80

**634-090601395** weiß  
**634-090601396** schwarz  
**634-090601398** Alu eloxiert

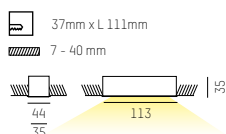

## LED KONVERTER

500mA für 2 x RIDE 6W  
 Separat ordern

**24-122201** nicht dimm.  
**24-122403** DALI dimm.

## RIDE LENS 17W EBL

### REFLEKTOR 15° SPOT

SYS 17W | 500mA | 2700K | 1750lm | CRI>80

**634-011701135** weiß  
**634-011701136** schwarz  
**634-011701138** Alu eloxiert

SYS 17W | 500mA | 3000K | 1750lm | CRI>80

**634-011701195** weiß  
**634-011701196** schwarz  
**634-011701198** Alu eloxiert

### REFLEKTOR 46° FLOOD

SYS 17W | 500mA | 2700K | 1750lm | CRI>80

**634-011701335** weiß  
**634-011701336** schwarz  
**634-011701338** Alu eloxiert

SYS 17W | 500mA | 3000K | 1750lm | CRI>80

**634-011701395** weiß  
**634-011701396** schwarz  
**634-011701398** Alu eloxiert

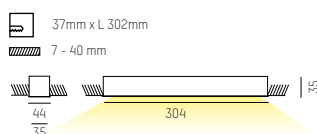

## LED KONVERTER

500mA für 1 x RIDE 17W  
 Separat ordern

**24-122201** nicht dimm.  
**24-122403** DALI dimm.

## RIDE LENS 30W EBL

### REFLEKTOR 15° SPOT

SYS 30W | 900mA | 2700K | 2900lm | CRI>80

**634-053001135** weiß  
**634-053001136** schwarz  
**634-053001138** Alu eloxiert

SYS 30W | 900mA | 3000K | 2900lm | CRI>80

**634-053001195** weiß  
**634-053001196** schwarz  
**634-053001198** Alu eloxiert

### REFLEKTOR 46° FLOOD

SYS 30W | 900mA | 2700K | 2900lm | CRI>80

**634-053001335** weiß  
**634-053001336** schwarz  
**634-053001338** Alu eloxiert

SYS 30W | 900mA | 3000K | 2900lm | CRI>80

**634-053001395** weiß  
**634-053001396** schwarz  
**634-053001398** Alu eloxiert

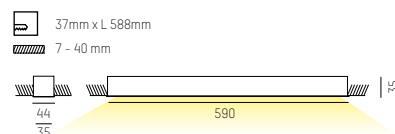

## LED KONVERTER

900mA für 1 x RIDE 30W  
 Separat ordern

**24-122204** nicht dimm.  
**24-122413** DALI dimm.





MOLTO LUCE®

# RIDE BLIND

LED Aufbauleuchte aus stranggepresstem Aluminium mit Oberfläche eloxiert, weiß oder schwarz pulverbeschichtet

A++ → A  
IP20  

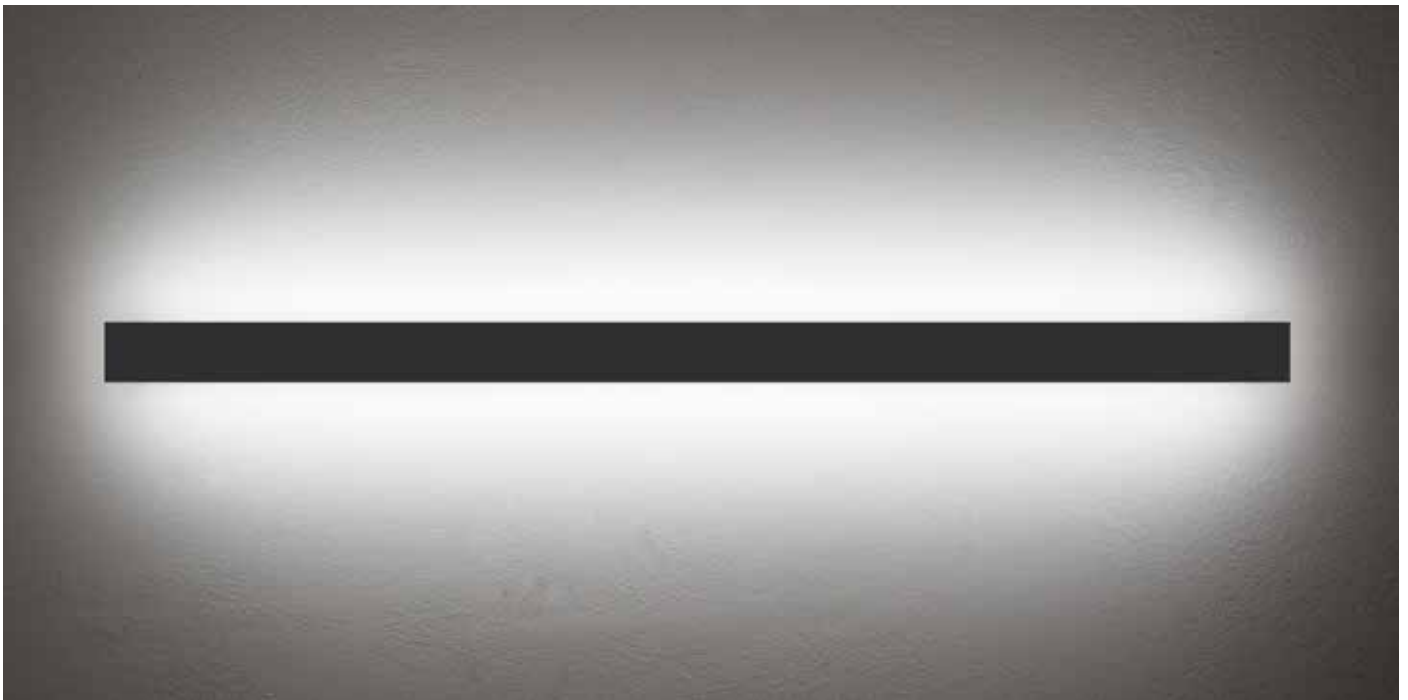

### RIDE BLIND 11W WL/DL

SYS 11W | 230V | 2700K  
714lm | CRI>80

**577-3110135** weiß  
**577-3110136** schwarz  
**577-3110138** Alu eloxiert

SYS 11W | 230V | 3000K  
770lm | CRI>80

**577-3110195** weiß  
**577-3110196** schwarz  
**577-3110198** Alu eloxiert

### RIDE BLIND 17W WL/DL

SYS 17W | 230V | 2700K  
847lm | CRI>80

**577-3170135** weiß  
**577-3170136** schwarz  
**577-3170138** Alu eloxiert

SYS 17W | 230V | 3000K  
981lm | CRI>80

**577-3170195** weiß  
**577-3170196** schwarz  
**577-3170198** Alu eloxiert

### RIDE BLIND 22W WL/DL

SYS 22W | 230V | 2700K  
1340lm | CRI>80

**577-3220135** weiß  
**577-3220136** schwarz  
**577-3220138** Alu eloxiert

SYS 22W | 230V | 3000K  
1470lm | CRI>80

**577-3220195** weiß  
**577-3220196** schwarz  
**577-3220198** Alu eloxiert

### RIDE BLIND 27W WL/DL

SYS 27W | 230V | 2700K  
1540lm | CRI>80

**577-3270135** weiß  
**577-3270136** schwarz  
**577-3270138** Alu eloxiert

SYS 27W | 230V | 3000K  
1680lm | CRI>80

**577-3270195** weiß  
**577-3270196** schwarz  
**577-3270198** Alu eloxiert

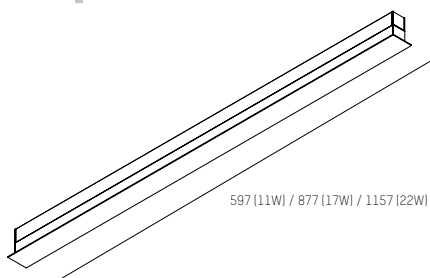
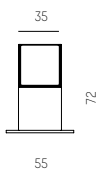





MOLTO LUCE®

# VOLTO COPERTO

Extra schlanke LED Aufbauleuchte aus Aluminium, Oberfläche eloxiert oder weiß pulverbeschichtet, opale PMMA Abdeckung kubisch, flach oder rund, Erhältlich in 4 Längen

A++ → A  
IP20  

## VOLTO COPERTO 11W WL

### ABDECKUNG KUBISCH

SYS 11W | 230V | 2700K  
810lm | CRI>80

**539-3110135** weiß  
**539-3110136** schwarz  
**539-3110138** Alu eloxiert

SYS 11W | 230V | 3000K  
830lm | CRI>80

**539-3110195** weiß  
**539-3110196** schwarz  
**539-3110198** Alu eloxiert

### ABDECKUNG FLACH

SYS 11W | 230V | 2700K  
810lm | CRI>80

**539-3111135** weiß  
**539-3111136** schwarz  
**539-3111138** Alu eloxiert

SYS 11W | 230V | 3000K  
830lm | CRI>80

**539-3111195** weiß  
**539-3111196** schwarz  
**539-3111198** Alu eloxiert

### ABDECKUNG RUND

SYS 11W | 230V | 2700K  
810lm | CRI>80

**539-3113135** weiß  
**539-3113136** schwarz  
**539-3113138** Alu eloxiert

SYS 11W | 230V | 3000K  
830lm | CRI>80

**539-3113195** weiß  
**539-3113196** schwarz  
**539-3113198** Alu eloxiert

## VOLTO COPERTO 17W WL

### ABDECKUNG KUBISCH

SYS 17W | 230V | 2700K  
1210lm | CRI>80

**539-3170135** weiß  
**539-3170136** schwarz  
**539-3170138** Alu eloxiert

SYS 17W | 230V | 3000K  
1240lm | CRI>80

**539-3170195** weiß  
**539-3170196** schwarz  
**539-3170198** Alu eloxiert

### ABDECKUNG FLACH

SYS 17W | 230V | 2700K  
1210lm | CRI>80

**539-3171135** weiß  
**539-3171136** schwarz  
**539-3171138** Alu eloxiert

SYS 17W | 230V | 3000K  
1240lm | CRI>80

**539-3171195** weiß  
**539-3171196** schwarz  
**539-3171198** Alu eloxiert

### ABDECKUNG RUND

SYS 17W | 230V | 2700K  
1210lm | CRI>80

**539-3173135** weiß  
**539-3173136** schwarz  
**539-3173138** Alu eloxiert

SYS 17W | 230V | 3000K  
1240lm | CRI>80

**539-3173195** weiß  
**539-3173196** schwarz  
**539-3173198** Alu eloxiert

## VOLTO COPERTO 22W WL

### ABDECKUNG KUBISCH

SYS 22W | 230V | 2700K  
1620lm | CRI>80

**539-3220135** weiß  
**539-3220136** schwarz  
**539-3220138** Alu eloxiert

SYS 22W | 230V | 3000K  
1660lm | CRI>80

**539-3220195** weiß  
**539-3220196** schwarz  
**539-3220198** Alu eloxiert

### ABDECKUNG FLACH

SYS 22W | 230V | 2700K  
1620lm | CRI>80

**539-3221135** weiß  
**539-3221136** schwarz  
**539-3221138** Alu eloxiert

SYS 22W | 230V | 3000K  
1660lm | CRI>80

**539-3221195** weiß  
**539-3221196** schwarz  
**539-3221198** Alu eloxiert

### ABDECKUNG RUND

SYS 22W | 230V | 2700K  
1620lm | CRI>80

**539-3223135** weiß  
**539-3223136** schwarz  
**539-3223138** Alu eloxiert

SYS 22W | 230V | 3000K  
1660lm | CRI>80

**539-3223195** weiß  
**539-3223196** schwarz  
**539-3223198** Alu eloxiert

## VOLTO COPERTO 27W WL

### ABDECKUNG KUBISCH

SYS 27W | 230V | 2700K  
2020lm | CRI>80

**539-3270135** weiß  
**539-3270136** schwarz  
**539-3270138** Alu eloxiert

SYS 27W | 230V | 3000K  
2070lm | CRI>80

**539-3270195** weiß  
**539-3270196** schwarz  
**539-3270198** Alu eloxiert

### ABDECKUNG FLACH

SYS 27W | 230V | 2700K  
2020lm | CRI>80

**539-3271135** weiß  
**539-3271136** schwarz  
**539-3271138** Alu eloxiert

SYS 27W | 230V | 3000K  
2070lm | CRI>80

**539-3271195** weiß  
**539-3271196** schwarz  
**539-3271198** Alu eloxiert

### ABDECKUNG RUND

SYS 27W | 230V | 2700K  
2020lm | CRI>80

**539-3273135** weiß  
**539-3273136** schwarz  
**539-3273138** Alu eloxiert

SYS 27W | 230V | 3000K  
2070lm | CRI>80

**539-3273195** weiß  
**539-3273196** schwarz  
**539-3273198** Alu eloxiert

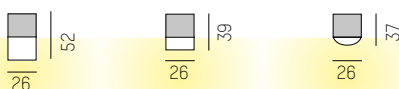

570 (11W) / 850 (17W) / 1130 (22W) / 1410 (27W)

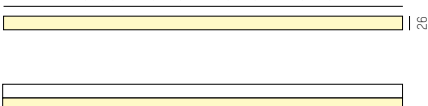

### ABDECKUNG KUBISCH



### ABDECKUNG FLACH



### ABDECKUNG RUND





MOLTO LUCE®

# RIDE

LED Aufbauleuchte aus stranggepresstem Aluminium mit Oberfläche eloxiert, weiß oder schwarz pulverbeschichtet, flache oder vorspringende kubische Abdeckung

A++ - A  
IP20  



## RIDE 17W WL/DL

### ABDECKUNG KUBISCH

SYS 17W | 230V | 2700K  
1130lm | CRI>80

577-23021135 weiß  
577-23021136 schwarz  
577-21021138 Alu eloxiert

SYS 17W | 230V | 3000K  
1230lm | CRI>80

577-23021195 weiß  
577-23021196 schwarz  
577-23021198 Alu eloxiert

### ABDECKUNG FLACH

SYS 17W | 230V | 2700K  
970lm | CRI>80

577-23020135 weiß  
577-23020136 schwarz  
577-23020138 Alu eloxiert

SYS 17W | 230V | 3000K  
1050lm | CRI>80

577-23020195 weiß  
577-23020196 schwarz  
577-23020198 Alu eloxiert

## RIDE 22W WL/DL

### ABDECKUNG KUBISCH

SYS 22W | 230V | 2700K  
1510lm | CRI>80

577-25021135 weiß  
577-25021136 schwarz  
577-25021138 Alu eloxiert

SYS 22W | 230V | 3000K  
1650lm | CRI>80

577-25021195 weiß  
577-25021196 schwarz  
577-25021198 Alu eloxiert

### ABDECKUNG FLACH

SYS 22W | 230V | 2700K  
1290lm | CRI>80

577-25020135 weiß  
577-25020136 schwarz  
577-25020138 Alu eloxiert

SYS 22W | 230V | 3000K  
1400lm | CRI>80

577-25020195 weiß  
577-25020196 schwarz  
577-25020198 Alu eloxiert

## RIDE 27W WL/DL

### ABDECKUNG KUBISCH

SYS 27W | 230V | 2700K  
1890lm | CRI>80

577-26021135 weiß  
577-26021136 schwarz  
577-26021138 Alu eloxiert

SYS 27W | 230V | 3000K  
2060lm | CRI>80

577-26021195 weiß  
577-26021196 schwarz  
577-26021198 Alu eloxiert

### ABDECKUNG FLACH

SYS 27W | 230V | 2700K  
1610lm | CRI>80

577-26020135 weiß  
577-26020136 schwarz  
577-26020138 Alu eloxiert

SYS 27W | 230V | 3000K  
1760lm | CRI>80

577-26020195 weiß  
577-26020196 schwarz  
577-26020198 Alu eloxiert

## RIDE 54 W WL/DL

### ABDECKUNG KUBISCH

SYS 54W | 230V | 2700K  
3780lm | CRI>80

577-27021135 weiß  
577-27021136 schwarz  
577-27021138 Alu eloxiert

SYS 54W | 230V | 3000K  
4120lm | CRI>80

577-27021195 weiß  
577-27021196 schwarz  
577-27021198 Alu eloxiert

### ABDECKUNG FLACH

SYS 54W | 230V | 2700K  
3220lm | CRI>80

577-27020135 weiß  
577-27020136 schwarz  
577-27020138 Alu eloxiert

SYS 54W | 230V | 3000K  
3520lm | CRI>80

577-27020195 weiß  
577-27020196 schwarz  
577-27020198 Alu eloxiert

### ABDECKUNG FLACH

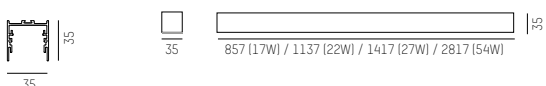

### ABDECKUNG KUBISCH

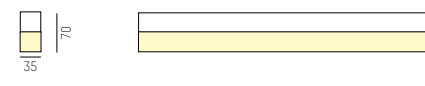



MOLTO LUCE®

# LOG OUT 2

LED Aufbauleuchte aus strang-  
gepresstem Aluminium mit  
Oberfläche eloxiert, weiß oder  
schwarz pulverbeschichtet  
Abdeckung Opaldiffuser

A++ → A  
IP20  



### LOG OUT 2 16W WL/DL

SYS 16W | 230V | 3000K  
1490lm | CRI>80

**628-216095pm** weiß  
**628-216096pm** schwarz  
**628-216098pm** Alu eloxiert

### LOG OUT 2 20W WL/DL

SYS 20W | 230V | 3000K  
1990lm | CRI>80

**628-220095pm** weiß  
**628-220096pm** schwarz  
**628-220098pm** Alu eloxiert

### LOG OUT 2 25W WL/DL

SYS 25W | 230V | 3000K  
2490lm | CRI>80

**628-225095pm** weiß  
**628-225096pm** schwarz  
**628-225098pm** Alu eloxiert

### LOG OUT 2 40W WL/DL

SYS 40W | 230V | 3000K  
3980lm | CRI>80

**628-240095pm** weiß  
**628-240096pm** schwarz  
**628-240098pm** Alu eloxiert

### LOG OUT 2 50W WL/DL

SYS 50W | 230V | 3000K  
4980lm | CRI>80

**628-250095pm** weiß  
**628-250096pm** schwarz  
**628-250098pm** Alu eloxiert

### LOG OUT 2 60W WL/DL

SYS 60W | 230V | 3000K  
5970lm | CRI>80

**628-260095pm** weiß  
**628-260096pm** schwarz  
**628-260098pm** Alu eloxiert

### LOG OUT 2 75W WL/DL

SYS 675W | 230V | 3000K  
7470lm | CRI>80

**628-275095pm** weiß  
**628-275096pm** schwarz  
**628-275098pm** Alu eloxiert

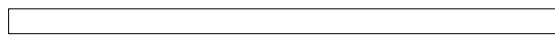
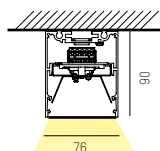

853 (16W) / 1134 (20W) / 1415 (25W) / 2259 (40W) / 2821 (50W) / 3383 (60W) / 4226 (75W)





### CLASSIC LED BULB

E27 | 230V | 7,5W | 2700K | 806lm  
Ersatz für 60W | CRI>80  
Dimmbar

30-575475 klar

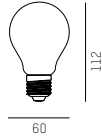

### CLASSIC LED BULB

E27 | 230V | 7,5W | 2000K | 600lm  
Ersatz für 48W | CRI>80  
Dimmbar

30-575673 gold

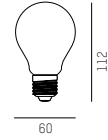

### CLASSIC LED BULB

E27 | 230V | 7W | 2700K | 806lm  
Ersatz für 60W | CRI>80  
Dimmbar

30-575697 klar

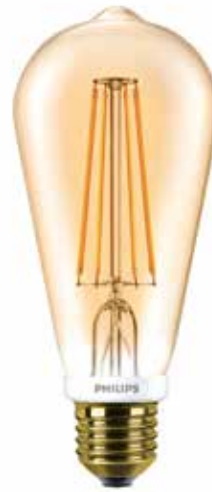
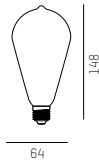

### CLASSIC LED BULB

E27 | 230V | 7W | 2000K | 630lm  
Ersatz für 50W | CRI>80  
Dimmbar

30-575734 gold

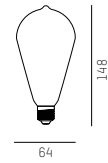

### CLASSIC LED GLOBE

E27 | 230V | 7W | 2700K | 806lm  
Ersatz für 60W | CRI>80  
Dimmbar

30-575758 klar

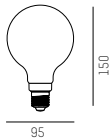

### CLASSIC LED GLOBE

E27 | 230V | 7W | 2000K | 630lm  
Ersatz für 50W | CRI>80  
Dimmbar

30-575772 gold

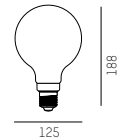

# LED-LEUCHTMITTEL

## VINTAGE LED LONG TUBE

E27 | 230V | 6W | 2200K | 470lm  
Ersatz für 40W | CRI>60  
Dimmbar

129-50395 klar

A+

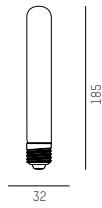

CODE	PAGE	CODE	PAGE	CODE	PAGE	CODE	PAGE
21-320131	317	64-20039	069	68-553601ww	095	140-1037010000101	127
21-320134	317	64-20040	069	68-553701ww	095	140-1037210000101	127
21-320135	317	64-20041	069	68-556101xw	299	140-1065010220101	097
21-320136	317	64-20042	099	68-556102xw	299	140-1065010370101	097
21-320191	317	64-20043	099	105-003687ciciv1	207	140-1065010450101	097
21-320194	317	64-20044	099	105-003688ciciv1	207	140-1081010800102	141
21-320195	317	64-30014	071	105-003689ciciv1	207	140-1081010800108	141
21-320196	317	64-30015	071	105-003806ciciv1	207	140-1081011200102	141
21-42014	317	64-30016	071	105-0052842121	169	140-1081011800102	141
21-42015	317	64-30017	071	105-005284bwbw	169	140-1081013000102	141
21-42016	317	64-30018	071	105-00528521f1	169	140-1081020800102	141
21-42024	317	64-30019	071	105-005285bwf1	169	140-1081020800108	141
21-42025	317	64-30020	071	105-00528721f1	169	140-1081021200102	141
21-42026	317	64-30021	071	105-005287bwf1	169	140-1081021800102	141
24-122201	319	64-30022	071	105-0056930505	117	140-1081023000102	141
24-122204	327	64-40011	071	105-0056940505	117	140-1081210800102	141
24-122400	319	64-40012	071	105-0056960505	117	140-1081210800108	141
24-122403	319	64-40013	071	105-00601406m1	225	140-1081211200102	141
24-122413	327	64-40014	071	105-00601506m1	225	140-1081211800102	141
30-575475	336	64-40015	071	105-0060172727	173	140-1082010800102	143
30-575673	336	64-40016	071	105-0060182727	173	140-1082011200102	143
30-575697	336	64-40017	071	105-0060212727	173	140-1082011800102	143
30-575758	336	64-40018	071	105-0556930505	119	140-1082020800102	143
30-575772	336	64-40019	071	105-1056930505	119	140-1082021200102	143
56-4035ng1	277	64-50013	071	105-2556930505	119	140-1082021800102	143
56-4036ng1	277	64-50014	071	105-7160222727	173	140-1082210800102	143
64-10102	067	64-50015	071	129-50395	337	140-1082211200102	143
64-10103	067	64-50016	071	140-a016010250101	265	140-1082211800102	143
64-10104	067	64-50017	071	140-a016010600101	265	140-1091520000200	151
64-10105	067	64-50018	071	140-a016010900101	265	140-1091530000200	151
64-10106	067	64-50019	071	140-a016210250101	265	140-1091540000200	151
64-10107	067	64-50020	071	140-a016210600101	265	140-1091550000200	151
64-10108	067	64-50021	071	140-a016210900101	265	140-1091560000200	151
64-10109	067	68-018201	299	140-a016370250101	265	140-1091570000200	151
64-10110	067	68-018202	299	140-a016370600101	265	140-1091620000200	151
64-10111	067	68-018235	299	140-a016370900101	265	140-1091630000200	151
64-10112	067	68-0963	279	140-a016390250101	265	140-1091640000200	151
64-10113	067	68-151001	177	140-a016390600101	265	140-1091650000200	151
64-10114	067	68-152401ww	123	140-a016390900101	265	140-1091660000200	151
64-10115	067	68-152501ww	123	140-a035010500101	267	140-1091670000200	151
64-10116	067	68-153001ww	095	140-a035011000101	267	140-1094520000200	149
64-10117	067	68-153101ww	095	140-a035210500101	267	140-1094530000200	149
64-10118	067	68-153201ww	095	140-a035211000101	267	140-1094540000200	149
64-10119	067	68-456101xw	299	140-a035220500101	267	140-1094550000200	149
64-10120	067	68-45610229xw	299	140-a035221000101	267	140-1094560000200	149
64-10121	067	68-45613101xw	299	140-a035230500101	267	140-1094570000200	149
64-10122	067	68-456135xw	299	140-a035231000101	267	140-1094620000200	149
64-10123	067	68-456701ww	281	140-a035240500101	267	140-1094630000200	149
64-10124	067	68-456731ww	281	140-a035241000101	267	140-1094640000200	149
64-10125	067	68-456801ww	281	140-a064010000101	287	140-1094650000200	149
64-10126	067	68-456831ww	281	140-a064020000101	287	140-1094660000200	149
64-10127	067	68-456901ww	281	140-a070010110101	293	140-1094670000200	149
64-10128	067	68-456931ww	281	140-a070010140101	293	140-1097520000200	153
64-10129	099	68-457401ww	269	140-c077010000409	251	140-1097530000200	153
64-10130	099	68-457402ww	269	140-c077020000409	251	140-1097540000200	153
64-10131	099	68-457501ww	269	140-c077030000409	251	140-1097550000200	153
64-10132	099	68-457502ww	269	140-c077300000409	251	140-1097560000200	153
64-10133	099	68-457601ww	269	140-1020011200102	209	140-1097570000200	153
64-10134	099	68-457602ww	269	140-1020012100102	209	140-1097620000200	153
64-20033	069	68-457701ww	269	140-1020021200102	209	140-1097630000200	153
64-20034	069	68-457702ww	269	140-1020022100102	209	140-1097640000200	153
64-20035	069	68-458201ww	279	140-1021011200102	209	140-1097650000200	153
64-20036	069	68-458301ww	279	140-1021012100102	209	140-1097660000200	153
64-20037	069	68-523601ww	123	140-1021021200102	209	140-1097670000200	153
64-20038	069	68-523701ww	123	140-1021022100102	209	140-1231013600102	137

# INDEX

CODE	PAGE	CODE	PAGE	CODE	PAGE	CODE	PAGE
140-1231011800102	137	140-t020012100102	209	264-ph00312	079	264-so01126	159
140-1232011800102	137	140-t020022100102	209	264-pl01575	059	264-so01127	159
140-1232013600102	137	140-t077010000409	251	264-pl01576	059	264-so01128	159
140-l0081213000102	141	140-t077020000409	251	264-pl01578	059	264-so01129	159
140-m091520000200	151	140-t077030000409	251	264-pl01579	059	264-so01136	157
140-m091530000200	151	140-t077300000409	251	264-pl01580	059	264-so01137	157
140-m091540000200	151	226-globm	201	264-pl01582	059	264-so01154	073
140-m091550000200	151	226-glonm	201	264-pl01583	059	264-so01158	073
140-m091560000200	151	226-l1bm	203	264-pl01584	059	264-so01161	073
140-m091570000200	151	226-l1nm	203	264-pl01585	059	264-so01165	073
140-m091620000200	151	226-l2bm	203	264-pl01587	059	264-so01166	073
140-m091630000200	151	226-l2nm	203	264-pl01588	059	264-so01167	073
140-m091640000200	151	226-l3bm	203	264-pl01590	059	264-so01173	171
140-m091650000200	151	226-l3nm	203	264-pl01591	059	264-so01324	227
140-m091660000200	151	226-l4bm	205	264-pl01592	059	264-so01346	227
140-m091670000200	151	226-l4nm	205	264-pl01594	059	264-so01347	227
140-m094520000200	149	226-l5bm	205	264-pl01595	059	264-so01348	227
140-m094530000200	149	226-l5nm	205	264-pl01596	059	264-so01349	227
140-m094540000200	149	226-l6bm	205	264-pl01597	059	264-so01350	227
140-m094550000200	149	226-l6nm	205	264-pl01599	059	264-so01351	227
140-m094560000200	149	264-acc00542	121	264-pl01600	059	264-so01352	227
140-m094570000200	149	264-acc00544	121	264-pl01601	059	264-so01353	227
140-m094620000200	149	264-ap00773	261	264-pl01603	059	264-so01355	227
140-m094630000200	149	264-ap00774	261	264-pl01604	059	264-so01356	227
140-m094640000200	149	264-lp00136	077	264-pl01605	059	264-so01357	227
140-m094650000200	149	264-lp00187	077	264-pl01627	313	264-so01358	227
140-m094660000200	149	264-lp00188	077	264-pl01629	313	264-so01359	227
140-m094670000200	149	264-lp00211	249	264-so00417	057	264-so01360	227
140-m097520000200	153	264-lp00212	249	264-so00418	057	264-so01361	227
140-m097530000200	153	264-lp00213	249	264-so00419	057	264-so01362	227
140-m097540000200	153	264-lp00223	077	264-so00437	159	264-so01363	227
140-m097550000200	153	264-lp00224	077	264-so00512	075	264-so01364	061
140-m097560000200	153	264-lp00225	077	264-so00515	075	264-so01366	061
140-m097570000200	153	264-lp00226	077	264-so00518	075	264-so01368	061
140-m097620000200	153	264-lp00240	077	264-so00520	075	264-so01370	061
140-m097630000200	153	264-lp00241	077	264-so00522	075	264-so01372	061
140-m097640000200	153	264-lp00290	065	264-so00524	075	264-so01374	061
140-m097650000200	153	264-lp00292	065	264-so00862	075	264-so01376	061
140-m097660000200	153	264-lp00294	065	264-so00863	075	264-so01378	061
140-m097670000200	153	264-lp00296	065	264-so00875	075	264-so01380	061
140-m81013	141	264-lp00298	065	264-so00877	075	264-so01382	061
140-m81016	141	264-lp00300	065	264-so00879	075	264-so01384	061
140-m81023	141	264-lp00302	065	264-so00881	075	264-so01386	061
140-m81026	141	264-lp00304	065	264-so00883	075	264-so01444	121
140-m81213	141	264-lp00306	065	264-so00885	075	264-so01445	121
140-m81216	141	264-lp00308	065	264-so00887	075	264-sp00103	063
140-m919402	149	264-lp00310	065	264-so00889	075	264-sp00105	063
140-m919425	149	264-lp00312	065	264-so00944	057	264-sp00107	063
140-p037010000101	127	264-lp00665	079	264-so00960	171	264-sp00109	063
140-p037210000101	127	264-lp00666	079	264-so00961	171	264-sp00111	063
140-p064010020101	287	264-lp00668	079	264-so00962	171	264-sp00113	063
140-p064010030103	287	264-ph00091	249	264-so00963	171	264-sp00115	063
140-p064020020101	287	264-ph00092	249	264-so00971	171	264-sp00117	063
140-p064020030103	287	264-ph00093	249	264-so00972	171	264-sp00119	063
140-p065010370101	097	264-ph00142	121	264-so00973	171	264-sp00121	063
140-p065010450101	097	264-ph00143	121	264-so00974	171	264-sp00123	063
140-p082010800102	145	264-ph00144	121	264-so01117	075	264-sp00125	063
140-p082011200102	145	264-ph00145	121	264-so01118	075	264-sp00132	077
140-p082011800102	145	264-ph00146	121	264-so01119	075	264-sp00133	077
140-p082020800102	145	264-ph00147	121	264-so01120	075	264-sp00134	077
140-p082021200102	145	264-ph00305	079	264-so01121	075	264-sp00136	077
140-p082021800102	145	264-ph00306	079	264-so01122	075	264-sp00137	077
140-p082210800102	145	264-ph00307	079	264-so01123	075	264-sp00138	077
140-p082211200102	145	264-ph00309	079	264-so01124	075	264-sp00140	077
140-p082211800102	145	264-ph00310	079	264-so01125	159	264-sp00141	077

CODE	PAGE	CODE	PAGE	CODE	PAGE	CODE	PAGE
264-sp00142	077	305-604430bddd	311	385-coau04b	017	385-ge04ldg	027
264-sp00415	301	305-604430wddd	311	385-coau04be	017	385-ge04ldna	027
264-sp00416	301	305-604527bddd	311	385-coau04g	017	385-ge04na	027
264-sp00419	301	305-604527wddd	311	385-coau04ga	017	385-ge06a	031
264-sp00420	301	305-604530bddd	311	385-coau04gbe	017	385-ge06b	031
264-sp00567	283	305-604530wddd	311	385-coau04gg	017	385-ge06be	031
264-sp00568	283	383-1093002	053	385-coau04gna	017	385-ge06g	031
264-sp00571	283	383-1093025	053	385-coau04lda	017	385-ge06na	031
264-sp00572	283	383-1094002	053	385-coau04ldb	017	385-kt04a	033
302-72743003	191	383-1094025	053	385-coau04ldbe	017	385-kt04b	033
302-72753001	191	383-1095002	053	385-coau04ldg	017	385-kt04be	033
302-72753003	191	383-1095025	053	385-coau04ldna	017	385-kt04da	033
302-78203001	087	383-1096002	055	385-coau04na	017	385-kt04db	033
302-78203030	087	383-1096025	055	385-cocy04a	021	385-kt04dbe	033
302-78203032	087	383-1097002	055	385-cocy04b	021	385-kt04dg	033
302-78213001	087	383-1097025	055	385-cocy04be	021	385-kt04dna	033
302-78213030	087	383-1098002	055	385-cocy04g	021	385-kt04g	033
302-78213032	087	383-1098025	055	385-cocy04lda	021	385-kt04ga	033
302-78223030	087	383-2770011	109	385-cocy04ldb	021	385-kt04gb	033
302-78223032	087	383-2770024	109	385-cocy04ldbe	021	385-kt04gbe	033
302-78271001	091	383-2770030	109	385-cocy04ldg	021	385-kt04gda	033
302-78271003	091	383-27703011	109	385-cocy04ldna	021	385-kt04gdb	033
302-78271011	091	383-27703024	109	385-cocy04na	021	385-kt04gdbe	033
302-78283001	089	383-27703030	109	385-coga04a	025	385-kt04gdg	033
302-78283003	089	383-2771011	109	385-coga04b	025	385-kt04gdna	033
302-78283011	089	383-2771024	109	385-coga04be	025	385-kt04gg	033
302-78294001	091	383-2771030	109	385-coga04g	025	385-kt04gna	033
302-78294003	091	383-2772011	109	385-coga04lda	025	385-kt04na	033
302-78294011	091	383-2772024	109	385-coga04ldb	025	385-kt06a	035
302-83001030	087	383-2772030	109	385-coga04ldbe	025	385-kt06b	035
302-83001032	087	383-2775011	111	385-coga04ldg	025	385-kt06be	035
302-83083003	197	383-2775024	111	385-coga04ldna	025	385-kt06da	035
302-83083010	197	383-2775030	111	385-coga04na	025	385-kt06db	035
302-83083030	197	383-2776011	111	385-core04a	023	385-kt06dbe	035
302-83093003	197	383-2776024	111	385-core04b	023	385-kt06dg	035
302-83093010	197	383-2776030	111	385-core04be	023	385-kt06dna	035
302-83093030	197	383-2777011	111	385-core04g	023	385-kt06g	035
302-84203010	165	383-2777024	111	385-core04lda	023	385-kt06ga	035
302-84203058	165	383-2777030	111	385-core04ldb	023	385-kt06gb	035
302-84213010	165	383-2781011	113	385-core04ldbe	023	385-kt06gbe	035
302-84213058	165	383-2781013	113	385-core04ldg	023	385-kt06gda	035
302-84243003	193	383-2781023	113	385-core04ldna	023	385-kt06gdb	035
302-84253003	193	383-2781024	113	385-core04na	023	385-kt06gdbe	035
302-84263003	193	383-2781063	113	385-cose04a	019	385-kt06gdg	035
302-84333001	195	383-2782011	115	385-cose04b	019	385-kt06gdna	035
302-84333003	195	383-2782013	115	385-cose04be	019	385-kt06gg	035
302-84333032	195	383-2782023	115	385-cose04g	019	385-kt06gna	035
302-84343001	195	383-2782024	115	385-cose04lda	019	385-kt06na	035
302-84343003	195	383-2782063	115	385-cose04ldb	019	385-on04b	043
302-84343032	195	385-co0410a	015	385-cose04ldbe	019	385-on04gb	043
302-84353001	195	385-co0410b	015	385-cose04ldg	019	385-on04gldb	043
302-84353003	195	385-co0410be	015	385-cose04ldna	019	385-on04gldo	043
302-84353032	195	385-co0410g	015	385-cose04na	019	385-on04gldv	043
302-84403001	199	385-co0410na	015	385-ge03a	029	385-on04go	043
302-84403003	199	385-co043a	015	385-ge03b	029	385-on04gv	043
305-602427b	311	385-co043b	015	385-ge03be	029	385-on04ldb	043
305-602427w	311	385-co043be	015	385-ge03g	029	385-on04ldo	043
305-602430b	311	385-co043g	015	385-ge03na	029	385-on04ldv	043
305-602430w	311	385-co043na	015	385-ge04a	027	385-on04o	043
305-602527b	311	385-co045a	015	385-ge04b	027	385-on04v	043
305-602527w	311	385-co045b	015	385-ge04be	027	385-on06b	045
305-602530b	311	385-co045be	015	385-ge04g	027	385-on06gb	045
305-602530w	311	385-co045g	015	385-ge04lda	027	385-pl01b	257
305-604427bddd	311	385-co045na	015	385-ge04ldb	027	385-pm06pra	037
305-604427wddd	311	385-coau04a	017	385-ge04ldbe	027	385-pm06prb	037

# INDEX

CODE	PAGE	CODE	PAGE	CODE	PAGE	CODE	PAGE
385-pm06prbe	037	456-305000700007	051	472-291017bg	272	539-3221135	331
385-pm06prg	037	456-305000700008	051	472-291017g	272	539-3221136	331
385-pm06prlda	037	456-309000300000	231	472-291017w	272	539-3221138	331
385-pm06prldb	037	456-310000300000	231	520-0598	285	539-3221195	331
385-pm06prldbe	037	456-608000000020	231	520-0698	285	539-3221196	331
385-pm06prldg	037	456-608000000027	231	530-15405	215	539-3221198	331
385-pm06prldna	037	456-609000000020	231	530-15444	215	539-3223135	331
385-pm06prna	037	456-609000000027	231	530-15455	215	539-3223136	331
385-pm06ra	037	456-701000700006	049	530-2181305	215	539-3223138	331
385-pm06rb	037	456-701000700007	049	530-2181354	215	539-3223195	331
385-pm06rbe	037	456-701000700008	049	530-2181355	215	539-3223196	331
385-pm06rg	037	456-704000000006	051	530-2181905	215	539-3223198	331
385-pm06rlda	037	456-704000000007	051	530-2181954	215	539-3270135	331
385-pm06rldb	037	456-704000000008	051	530-2181955	215	539-3270136	331
385-pm06rldbe	037	456-705000000006	051	532-12005	187	539-3270138	331
385-pm06rldg	037	456-705000000007	051	532-12055	187	539-3270195	331
385-pm06rldna	037	456-705000000008	051	532-12056	187	539-3270196	331
385-pm06rna	037	456-801000000006	051	532-13005	187	539-3270198	331
385-tn03b	085	456-801000000007	051	532-13055	187	539-3271135	331
385-tn045b	083	456-801000000008	051	532-13056	187	539-3271136	331
385-tn04b	081	456-802000000006	051	532-14005	187	539-3271138	331
385-tn04gb	081	456-802000000007	051	532-14055	187	539-3271195	331
385-tn04gldb	081	456-802000000008	051	532-14056	187	539-3271196	331
385-tn04ldb	081	456-803000000006	051	539-3110135	331	539-3271198	331
385-ur01b	041	456-803000000007	051	539-3110136	331	539-3273135	331
385-ur03b	041	456-803000000008	051	539-3110138	331	539-3273136	331
385-ur104b	039	472-0080490003005	274	539-3110195	331	539-3273138	331
385-ur104ldb	039	472-0080490003006	274	539-3110196	331	539-3273195	331
385-ur104ldo	039	472-0090890003005	274	539-3110198	331	539-3273196	331
385-ur104ldv	039	472-0090890003006	274	539-3111135	331	539-3273198	331
385-ur104o	039	472-258951b	309	539-3111136	331	569-104095ng1	125
385-ur104v	039	472-258951s	309	539-3111138	331	569-104096ng1	125
385-ur204b	039	472-258951w	309	539-3111195	331	569-107095ng1	125
385-ur204ldb	039	472-258952b	309	539-3111196	331	569-107096ng1	125
385-ur204ldo	039	472-258952s	309	539-3111198	331	569-114096ng1	125
385-ur204ldv	039	472-258952w	309	539-3113135	331	569-117096ng1	125
385-ur204o	039	472-260029	306	539-3113136	331	569-154095ng1	125
385-ur204v	039	472-260030	306	539-3113138	331	569-154096ng1	125
385-ur304b	039	472-260031	306	539-3113195	331	569-157095ng1	125
385-ur304ldb	039	472-260032	306	539-3113196	331	569-157096ng1	125
385-ur304ldo	039	472-260033ng1	308	539-3113198	331	569-164096ng1	125
385-ur304ldv	039	472-260034ng1	308	539-3170135	331	569-167096ng1	125
385-ur304o	039	472-260035ng1	308	539-3170136	331	577-21021138	333
385-ur304v	039	472-260036ng1	308	539-3170138	331	577-23020135	333
385-ux04am	221	472-260037ng1	308	539-3170195	331	577-23020136	333
385-ux04b	221	472-260038ng1	308	539-3170196	331	577-23020138	333
385-ux04dam	221	472-260039ng1	307	539-3170198	331	577-23020195	333
385-ux04db	221	472-260040ng1	307	539-3171135	331	577-23020196	333
385-ux04dwe	221	472-260041ng1	307	539-3171136	331	577-23020198	333
385-ux04we	221	472-29100427atr	275	539-3171138	331	577-23021135	333
456-101000600006	049	472-29100427bgtr	275	539-3171195	331	577-23021136	333
456-101000600007	049	472-29100427btr	275	539-3171196	331	577-23021195	333
456-101000600008	049	472-29100427str	275	539-3171198	331	577-23021196	333
456-102000600006	049	472-29100427wtr	275	539-3173135	331	577-23021198	333
456-102000600007	049	472-29100430atr	275	539-3173136	331	577-25020135	333
456-102000600008	049	472-29100430bgtr	275	539-3173138	331	577-25020136	333
456-103000600006	049	472-29100430btr	275	539-3173195	331	577-25020138	333
456-103000600007	049	472-29100430str	275	539-3173196	331	577-25020195	333
456-103000600008	049	472-29100430wtr	275	539-3173198	331	577-25020196	333
456-127000300000	233	472-291009a	273	539-3220135	331	577-25020198	333
456-128000300000	233	472-291009b	273	539-3220136	331	577-25021135	333
456-304000700006	051	472-291009s	273	539-3220138	331	577-25021136	333
456-304000700007	051	472-291009w	273	539-3220195	331	577-25021138	333
456-304000700008	051	472-291017a	272	539-3220196	331	577-25021195	333
456-305000700006	051	472-291017b	272	539-3220198	331	577-25021196	333

CODE	PAGE	CODE	PAGE	CODE	PAGE	CODE	PAGE
577-25021198	333	577-35020196	213	597-2201955	303	599-76459565ng6	131
577-26020135	333	577-35020198	213	597-2201956	303	599-76459633ng6	131
577-26020136	333	577-35021135	213	597-2201963	303	599-76459636ng6	131
577-26020138	333	577-35021136	213	597-2201965	303	599-76459666ng6	131
577-26020195	333	577-35021138	213	597-2201966	303	599-86423535ng6	129
577-26020196	333	577-35021195	213	598-110191	295	599-86423555ng6	129
577-26020198	333	577-35021196	213	599-12	315	599-86423565ng6	129
577-26021135	333	577-35021198	213	599-13	315	599-86423633ng6	129
577-26021136	333	577-36020135	213	599-15	315	599-86423636ng6	129
577-26021138	333	577-36020136	213	599-31401531ng2	315	599-86423666ng6	129
577-26021195	333	577-36020138	213	599-31401534ng2	315	599-86429535ng6	129
577-26021196	333	577-36020195	213	599-31401535ng2	315	599-86429555ng6	129
577-26021198	333	577-36020196	213	599-31401536ng2	315	599-86429565ng6	129
577-27020135	333	577-36020198	213	599-31401591ng2	315	599-86429633ng6	129
577-27020136	333	577-36021135	213	599-31401594ng2	315	599-86429636ng6	129
577-27020138	333	577-36021136	213	599-31401595ng2	315	599-86429666ng6	129
577-27020195	333	577-36021138	213	599-31401596ng2	315	599-86453535ng6	129
577-27020196	333	577-36021195	213	599-31401831ng2	315	599-86453555ng6	129
577-27020198	333	577-36021196	213	599-31401834ng2	315	599-86453565ng6	129
577-27021135	333	577-36021198	213	599-31401835ng2	315	599-86453633ng6	129
577-27021136	333	577-37020135	213	599-31401836ng2	315	599-86453636ng6	129
577-27021138	333	577-37020136	213	599-31401891ng2	315	599-86453666ng6	129
577-27021195	333	577-37020138	213	599-31401894ng2	315	599-86459535ng6	129
577-27021196	333	577-37020195	213	599-31401895ng2	315	599-86459555ng6	129
577-27021198	333	577-37020196	213	599-31401896ng2	315	599-86459565ng6	129
577-3110135	329	577-37020198	213	599-31401931ng2	315	599-86459633ng6	129
577-3110136	329	577-37021135	213	599-31401934ng2	315	599-86459636ng6	129
577-3110138	329	577-37021136	213	599-31401935ng2	315	599-86459666ng6	129
577-3110195	329	577-37021138	213	599-31401936ng2	315	601-10341	219
577-3110196	329	577-37021195	213	599-31401991ng2	315	601-10342	219
577-3110198	329	577-37021196	213	599-31401994ng2	315	601-1035	219
577-3170135	329	577-37021198	213	599-31401995ng2	315	601-10941	219
577-3170136	329	588-100	181	599-31401996ng2	315	601-10942	219
577-3170138	329	588-200	181	599-61401534ng2	315	601-1095	219
577-3170195	329	592-11033	189	599-61401535ng2	315	603-1102946	103
577-3170196	329	592-11034	189	599-61401536ng2	315	603-1102955	103
577-3170198	329	592-11038	189	599-61401594ng2	315	603-1102956	103
577-3220135	329	592-1105	189	599-61401595ng2	315	603-1102965	103
577-3220136	329	592-12033	189	599-61401596ng2	315	603-1102966	103
577-3220138	329	592-12034	189	599-61401834ng2	315	603-1202946	103
577-3220195	329	592-12038	189	599-61401835ng2	315	603-1202955	103
577-3220196	329	592-1205	189	599-61401836ng2	315	603-1202956	103
577-3220198	329	592-14033	189	599-61401894ng2	315	603-1202965	103
577-3270135	329	592-14034	189	599-61401895ng2	315	603-1202966	103
577-3270136	329	592-14038	189	599-61401896ng2	315	603-1302946	103
577-3270138	329	592-1405	189	599-76423535ng6	131	603-1302955	103
577-3270195	329	597-1101353	303	599-76423555ng6	131	603-1302956	103
577-3270196	329	597-1101355	303	599-76423565ng6	131	603-1302965	103
577-3270198	329	597-1101356	303	599-76423633ng6	131	603-1302966	103
577-33020135	213	597-1101363	303	599-76423636ng6	131	603-2102955	105
577-33020136	213	597-1101365	303	599-76423666ng6	131	603-2102956	105
577-33020138	213	597-1101366	303	599-76429535ng6	131	603-2202955	105
577-33020195	213	597-1101953	303	599-76429555ng6	131	603-2202956	105
577-33020196	213	597-1101955	303	599-76429565ng6	131	603-2302955	105
577-33020198	213	597-1101956	303	599-76429633ng6	131	603-2302956	105
577-33021135	213	597-1101963	303	599-76429636ng6	131	603-3202946	101
577-33021136	213	597-1101965	303	599-76429666ng6	131	603-3202955	101
577-33021138	213	597-1101966	303	599-76453535ng6	131	603-3202956	101
577-33021195	213	597-2201353	303	599-76453555ng6	131	603-3202965	101
577-33021196	213	597-2201355	303	599-76453565ng6	131	603-3202966	101
577-33021198	213	597-2201356	303	599-76453633ng6	131	603-3302946	101
577-35020135	213	597-2201363	303	599-76453636ng6	131	603-3302955	101
577-35020136	213	597-2201365	303	599-76453666ng6	131	603-3302956	101
577-35020138	213	597-2201366	303	599-76459535ng6	131	603-3302965	101
577-35020195	213	597-2201953	303	599-76459555ng6	131	603-3302966	101

# INDEX

CODE	PAGE	CODE	PAGE	CODE	PAGE	CODE	PAGE
614-110190	297	629-50124956	323	634-090601336	327	669-095127	237
614-110195	297	629-50124965	323	634-090601338	327	669-102047	179
614-120190	297	629-50124966	323	634-090601395	327	669-102054	179
614-120195	297	629-50125355	323	634-090601396	327	669-104928	178
628-216095pm	335	629-50125356	323	634-090601398	327	669-104935	178
628-216096pm	335	629-50125365	323	636-1001	163	669-104942	178
628-216098pm	335	629-50125366	323	636-1006	163	669-110356	239
628-220095pm	335	629-50125955	323	636-700a	163	669-110363	239
628-220096pm	335	629-50125956	323	636-700b	163	669-110370	239
628-220098pm	335	629-50125965	323	636-700g	163	669-110417	183
628-225095pm	335	629-50125966	323	636-710a	163	669-110424	183
628-225096pm	335	629-60121355	325	636-710b	163	669-110431	183
628-225098pm	335	629-60121356	325	636-710g	163	669-110462	183
628-240095pm	335	629-60121365	325	636-720a	163	669-112305	167
628-240096pm	335	629-60121366	325	636-720b	163	669-112336	167
628-240098pm	335	629-60121955	325	636-720g	163	669-116051	237
628-250095pm	335	629-60121956	325	660-10195	093	669-116068	237
628-250096pm	335	629-60121965	325	660-30195	093	669-116075	237
628-250098pm	335	629-60121966	325	660-50195d	093	669-120898	167
628-260095pm	335	629-60122355	325	661-1090135	289	669-121390	241
628-260096pm	335	629-60122356	325	661-1090136	289	669-121406	241
628-260098pm	335	629-60122365	325	661-1090195	289	669-121420	241
628-275095pm	335	629-60122366	325	661-1090196	289	669-121437	241
628-275096pm	335	629-60122955	325	661-2150135	289	699-t83fliwl	247
628-275098pm	335	629-60122956	325	661-2150136	289	699-t83tliwl	247
629-105	319	629-60122965	325	661-2150195	289	699-t90h1dwl	175
629-106	319	629-60122966	325	661-2150196	289	699-t90h1dzl	175
629-205	319	630-1801941	253	661-3280135	289	699-t90h2dwl	175
629-3012135	321	630-180195	253	661-3280136	289	699-t90h2dzl	175
629-3012136	321	630-180198	253	661-3280195	289	699-t90h3dwl	175
629-3012195	321	634-011701135	327	661-3280196	289	699-t90h3dzl	175
629-3012196	321	634-011701136	327	669-003528	243	699-t95c1dwl	305
629-3012235	321	634-011701138	327	669-003535	243	699-t95c1dzl	305
629-3012236	321	634-011701195	327	669-005126	237	699-t95c2dwl	305
629-3012295	321	634-011701196	327	669-012209	243	699-t95c2dzl	305
629-3012296	321	634-011701198	327	669-012605	237	699-t95c3dwl	305
629-3012435	319	634-011701335	327	669-014166	271	699-t95c3dzl	305
629-3012436	319	634-011701336	327	669-014371	237	699-t97h2izl	223
629-3012495	319	634-011701338	327	669-015286	243	699-t97h5izl	223
629-3012496	319	634-011701395	327	669-016375	243	699-t97h6izl	223
629-3012535	319	634-011701396	327	669-016399	243	699-t97h7izl	223
629-3012536	319	634-011701398	327	669-027036	245	895-1cdh000063z10	291
629-3012595	319	634-042201335	211	669-027043	245	895-1cdh000063z11	291
629-3012596	319	634-042201336	211	669-027050	245	895-1cdh000065z10	291
629-50121355	325	634-042201395	211	669-027852	243	895-1cdh000065z11	291
629-50121356	325	634-042201396	211	669-027869	243	895-1cdh100063z10	291
629-50121365	325	634-053001135	327	669-027876	243	895-1cdh100063z11	291
629-50121366	325	634-053001136	327	669-031361	271	895-1cdh100065z10	291
629-50121955	325	634-053001138	327	669-032436	255	895-1cdh100065z11	291
629-50121956	325	634-053001195	327	669-032467	255	895-1srxl00143e10	235
629-50121965	325	634-053001196	327	669-049229	271	895-1srxl00162e10	235
629-50121966	325	634-053001198	327	669-049236	271	895-1srxl00163e10	235
629-50122355	325	634-053001335	327	669-061177	245		
629-50122356	325	634-053001336	327	669-061184	245		
629-50122365	325	634-053001338	327	669-061191	245		
629-50122366	325	634-053001395	327	669-088266	271		
629-50122955	325	634-053001396	327	669-088273	271		
629-50122956	325	634-053001398	327	669-089799	241		
629-50122965	325	634-090601135	327	669-089805	241		
629-50122966	325	634-090601136	327	669-091129	271		
629-50124355	323	634-090601138	327	669-091136	271		
629-50124356	323	634-090601195	327	669-091983	237		
629-50124365	323	634-090601196	327	669-093659	179		
629-50124366	323	634-090601198	327	669-093680	179		
629-50124955	323	634-090601335	327	669-093697	179		





HEADQUARTERS Wels  
Office & Showroom  
4600 Wels, Austria  
Europastraße 45  
T: +43 7242 698-0  
F: +43 7242 60376  
M: office@moltoluce.com

VIENNA  
Office & Showroom  
1230 Vienna, Austria  
Vorarlberger Allee 28  
T: +43 1 6160300  
F: +43 1 6160300-40  
M: office.wien@moltoluce.com

GRAZ  
Office  
8020 Graz, Austria  
Kalvariengürtel 67  
T: +43 316 672525-0  
F: +43 316 672525-520  
M: office.graz@moltoluce.com

[www.moltoluce.com](http://www.moltoluce.com)

MOLTO LUCE®