

TAL

L
I
G H
· T S

Nice to meet you, we are TAL

Welcome to TAL, welcome to our brand-new catalogue 2021/2022: **your inspirational guide** full of new products and all-time classics. It is designed in the same light as our lighting solutions: based on **your needs, expectations and convenience.**

Browse through its many hundreds of pages, get inspired, let your imagination roam free and enjoy the wide variety of combinations that our different product families have to offer. You will see we have made it as easy as possible for you.

Or wait, hang on: maybe you would first like to get to know us.

We are all a little crazy.
Crazy for quality, mad
about design and obsessed
with workmanship.



Real craftsmanship made in Belgium

What drives and motivates us at TAL? Well, we are all a little bit crazy. Crazy for quality, mad about design and obsessed with workmanship.

Why this passion for quality? TAL is truly Belgian. We design, develop and manufacture all of our products right here. **Beautiful, rock solid and technically top-notch since 1992.** Are we proud of that? Sure, we are. Yet we keep our feet firmly on the ground and we keep working hard to do even better next time. After all we remain craftsmen who recognise, understand and appreciate craftsmanship. True to the Belgian spirit!

TAL operates in an environment of hard work and concentration, thanks to an extremely well-organised warehouse and logistic chain. Structure is key to a peaceful work environment and brings peace of mind to the employees.

Teamwork always sounds great, but you have to be able to live up to it. Here, in the workshop, you can see how that works, how experience and commitment find each other. Co-workers help each other out: whoever finishes his or her task will lend another assembly workstation a helping hand. That's because everyone has the knowledge and skills to assemble multiple products. **This flexibility is definitely one of our strengths here at TAL.**



"Everyone has the knowledge and skills to assemble multiple products. This makes it easier to help each other out."

Lieve
Product development



Nobody is perfect, but that doesn't mean we shouldn't strive for perfection. We are trained to pay meticulous attention to quality. The slightest quality issue will immediately be corrected or reported by anyone in our team who spots it. This is the kind of commitment that defines us. **We strongly stand by our passion for quality not only in words, but definitely also in deeds. ●**



We are always open

We are very accessible and deeply involved; we leave the light on for you. Most of all, we prefer to listen. To what you expect from us. Fast deliveries, for example. That's what we are known for. A complete range that covers your lighting needs from A to Z without getting lost in it. Made-to-measure. We can handle that thanks to our flexible way of working and our local production. It allows us to respond quickly. We adapt quickly. **We deliver fast.** Let us rise to your challenge. We'll give it our all, every time again.



Sometimes project developers, architects or distributors **seek to customize light fittings** to their specific needs. Our Research and Development department is well up for the challenge, as we are perfectly equipped both on the technical and on workmanship level.

We call their solutions our 'specials'. Whether it takes adapting the beam angles, extending cables, or some other procedure, R&D will find a suitable solution. ●

"We're always well up for a challenge."

**Jorgen
Research & Development**

Bert's TAL Top 3

Export manager Bert Soenen has been with TAL since 2007. With all his experience, he's perfectly placed to shed light on his three favourite TAL-families of the moment: The Berrier family, MIX and 48V.

1

You've shown enthusiasm for our Berrier product family on many occasions.

What makes this family so special for you?

Our Berrier family is named after a delightful technically gifted football player. That aspect of technicality is what defines this product family and what made me such a big fan of the Berrier lighting. Clearly, I'm not the only one, as it has become a real top-seller. Meanwhile by natural evolution, Berrier Junior, has also become very popular. Berrier Junior is a quite beautiful addition to the Think Small family.

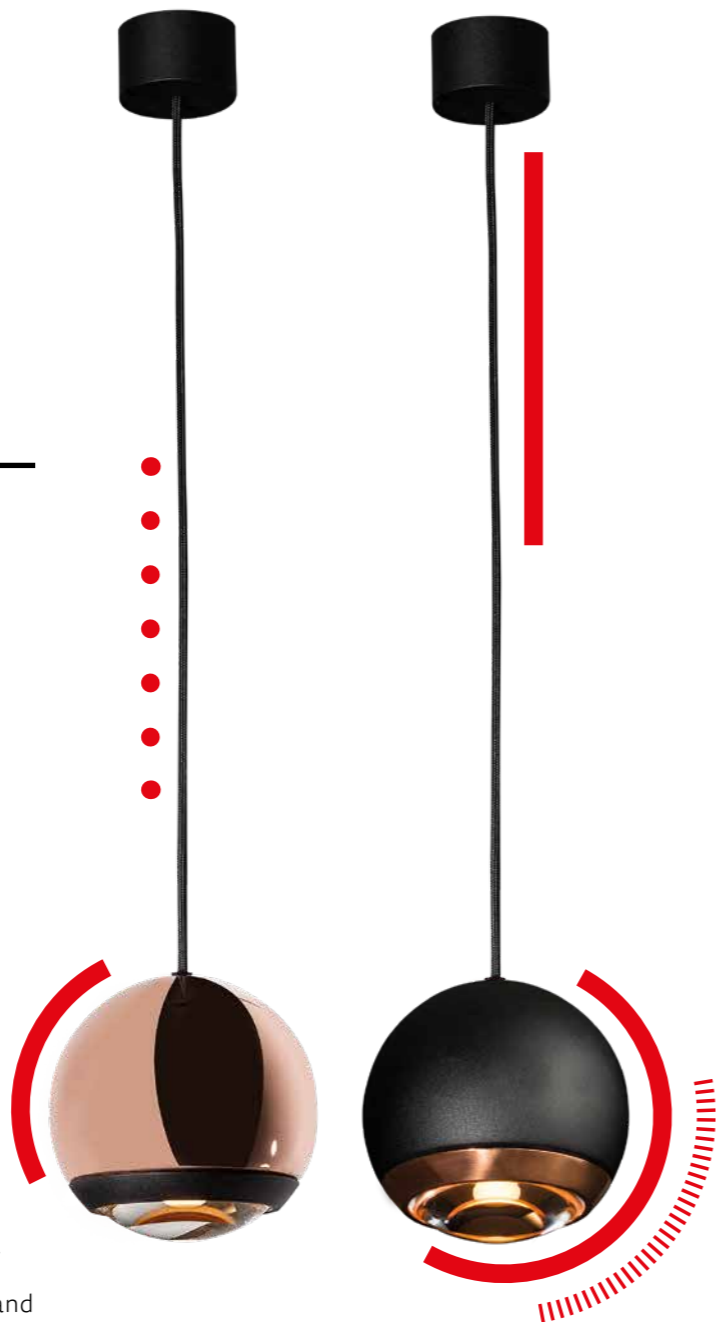

What would you say makes the Berrier Lighting so popular with the customer?

The glass lens, with its excellent anti-glare effect, is certainly an eye-catcher. Berrier is also very versatile, although (in my opinion) shown to its best advantage above a table, a bar or a reception desk. The beam angle on a tabletop is really just perfect.

Does the price tag look equally appealing?

Certainly! Berrier lighting is also very attractive pricewise, which I'm sure will have contributed to its popularity. But there are more selling points than just the affordable price. To name a few, Berrier fixtures consume very little energy and the state-of-the-art LEDs have a long-life expectancy, because of their well calculated cooling balance. The housing doesn't become hot, which suggests a perfect heat dissipation.

What's noteworthy about the Berrier Junior, which you mentioned earlier?

I would definitely point out the thin wire, for whomever prefers the suspension cable to be a bit thinner and tighter. There are some newly added finishes like anodic brown and bronze. Then there's the atmospheric Halosphere dim-to-warm option.

Installation-wise you can just go either way, surface-mounted or trimless-recessed, it's all possible. ▶



2

The second family on your list, **MIX**, suggests a lot of 'mixing'?

Indeed so. You can customise your Mix downlight entirely to your taste or needs. Whether you opt for 13W or 26W, there are no less than 768 possibilities of each version.

First of all, you can choose the shape, which is square or round with a minimal trim or trimless. You can even decide if you want a fixed or adjustable LED module. Then you can pick a narrow, medium or wide beam angle and the desired colour temperature, e.g. 2700K, 3000K, 4000K or even our Halosphere „Dim to Warm“ technology of 1800K – 3000K. Finish it off by choosing the perfect colour combinations. A small trim in textured white finish with a focus in black chrome looks really elegant. Personalising your Mix fixture almost feels like picking out your favorite candy at the corner store.

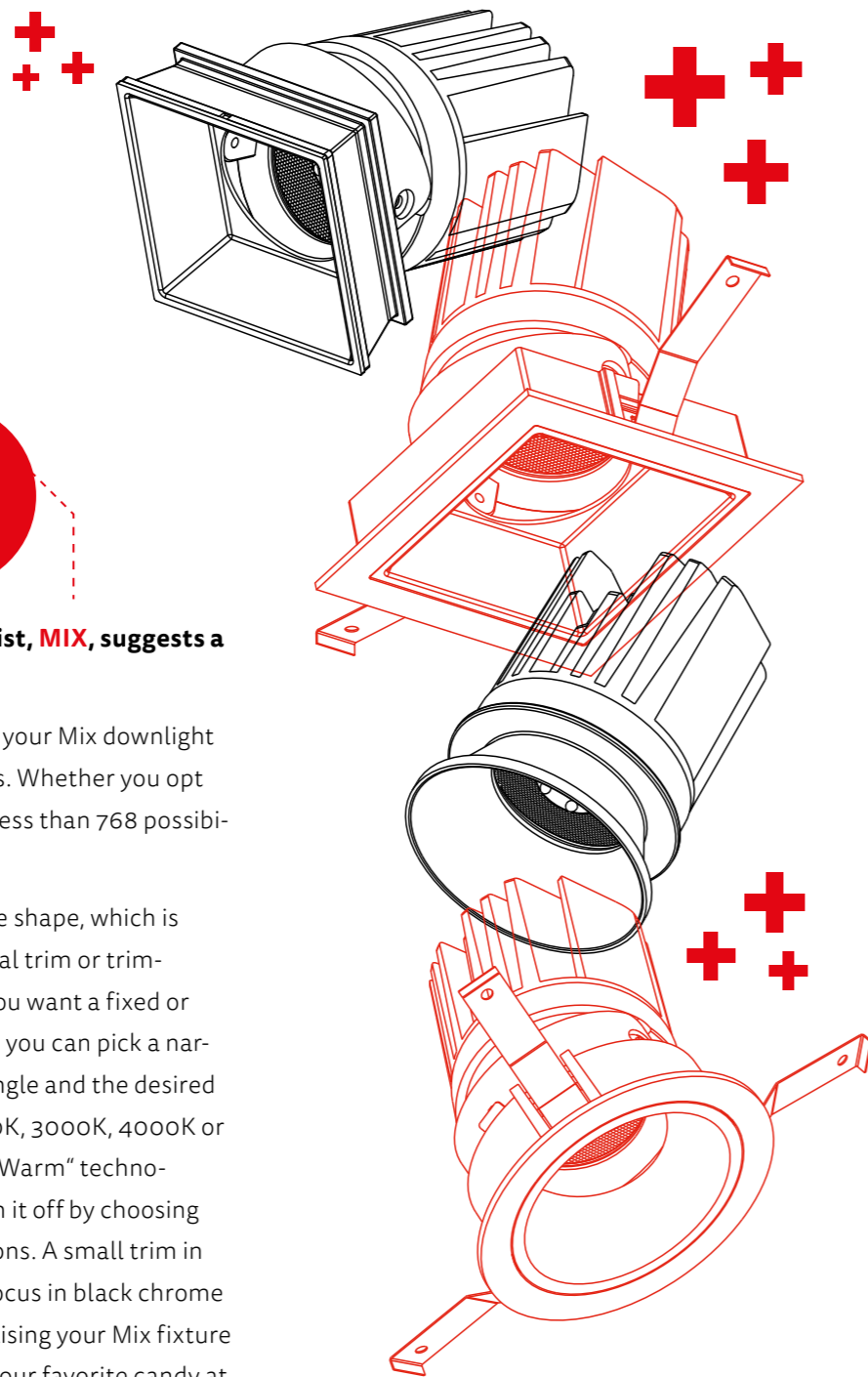

3

Finally, you picked our **48V tracks** as your third favorite. Although that's not really a family is it?

No, it's not, strictly speaking, but I do feel like they're a wonderful addition to our Think Small family. 48V is slender and subtle, it's modern and it's elegant. Our 48V track is a minimalistic track system that allows both trimless-, surface - and pendant mounting. On that track system we can fit a selection of Think Small fixtures, orientable fittings as well as pendants.

Another advantage of the 48V track system is that you can add magnetic LED modules with a

UGR⁽³⁾ value below 19. This makes the track system perfectly suitable for office use because the LEDs produce no discomfort. By the way, our 48V tracks are also good news for those who would rather avoid the hard choice between minimalistic design and DALI control. You'd think you can't have both, as the DALI system usually requires quite large gear. However, our 48V DALI fittings are minimalistic thanks to the extremely small DALI gear that fits into the adapters. ●



Black on the outside. Gold on the inside.

Some people call this the blackest gold ever seen. We call it the Black + Gold family. It is now a classic of TAL. But still leaves a bold impression. The black housing of the products contrasts beautifully to their warm, golden interior.



Shiny gold and an elegant black texture are natural partners in crime. With its unique character, the **Black + Gold series** offers that extra added aesthetic value to both classical and contemporary interiors. Throughout the range, you will discover attractive fixtures reminiscent of thirties style, of jazz clubs and of royal interiors. Black on the outside and gold on the inside, a mystifying lighting concept that will forever remain in style.



Modest in size and grand in performance

Think Small is based on the complaint of many architects and interior architects. Where are the subtle light accents that improve the architectural value of a project to a maximum?

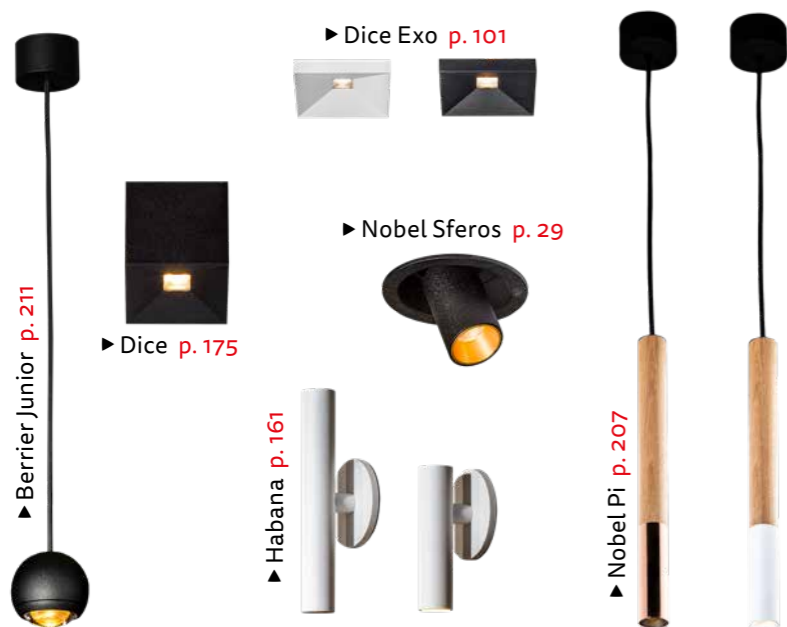

TAL has developed the answer with small and elegant lighting fixtures whose light output increases while the power consumption drastically decreases. Strikingly good for such small fixtures, don't you think?

Conical and iconic: a feast for the eye

Funnel is an extensive product family that can offer a lighting solution for any project. Typical of the family is a beautiful conical interior with recessed light source.









This design is extended from downlight (directional and non-directional) to surface-mounted (wall and ceiling) to even the pendant version. A special version of the downlight is the Funnel Exo (semi recessed) in which the inside of the downlight is, as it were, turned outwards. Funnel Elbow is a ceiling fixture with a knuckle joint allowing the user to direct the light dynamically. The Funnel product family can be used in both residential and commercial environments and is a feast for the eye in every version.

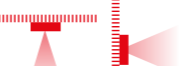
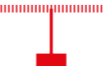

First things first: put the light on.

We can offer plenty of solutions for every room and for all your needs.

The classification on the right will get you started. Based on that, you can select the type of lighting you need. From trimless to track lighting, suspended to exterior. You will easily find all possible TAL products clearly ranked within each type.

	trimless	20
	downlights	50
	wall recessed	112
	surface mounted	122
	suspended	204
	stand alone	266
	inground uplight	272
	exterior	288
	profiles	334
	track lighting	444

trimless



NEW Mix 13 Round	22	NEW Mix 13 Square	42
NEW Mix 26 Round	26	NEW Mix 26 Square	44
NEW Nobel Sferos	29	Micro Incas	47
NEW Berrier Junior	31	Mini Projexxar	49
Intana	33		
Orbital	35		

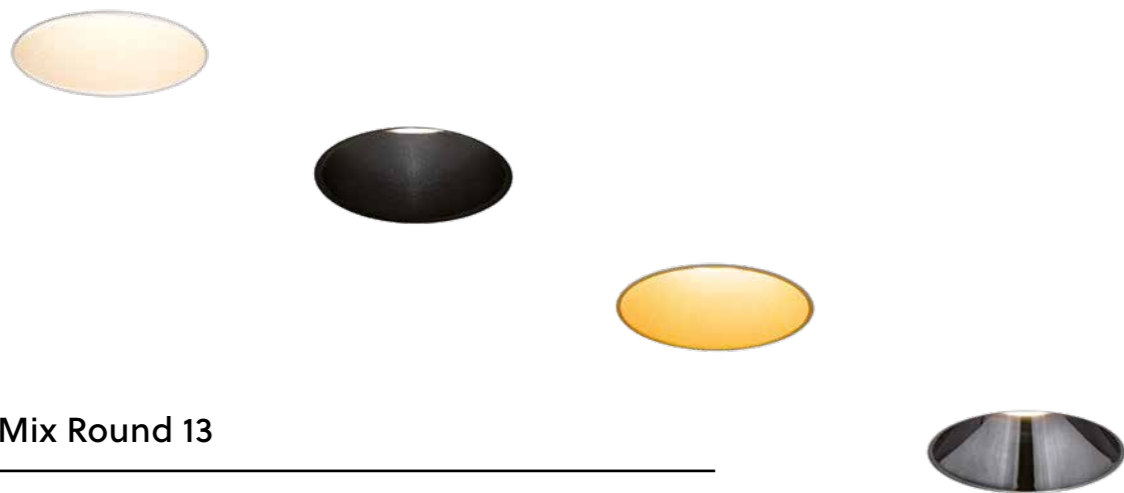

Mix Round 13

CITIZEN - 13,5W - 350mA DC - (38,6 Vf)

- 1444 lumen 2700K CRI90
- 1506 lumen 3000K CRI90
- 1556 lumen 4000K CRI90
- dimmability: PWM/CCR
- beam 15° - 36° - 60°

HALOSPHERE - 11,8W - 350mA DC - (33,8 Vf)

- 1265 lumen 1800K ▶ 3000K CRI90
- dimmability: CCR
- beam 15° - 36° - 60°

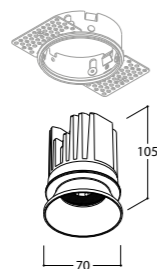

76mm
Installation depth 110mm

MIX 13W
all variations
€ 109,-

€

! Installation frame for plaster **MX130097** 20,-



! Converter matrix, see back flap

M	X	1	DIGIT 1	DIGIT 2	DIGIT 3	DIGIT 4	DIGIT 5
13W	MODEL	BEAM ANGLE	COLOUR TEMP LED	FOCUS COLOUR	FRONT COLOUR		
	1: Round	N: 15°	1: Halosphere 1800-3000K	1: Matt White	6: Textured Black		
	2: Round Flex	M: 36°	2: 2700K	2: Matt Black	7: Textured White		
	3: Trimless Round	W: 60°	3: 3000K	3: Matt Gold	0: Trimless		
	4: Trimless Round Flex		4: 4000K	4: Black Chrome			
	5: Square						
	6: Square Flex						
	7: Trimless Square						
	8: Trimless Square Flex						

! FOR MIX IP54 USE MX4 INSTEAD OF MX1 WHEN CONFIGURING AN ARTICLE NUMBER. IP54 LED MODULE IS ONLY FOR BATHROOMS

Examples of article numbers for the MIX 13 range

MX13W110 = MIX-T 13W Trimless Round 60° Halosphere Matt White Focus

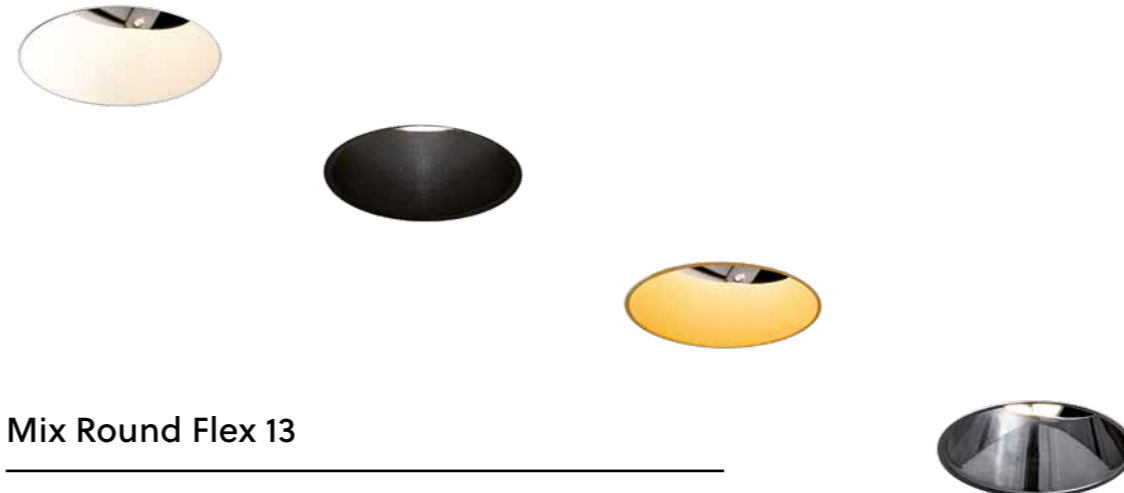

Mix Round Flex 13

CITIZEN - 13,5W - 350mA DC - (38,6 Vf)

- 1444 lumen 2700K CRI90
- 1506 lumen 3000K CRI90
- 1556 lumen 4000K CRI90
- dimmability: PWM/CCR
- beam 15° - 36° - 60°

HALOSPHERE - 11,8W - 350mA DC - (33,8 Vf)

- 1265 lumen 1800K ▶ 3000K CRI90
- dimmability: CCR
- beam 15° - 36° - 60°



76mm
Installation depth 110mm
359° 30°

MIX 13W
all variations
€ 109,-

€

! Installation frame for plaster **MX130097** 20,-

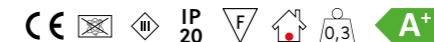

! Converter matrix, see back flap

M	X	1	DIGIT 1	DIGIT 2	DIGIT 3	DIGIT 4	DIGIT 5
13W	MODEL	BEAM ANGLE	COLOUR TEMP LED	FOCUS COLOUR	FRONT COLOUR		
	1: Round	N: 15°	1: Halosphere 1800-3000K	1: Matt White	6: Textured Black		
	2: Round Flex	M: 36°	2: 2700K	2: Matt Black	7: Textured White		
	3: Trimless Round	W: 60°	3: 3000K	3: Matt Gold	0: Trimless		
	4: Trimless Round Flex		4: 4000K	4: Black Chrome			
	5: Square						
	6: Square Flex						
	7: Trimless Square						
	8: Trimless Square Flex						

! FOR MIX IP54 USE MX4 INSTEAD OF MX1 WHEN CONFIGURING AN ARTICLE NUMBER. IP54 LED MODULE IS ONLY FOR BATHROOMS

Example of article number for the MIX 13 range

MX14N240 = MIX-T 13W Trimless Round Flex 15° 2700K Black Chrome Focus



Private house Kinrooi

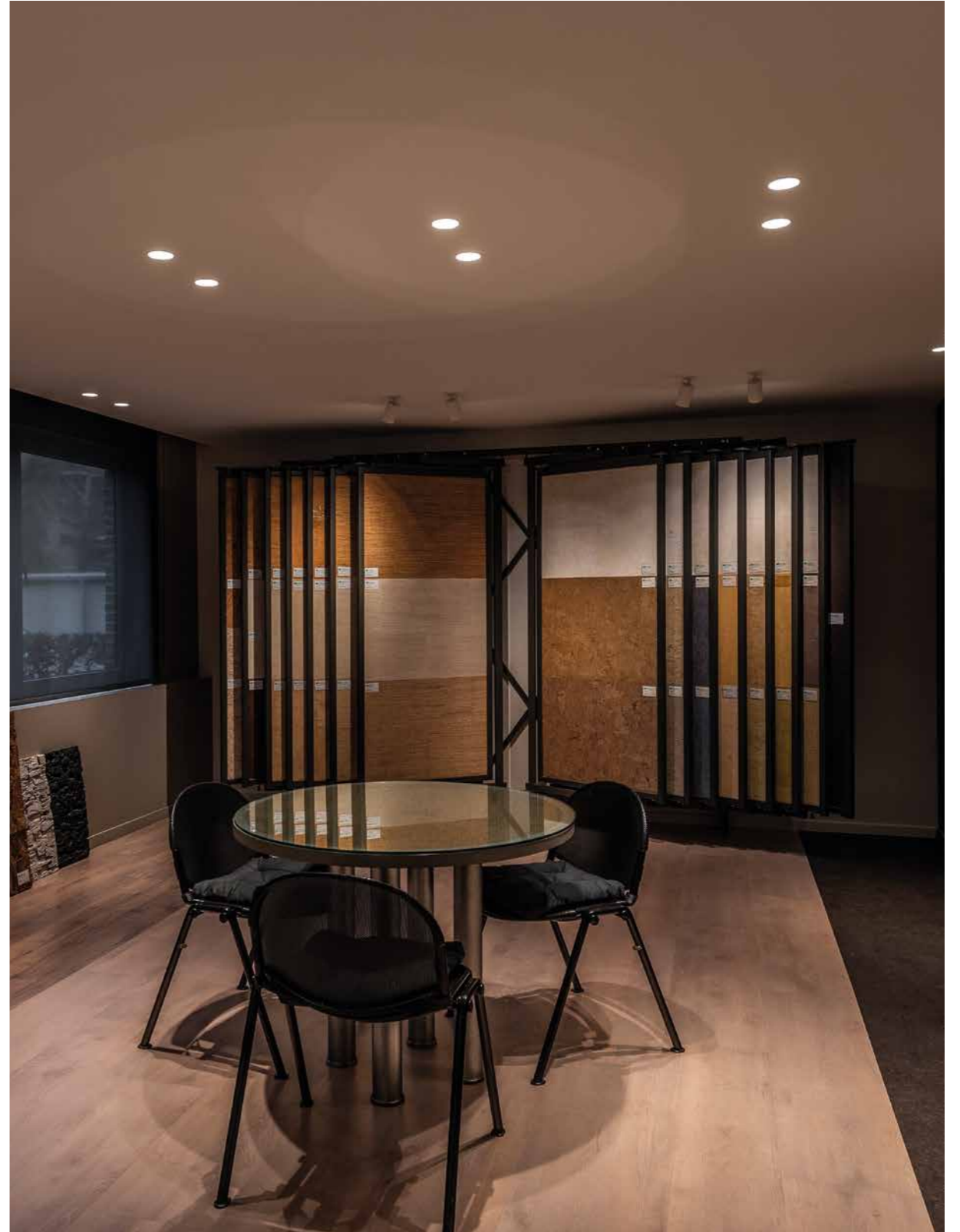

Kurk Van Avermaet

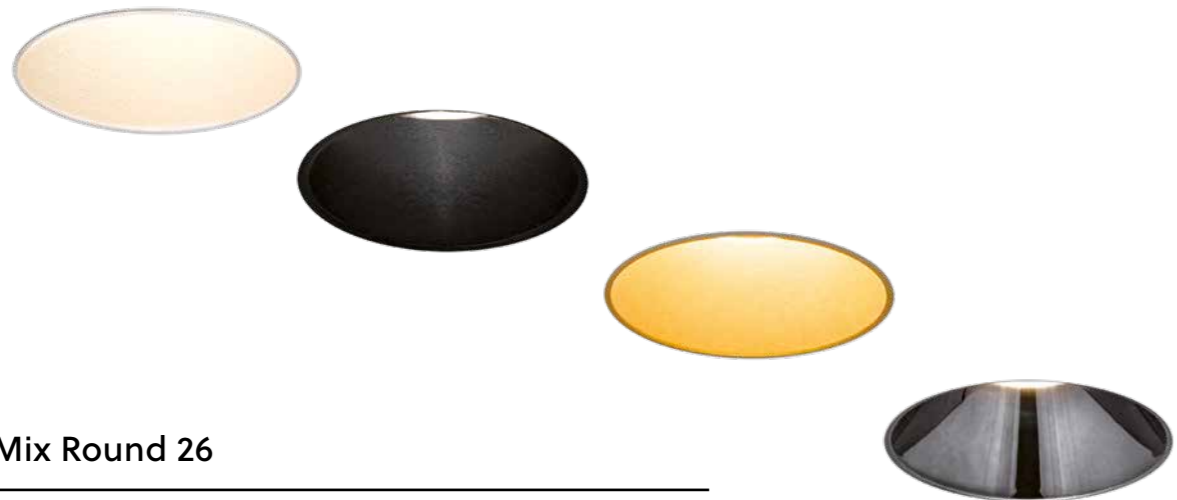

Mix Round 26

CITIZEN - 24,5W - 700mA DC - (35,1 Vf)
 3190 lumen 2700K CRI90
 3318 lumen 3000K CRI90
 3368 lumen 4000K CRI90
 dimmability: PWM/CCR
 beam 15° - 36° - 50°

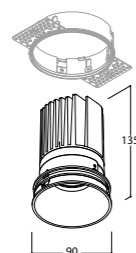

MIX 26W
 all variations
 € 149,-

100mm
 Installation depth 111mm

€

! Installation frame for plaster **MX230097** 30,-



! Converter matrix, see back flap

M	X	2	DIGIT 1	DIGIT 2	DIGIT 3	DIGIT 4	DIGIT 5
26W	MODEL	BEAM ANGLE	COLOUR TEMP LED	FOCUS COLOUR	FRONT COLOUR		
	1: Round	N: 15°		1: Matt White	6: Textured Black		
	2: Round Flex	M: 36°	2: 2700K	2: Matt Black	7: Textured White		
	3: Trimless Round	W: 50°	3: 3000K	3: Matt Gold	0: Trimless		
	4: Trimless Round Flex		4: 4000K	4: Black Chrome			
	5: Square						
	6: Square Flex						
	7: Trimless Square						
	8: Trimless Square Flex						

Example of article number for the MIX 26 range

MX23W210 = MIX-T 26W Trimless Round 60° 2700K Matt White Focus

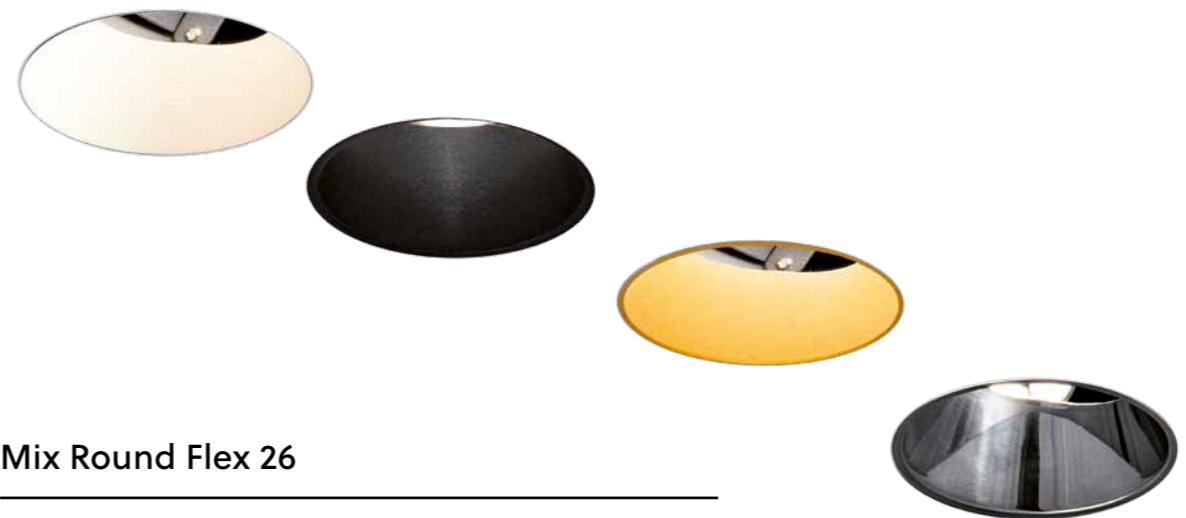

Mix Round Flex 26

CITIZEN - 24,5W - 700mA DC - (35,1 Vf)
 3190 lumen 2700K CRI90
 3318 lumen 3000K CRI90
 3368 lumen 4000K CRI90
 dimmability: PWM/CCR
 beam 15° - 36° - 50°

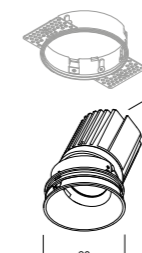

MIX 26W
 all variations
 € 149,-

100mm
 Installation depth 111mm
 359° 30°

€

! Installation frame for plaster **MX230097** 30,-

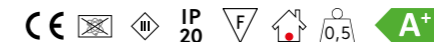

! Converter matrix, see back flap

M	X	2	DIGIT 1	DIGIT 2	DIGIT 3	DIGIT 4	DIGIT 5
26W	MODEL	BEAM ANGLE	COLOUR TEMP LED	FOCUS COLOUR	FRONT COLOUR		
	1: Round	N: 15°		1: Matt White	6: Textured Black		
	2: Round Flex	M: 36°	2: 2700K	2: Matt Black	7: Textured White		
	3: Trimless Round	W: 50°	3: 3000K	3: Matt Gold	0: Trimless		
	4: Trimless Round Flex		4: 4000K	4: Black Chrome			
	5: Square						
	6: Square Flex						
	7: Trimless Square						
	8: Trimless Square Flex						

Example of article number for the MIX 26 range

MX24N240 = MIX-T 26W Trimless Round Flex 15° 2700K Black Chrome Focus

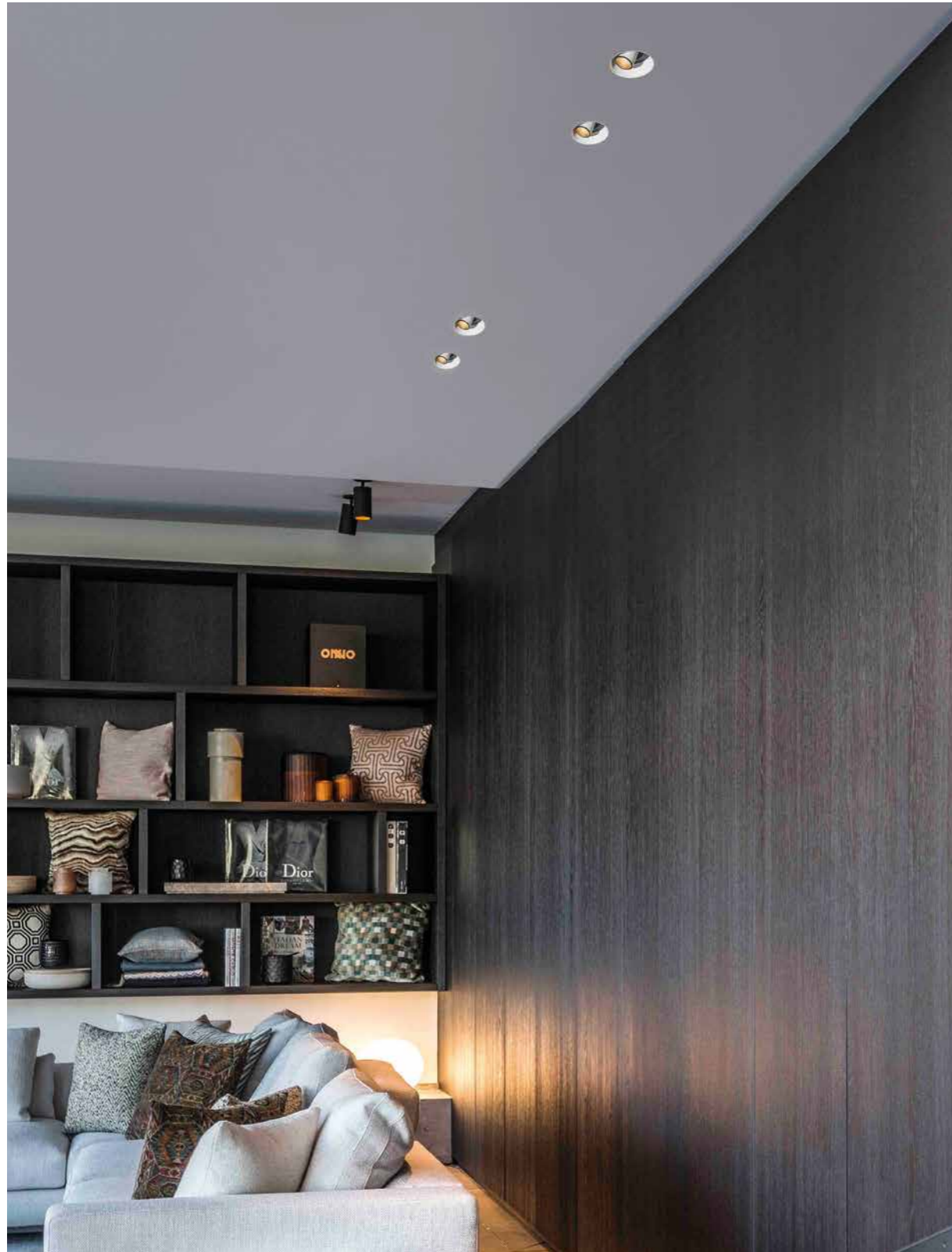

RR Luxembourg



Nobel Sferos

LUXEON M - 3,82W - 350mA DC - (10,95 Vf)

400 lumen 2700K CRI90
 429 lumen 3000K CRI90
 dimmability: PWM/CCR
 beam 36°

HALOSPHERE - 4,25W - 250mA DC - (17 Vf)

455 lumen 1800K ▶ 3000K CRI90
 dimmability: CCR
 beam 40°

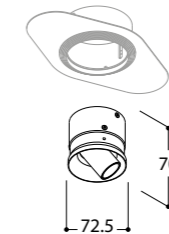

125 mm
 Installation depth 75 mm
 359° 55°

housing/ tube	focus	2700K	3000K	€	1800K- 3000K	€
●	●	498526	498516	161,-	498506	173,-
○	○	498547	498537	161,-	498527	173,-
○	●	498592	498582	165,-	498572	177,-
○	●	498594	498584	161,-	498574	173,-
●	○	498595	498585	161,-	498575	173,-
●	●	498596	498586	165,-	498576	177,-
! installation frame for plaster					701113	37,-

Family members:



4000K ON DEMAND Converter matrix, see back flap



Private house Ghent



Berrier Junior Semi Recessed

LUXEON M - 3,82W - 350mA DC - (10,95 Vf)

400 lumen 2700K CRI90
 429 lumen 3000K CRI90
 dimmability: PWM/CCR
 beam 60°

HALOSPHERE - 4,25W - 250mA DC - (17 Vf)

455 lumen 1800K ▶ 3000K CRI90
 dimmability: CCR
 beam 60°

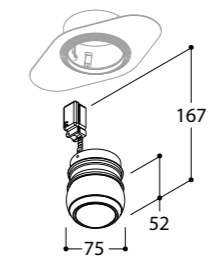

125 mm
 Installation depth 80 mm
 359° 45°

housing	front	2700K	3000K	€	1800K-3000K	€
●	●	456302	456312	201,-	456392	213,-
●	●	456344	456354	201,-	456314	213,-
●	●	456345	456355	201,-	456315	213,-
○	○	456334	456324	201,-	456304	213,-
○	●	456352	456362	201,-	456322	213,-
●	●	456396	456386	205,-	456376	217,-
! installation frame for plaster					701116	46,-

Family members:



4000K ON DEMAND Converter matrix, see back flap

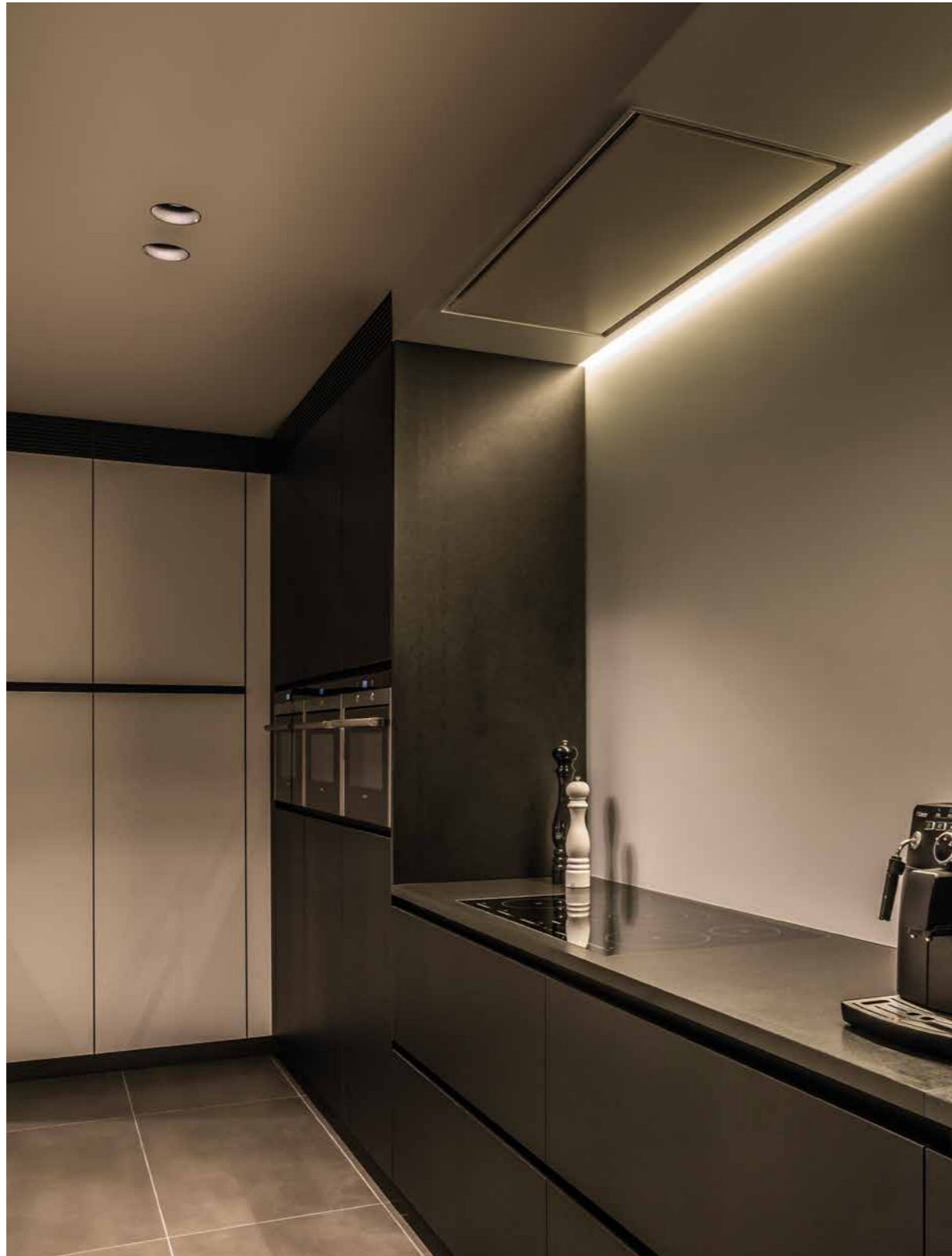

Private house Rumbeke

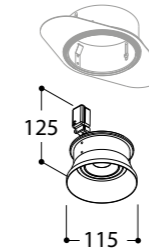

Intana Beaufort

CITIZEN - 6,22W - 180mA DC - (34,6 Vf)
 758 lumen 2700K CRI92
 793 lumen 3000K CRI92
 dimmability: PWM/CCR
 beam 36°



 **GU 10 versions: see website**

 140 mm
 Installation depth 130 mm
 359°  30°

finish	2700K	3000K	€
	133847	133857	146,-
	133826	133836	146,-
 Intana frame	701111		53,-



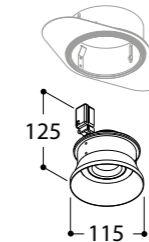

Intana Haloled

LUXEON M - 7,84W - 700mA DC - (11,2 Vf)
 755 lumen 2700K CRI90
 793 lumen 3000K CRI90
 dimmability: PWM/CCR
 beam 36°



 **GU 10 versions: see website**

 140 mm
 Installation depth 130 mm
 359°  15°

finish	2700K	3000K	€
	133807	133817	132,-
	133806	133816	132,-
 Intana frame	701111		53,-





Private house Ardoois

Orbital Flow Control

ANNULAR LED ARRAY - 12,3W - 350mA DC - (35,1 Vf)

1460 lumen 2700K CRI92
1486 lumen 3000K CRI92
dimmability: PWM/CCR
beam 120°

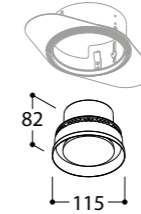

HALOSPHERE - 12,7W - 350mA DC - (36 Vf)

1230 lumen 1800K ▶ 3000K CRI87
dimmability: CCR
beam 120°

140 mm
Installation depth 180 mm
(when using flexible ventilation
valve Ø80mm)

finish	2700K	3000K	€	1800K-3000K	€
○	650247	650267	181,-	650287	198,-
●	650246	650266	181,-	650286	198,-
! Trimless frame	701112	56,-		140 x H 130 mm	



finish	3400K	4000K	€	2500K-4000K	€
○	650257	650277	228,-	650297	241,-
●	650256	650276	228,-	650296	241,-
! Trimless frame	701112	56,-		140 x H 130 mm	



Flow control = Ventilation valve

- Supply valve / extract valve
- Incorporated adjustable flow regulator

FLOW CONTROL (DISC @-30mm) SUPPLY		FLOW CONTROL (DISC @-30mm) EXHAUST	
SOUND POWER Lw(dB(A))	FLOW RATE (m³/h)	SOUND POWER Lw(dB(A))	FLOW RATE (m³/h)
35,0	68,0	35,0	85,0
30,0	56,0	30,0	71,0
25,0	47,0	25,0	59,0

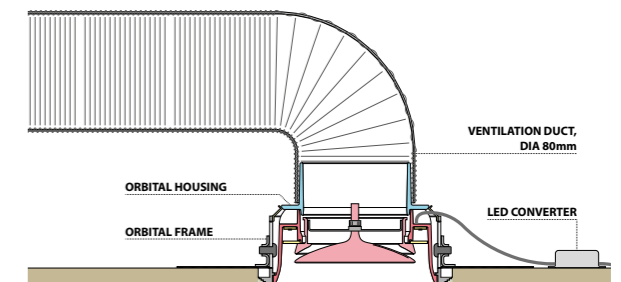

! Converter matrix, see back flap



trimless

140 mm

Orbital Designed by Bruno Erpicum

Orbital Light Only Flow Control Look

ANNULAR LED ARRAY- 12,3W - 350mA DC - (35,1 Vf)

1460 lumen 2700K CRI92
1486 lumen 3000K CRI92
dimmability: PWM/CCR
beam 120°

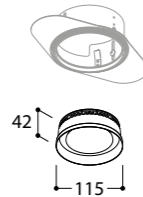

HALOSPHERE - 12,7W - 350mA DC - (36 Vf)

1230 lumen 1800K ▶ 3000K CRI87
dimmability: CCR
beam 120°

140 mm
Installation depth 130 mm



finish	2700K	3000K	€	1800K-3000K	€
○	650047	650067	140,-	650087	164,-
●	650046	650066	140,-	650086	164,-

Trimless frame 701112 56,- 140 x H 130 mm



finish	3400K	4000K	€	2500K-4000K	€
○	650057	650077	186,-	650097	200,-
●	650056	650076	186,-	650096	200,-

Trimless frame 701112 56,- 140 x H 130 mm



Orbital Light Only Through Flow Look

ANNULAR LED ARRAY- 12,3W- 350mA DC - (35,1 Vf)

1460 lumen 2700K CRI92
1486 lumen 3000K CRI92
dimmability: PWM/CCR
beam 120°

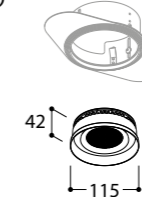

HALOSPHERE - 12,7W - 350mA DC - (36 Vf)

1230 lumen 1800K ▶ 3000K CRI87
dimmability: CCR
beam 120°

140 mm
Installation depth 130 mm



finish	2700K	3000K	€	1800K-3000K	€
○	650044	650064	156,-	650084	180,-
●	650042	650062	156,-	650082	180,-

Trimless frame 701112 56,- 140 x H 130 mm



finish	3400K	4000K	€	2500K-4000K	€
○	650054	650074	202,-	650094	215,-
●	650052	650072	202,-	650092	215,-

Trimless frame 701112 56,- 140 x H 130 mm





Private house Oostduinkerke

Orbital Through Flow

ANNULAR LED ARRAY - 12,3W - 350mA DC - (35,1 Vf)

1460 lumen 2700K CRI92
1486 lumen 3000K CRI92
dimmability: PWM/CCR
beam 120°



HALOSPHERE - 12,7W - 350mA DC - (36 Vf)

1230 lumen 1800K ▶ 3000K CRI87
dimmability: CCR
beam 120°

140 mm
Installation depth 180 mm
(when using flexible ventilation
valve Ø80mm)



finish	2700K	3000K	€	1800K-3000K	€
○	650147	650167	160,-	650187	184,-
●	650146	650166	160,-	650286	184,-
! Trimless frame	701112	56,-		140 x H 130 mm	

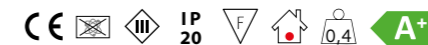

finish	3400K	4000K	€	2500K-4000K	€
○	650157	650177	206,-	650197	219,-
●	650156	650176	206,-	650196	219,-
! Trimless frame	701112	56,-		140 x H 130 mm	

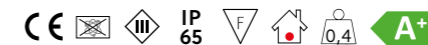

Flow control = Ventilation valve

- Supply valve / extract valve
- Flow regulator must be provided in air ducts

THROUGH FLOW SUPPLY		THROUGH FLOW EXHAUST	
SOUND POWER Lw(dB(A))	FLOW RATE (m³/h)	SOUND POWER Lw(dB(A))	FLOW RATE (m³/h)
35,0	93,0	35,0	94,0
30,0	77,0	30,0	77,0
25,0	63,0	25,0	62,0

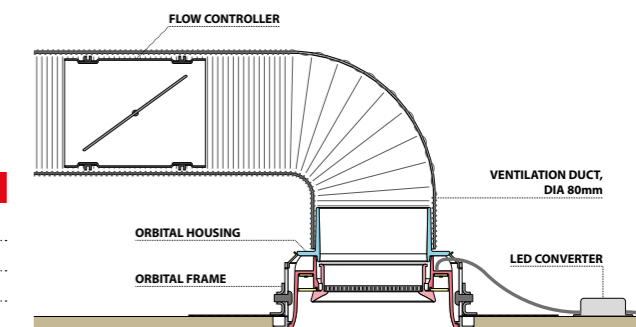

! Converter matrix, see back flap

Orbital Loudspeaker

ANNULAR LED ARRAY - 12,3W - 350mA DC - (35,1 Vf)

1460 lumen 2700K CRI92
1486 lumen 3000K CRI92
dimmability: PWM/CCR
beam 120°

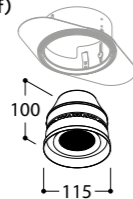

HALOSPHERE - 12,7W - 350mA DC - (36 Vf)

1230 lumen 1800K ▶ 3000K CRI87
dimmability: CCR
beam 120°

140 mm
Installation depth 130 mm



finish	2700K	3000K	€	1800K-3000K	€
○	650347	650367	248,-	650387	288,-
●	650346	650366	248,-	650386	288,-
! Trimless frame	701112	56,-		140 x H 130 mm	



Sound = 3" full range speaker

- Max. power = 30W
- Rated power input = 15W
- Nominal impedance = 8ohm
- DCR impedance = 6,6ohm
- Sensitivity 1w/1m = 88db
- Frequency response = 75hz-20khz

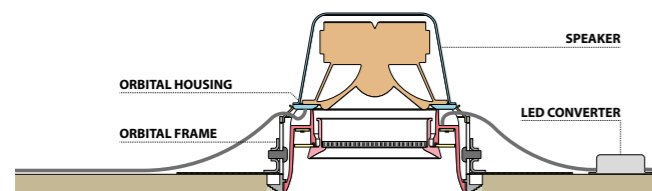

! Converter matrix, see back flap

Orbital Smoke Detector

ANNULAR LED ARRAY - 12,3W - 350mA DC - (35,1 Vf)

1460 lumen 2700K CRI92
1486 lumen 3000K CRI92
dimmability: PWM/CCR
beam 120°

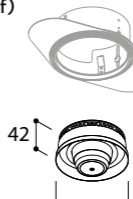

HALOSPHERE - 12,7W - 350mA DC - (36 Vf)

1230 lumen 1800K ▶ 3000K CRI87
dimmability: CCR
beam 120°

140 mm
Installation depth 130 mm



finish	2700K	3000K	€	1800K-3000K	€
○	650447	650467	289,-	650487	329,-
●	650446	650466	289,-	650486	329,-
! Trimless frame	701112	56,-		140 x H 130 mm	

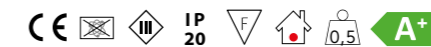

Smoke = Optical smoke alarm device

- Integrated wireless interlink
- (Max. 32 devices) - RF: 868MHz
- Replacable 3V CR123A
- Lithium battery 1600mah
- Min. 5 year battery life
- Low battery indication
- 100 m open field range
- Visible indicator
- Frequency response = 75hz-20khz

! Converter matrix, see back flap



Mix Square 13

CITIZEN - 13,5W - 350mA DC - (38,6 Vf)

- 1444 lumen 2700K CRI90
- 1506 lumen 3000K CRI90
- 1556 lumen 4000K CRI90
- dimmability: PWM/CCR
- beam 15° - 36° - 60°

HALOSPHERE - 11,8W - 350mA DC - (33,8 Vf)

- 1265 lumen 1800K ▶ 3000K CRI90
- dimmability: CCR
- beam 15° - 36° - 60°

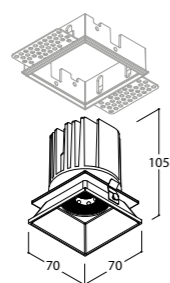

MIX 13W
all variations
€ 109,-

76x76 mm
Installation depth 110mm

€

! Installation frame for plaster **MX170097** 20,-



! Converter matrix, see back flap

M	X	1	DIGIT 1	DIGIT 2	DIGIT 3	DIGIT 4	DIGIT 5
13W	MODEL	BEAM ANGLE	COLOUR TEMP LED	FOCUS COLOUR	FRONT COLOUR		
	1: Round	N: 15°	1: Halosphere 1800-3000K	1: Matt White	6: Textured Black		
	2: Round Flex	M: 36°	2: 2700K	2: Matt Black	7: Textured White		
	3: Trimless Round	W: 60°	3: 3000K	3: Matt Gold	0: Trimless		
	4: Trimless Round Flex		4: 4000K	4: Black Chrome			
	5: Square						
	6: Square Flex						
	7: Trimless Square						
	8: Trimless Square Flex						

! FOR MIX IP54 USE MX4 INSTEAD OF MX1 WHEN CONFIGURING AN ARTICLE NUMBER. IP54 ONLY FOR BATHROOMS

Example of article number for the MIX 13 range

MX17W440 = MIX-T 13W Trimless Square 60° 4000K Black Chrome Focus



Mix Square Flex 13

CITIZEN - 13,5W - 350mA DC - (38,6 Vf)

- 1444 lumen 2700K CRI90
- 1506 lumen 3000K CRI90
- 1556 lumen 4000K CRI90
- dimmability: PWM/CCR
- beam 15° - 36° - 60°

HALOSPHERE - 11,8W - 350mA DC - (33,8 Vf)

- 1265 lumen 1800K ▶ 3000K CRI90
- dimmability: CCR
- beam 15° - 36° - 60°

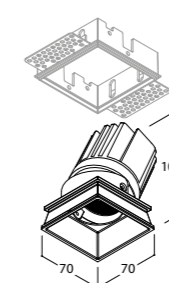

MIX 13W
all variations
€ 109,-

76x76 mm
Installation depth 110 mm
30°

€

! Installation frame for plaster **MX170097** 20,-

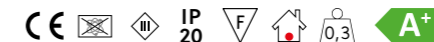

! Converter matrix, see back flap

M	X	1	DIGIT 1	DIGIT 2	DIGIT 3	DIGIT 4	DIGIT 5
13W	MODEL	BEAM ANGLE	COLOUR TEMP LED	FOCUS COLOUR	FRONT COLOUR		
	1: Round	N: 15°	1: Halosphere 1800-3000K	1: Matt White	6: Textured Black		
	2: Round Flex	M: 36°	2: 2700K	2: Matt Black	7: Textured White		
	3: Trimless Round	W: 60°	3: 3000K	3: Matt Gold	0: Trimless		
	4: Trimless Round Flex		4: 4000K	4: Black Chrome			
	5: Square						
	6: Square Flex						
	7: Trimless Square						
	8: Trimless Square Flex						

! FOR MIX IP54 USE MX4 INSTEAD OF MX1 WHEN CONFIGURING AN ARTICLE NUMBER. IP54 ONLY FOR BATHROOMS

Examples of article numbers for the MIX 13 range

MX18M310 = MIX-T 13W Trimless Square Flex 36° 3000K Matt White Focus

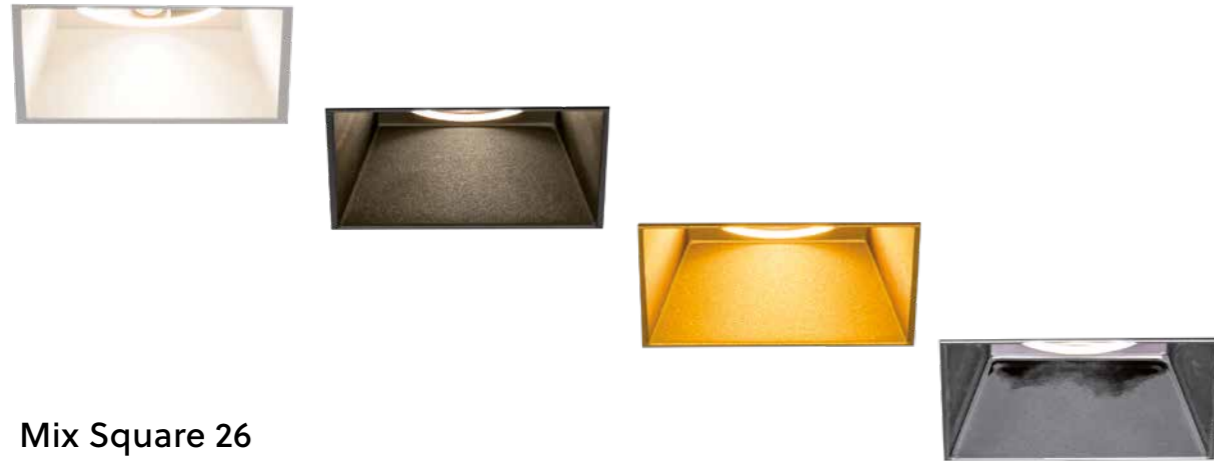

Mix Square 26

CITIZEN - 24,5W - 700mA DC - (35,1 Vf)
 3190 lumen 2700K CRI90
 3318 lumen 3000K CRI90
 3368 lumen 4000K CRI90
 dimmability: PWM/CCR
 beam 15° - 36° - 50°

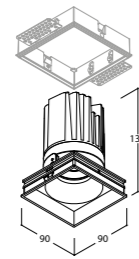

100x100 mm
 Installation depth 110x110 mm

MIX 26W
 all variations
 € 149,-

€

! Installation frame for plaster **MX270097** 30,-



! Converter matrix, see back flap

M	X	2	DIGIT 1	DIGIT 2	DIGIT 3	DIGIT 4	DIGIT 5
26W	MODEL	BEAM ANGLE	COLOUR TEMP LED	FOCUS COLOUR	FRONT COLOUR		
	1: Round	N: 15°		1: Matt White	6: Textured Black		
	2: Round Flex	M: 36°	2: 2700K	2: Matt Black	7: Textured White		
	3: Trimless Round	W: 50°	3: 3000K	3: Matt Gold	0: Trimless		
	4: Trimless Round Flex		4: 4000K	4: Black Chrome			
	5: Square						
	6: Square Flex						
	7: Trimless Square						
	8: Trimless Square Flex						

Example of article number for the MIX 26 range

MX27W440 = MIX-T 26W Trimless Square 60° 4000K Black Chrome Focus

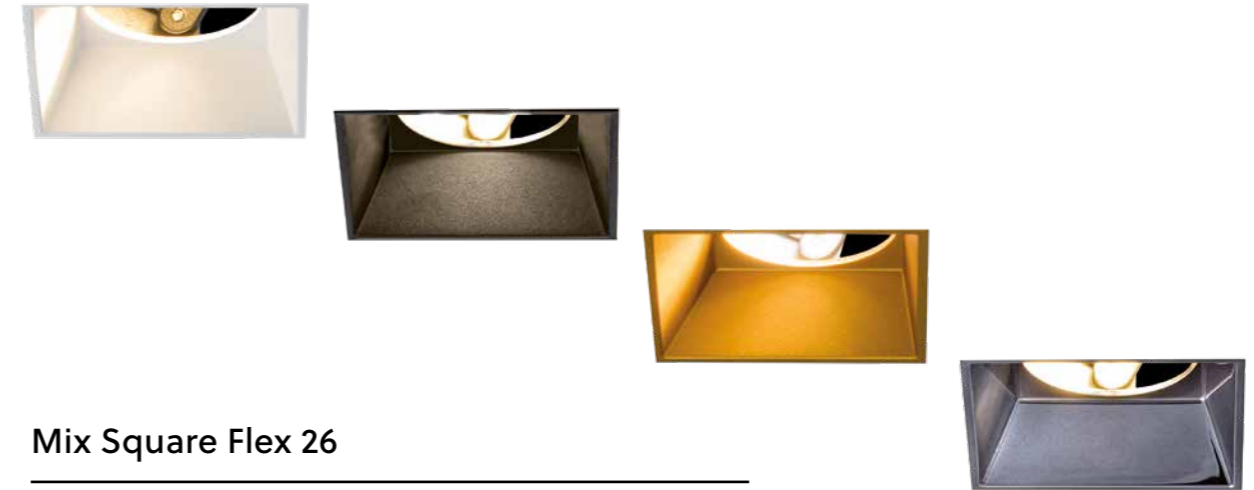

Mix Square Flex 26

CITIZEN - 24,5W - 700mA DC - (35,1 Vf)
 3190 lumen 2700K CRI90
 3318 lumen 3000K CRI90
 3368 lumen 4000K CRI90
 dimmability: PWM/CCR
 beam 15° - 36° - 50°

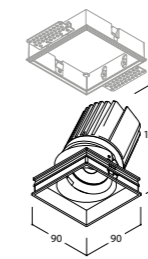

100x100 mm
 Installation depth 110x110 mm
 30°

MIX 26W
 all variations
 € 149,-

€

! Installation frame for plaster **MX270097** 30,-

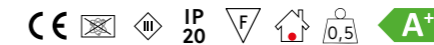

! Converter matrix, see back flap

M	X	2	DIGIT 1	DIGIT 2	DIGIT 3	DIGIT 4	DIGIT 5
26W	MODEL	BEAM ANGLE	COLOUR TEMP LED	FOCUS COLOUR	FRONT COLOUR		
	1: Round	N: 15°		1: Matt White	6: Textured Black		
	2: Round Flex	M: 36°	2: 2700K	2: Matt Black	7: Textured White		
	3: Trimless Round	W: 50°	3: 3000K	3: Matt Gold	0: Trimless		
	4: Trimless Round Flex		4: 4000K	4: Black Chrome			
	5: Square						
	6: Square Flex						
	7: Trimless Square						
	8: Trimless Square Flex						

Example of article number for the MIX 26 range

MX28M310 = MIX-T 26W Trimless Square Flex 36° 3000K Matt White Focus

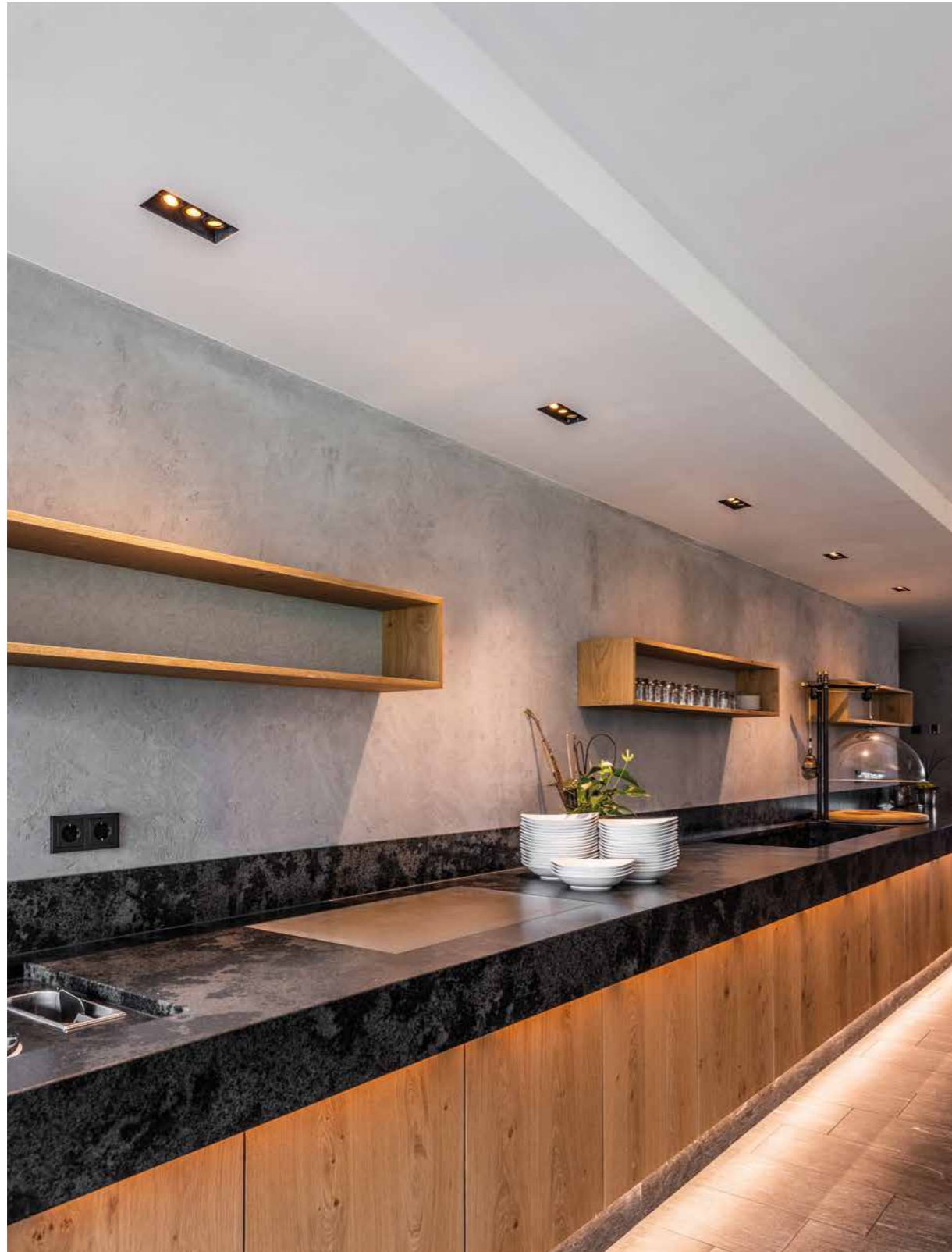

Winkler Hotel Bolzano



Micro Incas 3

LUXEON M (3X) 3,82W - 350mA DC - (32,85 Vf)

3x 400 lumen 2700K CRI90
 3x 429 lumen 3000K CRI90
 dimmability: PWM/CCR
 beam 36°

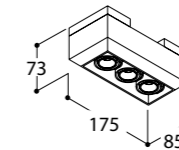

HALOSPHERE - (3X) 4,25W - 250mA DC - (51 Vf)

3x 455 lumen 1800K ▶ 3000K CRI90
 dimmability: CCR
 beam 40°

177 x 87 mm
 Installation depth 80 mm
 35° 20°



Reference numbers are for Box + Module

module & rings	focus	2700K	3000K	€	1800K-3000K	€
○	○	419847	419837	294,-	419827	331,-
●	●	419826	419816	294,-	419806	331,-
●	○	419895	419885	294,-	419875	331,-
○	●	419894	419884	294,-	419874	331,-
●	●	419896	419886	306,-	419876	343,-

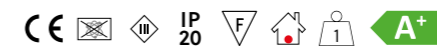

4000K ON DEMAND

Converter matrix, see back flap

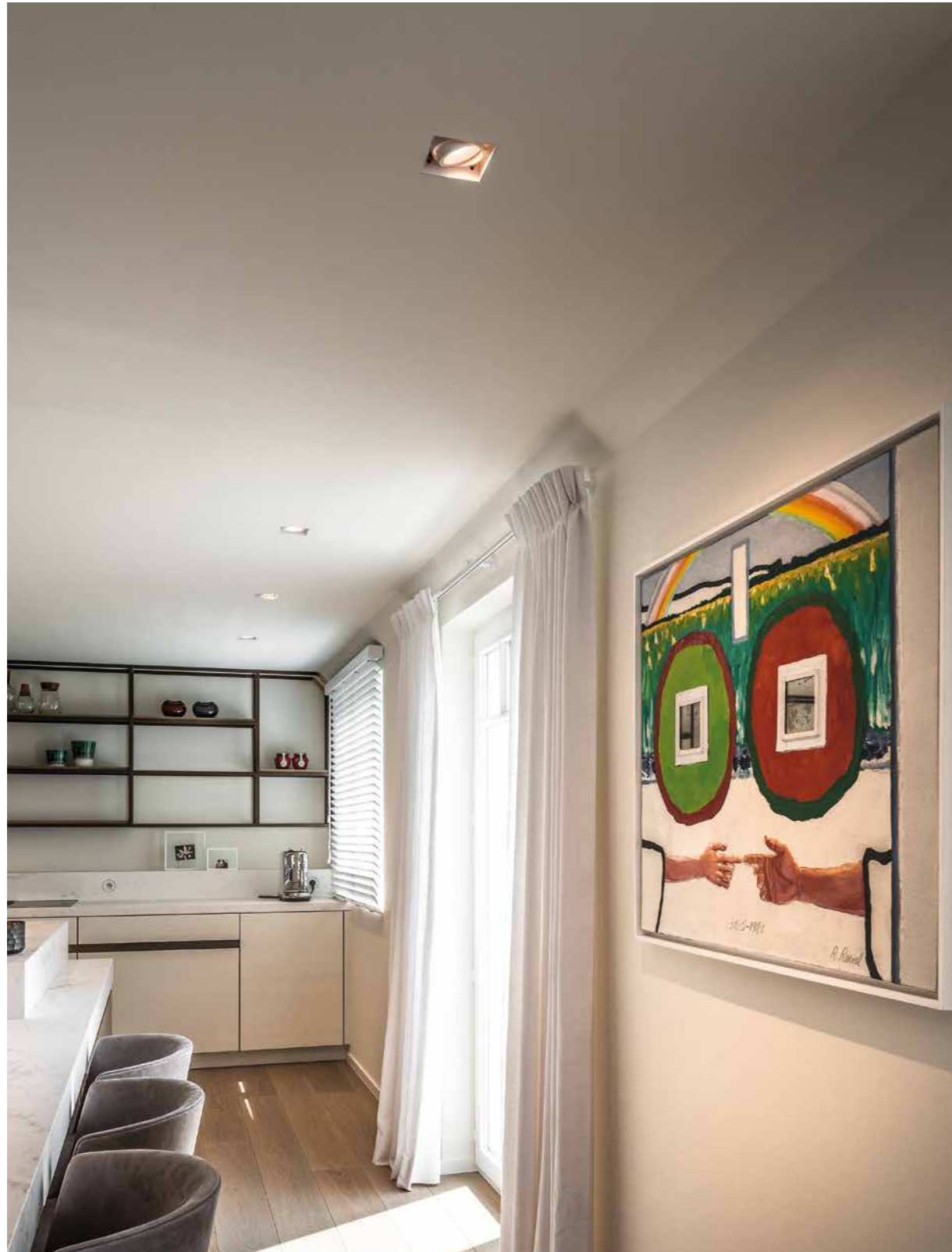

Private house Knokke

Mini Projexxar 1 Beaufort

CITIZEN - 6,22W - 180mA DC - (34,6 Vf)

758 lumen 2700K CRI92
793 lumen 3000K CRI92
dimmability: PWM/CCR
beam 36°

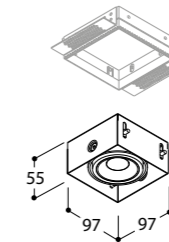

↻ 30° ↻ 30°

finish	2700K	3000K	€
○	409527	409537	117,-
●	409526	409536	117,-

🔧 Installation frame for plaster 409177 20,- 📏 110 x 110 x 60 mm



Mini Projexxar 2 Beaufort

CITIZEN (2X) 6,22W - 180mA DC - (2x 34,6 Vf)

2x 758 lumen 2700K CRI92
2x 793 lumen 3000K CRI92
dimmability: PWM/CCR
beam 36°

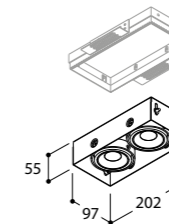

↻ 30° ↻ 30°

finish	2700K	3000K	€
○	409627	409637	216,-
●	409626	409636	216,-

🔧 Installation frame for plaster 409277 23,- 📏 215 x 110 x 60 mm

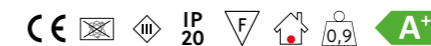

downlights



Mini Helax	55	Micro Tommy	90
Helax	57	Mini Tommy	97
Micro Eclips	63	Dice Exo	101
Funnel	65	NEW Mix 13 Square	102
Nobel Sferos	71	Solid Square	104
Cedrus	73	Quad	106
NEW Mix 13 Round	76	B4	109
Solid Round	78	NEW Mix 26 Square	110
Simplon	80		
NEW Mix 26 Round	82		
Orbital	84		

Overview round cut out

	UK CUT OUT	F DECOUPE	D AUSSCHNITT	NL ZAAGGAT	E CORTE	I TAGLIO
	Cut out round	Decoupe ronde	Ausschnitt rund	Inbouwopening rond	Corte redondo	Taglio rotondo
	Cut out square	Decoupe square	Ausschnitt quadratisch	Inbouwopening vierkant	Corte cuadrado	Taglio quadrato











DIA	FIXTURE	MIN. RECESSED DEPTH	PAGE
40	Mini Helax	60	55
55	Helax SML Torsion	65	57
56	Dice Exo	60	101
	Helax Sml Leaf	55 (70 for solid)	57
	Funnel Exo	65 (80 For solid)	65
	Micro Eclips Leaf	50 (65 for solid)	63
	Micro Eclips Torsion	50	63
70	Helax 70 Haloled	85 (100 for solid)	59
	Helax Haloled IP54	85 (100 for solid)	295
	Nobel Sferos	75	71
76	Funnel Fix	75 (90 for solid)	67
	Cedrus Quantum Leaf	85 (100 for solid)	73
	Cedrus Quantum Torsion	100	73
	Mix Round I3	110	76
80	B4 Leaf	75 (90 for solid)	109
	B4 Torsion	75	109
	Solid GU10	135	78
	Solid Haloled	55 (70 for solid)	79
82	Simplon Haloled Torsion	55	81
	Simplon Haloled Leaf	55 (70 for solid)	81
	Simplon Beaufort Torsion	45	80
	Simplon Beaufort Leaf	45 (60 for solid)	80
83	Cedrus GU10 Leaf	125	75
	Cedrus GU10 Torsion	130	75
	Cedrus Beaufort	100 (125 for solid)	tal.be
	Helva GU10	130	tal.be
	Helva Beaufort Torsion	70	tal.be
	Helva Beaufort Leaf	70 (80 for solid)	tal.be
	Funnel Flex	75 (90 For solid)	69

DIA	FIXTURE	MIN. RECESSED DEPTH	PAGE
95	Helax SML Haloled	85 (100 for solid)	60
100	Mix Round 26	140	82
125	Orbital Light Only-Smoke	45	84
127	Helax SML Beaufort ²	90 (105 for solid)	61







Downlights with limited installation depth (<65mm)

i No interference with the vapour barrier: Ideal for super insulated houses



Round cut out downlights

MIN. RECESSED DEPTH	FIXTURE	PAGE
45	 Simplon Beaufort Torsion	82 80
45 (60 for solid)	 Simplon Beaufort Leaf	82 80
50	 Micro Eclips	56 63
55 (70 for solid)	 Helax SML Leaf	55 57
55 (70 for solid)	 Solid Haloled	80 79
55 (70 for solid)	 Simplon Haloled	82 80
60	 Mini Helax	40 55
60	 Dice Exo	56 101
65	 Funnel Exo	56 65
65	 Helax SML Torsion	55 57

Rectangular cut out downlights

MIN. RECESSED DEPTH	FIXTURE	PAGE
60	 Micro Tommy 1	52 X 52 90
60	 Micro Tommy 2	114 X 52 91
60	 Micro Tommy 3	162 X 52 91
60	 Micro Tommy IP54	52 X 52 95
60	 Mini Tommy 1 Beaufort	110 X 110 97
60	 Mini Tommy 2 Beaufort	210 X 110 97

Trimless

MIN. RECESSED DEPTH	FIXTURE	PAGE
60	 Mini Tommy 1 Beaufort	112 X 112 tal.be
60	 Mini Tommy 2 Beaufort	213 X 112 tal.be



Naomie

Mini Helax 400

LUXEON M - 3,82W - 350mA DC - (10,95 Vf)

400 lumen 2700K CRI90
 429 lumen 3000K CRI90
 dimmability: PWM/CCR
 beam 36°

HALOSPHERE - 4,25W - 250mA DC- (17 Vf)

455 lumen 1800K ▶ 3000K CRI90
 dimmability: CCR
 beam 40°

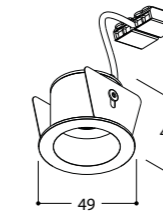

40 mm
 Installation depth 60 mm

finish	2700K	3000K	€	1800K-3000K	€
○	178930	178931	63,-	178927	75,-
●	178936	178937	63,-	178928	75,-
+ Frame for plaster	178900		9,-		

IP54
 see exterior

Family members:



4000K ON DEMAND

Converter matrix, see back flap



Mini Helax

downlights

40 mm



Private house Ardoois

Helax SML Leaf

LUXEON M - 3,82W - 350mA DC - (10,95 Vf)

400 lumen 2700K CRI90
 429 lumen 3000K CRI90
 dimmability: PWM/CCR
 beam 36°

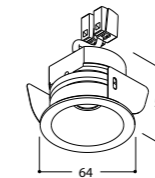

- 56 mm solid ceilings
Installation depth 70 mm
- 55 mm hollow ceilings
Installation depth 55 mm

finish	2700K	3000K	€
	178347	178357	77,-
	178326	178336	77,-
Frame for plaster	178000		9,-

IP54
IP65
see exterior

Family members:

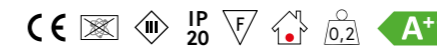

Helax SML Torsion

LUXEON M - 3,82W - 350mA DC - (10,95 Vf)

400 lumen 2700K CRI90
 429 lumen 3000K CRI90
 dimmability: PWM/CCR
 beam 36°

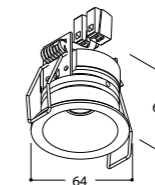

- 55 mm
Installation depth 65 mm

finish	2700K	3000K	€
	178447	178457	77,-
	178426	178436	77,-
Frame for plaster	178000		9,-

IP54
IP65
see exterior

Family members:

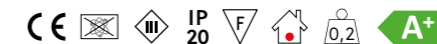

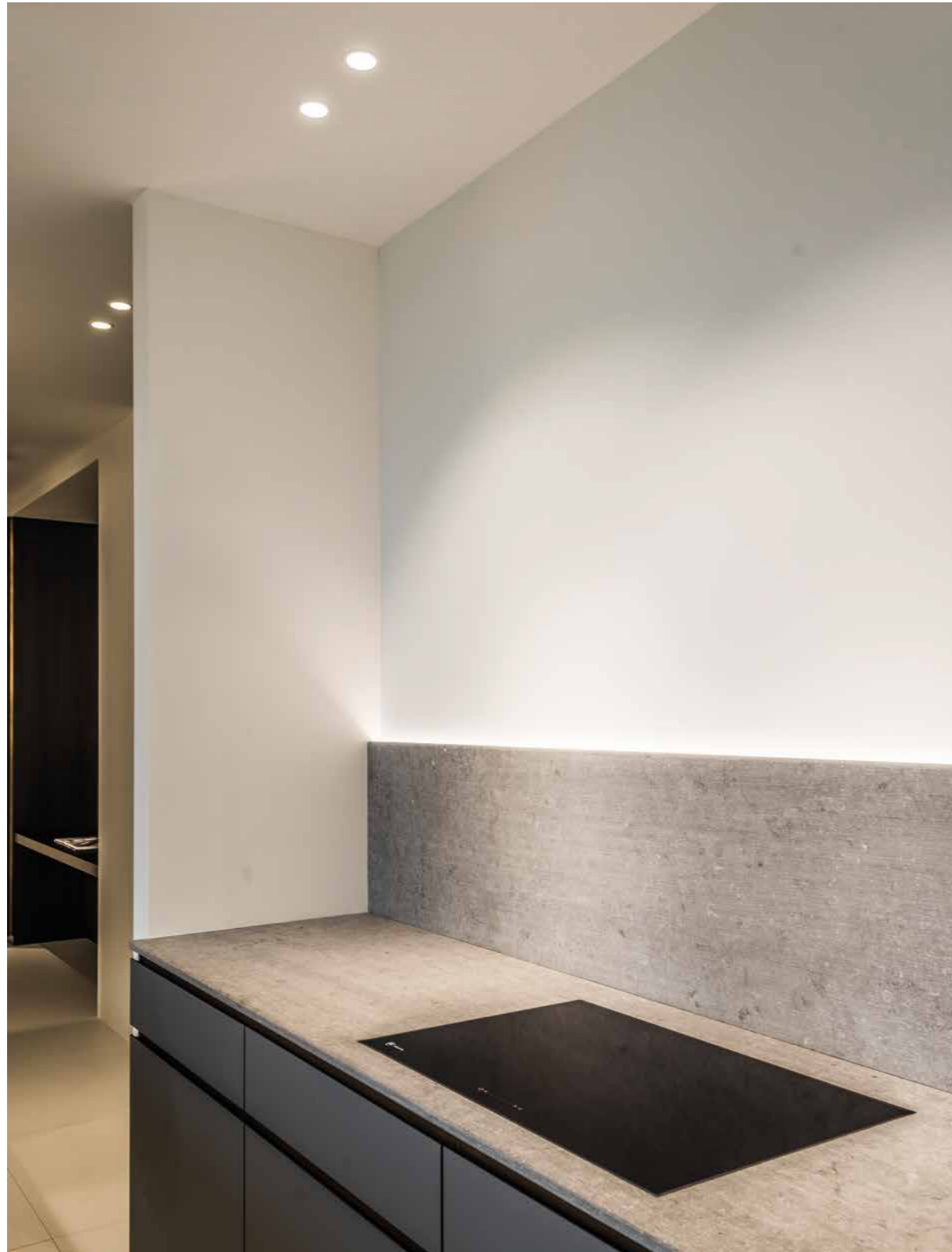

Private house Ardoois

Helax 70 Haloled Leaf

LUXEON M - 7,84W - 700mA DC - (11,2 Vf)

755 lumen 2700K CRI90
810 lumen 3000K CRI90
dimmability: PWM/CCR
beam 36°

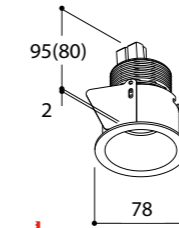

70 mm
Installation depth:
100 mm solid ceilings /
85 mm hollow ceilings



GU 10 versions: see website

finish	2700K	3000K	€
○	248047	248057	91,-
●	248046	248056	91,-
+	Frame for plaster	498100	11,-



Helax 70 Haloled Torsion

LUXEON M - 7,84W - 700mA DC - (11,2 Vf)

755 lumen 2700K CRI90
810 lumen 3000K CRI90
dimmability: PWM/CCR
beam 36°

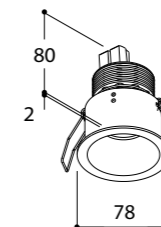

70 mm
Installation depth 85 mm



GU 10 versions: see website

finish	2700K	3000K	€
○	248017	248027	91,-
●	248016	248026	91,-
+	Frame for plaster	498100	11,-

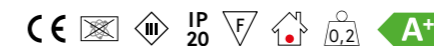

Helax SML Haloled Leaf

LUXEON M - 7,84W - 700mA DC - (11,2 Vf)

755 lumen 2700K CRI90
810 lumen 3000K CRI90
dimmability: PWM/CCR
beam 36°

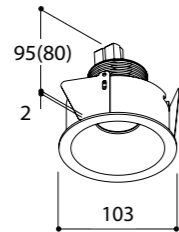

95 mm
Installation depth
100 mm solid ceilings /
85 mm hollow ceilings



finish	2700K	3000K	€
○	248147	248157	92,-
●	248146	248156	92,-



Helax SML Leaf Beaufort²

CITIZEN - 18W - 500 mA DC - (34,6 Vf)

2000 lumen 2700K CRI90
2000 lumen 3000K CRI90
2000 lumen 4000K CRI90
dimmability: PWM/CCR

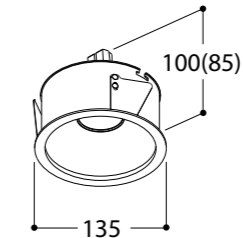

127 mm
Installation depth
105 mm solid ceilings / 90 mm hollow ceilings

finish	2700K		3000K		4000K		€
	35°	70°	35°	70°	35°	70°	
○	471147	471127	471177	471137	471157	471117	158,-
●	471146	471126	471176	471136	471156	471116	158,-



Helax SML Haloled Torsion

LUXEON M - 7,84W - 700mA DC - (11,2 Vf)

755 lumen 2700K CRI90
810 lumen 3000K CRI90
dimmability: PWM/CCR
beam 36°

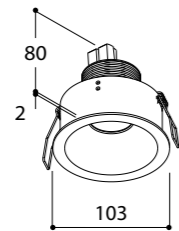

95 mm
Installation depth 85 mm



finish	2700K	3000K	€
○	248117	248127	92,-
●	248116	248126	92,-



Helax SML Torsion Beaufort²

CITIZEN - 18W - 500 mA DC - (34,6 Vf)

2000 lumen 2700K CRI90
2000 lumen 3000K CRI90
2000 lumen 4000K CRI90
dimmability: PWM/CCR

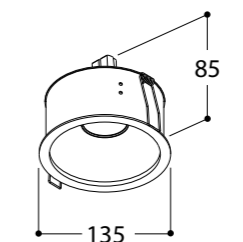

127 mm
Installation depth 90 mm

finish	2700K		3000K		4000K		€
	35°	70°	35°	70°	35°	70°	
○	471047	471027	471077	471037	471057	471017	158,-
●	471046	471026	471076	471036	471056	471016	158,-





Penthouse Ostend

Micro Eclips Leaf

LUXEON M - 3,82W - 350mA DC - (10,95 Vf)

400 lumen 2700K CRI90
429 lumen 3000K CRI90
dimmability: PWM/CCR
beam 36°

HALOSPHERE - 4,25W - 250mA DC - (17 Vf)

455 lumen 1800K ▶ 3000K CRI90
dimmability: CCR
beam 40°

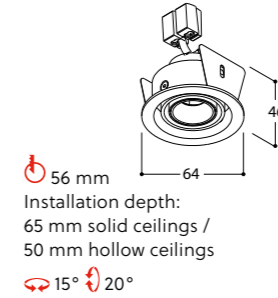

56 mm
Installation depth:
65 mm solid ceilings /
50 mm hollow ceilings

15° 20°

front	ring	focus	2700K	3000K	€	1800K-3000K	€
○	○	○	497447	497437	96,-	497427	108,-
●	●	●	497426	497416	96,-	497406	108,-
○	○	●	497492	497482	100,-	497472	112,-
○	○	●	497494	497484	96,-	497474	108,-
○	●	●	497495	497485	96,-	497475	108,-
●	●	●	497496	497486	100,-	497476	112,-
+ Frame for plaster			178000		9,-		

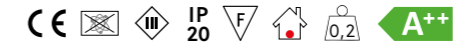

Micro Eclips Torsion

LUXEON M - 3,82W - 350mA DC - (10,95 Vf)

400 lumen 2700K CRI90
429 lumen 3000K CRI90
dimmability: PWM/CCR
beam 36°

HALOSPHERE - 4,25W - 250mA DC - (17 Vf)

455 lumen 1800K ▶ 3000K CRI90
dimmability: CCR
beam 40°

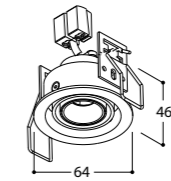

56 mm
Installation depth 65 mm
15° 20°

front	ring	focus	2700K	3000K	€	1800K-3000K	€
○	○	○	497147	497137	96,-	497127	108,-
●	●	●	497126	497116	96,-	497106	108,-
○	○	●	497192	497182	100,-	497172	112,-
○	○	●	497194	497184	96,-	497174	108,-
○	●	●	497195	497185	96,-	497175	108,-
●	●	●	497196	497186	100,-	497176	112,-
+ Frame for plaster			178000		9,-		





Private house Ardoois

Funnel Exo Haloed

LUXEON M - 7,84W - 700mA DC - (11,2 Vf)

755 lumen 2700K CRI90
 810 lumen 3000K CRI90
 dimmability: PWM/CCR
 beam 36°

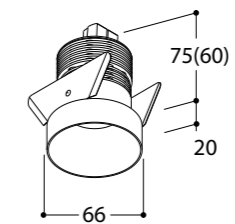

56 mm
 Installation depth:
 80 mm solid ceilings / 65 mm hollow ceilings

finish	2700K	3000K	€
○	484647	484657	81,-
●	484626	484636	81,-
+	Frame for plaster	178000	9,-

Family members:



4000K ON DEMAND Converter matrix, see back flap



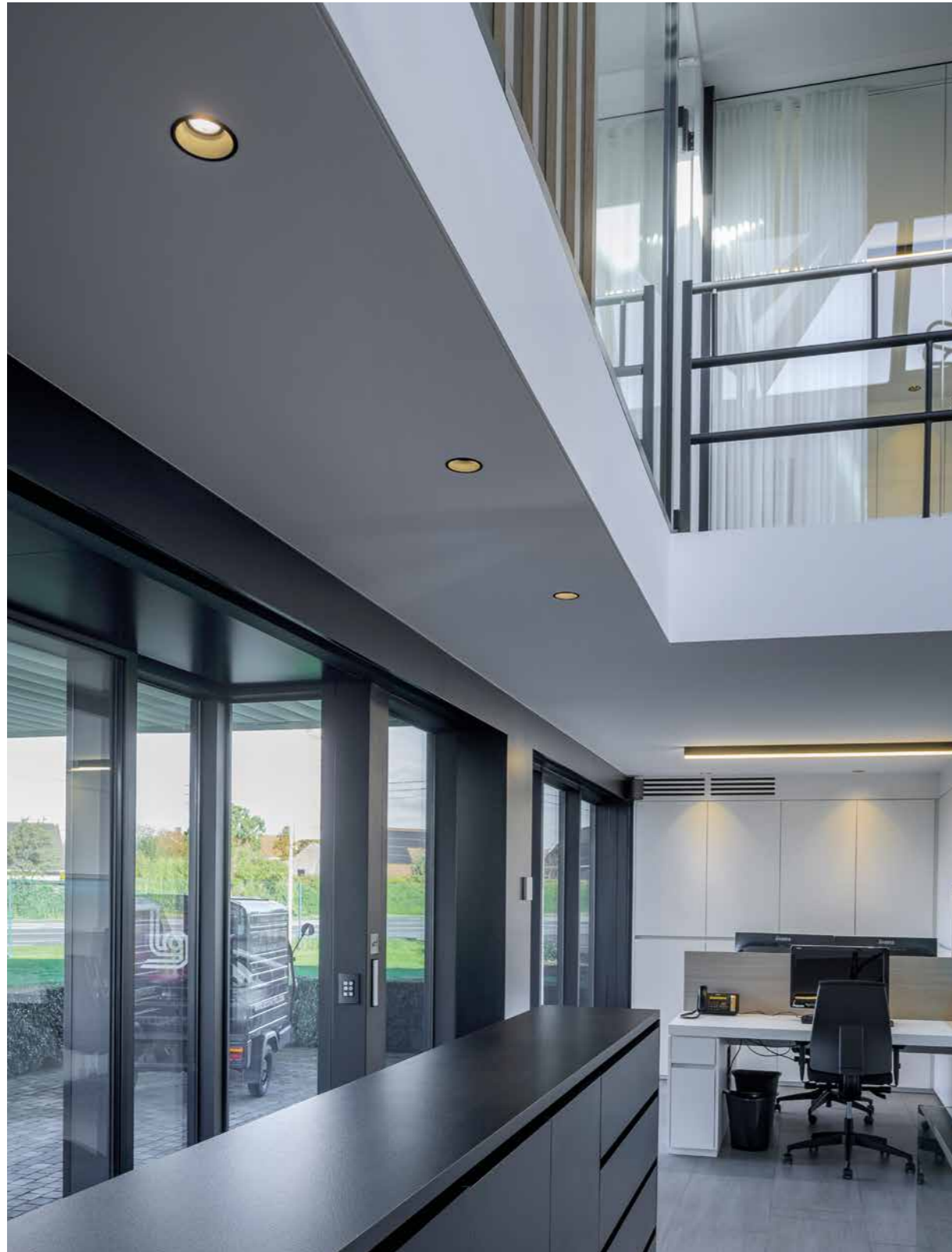

Lammertyn Ardoois

Funnel Fix Haloed Leaf

LUXEON M - 7,84W - 700mA DC - (11,2 Vf)

755 lumen 2700K CRI90
 810 lumen 3000K CRI90
 dimmability: PWM/CCR
 beam 36°

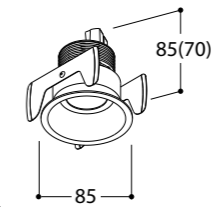

76 mm
 Installation depth:
 90 mm solid ceilings / 75 mm hollow ceilings

finish	2700K	3000K	€
○	469147	469157	85,-
●	469126	469136	85,-

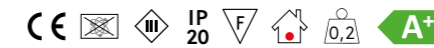

Funnel Fix Haloed Torsion

LUXEON M - 7,84W - 700mA DC - (11,2 Vf)

755 lumen 2700K CRI90
 810 lumen 3000K CRI90
 dimmability: PWM/CCR
 beam 36°

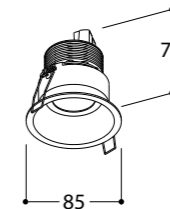

76 mm
 Installation depth 75 mm

finish	2700K	3000K	€
○	469047	469057	85,-
●	469026	469036	85,-

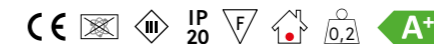



Baelskaai Ostend

Funnel Flex Haloled Leaf

LUXEON M - 7,84W - 700mA DC - (11,2 Vf)

755 lumen 2700K CRI90
810 lumen 3000K CRI90
dimmability: PWM/CCR
beam 36°

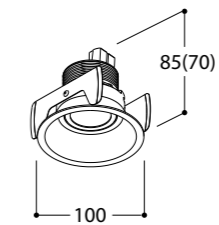

92 mm
Installation depth:
90 mm solid ceilings / 75 mm hollow ceilings
20°

finish	2700K	3000K	€
○	469347	469357	97,-
●	469326	469336	97,-

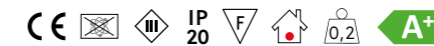

Funnel Flex Haloled Torsion

LUXEON M - 7,84W - 700mA DC - (11,2 Vf)

755 lumen 2700K CRI90
810 lumen 3000K CRI90
dimmability: PWM/CCR
beam 36°

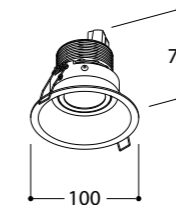

92 mm
Installation depth 75 mm
20°

finish	2700K	3000K	€
○	469247	469257	97,-
●	469226	469236	97,-

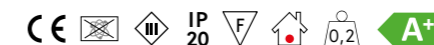

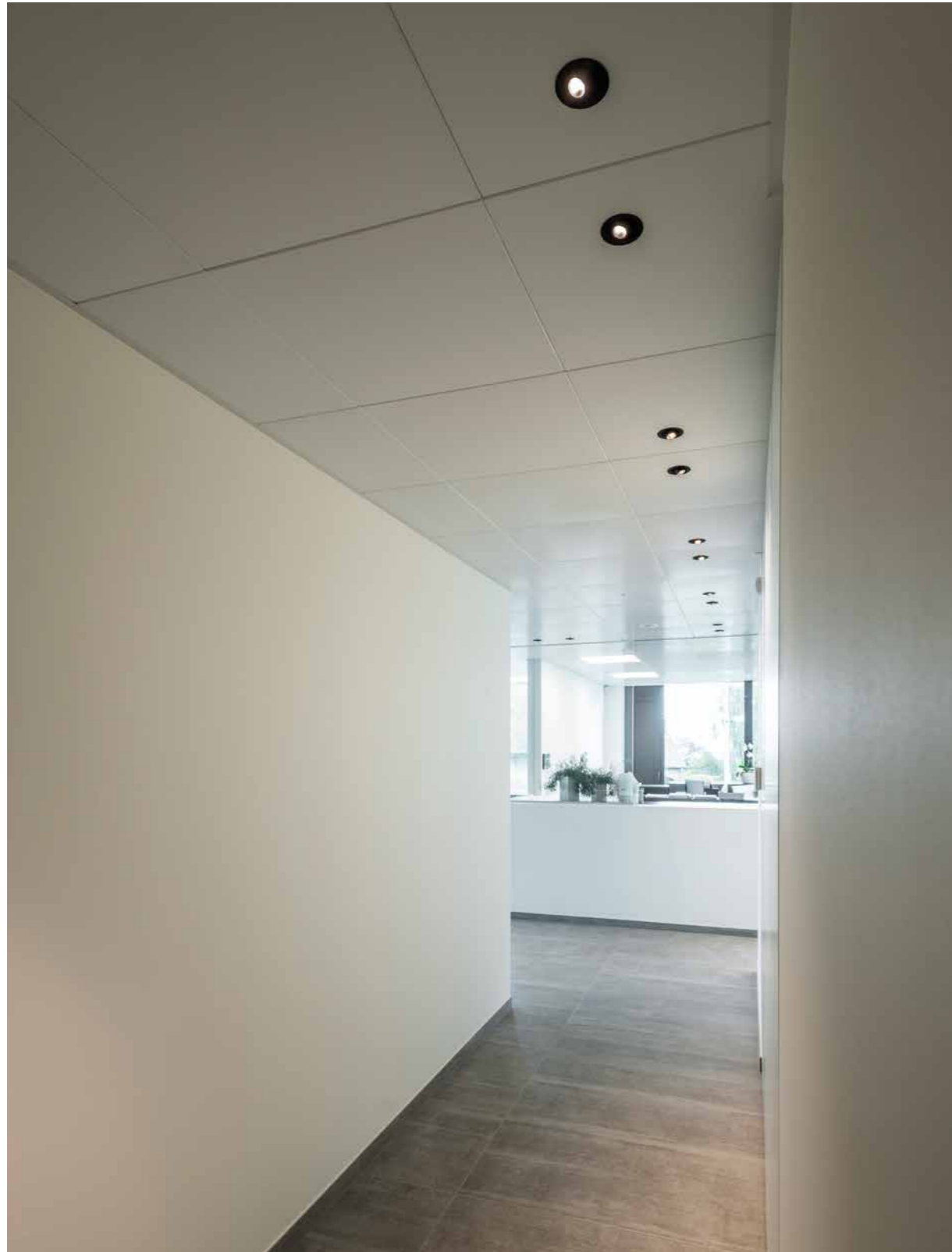

GLK Kruisem

Nobel Sferos Leaf

LUXEON M - 3,82W - 350mA DC - (10,95 Vf)

400 lumen 2700K CRI90
429 lumen 3000K CRI90
dimmability: PWM/CCR
beam 36°

HALOSPHERE - 4,25W - 250mA DC - (17 Vf)

455 lumen 1800K ▶ 3000K CRI90
dimmability: CCR
beam 40°

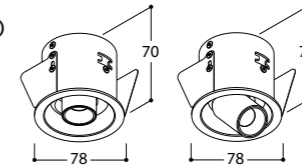

70 mm
Installation depth:
90 mm solid ceilings / 75 mm hollow ceilings
359° 55°



housing	tube	focus	2700K	3000K	€	1800K-3000K	€
○	○	○	498447	498437	143,-	498427	155,-
●	●	●	498426	498416	143,-	498406	155,-
○	○	●	498492	498482	147,-	498472	159,-
○	○	●	498494	498484	143,-	498474	155,-
●	●	○	498495	498485	143,-	498475	155,-
●	●	●	498496	498486	147,-	498476	159,-
+ Frame for plaster				498100	11,-		

Family members:



Nobel Sferos Torsion

LUXEON M - 3,82W - 350mA DC - (10,95 Vf)

400 lumen 2700K CRI90
429 lumen 3000K CRI90
dimmability: PWM/CCR
beam 36°

HALOSPHERE - 4,25W - 250mA DC - (17 Vf)

455 lumen 1800K ▶ 3000K CRI90
dimmability: CCR
beam 40°

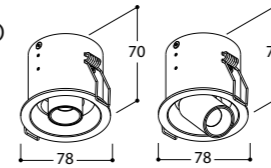

70 mm
Installation depth 75 mm
359° 55°

housing	tube	focus	2700K	3000K	€	1800K-3000K	€
○	○	○	498147	498137	143,-	498127	155,-
●	●	●	498126	498116	143,-	498106	155,-
○	○	●	498192	498182	147,-	498172	159,-
○	○	●	498194	498184	143,-	498174	155,-
●	●	○	498195	498185	143,-	498175	155,-
●	●	●	498196	498186	147,-	498176	159,-
+ Frame for plaster				498100	11,-		

Family members:

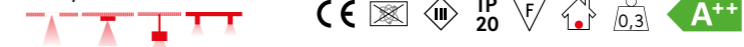

4000K ON DEMAND Converter matrix, see back flap



Pharmacy Zwevegem

Cedrus Quantum Leaf

BRIDGELUX - 6,2W - 350mA DC - (17,63 Vf)
 600 lumen 2700K CRI90
 622 lumen 3000K CRI90
 dimmability: PWM/CCR
 beam 36°

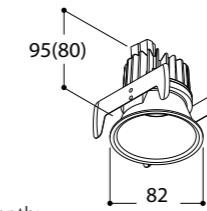

76 mm
 Installation depth:
 100 mm solid ceilings / 85 mm hollow ceilings

finish	2700K	3000K	€
○	348848	348849	55,-
●	348827	348828	55,-
+ Frame for plaster	348100		10,-

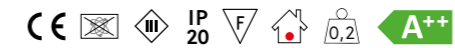

Cedrus Quantum Torsion

BRIDGELUX - 6,2W - 350mA DC - (17,63 Vf)
 600 lumen 2700K CRI90
 622 lumen 3000K CRI90
 dimmability: PWM/CCR
 beam 36°

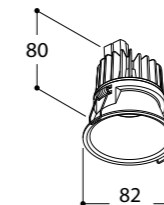

76 mm
 Installation depth 85 mm

finish	2700K	3000K	€
○	348748	348749	55,-
●	348727	348728	55,-
+ Frame for plaster	348100		10,-

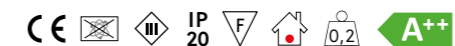

Converter matrix, see back flap



downlights

76 mm

Cedrus Quantum

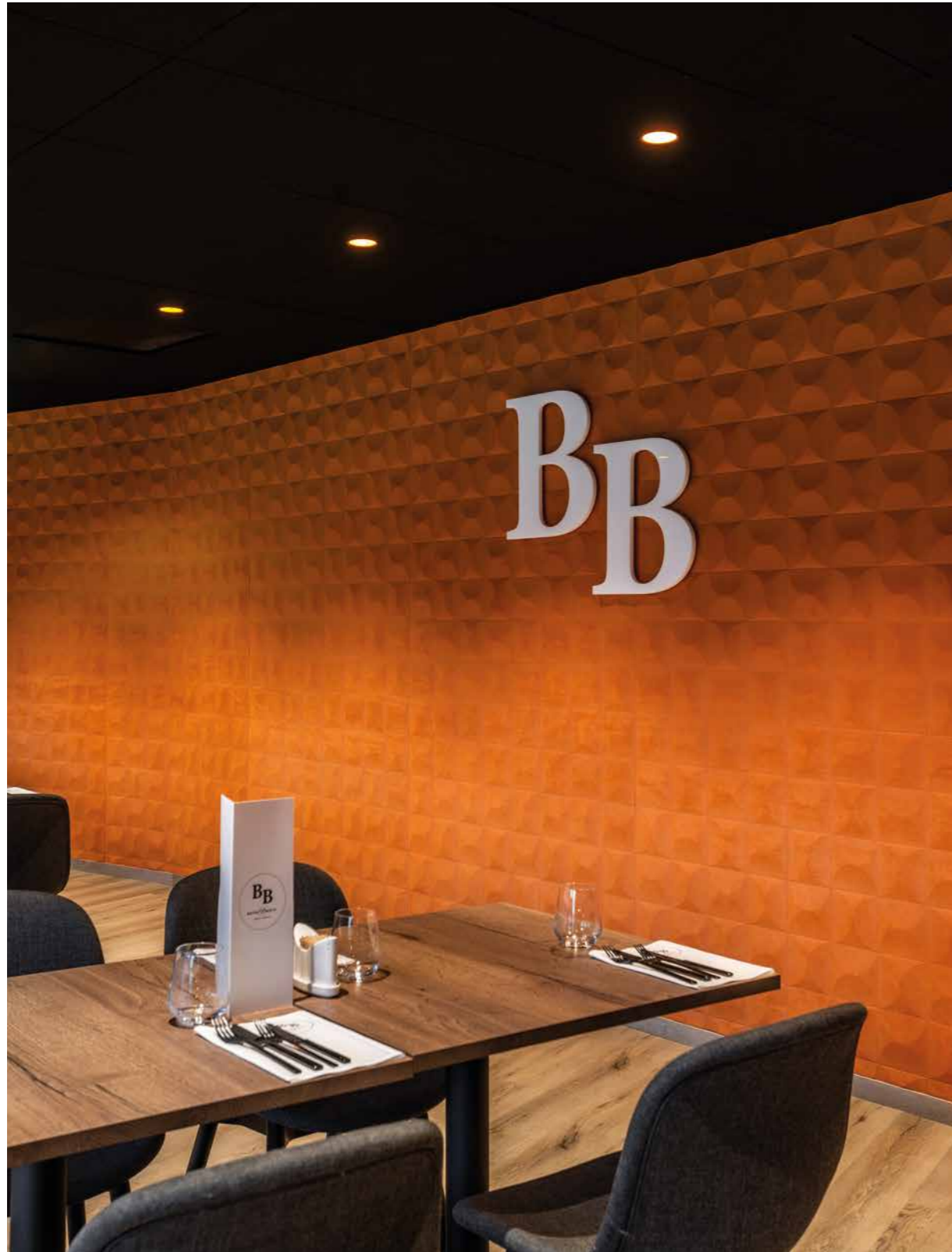

Bistro Berto Waregem

Cedrus GU10 Leaf

LED PAR16 - MAX 10W - 230V 50-60Hz AC
GU10
dimmability: dependent on bulb

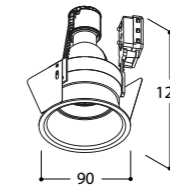

83 mm
Installation depth 130 mm
30°

finish		€
○	348347	32,-
●	348326	32,-
●	348313	50,-
+	Frame for plaster 348000	9,-



Cedrus GU10 Torsion

LED PAR16 - MAX 10W - 230V 50-60Hz AC
GU10
dimmability: dependent on bulb

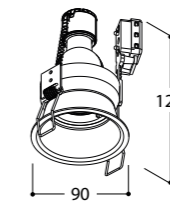

83 mm
Installation depth 130 mm
30°

finish		€
○	348247	28,-
●	348226	28,-
●	348213	46,-
+	Frame for plaster 348000	9,-





Mix Round 13W

CITIZEN - 13,5W - 350mA DC - (38,6 Vf)

1444 lumen 2700K CRI90
1506 lumen 3000K CRI90
1556 lumen 4000K CRI90
dimmability: PWM/CCR
beam 15° - 36° - 60°

HALOSPHERE - 11,8W - 350mA DC - (33,8 Vf)

1265 lumen 1800K ▶ 3000K CRI90
dimmability: CCR
beam 15° - 36° - 60°

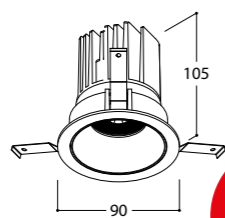

MIX 13W
all variations
€ 109,-

76mm
Installation depth 110mm



Converter matrix, see back flap

M	X	1	DIGIT 1	DIGIT 2	DIGIT 3	DIGIT 4	DIGIT 5
		13W	MODEL	BEAM ANGLE	COLOUR TEMP LED	FOCUS COLOUR	FRONT COLOUR
			1: Round	N: 15°	1: Halosphere 1800-3000K	1: Matt White	6: Textured Black
			2: Round Flex	M: 36°	2: 2700K	2: Matt Black	7: Textured White
			3: Trimless Round	W: 60°	3: 3000K	3: Matt Gold	0: Trimless
			4: Trimless Round Flex		4: 4000K	4: Black Chrome	
			5: Square				
			6: Square Flex				
			7: Trimless Square				
			8: Trimless Square Flex				

FOR MIX IP54 USE MX4 INSTEAD OF MX1 WHEN CONFIGURING AN ARTICLE NUMBER. IP54 LED MODULE IS ONLY FOR BATHROOMS

Example of article number for the MIX 13 range

MX11W116 = MIX 13W Round 60° Halosphere Matt White Focus Textured Black Front



Mix Round Flex 13W

CITIZEN - 13,5W - 350mA DC - (38,6 Vf)

1444 lumen 2700K CRI90
1506 lumen 3000K CRI90
1556 lumen 4000K CRI90
dimmability: PWM/CCR
beam 15° - 36° - 60°

HALOSPHERE - 11,8W - 350mA DC - (33,8 Vf)

1265 lumen 1800K ▶ 3000K CRI90
dimmability: CCR
beam 15° - 36° - 60°

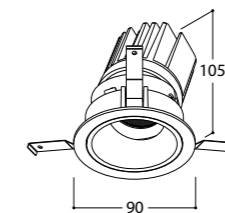

MIX 13W
all variations
€ 109,-

76mm
Installation depth 110mm
359° 30°

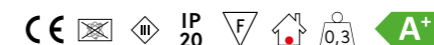

Converter matrix, see back flap

M	X	1	DIGIT 1	DIGIT 2	DIGIT 3	DIGIT 4	DIGIT 5
		13W	MODEL	BEAM ANGLE	COLOUR TEMP LED	FOCUS COLOUR	FRONT COLOUR
			1: Round	N: 15°	1: Halosphere 1800-3000K	1: Matt White	6: Textured Black
			2: Round Flex	M: 36°	2: 2700K	2: Matt Black	7: Textured White
			3: Trimless Round	W: 60°	3: 3000K	3: Matt Gold	0: Trimless
			4: Trimless Round Flex		4: 4000K	4: Black Chrome	
			5: Square				
			6: Square Flex				
			7: Trimless Square				
			8: Trimless Square Flex				

FOR MIX IP54 USE MX4 INSTEAD OF MX1 WHEN CONFIGURING AN ARTICLE NUMBER. IP54 LED MODULE IS ONLY FOR BATHROOMS

Example of article number for the MIX 13 range

MX12N247 = MIX 13W Round Flex 15° 2700K Black Chrome Focus Textured White Front

Solid Round GU10

LED PAR16 - MAX 10W - 230V 50-60Hz AC
GU10
dimmability: dependent on bulb

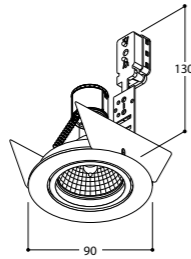

80 mm
Installation depth:
135 mm

finish		€
○	225518	32,-
●	225526	32,-
●	225472	32,-



Solid Round Moby GU10

LED PAR16 - MAX 10W - 230V 50-60Hz AC
GU10
dimmability: dependent on bulb

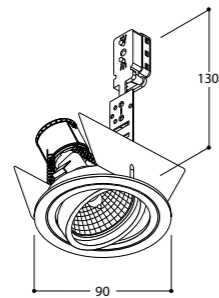

80 mm
Installation depth:
135 mm

350° 30°

finish		€
○	227518	43,-
●	227526	43,-
●	227472	43,-



Solid Round Haloed

LUXEON M - 7,84W - 700mA DC - (11,2 Vf)
755 lumen 2700K CRI90
810 lumen 3000K CRI90
dimmability: PWM/CCR
beam 36°

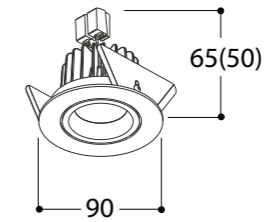

80 mm
Installation depth:
70 mm solid ceilings /
55 mm hollow ceilings

finish	2700K	3000K	€
○	466047	466057	75,-
●	466026	466036	75,-
●	466008	466018	75,-



Solid Round Moby Haloed

LUXEON M - 7,84W - 700mA DC - (11,2 Vf)
755 lumen 2700K CRI90
810 lumen 3000K CRI90
dimmability: PWM/CCR
beam 36°

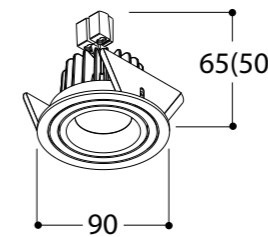

80 mm
Installation depth:
70 mm solid ceilings /
55 mm hollow ceilings

359° 20°

finish	2700K	3000K	€
○	466147	466157	83,-
●	466126	466136	83,-
●	466108	466118	83,-



Simplon Beaufort Leaf

CITIZEN - 6,22W - 180mA DC - (36,2 Vf)
 758 lumen 2700K CRI92
 793 lumen 3000K CRI92
 dimmability: PWM/CCR
 beam 36°

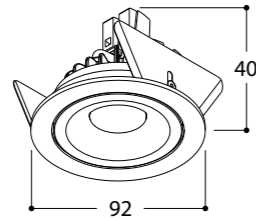

82 mm
 Installation depth:
 60 mm solid ceilings /
 45 mm hollow ceilings
 20°

finish	2700K	3000K	€
○	227947	227957	79,-
●	227926	227936	79,-



Installation depth with leaf:

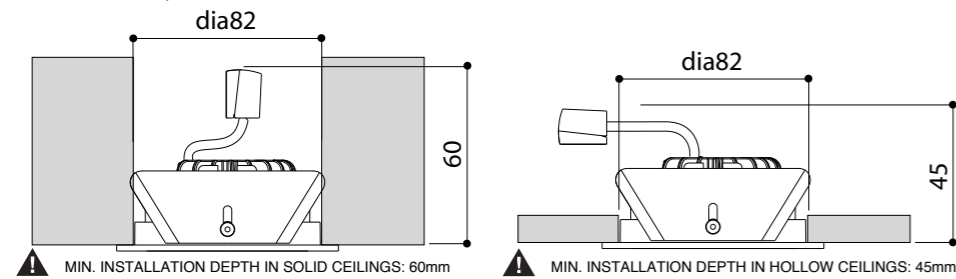

Simplon Beaufort Torsion

CITIZEN - 6,22W - 180mA DC - (36,2 Vf)
 758 lumen 2700K CRI92
 793 lumen 3000K CRI92
 dimmability: PWM/CCR
 beam 36°

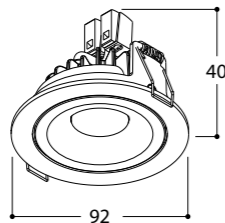

82 mm
 Installation depth 45 mm
 20°

finish	2700K	3000K	€
○	227847	227857	79,-
●	227826	227836	79,-



Simplon Haloled Leaf

LUXEON M - 7,84W - 700mA DC - (11,2 Vf)
 755 lumen 2700K CRI90
 810 lumen 3000K CRI90
 dimmability: PWM/CCR
 beam 36°

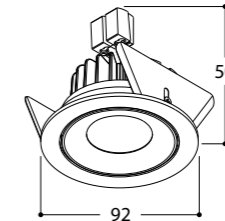

82 mm
 Installation depth:
 70 mm solid ceilings /
 55 mm hollow ceilings
 20°

finish	2700K	3000K	€
○	227747	227757	85,-
●	227726	227736	85,-



Leaf (for all ceiling types):

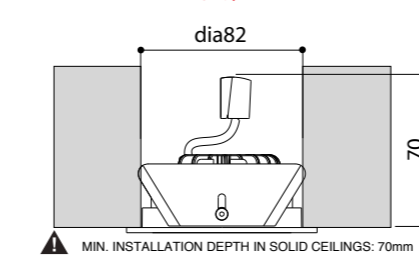

Torsion (only for hollow ceilings):

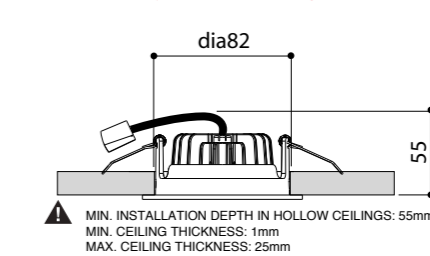

Simplon Haloled Torsion

LUXEON M - 7,84W - 700mA DC - (11,2 Vf)
 755 lumen 2700K CRI90
 810 lumen 3000K CRI90
 dimmability: PWM/CCR
 beam 36°

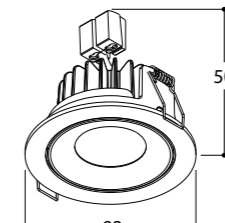

82 mm
 Installation depth 55 mm
 20°

finish	2700K	3000K	€
○	227647	227657	85,-
●	227626	227636	85,-

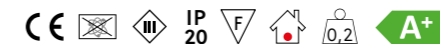



Mix Round 26W

CITIZEN - 24,5W - 700mA DC - (35,1 Vf)
 3190 lumen 2700K CRI90
 3318 lumen 3000K CRI90
 3368 lumen 4000K CRI90
 dimmability: PWM/CCR
 beam 15° - 36° - 50°

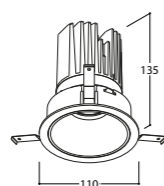

MIX 26W
 all variations
 € 149,-

100mm
 Installation depth 140mm



Converter matrix, see back flap

M	X	2	DIGIT 1	DIGIT 2	DIGIT 3	DIGIT 4	DIGIT 5
26W	MODEL	BEAM ANGLE	COLOUR TEMP LED	FOCUS COLOUR	FRONT COLOUR		
	1: Round	N: 15°		1: Matt White	6: Textured Black		
	2: Round Flex	M: 36°	2: 2700K	2: Matt Black	7: Textured White		
	3: Trimless Round	W: 50°	3: 3000K	3: Matt Gold	0: Trimless		
	4: Trimless Round Flex		4: 4000K	4: Black Chrome			
	5: Square						
	6: Square Flex						
	7: Trimless Square						
	8: Trimless Square Flex						

Example of article number for the MIX 26 range

MX21W447 = MIX 26W Round 60° 4000K Black Chrome Focus Textured White Front



Mix Round Flex 26W

CITIZEN - 24,5W - 700mA DC - (35,1 Vf)
 3190 lumen 2700K CRI90
 3318 lumen 3000K CRI90
 3368 lumen 4000K CRI90
 dimmability: PWM/CCR
 beam 15° - 36° - 50°

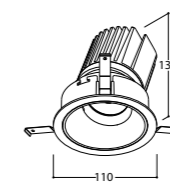

MIX 26W
 all variations
 € 149,-

100mm
 Installation depth 140mm
 359° 30°

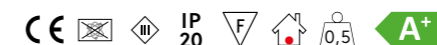

Converter matrix, see back flap

M	X	2	DIGIT 1	DIGIT 2	DIGIT 3	DIGIT 4	DIGIT 5
26W	MODEL	BEAM ANGLE	COLOUR TEMP LED	FOCUS COLOUR	FRONT COLOUR		
	1: Round	N: 15°		1: Matt White	6: Textured Black		
	2: Round Flex	M: 36°	2: 2700K	2: Matt Black	7: Textured White		
	3: Trimless Round	W: 50°	3: 3000K	3: Matt Gold	0: Trimless		
	4: Trimless Round Flex		4: 4000K	4: Black Chrome			
	5: Square						
	6: Square Flex						
	7: Trimless Square						
	8: Trimless Square Flex						

Example of article number for the MIX 26 range

MX22M316 = MIX 26W Round Flex 36° 3000K Matt White Focus Textured Black Front

Orbital Flow Control

ANNULAR LED ARRAY - 12,3W - 350mA DC - (35,1 Vf)

1460 lumen 2700K CRI92
1486 lumen 3000K CRI92
dimmability: PWM/CCR
beam 120°

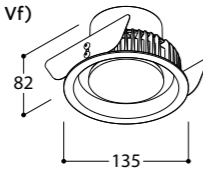

HALOSPHERE - 12,7W - 350mA DC - (36 Vf)

1230 lumen 1800K ▶ 3000K CRI87
dimmability: CCR
beam 120°

125 mm
Installation depth 180 mm
(when using flexible ventilation
valve Ø80mm)

finish	2700K	3000K	€	1800K-3000K	€
○	650747	650767	195,-	650787	204,-
●	650746	650766	195,-	650786	204,-



finish	3400K	4000K	€	2500K-4000K	€
○	650757	650777	241,-	650797	250,-
●	650756	650776	241,-	650796	250,-



Flow control = Ventilation valve

- Supply valve / extract valve
- Incorporated adjustable flow regulator

FLOW CONTROL (DISC@-30mm)

SUPPLY	
SOUND POWER Lw(dB(A))	FLOW RATE (m³/h)
35,0	68,0
30,0	56,0
25,0	47,0

FLOW CONTROL (DISC@-30mm)

EXHAUST	
SOUND POWER Lw(dB(A))	FLOW RATE (m³/h)
35,0	85,0
30,0	71,0
25,0	59,0

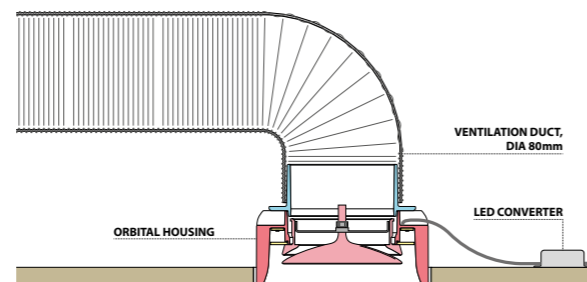

TAL Headquarters

Orbital Light Only Flow Control Look

ANNULAR LED ARRAY - 12,3W - 350mA DC - (35,1 Vf)

1460 lumen 2700K CRI92
1486 lumen 3000K CRI92
dimmability: PWM/CCR
beam 120°

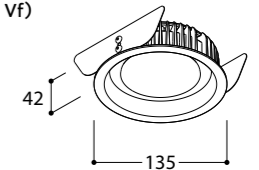

HALOSPHERE - 12,7W - 350mA DC - (36 Vf)

1230 lumen 1800K ▶ 3000K CRI87
dimmability: CCR
beam 120°

125 mm
Installation depth:
60 mm solid ceilings /
45 mm hollow ceilings

finish	2700K	3000K	€	1800K-3000K	€
○	650547	650567	153,-	650587	178,-
●	650546	650566	153,-	650586	178,-



finish	3400K	4000K	€	2500K-4000K	€
○	650557	650577	200,-	650597	213,-
●	650556	650576	200,-	650596	213,-



Orbital Through Flow

ANNULAR LED ARRAY - 12,3W - 350mA DC- (35,1 Vf)

1460 lumen 2700K CRI92
1486 lumen 3000K CRI92
dimmability: PWM/CCR
beam 120°

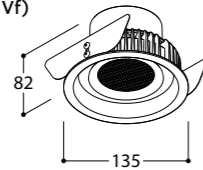

HALOSPHERE - 12,7W - 350mA DC - (36 Vf)

1230 lumen 1800K ▶ 3000K CRI87
dimmability: CCR
beam 120°

125 mm
Installation depth 180 mm
(when using flexible ventilation
valve Ø80mm)

finish	2700K	3000K	€	1800K-3000K	€
○	650647	650667	180,-	650687	194,-
●	650646	650666	180,-	650686	194,-



finish	3400K	4000K	€	2500K-4000K	€
○	650657	650677	227,-	650697	240,-
●	650656	650676	227,-	650696	240,-



Flow control = Ventilation valve

- Supply valve / extract valve
- Flow regulator must be provided in air ducts

THROUGH FLOW SUPPLY		THROUGH FLOW EXHAUST	
SOUND POWER Lw(dB(A))	FLOW RATE (m³/h)	SOUND POWER Lw(dB(A))	FLOW RATE (m³/h)
35,0	93,0	35,0	94,0
30,0	77,0	30,0	77,0
25,0	63,0	25,0	62,0

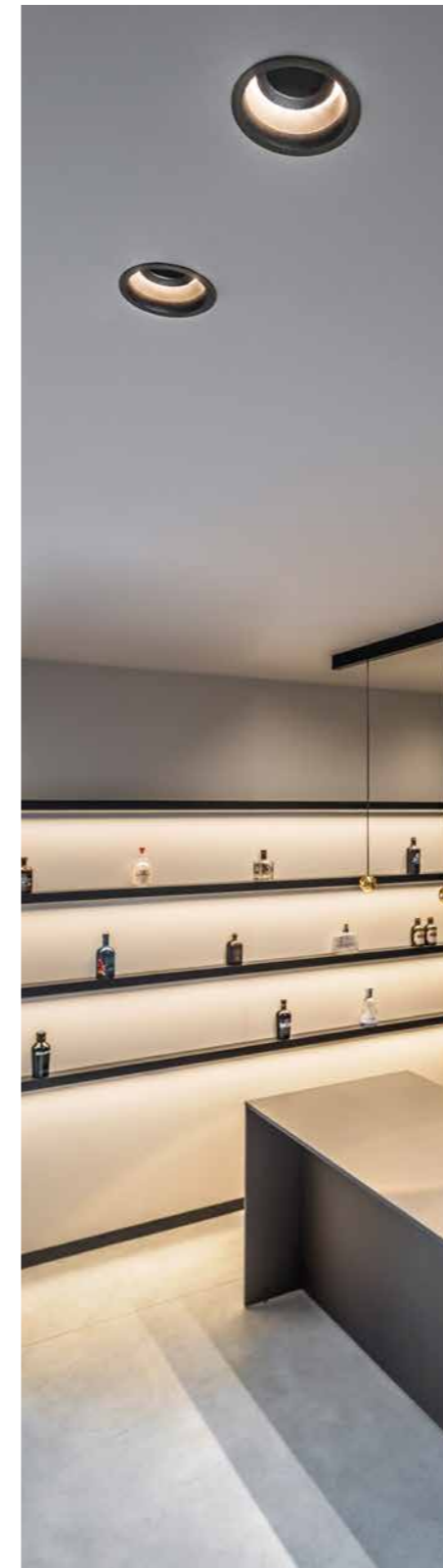
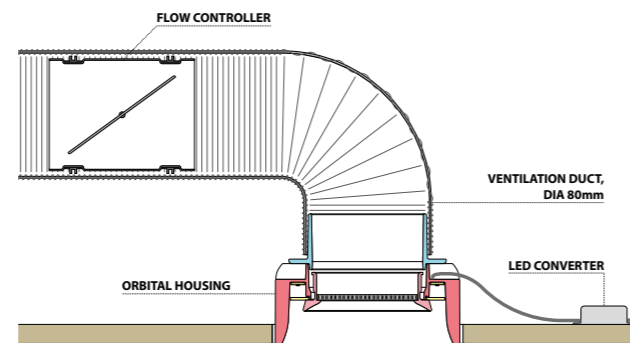

TAL Headquarters

Orbital Light Only Through Flow Look

ANNULAR LED ARRAY - 12,3W - 350mA DC - (35,1 Vf)

1460 lumen 2700K CRI92
1486 lumen 3000K CRI92
dimmability: PWM/CCR
beam 120°

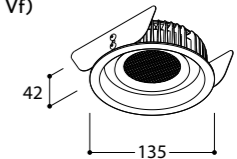

HALOSPHERE - 12,7W - 350mA DC - (36 Vf)

1230 lumen 1800K ▶ 3000K CRI87
dimmability: CCR
beam 120°

125 mm
Installation depth:
60 mm solid ceilings /
45 mm hollow ceilings

finish	2700K	3000K	€	1800K-3000K	€
○	650544	650564	168,-	650584	194,-
●	650542	650562	168,-	650582	194,-



finish	3400K	4000K	€	2500K-4000K	€
○	650554	650574	214,-	650594	226,-
●	650552	650572	214,-	650592	226,-



Orbital Loudspeaker

ANNULAR LED ARRAY - 12,3W - 350mA DC - (35,1 Vf)

1460 lumen 2700K CRI92
 1486 lumen 3000K CRI92
 dimmability: PWM/CCR
 beam 120°

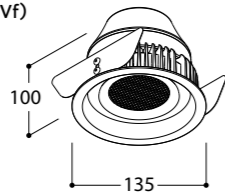

HALOSPHERE - 12,7W - 350mA DC - (36 Vf)

1230 lumen 1800K ▶ 3000K CRI87
 dimmability: CCR
 beam 120°

125 mm
 Installation depth:
 120 mm solid ceilings /
 105 mm hollow ceilings



Orbital Smoke Detector

ANNULAR LED ARRAY - 12,3W - 350mA DC - (35,1 Vf)

1460 lumen 2700K CRI92
 1486 lumen 3000K CRI92
 dimmability: PWM/CCR
 beam 120°

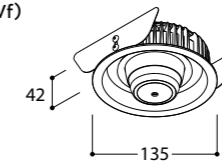

HALOSPHERE - 12,7W - 350mA DC - (36 Vf)

1230 lumen 1800K ▶ 3000K CRI87
 dimmability: CCR
 beam 120°

125 mm
 Installation depth:
 60 mm solid ceilings /
 45 mm hollow ceilings



finish	2700K	3000K	€	1800K-3000K	€
○	650847	650867	288,-	650887	301,-
●	650846	650866	288,-	650886	301,-

finish	2700K	3000K	€	1800K-3000K	€
○	650947	650967	306,-	650987	343,-
●	650946	650966	306,-	650986	343,-

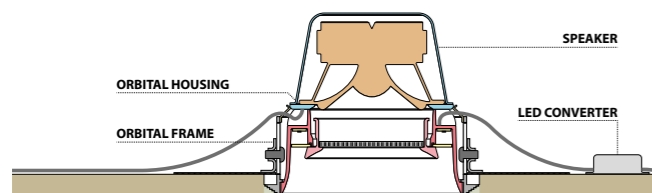

Sound = 3" full range speaker

- Max. power = 30W
- Rated power input = 15W
- Nominal impedance = 8ohm
- DCR impedance = 6,6ohm
- Sensitivity 1w/1m = 88db
- Frequency response = 75hz-20khz

Smoke = Optical smoke alarm device

- Integrated wireless interlink
- (Max. 32 devices) - RF: 868MHz
- Replacable 3V CR123A
- Lithium battery 1600mah
- Min. 5 year battery life
- Low battery indication
- 100 m open field range
- Visible indicator
- Frequency response = 75hz-20khz



Hertog Jan Zedelgem

Micro Tommy 1 Torsion

LUXEON M - 3,82W - 350mA DC - (10,95 Vf)

400 lumen 2700K CRI90
429 lumen 3000K CRI90
dimmability: PWM/CCR
beam 36°

HALOSPHERE - 4,25W - 250mA DC - (17 Vf)

455 lumen 1800K▶3000K CRI90
dimmability: CCR
beam 40°

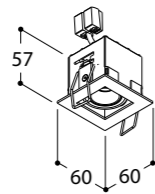

52 x 52 mm
Installation depth 60 mm

15° 20°



front	housing	ring	focus	2700K	3000K	€	1800K-3000K	€
○	○	○	○	419147	419137	101,-	419127	113,-
●	●	●	●	419126	419116	101,-	419106	113,-
○	○	○	●	419194	419184	101,-	419174	113,-
○	●	●	●	419195	419185	101,-	419175	113,-
●	●	●	●	419196	419186	105,-	419176	117,-
+	Micro frame for plaster			419199	10,-		140 x 85 x H60 mm	
+	Micro box for plaster finish			419197	23,-		155 x 85 x H90 mm	

Family members:



Micro Tommy 2 Torsion

LUXEON M - (2x) 3,82W - 350mA DC - (2x 10,95 Vf)

2x 400 lumen 2700K CRI90
2x 429 lumen 3000K CRI90
dimmability: PWM/CCR
beam 36°

HALOSPHERE - (2x) 4,25W - 250mA DC - (2x 17 Vf)

2x 455 lumen 1800K▶3000K CRI90
dimmability: CCR
beam 40°

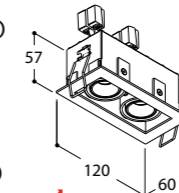

114 x 52 mm
Installation depth 60 mm

35° 20°



front	housing	ring	focus	2700K	3000K	€	1800K-3000K	€
○	○	○	○	419247	419237	169,-	419227	194,-
●	●	●	●	419226	419216	169,-	419206	194,-
○	○	○	●	419294	419284	169,-	419274	194,-
○	●	●	●	419295	419285	169,-	419275	194,-
●	●	●	●	419296	419286	177,-	419276	202,-
+	Micro frame for plaster			419299	14,-		200 x 235 x H60 mm	
+	Micro box for plaster finish			419297	38,-		200 x 235 x H150 mm	

Family members:



Micro Tommy 3 Torsion

LUXEON M - (3x) 3,82W - 350mA DC - (3x 10,95 Vf)

3x 400 lumen 2700K CRI90
3x 429 lumen 3000K CRI90
dimmability: PWM/CCR
beam 36°

HALOSPHERE - (3x) 4,25W - 250mA DC - (3x 17 Vf)

3x 455 lumen 1800K▶3000K CRI90
dimmability: CCR
beam 40°

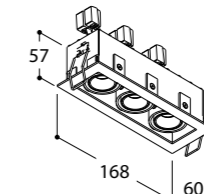

162 x 52 mm
Installation depth 60 mm

35° 20°



front	housing	ring	focus	2700K	3000K	€	1800K-3000K	€
○	○	○	○	419347	419337	232,-	419327	269,-
●	●	●	●	419326	419316	232,-	419306	269,-
○	○	○	●	419394	419384	232,-	419374	269,-
○	●	●	●	419395	419385	232,-	419375	269,-
●	●	●	●	419396	419386	244,-	419376	281,-
+	Micro frame for plaster			419399	16,-		260 x 235 x H60 mm	
+	Micro box for plaster finish			419397	41,-		260 x 235 x H150 mm	

Family members:





Private house Ypres

Micro Tommy 1 Leaf

LUXEON M - 3,82W - 350mA DC - (10,95 Vf)

400 lumen 2700K CRI90
429 lumen 3000K CRI90
dimmability: PWM/CCR
beam 36°

HALOSPHERE - 4,25W - 250mA DC - (17 Vf)

455 lumen 1800K▶3000K CRI90
dimmability: CCR
beam 40°

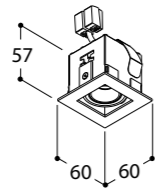

52 x 52 mm
Installation depth 60 mm
15° 20°

front	housing	ring	focus	2700K	3000K	€	1800K-3000K	€
○	○	○	○	419447	419437	101,-	419427	113,-
●	●	●	●	419426	419416	101,-	419406	113,-
○	○	○	●	419494	419484	101,-	419474	113,-
○	●	●	●	419495	419485	101,-	419475	113,-
●	●	●	●	419496	419486	105,-	419476	117,-
+ Micro frame for plaster				419199	10,-		140 x 85 x H60 mm	
+ Micro box for plaster finish				419197	23,-		155 x 85 x H90 mm	

Family members:



Micro Tommy 2 Leaf

LUXEON M - (2x) 3,82W - 350mA DC - (2x 10,95 Vf)

2x 400 lumen 2700K CRI90
2x 429 lumen 3000K CRI90
dimmability: PWM/CCR
beam 36°

HALOSPHERE - (2x) 4,25W - 250mA DC - (2x 17 Vf)

2x 455 lumen 1800K▶3000K CRI90
dimmability: CCR
beam 40°

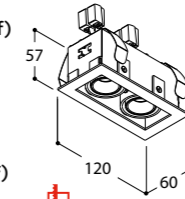

114 x 52 mm
Installation depth 60 mm
35° 20°

front	housing	ring	focus	2700K	3000K	€	1800K-3000K	€
○	○	○	○	419547	419537	169,-	419527	194,-
●	●	●	●	419526	419516	169,-	419506	194,-
○	○	○	●	419594	419584	169,-	419574	194,-
○	●	●	●	419595	419585	169,-	419575	194,-
●	●	●	●	419596	419586	177,-	419576	202,-
+ Micro frame for plaster				419299	14,-		200 x 235 x H60 mm	
+ Micro box for plaster finish				419297	38,-		200 x 235 x H150 mm	

Family members:



Micro Tommy 3 Leaf

LUXEON M - (3x) 3,82W - 350mA DC - (3x 10,95 Vf)

3x 400 lumen 2700K CRI90
3x 429 lumen 3000K CRI90
dimmability: PWM/CCR
beam 36°

HALOSPHERE - (3x) 4,25W - 250mA DC - (3x 17Vf)

3x 455 lumen 1800K▶3000K CRI90
dimmability: CCR
beam 40°

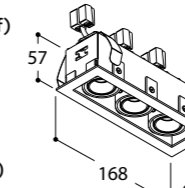

162 x 52 mm
Installation depth 60 mm
35° 20°

front	housing	ring	focus	2700K	3000K	€	1800K-3000K	€
○	○	○	○	419647	419637	232,-	419627	269,-
●	●	●	●	419626	419616	232,-	419606	269,-
○	○	○	●	419694	419684	232,-	419674	269,-
○	●	●	●	419695	419685	232,-	419675	269,-
●	●	●	●	419696	419686	244,-	419676	281,-
+ Micro frame for plaster				419399	16,-		260 x 235 x H60 mm	
+ Micro box for plaster finish				419397	41,-		260 x 235 x H150 mm	

Family members:



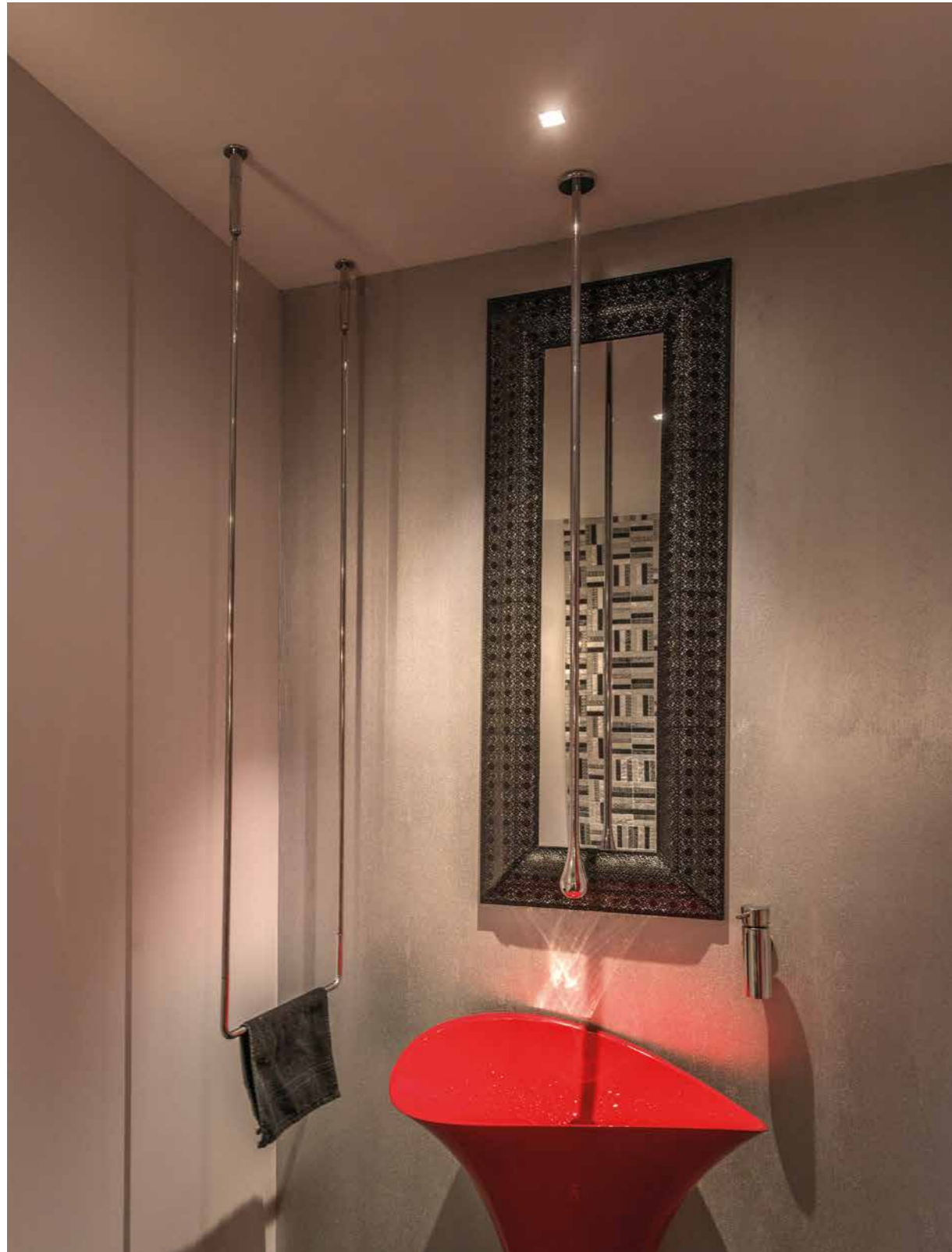

Private house Virton

Micro Tommy IP54

LUXEON M - 3,82W - 350mA DC - (10,95 Vf)

400 lumen 2700K CRI90

429 lumen 3000K CRI90

dimmiability: PWM/CCR

beam 36°

HALOSPHERE - 4,25W - 250mA DC - (17 Vf)

455 lumen 1800K ▶ 3000K CRI90

dimmiability: CCR

beam 40°

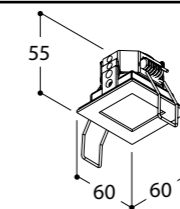

52 x 52 mm
Installation depth 60 mm



front	inside	focus	2700K	3000K	€	1800K-3000K	€
○	○	○	472147	472137	126,-	472127	138,-
●	●	●	472126	472116	126,-	472106	138,-
○	○	●	472194	472184	126,-	472174	138,-
●	●	●	472196	472186	130,-	472176	142,-
○	●	●	472195	472185	126,-	472175	138,-
○	●	○	472192	472182	130,-	472172	142,-
+ Micro frame for plaster			419199	10,-	140 x 85 x H60 mm		
+ Micro box for plaster finish			419197	23,-	155 x 85 x H90 mm		

Family members:



4000K ON DEMAND

Converter matrix, see back flap



Penthouse Knokke

Mini Tommy 1 Beaufort

CITIZEN LED - 6,22W - 180mA DC - (34,6 Vf)

758 lumen 2700K CRI92
793 lumen 3000K CRI92
dimmability: PWM/CCR
beam 36°

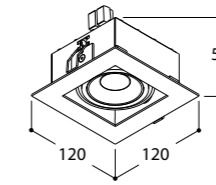

GU 10 versions: see website

110 x 110 mm
Installation depth 60 mm
30° ↻ 30°

front	ring	focus	2700K	3000K	€
			107107	107117	133,-
			107106	107116	133,-
			107186	107196	137,-
+ Installation frame for plaster			700139	15,-	200 x 235 mm
+ Installation box for plaster			700138	39,-	200 x 235 x 150 mm

CE IP 20

Mini Tommy 2 Beaufort

CITIZEN (2X) 6,22W - 180mA DC - (2x 34,6 Vf)

2x 758 lumen 2700K CRI92
2x 793 lumen 3000K CRI92
dimmability: PWM/CCR
beam 36°

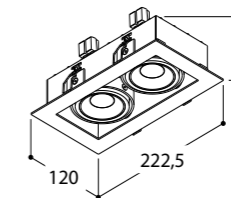

GU 10 versions: see website

210 x 110 mm
Installation depth 60 mm
30° ↻ 30°

front	ring	focus	2700K	3000K	€
			107207	107217	235,-
			107206	107216	235,-
			107286	107296	243,-
+ Installation frame for plaster			700239	19,-	260 x 235 mm
+ Installation box for plaster			700238	44,-	260 x 235 x 150 mm

CE IP 20

Converter matrix, see back flap

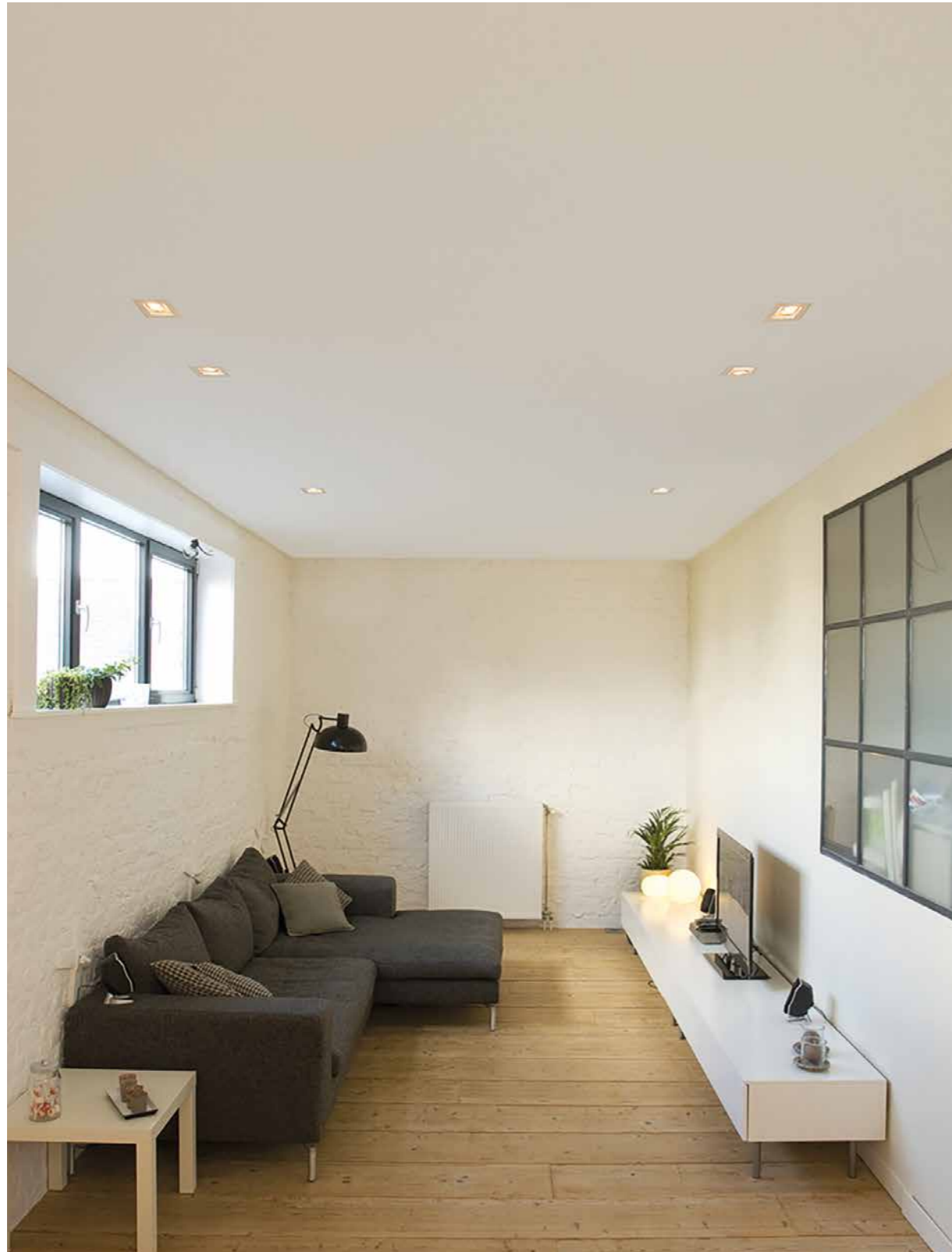

Loft Izegem

Mini Tommy 1 Haloled

LUXEON M - 7,84W - 700mA DC - (11,2 Vf)
 755 lumen 2700K CRI90
 810 lumen 3000K CRI90
 dimmability: PWM/CCR
 beam 36°

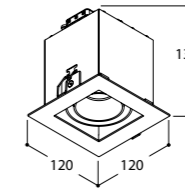

110 x 110 mm
 Installation depth 135 mm
 30°

GU 10 versions: see website

finish	2700K	3000K	€
	107407	107417	110,-
	107406	107416	110,-

+ Installation frame for plaster	700139	15,-	200 x 235 mm
+ Installation box for plaster	700138	39,-	200 x 235 x 150 mm

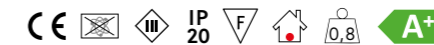

Mini Tommy 2 Haloled

LUXEON M (2X) 7,84W - 700mA DC - (2x 11,2 Vf)
 2x 755 lumen 2700K CRI90
 2x 810 lumen 3000K CRI90
 dimmability: PWM/CCR
 beam 36°

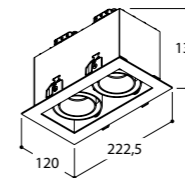

210 x 110 mm
 Installation depth 135 mm
 30°

GU 10 versions: see website

finish	2700K	3000K	€
	107507	107517	183,-
	107506	107516	183,-

+ Installation frame for plaster	700239	19,-	260 x 235 mm
+ Installation box for plaster	700238	44,-	260 x 235 x 150 mm

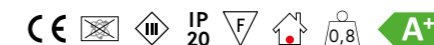



TAL Headquarters



Dice Exo

LUXEON M - 7,84W - 700mA DC - (11,2 Vf)

755 lumen 2700K CRI90
810 lumen 3000K CRI90
dimmability: PWM/CCR
beam 50°

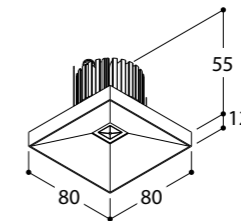

56 mm
Installation depth 60 mm

finish	2700K	3000K	€
○	377347	377337	94,-
●	377326	377316	94,-
+	Frame for plaster	178000	9,-

Family members:



4000K ON DEMAND Converter matrix, see back flap



Mix Square 13W

CITIZEN - 13,5W - 350mA DC - (38,6 Vf)

1444 lumen 2700K CRI90
 1506 lumen 3000K CRI90
 1556 lumen 4000K CRI90
 dimmability: PWM/CCR
 beam 15° - 36° - 60°

HALOSPHERE - 11,8W - 350mA DC - (33,8 Vf)

1265 lumen 1800K ▶ 3000K CRI90
 dimmability: CCR
 beam 15° - 36° - 60°

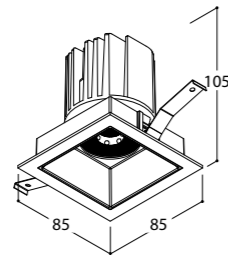

76x76 mm
 Installation depth 110mm

MIX 13W
 all variations
 € 109,-



Converter matrix, see back flap

M	X	1	DIGIT 1	DIGIT 2	DIGIT 3	DIGIT 4	DIGIT 5
13W	MODEL	BEAM ANGLE	COLOUR TEMP LED	FOCUS COLOUR	FRONT COLOUR		
	1: Round	N: 15°	1: Halosphere 1800-3000K	1: Matt White	6: Textured Black		
	2: Round Flex	M: 36°	2: 2700K	2: Matt Black	7: Textured White		
	3: Trimless Round	W: 60°	3: 3000K	3: Matt Gold	0: Trimless		
	4: Trimless Round Flex		4: 4000K	4: Black Chrome			
	5: Square						
	6: Square Flex						
	7: Trimless Square						
	8: Trimless Square Flex						

FOR MIX IP54 USE MX4 INSTEAD OF MX1 WHEN CONFIGURING AN ARTICLE NUMBER. IP54 LED MODULE IS ONLY FOR BATHROOMS

Example of article number for the MIX 13 range

MX15W446 = MIX 13W Square 60° 4000K Black Chrome Focus Textured Black Front



Mix Square Flex 13W

CITIZEN - 13,5W - 350mA DC - (38,6 Vf)

1444 lumen 2700K CRI90
 1506 lumen 3000K CRI90
 1556 lumen 4000K CRI90
 dimmability: PWM/CCR
 beam 15° - 36° - 60°

HALOSPHERE - 11,8W - 350mA DC - (33,8 Vf)

1265 lumen 1800K ▶ 3000K CRI90
 dimmability: CCR
 beam 15° - 36° - 60°

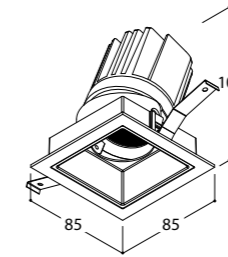

76x76 mm
 Installation depth 110mm
 30°

MIX 13W
 all variations
 € 109,-

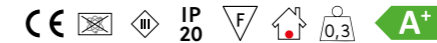

Converter matrix, see back flap

M	X	1	DIGIT 1	DIGIT 2	DIGIT 3	DIGIT 4	DIGIT 5
13W	MODEL	BEAM ANGLE	COLOUR TEMP LED	FOCUS COLOUR	FRONT COLOUR		
	1: Round	N: 15°	1: Halosphere 1800-3000K	1: Matt White	6: Textured Black		
	2: Round Flex	M: 36°	2: 2700K	2: Matt Black	7: Textured White		
	3: Trimless Round	W: 60°	3: 3000K	3: Matt Gold	0: Trimless		
	4: Trimless Round Flex		4: 4000K	4: Black Chrome			
	5: Square						
	6: Square Flex						
	7: Trimless Square						
	8: Trimless Square Flex						

FOR MIX IP54 USE MX4 INSTEAD OF MX1 WHEN CONFIGURING AN ARTICLE NUMBER. IP54 LED MODULE IS ONLY FOR BATHROOMS

Example of article number for the MIX 13 range

MX16M316 = MIX 13W Square Flex 36° 3000K Matt White Focus Textured Black Front

Solid Square GU10

LED PAR16 - MAX 10W - 230V 50-60Hz AC
GU10
dimmability: dependent on bulb

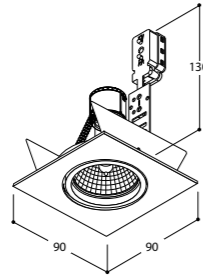

80 mm
Installation depth:
135 mm

finish		€
○	226518	43,-
●	226526	43,-
●	226472	43,-



Solid Square Haloled

LUXEON M - 7,84W - 700mA DC - (11,2 Vf)
755 lumen 2700K CRI90
810 lumen 3000K CRI90
dimmability: PWM/CCR
beam 36°

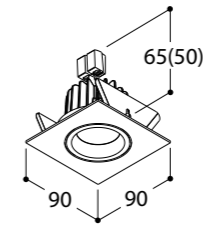

80 mm
Installation depth:
70 mm solid ceilings / 55 mm hollow ceilings

finish	2700K	3000K	€
○	466247	466257	80,-
●	466226	466236	80,-
●	466208	466218	80,-



Solid Square Moby GU10

LED PAR16 - MAX 10W - 230V 50-60Hz AC
GU10
dimmability: dependent on bulb

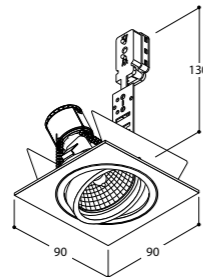

80 mm
Installation depth:
135 mm

finish		€
○	228518	59,-
●	228526	59,-
●	228472	59,-

350° 30°



Solid Square Moby Haloled

LUXEON M - 7,84W - 700mA DC - (11,2 Vf)
755 lumen 2700K CRI90
810 lumen 3000K CRI90
dimmability: PWM/CCR
beam 36°

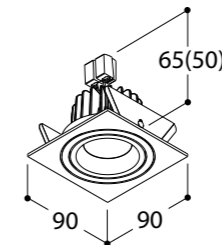

80 mm
Installation depth:
70 mm solid ceilings / 55 mm hollow ceilings
359° 20°

finish	2700K	2700K	€
○	466347	466357	89,-
●	466326	466336	89,-
●	466308	466318	89,-



Quad GU10 Torsion

LED PAR16 - MAX 10W - 230V 50-60HZ AC
GU10
dimmability: dependent on bulb

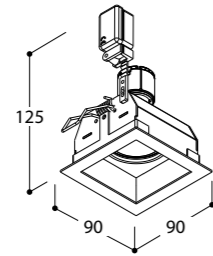

finish		€
○	750161	38,-
●	750160	38,-
●	750162	38,-
●	750165	55,-

80 x 80 mm
Installation depth 125 mm

+ Installation box for plaster	750138	28,-	155 x 155 x 165 mm
+ Installation frame for plaster	250790	10,-	85 x 85 mm



Quad Orientable GU10

LED PAR16 - MAX 10W - 230V 50-60HZ AC
GU10
dimmability: dependent on bulb

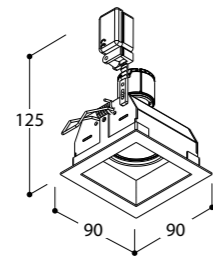

finish		€
○	750171	44,-
●	750170	44,-
●	750172	44,-
●	750175	61,-

80 x 80 mm
Installation depth 125 mm
30°

+ Installation box for plaster	750138	28,-	155 x 155 x 165 mm
+ Installation frame for plaster	250790	10,-	85 x 85 mm



Quincalux

Quad Asymmetric Beaufort

CITIZEN - 6,22W - 180mA DC - (34,6 Vf)
758 lumen 2700K CRI92
793 lumen 3000K CRI92
dimmability: PWM/CCR
beam 36°

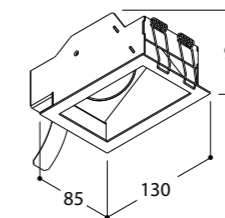

123 x 78 mm
Installation depth 95 mm
45°

finish	2700K	3000K	€
○	750847	750857	127,-
●	750826	750836	127,-

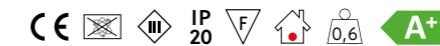

Converter matrix, see back flap



Excellent Luxembourg

B4 Leaf

CREE XPG - 8W - 700mA DC - (11,32 Vf)

832 lumen 2700K CRI92

832 lumen 3000K CRI92

dimmiability: PWM/CCR

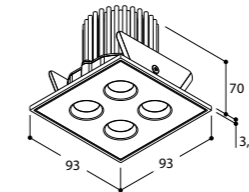

80 mm

Installation depth:

90 mm solid ceilings / 75 mm hollow ceilings

finish	2700K			3000K			€
	10°	25°	46°	10°	25°	46°	
●	293347	293447	293547	293357	293457	293557	133,-
○	293326	293426	293526	293336	293436	293536	133,-

Family members:

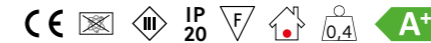

B4 Torsion

CREE XPG - 8W - 700mA DC - (11,32 Vf)

832 lumen 2700K CRI92

832 lumen 3000K CRI92

dimmiability: PWM/CCR

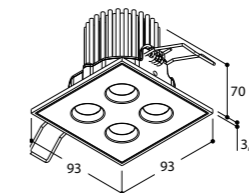

80 mm

Installation depth 75 mm

finish	2700K			3000K			€
	10°	25°	46°	10°	25°	46°	
●	293047	293147	293247	293057	293157	293257	133,-
○	293026	293126	293226	293036	293136	293236	133,-

Family members:

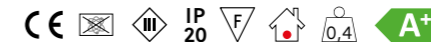

4000K ON DEMAND

Converter matrix, see back flap





Mix Square 26W

CITIZEN - 24,5W - 700mA DC - (35,1 Vf)
 3190 lumen 2700K CRI90
 3318 lumen 3000K CRI90
 3368 lumen 4000K CRI90
 dimmability: PWM/CCR
 beam 15° - 36° - 50°

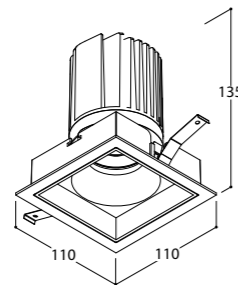

100x100 mm
 Installation depth 140 mm

MIX 26W
 all variations
 € 149,-



Converter matrix, see back flap



Mix Square Flex 26W

CITIZEN - 24,5W - 700mA DC - (35,1 Vf)
 3190 lumen 2700K CRI90
 3318 lumen 3000K CRI90
 3368 lumen 4000K CRI90
 dimmability: PWM/CCR
 beam 15° - 36° - 50°

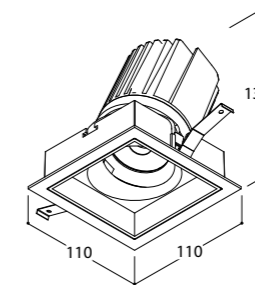

30°
 100x100 mm
 Installation depth 140 mm

MIX 26W
 all variations
 € 149,-

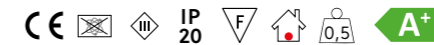

Converter matrix, see back flap

M	X	2	DIGIT 1	DIGIT 2	DIGIT 3	DIGIT 4	DIGIT 5
26W	MODEL	BEAM ANGLE	COLOUR TEMP LED	FOCUS COLOUR	FRONT COLOUR		
1:	Round	N: 15°		1: Matt White	6: Textured Black		
2:	Round Flex	M: 36°	2: 2700K	2: Matt Black	7: Textured White		
3:	Trimless Round	W: 50°	3: 3000K	3: Matt Gold	0: Trimless		
4:	Trimless Round Flex		4: 4000K	4: Black Chrome			
5:	Square						
6:	Square Flex						
7:	Trimless Square						
8:	Trimless Square Flex						

Example of article number for the MIX 26 range

MX25W216 = MIX 26W Square 60° 2700K Matt White Focus Textured Black Front

M	X	2	DIGIT 1	DIGIT 2	DIGIT 3	DIGIT 4	DIGIT 5
26W	MODEL	BEAM ANGLE	COLOUR TEMP LED	FOCUS COLOUR	FRONT COLOUR		
1:	Round	N: 15°		1: Matt White	6: Textured Black		
2:	Round Flex	M: 36°	2: 2700K	2: Matt Black	7: Textured White		
3:	Trimless Round	W: 50°	3: 3000K	3: Matt Gold	0: Trimless		
4:	Trimless Round Flex		4: 4000K	4: Black Chrome			
5:	Square						
6:	Square Flex						
7:	Trimless Square						
8:	Trimless Square Flex						

Example of article number for the MIX 26 range

MX26N236 = MIX 26W Square Flex 15° 2700K Matt Gold Focus Textured Black Front

wall recessed

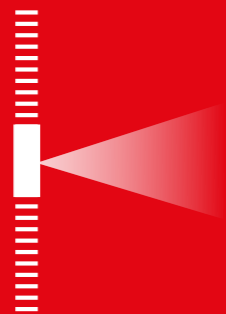

Diabolo S 115

Fonda 117

Dice 118

Elite 119

NEW Flox 121



Headquarters TAL





Diabolo S CI

CREE XPE - 1,2W - 230V 50-60Hz AC
 94 lumen 2700K CRI80
 94 lumen 3000K CRI80
 dimmability: mains dim LC

i Fits on standard round electrical accessory box with screws

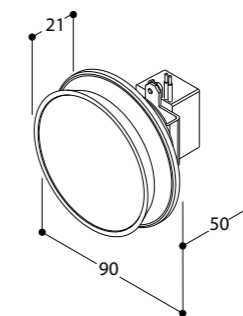
 Installation depth 61 mm



finish	2700K	3000K	€
	177467	177477	128,-
	177446	177456	128,-

Family members:

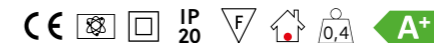
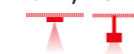

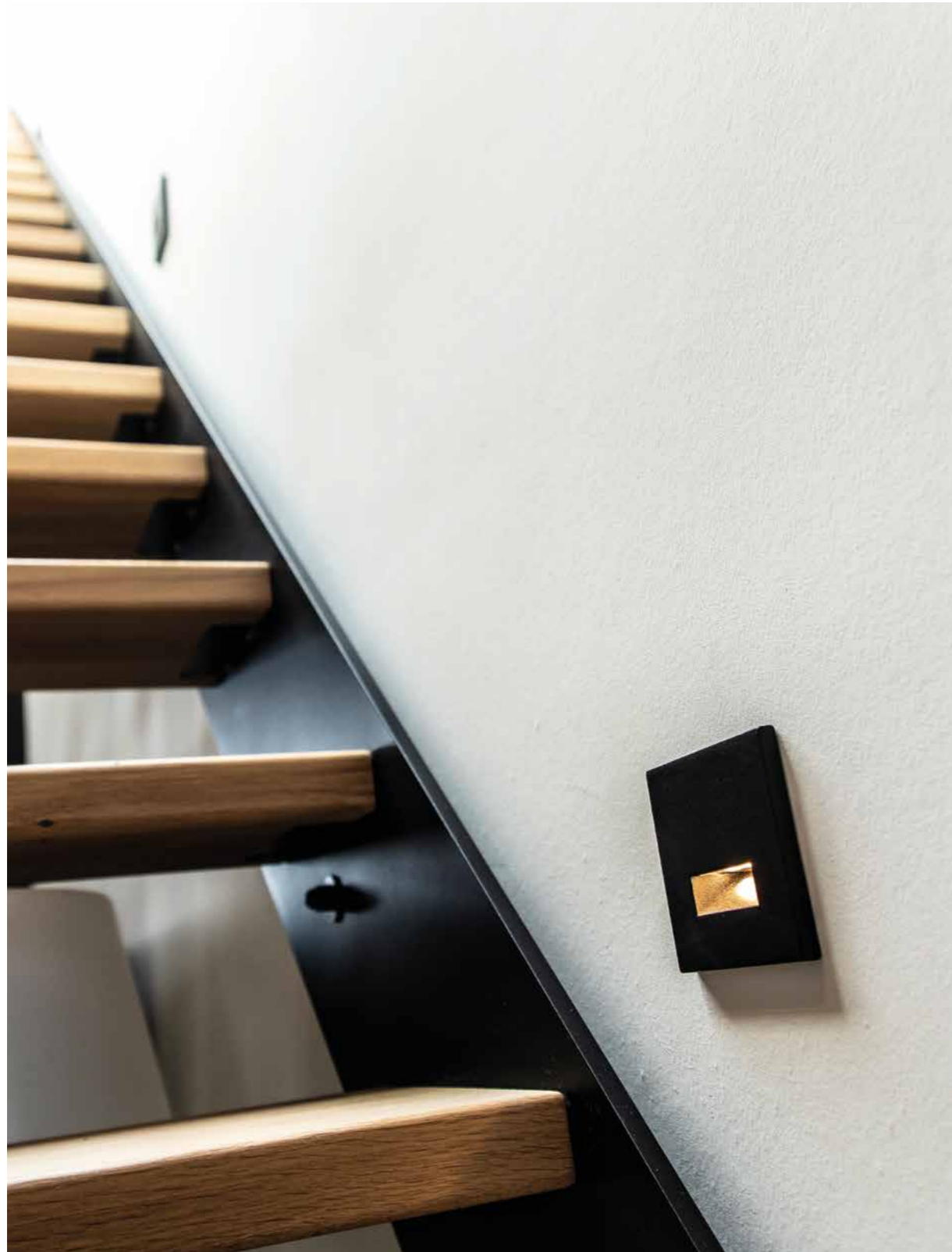

FBF



wall recessed

Fonda

SMD LED - 0,8W - 230V 50-60Hz AC
 60 lumen 2700K CRI80
 60 lumen 3000K CRI80
 dimmability: not dimmable

i Fits on standard round electrical accessory box with screws



Installation depth 61 mm

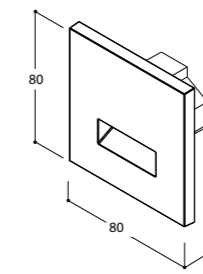

finish	2700K	3000K	€
○	452057	452047	74,-
●	452036	452026	74,-
●	452022	452012	74,-
i Clamp set	145900		7,-

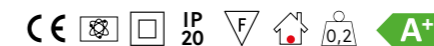

Fonda



Private house Brussels

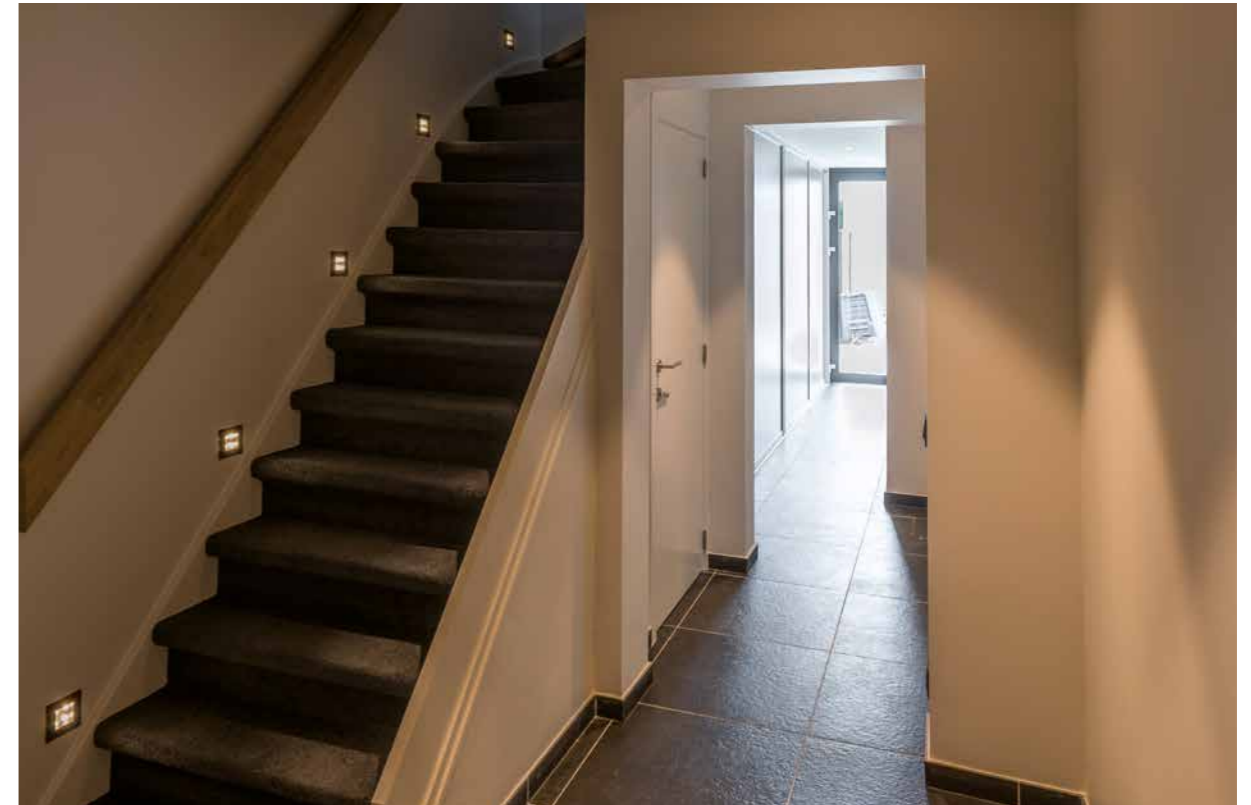

Private house Wevelgem

wall recessed

Dice Wall CI

CREE XPE - 1,2W - 230V 50-60Hz AC

94 lumen 2700K CRI80
94 lumen 3000K CRI80
dimmability: mains dim LC
beam 50°

i Fits on standard round electrical accessory box with screws



Installation depth 61 mm

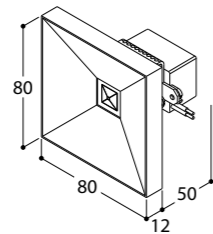

finish	2700K	3000K	€
○	377647	377657	79,-
●	377626	377636	79,-

Family members:

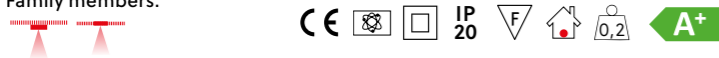

Elite

SMD LED - 0,8W - 230V 50-60Hz AC

60 lumen 2700K CRI80
60 lumen 3000K CRI80
dimmability: not dimmable
beam 120°

i Fits on standard round electrical accessory box with screws



Installation depth 61 mm

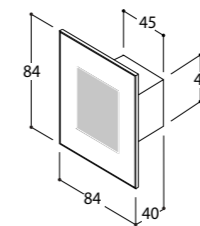

finish	2700K	3000K	€
○	145531	145611	70,-
●	145567	145626	70,-
●	145541	145621	94,-
●	145530	145610	70,-
i Clamp set	145900		7,-

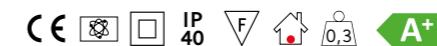

Dice & Elite

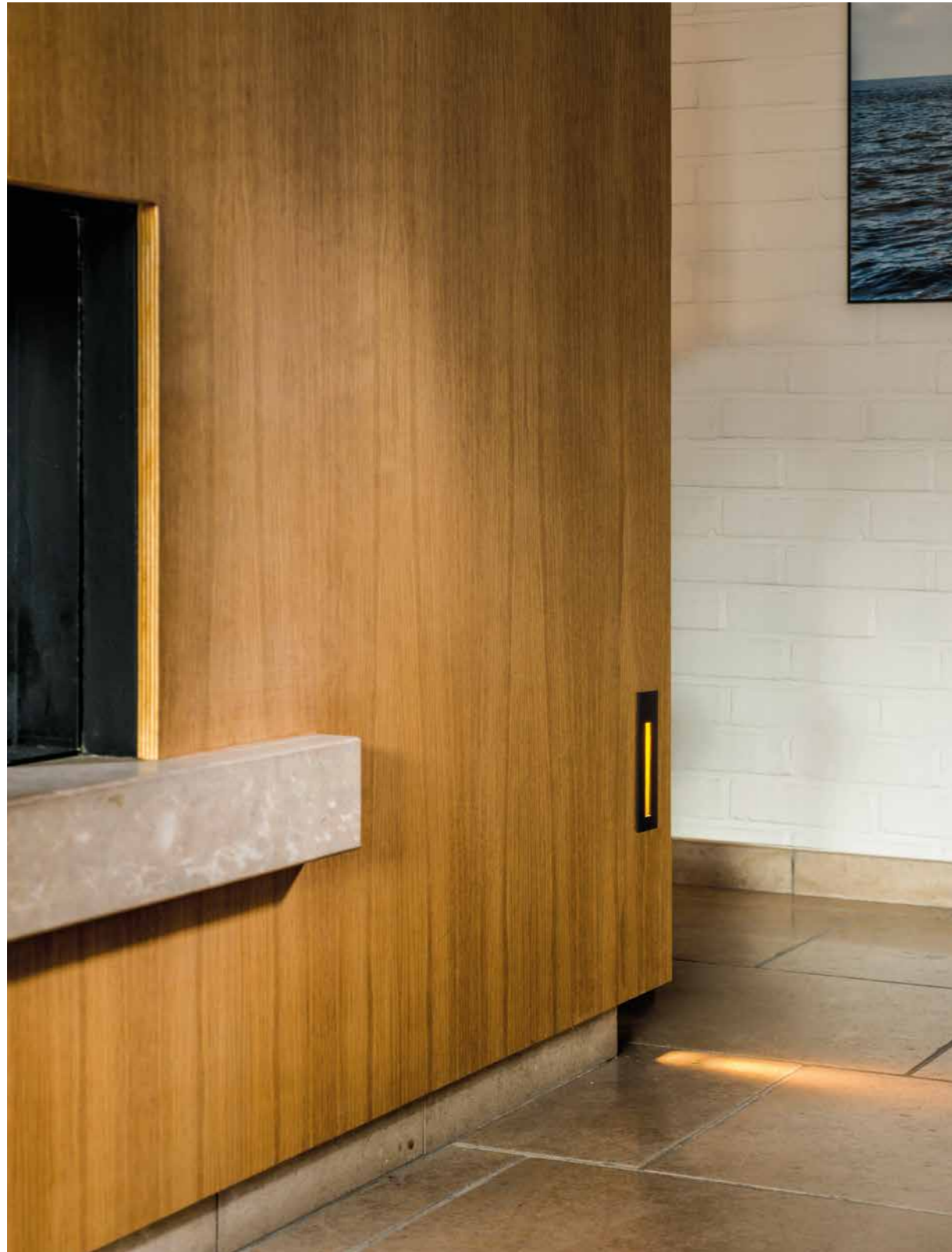

Private house Izegem

Flox Nxt Torsion CI

LUXEON M - 3,82W - 230V 50-60Hz AC
 400 lumen 2700K CRI90
 429 lumen 3000K CRI90
 dimmability: mains dim LC

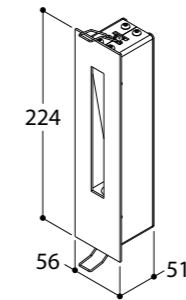

finish	reflector	2700K	3000K	€
○	○	131247	131237	120,-
○	●	131292	131282	124,-
●	●	131296	131286	124,-
+ frame for plaster		131197	22,-	
+ box for plaster		131177	40,-	

214 x 43 mm
 Installation depth 56 mm

230 x 57 mm
 Installation depth 56 mm
 431 x 114 mm
 Installation depth 90 mm



Flox Nxt Leaf CI

LUXEON M - 3,82W - 230V 50-60Hz AC
 400 lumen 2700K CRI90
 429 lumen 3000K CRI90
 dimmability: mains dim LC

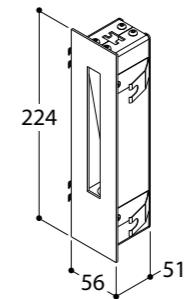

finish	reflector	2700K	3000K	€
○	○	131147	131137	120,-
○	●	131192	131182	124,-
●	●	131196	131186	124,-
+ frame for plaster		131197	22,-	
+ box for plaster		131177	40,-	

214 x 43 mm
 Installation depth 56 mm

230 x 57 mm
 Installation depth 56 mm
 431 x 114 mm
 Installation depth 90 mm



wall recessed

Flox Nxt

surface mounted

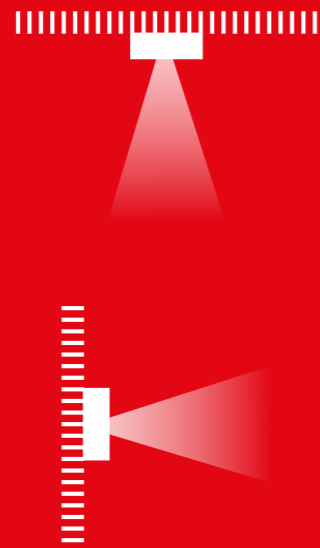

Chromos	125	Fabian	172
NEW Berrier Junior	127	Dice	175
NEW Cone	131	Blox	177
Microscoop	135	Django	179
Nobel Elbow	137	Odil	183
NEW Lithoss: Luminaries	140	Pandora	185
Berrier	143	Brix	187
Mini Scoop Deimos	145	Dartling	189
Funnel	146	Boa	193
Habana	161	Micro Tommy	197
Telescoop & Nelson	165	Domino	199
Hubble	167	M10 Base	200
Rollo	169	Wodan	203
Diabolo	171		



Maison et Objet Paris

Chromos

CREE XPE - 1,2W - 350mA DC - (3,2 Vf)
 94 lumen 2700K CRI80
 94 lumen 3000K CRI80
 dimmability: PWM/CCR

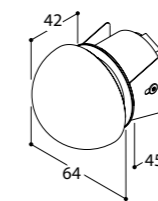

48 mm
 Installation depth 45 mm

finish	2700K	3000K	€
○	177078	177927	76,-
●	177076	177928	76,-
●	177070	177920	100,-

📌 installation box for plaster	177077	22,-	📏 92 x H77 mm
📌 installation frame for plaster	177097	10,-	📏 48 mm

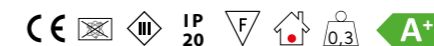

Chromos

surface mounted

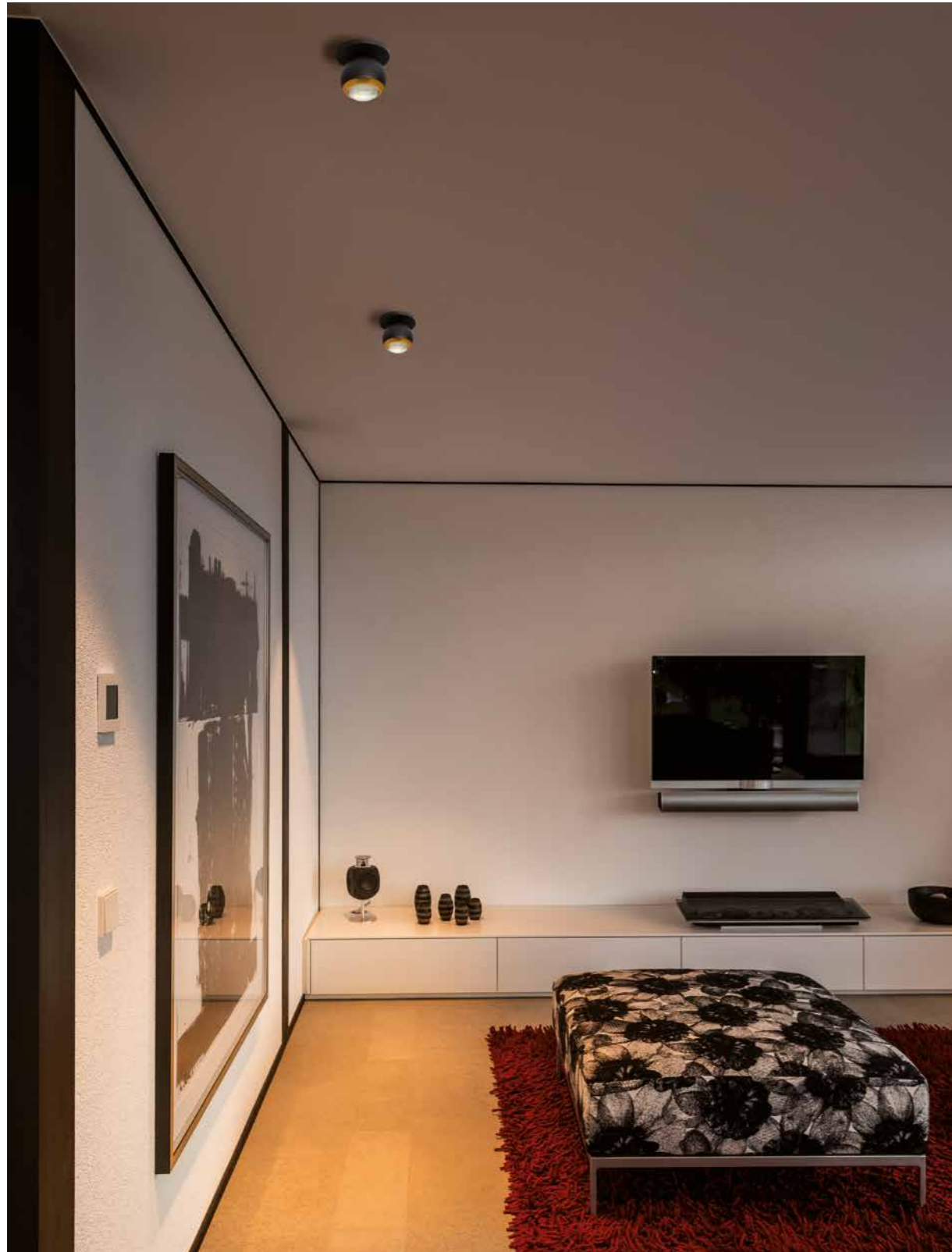

Private house London

Berrier Junior WC

LUXEON M - 3,82W - 350mA DC - (10,95 Vf)
 400 lumen 2700K CRI90
 429 lumen 3000K CRI90
 dimmability: PWM/CCR
 beam 60°

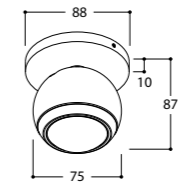

HALOSPHERE - 4,25W - 250mA DC (17 Vf)
 455 lumen 1800K ▶ 3000K CRI90
 dimmability: CCR
 beam 60°

42 mm
 Installation depth 50 mm 359° 45°
 Fits also on standard electrical accessory box with screws hole dia 68

Installation depth 61 mm

housing	front	2700K	3000K	€	1800K-3000K	€
●	●	456402	456412	185,-	456492	198,-
●	●	456444	456454	185,-	456414	198,-
●	●	456445	456455	185,-	456415	198,-
○	○	456434	456424	185,-	456404	198,-
○	●	456452	456462	185,-	456422	198,-
●	●	456496	456486	189,-	456476	202,-

Family members:



surface mounted

Berrier Junior M10 WC

LUXEON M - 3,82W - 350mA DC - (10,95 Vf)
 400 lumen 2700K CRI90
 429 lumen 3000K CRI90
 dimmability: PWM/CCR
 beam 60°

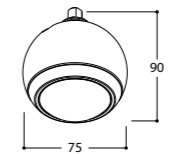

HALOSPHERE - 4,25W - 250mA DC (17 Vf)
 455 lumen 1800K ▶ 3000K CRI90
 dimmability: CCR
 beam 60°

45°

housing	front	2700K	3000K	€	1800K-3000K	€
●	●	456602	456612	149,-	456692	162,-
●	●	456644	456654	149,-	456614	162,-
●	●	456645	456655	149,-	456615	162,-
○	○	456634	456624	149,-	456604	162,-
○	●	456652	456662	149,-	456622	162,-
●	●	456696	456686	153,-	456666	166,-

M10 Base, see end of this chapter

Family members:



Berrier Junior



Van Marcke



surface mounted

Berrier Junior CI

LUXEON M - (2x) 3,82W - 230V 50-60Hz AC

2x 400 lumen 2700K CRI90
 2x 429 lumen 3000K CRI90
 dimmability: mains dim LC
 beam 60°

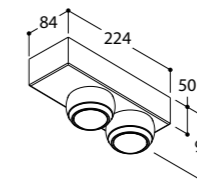

HALOSPHERE - (2x) 4,25W - 230V 50-60Hz AC

2x 455 lumen 1800K ▶ 3000K CRI90
 dimmability: mains dim LC
 beam 60°

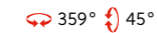

housing	front	2700K	3000K	€	1800K-3000K	€
●	●	456502	456512	410,-	456592	435,-
○	○	456534	456524	410,-	456504	435,-
○	●	456552	456562	410,-	456522	435,-
●	●	456596	456586	418,-	456566	443,-

Family members:

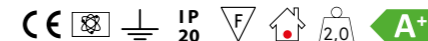

Berrier Junior



Decat

Cone Junior WC

LUXEON M - 3,82W - 350mA DC - (10,95 Vf)
 400 lumen 2700K CRI90
 429 lumen 3000K CRI90
 dimmability: PWM/CCR
 beam 60°

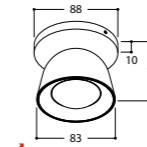

HALOSPHERE - 4,25W - 250mA DC - (17 Vf)
 455 lumen 1800K ▶ 3000K CRI90
 dimmability: CCR
 beam 60°

42 mm / Installation depth 50 mm
 Fits on standard round electrical accessory box with screws hole dia 68
 Installation depth 61 mm



housing	focus	2700K	3000K	€	1800K-3000K	€
●	●	450402	450412	185,-	450492	198,-
○	○	450434	450424	185,-	450404	198,-
●	●	450444	450454	185,-	450414	198,-
●	●	450445	450455	185,-	450415	198,-
○	●	450452	450462	185,-	450422	198,-
●	●	450496	450486	189,-	450476	202,-

Family members:



Cone Junior M10 WC

LUXEON M - 3,82W - 350mA DC - (10,95 Vf)
 400 lumen 2700K CRI90
 429 lumen 3000K CRI90
 dimmability: PWM/CCR
 beam 60°

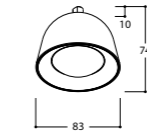

HALOSPHERE - 4,25W - 250mA DC - (17 Vf)
 455 lumen 1800K ▶ 3000K CRI90
 dimmability: CCR
 beam 60°



housing	front	2700K	3000K	€	1800K-3000K	€
●	●	450602	450612	149,-	450692	162,-
○	○	450634	450624	149,-	450604	162,-
●	●	450644	450654	149,-	450614	162,-
●	●	450645	450655	149,-	450615	162,-
○	●	450652	450662	149,-	450622	162,-
●	●	450696	450686	153,-	450666	166,-

M10 Base, see end of this chapter

Family members:





TAL Headquarters



surface mounted

Cone Wall

PREVALED - 9W - 230V 50-60Hz AC
 1017 lumen 2700K CRI90
 1066 lumen 3000K CRI90
 dimmability: mains dim RC
 beam 60°

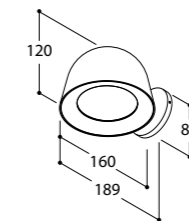

42 mm
 Installation depth 40 mm
 359°

housing	front	2700K	3000K	€
●	●	457502	457512	382,-
●	●	457544	457554	382,-
●	●	457545	457555	382,-
○	○	457534	457524	382,-
○	●	457552	457562	382,-
●	●	457596	457586	394,-

Fits on standard round electrical accessory box with screws hole dia 68
 Installation depth 61 mm

Family members:

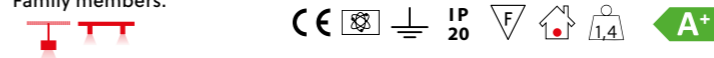

Cone

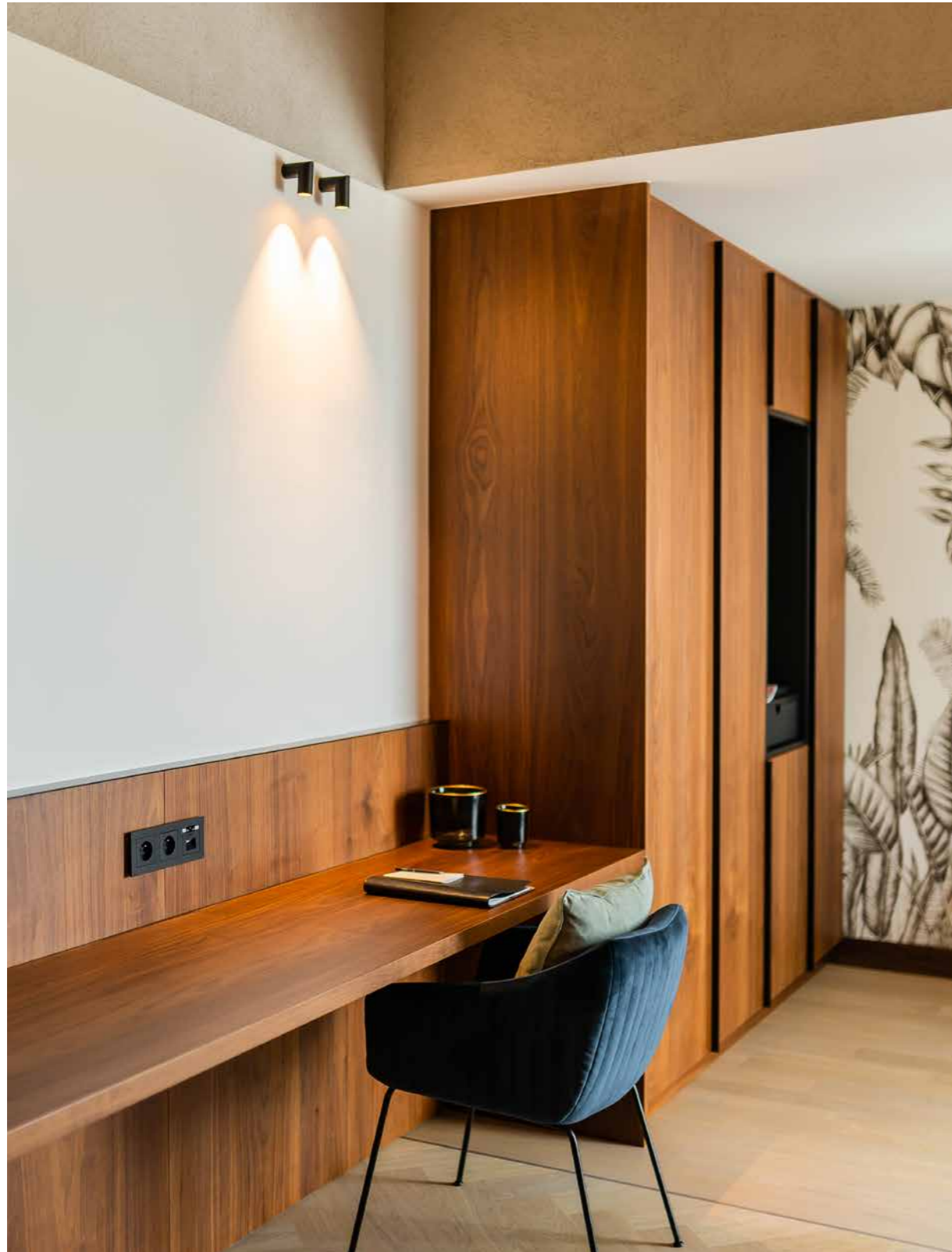

Hashotel Hasselt



Microscoop

LUXEON M - 3,82W - 350mA DC - (10,95 Vf)

400 lumen 2700K CRI90
 429 lumen 3000K CRI90
 dimmability: PWM/CCR
 beam 36°

HALOSPHERE - 4,25W - 250mA DC - (17 Vf)

455 lumen 1800K ▶ 3000K CRI90
 dimmability: CCR
 beam 40°

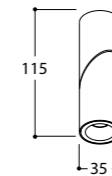

↻ 359° ↻ 359°
 Installation depth 61 mm

ⓘ Fits on box only in combination with wall adapter

housing	focus	2700K	3000K	€	1800K-3000K	€
●	●	407026	407226	125,-	407216	137,-
○	○	407027	407227	125,-	407217	137,-
●	●	407044	407244	125,-	407144	137,-
●	●	407045	407245	125,-	407145	137,-
●	●	407057	407257	125,-	407157	137,-
○	●	407095	407295	125,-	407285	137,-
●	●	407096	407296	141,-	407286	153,-
ⓘ Micro Scoop wall adapter	●	407926		37,-		
	○	407947		37,-		

Family members:



4000K ON DEMAND

ⓘ Converter matrix, see back flap

surface mounted

Microscoop

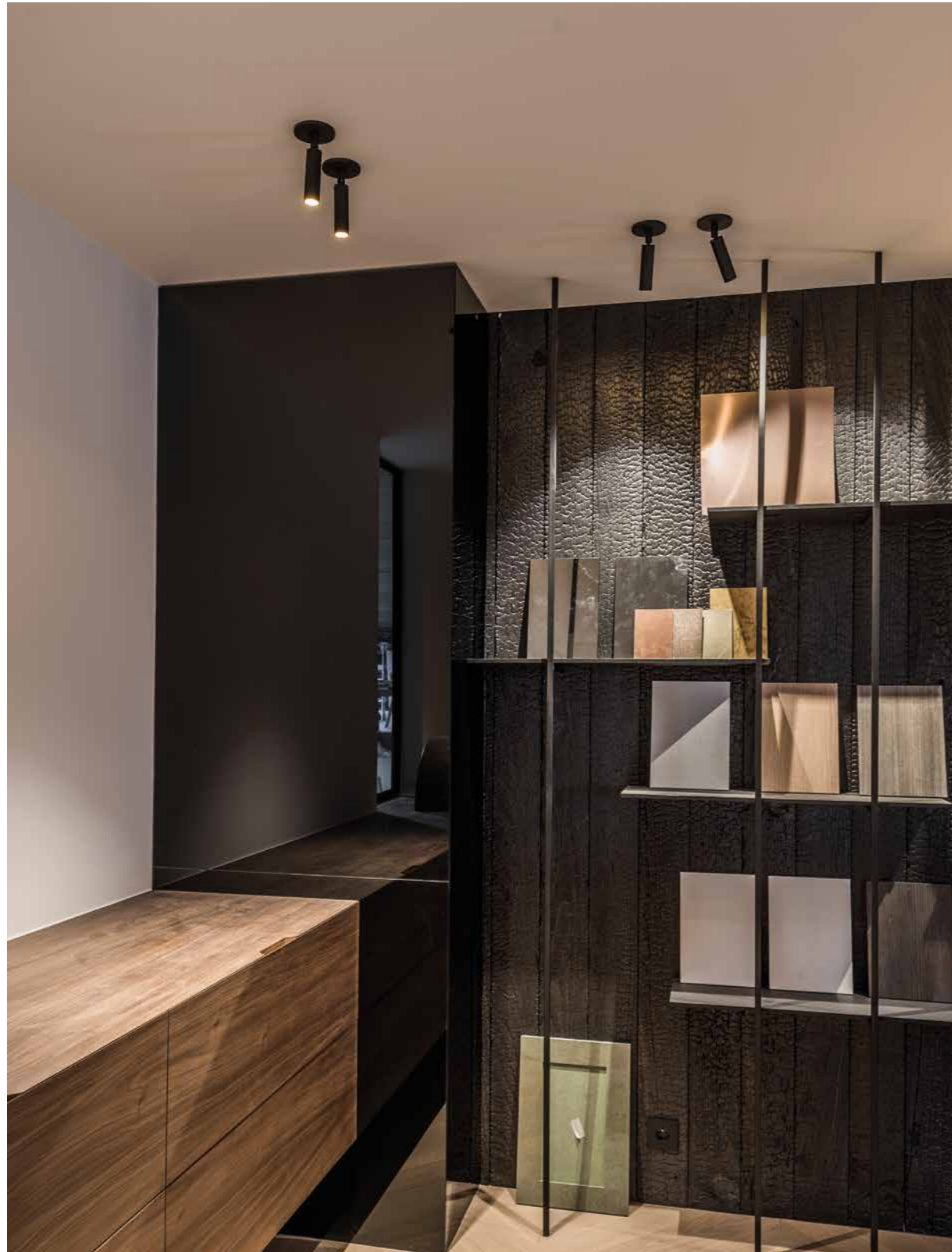

De Maatwerker Knokke

Nobel Elbow WC

LUXEON M - 3,82W - 350mA DC - (10,95 Vf)

400 lumen 2700K CRI90
429 lumen 3000K CRI90
dimmability: PWM/CCR
beam 36°

HALOSPHERE - 4,25W - 250mA DC - (17 Vf)

455 lumen 1800K ▶ 3000K CRI90
dimmability: CCR
beam 40°

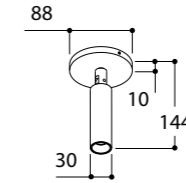

42 mm
Installation depth 40 mm
359° 90°

Fits on standard round electrical accessory box with screws hole dia 68

Installation depth 61 mm

housing	focus	2700K	3000K	€	1800K-3000K	€
○	○	459047	459036	127,-	459016	139,-
●	●	459026	459057	127,-	459037	139,-
●	●	459096	459086	131,-	459066	143,-

Family members:



Nobel Elbow 1 Base

LUXEON M - 3,82W - 230V 50-60Hz AC

400 lumen 2700K CRI90
429 lumen 3000K CRI90
dimmability: mains dim LC
beam 36°

HALOSPHERE - 4,25W - 230V 50-60Hz AC

455 lumen 1800K ▶ 3000K CRI90
dimmability: mains dim LC
beam 40°

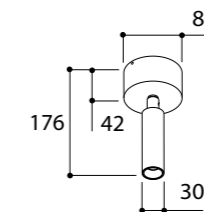

359° 90°

housing	focus	2700K	3000K	€	1800K-3000K	€
○	○	459107	459117	141,-	459137	153,-
●	●	459102	459112	141,-	459116	153,-
●	●	459106	459156	145,-	459166	157,-

Family members:

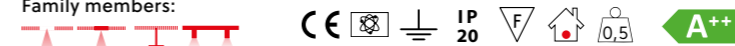

4000K ON DEMAND Converter matrix, see back flap



surface mounted



Nobel Elbow

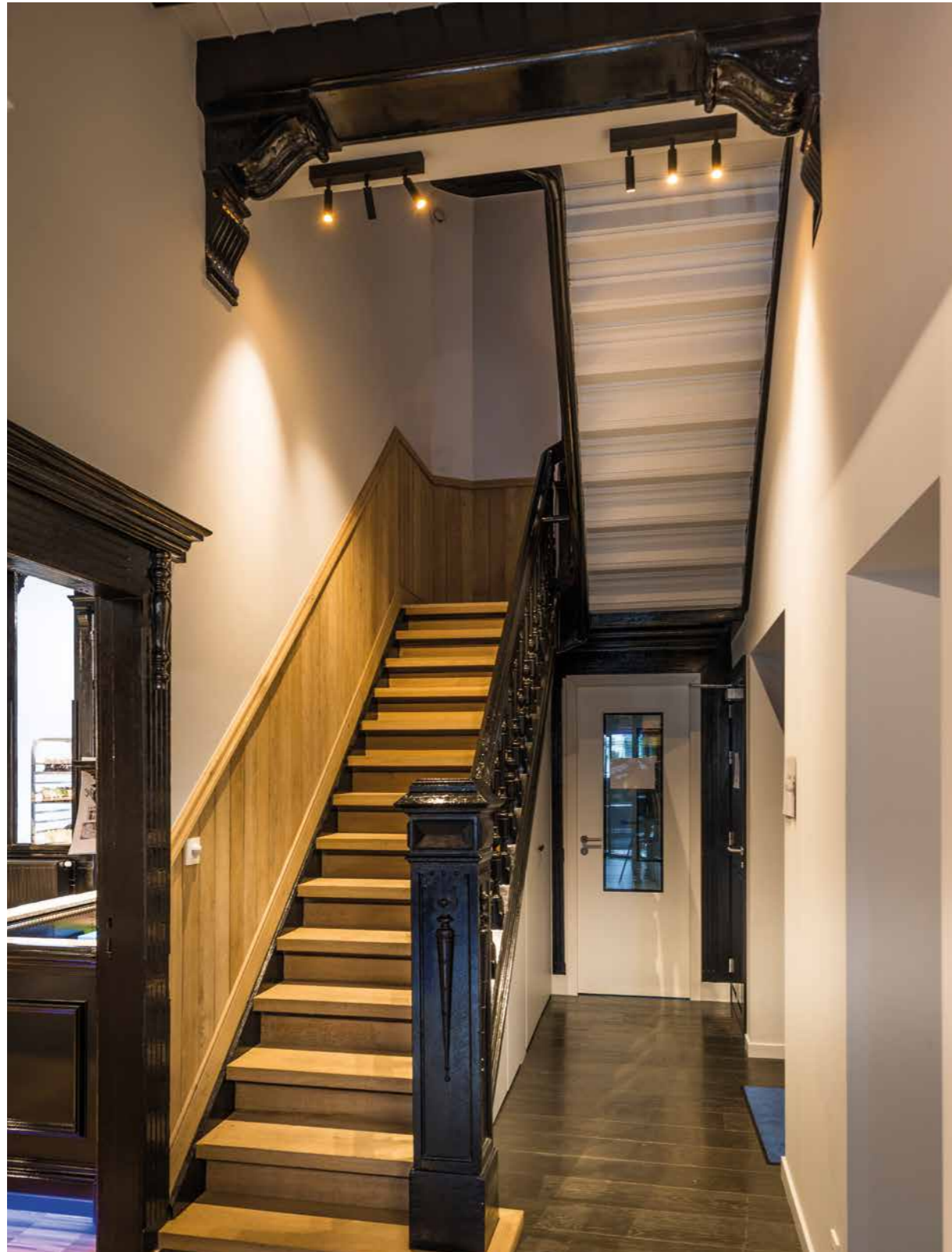

Royce Chocolate Antwerp

Nobel Elbow M10

LUXEON M - 3,82W - 350mA DC - (10,95 Vf)

400 lumen 2700K CRI90
 429 lumen 3000K CRI90
 dimmability: PWM/CCR
 beam 36°

HALOSPHERE - 4,25W - 250mA DC - (17 Vf)

455 lumen 1800K ▶ 3000K CRI90
 dimmability: CCR
 beam 40°

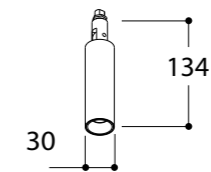

↻ 359° ↻ 90°



housing	focus	2700K	3000K	€	1800K-3000K	€
○	○	459547	459557	92,-	459537	104,-
●	●	459526	459536	92,-	459516	104,-
●	●	459567	459577	129,-	459597	141,-
●	●	459596	459586	96,-	459566	108,-

ⓘ M10 Base, see end of this chapter

Family members:

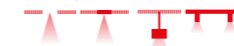

ⓘ Converter matrix, see back flap

Microscop/Cockpit 2-way switch

LUXEON M - 3,82W - 350mA DC - (10,95 Vf)
400 lumen 2700K CRI90
dimmability: not dimmable
beam 36°

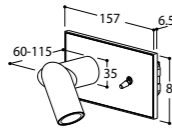

housing	switch	2700K	€
●	●	253226	293,-
○	Lithoss RAL 9010	253211	293,-
●	●	253244	293,-
●	●	253245	293,-
●	knurl	253296	293,-

↻ 359° ↻ 359°
Installation depth 45 mm



Microscop/1T 24V-250V push button

LUXEON M - 3,82W - 350mA DC - (10,95 Vf)
400 lumen 2700K CRI90
dimmability: PWM/CCR
beam 36°

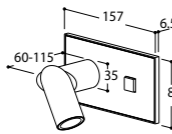

housing	switch	2700K	€
●	●	253026	255,-
○	Lithoss RAL 9010	253011	255,-
●	●	253044	255,-
●	●	253045	255,-
●	●	253096	275,-

↻ 359° ↻ 359°
Installation depth 40 mm
i remote relays or home automation system



Microscop/Mains Dimmer

LUXEON M - 3,82W - 350mA DC - (10,95 Vf)
400 lumen 2700K CRI90
lamp dimmability: PWM/CCR
dimmer: RLC dimming 20-420VA
beam 36°

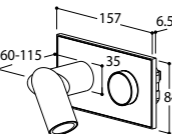

housing	switch	2700K	€
●	●	253126	466,-
○	Lithoss RAL 9010	253111	466,-
●	●	253144	466,-
●	●	253145	466,-
●	knurl	253196	475,-

↻ 359° ↻ 359°
Installation depth 45 mm
i 350 mA converter mains dimmable



Nobel Elbow/Cockpit 2-way switch

LUXEON M - 3,82W - 350mA DC - (10,95 Vf)
400 lumen 2700K CRI90
dimmability: not dimmable
beam 36°

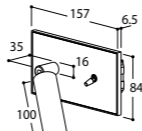

housing	switch	2700K	€
●	●	253526	245,-
○	Lithoss RAL 9010	253511	245,-
●	●	253544	245,-
●	●	253545	245,-
●	knurl	253596	245,-

↻ 315° ↻ 90°
Installation depth 45 mm



Nobel Elbow/1T 24V-250V push button

LUXEON M - 3,82W - 350mA DC - (10,95 Vf)
400 lumen 2700K CRI90
dimmability: PWM/CCR
beam 36°

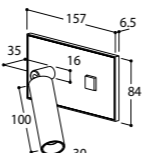

housing	switch	2700K	€
●	●	253326	208,-
○	Lithoss RAL 9010	253311	208,-
●	●	253344	208,-
●	●	253345	208,-
●	●	253396	228,-

↻ 315° ↻ 90°
Installation depth 40 mm
i remote relays or home automation system



Nobel Elbow/Mains Dimmer

LUXEON M - 3,82W - 350mA DC - (10,95 Vf)
400 lumen 2700K CRI90
lamp dimmability: PWM/CCR
dimmer: RLC dimming 20-420VA
beam 36°

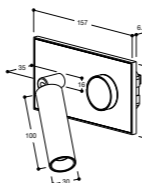

housing	switch	2700K	€
●	●	253426	419,-
○	Lithoss RAL 9010	253411	419,-
●	●	253444	419,-
●	●	253445	419,-
●	knurl	253496	428,-

↻ 315° ↻ 90°
Installation depth 45 mm
i 350 mA converter mains dimmable



Mains Dimmer

230V 50-60Hz
dimmer: RLC dimming 20-420VA

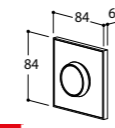

housing	switch	€
●	●	253626 273,-
○	○	253611 273,-
●	●	253644 273,-
●	●	253645 273,-
●	knurl	253696 281,-

i Fits on standard single electrical accessory box with screws



Installation depth 45 mm



i for use with mains dimmable powered converters



Private house Brussels



Private house Brussels

surface mounted





Casello Schilde



Berrier

PREVALED - 12,7W - 230V 50-60Hz AC
 1365 lumen 2700K CRI90
 dimmability: mains dim LC
 beam 60°

i adjust by incorporated hinge
 with hex key

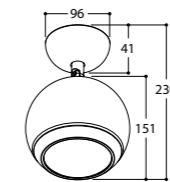

↻ 359° ↻ 45°

housing	front	2700K	€
○	○	494247	383,-
●	●	494226	383,-
●	●	494219	392,-
○	●	494220	392,-
●	●	494296	400,-
●	●	494250	484,-
●	●	494256	403,-
●	●	494257	403,-
○	●	494294	383,-
●	○	494295	383,-

Family members:





Gopa Keukens

Mini Scoop Deimos CI

LUXEON M - 7,84 W - 230V 50-60Hz AC
 755 lumen 2700K CRI90
 810 lumen 3000K CRI90
 dimmability: mains dim LC
 beam 36°

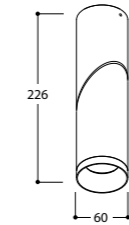

↻ 359° ↴ 90°

finish	2700K			3000K			€
	9°	38°	60°	9°	38°	60°	
○	179727	179747	179767	179737	179757	179777	255,-
●	179706	179726	179746	179716	179736	179756	255,-
ⓘ Mini Scoop foot	○	179090	22,-	●	179091	22,-	

4000K ON DEMAND



Mini Scoop GU10

LED PAR16 - MAX 10W - 230V 50-60Hz AC
 GU10
 dimmability: dependend on bulb

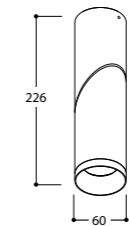

↻ 359° ↴ 90°

finish	€	
	○	179247
●	179226	191,-
ⓘ Mini Scoop foot	○	179090 22,-
	●	179091 22,-



surface mounted

Mini Scoop Deimos

Funnel Elbow M10

LUXEON M - 7,84 W - 230V 50-60Hz AC
 755 lumen 2700K CRI90
 810 lumen 3000K CRI90
 dimmability: mains dim RC
 beam 36°

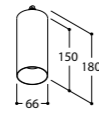

90°

housing	focus	2700K	3000K	€
○	○	478667	478677	198,-
●	●	478646	478656	198,-
●	●	478706	478716	202,-
○	●	478702	478712	202,-

Family members:

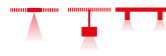

Funnel Elbow M10 GU10

LED PAR16 - MAX 10W - 230V 50-60Hz AC
 GU10
 dimmability: depend on bulb

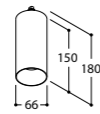

90°

housing	focus	€
○	○	478267 143,-
●	●	478246 143,-
●	●	478316 147,-
○	●	478312 147,-

Family members:

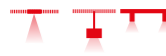

Franco Belge Brugge

Funnel Elbow

LUXEON M - 7,84 W - 230V 50-60Hz AC
 755 lumen 2700K CRI90
 810 lumen 3000K CRI90
 dimmability: mains dim RC
 beam 36°

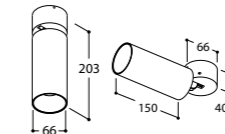

90°

housing	focus	2700K	3000K	€
○	○	479647	479636	225,-
●	●	479626	479657	225,-
●	●	479686	479696	229,-
○	●	479682	479692	229,-

Family members:



Funnel Elbow GU10

LED PAR16 - MAX 10W - 230V 50-60Hz AC
 GU10
 dimmability: depend on bulb

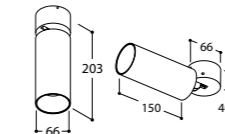

90°

housing	focus	€
○	○	479247 168,-
●	●	479226 168,-
●	●	479296 172,-
○	●	479292 172,-

Family members:

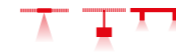

surface mounted

Funnel

Funnel Elbow Leaf

LUXEON M - 7,84 W - 230V 50-60Hz AC
 755 lumen 2700K CRI90
 810 lumen 3000K CRI90
 dimmability: mains dim RC
 beam 36°

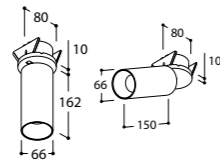

housing	focus	2700K	3000K	€	
○	○	479947	479957	185,-	
●	●	479926	479936	185,-	
●	●	479986	479996	189,-	
○	●	479982	479992	189,-	

Family members:

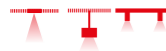

Funnel Elbow Leaf GU10

LED PAR16 - MAX 10W - 230V 50-60Hz AC
 GU10
 dimmability: dependend on bulb

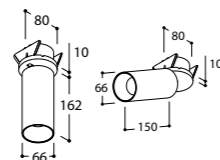

housing	focus	€	
○	○	479257 143,-	
●	●	479236 143,-	
●	●	479286 147,-	
○	●	479282 147,-	

Family members:



Funnel Elbow Torsion

LUXEON M - 7,84 W - 230V 50-60Hz AC
 755 lumen 2700K CRI90
 810 lumen 3000K CRI90
 dimmability: mains dim RC
 beam 36°

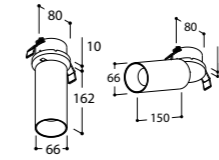

housing	focus	2700K	3000K	€	
○	○	479948	479958	185,-	
●	●	479927	479937	185,-	
●	●	479987	479997	189,-	
○	●	479983	479993	189,-	

Family members:



Funnel Elbow Torsion GU10

LED PAR16 - MAX 10W - 230V 50-60Hz AC
 GU10
 dimmability: dependend on bulb

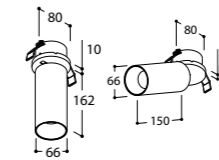

housing	focus	€	
○	○	479258 143,-	
●	●	479237 143,-	
●	●	479287 147,-	
○	●	479283 147,-	

Family members:





Loft Antwerp



Funnel On Splash

LUXEON M - 3,82W - 230V 50-60Hz AC
 400 lumen 2700K CRI90
 429 lumen 3000K CRI90
 dimmability: mains dim LC
 beam 36°

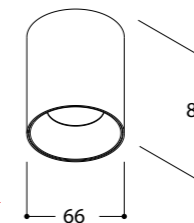

housing	focus	2700K	3000K	€
○	○	433947	433948	184,-
●	●	433926	433927	184,-
●	●	433996	433997	188,-
○	●	433992	433993	188,-

Family members:



Funnel On 150 CI

LUXEON M - 7,84 W - 230V 50-60Hz AC
 755 lumen 2700K CRI90
 810 lumen 3000K CRI90
 dimmability: mains dim RC
 beam 36°

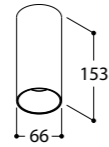

housing	focus	2700K	3000K	€
○	○	479447	479457	163,-
●	●	479426	479436	163,-
●	●	479486	479496	167,-
○	●	479482	479492	167,-

Family members:

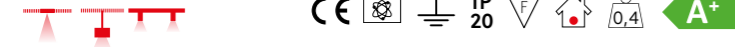

Funnel On 150 GU10

LED PAR16 - MAX 10W - 230V 50-60Hz AC
 GU10
 dimmability: dependend on bulb

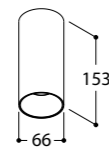

housing	focus	€
○	○	479047 112,-
●	●	479026 112,-
●	●	479096 116,-
○	●	479092 116,-

Family members:



Funnel On 240 CI

LUXEON M - 7,84 W - 230V 50-60Hz AC
 755 lumen 2700K CRI90
 810 lumen 3000K CRI90
 dimmability: mains dim RC
 beam 36°

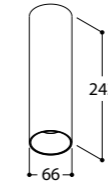

housing	focus	2700K	3000K	€
○	○	479547	479557	204,-
●	●	479526	479536	204,-
●	●	479586	479596	208,-
○	●	479582	479592	208,-

Family members:



Funnel On 240 GU10

LED PAR16 - MAX 10W - 230V 50-60Hz AC
 GU10
 dimmability: dependend on bulb

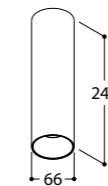

housing	focus	€
○	○	479147 153,-
●	●	479126 153,-
●	●	479196 157,-
○	●	479192 157,-

Family members:





Private house Kortrijk

Funnel WC Single Beam

LUXEON M - 5,53W - 500mA DC - (11,05 Vf)

566 lumen 2700K CRI90
608 lumen 3000K CRI90
dimmability: PMW/CCR
beam 36°

↓ up or ↑ down

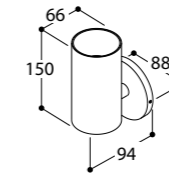

i Fits on standard round electrical accessory box with screws hole dia 68

Installation depth 61 mm

housing	focus	2700K	3000K	€
		484747	484757	189,-
		484726	484736	189,-
		484786	484796	193,-
		484782	484792	193,-

Family members:



i Converter matrix, see back flap

Funnel CI Single Beam

LUXEON M - 5,53W - 230V 50-60Hz AC

566 lumen 2700K CRI90
608 lumen 3000K CRI90
dimmability: mains dim LC
beam 36°

↓ up or ↑ down

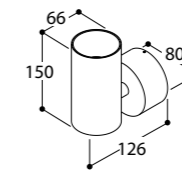

housing	focus	2700K	3000K	€
		484847	484857	209,-
		484826	484836	209,-
		484886	484896	213,-
		484882	484892	213,-

Family members:

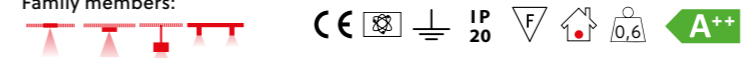

4000K ON DEMAND



surface mounted



Funnel



TAL Headquarters

Funnel Up/down WC

LUXEON M - (2x) 5,53W - 500mA DC - (2x 11,05 Vf)
 2x 566 lumen 2700K CRI90
 2x 608 lumen 3000K CRI90
 dimmability: PWM/CCR
 beam 36°
 up/down

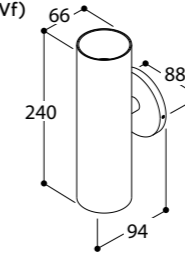

i Fits on standard round electrical accessory box with screws

Installation depth 61 mm

housing	focus	2700K	3000K	€
		485747	485757	280,-
		485726	485736	280,-
		485786	485796	288,-
		485782	485792	288,-

Family members:

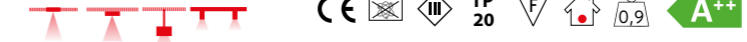

i Converter matrix, see back flap

Funnel Up/down CI

LUXEON M - (2x) 5,53W - 230V 50-60Hz AC
 2x 566 lumen 2700K CRI90
 2x 608 lumen 3000K CRI90
 dimmability: mains dim LC
 beam 36°
 up/down

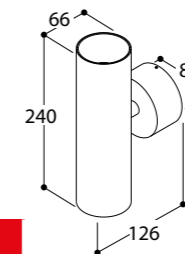

housing	focus	2700K	3000K	€
		485847	485857	296,-
		485826	485836	296,-
		485886	485896	304,-
		485882	485892	304,-

Family members:

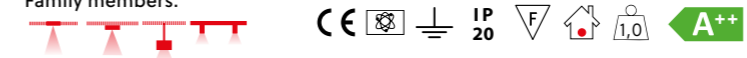

4000K ON DEMAND



surface mounted



Funnel

Funnel Single Beam GU10 For Wallbox

LED PAR16 - MAX 10W - 230V 50-60Hz AC

GU10

dimmbility: dependend on bulb

▼ up or ▲ down

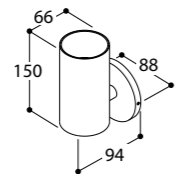

housing	focus		€
○	○	484737	158,-
●	●	484716	158,-
●	●	484776	162,-
○	●	484783	162,-

Family members:



Funnel Up/down GU10 For Wallbox

LED PAR16 - (2x) MAX 10W - 230V 50-60Hz AC

GU10

dimmbility: dependend on bulb

▲ up/down

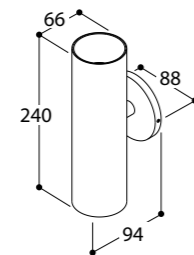

housing	focus		€
○	○	485737	211,-
●	●	485716	211,-
●	●	485776	219,-
○	●	485783	219,-

Family members:



Funnel Single Beam GU10

LED PAR16 - MAX 10W - 230V 50-60Hz AC

GU10

dimmbility: dependend on bulb

▼ up or ▲ down

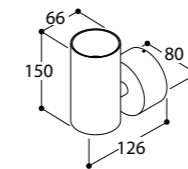

housing	focus		€
○	○	484837	152,-
●	●	484816	152,-
●	●	484876	156,-
○	●	484883	156,-

Family members:

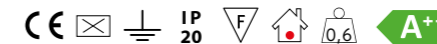

Funnel Up/down GU10

LED PAR16 - (2x) MAX 10W - 230V 50-60Hz AC

GU10

dimmbility: dependend on bulb

▲ up/down

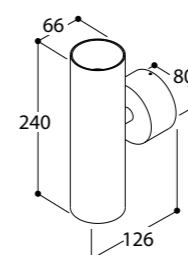

housing	focus		€
○	○	485837	205,-
●	●	485816	205,-
●	●	485876	213,-
○	●	485883	213,-

Family members:

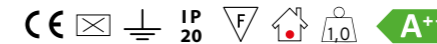

Funnel



Lithoss Maison et Objet

Habana WC Single Beam

LUXEON M - 3,82W - 350mA DC - (10,95 Vf)
 400 lumen 2700K CRI90
 429 lumen 3000K CRI90
 dimmability: PWM/CCR
 beam 36°

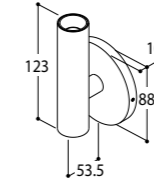

HALOSPHERE - 4,25W - 250mA DC - (17 Vf)
 455 lumen 1800K ▶ 3000K CRI90
 dimmability: CCR
 beam 40°

i Fits on standard round electrical accessory box with screws hole dia 68

⬇ up or ⬆ down

i Installation depth 61 mm

housing	focus	base	2700K	3000K	€	1800K-3000K	€
○	○	○	467047	467067	150,-	467087	157,-
●	●	●	467026	467046	150,-	467036	157,-
●	●	●	467096	467016	154,-	467006	161,-
●	●	●	467057	467077	225,-	467097	237,-

Family members (Nobel):

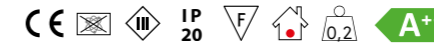

i Converter matrix, see back flap

Habana CI Single Beam

LUXEON M - 3,82W - 230V 50-60Hz AC
 400 lumen 2700K CRI90
 429 lumen 3000K CRI90
 dimmability: mains dim LC
 beam 36°

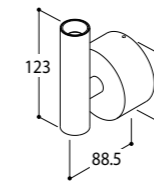

HALOSPHERE - 4,25W - 230V 50-60Hz AC
 455 lumen 1800K ▶ 3000K CRI90
 dimmability: mains dim LC
 beam 40°

⬇ up or ⬆ down

housing	focus	base	2700K	3000K	€	1800K-3000K	€
○	○	○	467217	467227	187,-	467287	200,-
●	●	●	467256	467266	187,-	467236	200,-
●	●	●	467276	467286	191,-	467206	204,-
●	●	●	467228	467238	234,-	467298	246,-

Family members (Nobel):

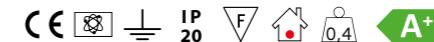
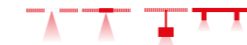

4000K ON DEMAND



surface mounted



Habana

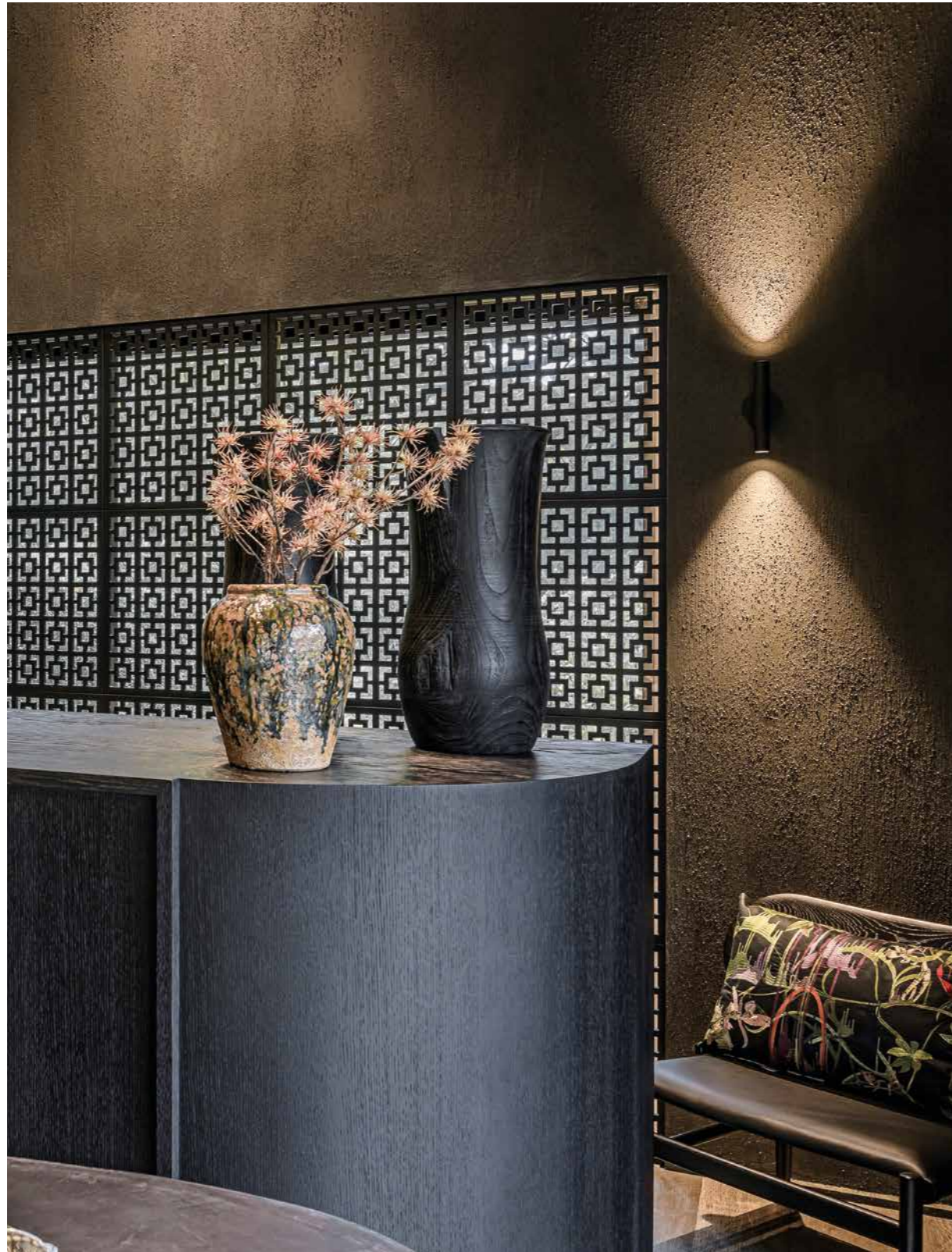

Casello Schilde

Habana Up/down WC

LUXEON M - (2x) 3,82W - 350mA DC - (2x 10,95 Vf)
 2x 400 lumen 2700K CRI90
 2x 429 lumen 3000K CRI90
 dimmability: PWM/CCR
 beam 36°

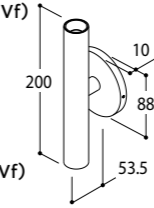

HALOSPHERE - (2x) 4,25W - 250mA DC - (2x 17 Vf)
 2x 455 lumen 1800K ▶ 3000K CRI90
 dimmability: CCR
 beam 40°

i Fits on standard round electrical accessory box with screws hole dia 68

up/down

Installation depth 61 mm

housing	focus	base	2700K	3000K	€	1800K-3000K	€
○	○	○	467147	467167	172,-	467187	197,-
●	●	●	467126	467146	172,-	467136	197,-
●	●	●	467196	467116	180,-	467106	205,-
●	●	●	467157	467177	253,-	467197	277,-

Family members (Nobel):



i Converter matrix, see back flap

Habana Up/down CI

LUXEON M - (2x) 3,82W - 230V 50-60Hz AC
 2x 400 lumen 2700K CRI90
 2x 429 lumen 3000K CRI90
 dimmability: mains dim LC
 beam 40°

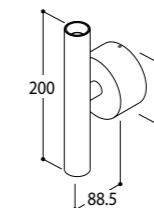

HALOSPHERE - (2x) 4,25W - 230V 50-60Hz AC
 2x 455 lumen 1800K ▶ 3000K CRI90
 dimmability: mains dim LC
 beam 36°

up/down

housing	focus	base	2700K	3000K	€	1800K-3000K	€
○	○	○	467317	467327	218,-	467387	243,-
●	●	●	467356	467366	218,-	467336	243,-
●	●	●	467376	467386	226,-	467306	251,-
●	●	●	467328	467338	267,-	467398	291,-

Family members (Nobel):

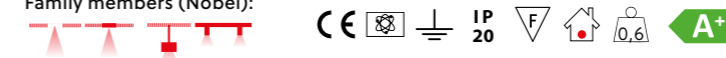

4000K ON DEMAND



surface mounted

Habana



Cras Woodshop

Telescoop

LUXEON M - 7,84 W - 230V 50-60Hz AC
 755 lumen 2700K CRI90
 810 lumen 3000K CRI90
 dimmability: mains dim LC
 adjustable beam 20°- 48°

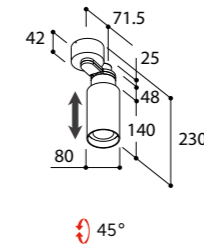

finish	2700K	3000K	€
○	491447	491457	522,-
●	491426	491436	522,-

Family members:

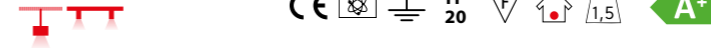

Nelson

LUXEON M - 7,84 W - 230V 50-60Hz AC
 755 lumen 2700K CRI90
 810 lumen 3000K CRI90
 dimmability: mains dim LC
 adjustable beam 20°- 48°

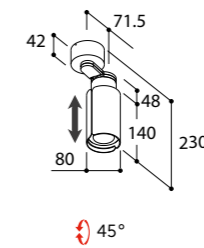

finish	layer	2700K	3000K	€
○	●	491057	491067	594,-
●	●	491056	491066	594,-
●	●	491050	491060	594,-

Family members:

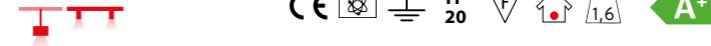

surface mounted

Designed by Sylvain Willenz

Telescoop & Nelson



Gopa Keukens

Hubble 300

LED ARRAY - 13,3W - 230V 50-60Hz AC
 2000 lumen 3000K CRI82
 dimmability: mains dim LC or dali touch dim

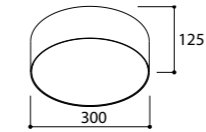

- Opal diffuser
- Indirect backlight

finish	3000K	€	3000K	€
	dimnable L, C		touch/dali dimmable	
○	491847	460,-	491857	483,-
●	491826	460,-	491836	483,-

Family members:



Hubble 400

LED ARRAY - 20,1W - 230V 50-60Hz AC
 2960 lumen 3000K CRI82
 dimmability: mains dim LC or dali touch dim

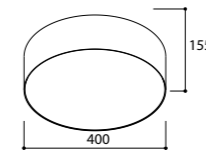

- Opal diffuser
- Indirect backlight

finish	3000K	€	3000K	€
	dimnable L, C		touch/dali dimmable	
○	491867	666,-	491877	689,-
●	491846	666,-	491856	689,-

Family members:





Nelson Hairteam Destelbergen

Rollo 300

LED ARRAY - 13,3W - 230V 50-60Hz AC
 2000 lumen 3000K CRI82
 dimmability: mains dim LC or dali touch dim

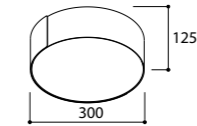

- Opal diffuser
- Indirect backlight

finish	layer	3000K	€	3000K	€
		dimmable L, C		touch/dali dimmable	
		492057	569,-	492067	583,-
		492056	569,-	492066	583,-
		492050	569,-	492060	583,-

Family members:



Rollo 400

LED ARRAY - 20,1W - 230V 50-60Hz AC
 2960 lumen 3000K CRI82
 dimmability: mains dim LC or dali touch dim

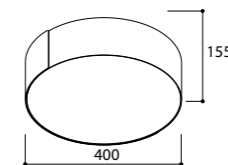

- Opal diffuser
- Indirect backlight

finish	layer	3000K	€	3000K	€
		dimmable L, C		touch/dali dimmable	
		492257	828,-	492267	865,-
		492256	828,-	492266	865,-
		492250	828,-	492260	865,-

Family members:



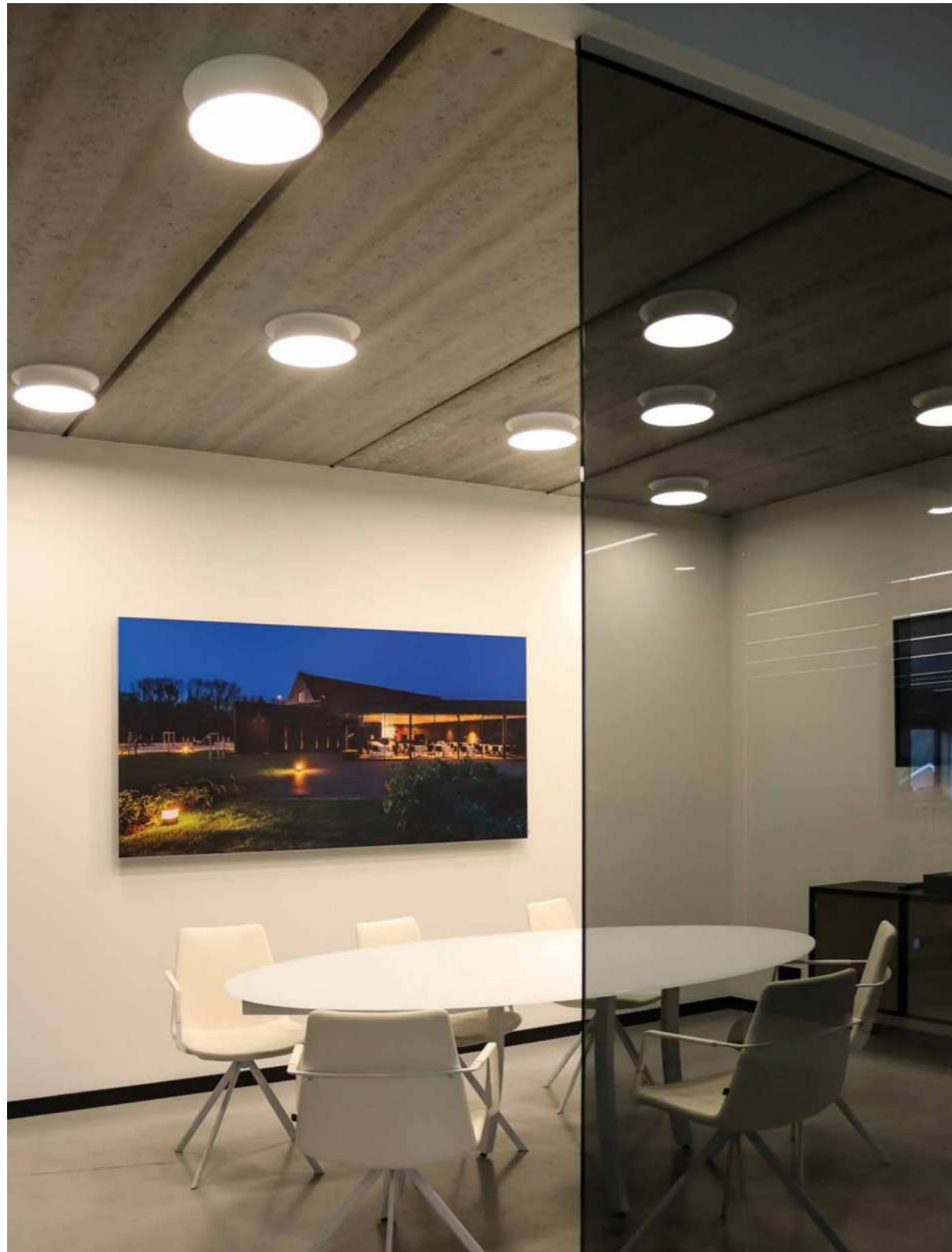

TAL Headquarters

Diabolo M

LED ARRAY - 13,3W - 230V 50-60Hz AC
 2000 lumen 3000K CRI82
 2200 lumen 4000K CRI82
 dimmability: mains dim LC or dali touch dim

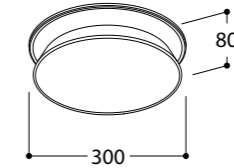

finish	3000K	4000K	€	3000K	4000K	€
	mains dim			dali touch		
○	177647	177657	270,-	177747	177757	312,-
●	177626	177636	270,-	177726	177736	312,-

Family members:

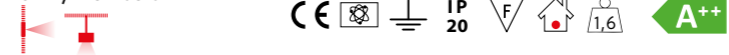

surface mounted

Diabolo XL

LED ARRAY - 70,8W - 230V 50-60Hz AC
 13000 lumen 2700K CRI80
 13000 lumen 3000K CRI80
 13000 lumen 4000K CRI80
 dimmability: dali touch dim

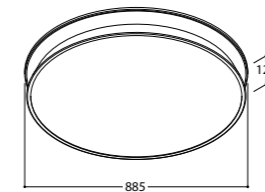

finish	2700K	3000K	4000K	€
○	277037	277047	277057	1813,-
●	277016	277026	277036	1813,-

Family members:

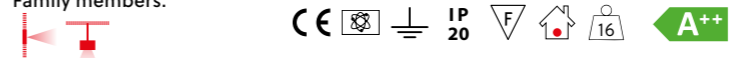

Designed by Cas Moor & Lieven Musschoot

Diabolo



Multum Wetteren

Fabian 300

LED ARRAY - 13,3W - 230V 50-60Hz AC

2000 lumen 3000K CRI82
2200 lumen 4000K CRI82
dimmability: mains dim LC or dali touch dim

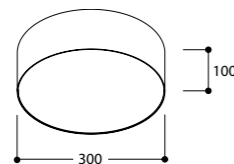

finish	3000K	4000K	€	3000K	4000K	€
	mains dim			dali touch		
○	620147	620167	387,-	620157	620177	426,-
●	620146	620166	387,-	620156	620176	426,-

Family members:

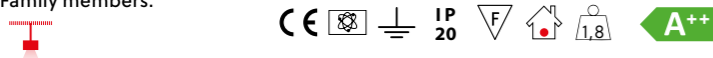

Fabian 400

LED ARRAY - 20,1W - 230V 50-60Hz AC

2960 lumen 3000K CRI82
3270 lumen 4000K CRI82
dimmability: mains dim LC or dali touch dim

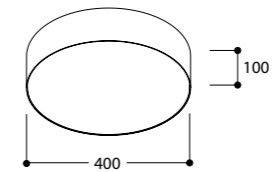

finish	3000K	4000K	€	3000K	4000K	€
	mains dim			dali touch		
○	621147	621167	469,-	621157	621177	497,-
●	621146	621166	469,-	621156	621176	497,-

Family members:

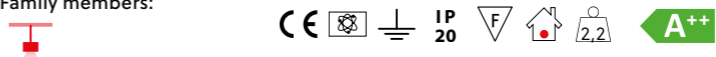

Fabian 500

LED ARRAY - 28W - 230V 50-60Hz AC

5200 lumen 3000K CRI80
5200 lumen 4000K CRI80
dimmability: non-dim or dali touch dim

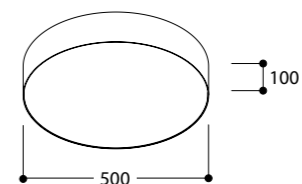

finish	3000K	4000K	€	3000K	4000K	€
	non-dim			dali touch		
○	630147	630167	568,-	630157	630177	596,-
●	630146	630166	568,-	630156	630176	596,-

Family members:

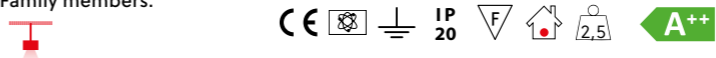

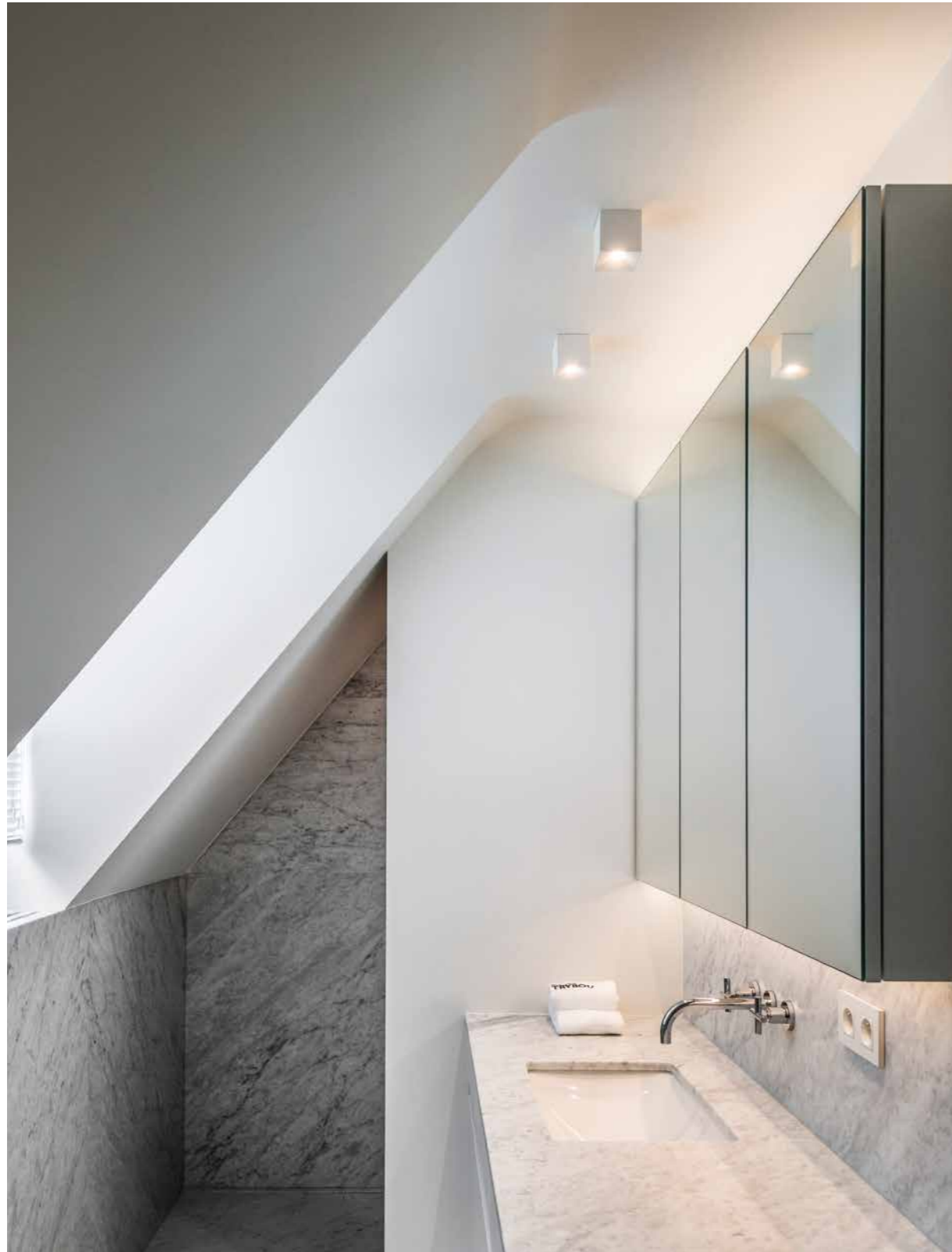

Private house Brussels

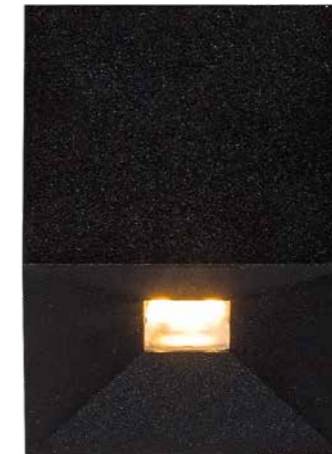

Dice

LUXEON M LED - 3,82W - 230V 50-60Hz AC

400 lumen 2700K CRI90
 429 lumen 3000K CRI90
 dimmability: mains dim LC
 beam 50°

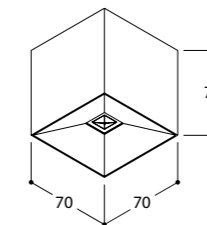

finish	2700K	3000K	€
○	377147	377137	102,-
●	377126	377116	102,-

Family members:

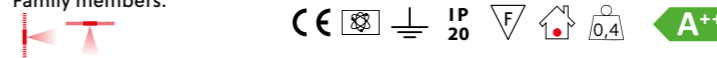

surface mounted

Dice



Danilith Wortegem - Petegem

Blox Single Beam

CREE XPE - 1,2W - 230V 50-60Hz AC
 94 lumen 2700K CRI80
 94 lumen 3000K CRI80
 dimmability: mains dim LC
 beam 70°
 up or down

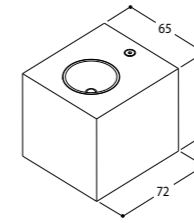

housing	focus	2700K	3000K	€
○	●	175277	175297	156,-
●	●	175278	175298	147,-
●	●	175476	175496	147,-
●	●	175256	175266	156,-

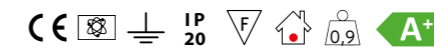

surface mounted

Blox Up/down

CREE XPE - (2x) 1,2W - 230V 50-60Hz AC
 2x 94 lumen 2700K CRI80
 2x 94 lumen 3000K CRI80
 dimmability: mains dim LC
 beam 70°
 up/down

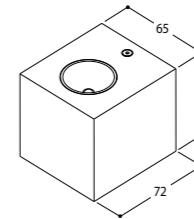

housing	focus	2700K	3000K	€
○	●	175377	175397	188,-
●	●	175378	175398	178,-
●	●	175576	175596	178,-
●	●	175356	175366	188,-



Blox

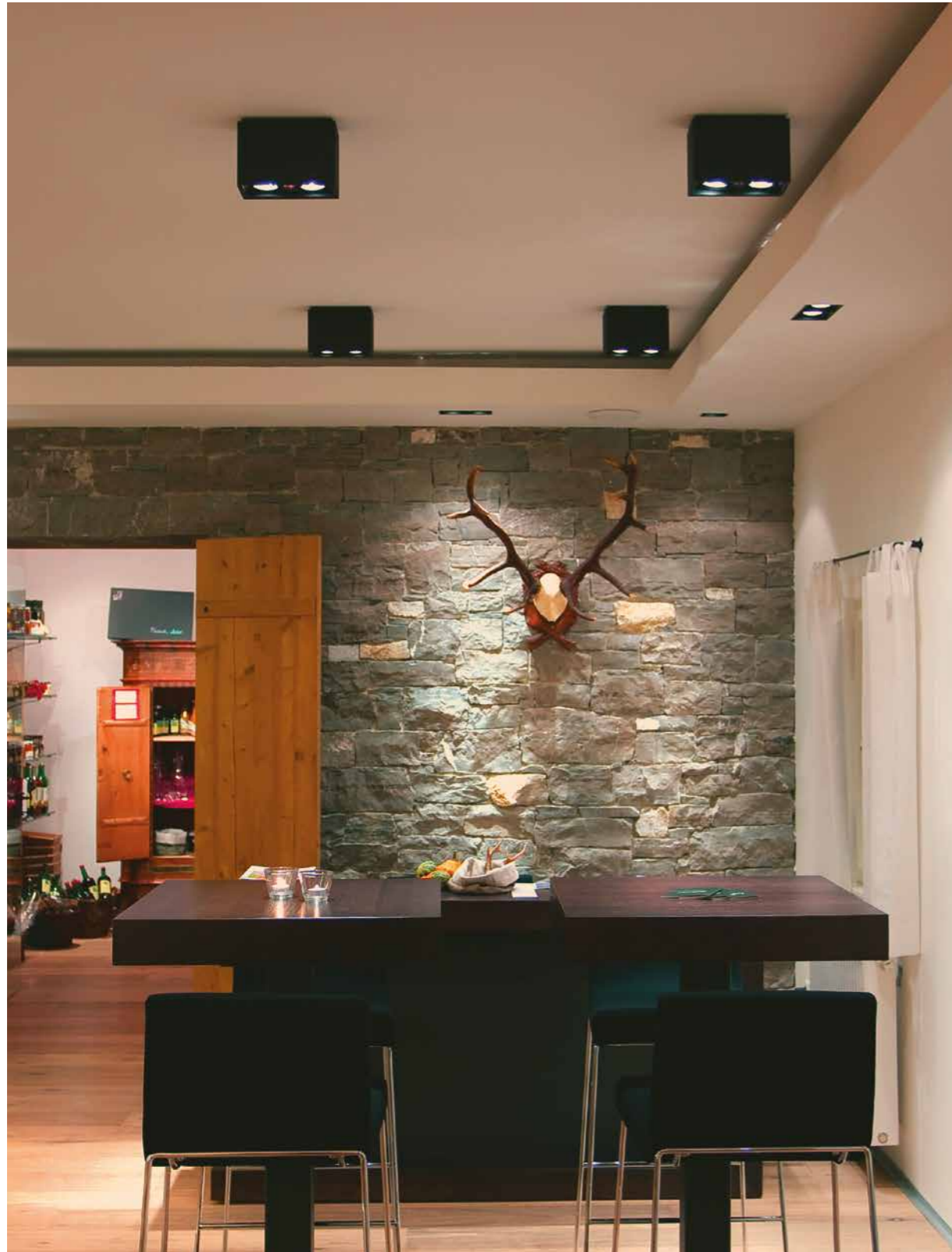

Private house Switzerland

Django Haloled

LUXEON M - 5,53W - 230V 50-60Hz AC

566 lumen 2700K CRI90
608 lumen 3000K CRI90
dimmability: not dimmable
beam 36°

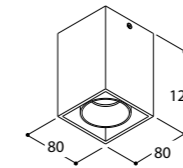

housing	focus	2700K	3000K	€
○	○	371941	371943	156,-
●	●	371942	371944	156,-
○	●	371945	371946	156,-

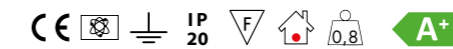

Django Haloled Double

LUXEON M - (2x) 5,53W - 230V 50-60Hz AC

2x 566 lumen 2700K CRI90
2x 608 lumen 3000K CRI90
dimmability: mains dim LC
beam 36°

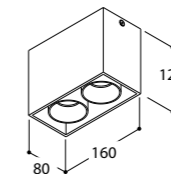

housing	focus	2700K	3000K	€
○	○	371951	371953	237,-
●	●	371952	371954	237,-
○	●	371955	371956	237,-

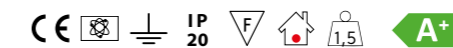

Django GU10 Fixed

LED PAR16 - MAX 10W - 230V 50-60Hz AC
GU10
dimmability: dependent on bulb

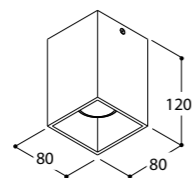

finish		€
○	371905	63,-
●	371906	63,-
◐	371907	74,-



Django 2 GU10 Fixed

LED PAR16 - (2x) MAX 10W - 230V 50-60Hz AC
GU10
dimmability: dependent on bulb

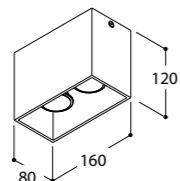

finish		€
○	371925	89,-
●	371926	89,-
◐	371927	104,-



Django GU10 Orientable

LED PAR16 - MAX 10W - 230V 50-60Hz AC
GU10
dimmability: dependent on bulb

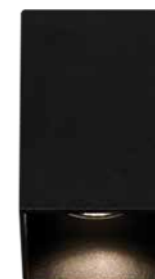
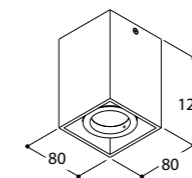

finish		€
○	371901	80,-
●	371902	80,-
◐	371903	111,-

↻ 359° ↻ 20°



Django 2 GU10 Orientable

LED PAR16 - (2x) MAX 10W - 230V 50-60Hz AC
GU10
dimmability: dependent on bulb

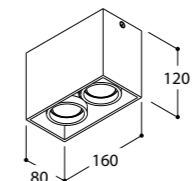

finish		€
○	371921	157,-
●	371922	157,-
◐	371923	191,-

↻ 359° ↻ 20°





Danilith Wortegem-Petegem



Odil

CREE XPG - 7,91W - 230V 50-60Hz AC
 832 lumen 2700K CRI92
 832 lumen 3000K CRI92
 dimmability: mains dim LC

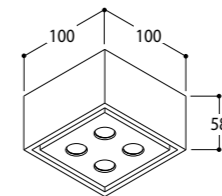

finish	2700K			3000K			€
	10°	25°	46°	10°	25°	46°	
○	390647	390747	390847	390657	390757	390857	216,-
●	390626	390726	390826	390636	390736	390836	216,-

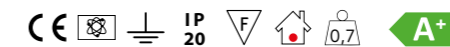



Sands Oslo



surface mounted

Pandora

CREE XPG - 7,91W - 230V 50-60Hz AC
 832 lumen 2700K CRI92
 832 lumen 3000K CRI92
 dimmability: mains dim LC

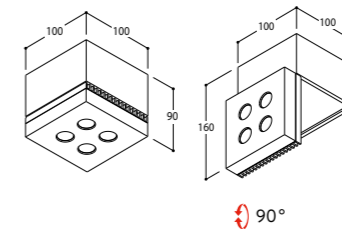

finish	2700K			3000K			€
	10°	25°	46°	10°	25°	46°	
○	391237	391337	391437	391247	391347	391447	344,-
●	391216	391316	391416	391226	391326	391426	344,-

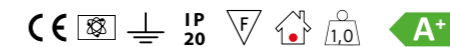

Pandora

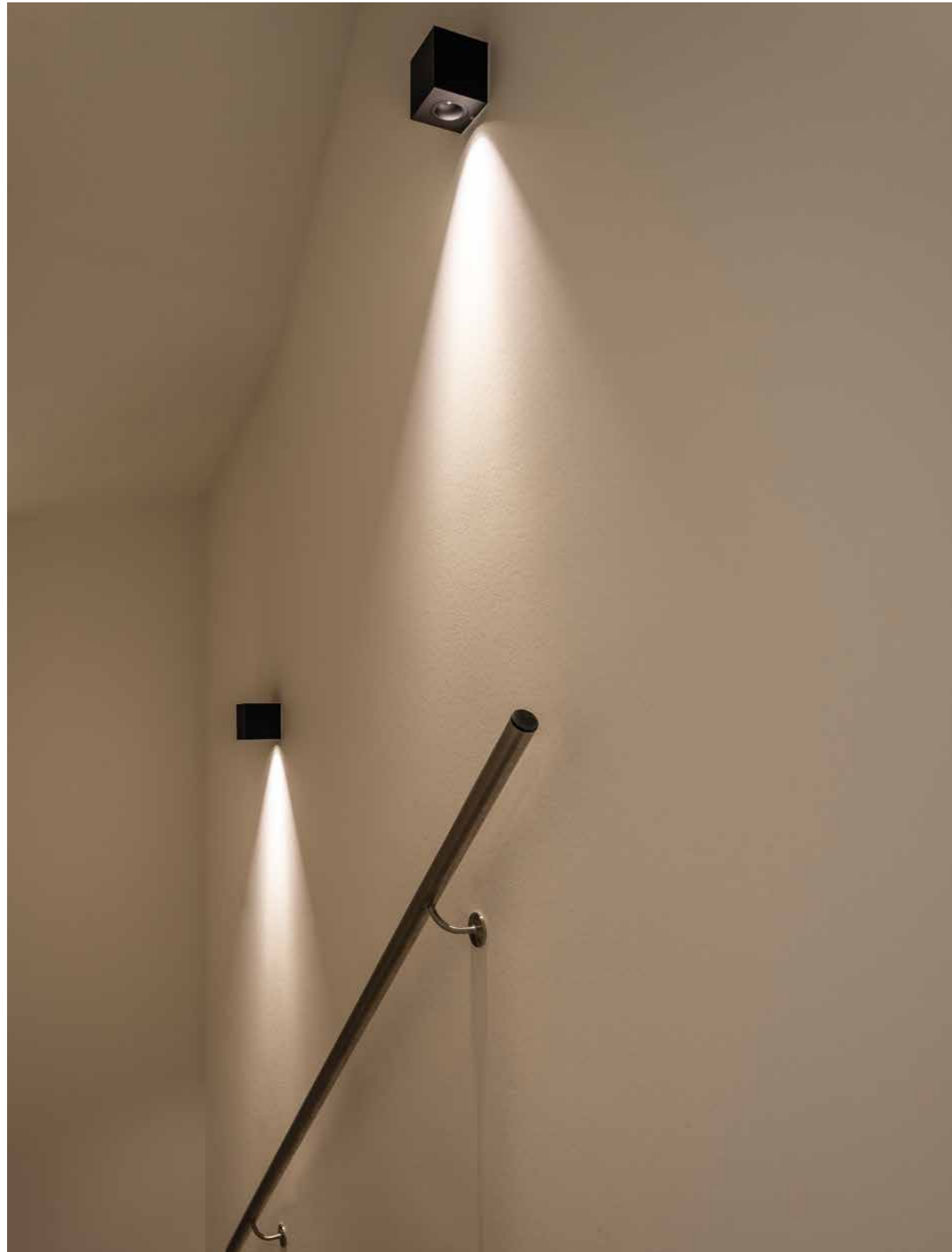

GLK Kruisem

Brix SML Single Beam

LUXEON M - 3,82W - 230V 50-60Hz AC

400 lumen 2700K CRI90
429 lumen 3000K CRI90
dimmability: mains dim LC
beam 36°

⬇ up or ⬆ down

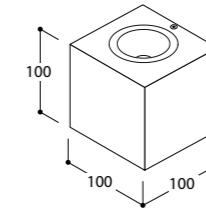

finish	2700K	3000K	€
○	458547	458557	183,-
●	458526	458536	183,-
●	458512	458522	193,-

Family members:



Brix SML Up/down

LUXEON M - (2x) 3,82W - 230V 50-60Hz AC

2x 400 lumen 2700K CRI90
2x 429 lumen 3000K CRI90
dimmability: mains dim LC
beam 36°

⬆ up/down

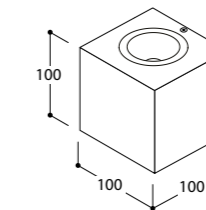

finish	2700K	3000K	€
○	458647	458657	239,-
●	458626	458636	239,-
●	458612	458622	249,-

Family members:





Private house Bergen aan Zee

Dartling Single Beam

LUXEON M - 3,82W - 230V 50-60Hz AC
 400 lumen 2700K CRI90
 429 lumen 3000K CRI90
 dimmability: mains dim LC
 beam 110°
 up or down

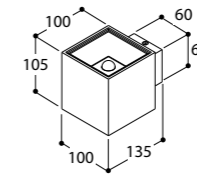

housing	reflector	2700K	3000K	€
○	○	359918	359928	185,-
○	●	359992	359982	189,-
●	●	359900	359920	185,-
●	●	359950	359970	185,-
●	●	359926	359946	189,-
●	●	359956	359976	214,-



Dartling Up/down

LUXEON M - (2x) 3,82W - 230V 50-60Hz AC
 2x 400 lumen 2700K CRI90
 2x 429 lumen 3000K CRI90
 dimmability: mains dim LC
 beam 110°
 up/down

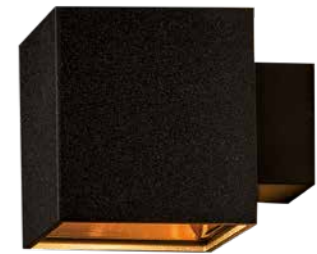
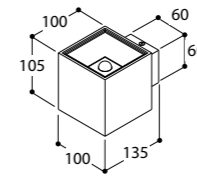

housing	reflector	2700K	3000K	€
○	○	359818	359828	255,-
○	●	359892	359882	263,-
●	●	359800	359820	255,-
●	●	359850	359870	255,-
●	●	359826	359846	263,-
●	●	359857	359877	388,-
●	●	359856	359876	276,-



surface mounted

Dartling

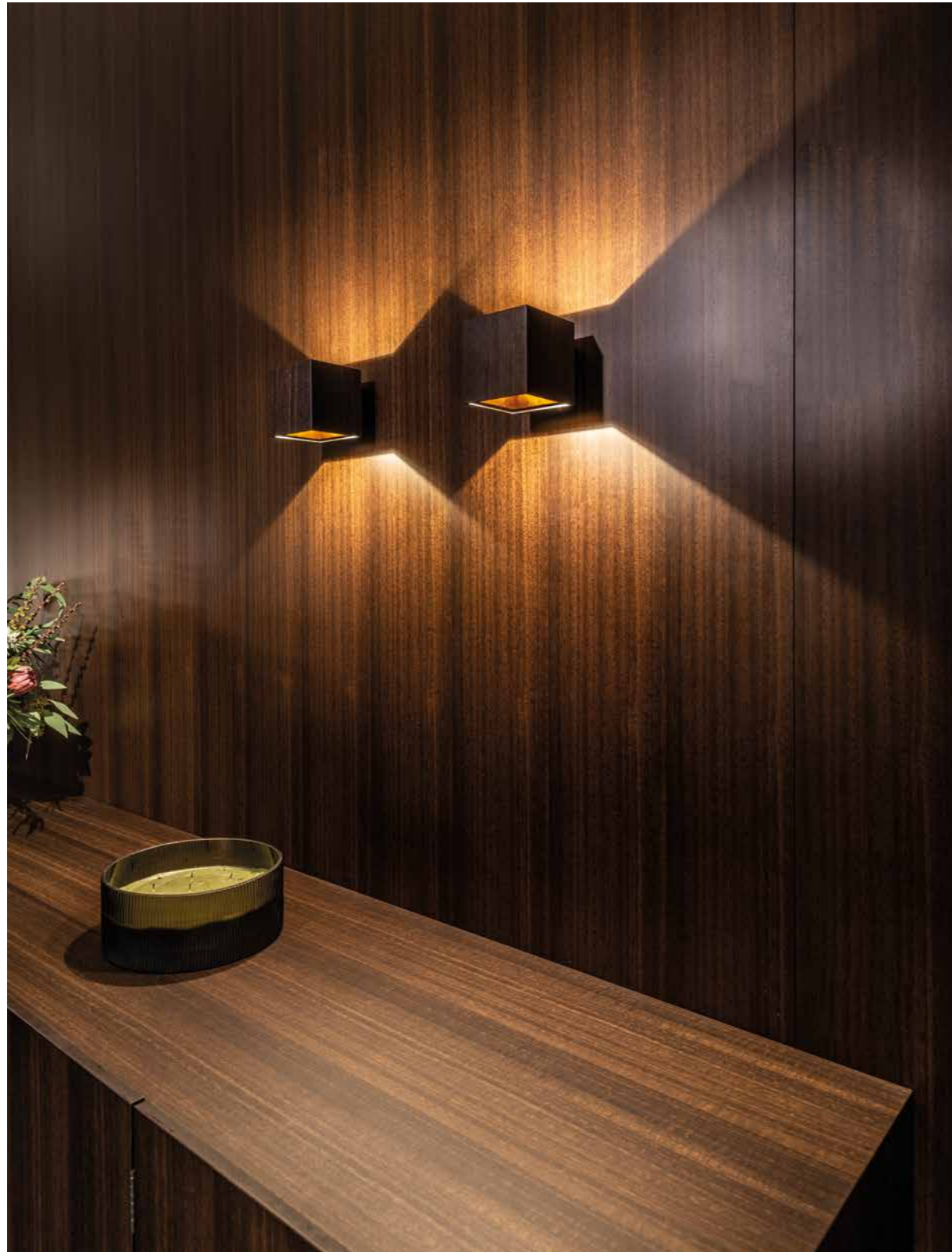

Fraeye Interieur

Dartling Oak Single Beam

LUXEON M - 3,82W - 230V 50-60Hz AC
 400 lumen 2700K CRI90
 429 lumen 3000K CRI90
 dimmability: mains dim LC
 beam 110°
 up or down

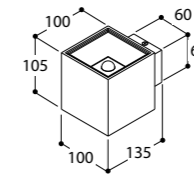

oak housing	reflector	2700K	3000K	€
●	○	351047	351057	294,-
●	●	351050	351060	313,-
●	●	351086	351096	306,-
●	●	351056	351066	325,-



surface mounted

Dartling Oak Up/down

LUXEON M - (2x) 3,82W - 230V 50-60Hz AC
 2x 400 lumen 2700K CRI90
 2x 429 lumen 3000K CRI90
 dimmability: mains dim LC
 beam 110°
 up/down

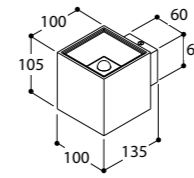

oak housing	reflector	2700K	3000K	€
●	○	351147	351157	307,-
●	●	351150	351160	332,-
●	●	351186	351196	327,-
●	●	351156	351166	351,-



Dartling



Private apartment Knokke

Boa Single Beam

CITIZEN LED - 6,44W - 230V 50-60Hz AC
 500 lumen 2700K CRI90
 610 lumen 3000K CRI85
 dimmability: mains dim LC
 ▼ up or ▲ down

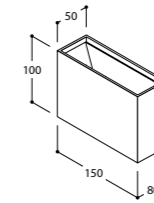

housing	focus	2700K	3000K	€
○	○	405947	405937	185,-
●	●	405926	405916	189,-
○	●	405992	405982	189,-
●	○	405995	405985	185,-

Family members:

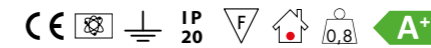

Boa Up/down

CITIZEN LED - (2x) 6,44W - 230V 50-60Hz AC
 2x 500 lumen 2700K CRI90
 2x 610 lumen 3000K CRI85
 dimmability: mains dim LC
 ▼ up/down

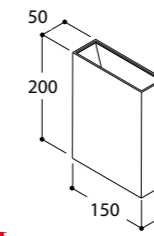

housing	focus	2700K	3000K	€
○	○	405447	405437	316,-
●	●	405426	405416	324,-
○	●	405492	405482	324,-
●	○	405495	405485	316,-

Family members:

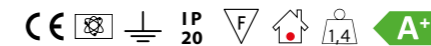



Steenhuysen Signature Spaces

surface mounted



Boa

CITIZEN LED - 6,44W - 230V 50-60Hz AC

500 lumen 2700K CRI90
610 lumen 3000K CRI85
dimmability: mains dim LC

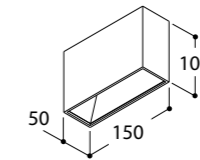

housing	focus	2700K	3000K	€
○	○	406247	406237	182,-
●	○	406295	406285	182,-
○	●	406292	406282	186,-
●	●	406226	406216	186,-

Family members:

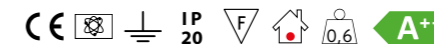

Boa



Private apartment Knokke



surface mounted

Micro Tommy

LUXEON M - (3x) 3,82W - 230V 50-60Hz AC
 3x 400 lumen 2700K CRI90
 3x 429 lumen 3000K CRI90
 dimmability: mains dim RC
 beam 36°

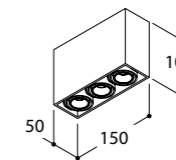

↻ 15° ↺ 20°

housing	focus	2700K	3000K	€
●	●	418726	418716	357,-
○	○	418747	418737	357,-
○	●	418794	418784	357,-
●	○	418795	418785	357,-
●	●	418796	418786	369,-
○	●	418792	418782	369,-
○	● rings	418797	418787	357,-

Family members:

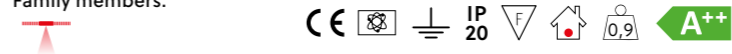

Micro Tommy

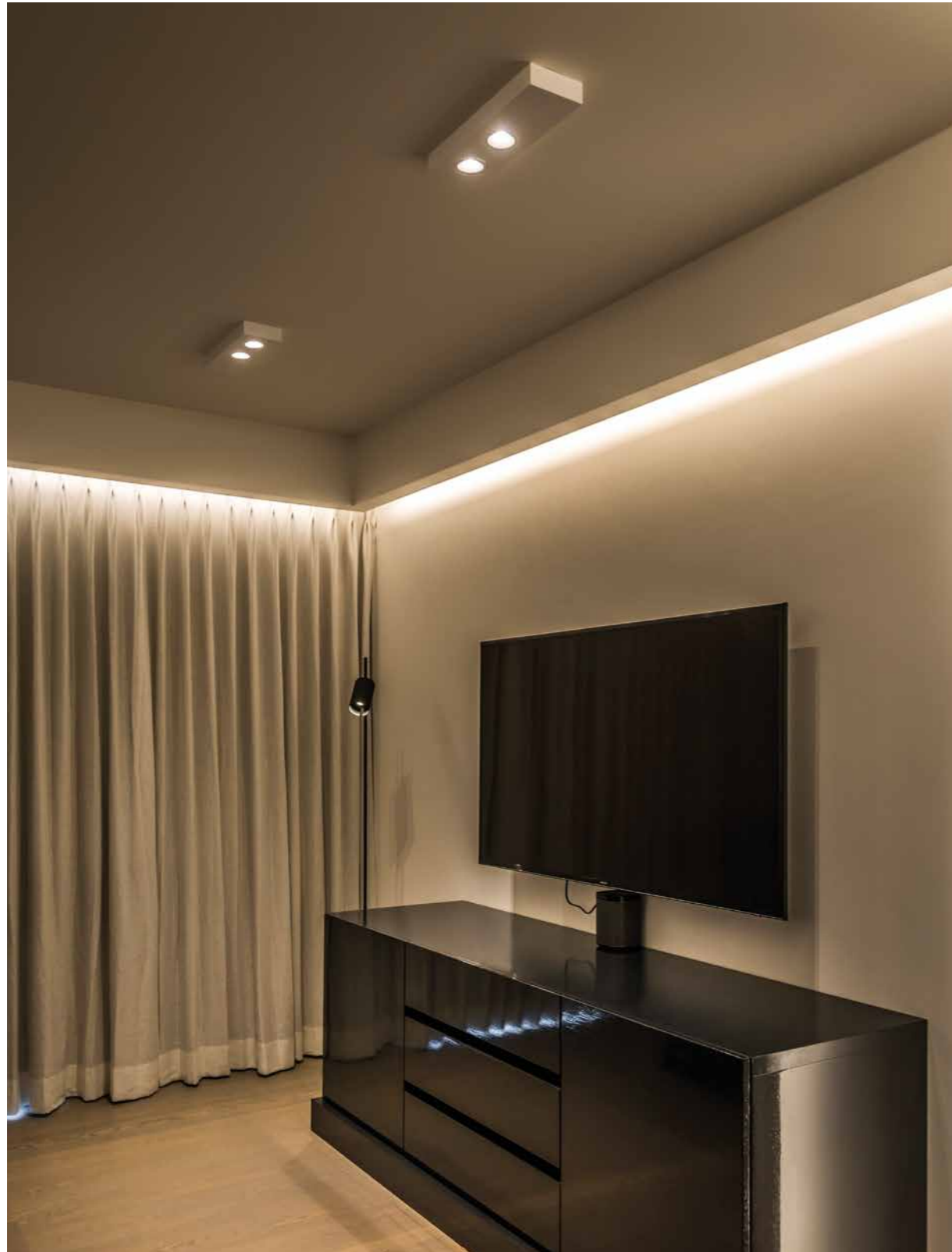

Private house Brussels



Domino Sferos Beaufort

CITIZEN LED - (2x) 6,22W - 230V 50-60Hz AC
 2 x 758 lumen 2700K CRI92
 2 x 793 lumen 3000K CRI92
 dimmability: mains dim LC
 beam 36°

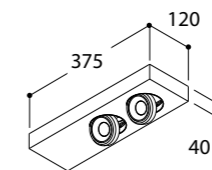

↻ 359° ↻ 60°

finish	2700K	3000K	€
○	468547	468557	438,-
●	468526	468536	438,-



M10 Base Pro 1 (300)

230V 50-60Hz AC

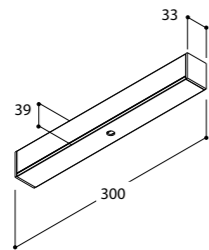

finish	230V*	€	CI 350mA mains dimm LC	CI 250mA mains dimm LC	€
●	375827	74,-	378827	379827	105,-
○	375848	74,-	378848	379848	105,-

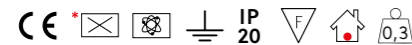

M10 Base Pro 2 (600)

230V 50-60Hz AC

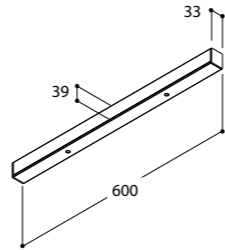

finish	230V*	€	CI 350mA mains dimm LC	CI 250mA mains dimm LC	€
●	375527	89,-	378527	379527	142,-
○	375548	89,-	378548	379548	142,-



M10 Base Pro 3 (900)

230V 50-60Hz AC

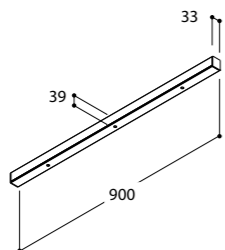

finish	230V*	€	CI 350mA mains dimm LC	CI 250mA mains dimm LC	€
●	375627	110,-	378627	379627	204,-
○	375648	110,-	378648	379648	204,-



M10 Base Pro 4 (1200)

230V 50-60Hz AC

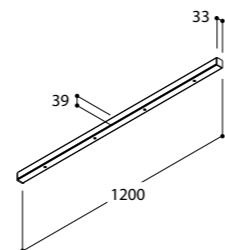

finish	230V*	€	CI 350mA mains dimm LC	CI 250mA mains dimm LC	€
●	375727	136,-	378727	379727	243,-
○	375748	136,-	378748	379748	243,-

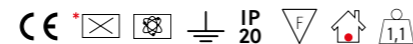

For custom made lengths please use Protut profile with M10 modules P.437



RR Interior Luxembourg

surface mounted

Matchable products



Berrier Junior M10



Cone Junior M10



Funnel Elbow M10



Nobel Elbow M10

M10 Base

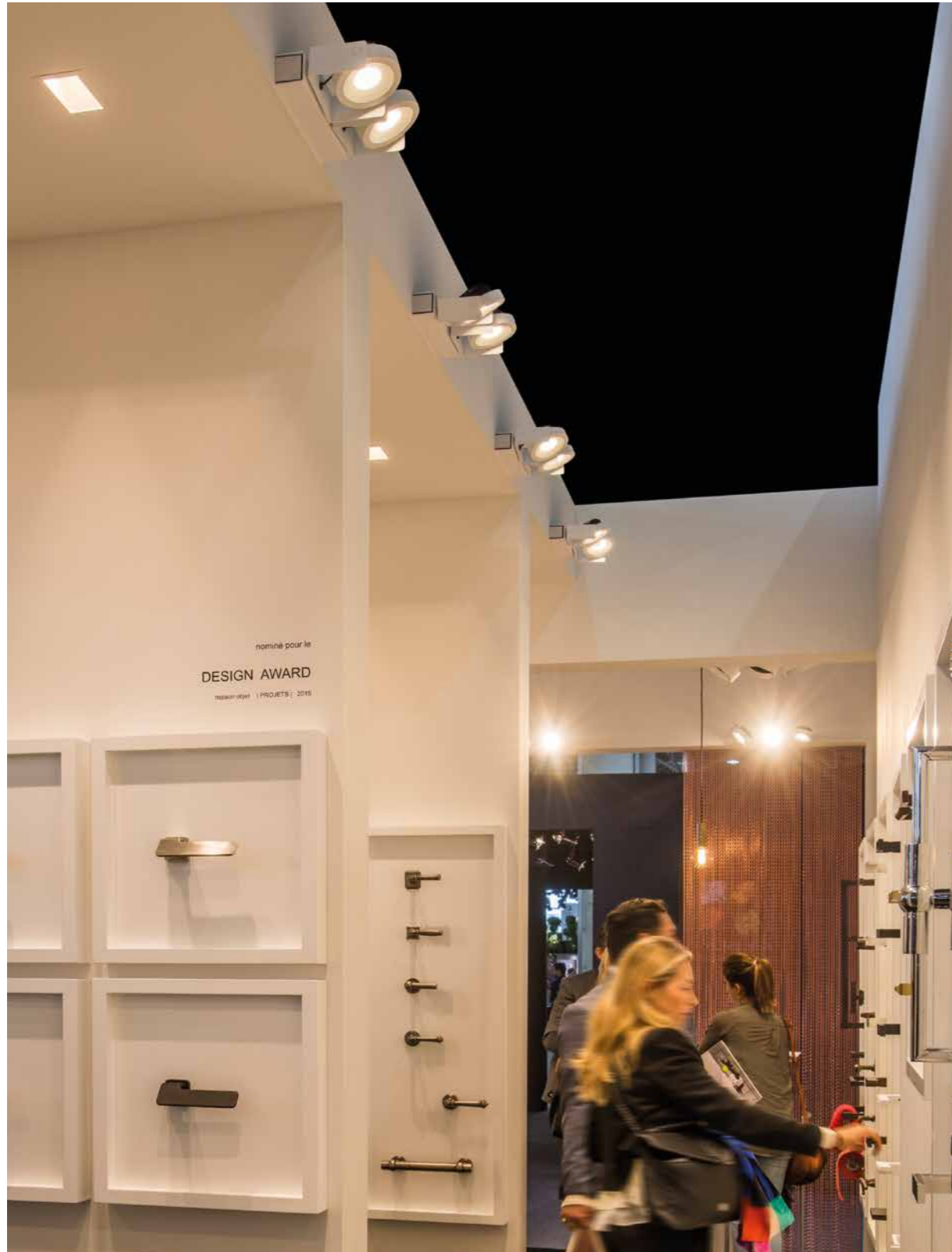

Quincalux Maison et Objet

Wodan 1 Beaufort²

CITIZEN - 12,3W - 230V 50-60Hz AC
 1506 lumen 2700K CRI90
 1556 lumen 3000K CRI90
 dimmability: mains dim RC

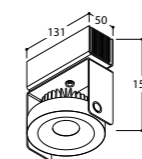

↻ 155° ↻ 90°

housing	module	2700K		3000K		€
		35°	70°	35°	70°	
●	●	420685	420666	420676	420656	311,-
○	○	420687	420667	420677	420657	311,-
○	●	420682	420664	420674	420654	311,-

Family members:

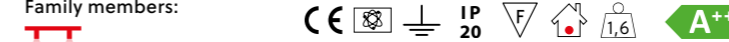

surface mounted

Wodan

suspended

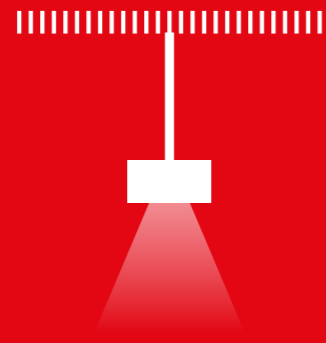

Nobel	207	Paris	245
NEW Berrier Junior	211	Hubble	246
NEW Cone Junior	215	Telescoop	247
NEW Kalebas	217	Nelson	249
Nuts	223	Rollo	251
Berrier	225	Queen Elizabeth	253
Cone	227	King George	255
Funnel	228	Ringo	256
Dimitri & Kazan	233	Diabolo XL	259
Luzien	235	M10 bases	260
Fabian	240	Kosmos Base M10	265
Olijf	243		



Private house Brussels

Nobel Oak Pi

LUXEON M - 3,82W - 230V 50-60Hz AC
 400 lumen 2700K CRI90
 429 lumen 3000K CRI90
 dimmability: mains dim LC
 beam 36°

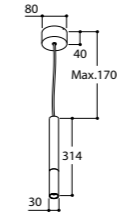

upper part	lower part	focus	mains-cord	2700K	3000K	€
				488247	488237	230,-
				488226	488217	230,-
				488250	488240	251,-

Family members:

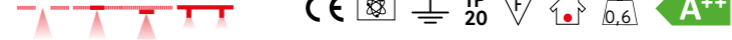

Nobel Oak Pi M10

LUXEON M - 3,82W - 350mA DC (VF 10,95)
 400 lumen 2700K CRI90
 429 lumen 3000K CRI90
 dimmability: PWM/CCR
 beam 36°

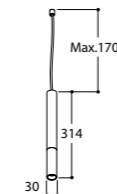

upper part	lower part	focus	mains-cord	2700K	3000K	€
				488547	488537	167,-
				488526	488516	167,-
				488550	488540	193,-

i M10 Base, see end of this chapter

Family members:



4000K ON DEMAND

i Converter matrix, see back flap



suspended

Nobel Oak Pi

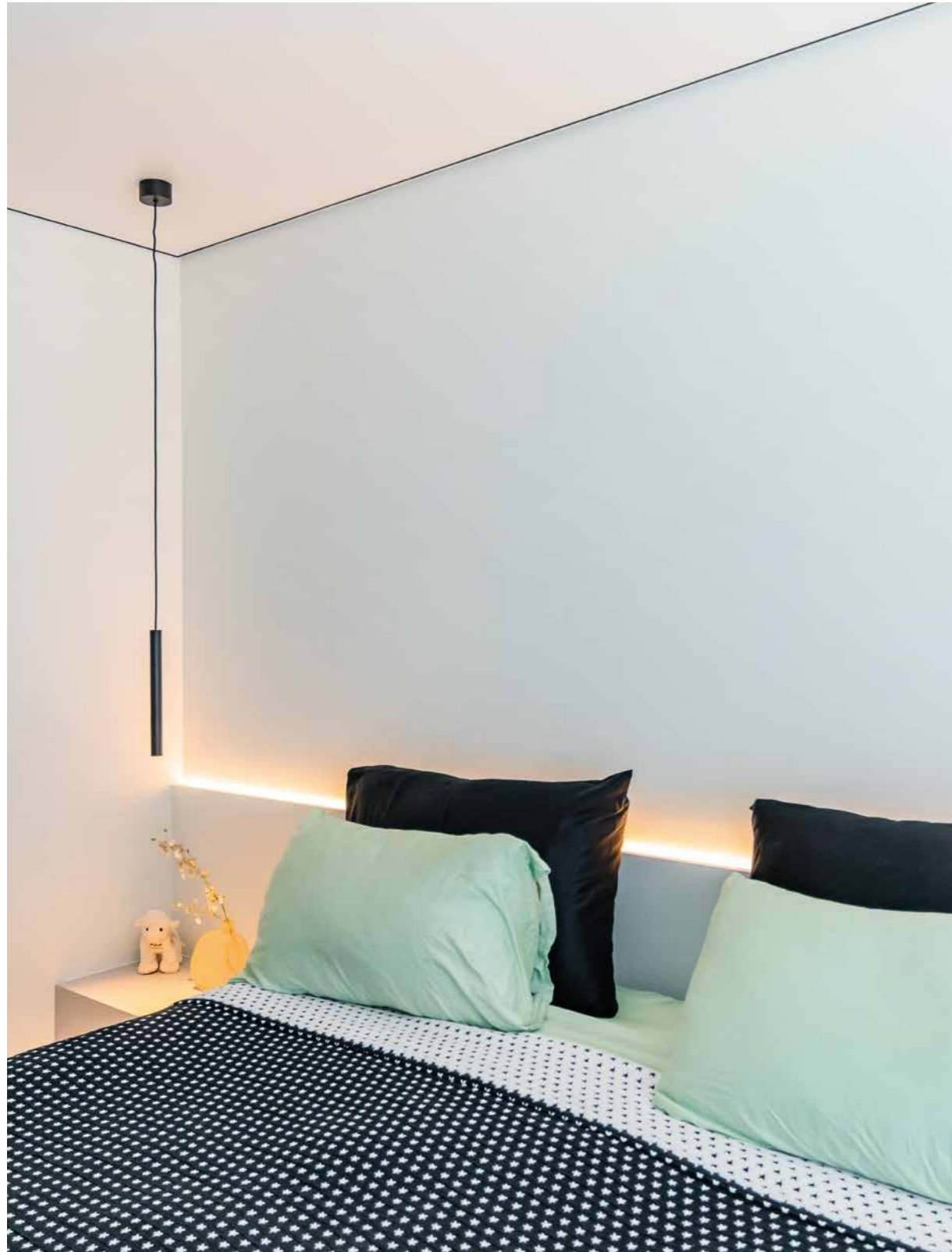

Penthouse Ostend

Nobel Pi

LUXEON M - 3,82W - 230V 50-60Hz AC
 400 lumen 2700K CRI90
 429 lumen 3000K CRI90
 dimmability: mains dim LC
 beam 36°

HALOSPHERE - 4,25W - 230V 50-60Hz AC
 455 lumen 1800K ▶ 3000K CRI90
 dimmability: mains dim LC
 beam 40°

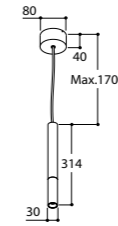

upper part	lower part	focus	mains-cord	2700K	3000K	€	1800K-3000K	€
●	●	●	●	418496	418486	165,-	418106	177,-
●	●	●	●	418420	418410	247,-	418030	259,-
●	●	●	●	418456	418446	259,-	418066	271,-
●	●	●	●	418402	418412	161,-	418032	173,-
●	●	●	●	418419	418409	199,-	418029	211,-
●	●	●	●	418457	418447	199,-	418067	211,-
○	○	○	○	418418	418408	161,-	418028	173,-
○	○	●	○	418494	418484	161,-	418104	173,-

Family members:

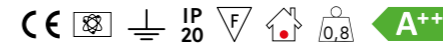

Nobel Pi M10

LUXEON M - 3,82W - 350mA DC - (10,95 Vf)
 400 lumen 2700K CRI90
 429 lumen 3000K CRI90
 dimmability: PWM/CCR
 beam 36°

HALOSPHERE - 4,25W - 250mA DC - (17 Vf)
 455 lumen 1800K ▶ 3000K CRI90
 dimmability: CCR
 beam 40°

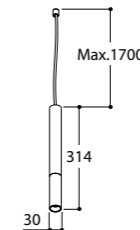

upper part	lower part	focus	mains-cord	2700K	3000K	€	1800K-3000K	€
●	●	●	●	418296	418286	127,-	418206	139,-
●	●	●	●	418220	418210	209,-	418230	221,-
●	●	●	●	418256	418246	221,-	418266	233,-
●	●	●	●	418202	418212	123,-	418132	135,-
●	●	●	●	418219	418209	162,-	418229	174,-
●	●	●	●	418257	418247	162,-	418267	174,-
○	○	○	○	418218	418208	123,-	418128	135,-
○	○	●	○	418294	418284	123,-	418204	135,-

! M10 Base, see end of this chapter

Family members:



! Converter matrix, see back flap



suspended

Nobel Pi



Kreatos Knokke

Berrier Junior Thin Wire CI

LUXEON M - 3,82W - 230V 50-60Hz AC
 400 lumen 2700K CRI90
 429 lumen 3000K CRI90
 dimmability: LC
 beam 60°

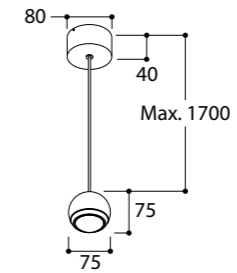

HALOSPHERE - 4,25W - 230V 50-60HZ AC
 455 lumen 1800K ▶ 3000K CRI90
 dimmability: LC
 beam 60°

housing	front	mains-cord	2700K	3000K	€	1800K-3000K	€
●	●	●	456002	456012	191,-	456092	203,-
○	○	○	456034	456024	191,-	456004	203,-
●	●	●	456044	456054	191,-	456014	203,-
●	●	●	456045	456055	191,-	456015	203,-
○	●	○	456052	456062	191,-	456022	203,-
●	●	●	456096	456086	195,-	456066	207,-

Family members:



Berrier Junior Thin Wire M10

LUXEON M - 3,82W - 350mA DC - (10,95 Vf)
 400 lumen 2700K CRI90
 429 lumen 3000K CRI90
 dimmability: PWM/CCR
 beam 60°

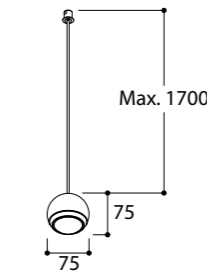

HALOSPHERE - 4,25W - 250mA DC - (17 Vf)
 455 lumen 1800K ▶ 3000K CRI90
 dimmability: CCR
 beam 60°

housing	front	mains-cord	2700K	3000K	€	1800K-3000K	€
●	●	●	456102	456112	152,-	456192	165,-
○	○	○	456134	456124	152,-	456104	165,-
●	●	●	456144	456154	152,-	456114	165,-
●	●	●	456145	456155	152,-	456115	165,-
○	●	○	456152	456162	152,-	456122	165,-
●	●	●	456196	456186	156,-	456166	169,-

ⓘ M10 Base, see end of this chapter

Family members:

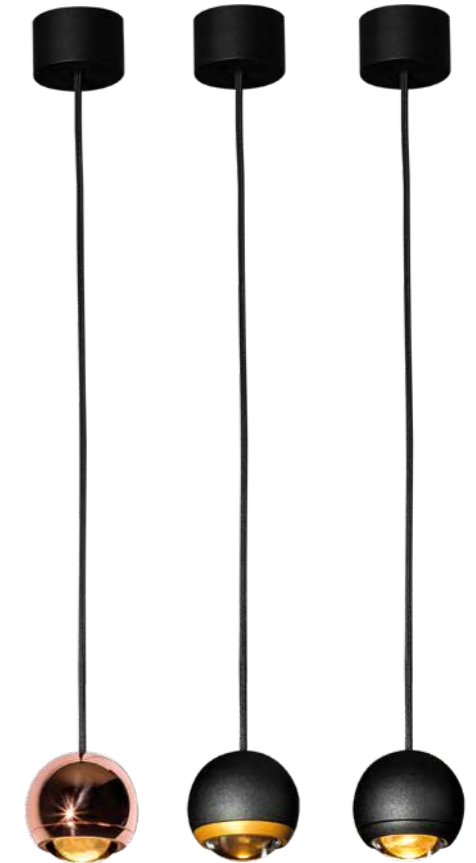

suspended

Berrier Junior



Inofec Café Tielt

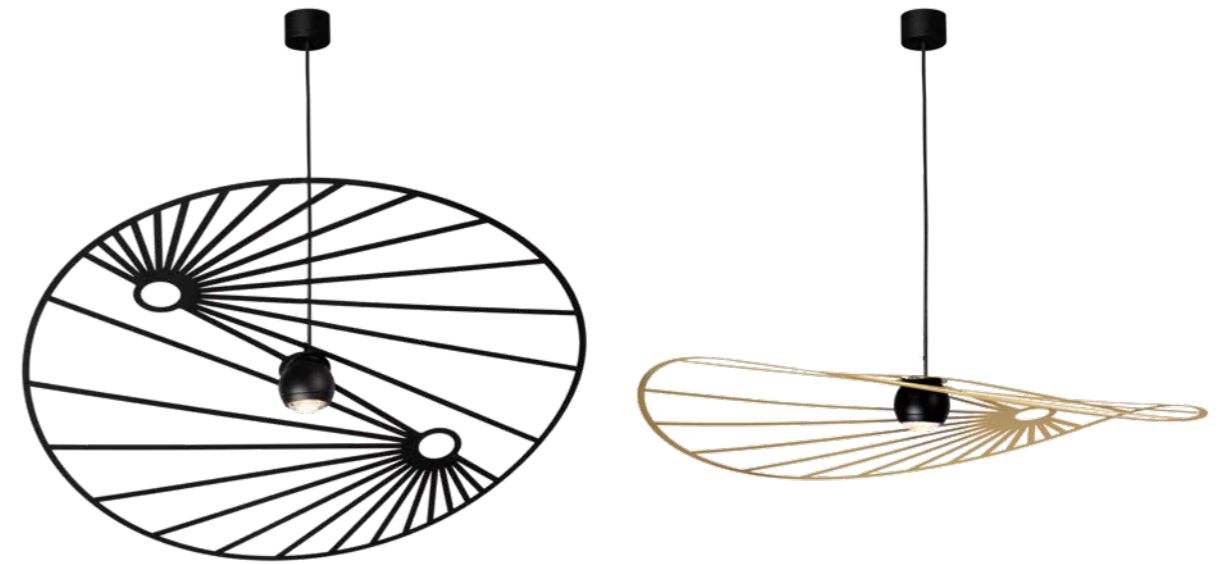

Ray

Accessory to pimp your Berrier Junior (or Cone Junior)

i Not compatible with 48V track luminaires

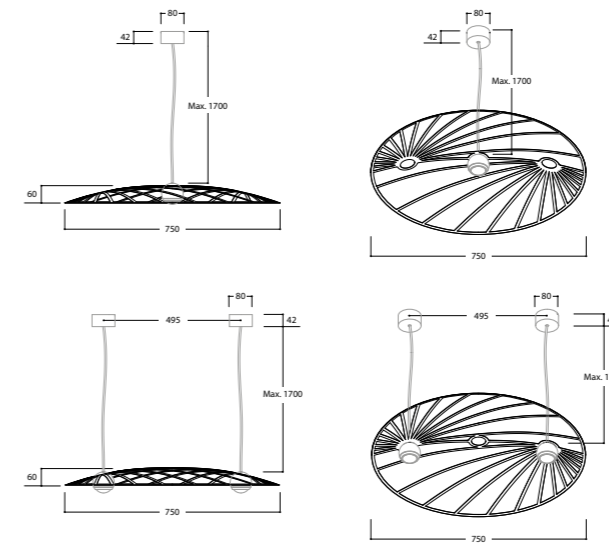

finish	ACCESSORY	€
○	487947	157,-
●	487926	157,-
●	487903	157,-



suspended

Designed by Cas Moor & Lieven Musschoot

Berrier Junior Ray



Private house Paris

Cone Junior CI

LUXEON M - 3,82W - 230V 50-60Hz AC
 400 lumen 2700K CRI90
 429 lumen 3000K CRI90
 dimmability: mains dim LC
 beam 60°

HALOSPHERE - 4,25W - 230V 50-60Hz AC
 455 lumen 1800K ▶ 3000K CRI90
 dimmability: mains dim LC
 beam 60°

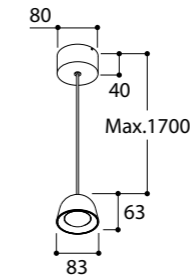

housing	focus	mains-cord	2700K	3000K	€	1800K-3000K	€
●	●	●	450102	450112	198,-	450192	210,-
○	○	○	450134	450124	198,-	450104	210,-
●	●	●	450145	450155	198,-	450115	210,-
●	●	●	450144	450154	198,-	450114	210,-
○	●	○	450152	450162	198,-	450122	210,-
●	●	●	450196	450186	202,-	450166	214,-

Family members:

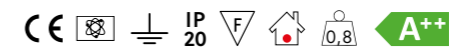
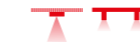

suspended

Cone Junior M10

LUXEON M - 3,82W - 350mA DC - (10,95 Vf)
 400 lumen 2700K CRI90
 429 lumen 3000K CRI90
 dimmability: PWM/CCR
 beam 60°

HALOSPHERE - 4,25W - 250mA DC - (17 Vf)
 455 lumen 1800K ▶ 3000K CRI90
 dimmability: CCR
 beam 60°

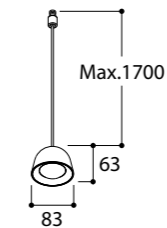

housing	focus	mains-cord	2700K	3000K	€	1800K-3000K	€
●	●	●	450202	450212	153,-	450292	166,-
○	○	○	450234	450224	153,-	450204	166,-
●	●	●	450245	450255	153,-	450215	166,-
●	●	●	450244	450254	153,-	450214	166,-
○	●	○	450252	450262	153,-	450222	166,-
●	●	●	450296	450286	157,-	450266	170,-

ⓘ M10 Base, see end of this chapter

Family members:

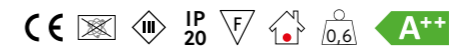
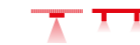

ⓘ Converter matrix, see back flap

Cone Junior

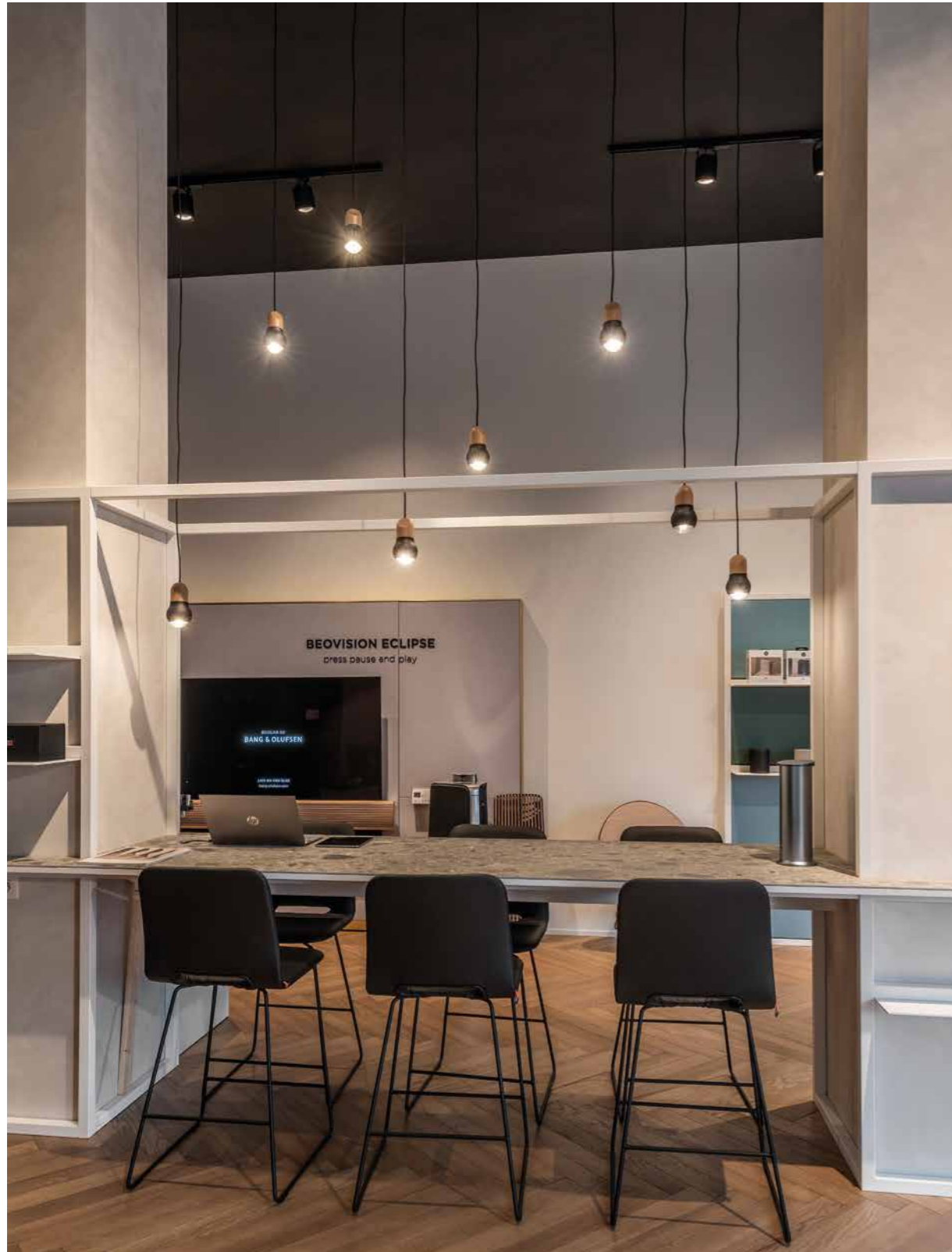

B&O store Kortrijk

Kalebas

A60 - MAX. 40W - 230V 50-60Hz AC
E27
dimmability: dependent on bulb

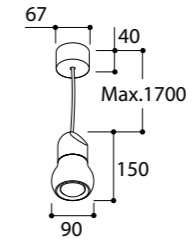

upper part oak	lower part	mains-cord		€
●	●	●	488015	236,-
●	●	●	488025	252,-
●	●	●	488026	204,-
●	●	●	488036	222,-
●	○	○	488047	204,-
●	●	●	488050	236,-
●	●	●	488060	252,-

+ Compatible with kalebas Glass

Family members:



Kalebas M10

A60 - MAX. 40W - 230V 50-60Hz AC
E27
dimmability: dependent on bulb

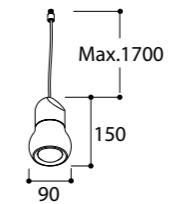

upper part oak	lower part	mains-cord		€
●	●	●	488115	216,-
●	●	●	488125	233,-
●	●	●	488126	184,-
●	●	●	488136	203,-
●	○	○	488147	184,-
●	●	●	488150	216,-
●	●	●	488160	233,-

! M10 Base, see end of this chapter

+ Compatible with kalebas Glass

Family members:



suspended

Kalebas Designed by Cas Moor & Lieven Musschoot



Memlinc Knokke

Kalebas LED

LUXEON M - 3,82W - 230V 50-60HZ AC
 400 lumen 2700K CRI90
 429 lumen 3000K CRI90
 dimmability: mains dim LC
 beam 60°

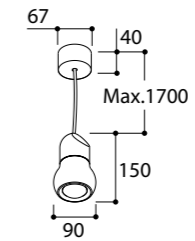

upper part oak	lower part	mains-cord	2700K	3000K	€
●	●	●	488815	488820	339,-
●	●	●	488826	488831	307,-
●	●	●	488836	488841	325,-
●	○	○	488847	488852	307,-
●	●	●	488850	488855	339,-

+ Compatible with Kalebas Glass

Family members:



Kalebas LED M10

LUXEON M - 3,82W - 230V 50-60HZ AC
 400 lumen 2700K CRI90
 429 lumen 3000K CRI90
 dimmability: mains dim LC
 beam 60°

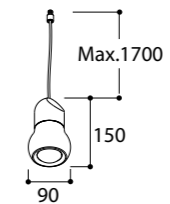

upper part oak	lower part	mains-cord	2700K	3000K	€
●	●	●	488915	488920	319,-
●	●	●	488926	488931	287,-
●	●	●	488936	488941	306,-
●	○	○	488947	488952	287,-
●	●	●	488950	488955	319,-

+ Compatible with Kalebas Glass

! M10 Base, see end of this chapter

Family members:



4000K ON DEMAND

Converter matrix, see back flap



suspended

Kalebas
 Designed by Cas Moor & Lieven Musschoot

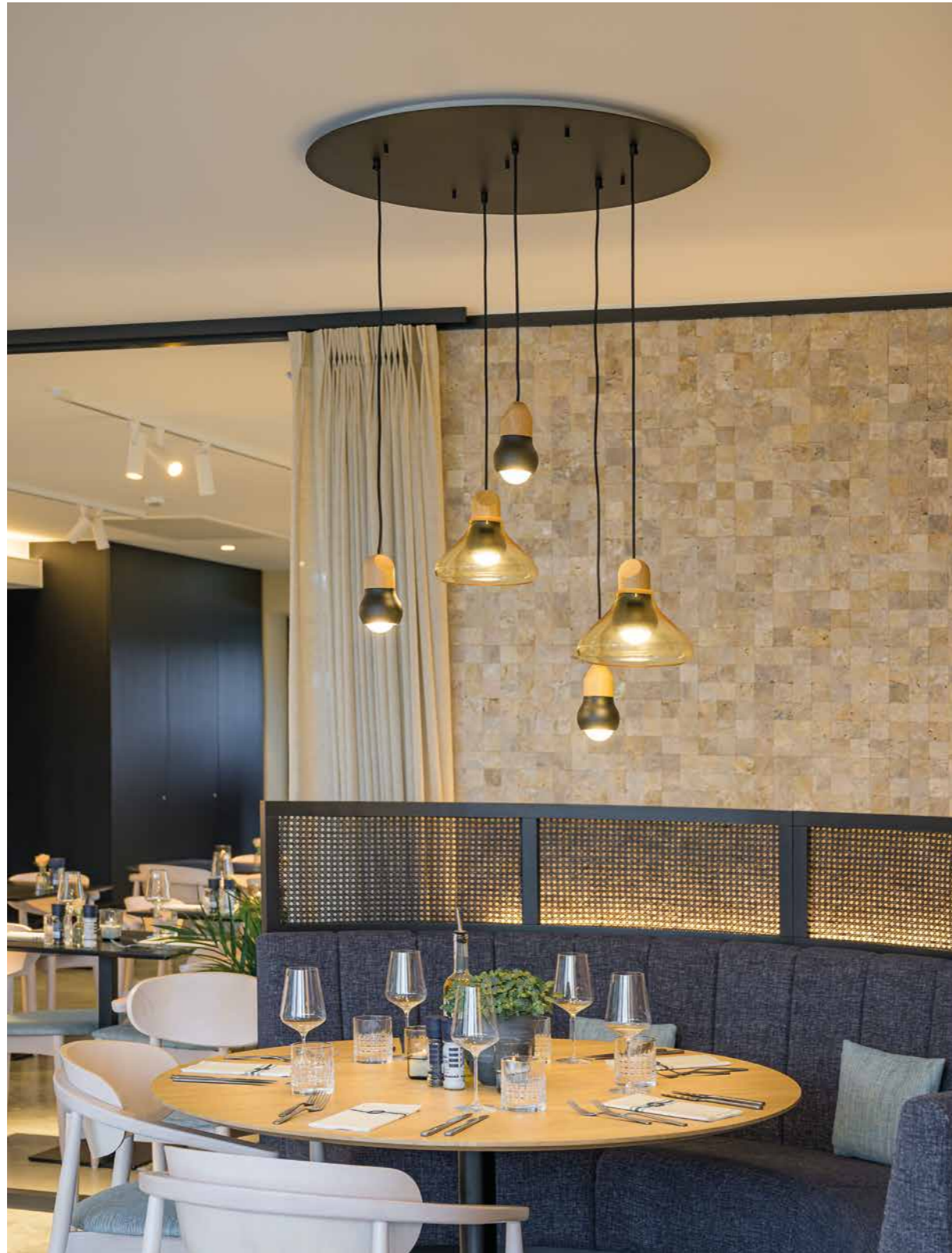

Zilt & Zout Cadzand



Kalebas Glass

Accessory to pimp your Kalebas

finish	ACCESSORY	€
○	488293	142,-
●	488292	142,-
●	488290	142,-
●	488291	142,-

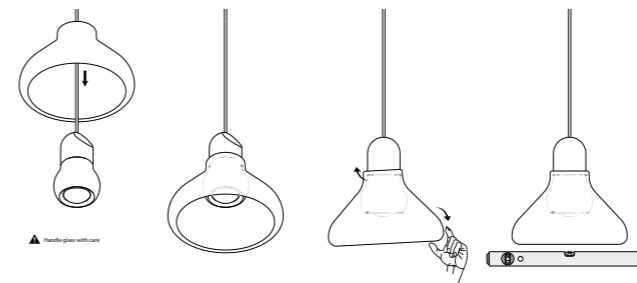
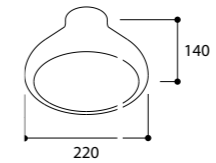

Glass production

Kalebas Glass

Designed by Cas Moor & Lieven Musschoot

suspended



Dentist Aalst

Nuts E27

A60 - MAX. 40W - 230V 50-60Hz AC

E27

dimmability: dependent on bulb
bulb not included

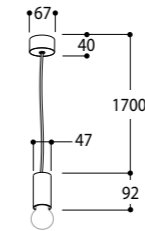

finish	mains-cord		€
○	○	425047	110,-
●	●	425026	110,-
◐	●	425021	130,-
●	●	425050	130,-



Nuts E27 M10

A60 - MAX. 40W - 230V 50-60Hz AC

E27

dimmability: dependent on bulb
bulb not included

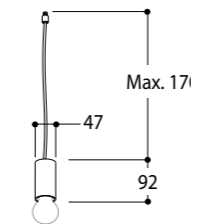

finish	mains-cord		€
○	○	425547	80,-
●	●	425526	80,-
◐	●	425521	100,-
●	●	425550	100,-

ⓘ M10 Base, see end of this chapter



suspended

Nuts

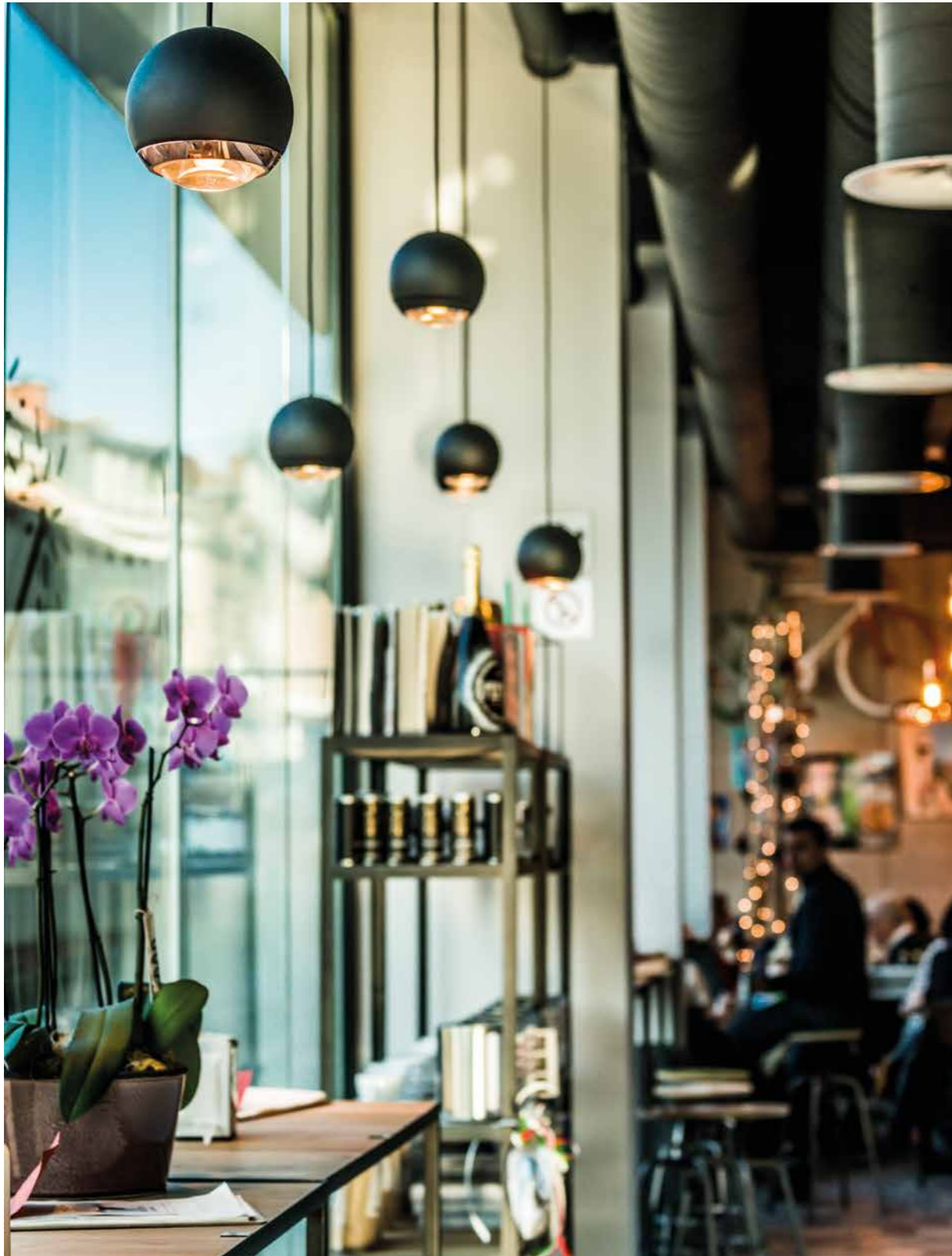

Peppe's Genk

Berrier

PREVALED - 12,7W - 230V 50-60Hz AC
 1365 lumen 2700K CRI90
 dimmability: LC
 beam 60°

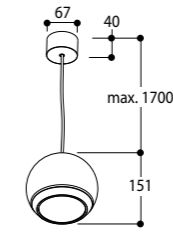

housing	front	mains-cord	2700K	€
			494050	404,-
			494056	333,-
			494057	378,-
			494001	296,-
			494019	325,-
			494016	296,-
			494020	325,-
			494096	313,-

Family members:



Berrier M10

PREVALED - 12,7W - 230V 50-60Hz AC
 1365 lumen 2700K CRI90
 dimmability: LC
 beam 60°

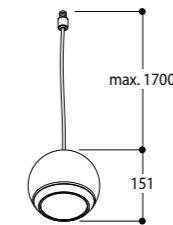

housing	front	mains-cord	2700K	€
			494150	375,-
			494156	302,-
			494157	344,-
			494101	282,-
			494119	294,-
			494116	282,-
			494120	294,-
			494196	299,-

M10 Base, see end of this chapter

Family members:



suspended

Berrier



TAL Headquarters

Cone CI

PREVALED - 9W - 230V 50-60Hz AC
 1017 lumen 2700K CRI90
 1066 lumen 3000K CRI90
 dimmability: mains dim RC
 beam 60°

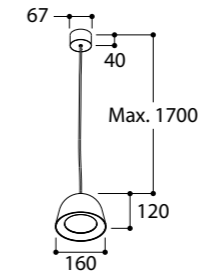

housing	focus	mains-cord	2700K	3000K	€
●	●	●	457202	457212	336,-
○	○	○	457234	457224	336,-
●	●	●	457244	457254	336,-
●	●	●	457245	457255	336,-
○	●	○	457252	457262	336,-
●	●	●	457296	457286	348,-

Family members:



Cone M10

PREVALED - 9W - 230V 50-60Hz AC
 1017 lumen 2700K CRI90
 1066 lumen 3000K CRI90
 dimmability: mains dim RC
 beam 60°

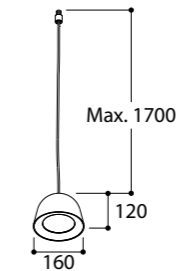

housing	focus	mains-cord	2700K	3000K	€
●	●	●	457302	457312	323,-
○	○	○	457334	457324	323,-
●	●	●	457344	457354	323,-
●	●	●	457345	457355	323,-
○	●	○	457352	457362	323,-
●	●	●	457396	457386	335,-

ⓘ M10 Base, see end of this chapter

Family members:

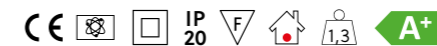

suspended

Cone



Private house Rekkem

Funnel 150 CI M10

LUXEON M - 7,84W - 230V 50-60Hz AC
 755 lumen 2700K CRI90
 810 lumen 3000K CRI90
 dimmability: mains dim RC
 beam 36°

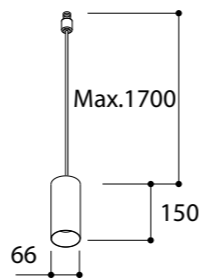

housing	focus	2700K	3000K	€
●	●	478736	478746	236,-
○	○	478757	478767	236,-
●	●	478796	478806	240,-
○	●	478792	478802	240,-

4000K ON DEMAND

Family members:

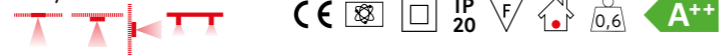

Funnel 150 M10 GU10

LED PAR16 - MAX 10W - 230V 50-60Hz AC
 GU10
 dimmability: dependent on bulb

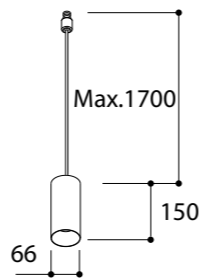

housing	focus	€
●	●	478336 174,-
○	○	478357 174,-
●	●	478406 178,-
○	●	478402 178,-

Family members:



Funnel 150 CI

LUXEON M - 7,84W - 230V 50-60Hz AC
 755 lumen 2700K CRI90
 810 lumen 3000K CRI90
 dimmability: mains dim RC
 beam 36°

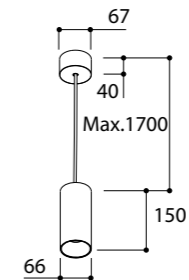

housing	focus	2700K	3000K	€
●	●	479726	479736	264,-
○	○	479747	479757	264,-
●	●	479786	479796	268,-
○	●	479782	479792	268,-

4000K ON DEMAND

Family members:

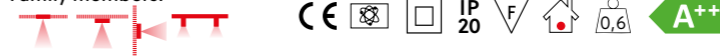

Funnel 150 GU10

LED PAR16 - MAX 10W - 230V 50-60Hz AC
 GU10
 dimmability: dependent on bulb

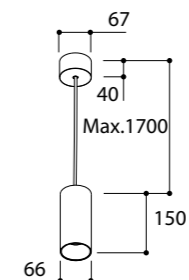

housing	focus	€
●	●	479326 200,-
○	○	479347 200,-
●	●	479396 204,-
○	●	479392 204,-

Family members:



suspended

Funnel 150

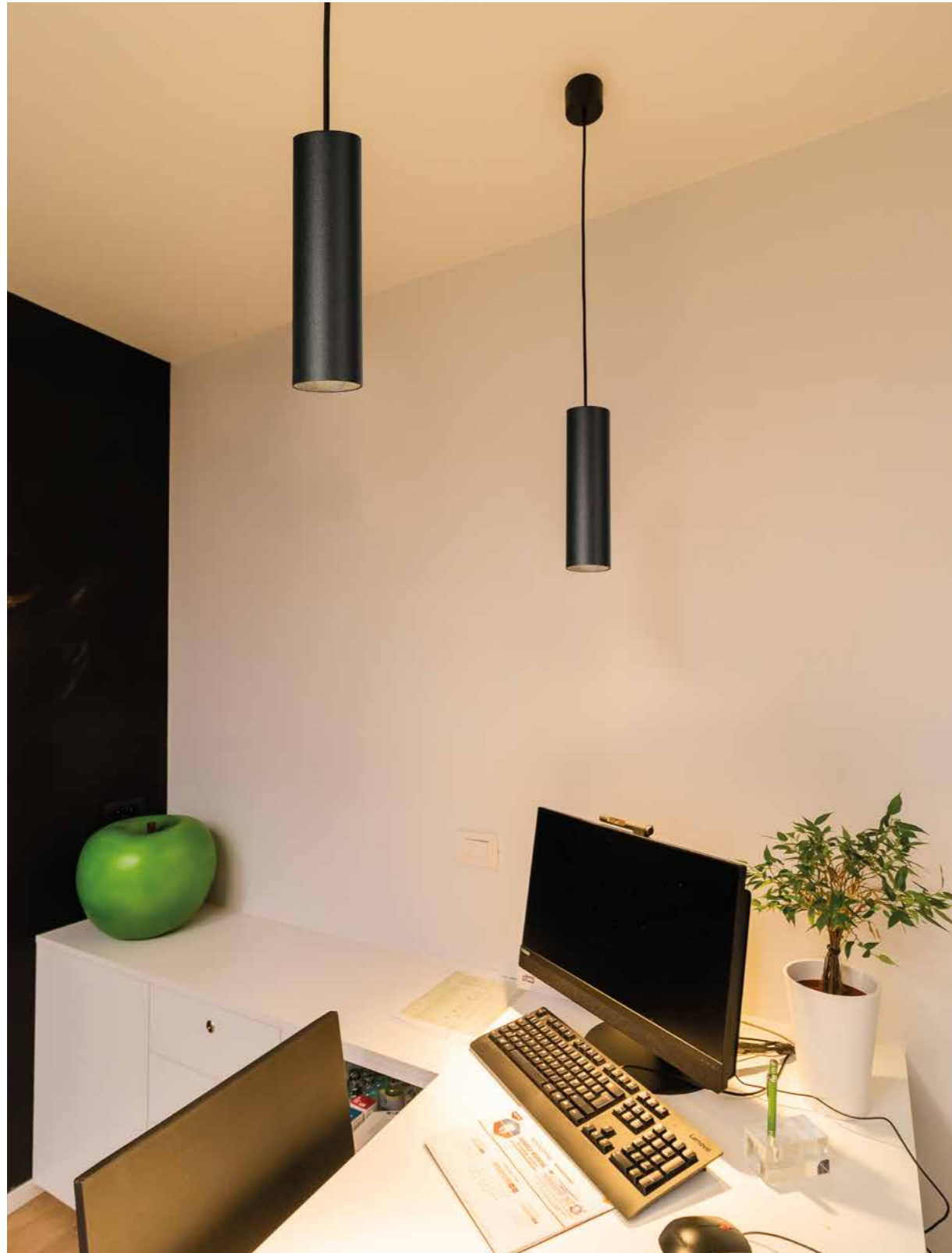

Dentist Brugge

Funnel 240 CI

LUXEON M - 7,84W - 230V 50-60Hz AC
 755 lumen 2700K CRI90
 810 lumen 3000K CRI90
 dimmability: mains dim RC
 beam 36°

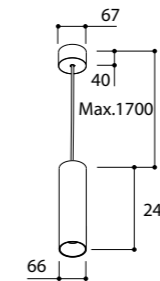

housing	focus	2700K	3000K	€
●	●	479826	479836	280,-
○	○	479847	479857	280,-
●	●	479886	479896	284,-
○	●	479882	479892	284,-

4000K ON DEMAND

Family members:

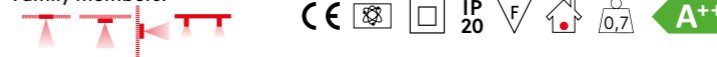

Funnel 240 GU10

LED PAR16 - MAX 10W - 230V 50-60Hz AC
 GU10
 dimmability: dependent on bulb

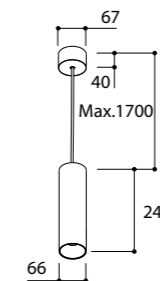

housing	focus	€
●	●	479316 216,-
○	○	479337 216,-
●	●	479386 220,-
○	●	479382 220,-

Family members:



suspended

Funnel 240



Gardeco Zedelgem

Dimitri

A60 - 40W - 230V 50-60Hz AC
 E27
 dimmability: dependent on bulb

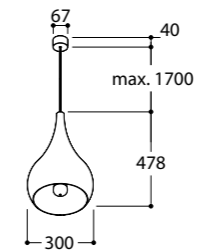

housing	focus	€
●	●	453596 540,-



Kazan

A60 - 40W - 230V 50-60Hz AC
 E27
 dimmability: dependent on bulb

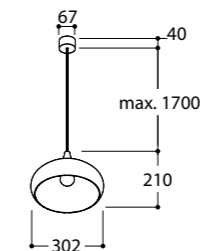

housing	focus	€
●	●	453696 378,-

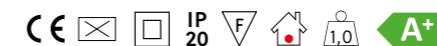

suspended

Dimitri & Kazan



Dieto Ooigem

Luzien LED

LED ARRAY - 20,1 W - 230V 50-60Hz AC
 2960 lumen 3000K CRI82
 dimmability: mains dim LC

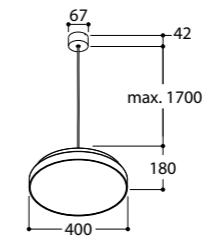

finish	3000K	€
○	453147	585,-
●	453126	585,-



Luzien LED

LED ARRAY - 20,1 W - 230V 50-60Hz AC
 2960 lumen 3000K CRI82
 dimmability: dali/touch dim

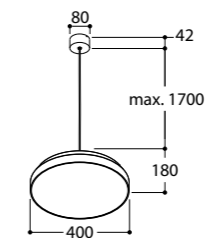

finish	3000K	€
○	453247	612,-
●	453226	612,-

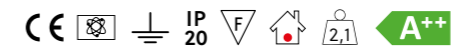

suspended



Luzien



Office Knokke

Luzien LED dB

LED ARRAY - 20,1 W - 230V 50-60Hz AC
 2960 lumen 3000K CRI82
 dimmability: dali / touch dim

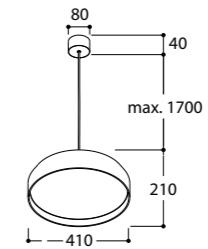

finish	cone	mains-cord	3000K	€
●	●	○	453270	775,-
●	●	●	453276	775,-



Luzien LED dB

LED ARRAY - 20,1 W - 230V 50-60Hz AC
 2960 lumen 3000K CRI82
 dimmability: mains dim LC

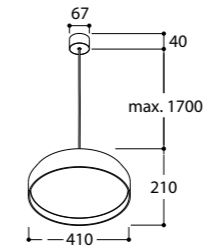

finish	cone	mains-cord	3000K	€
●	●	○	453170	746,-
●	●	●	453176	746,-

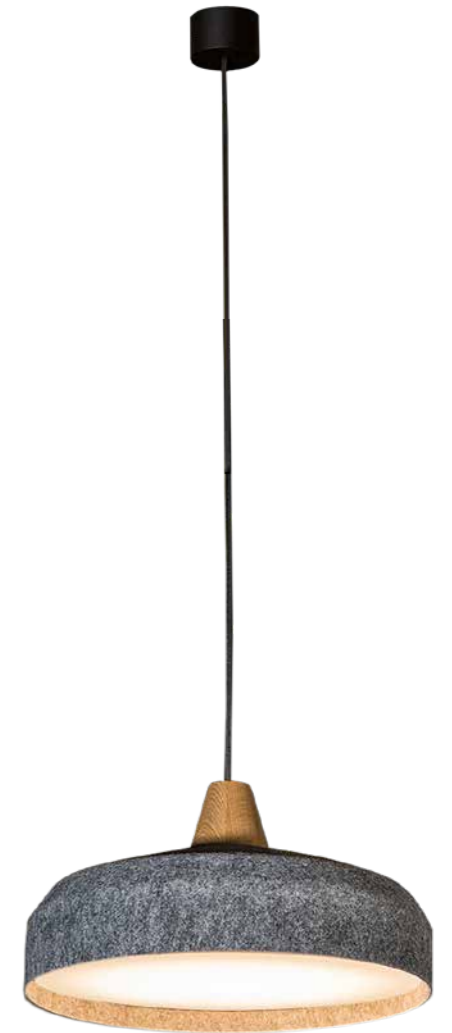
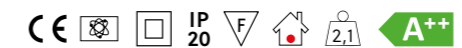

suspended

Luzien



De Casteur Ooigem

Luzien E27

A60 - MAX. 40W - 230V 50-60Hz AC
 E27
 dimmability: dependent on bulb

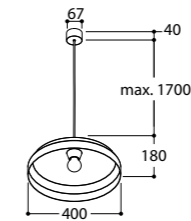

outside	inside		€
○	○	453047	239,-
●	●	453026	239,-
●	●	453096	322,-
○	●	453097	322,-



Luzien E27 dB

A60 - MAX. 40W - 230V - 50-60Hz AC
 E27
 dimmability: dependent on bulb

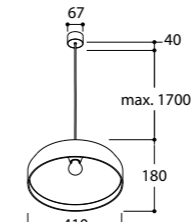

outside	cone	inside	mains-cord		€
●	●	○	○	453070	417,-
●	●	○	●	453076	417,-



suspended

Luzien

Fabian 300

LED ARRAY - 13,3 W - 230V 50-60Hz AC
2000 lumen 3000K CRI82
2200 lumen 4000K CRI82

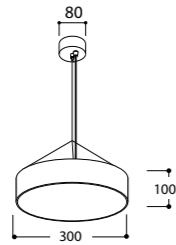

finish	3000K	4000K	€	3000K	4000K	€
	mains dim			dali touch		
○	620347	620367	457,-	620357	620377	496,-
●	620346	620366	457,-	620356	620376	496,-

Family members:



Fabian 400

LED ARRAY - 20,1 W - 230V 50-60Hz AC
2960 lumen 3000K CRI82
3270 lumen 4000K CRI82

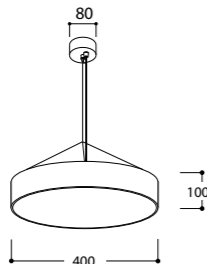

finish	3000K	4000K	€	3000K	4000K	€
	mains dim			dali touch		
○	621347	621367	539,-	621357	621377	568,-
●	621346	621366	539,-	621356	621376	568,-

Family members:



Fabian 500

LED ARRAY - 28W - 230V 50-60Hz AC
5200 lumen 3000K CRI80
5200 lumen 4000K CRI80

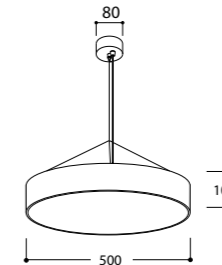

finish	3000K	4000K	€	3000K	4000K	€
	non dim			dali touch		
○	630347	630367	638,-	630357	630377	667,-
●	630346	630366	638,-	630356	630376	667,-

Family members:



Fabian Oak

LED ARRAY - 13,3 W - 230V 50-60Hz AC
2000 lumen 3000K CRI82

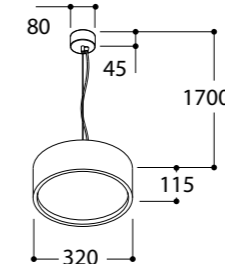

finish	mains-cord	3000K	€	3000K	€
		mains dim		dali/touch	
●	○	481100	483,-	481150	531,-

Family members:



suspended

Fabian

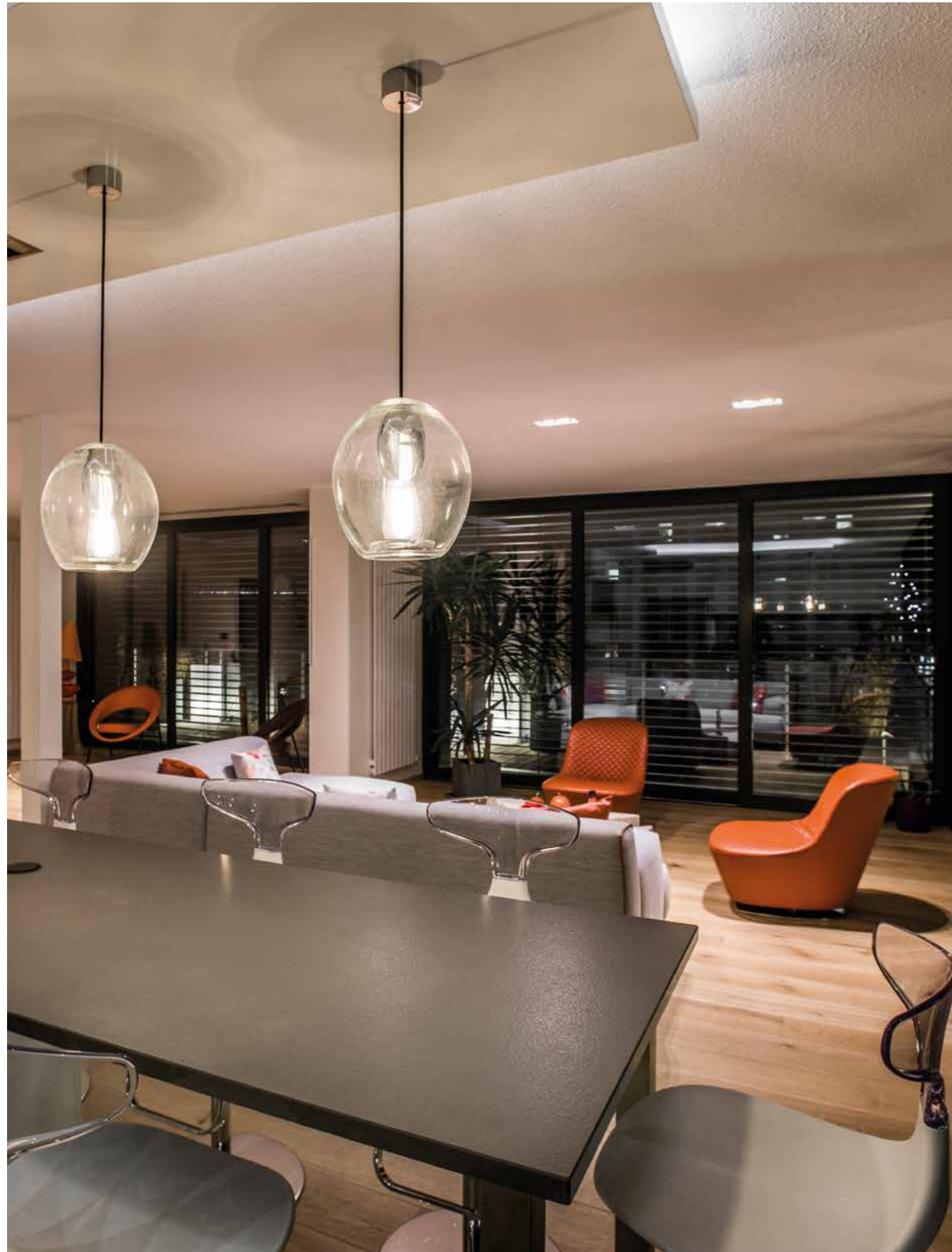

Penthouse Strasbourg



suspended

Olijf E27

A60 - MAX. 40W - 230V 50-60Hz AC

E27

dimmiability: dependent on bulb

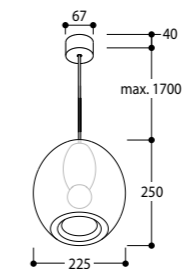

glass	pit		€
		480100	389,-
		480104	399,-

Family members:



Olijf



Danilith Wortegem-Petegem

Paris

PREVALED - 12,7W - 230V 50-60Hz AC
 1365 lumen 2700K CRI90
 dimmability: mains dim LC
 beam 38°

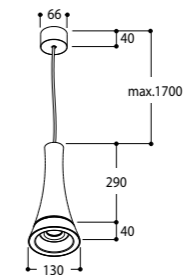

body	cone	focus	mains-cord	2700K	€
			transp.	496021	503,-
				496026	416,-
				496037	416,-
			transp.	496091	455,-
				496096	436,-
				496056	455,-
				496057	503,-

Family members:

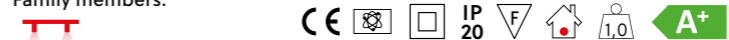

suspended

Designed by Peter Vanooteeghem

Paris

Hubble 300

LED ARRAY - 13,3 W - 230V 50-60Hz AC
2000 lumen 3000K CRI82
Opal diffuser
Indirect backlight

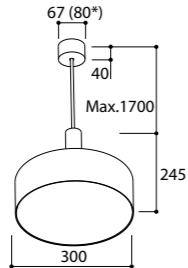

finish	3000K	€	3000K	€
	dimmable L,C		dali/touch	
	491947	551,-	491957	581,-
	491926	551,-	491936	581,-

Family members:

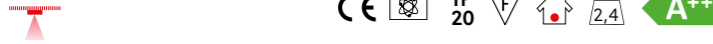

Hubble 400

LED ARRAY - 20,1 W - 230V 50-60Hz AC
2960 lumen 3000K CRI82
Opal diffuser
Indirect backlight

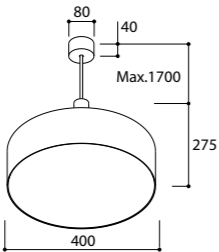

finish	3000K	€	3000K	€
	dimmable L,C		dali/touch	
	491967	775,-	491977	795,-
	491946	775,-	491956	795,-

Family members:



Telescoop

LUXEON M - 7,84W - 230V 50-60Hz AC
755 lumen 2700K CRI90
810 lumen 3000K CRI90
dimmability: mains dim RC
adjustable beam 20° - 48°

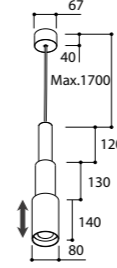

finish	2700K	3000K	€
	491562	491572	464,-
	491541	491551	464,-

Family members:

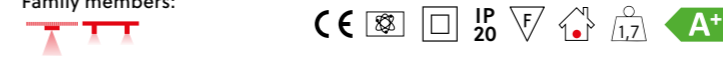

Telescoop M10

LUXEON M - 7,84W - 230V 50-60Hz AC
755 lumen 2700K CRI90
810 lumen 3000K CRI90
dimmability: mains dim LC
adjustable beam 20° - 48°

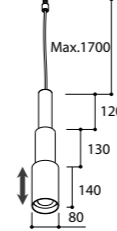

finish	2700K	3000K	€
	491662	491672	424,-
	491641	491651	424,-

M10 Base, see end of this chapter

Family members:



▲ Telescoop zoom in



▲ Telescoop zoom out



Fraeye Interieur

Nelson

LUXEON M - 7,84W - 230V 50-60Hz AC

755 lumen 2700K CRI90
 810 lumen 3000K CRI90
 dimmability: mains dim LC
 adjustable beam 20° - 48°

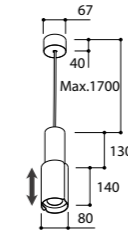

finish	layer	2700K	3000K	€
○	●	491177	491187	485,-
●	●	491176	491186	485,-
●	●	491170	491180	499,-

Family members:



Nelson M10

LUXEON M - 7,84W - 230V 50-60Hz AC

755 lumen 2700K CRI90
 810 lumen 3000K CRI90
 dimmability: mains dim LC
 adjustable beam 20° - 48°

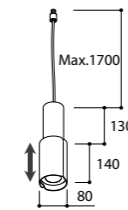

finish	layer	2700K	3000K	€
○	●	491277	491287	445,-
●	●	491276	491286	445,-
●	●	491270	491280	459,-

ⓘ M10 Base, see end of this chapter

Family members:

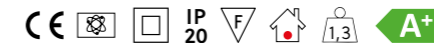

suspended

Designed by Sylvain Willenz

Nelson



Fraeye Interieur

Rollo 300

LED ARRAY - 13,3 W - 230V 50-60Hz AC
 2000 lumen 3000K CRI82
 Opal diffuser
 Indirect backlight

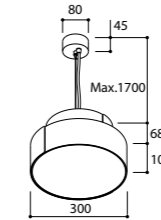

finish	layer	3000K	€	3000K	€
		dimmable L,C		dali/touch	
○	●	492157	713,-	492167	751,-
●	●	492156	713,-	492166	751,-
●	●	492150	713,-	492160	751,-

Family members:



Rollo 400

LED ARRAY - 20,1 W - 230V 50-60Hz AC
 2960 lumen 3000K CRI82
 Opal diffuser
 Indirect backlight

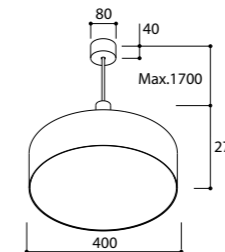

finish	layer	3000K	€	3000K	€
		dimmable L,C		dali/touch	
○	●	492357	968,-	492367	1004,-
●	●	492356	968,-	492366	1004,-
●	●	492350	968,-	492360	1004,-

Family members:



suspended

Rollo Designed by Sylvain Willenz



Gopa keukens

Queen Elizabeth

Configurations

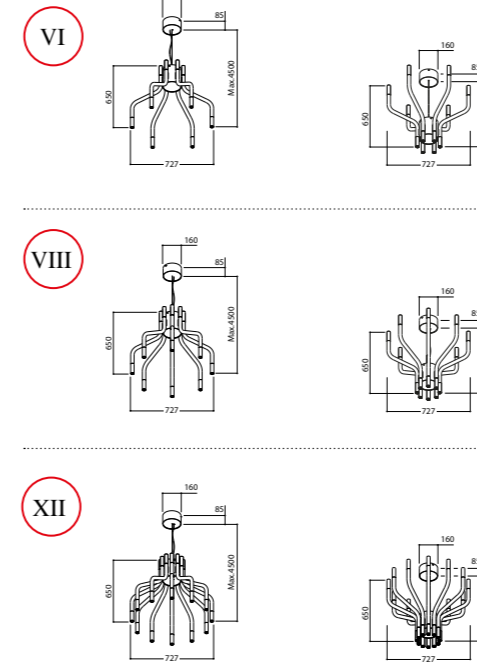

Visit our website and compose
your own **QUEEN ELIZABETH**
www.king-george.be



suspended

Designed by Michel de Nyn

Queen Elizabeth



Private house Kinrooi

King George

Configurations

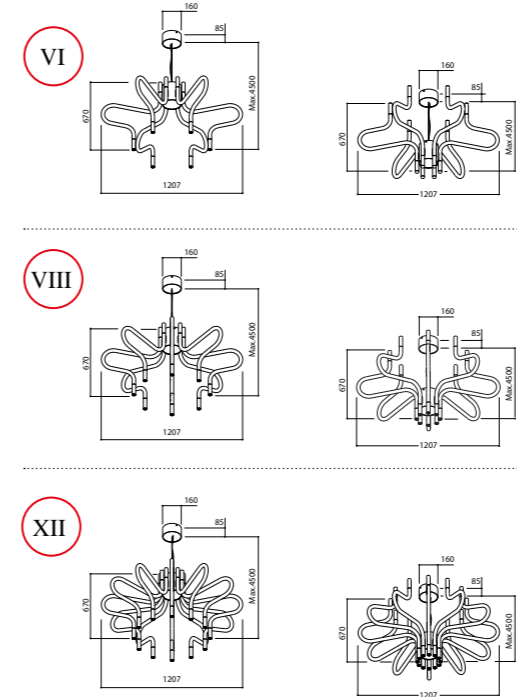

Visit our website and compose
your own King George
www.king-george.be

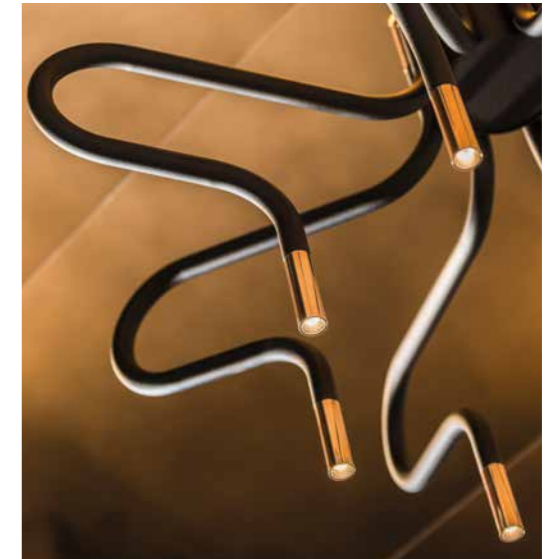

Family chalet Italy

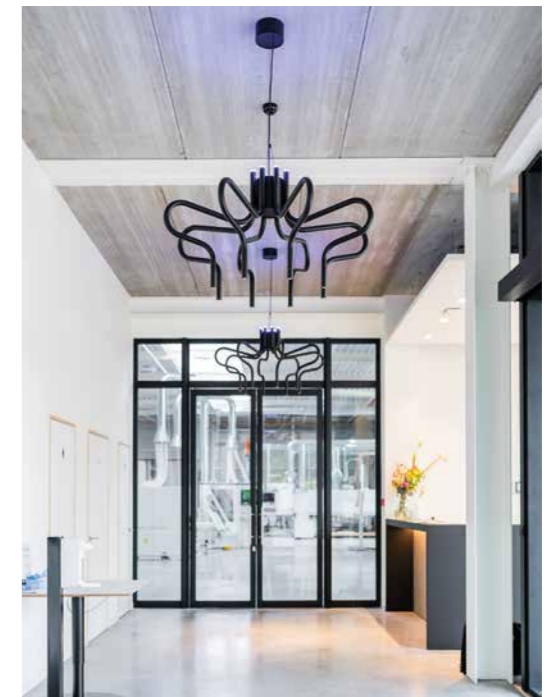

Rogiers Waregem

King George

Designed by Michel de Nyn

suspended

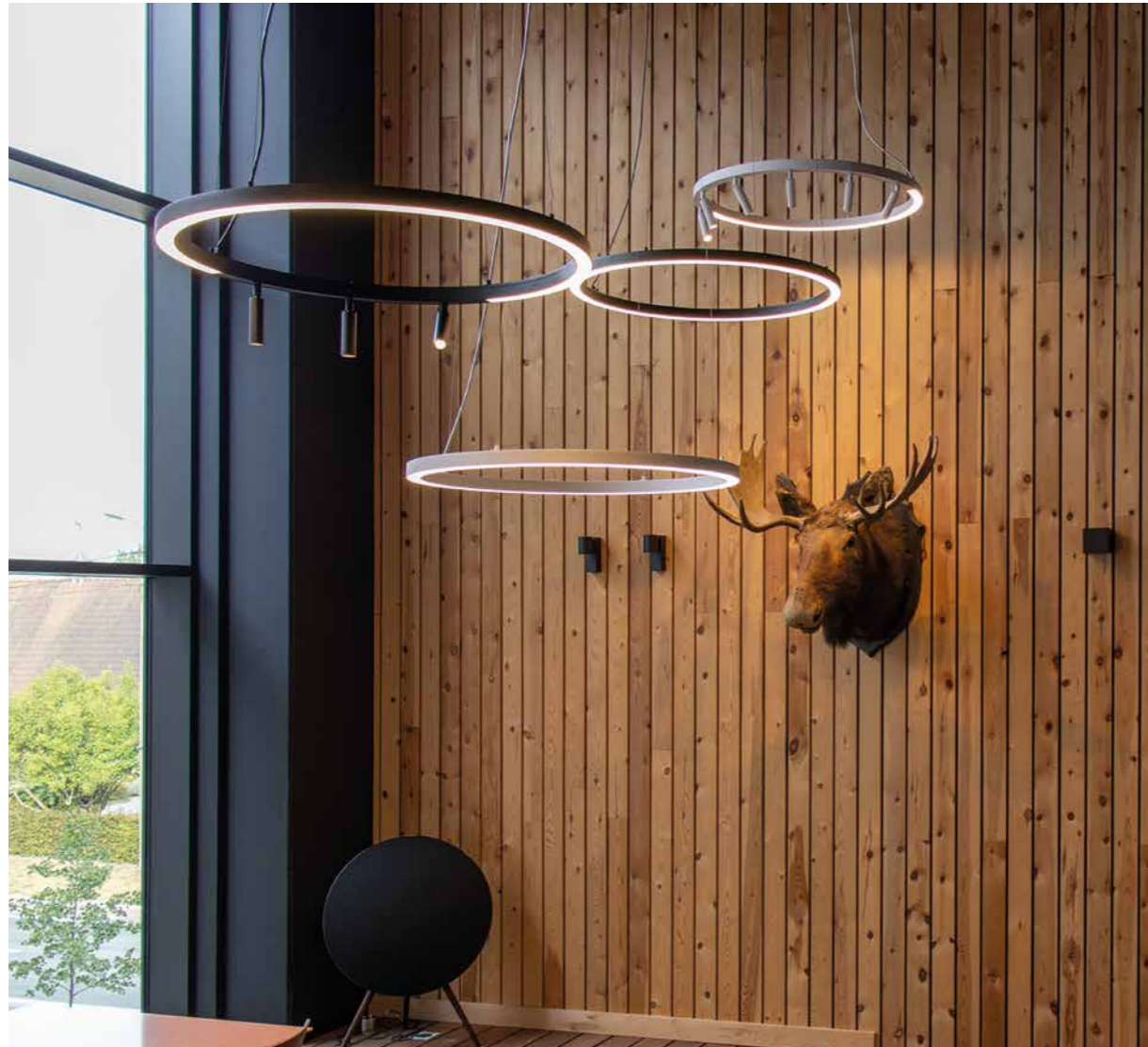

TAL Headquarters

Ringo Base

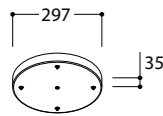

finish	24W LEDLINE + 24W SPOT	€	24W LEDLINE + 24W SPOT 1-10V DIMM	€	36W LEDLINE + 12W SPOT	€	36W LEDLINE + 12W SPOT 1-10V DIMM	€	48W	€	48W 1-10V DIMM	€
○	297327	420,-	297357	471,-	297317	417,-	297347	466,-	297307	349,-	297337	415,-
●	297326	420,-	297356	471,-	297316	417,-	297346	466,-	297306	349,-	297336	415,-

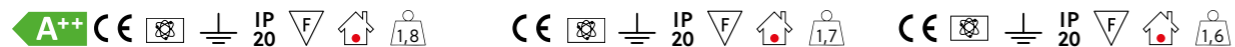

Ringo 835 180° Ledline

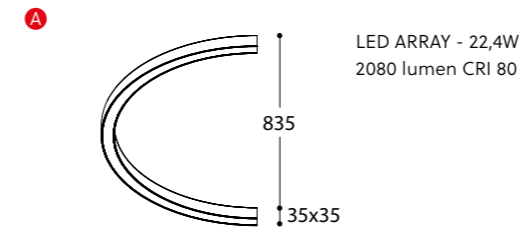

finish	2700K	3000K	4000K	€
○	297027	297037	297047	347,-
●	297026	297036	297046	347,-

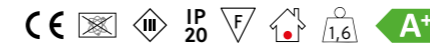

Ringo 835 90° Ledline + 90° 3x M10

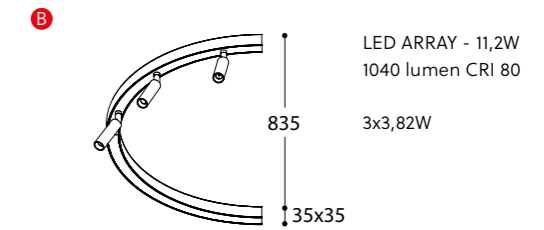

finish	2700K	3000K	4000K	€
○	297127	297137	297147	286,-
●	297126	297136	297146	286,-

! Nobel M10 spots need to be ordered separately see p.139



Ringo 835 180° 6x M10

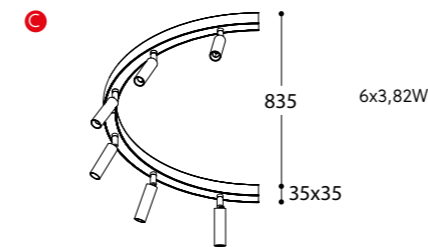

finish	2700K	€
○	297227	258,-
●	297226	258,-

! Nobel M10 spots need to be ordered separately see p.139

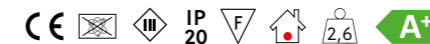

Ringo Suspension Examples

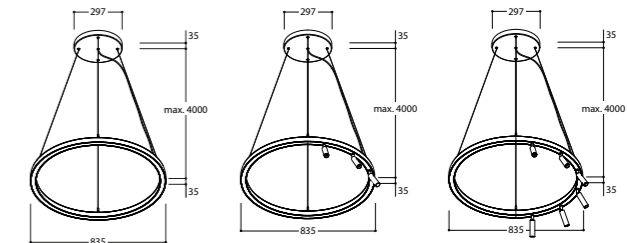

example A+A

example A+B

example A+C

C+C combination is not possible

Ringo Suspension Set

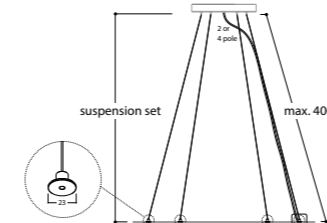

finish	2 P	€	4 P	€
	ledline		ledline + spot	
○	297901	83,-	297911	88,-
●	297902	83,-	297912	88,-

Extra Circuit

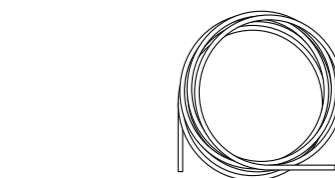

		€
Common neutral	892630	14,-
No common neutral	892631	29,-

suspended

Ringo



Memlinc Knokke (special work: chrome)

Diabolo M

LED ARRAY - 13,3W - 230V 50-60Hz AC
 2000 lumen 2700K CRI82
 2000 lumen 3000K CRI82
 2200 lumen 4000K CRI82

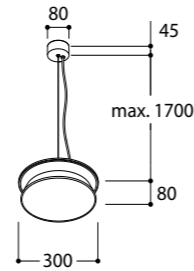

finish	3000K		€	4000K		€
	mains dim		dali touch			
○	177847	177857	365,-	177947	177957	399,-
●	177826	177836	365,-	177926	177936	399,-

Family members:



Memlinc Knokke (special work: glossy black)

Diabolo XL

LED ARRAY - 70,8W - 230V 50-60HZ AC
 13000 lumen 2700K CRI80
 13000 lumen 3000K CRI80
 13000 lumen 4000K CRI80
 dimmability: dali touch dim

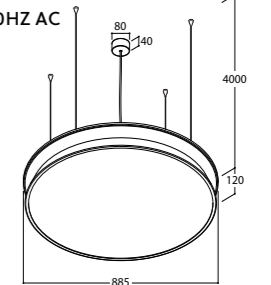

finish	2700K	3000K	4000K	€
	○	277137	277147	277157
●	277116	277126	277136	2034,-

Family members:

Matchable products



Berrier Cone Kalebas Nelson Nuts Olijf* Telescoop



Berrier Junior Cone Junior Kalebas Led Nobel Pi Funnel 150

*Olijf must be positioned at different heights to avoid glass contact



Private house Pittem

suspended

M10 Base Pro 1 (300)

230V 50-60Hz AC

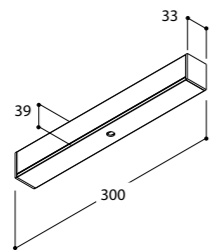

finish	230V*	€	CI 350mA mains dimm LC		CI 250mA mains dimm LC	
			MAX 4W	MAX 5W	€	€
●	375827	74,-	378827	379827	105,-	
○	375848	74,-	378848	379848	105,-	

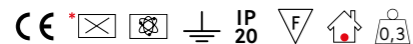

M10 Base Pro 2 (600)

230V 50-60Hz AC

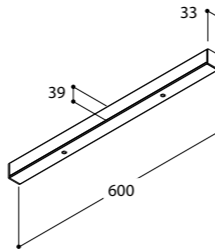

finish	230V*	€	CI 350mA mains dimm LC		CI 250mA mains dimm LC	
			MAX 8W	MAX 10W	€	€
●	375527	89,-	378527	379527	142,-	
○	375548	89,-	378548	379548	142,-	

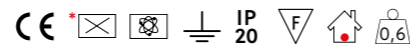

M10 Base Pro 3 (900)

230V 50-60Hz AC

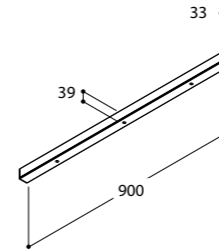

finish	230V*	€	CI 350mA mains dimm LC		CI 250mA mains dimm LC	
			MAX 12W	MAX 15W	€	€
●	375627	110,-	378627	379627	204,-	
○	375648	110,-	378648	379648	204,-	

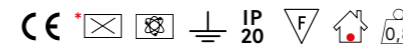

M10 Base Pro 4 (1200)

230V 50-60Hz AC

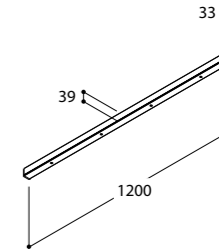

finish	230V*	€	CI 350mA mains dimm LC		CI 250mA mains dimm LC	
			MAX 16W	MAX 20W	€	€
●	375727	136,-	378727	379727	243,-	
○	375748	136,-	378748	379748	243,-	

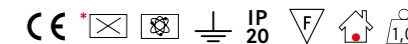

For custom made lengths please use Protut profile with M10 modules P.437

M10 Base Pro



Danilith Wortegem-Petegem

M10 Base Round 3

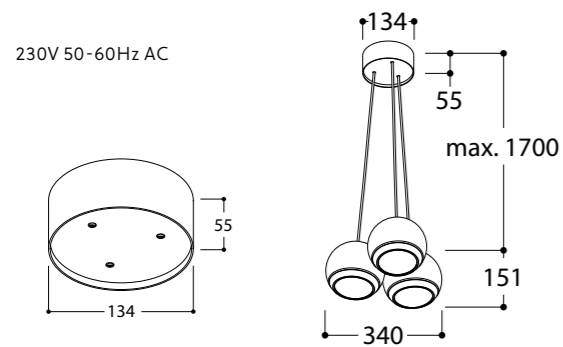

finish	230V*	€	CI 350mA mains dimm LC MAX18W	€
●	411926	85,-	408726	106,-
○	411937	85,-	408747	106,-

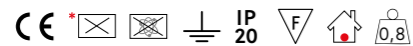

Inspirium Breda

M10 Base Round 7

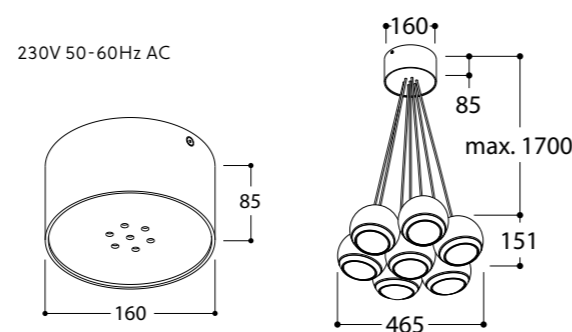

finish	230V	€
●	411976	111,-
○	411977	111,-

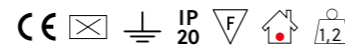

GLK Kruisem

M10 Clusterplate 7 230V

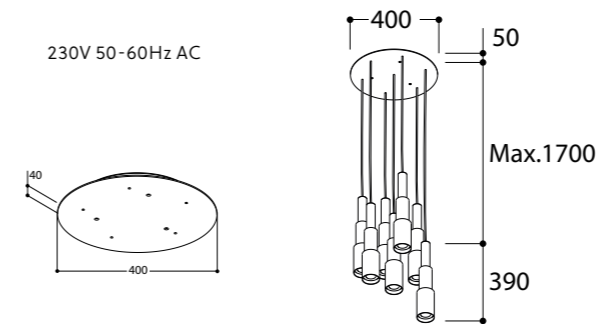

finish	€
●	492976 95,-
○	492977 95,-



M10 Clusterplate 11 230V

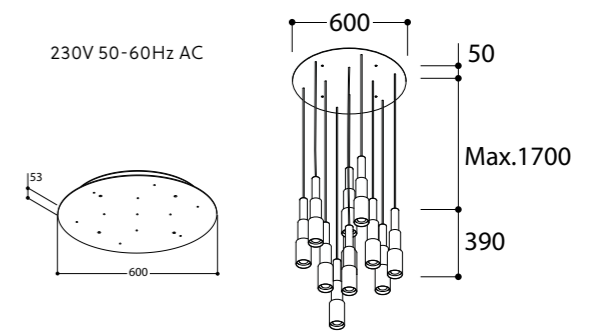

finish	€
●	492916 144,-
○	492917 144,-

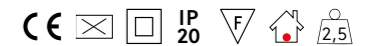

suspended

M10 Base Round



Home office Ardoois

M10 Base Recessed Small

350mA DC / 500mA DC / 700mA DC / ...
... / 230V - AC

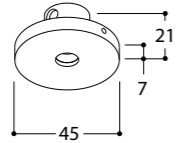

finish		€
●	408826	26,-
○	408847	26,-

56 mm
Installation depth 50 mm



M10 Base Recessed Large

350mA DC / 500mA DC / 700mA DC / ...
... / 230V - AC

Can be used as access point for converter!

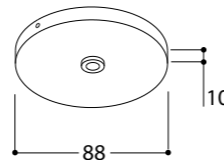

finish		€
●	408926	35,-
○	408947	35,-

42 mm
Installation depth 50 mm

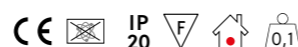

Matchable products



Kosmos Base M10

350mA DC / 500mA DC / 700mA DC / ...
... / 230V - AC

Max. luminaire weight: 0,5kg
Can be used as access point for converter!

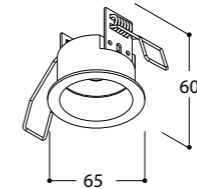

finish		€
●	408626	42,-
○	408647	42,-

56 mm
Installation depth 60 mm

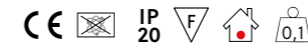

Kosmos Base M10 Heavy Load

350mA DC / 500mA DC / 700mA DC / ...
... / 230V - AC

Max. luminaire weight: 5kg
Can be used as access point for converter!

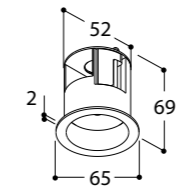

finish		€
●	408636	69,-
○	408657	69,-

56 mm
Installation depth 75 mm

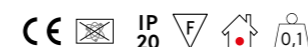

Converter matrix, see back flap

suspended

Kosmos Base M10

stand alone

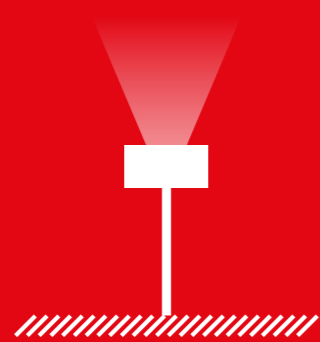

NEW	Kalebas	269
	Snake	270
	Roseau	271



Headquarters TAL

Kalebas Floor

LED ARRAY - 8,3W - 230V 50-60Hz AC
 1067 lumen 2700K CRI92
 1086 lumen 3000K CRI92
 dimmability: dimmer on mainscord
 beam 85°



finish	2700K	3000K	€
●	488436	488446	578,-
○	488457	488467	578,-
●	488403	488413	593,-

Kalebas Glass	finish	price
	○	488293 142,-
	●	488292 142,-
	●	488290 142,-
	●	488291 142,-

Family members:

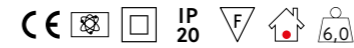

stand alone

Kalebas Table

LED ARRAY - 8,3W - 230V 50-60Hz AC
 1067 lumen 2700K CRI92
 1086 lumen 3000K CRI92
 dimmability: dimmer on mainscord
 beam 85°

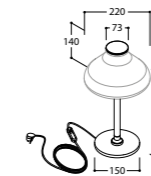

finish	2700K	3000K	€
●	488356	488366	444,-
○	488377	488387	444,-
●	488323	488333	459,-

Kalebas Glass	finish	price
	○	488293 142,-
	●	488292 142,-
	●	488290 142,-
	●	488291 142,-

Family members:

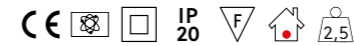

Kalebas



De Maatwerker Knokke

Snake

Designed by Bruno Epicum

LUXEON M - 3,82W - 230V AV 50-60Hz
 400 lumen 2700K CRI90
 429 lumen 3000K CRI90
 dimmability: dimmer on mainscord
 beam 36°

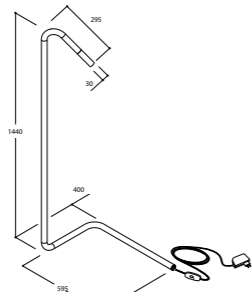
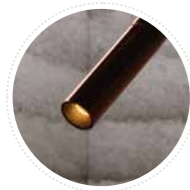

finish	2700K	3000K	€
○	485447	485547	696,-
●	485426	485526	696,-



Private house Brussels

Roseau Floor

Designed by Michel de Nyn

LUXEON M - 3,82W - 230V AV 50-60Hz AC
 400 lumen 2700K CRI90
 429 lumen 3000K CRI90
 dimmability: dimmer on mainscord
 beam 60°

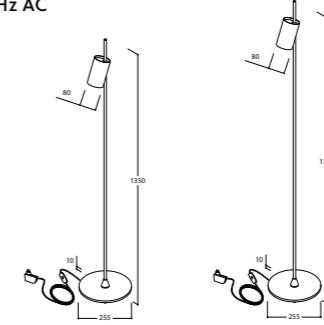

finish	1350mm		€	1700mm		€
	2700K	3000K		2700K	3000K	
○	416647	416657	625,-	416747	416757	640,-
●	416626	416636	625,-	416726	416736	640,-



stand alone

Snake & Roseau

inground uplight



Micro Obo	275
Micro Ubo	277
Mini Obo Opal 350mA	279
Mini Obo Spot 350mA	281
Mini Ubo Opal 350mA	283
Mini Ubo Spot 350mA	285

Section view Obo vs. Ubo



	MATERIAL	TREATMENT	
Finishes	Stainless Steel	Marine grade 316	Electrolytically Polished
	Silver Ano	AlMgSi 0,5	Technical Anodised
	Black Ano	AlMgSi 0,5	Technical Anodised

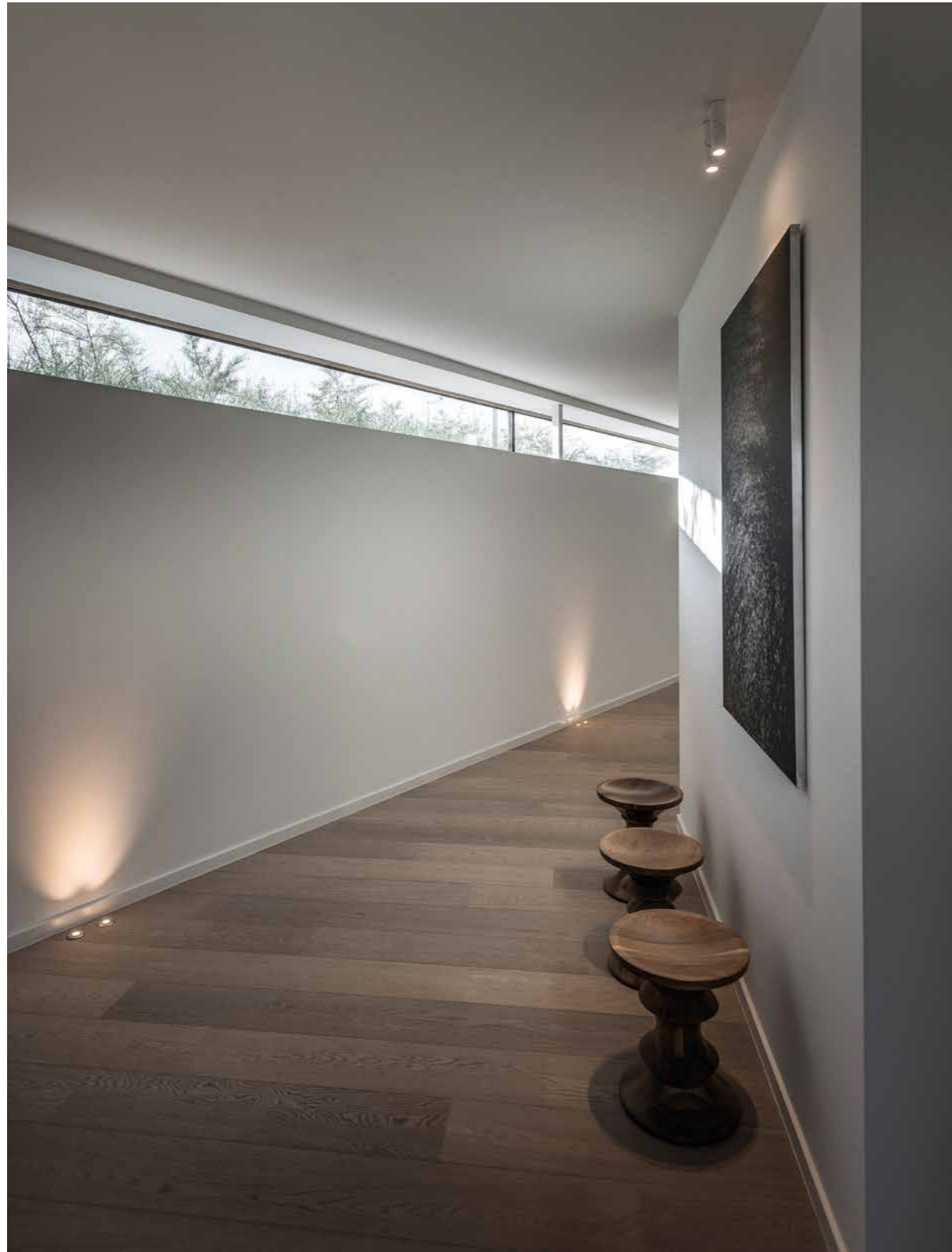

Residentie Corbu Koksijde

Micro Obo Round

LUXEON M - 3,82W - 350mA DC - (10,86 Vf)
 400 lumen 2700K CRI90
 429 lumen 3000K CRI90
 dimmability: PWM/CCR
 beam 36°
 clear glass

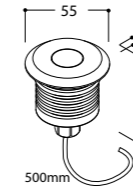

finish	2700K	3000K	€
●	362621	362670	123,-
●	362623	362672	101,-
! Floortube	369650		12,-

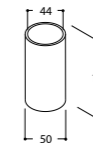

Micro Obo Focus

LUXEON M - 3,82W - 350mA DC - (10,86 Vf)
 400 lumen 2700K CRI90
 429 lumen 3000K CRI90
 dimmability: PWM/CCR
 beam 36°
 clear glass

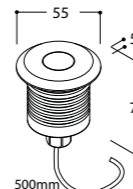

finish	focus	2700K	3000K	€
●	●	362625	362675	136,-
●	●	362627	362677	109,-
●	●	362628	362679	113,-
●	●	362629	362678	111,-
! Floortube		369650		12,-

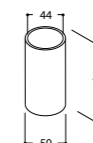

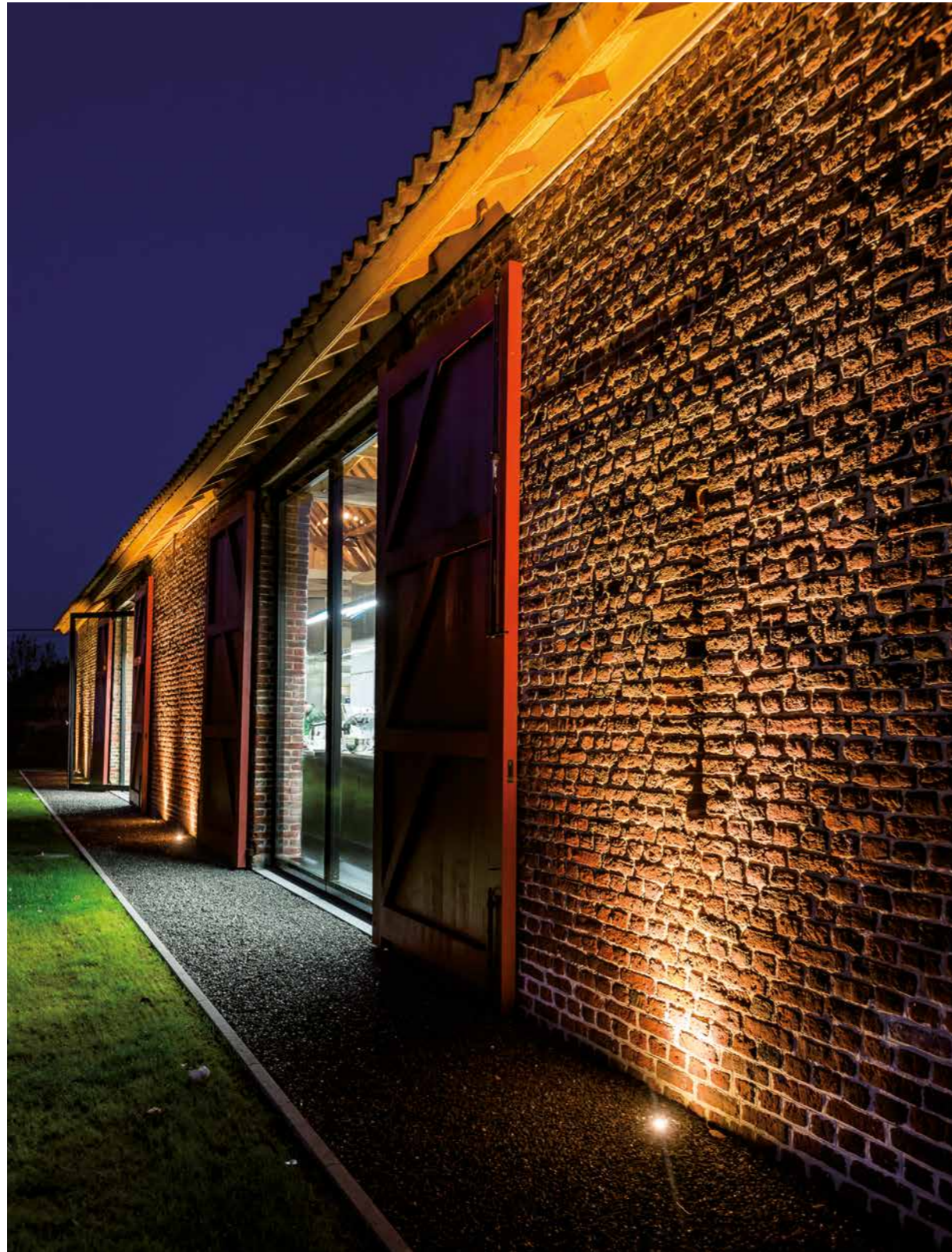

Hertog Jan Zedelgem

Micro Ubo Round

LUXEON M - 3,82W - 350mA DC - (10,86 Vf)

400 lumen 2700K CRI90
 429 lumen 3000K CRI90
 dimmability: PWM/CCR
 beam 36°
 clear glass

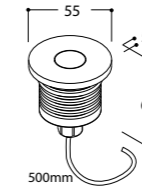

finish	2700K	3000K	€
●	362641	362660	123,-
●	362643	362662	101,-
! Floortube white	369651	13,-	
! Floortube black	369653	13,-	

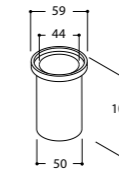

Micro Ubo Focus

LUXEON M - 3,82W - 350mA DC - (10,86 Vf)

400 lumen 2700K CRI90
 429 lumen 3000K CRI90
 dimmability: PWM/CCR
 beam 36°
 clear glass

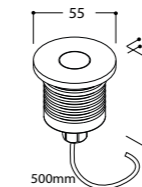

finish	focus	2700K	3000K	€
●	●	362645	362665	136,-
●	●	362647	362667	109,-
●	●	362648	362669	113,-
●	●	362649	362668	111,-
! Floortube white		369651	13,-	
! Floortube black		369653	13,-	

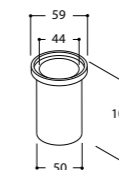

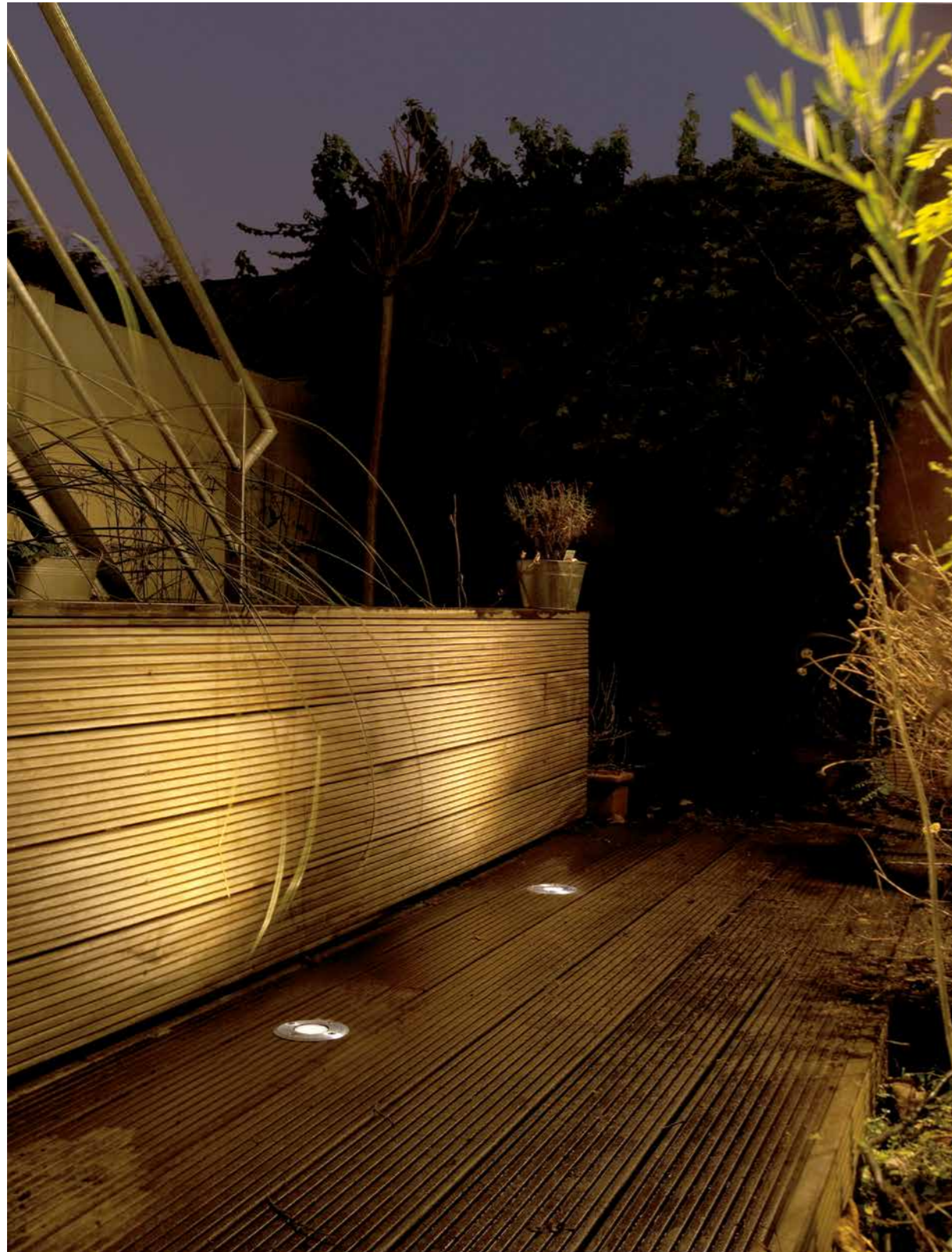

Private garden Menen

Mini Obo Round 350mA

LUXEON M - 3,82W - 350mA DC - (10,86 Vf)
 400 lumen 2700K CRI90
 429 lumen 3000K CRI90
 dimmability: PWM/CCR
 opal glass

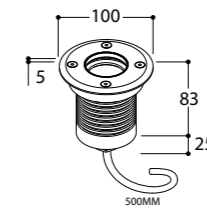

finish	2700K	3000K	€
●	369200	369240	265,-
●	369202	369242	235,-
! Floortube	366358		45,-



Mini Obo Square 350mA

LUXEON M - 3,82W - 350mA DC - (10,86 Vf)
 400 lumen 2700K CRI90
 429 lumen 3000K CRI90
 dimmability: PWM/CCR
 opal glass

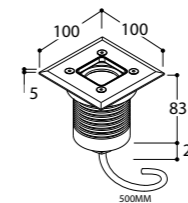

finish	2700K	3000K	€
●	369210	369250	265,-
●	369212	369252	235,-
! Floortube	366358		45,-



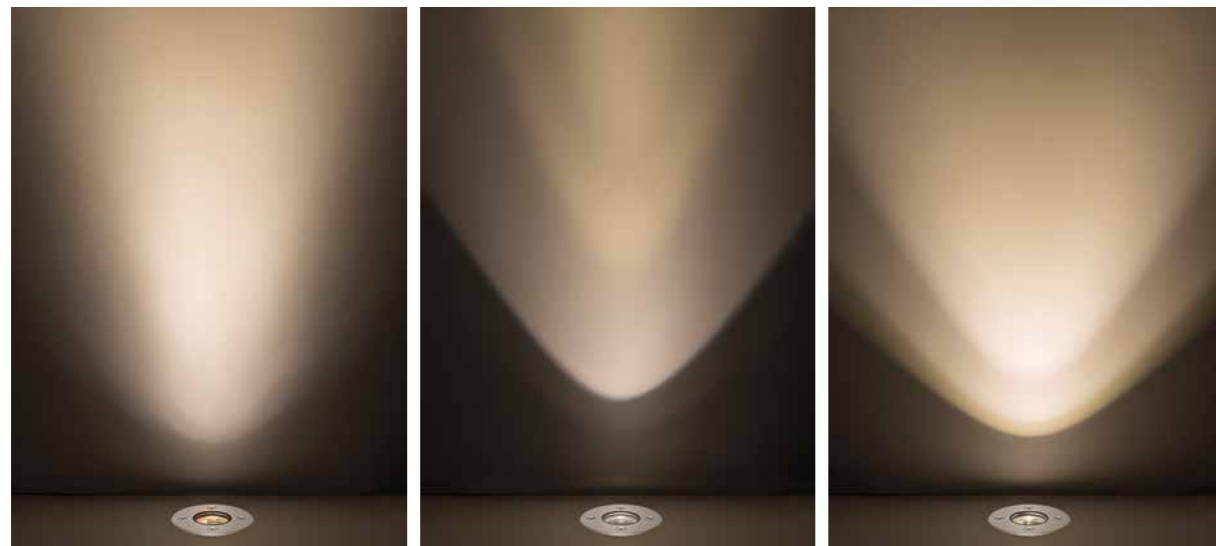

9°

38°

60°



Mini Obo Round 350mA

LUXEON M - 3,82W - 350mA DC - (10,86 Vf)
 400 lumen 2700K CRI90
 429 lumen 3000K CRI90
 dimmability: PWM/CCR
 clear glass

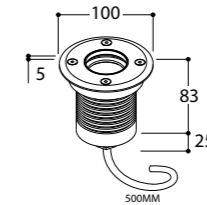

finish	2700K			3000K			€	
	9°	38°	60°	9°	38°	60°		
●	369300	369400	369500	369340	369440	369540	302,-	
●	369302	369402	369502	369342	369442	369542	279,-	
! Floortube							366358	45,-



inground uplight

Mini Obo Square 350mA

LUXEON M - 3,82W - 350mA DC - (10,86 Vf)
 400 lumen 2700K CRI90
 429 lumen 3000K CRI90
 dimmability: PWM/CCR
 clear glass

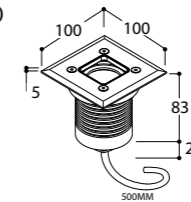

finish	2700K			3000K			€	
	9°	38°	60°	9°	38°	60°		
●	369310	369410	369510	369350	369450	369550	309,-	
●	369312	369412	369512	369352	369452	369552	285,-	
! Floortube							366358	45,-



Mini Obo Spot 350mA



Hertog Jan Zedelgem

Mini Ubo Round 350mA

LUXEON M - 3,82W - 350mA DC - (10,86 Vf)
 400 lumen 2700K CRI90
 429 lumen 3000K CRI90
 dimmability: PWM/CCR
 opal glass

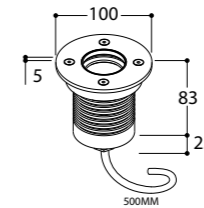

finish	2700K	3000K	€
●	369220	369260	265,-
●	369222	369262	235,-
! Floortube	366348		54,-



Mini Ubo Square 350mA

LUXEON M - 3,82W - 350mA DC - (10,86 Vf)
 400 lumen 2700K CRI90
 429 lumen 3000K CRI90
 dimmability: PWM/CCR
 opal glass

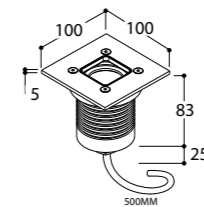

finish	2700K	3000K	€
●	369230	369270	265,-
●	369232	369272	235,-
! Floortube	366448		54,-



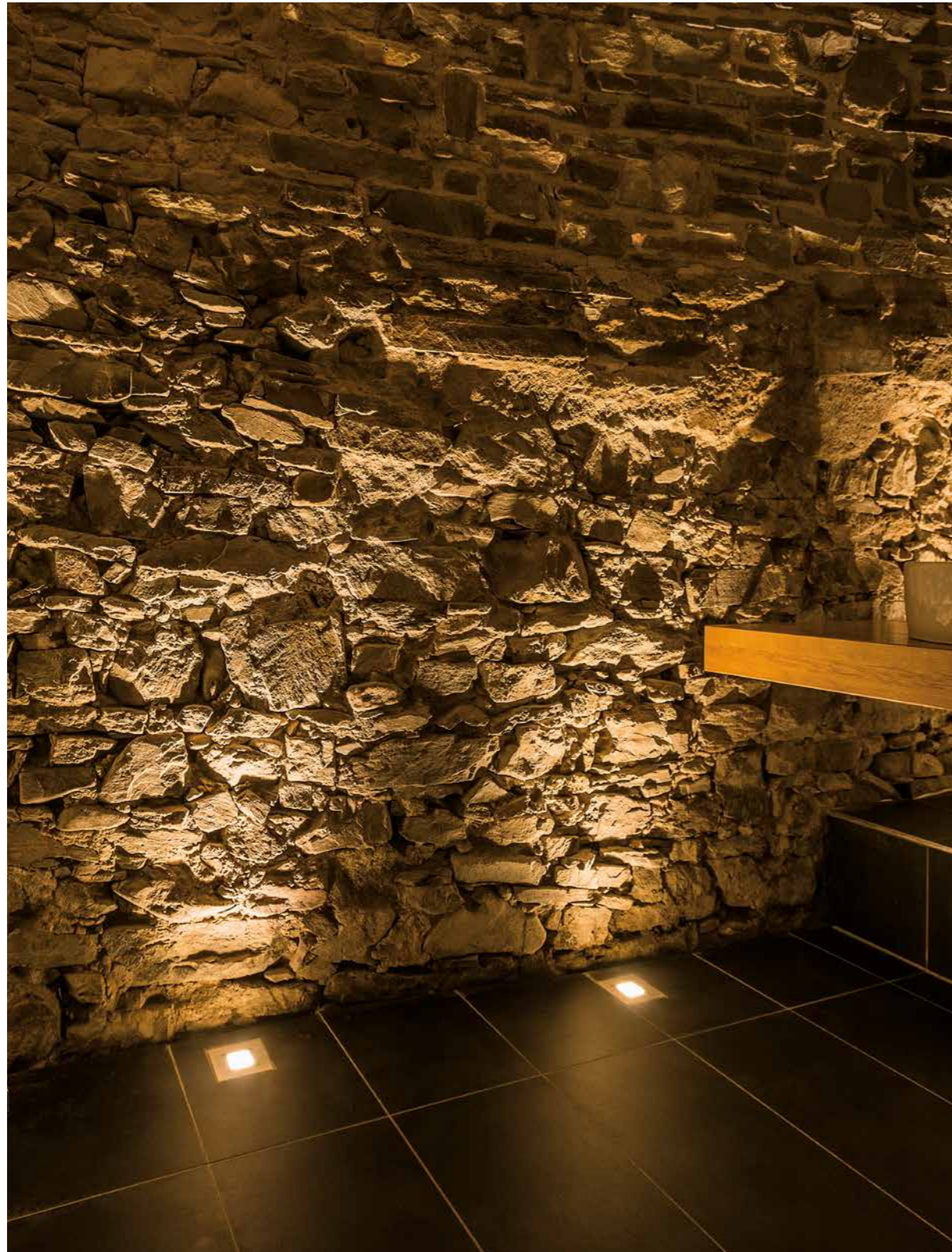

Restaurante Petrocelli Berlin

Mini Ubo Round 350mA

LUXEON M - 3,82W - 350mA DC - (10,86 Vf)
 400 lumen 2700K CRI90
 429 lumen 3000K CRI90
 dimmability: PWM/CCR
 clear glass

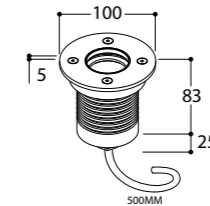

finish	2700K			3000K			€
	9°	38°	60°	9°	38°	60°	
●	369320	369420	369520	369360	369460	369560	302,-
●	369322	369422	369522	369362	369462	369562	279,-
ⓘ Floortube							366348 54,-



Mini Ubo Square 350mA

LUXEON M - 3,82W - 350mA DC - (10,86 Vf)
 400 lumen 2700K CRI90
 429 lumen 3000K CRI90
 dimmability: PWM/CCR
 clear glass

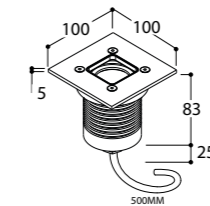

finish	2700K			3000K			€
	9°	38°	60°	9°	38°	60°	
●	369330	369430	369530	369370	369470	369570	309,-
●	369332	369432	369532	369372	369472	369572	271,-
ⓘ Floortube							366448 54,-

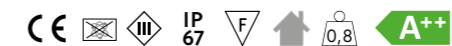

Floortubes

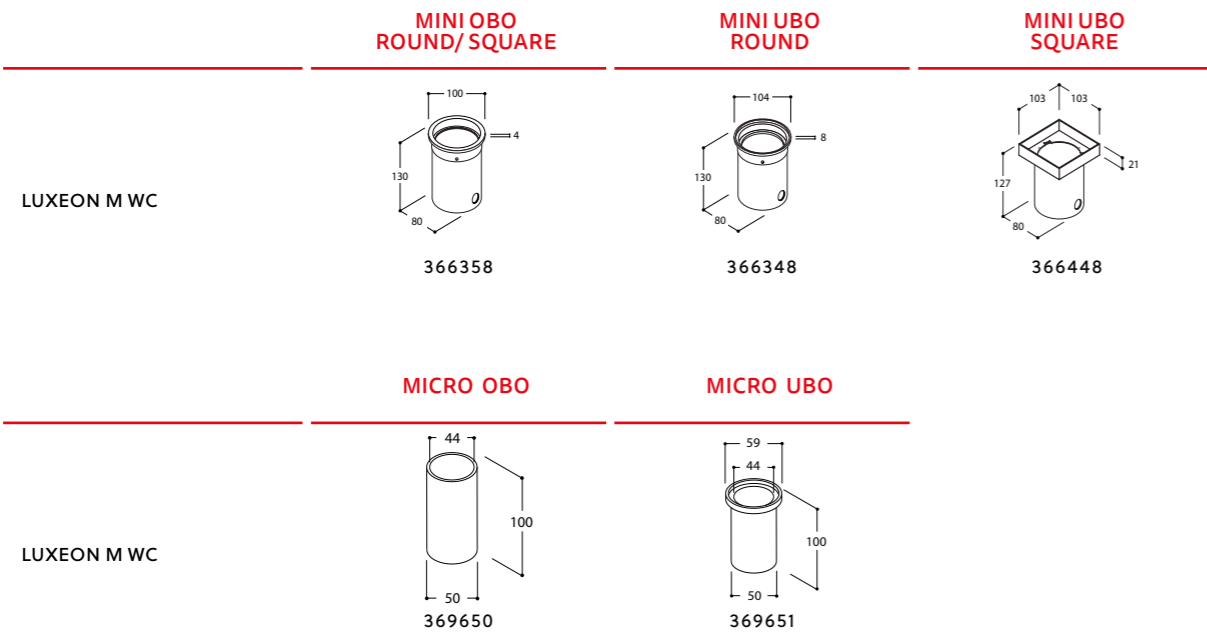

Recommended installation of floorspots

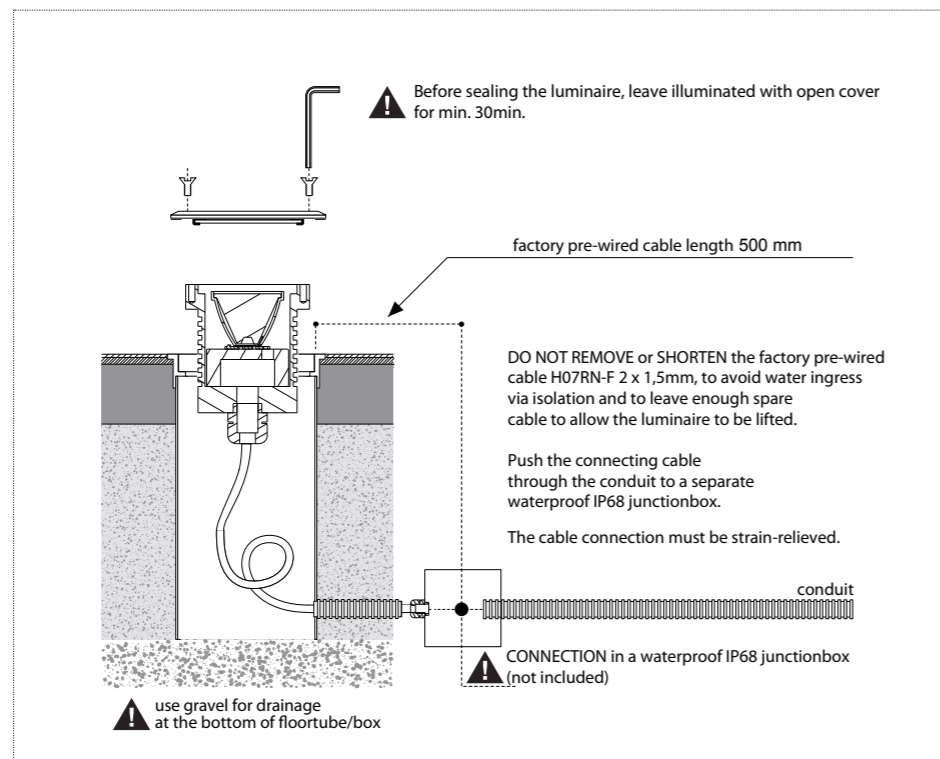

Recessed dimensions

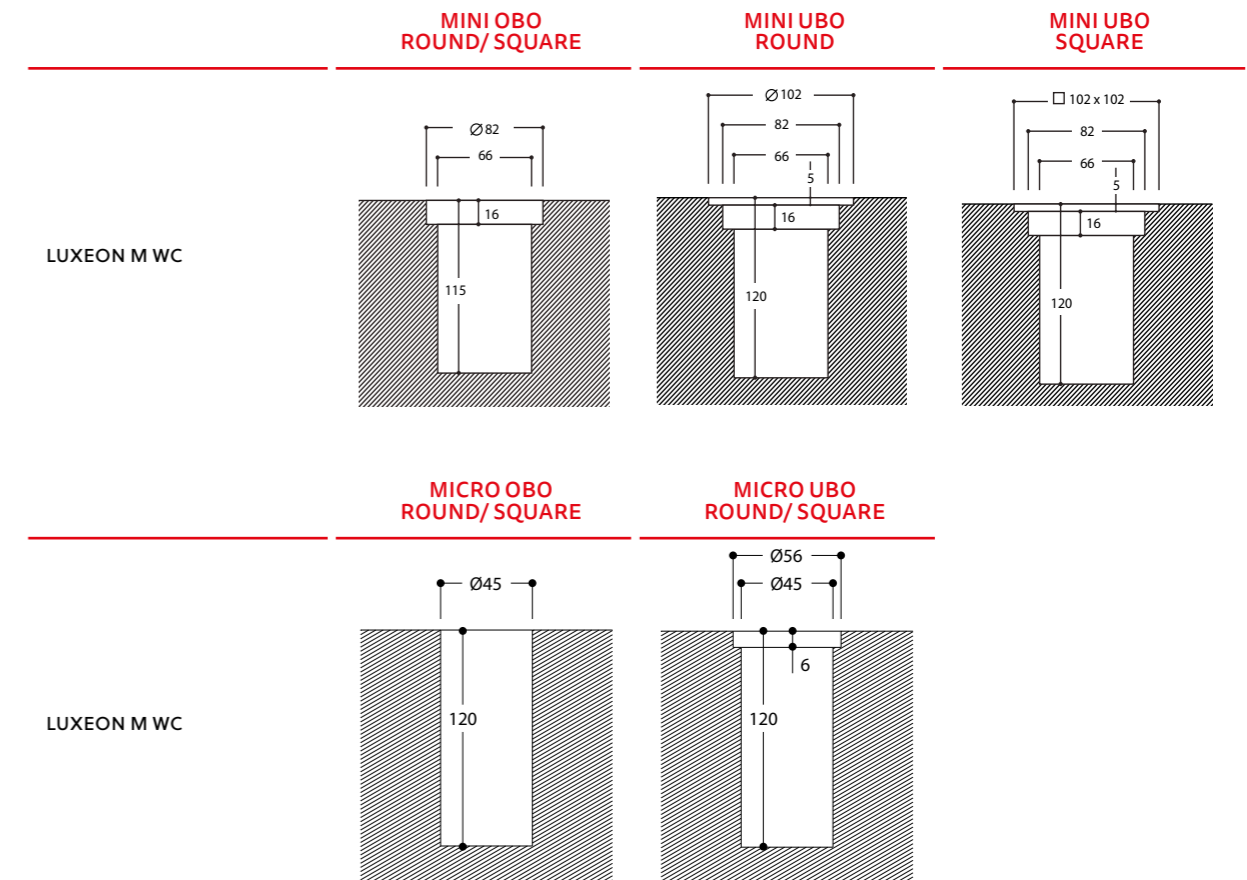

- Recessed dimensions are the minimum dimensions required for floorspot installation without floorspot or floortube.
- Longer factory pre-wired cable lengths available on request.

exterior



Mini Helax	291	Brix Out	313
NEW Helax	293	NEW Heb Nxt	315
B4 Out	298	Menhir	317
Brix Ceiling	299	NEW Pulsar	321
Greg	300	Roseau	323
Gregorius	301	Guardian	327
Guido	303	Bernard	329
NEW Hekowa	305	Hedge	331
Max	311	Tootem	333



Private house Zedelgem

Mini Helax Out 400

LUXEON M - 3,82W - 350mA DC - (10,95 Vf)

400 lumen 2700K CRI90

429 lumen 3000K CRI90

dimmiability: PWM/CCR

beam 36°

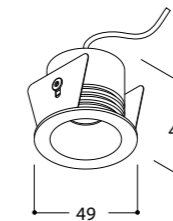

40 mm

Installation depth 60 mm

finish	2700K	3000K	€
●	178946	178947	84,-
○	178940	178941	84,-

Family members:



4000K ON DEMAND Converter matrix, see back flap



Mini Helax Out

40 mm

exterior



Private house

Helax SML Out Torsion

LUXEON M - 3,82W - 350mA DC - (10,95 Vf)

400 lumen 2700K CRI90

429 lumen 3000K CRI90

dimmiability: PWM/CCR

beam 36°

	finish	2700K	3000K	€
IP 54	●	178626	178636	95,-
	○	178647	178657	95,-
IP 65	●	178735	178736	123,-
	○	178756	178757	123,-

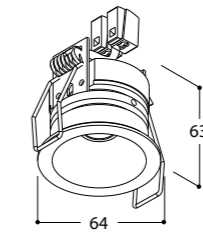

55 mm
Installation depth 65 mm

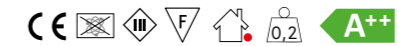

Helax SML Out Leaf

LUXEON M - 3,82W - 350mA DC - (10,95 Vf)

400 lumen 2700K CRI90

429 lumen 3000K CRI90

dimmiability: PWM/CCR

beam 36°

	finish	2700K	3000K	€
IP 54	●	178526	178536	95,-
	○	178547	178557	95,-
IP 65	●	178725	178726	123,-
	○	178746	178747	123,-

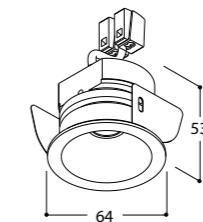

56 mm / Installation depth
70 mm solid ceilings
55 mm / Installation depth
55 mm hollow ceilings

Family members:

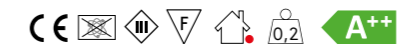



Private House Brugge

Helax 70 Out Haloled Torsion

LUXEON M - 7,84W - 700mA DC - (11,2 Vf)

755 lumen 2700K CRI90
810 lumen 3000K CRI90
dimmability: PWM/CCR
beam 36°

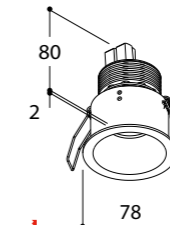

70 mm
Installation depth 85 mm

finish	2700K	3000K	€
●	249016	249026	98,-
○	249017	249027	98,-

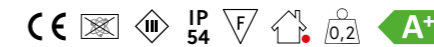

Helax 70 Out Haloled Leaf

LUXEON M - 7,84W - 700mA DC - (11,2 Vf)

755 lumen 2700K CRI90
810 lumen 3000K CRI90
dimmability: PWM/CCR
beam 36°

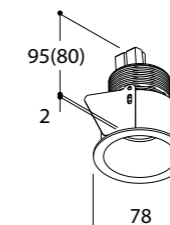

70 mm
Installation depth
85 mm hollow ceilings / 100 mm solid ceilings

finish	2700K	3000K	€
●	249046	249056	98,-
○	249047	249057	98,-

Family members:

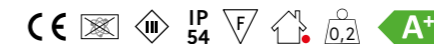

4000K ON DEMAND Converter matrix, see back flap





Private House Zedelgem

Helax SML Out Haloled

LUXEON M - 7,84W - 700mA DC - (11,2 Vf)
 755 lumen 2700K CRI90
 810 lumen 3000K CRI90
 dimmability: PWM/CCR
 beam 36°

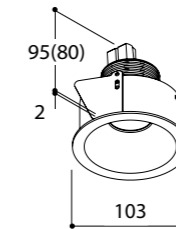

95 mm
 Installation depth
 85 mm hollow ceilings / 100 mm solid ceilings

finish	2700K	3000K	€
●	249146	249156	101,-
○	249147	249157	101,-

Family members:



4000K ON DEMAND Converter matrix, see back flap



Helax SML Out Haloled



Private house Ypres



Private house Brugge

exterior

B4 Out Leaf

CREE XPG - 7,91W - 700mA DC - (11,32VF)

832 lumen 2700K CRI92
832 lumen 3000K CRI92
dimmability: PWM/CCR

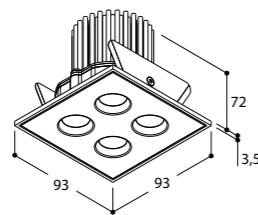

80 mm
Installation depth:
77 mm hollow ceilings / 92 mm solid ceilings



finish	2700K			3000K			€
	10°	25°	46°	10°	25°	46°	
●	294326	294426	294526	294336	294436	294536	176,-
○	294347	294447	294547	294357	294457	294557	176,-

Family members:

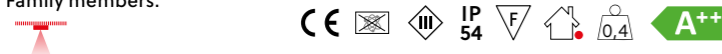

Brix Ceiling

LUXEON M - 3,82W - 230V - 50-60Hz AC

400 lumen 2700K CRI90
429 lumen 3000K CRI90
dimmability: dimmable LC
beam 36°

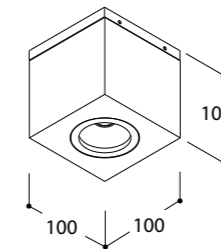

finish	2700K	3000K	€
	●	260972	
●	260976	260986	239,-
●	260974	260984	239,-

Family members:



B4 Out & Brix Ceiling



Private house Brussels

Greg Indy

CREE XPE - 1,2W - 230V 50-60Hz AC
 94 lumen 2700K CRI80
 94 lumen 3000K CRI80
 dimmability: not dimmable

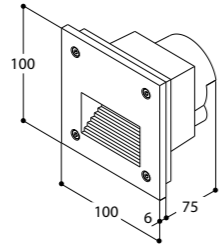

finish	2700K	3000K	€
●	186286	186296	132,-
●	186224	186234	132,-
●	186283	186293	132,-

Greg installation box 168999 13,- 93 x 93 x 90 mm



Gregorius

CITIZEN LED 6,44W - 230V 50-60Hz AC
 500 lumen 2700K CRI90
 610 lumen 3000K CRI85
 dimmability: not dimmable

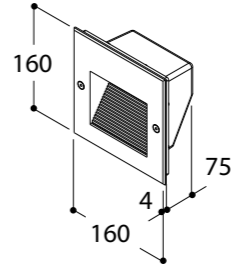

finish	2700K	3000K	€
●	432026	432036	244,-
●	432003	432013	244,-
●	432023	432033	244,-

Gregorius installation box 432097 50,- 153 x 153 x 105 mm
 Instal. box for visible concrete 432099 60,-

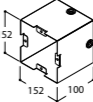

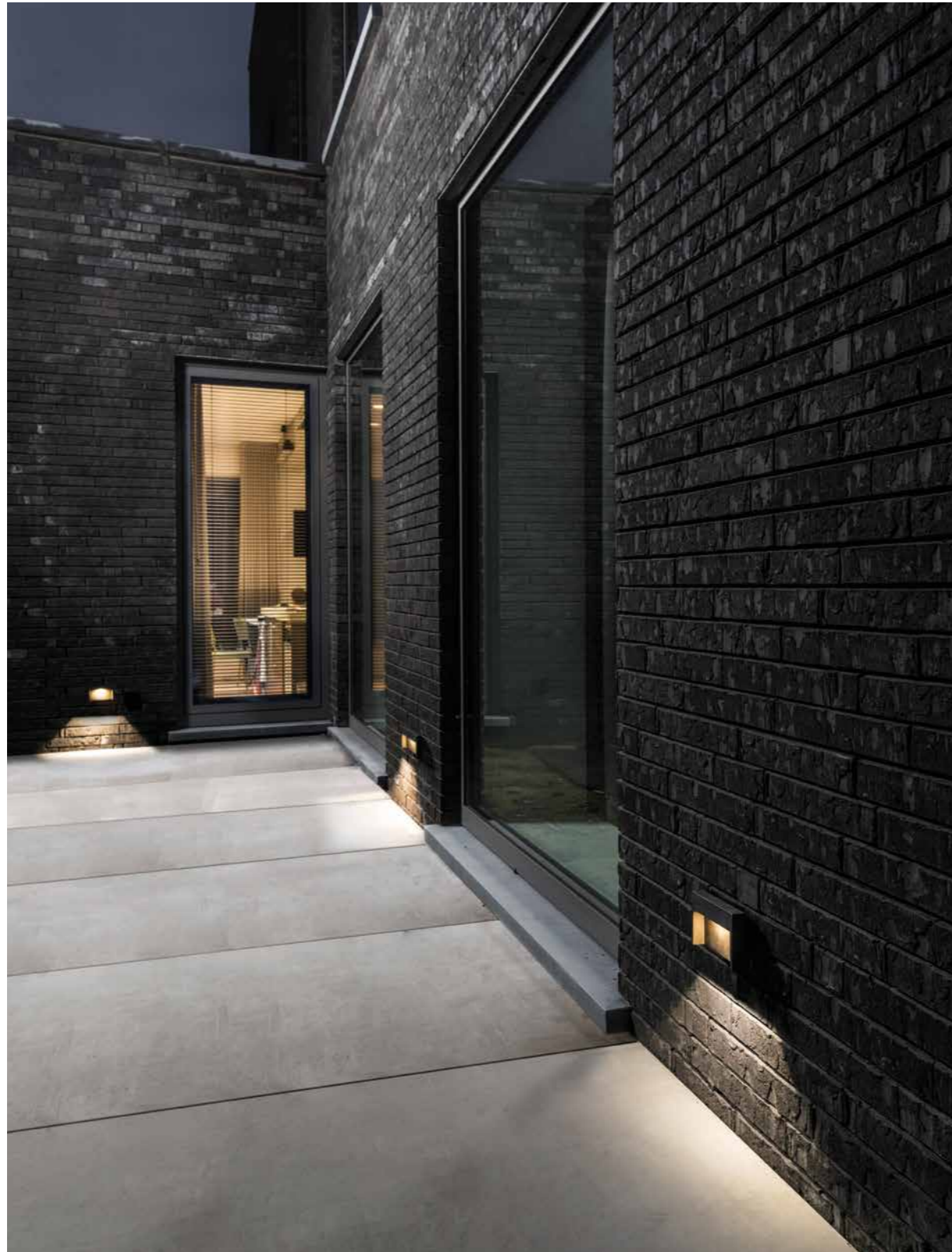

Private house Brugge

Guido

CREE XPE - 3,6W - 230V 50-60Hz AC
 282 lumen 2700K CRI80
 282 lumen 3000K CRI80
 dimmability: not dimmable

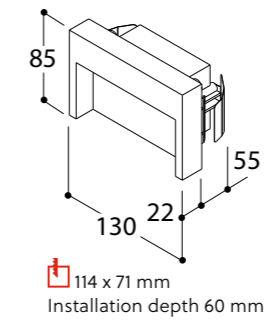

finish	2700K	3000K	€	
●	449026	449036	245,-	
●	449003	449013	245,-	
●	449023	449033	245,-	
! Frame for plaster	499077	29,-		116 x 73 x H 70 mm
! Box for plastered concrete	499097	49,-		128 x 78 x H 70 mm
! Box for visible concrete	499099	60,-		123 x 78 x H 70 mm





Private house Brussels

Hekowa Single Beam Spot WC

LUXEON M - 3,82W - 350mA DC - (10,95Vf)
 400 lumen 2700K CRI90
 429 lumen 3000K CRI90
 dimmability: PWM/CCR
 beam 36°

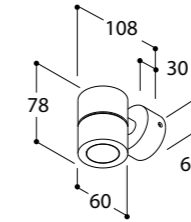

finish	2700K	3000K	€
●	473226	473236	237,-
●	473203	473213	237,-
●	473223	473233	237,-

Converter matrix, see back flap



exterior

Hekowa Single Beam Spot CI

LUXEON M - 3,82W - 230V 50-60Hz AC
 400 lumen 2700K CRI90
 429 lumen 3000K CRI90
 dimmability: mains dim LC
 beam 36°

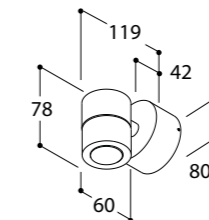

finish	2700K	3000K	€
●	473066	473076	275,-
●	473043	473053	275,-
●	473063	473073	275,-



Hekowa



Electra Palace Hotel Athens

Hekowa Up/down Spot WC

LUXEON M - (2X) 3,82W - 350mA DC - (2x 10,95 Vf)
 2x 400 lumen 2700K CRI90
 2x 429 lumen 3000K CRI90
 dimmability: PWM/CCR
 beam 36°

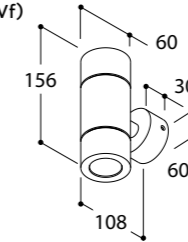

finish	2700K	3000K	€
●	473326	473336	378,-
●	473303	473313	378,-
●	473323	473333	378,-

Converter matrix, see back flap

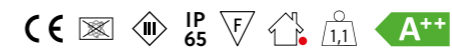

Hekowa Up/down Spot CI

LUXEON M - (2X) 3,82W - 230V 50-60HZ AC
 2x 400 lumen 2700K CRI90
 2x 429 lumen 3000K CRI90
 dimmability: mains dim LC
 beam 36°

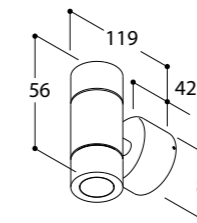

finish	2700K	3000K	€
●	473166	473176	416,-
●	473143	473153	416,-
●	473163	473173	416,-

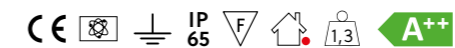

exterior

Hekowa

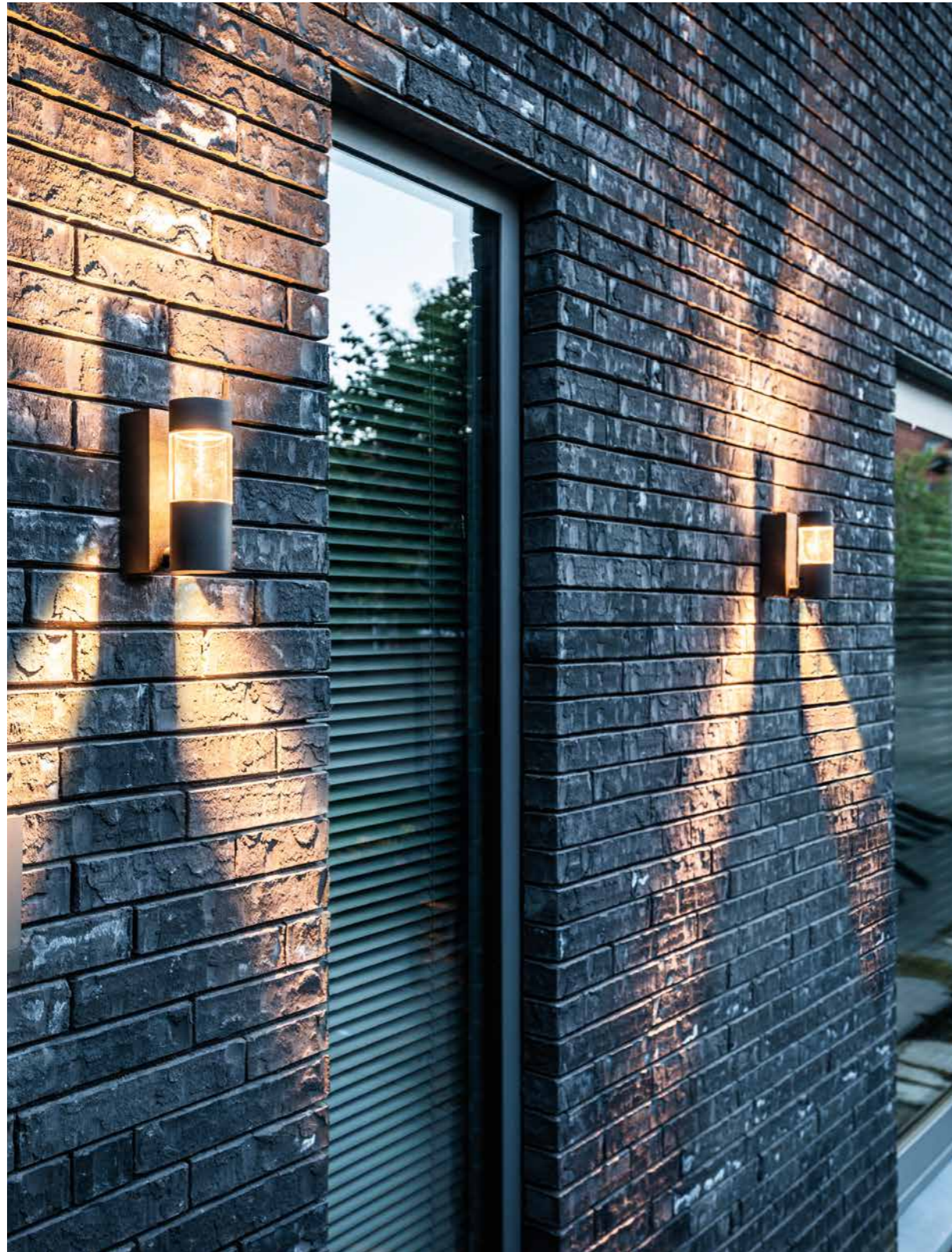

Private house Brugge

Hekowa Single Beam Beacon WC

LUXEON M - 3,82W - 350mA DC - (10,95Vf)
 400 lumen 2700K CRI90
 429 lumen 3000K CRI90
 dimmability: PWM/CCR
 beam

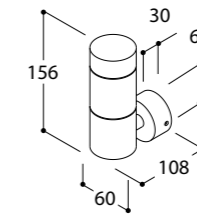

finish	2700K	3000K	€
●	473726	473736	399,-
●	473703	473713	399,-
●	473723	473733	399,-

Converter matrix, see back flap



Hekowa Single Beam Beacon CI

LUXEON M - 3,82W - 230V 50-60Hz AC
 400 lumen 2700K CRI90
 429 lumen 3000K CRI90
 dimmability: mains dim LC
 beam

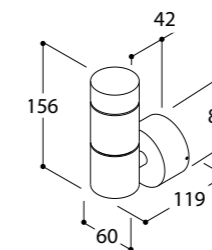

finish	2700K	3000K	€
●	473566	473576	437,-
●	473543	473553	437,-
●	473563	473573	437,-

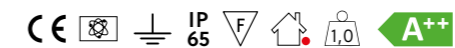



Garden 411

Max WC

LUXEON M - 3,82W - 350mA DC - (10,95 Vf)

400 lumen 2700K CRI90
 429 lumen 3000K CRI90
 dimmability: PWM/CCR
 beam 36°

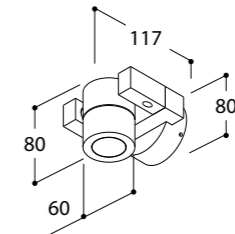

finish	2700K	3000K	€
●	474226	474236	459,-
●	474203	474213	459,-
●	474223	474233	459,-
! Groundpin	260990		58,-

! Converter matrix, see back flap

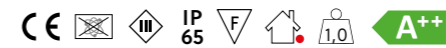

exterior

Max CI

LUXEON M - 3,82W - 230V 50-60Hz AC

400 lumen 2700K CRI90
 429 lumen 3000K CRI90
 dimmability: not dimmable
 beam 36°

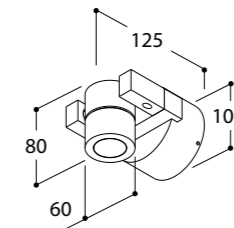

finish	2700K	3000K	€
●	474026	474036	468,-
●	474003	474013	468,-
●	474023	474033	468,-
! Groundpin	260990		58,-



Max



Private house Wortegem-Petegem

Brix Single Beam IP65

LUXEON M - 3,82W - 230V 50-60Hz AC
 400 lumen 2700K CRI90
 429 lumen 3000K CRI90
 dimmability: dimmable L,C
 beam 70°
 up or down

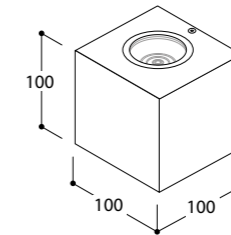

finish	2700K	3000K	€
●	260941	260931	305,-
●	260943	260933	305,-
●	260947	260937	305,-

Family members:

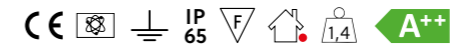

Brix Up/down IP65

LUXEON M - (2X) 3,82W - 230V 50-60HZ AC
 2x 400 lumen 2700K CRI90
 2x 429 lumen 3000K CRI90
 dimmability: dimmable L,C
 beam 70°
 up/down

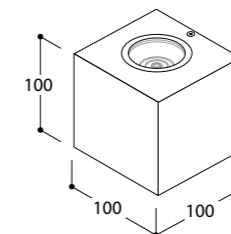

finish	2700K	3000K	€
●	260942	260932	401,-
●	260946	260936	401,-
●	260944	260934	401,-

Family members:





Private house

Heb Nxt

CLARA AC - 10W - 230V 50-60Hz AC
 1050 lumen 2700K CRI90
 1050 lumen 3000K CRI80
 dimmability: not dimmable

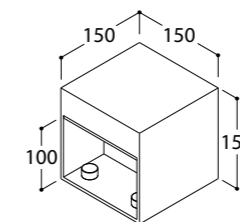

finish	2700K	3000K	€
●	150776	150076	465,-
●	150783	150083	465,-
●	150773	150073	465,-
! Groundpin large	260991		65,-

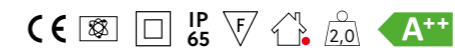

Heb Nxt

exterior



Hertog Jan Zedelgem

Menhir 250

A60 - MAX 40W - 230V 50-60Hz AC
 E27
 dimmability: dependent on bulb

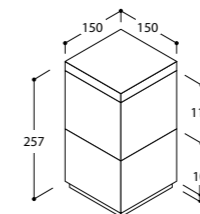

finish		€
●	360526	363,-
●	360533	363,-
●	360530	363,-
! Groundpin	260992	62,-

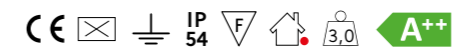

Menhir 250

exterior



Private house Wevelgem

Menhir 600

A60 - MAX 40W - 230V 50-60HZ AC
E27
dimmability: dependent on bulb

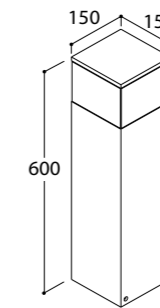

finish		€
●	360726	422,-
●	360734	422,-
●	360764	422,-
ⓘ	Groundpin large 260991	65,-



Menhir 600

exterior



Private house Brugge

Pulsar Pin

LUXEON M - 3,82W - 230V 50-60HZ AC
 400 lumen 2700K CRI90
 429 lumen 3000K CRI90
 dimmability: mains dim LC

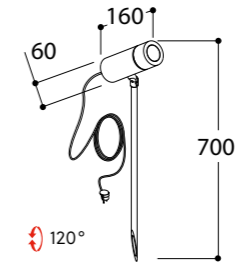

finish	2700K			3000K			€
	9°	38°	60°	9°	38°	60°	
●	352126	352226	352326	352136	352236	352336	335,-
●	352103	352203	352303	352113	352213	352313	335,-
●	352123	352223	352323	352133	352233	352333	335,-



Pulsar Base

LUXEON M - 3,82W - 230V 50-60Hz AC
 400 lumen 2700K CRI90
 429 lumen 3000K CRI90
 dimmability: mains dim LC

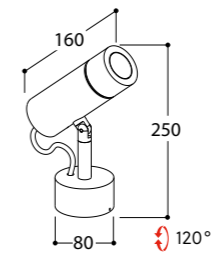

finish	2700K			3000K			€
	9°	38°	60°	9°	38°	60°	
●	352426	352526	352626	352436	352536	352636	283,-
●	352403	352503	352603	352413	352513	352613	283,-
●	352423	352523	352623	352433	352533	352633	283,-
ⓘ	Groundpin	260990					58,-



Pulsar

exterior

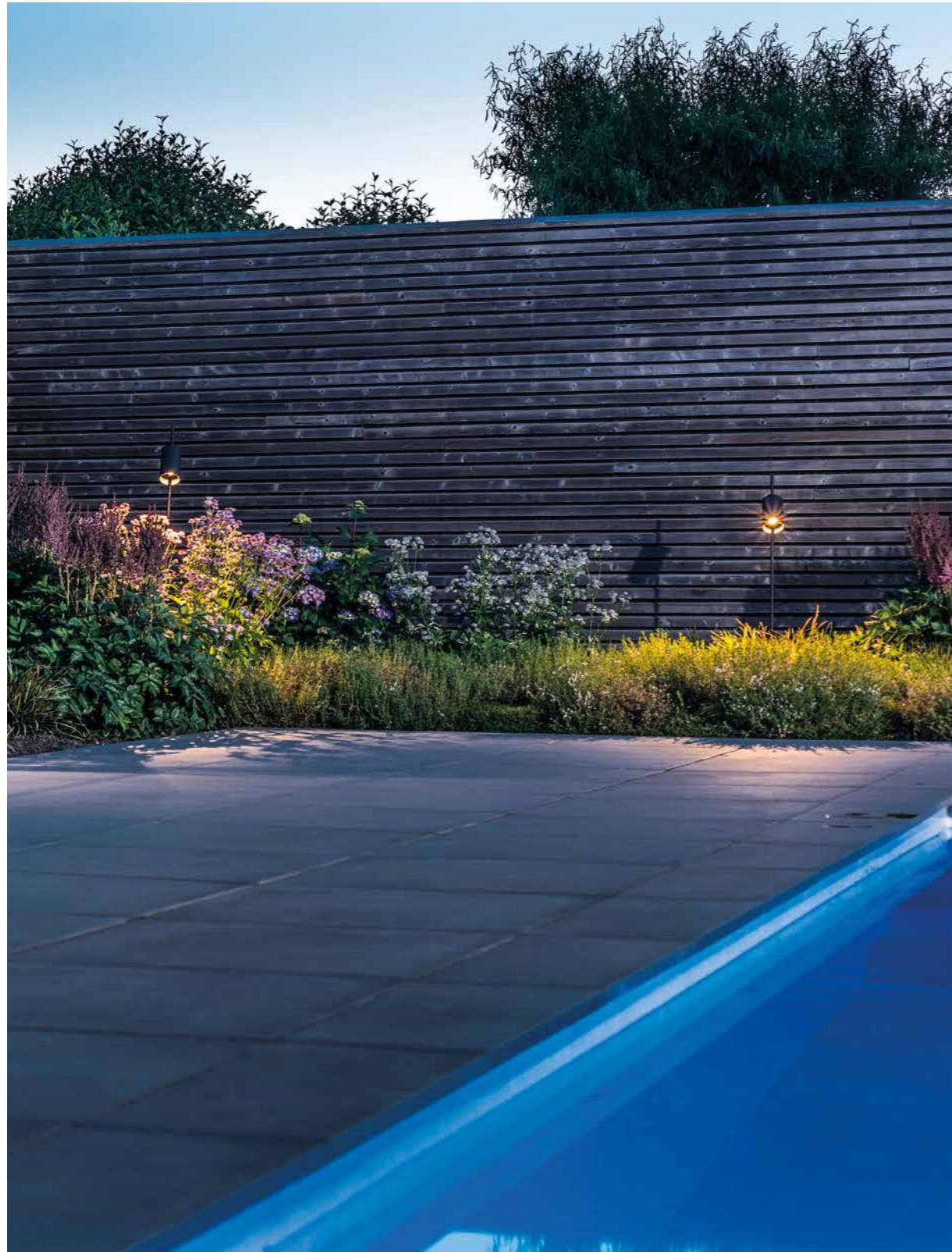

Private house Zedelgem

Roseau Pin

LUXEON M - 3,82W - 230V 50-60Hz AC

400 lumen 2700K CRI90

429 lumen 3000K CRI90

dimmiability: not dimmable

beam 60°

finish	2700K	3000K	€
●	416126	416136	355,-
●	416103	416113	355,-
●	416123	416133	355,-

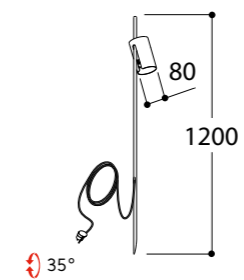

Roseau Pin

exterior

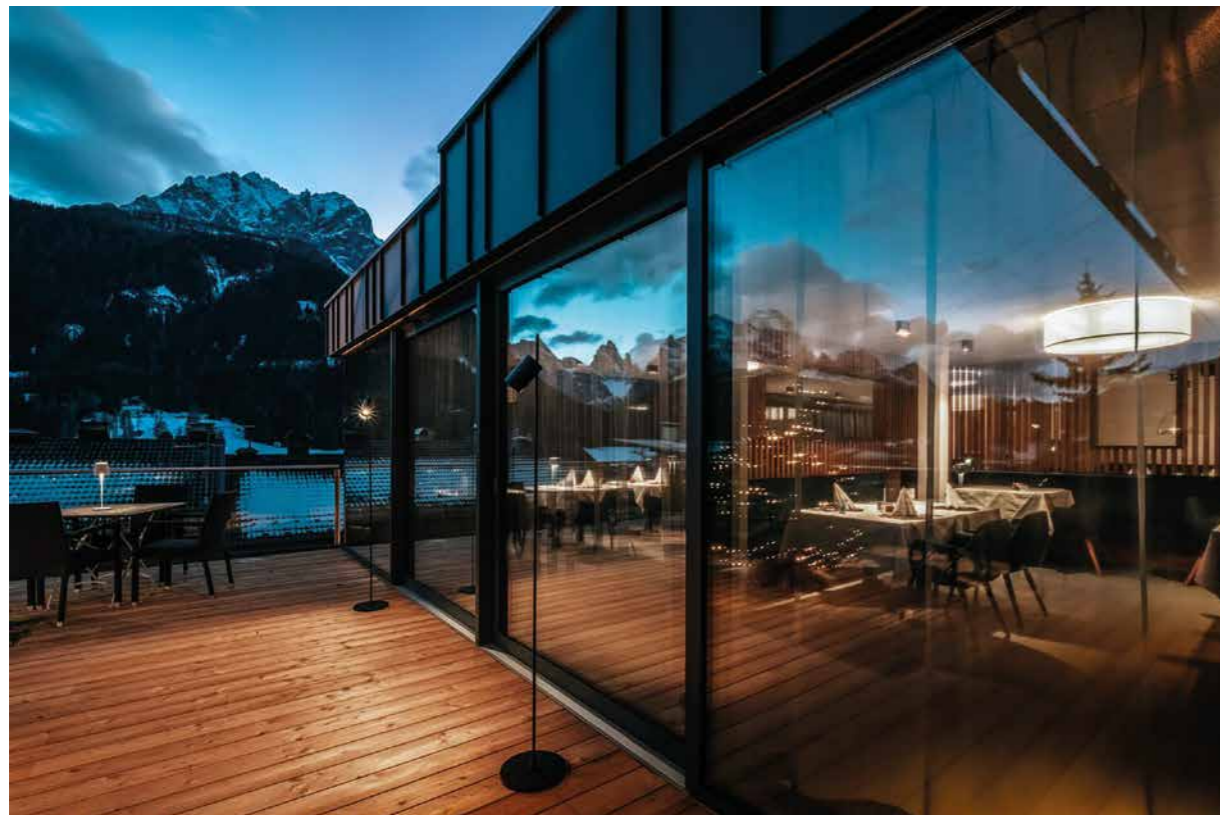

Hotel Gruber Sexten

Roseau Floor 1350

LUXEON M - 3,82W - 230V 50-60Hz AC

400 lumen 2700K CRI90
 429 lumen 3000K CRI90
 dimmability: not dimmable
 beam 60°

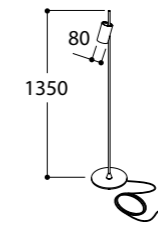

finish	2700K	3000K	€
●	416226	416236	540,-
●	416203	416213	540,-
●	416223	416233	540,-

↕ 35°



Roseau Floor 1700

LUXEON M - 3,82W - 230V 50-60Hz AC

400 lumen 2700K CRI90
 429 lumen 3000K CRI90
 dimmability: not dimmable
 beam 60°

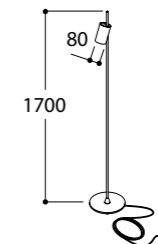

finish	2700K	3000K	€
●	416326	416336	555,-
●	416303	416313	555,-
●	416323	416333	555,-

↕ 35°

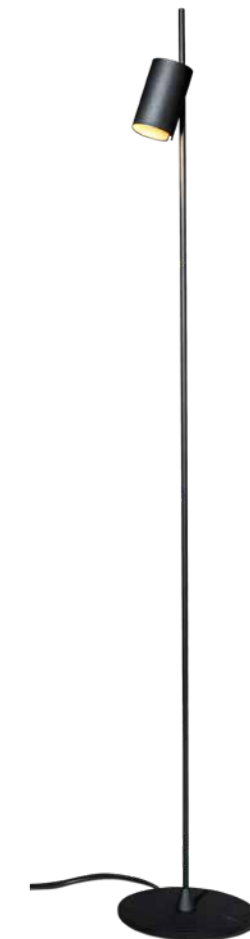

Roseau Floor

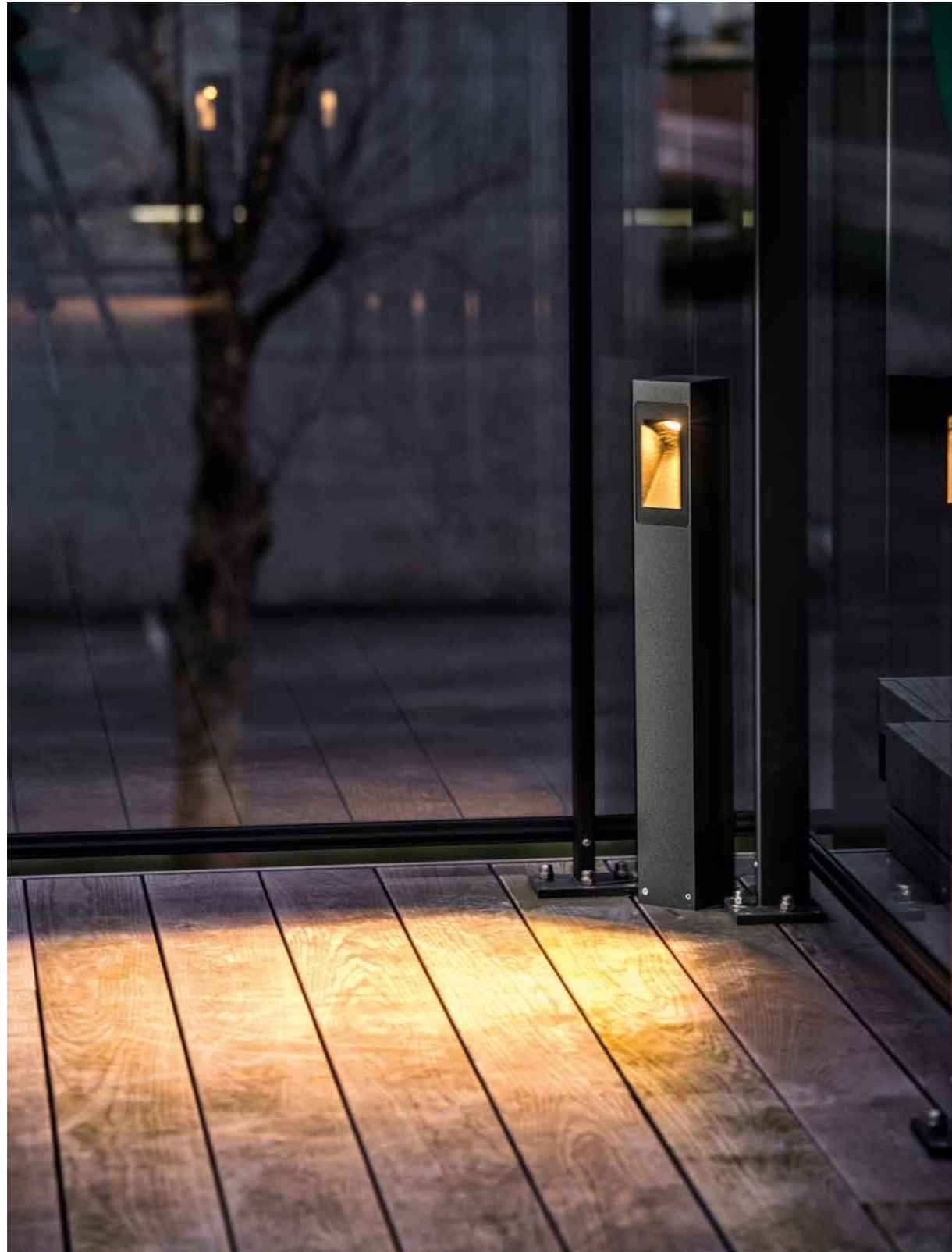

Private house Pittem

Guardian 295

LUXEON M - 3,82W - 230V 50-60Hz AC

400 lumen 2700K CRI90
 429 lumen 3000K CRI90
 dimmability: not dimmable
 beam 36°

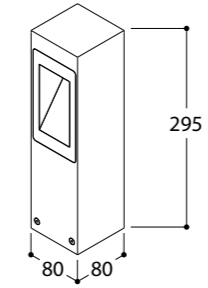

finish	2700K	3000K	€
●	431226	431626	281,-
●	431203	431603	281,-
●	431223	431623	281,-
! Groundpin	260992		62,-



Guardian 595

LUXEON M - 3,82W - 230V 50-60Hz AC

400 lumen 2700K CRI90
 429 lumen 3000K CRI90
 dimmability: not dimmable
 beam 36°

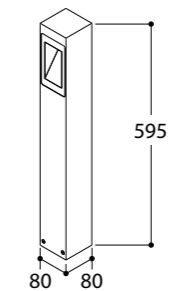

finish	2700K	3000K	€
●	431326	431726	363,-
●	431303	431703	363,-
●	431323	431723	363,-
! Groundpin	260992		62,-



Guardian

exterior

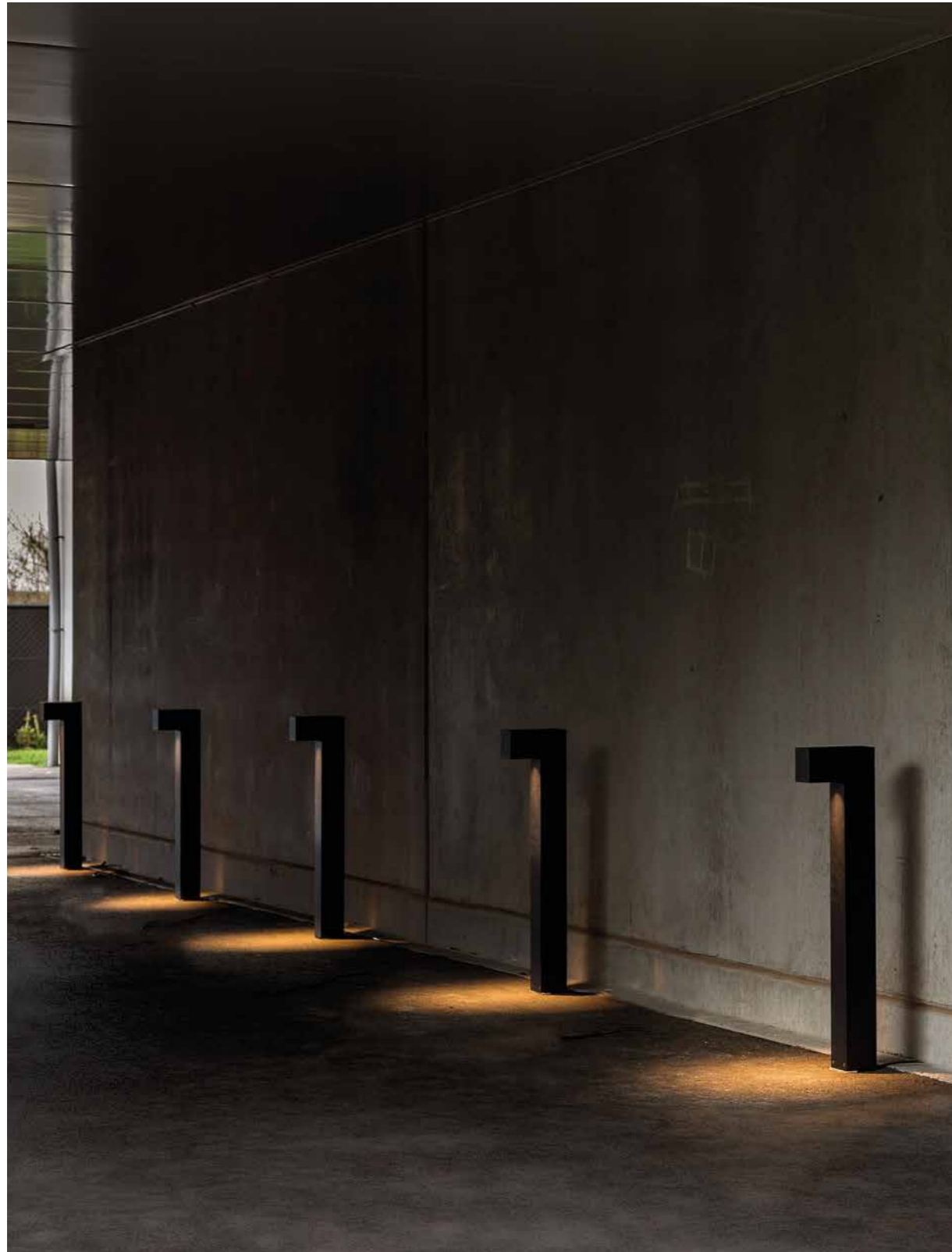

Private house Zwevegem

Bernard 350

LUXEON M - 3,82W - 230V 50-60Hz AC
 400 lumen 2700K CRI90
 429 lumen 3000K CRI90
 dimmability: not dimmable
 beam 36°

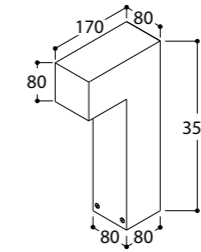

finish	2700K	3000K	€
●	454026	454226	323,-
●	454003	454203	323,-
●	454023	454223	323,-
! Groundpin	260992		62,-



Bernard 750

LUXEON M - 3,82W - 230V 50-60Hz AC
 400 lumen 2700K CRI90
 429 lumen 3000K CRI90
 dimmability: not dimmable
 beam 36°

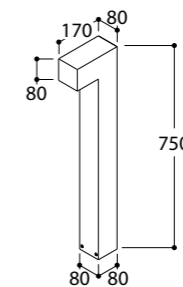

finish	2700K	3000K	€
●	454126	454326	357,-
●	454103	454309	357,-
●	454123	454323	357,-
! Groundpin	260992		62,-

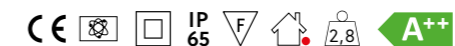

Bernard

exterior

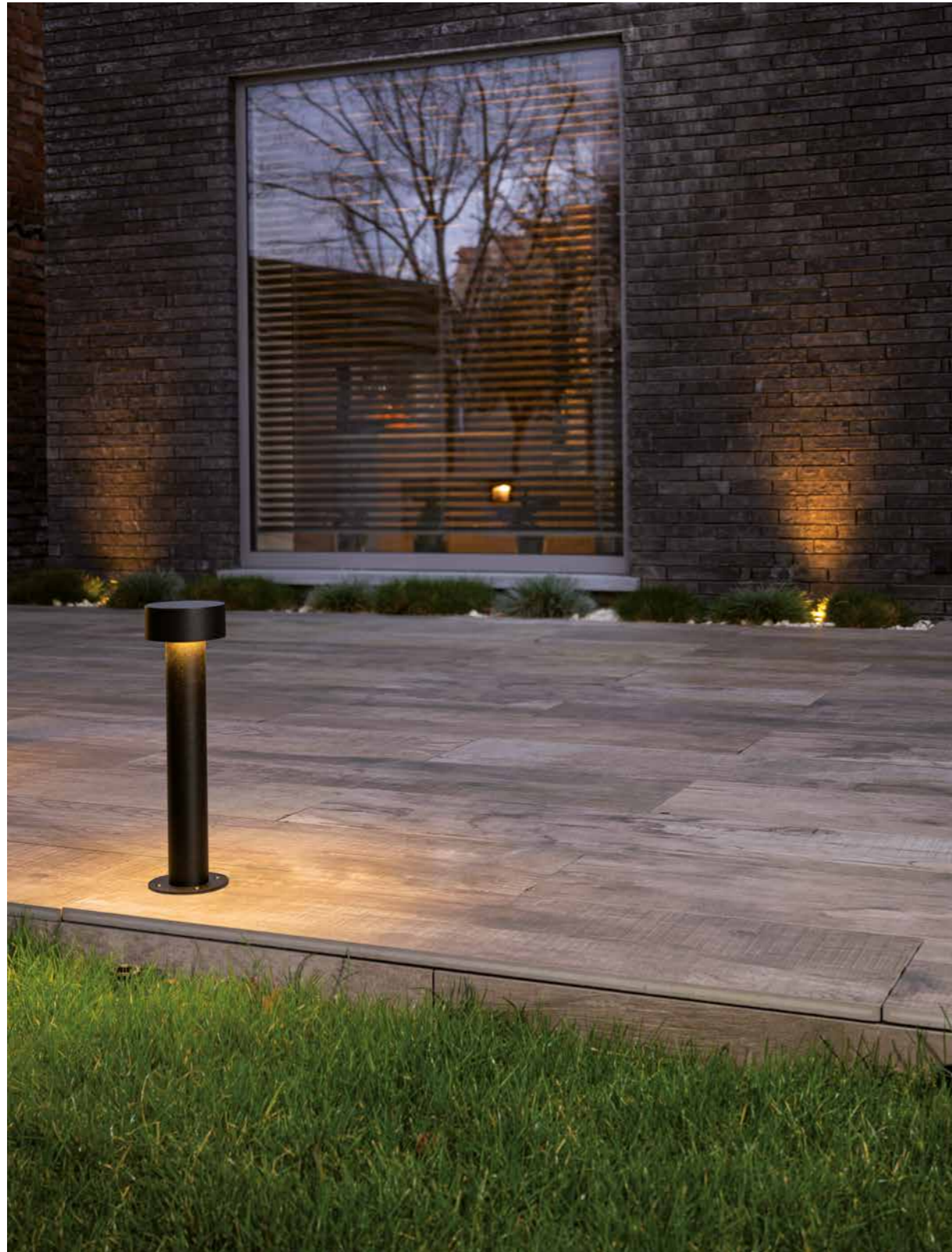

Private house Brugge

Hedge 400 CI

LED ARRAY - 8,8W - 230V 50-60HZ AC
 1026 lumen 3000K CRI80
 dimmability: mains dim LC
 beam 85°

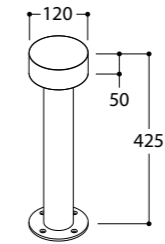

finish	3000K	€
●	478136	391,-
●	478113	391,-
●	478133	391,-
! Groundpin	260990	58,-



Hedge 700 CI

LED ARRAY - 8,8W - 230V 50-60Hz AC
 1026 lumen 3000K CRI80
 dimmability: mains dim LC
 beam 85°

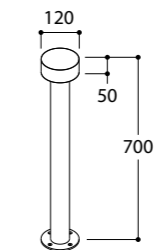

finish	3000K	€
●	478236	422,-
●	478213	422,-
●	478233	422,-
! Groundpin	260990	58,-



Hedge

exterior



Private house Brugge

Tootem 500 Beacon

LUXEON M - 3,82W - 230V 50-60Hz AC

400 lumen 2700K CRI90

429 lumen 3000K CRI90

dimmiability: not dimmable

beam

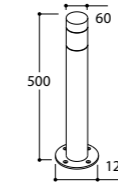

finish	2700K	3000K	€
●	476526	476536	459,-
●	476503	476513	459,-
●	476523	476533	459,-
! Groundpin	260990		58,-



Tootem 1000 Beacon

LUXEON M - 3,82W - 230V 50-60Hz AC

400 lumen 2700K CRI90

429 lumen 3000K CRI90

dimmiability: not dimmable

beam

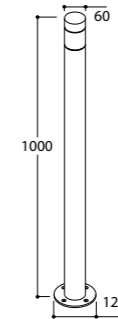

finish	2700K	3000K	€
●	477526	477536	493,-
●	477503	477513	493,-
●	477523	477533	493,-
! Groundpin	260990		58,-



exterior



Tootem

profiles



1U	336
1U Flush	343
1U IP65	347
1U Slim	348
1U Wall	354
2U	358
2U Recessed	374
Boriti	388
Ductor	396
Ludo	400
Oscar	414
Protut	430
Taglio	438



PROFILE SYSTEMS ALWAYS MADE TO MEASURE.
Prices of profile components: see price list

Profile/m

finish	
○	952047
●	952012
●	952026



Straight Connection

Straight connection	952060
---------------------	--------



Endcap

finish	
○	952247
●	952212
●	952226

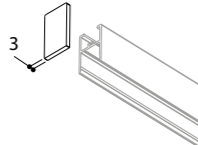

Corner

Corner 90°	952070
Corner 135°	952080
Corner on request	952090

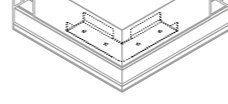

Diffuser/m

Polycarbonate Diffuser	952006
------------------------	--------

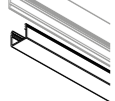

Mounting springs for surface installation

Spring	952905
--------	--------



i 2 mounting springs per m

i Section view

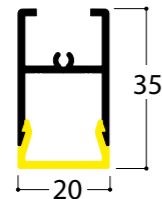

i Fixation on ceiling or wall

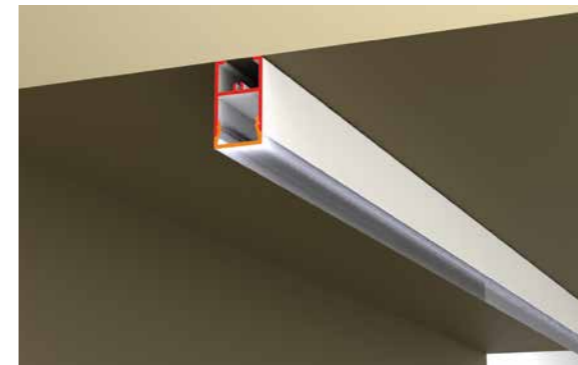
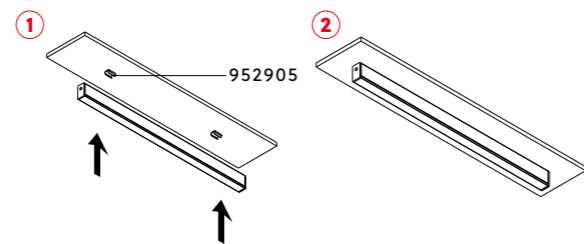

Module Ledline/m

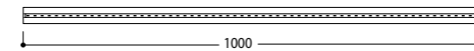

24V DC

i polycarbonate diffuser included

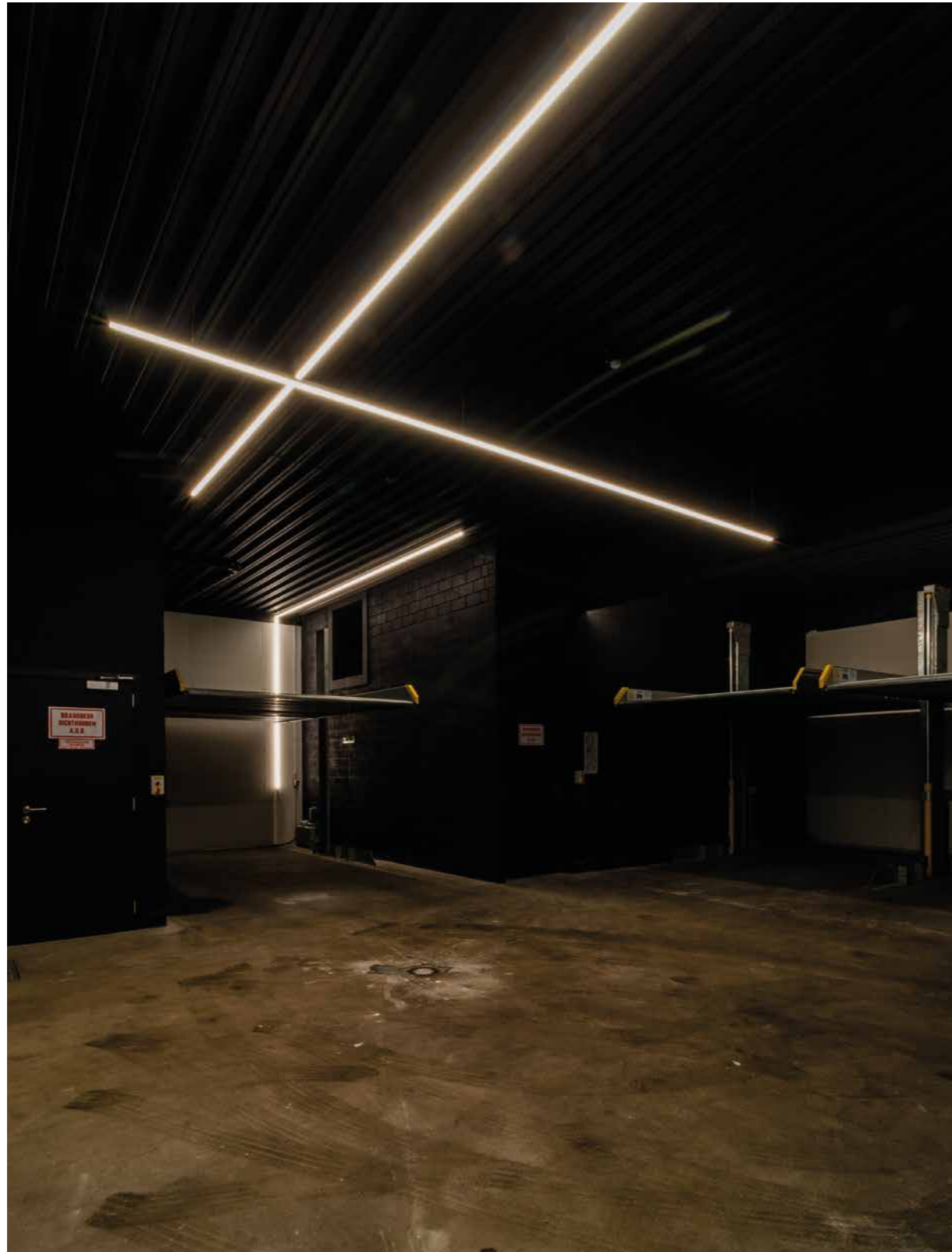

color temperature	2700K			3000K			4000K		
	medium power	high power	very high power	medium power	high power	very high power	medium power	high power	very high power
REFERENCE	952211	952251	952311	952221	952261	952321	952231	952271	952331
power	9,6W/m	14,4W/m	19,2W/m	9,6W/m	14,4W/m	19,2W/m	9,6W/m	14,4W/m	19,2W/m
lumen output	672 lm/m	1010 lm/m	2208lm/m	710 lm/m	1060 lm/m	2208lm/m	740 lm/m	1100 lm/m	2323lm/m
CRI	92	92	92	92	92	92	92	92	92
max. length 1 powerfeed	5 metres	5 metres	5 metres	5 metres	5 metres	5 metres	5 metres	5 metres	5 metres
min. cutting length	50 mm	33,33 mm	33,33 mm	50 mm	33,33 mm	33,33 mm	50 mm	33,33 mm	33,33 mm

i Converter matrix, see back flap



Korpoort Ghent



Suspension Single

finish	2,25m	4 m	6 m
	952041	952021	952051
	952040	952020	952050
	952042	952022	952052

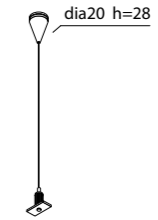
i 1 suspension/ 1,5 m profil
min. 2 suspensions



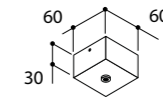

Connection Set Square

finish	2 P		
	2,25 m	4 m	6 m
	691050	691150	691250
	691039	691139	691239



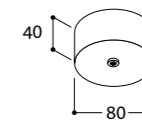

Connection Set Round

finish	2 P		
	2,25 m	4 m	6 m
	691049	691149	691249
	691038	691138	691238



Connection Set Kosmos (recessed)

finish	2P		
	2,25 m	4m	6 m
	691048	691148	691248
	691037	691137	691237

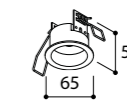

i 56 mm
Installation depth 60 mm

i Can be used as access point for converter

i Can be used as access point for converter



Korpoort Ghent

How to compose 1U

REQUEST CUSTOMER

SLIM PROFILE 2 M
 WHITE COLOR
 LED 2700K HP 24V
 INSTALLED ON CEILING

+ CONVERTOR

TAL

Orderform

REF	DESCRIPTION	PCS/M
952047	PROFILE TEXT WHITE	2
952247	ENDCAP TEXT WHITE	2
952251	MODULE LEDLINE 2700 HP	2
952905	MOUNTING SPRING	3
40070	CONVERTER 35W 24V	1

Drawing

TOP VIEW

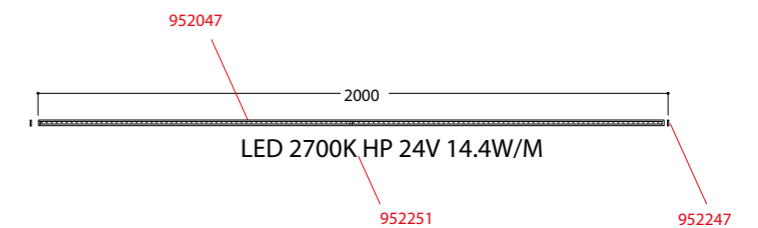

Section view

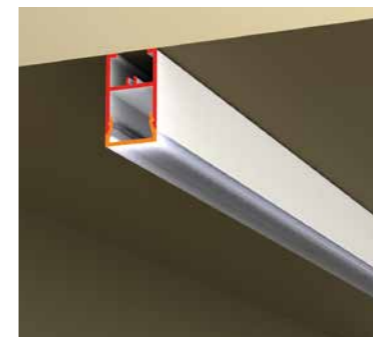
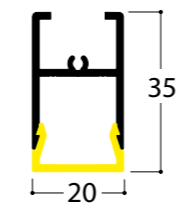



Private house Hasselt

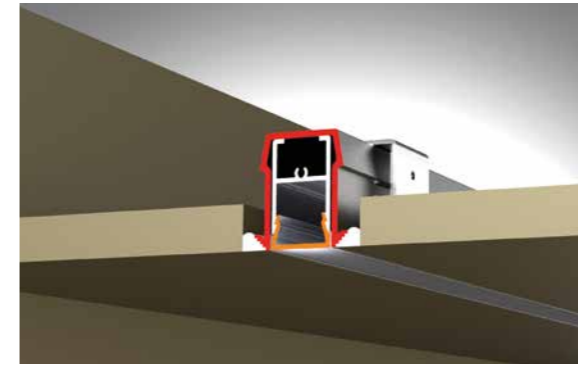

Plaster Profile/ m

finish
● 952035

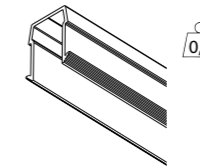

Profile for recessed installation of 1U

Straight configuration
Length of profile 952035:
< 5 m = X + 8mm
< 10 m = X + 9mm
> 10 m = X + 12mm
X = Length of 1U profile excl. endcaps

L - configuration
Length of profile 952035:
< 5 m = X + 5mm on both sides
< 10 m = X + 6mm on both sides
> 10 m = X + 8mm on both sides
X = Length of 1U profile excl. endcaps

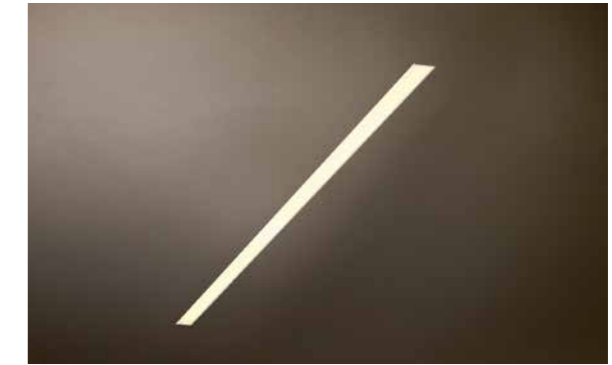

Endcap for plaster profile

finish
● 952235

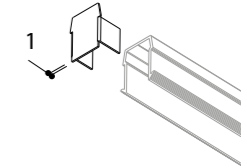

Mounting brackets for recessed installation

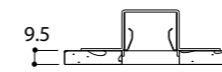

9,5 MM

952900

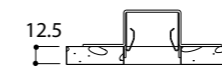

12,5 MM

952901

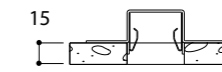

15 MM

952902

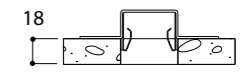

18MM

952903

2 mounting brackets per m (type according to ceiling thickness)

Section view

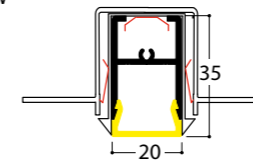

Plasterprofile
• 1U profile to be added
• see installation manual for installation tolerances

Cut out dimensions

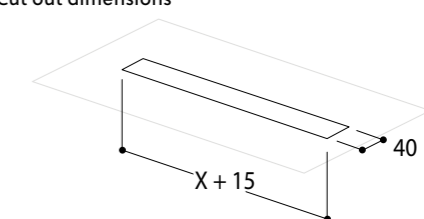

X = Length of profile (measured without endcaps)
Installation depth: 50 mm

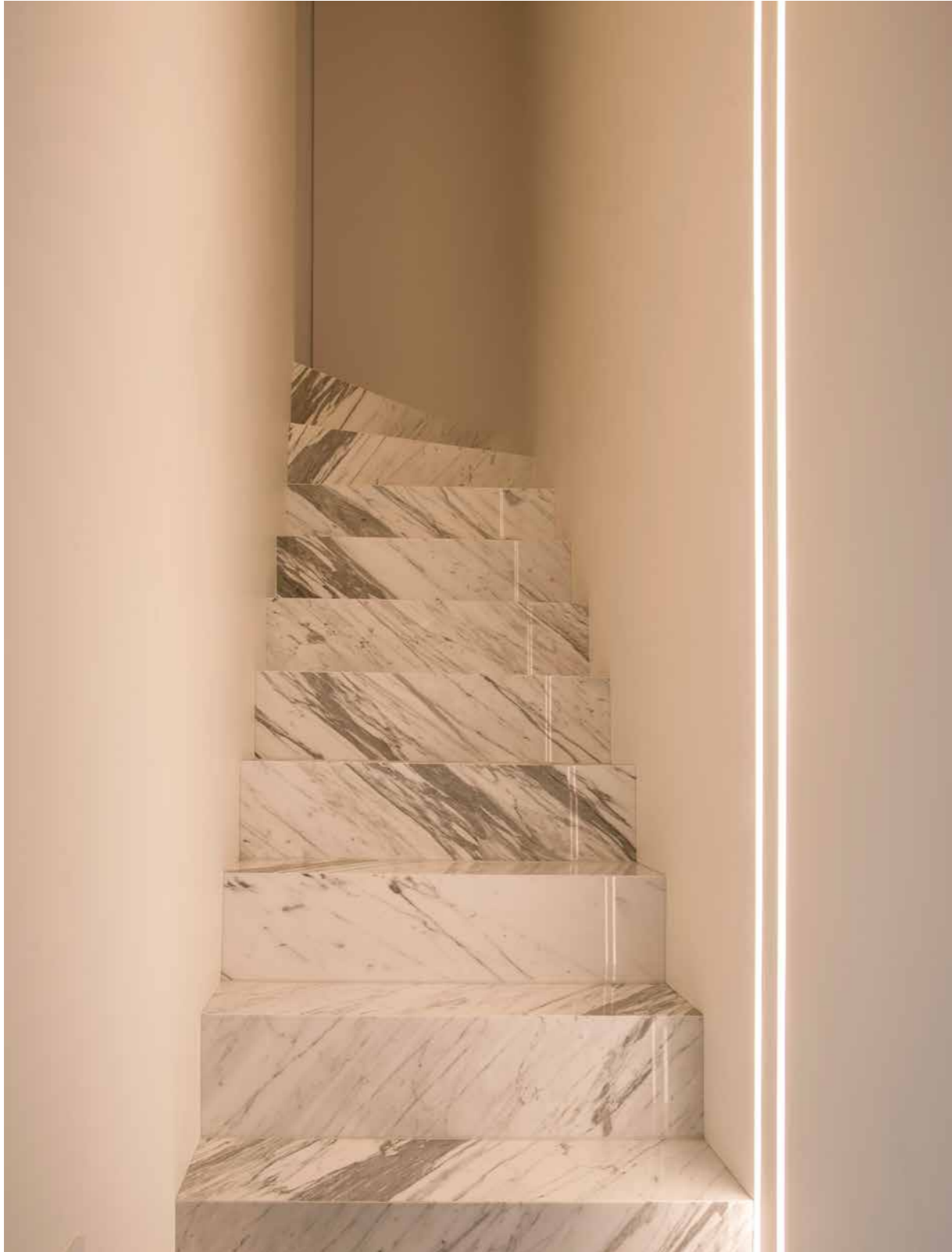

Private house Hasselt

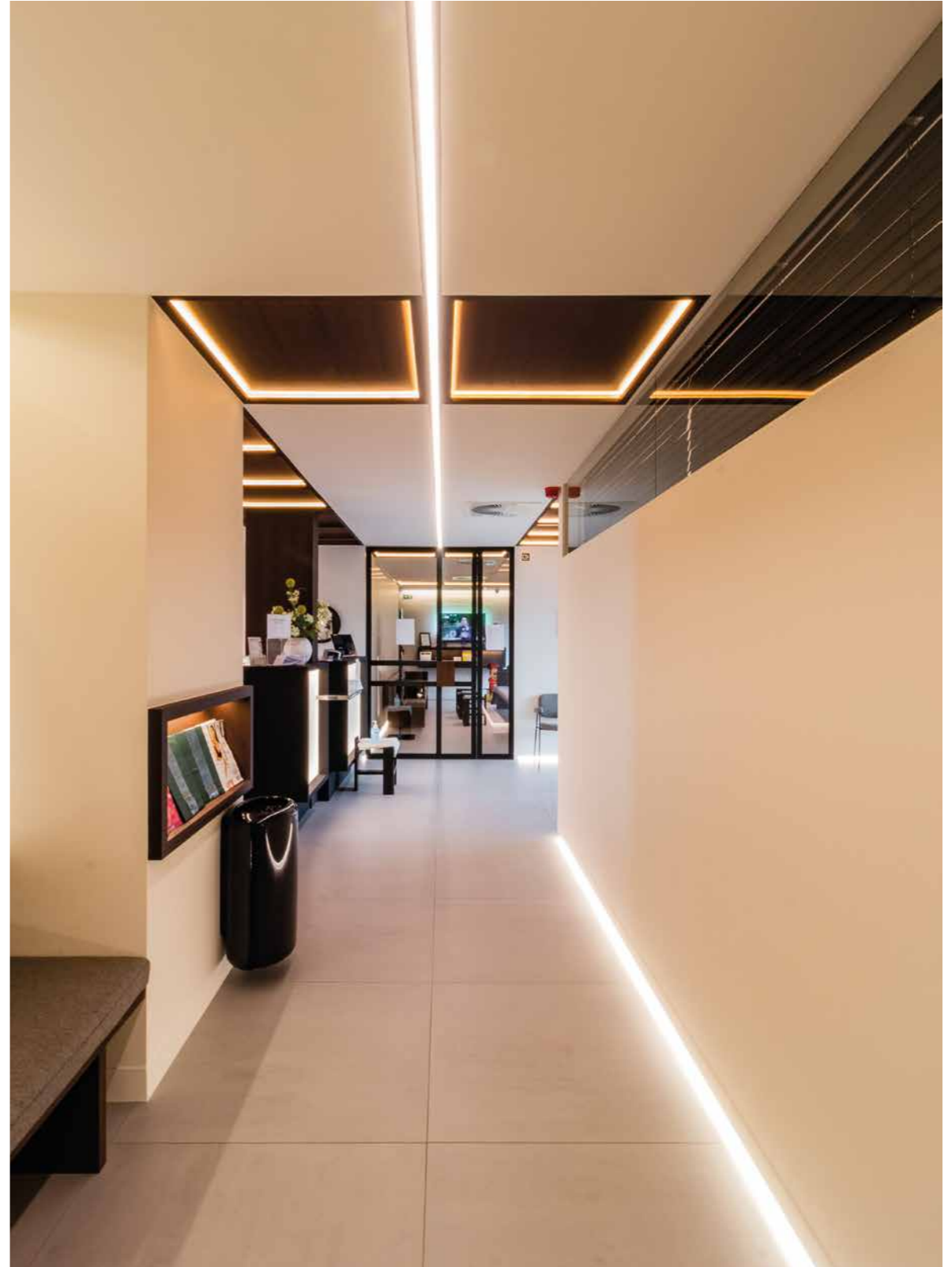

Oogcentrum Tiel

Profile/m

finish	
○	952047
●	952026



Straight Connection

Straight connection	952060
---------------------	--------



Endcap

finish	
○	952247
●	952226

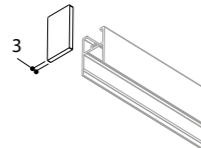

Corner

Corner 90°	952070
Corner 135°	952080
Corner on request	952090



Diffuser/m

Polycarbonate Diffuser	952006
------------------------	--------

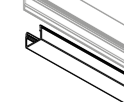

Mounting springs for surface installation

Spring	952905
--------	--------

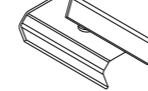

3 mounting springs per m

Section view

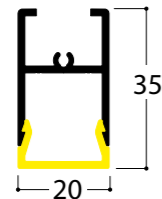

Fixation on ceiling or wall

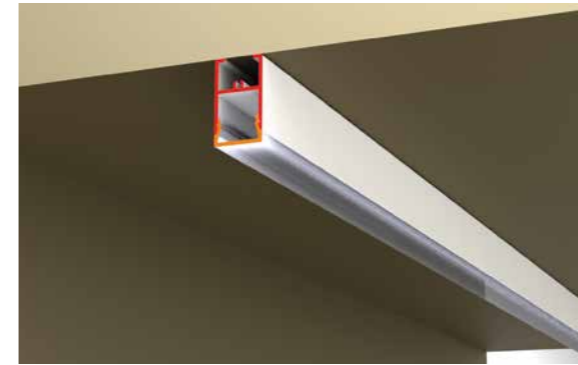
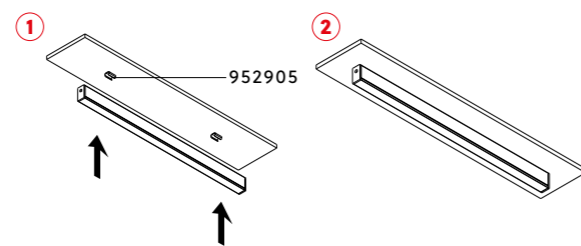

Only electrical part is IP65, mechanical components remain IP40.
Horizontal surface mounted installation under canopy only.
Max. section length = 4 metres



Module Ledline/m

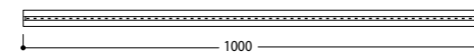

24V DC



polycarbonate diffuser included

color temperature	3400K*		4000K*	
	medium power	high power	medium power	high power
REFERENCE	952213	952253	952223	952263
power	9,6W/m	14,4W/m	9,6W/m	14,4W/m
lumen output	672 lm/m	1010 lm/m	710 lm/m	1060 lm/m
CRI	92	92	92	92
max. length 1 powerfeed	5 metres	5 metres	5 metres	5 metres
min. cutting length	50 mm	33,33 mm	50 mm	33,33 mm

*slight differences in colour temperature can occur due to resin

Converter matrix, see back flap

Profile/m

finish	
○	954047
●	954026
●	954012

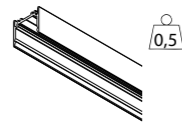

Max. length in combination with ledline = 5 metres

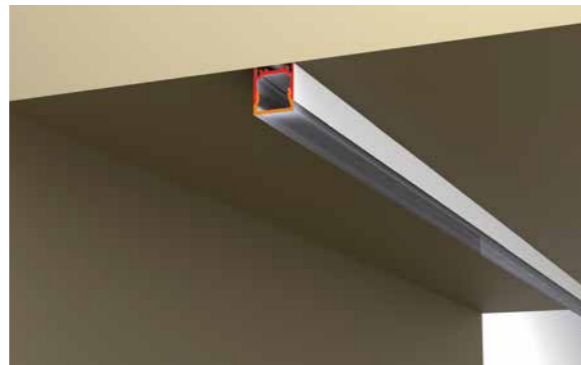

Endcap

finish	
○	954247
●	954226
●	954212

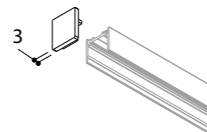

Diffuser/m

Polycarbonate Diffuser 952006

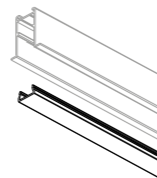

Module Ledline/m

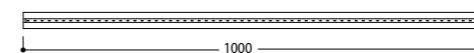

24V DC



polycarbonate diffuser included

Endcap for side entry

finish	
○	954347
●	954326
●	954312

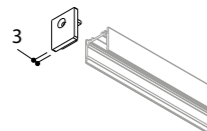

Mounting springs for surface installation

Spring 954905

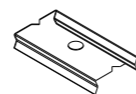

Minimum 2 mounting springs per metres

Section view with springs

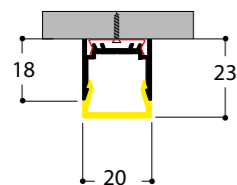

ledline= length of profile - 10mm *

Section view without springs

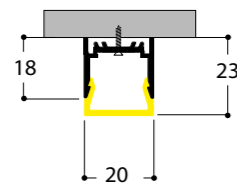

maximum length between 2 screws is 1.8m ledline= length of profile - 40mm **

Fixation on surface

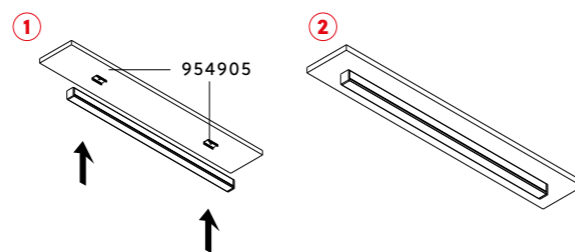

Multiple possibilities

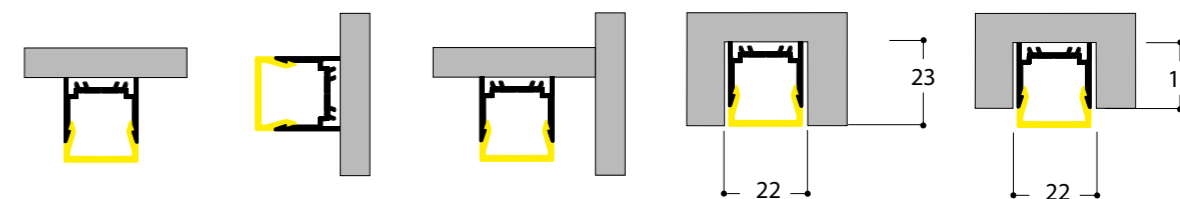

Converter matrix, see back flap

color temperature	2700K		3000K		4000K	
	medium power	high power	medium power	high power	medium power	high power
REFERENCE	952211	952251	952221	952261	952231	952271
power	9,6W/m	14,4W/m	9,6W/m	14,4W/m	9,6W/m	14,4W/m
lumen output	672 lm/m	1010 lm/m	710 lm/m	1060 lm/m	740 lm/m	1100 lm/m
CRI	92	92	92	92	92	92
max. length 1 powerfeed	5 metres	5 metres	5 metres	5 metres	5 metres	5 metres
min. cutting length	50 mm	33,33 mm	50 mm	33,33 mm	50 mm	33,33 mm

A. Installation with springs

1 Recommended for hollow ceiling, wall or cabinet

- 1 Fix the mounting springs with the correct plugs + washers to the ceiling. Make sure they are carefully lined up. Min. 2 mounting springs per meter.
- 2 Connect power supply with 1U Slim in the false ceiling or wall.

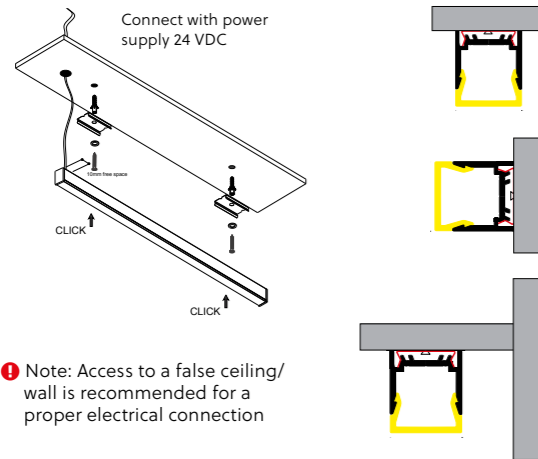

B. Installation for cove lighting

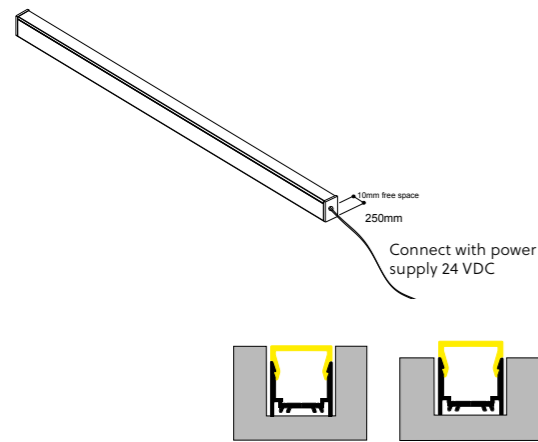

C. Installation without springs

1 Only for hollow ceiling, wall or cabinet

- 1 Remove diffuser
- 2 Drill holes for mounting. 20mm free space is provided at the end of both sides of the profile. Recommended screws, plug and drill hole dimensions depending on surface type.

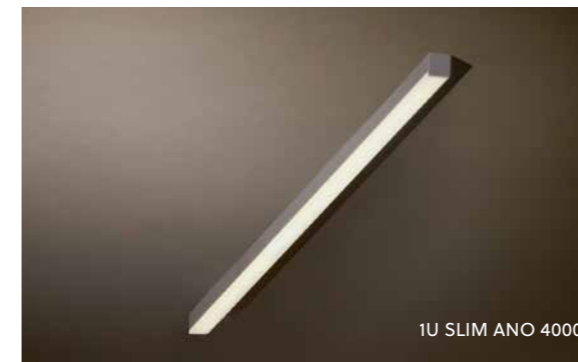
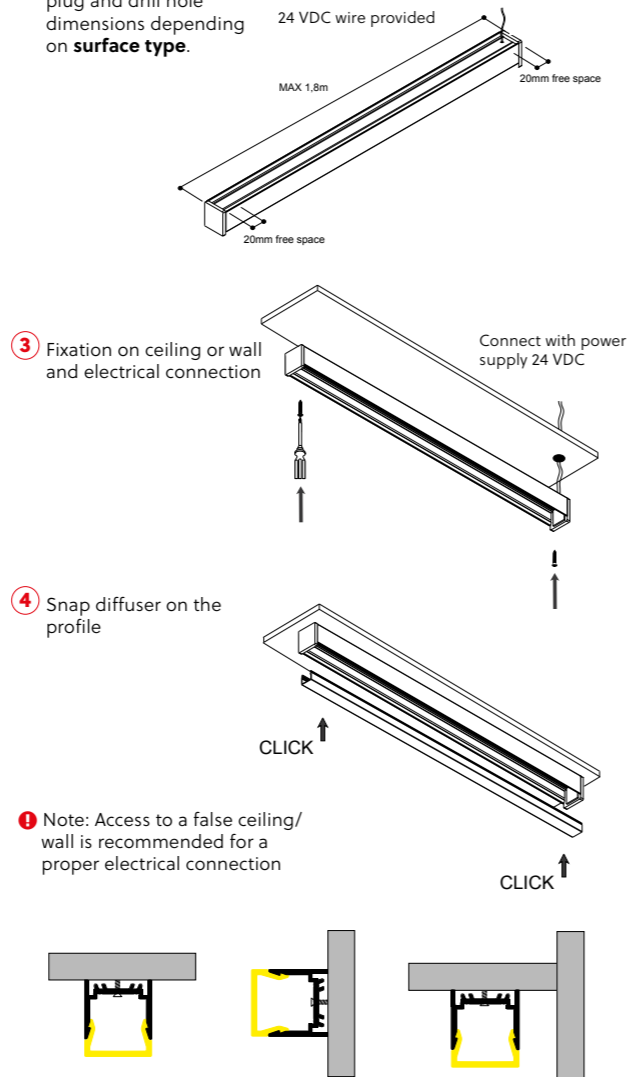

Private house Kinrooi

1U Slim

profiles



Private house Hasselt

How to compose 1U Slim

REQUEST CUSTOMER

VERY SLIM PROFILE APPROX. 2M
 BLACK COLOR
 WARM WHITE (RESIDENTIAL)
 CEILING MOUNTED

+ CONVERTER (REMOTE)

TAL

Orderform

REF	DESCRIPTION	PCS/M
954026	1U SLIM PROFILE TEXTURED BLACK	1,96
952211	LEDLINE 2700K MEDIUM POWER	1,95
952210	ENDCAP TEXTURED BLACK	2
954905	MOUNTING SPRING	3
952006	DIFFUSER	0,01
40057	CONVERTER 230V 24V 20VA	1

Drawing

Section view

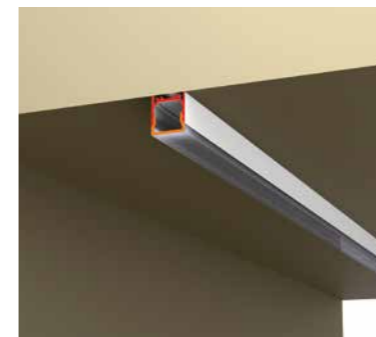
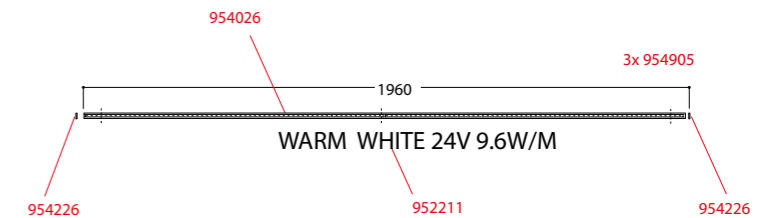
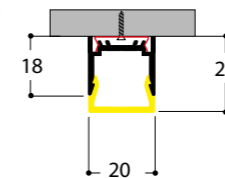

Profile/m

finish	
○	955047
●	955026
●	955012

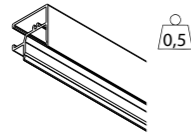

Endcap left

finish	
○	955248
●	955227
●	955213

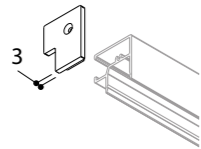

Diffuser/m

Polycarbonate Diffuser 952006

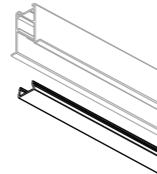

Endcap right

finish	
○	955247
●	955226
●	955212

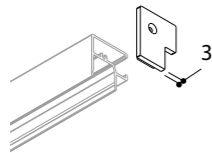

Mounting springs for surface installation

Spring 952905

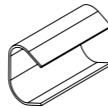

Minimum 2 mounting springs per 0,6 meter

Section view

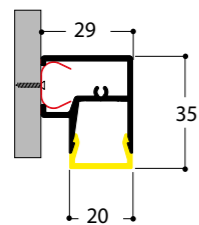

Fixation on wall

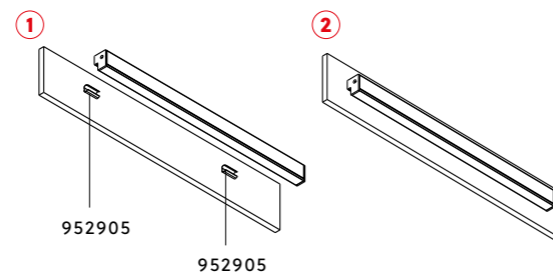

Module Ledline/m

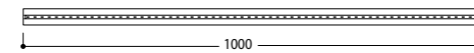

24V DC

polycarbonate diffuser included

color temperature	2700K			3000K			4000K		
	medium power	high power	very high power	medium power	high power	very high power	medium power	high power	very high power
REFERENCE	952211	952251	952311	952221	952261	952321	952231	952271	952331
power	9,6W/m	14,4W/m	19,2W/m	9,6W/m	14,4W/m	19,2W/m	9,6W/m	14,4W/m	19,2W/m
lumen output	672 lm/m	1010 lm/m	2208lm/m	710 lm/m	1060 lm/m	2208lm/m	740 lm/m	1100 lm/m	2323lm/m
CRI	92	92	92	92	92	92	92	92	92
max. length 1 powerfeed	5 metres	5 metres	5 metres	5 metres	5 metres	5 metres	5 metres	5 metres	5 metres
min. cutting length	50 mm	33,33 mm	33,33 mm	50 mm	33,33 mm	33,33 mm	50 mm	33,33 mm	33,33 mm

Installation

Fix the mounting springs with the correct plugs and washer on the wall. Make sure they are carefully lined up. 2 mounting springs per 0.6 meter.

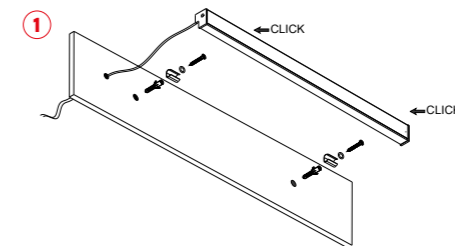

Converter matrix, see back flap



HasHotel Hasselt

How to compose 1U Wall

REQUEST CUSTOMER

SLIM PROFILE FOR WALL MOUNTING
APPROX. 7M

WHITE COLOR

WARM WHITE HIGH OUTPUT

HIGH COLOR RENDERING

+ CONVERTER DIMMABLE 1/10V

TAL

Orderform

REF	DESCRIPTION	PCS/M
955047	1U WALL PROFILE TEXTURED WHITE	6,996
952251	LEDLINE 2700K HIGH POWER CRI 92	6,996
955247	ENDCAP RIGHT TEXTURED WHITE	1
955248	ENDCAP LEFT TEXTURED WHITE	1
952905	SPRING	8
40084	CONVERTER 230V 24V 120VA DIMM 1/10V	1

Drawing

Section view

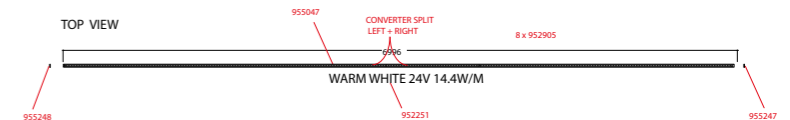
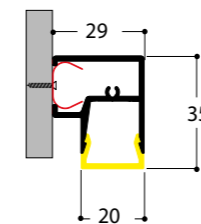

Profile/m

finish	
○	810047
●	810026
●	810012

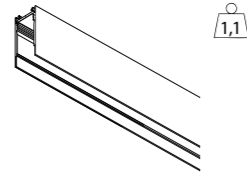

Diffuser/m & Alu Cover/m

finish	W	H	
Frosted Polycarbonate	810104	810105	Diffuser/ Alu cover W
○	810847	-	
●	810826	-	
●	810812	-	

Diffuser/ Alu cover W

Diffuser H

- ❗ To be used in empty profile spaces
- ❗ Alu cover included for UGR modules

Wall Beam

finish	
○	894547
●	894526
●	894512

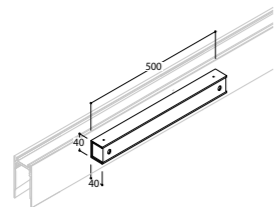

- ❗ 1 wall beam/ 2 m profile

Extra Circuit/m

Common neutral	892630
No common neutral	892631



- ❗ Same length as profile

Endcap

finish	ENDCAP W	ENDCAP H
○	810949	810347
●	810969	810326
●	810929	810312

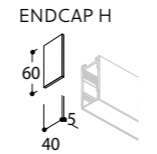
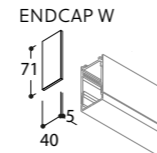

Straight Connection

Straight Connection	891900
---------------------	--------

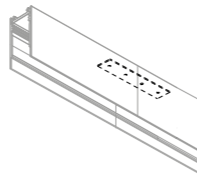

Corner

Corner 90°	892100
Corner 135°	892000
Corner 45°-85° on request	892200

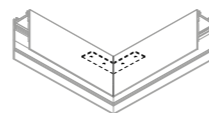

Wall Fixation

finish	
○	891847
●	891800
●	891826

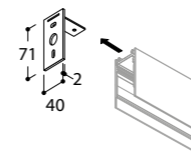

2U W vs 2U H

❗ 2U W

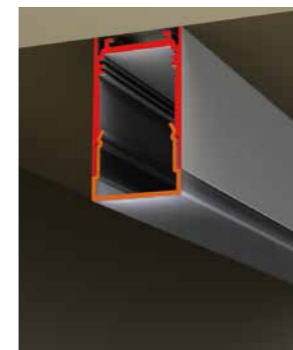

❗ Section view W

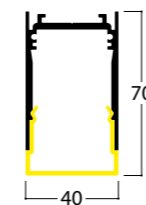

❗ 2U H



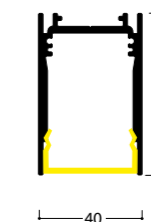

❗ Section view H

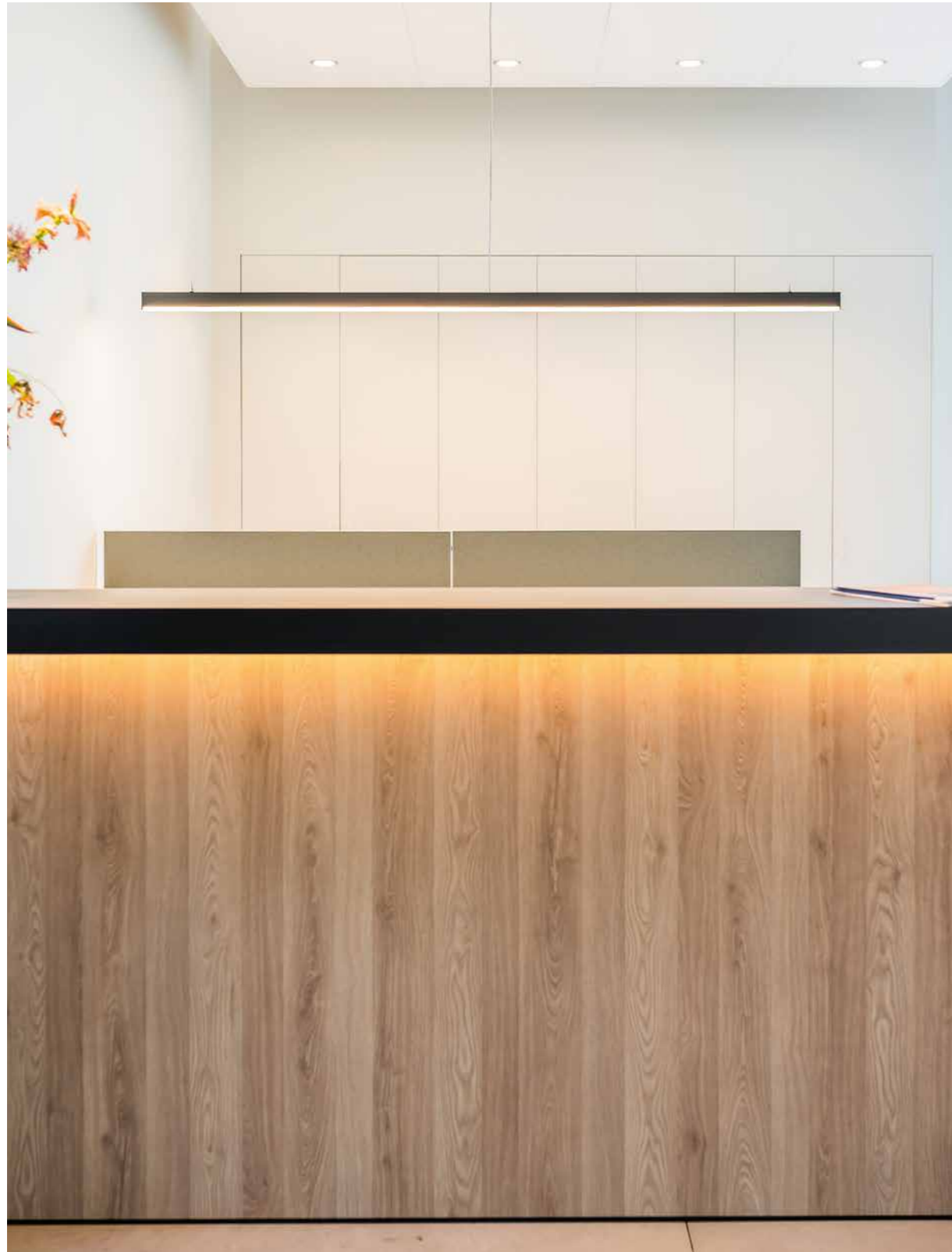



Rogiers Waregem



Suspension Single

finish	2,25 M	4 M	6 M
	892347	892447	892547
	892326	892426	892526
	892330	892430	892530

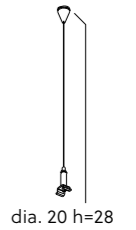
i 1 suspension/ 1,5 m profile
min. 2 suspensions



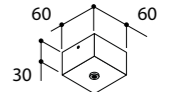

Connection Set Square

finish	3P			5P		
	2,25 m	4 m	6 m	2,25 m	4 m	6 m
	890847	890947	891047	891147	891247	891347
	890826	890926	891026	891126	891226	891326



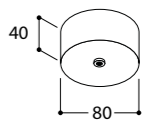

Connection Set Round

finish	3P			5P		
	2,25 m	4 m	6 m	2,25 m	4 m	6 m
	691047	691147	691247	691347	691447	691547
	691026	691126	691226	691326	691426	691526



Connection Set Kosmos (recessed)

finish	3P			5P		
	2,25 m	4 m	6 m	2,25 m	4 m	6 m
	691057	691157	691257	691357	691457	691557
	691036	691136	691236	691336	691436	691536

i 56 mm
Installation depth 60 mm

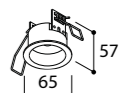



Lammertyn Ardoois

LEDSYSTEM HE - 2315 lm/meter

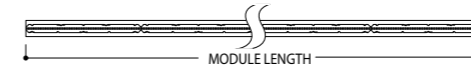

INPUT VOLTAGE 230V AC

Min. required space in profile



		2700K					
led lamps	diffuser	IP	not dimm	dali/touch	power /W	length/mm	length/ft
2U H Ledsystem 2x650lm	Frosted polycarbonate H	IP40	813724	813720	7	560	2
2U H Ledsystem 3x650lm	Frosted polycarbonate H	IP40	813714	813710	10,5	840	3
2U H Ledsystem 4x650lm	Frosted polycarbonate H	IP40	813744	813740	14	1120	4
2U H Ledsystem 5x650lm	Frosted polycarbonate H	IP40	813754	813750	17,5	1400	5
2U H Ledsystem 6x650lm	Frosted polycarbonate H	IP40	813764	813760	21	1680	6
2U H Ledsystem 7x650lm	Frosted polycarbonate H	IP40	813774	813770	24,5	1960	7
2U H Ledsystem 8x650lm	Frosted polycarbonate H	IP40	813784	813780	28	2240	8
2U H Ledsystem 9x650lm	Frosted polycarbonate H	IP40	813794	813790	31,5	2520	9
2U H Ledsystem 10x650lm	Frosted polycarbonate H	IP40	813704	813700	35	2800	10

		3000K					
led lamps	diffuser	IP	not dimm	dali/touch	power /W	length/mm	length/ft
2U H Ledsystem 2x650lm	Frosted polycarbonate H	IP40	811724	811720	7	560	2
2U H Ledsystem 3x650lm	Frosted polycarbonate H	IP40	811714	811710	10,5	840	3
2U H Ledsystem 4x650lm	Frosted polycarbonate H	IP40	811744	811740	14	1120	4
2U H Ledsystem 5x650lm	Frosted polycarbonate H	IP40	811754	811750	17,5	1400	5
2U H Ledsystem 6x650lm	Frosted polycarbonate H	IP40	811764	811760	21	1680	6
2U H Ledsystem 7x650lm	Frosted polycarbonate H	IP40	811774	811770	24,5	1960	7
2U H Ledsystem 8x650lm	Frosted polycarbonate H	IP40	811784	811780	28	2240	8
2U H Ledsystem 9x650lm	Frosted polycarbonate H	IP40	811794	811790	31,5	2520	9
2U H Ledsystem 10x650lm	Frosted polycarbonate H	IP40	811704	811700	35	2800	10

		4000K					
led lamps	diffuser	IP	not dimm	dali/touch	power /W	length/mm	length/ft
2U H Ledsystem 2x650lm	Frosted polycarbonate H	IP40	811725	811721	7	560	2
2U H Ledsystem 3x650lm	Frosted polycarbonate H	IP40	811715	811711	10,5	840	3
2U H Ledsystem 4x650lm	Frosted polycarbonate H	IP40	811745	811741	14	1120	4
2U H Ledsystem 5x650lm	Frosted polycarbonate H	IP40	811755	811751	17,5	1400	5
2U H Ledsystem 6x650lm	Frosted polycarbonate H	IP40	811765	811761	21	1680	6
2U H Ledsystem 7x650lm	Frosted polycarbonate H	IP40	811775	811771	24,5	1960	7
2U H Ledsystem 8x650lm	Frosted polycarbonate H	IP40	811785	811781	28	2240	8
2U H Ledsystem 9x650lm	Frosted polycarbonate H	IP40	811795	811791	31,5	2520	9
2U H Ledsystem 10x650lm	Frosted polycarbonate H	IP40	811705	811701	35	2800	10

LED SYSTEM HE - 2315 lm/meter

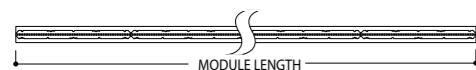

INPUT VOLTAGE 230V AC
 ⓘ Min. required space in profile



		2700K					
led lamps	diffuser	IP	not dimm	dali/touch	power /W	length/mm	length/ft
2U W Ledsystem 2x650lm	Frosted polycarbonate W	IP40	812924	812920	7	560	2
2U W Ledsystem 3x650lm	Frosted polycarbonate W	IP40	812914	812910	10,5	840	3
2U W Ledsystem 4x650lm	Frosted polycarbonate W	IP40	812944	812940	14	1120	4
2U W Ledsystem 5x650lm	Frosted polycarbonate W	IP40	812954	812950	17,5	1400	5
2U W Ledsystem 6x650lm	Frosted polycarbonate W	IP40	812964	812960	21	1680	6
2U W Ledsystem 7x650lm	Frosted polycarbonate W	IP40	812974	812970	24,5	1960	7
2U W Ledsystem 8x650lm	Frosted polycarbonate W	IP40	812984	812980	28	2240	8
2U W Ledsystem 9x650lm	Frosted polycarbonate W	IP40	812994	812990	31,5	2520	9
2U W Ledsystem 10x650lm	Frosted polycarbonate W	IP40	812904	812900	35	2800	10

		3000K					
led lamps	diffuser	IP	not dimm	dali/touch	power /W	length/mm	length/ft
2U W Ledsystem 2x650lm	Frosted polycarbonate W	IP40	810924	810920	7	560	2
2U W Ledsystem 3x650lm	Frosted polycarbonate W	IP40	810914	810910	10,5	840	3
2U W Ledsystem 4x650lm	Frosted polycarbonate W	IP40	810944	810940	14	1120	4
2U W Ledsystem 5x650lm	Frosted polycarbonate W	IP40	810954	810950	17,5	1400	5
2U W Ledsystem 6x650lm	Frosted polycarbonate W	IP40	810964	810960	21	1680	6
2U W Ledsystem 7x650lm	Frosted polycarbonate W	IP40	810974	810970	24,5	1960	7
2U W Ledsystem 8x650lm	Frosted polycarbonate W	IP40	810984	810980	28	2240	8
2U W Ledsystem 9x650lm	Frosted polycarbonate W	IP40	810994	810990	31,5	2520	9
2U W Ledsystem 10x650lm	Frosted polycarbonate W	IP40	810904	810900	35	2800	10

		4000K					
led lamps	diffuser	IP	not dimm	dali/touch	power /W	length/mm	length/ft
2U W Ledsystem 2x650lm	Frosted polycarbonate W	IP40	810925	810921	7	560	2
2U W Ledsystem 3x650lm	Frosted polycarbonate W	IP40	810915	810911	10,5	840	3
2U W Ledsystem 4x650lm	Frosted polycarbonate W	IP40	810945	810941	14	1120	4
2U W Ledsystem 5x650lm	Frosted polycarbonate W	IP40	810955	810951	17,5	1400	5
2U W Ledsystem 6x650lm	Frosted polycarbonate W	IP40	810965	810961	21	1680	6
2U W Ledsystem 7x650lm	Frosted polycarbonate W	IP40	810975	810971	24,5	1960	7
2U W Ledsystem 8x650lm	Frosted polycarbonate W	IP40	810985	810981	28	2240	8
2U W Ledsystem 9x650lm	Frosted polycarbonate W	IP40	810995	810991	31,5	2520	9
2U W Ledsystem 10x650lm	Frosted polycarbonate W	IP40	810905	810901	35	2800	10

LED SYSTEM HO - 3925 lm/meter



INPUT VOLTAGE 230V AC
 ⓘ Min. required space in profile



		2700K					
led lamps	diffuser	IP	not dimm	dali/touch	power /W	length/mm	length/ft
2U W Ledsystem 2x1100lm	Frosted polycarbonate W	IP40	812926	812922	11,6	560	2
2U W Ledsystem 3x1100lm	Frosted polycarbonate W	IP40	812916	812912	17,4	840	3
2U W Ledsystem 4x1100lm	Frosted polycarbonate W	IP40	812946	812942	23,2	1120	4
2U W Ledsystem 5x1100lm	Frosted polycarbonate W	IP40	812956	812952	29	1400	5
2U W Ledsystem 6x1100lm	Frosted polycarbonate W	IP40	812966	812962	34,8	1680	6
2U W Ledsystem 7x1100lm	Frosted polycarbonate W	IP40	812976	812972	40,6	1960	7
2U W Ledsystem 8x1100lm	Frosted polycarbonate W	IP40	812986	812982	46,4	2240	8
2U W Ledsystem 9x1100lm	Frosted polycarbonate W	IP40	812996	812992	52,2	2520	9
2U W Ledsystem 10x1100lm	Frosted polycarbonate W	IP40	812906	812902	58	2800	10

		3000K					
led lamps	diffuser	IP	not dimm	dali/touch	power /W	length/mm	length/ft
2U W Ledsystem 2x1100lm	Frosted polycarbonate W	IP40	810926	810922	11,6	560	2
2U W Ledsystem 3x1100lm	Frosted polycarbonate W	IP40	810916	810912	17,4	840	3
2U W Ledsystem 4x1100lm	Frosted polycarbonate W	IP40	810946	810942	23,2	1120	4
2U W Ledsystem 5x1100lm	Frosted polycarbonate W	IP40	810956	810952	29	1400	5
2U W Ledsystem 6x1100lm	Frosted polycarbonate W	IP40	810966	810962	34,8	1680	6
2U W Ledsystem 7x1100lm	Frosted polycarbonate W	IP40	810976	810972	40,6	1960	7
2U W Ledsystem 8x1100lm	Frosted polycarbonate W	IP40	810986	810982	46,4	2240	8
2U W Ledsystem 9x1100lm	Frosted polycarbonate W	IP40	810996	810992	52,2	2520	9
2U W Ledsystem 10x1100lm	Frosted polycarbonate W	IP40	810906	810902	58	2800	10

		4000K					
led lamps	diffuser	IP	not dimm	dali/touch	power /W	length/mm	length/ft
2U W Ledsystem 2x1100lm	Frosted polycarbonate W	IP40	810928	810923	11,6	560	2
2U W Ledsystem 3x1100lm	Frosted polycarbonate W	IP40	810918	810913	17,4	840	3
2U W Ledsystem 4x1100lm	Frosted polycarbonate W	IP40	810948	810943	23,2	1120	4
2U W Ledsystem 5x1100lm	Frosted polycarbonate W	IP40	810958	810953	29	1400	5
2U W Ledsystem 6x1100lm	Frosted polycarbonate W	IP40	810968	810963	34,8	1680	6
2U W Ledsystem 7x1100lm	Frosted polycarbonate W	IP40	810978	810973	40,6	1960	7
2U W Ledsystem 8x1100lm	Frosted polycarbonate W	IP40	810988	810983	46,4	2240	8
2U W Ledsystem 9x1100lm	Frosted polycarbonate W	IP40	810998	810993	52,2	2520	9
2U W Ledsystem 10x1100lm	Frosted polycarbonate W	IP40	810908	810903	58	2800	10

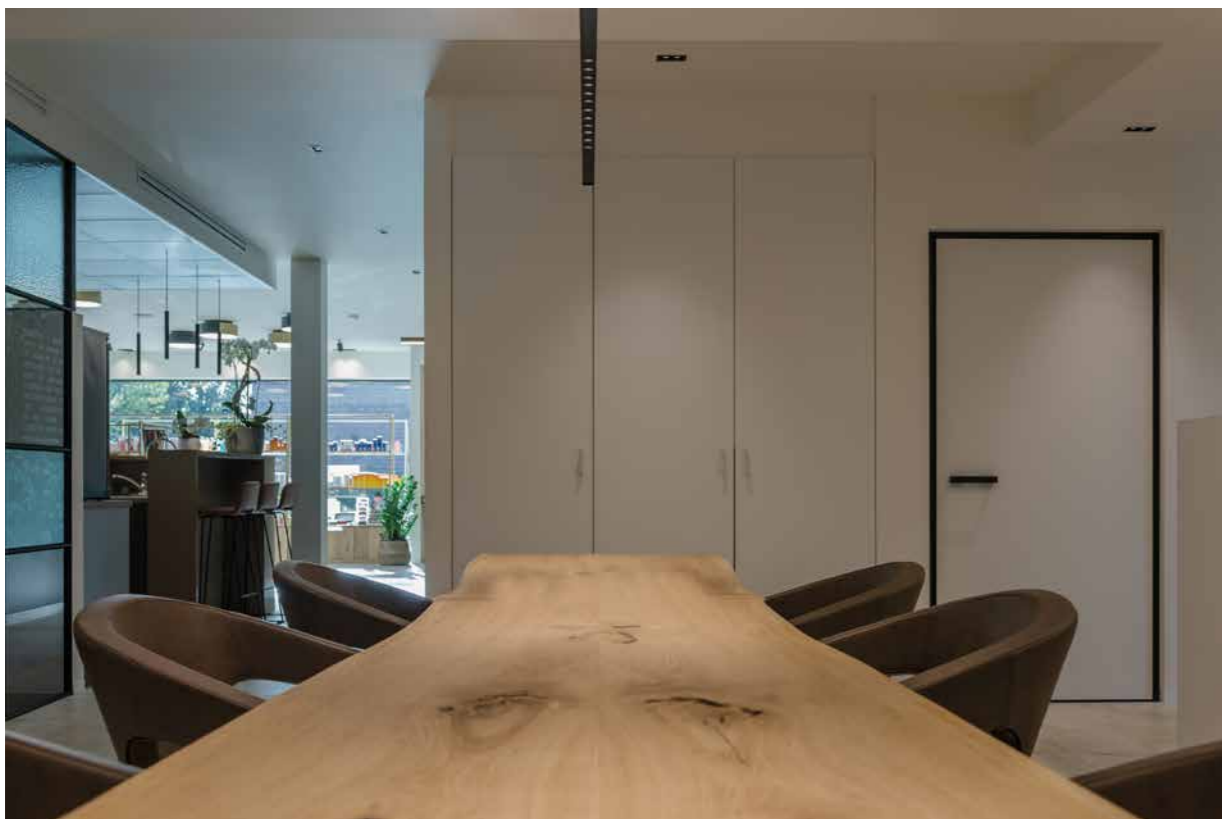

Nelson Hairteam Destelbergen

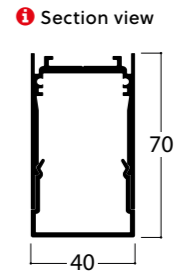

LEDSYSTEM

25° = UGR <12

46° = UGR <19

INPUT VOLTAGE 230V AC

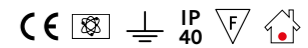

	25°				46°				length	W	lumen
	not dimm		dali		not dimm		dali				
2700k	○	●	○	●	○	●	○	●			
2U W UGR 2x500lm CRI92	814700	814705	814710	814715	814720	814725	814730	814735	560mm	7,5	948
2U W UGR 3x500lm CRI92	814701	814706	814711	814716	814721	814726	814731	814736	840mm	11,25	1422
2U W UGR 4x500lm CRI92	814702	814707	814712	814717	814722	814727	814732	814737	1120mm	15	1896
2U W UGR 5x500lm CRI92	814703	814708	814713	814718	814723	814728	814733	814738	1400mm	18,75	2370
2U W UGR 2x780lm CRI92	814740	814745	814750	814755	814760	814765	814770	814775	560mm	13,3	1484
2U W UGR 3x780lm CRI92	814741	814746	814751	814756	814761	814766	814771	814776	840mm	19,9	2226
2U W UGR 4x780lm CRI92	814742	814747	814752	814757	814762	814767	814772	814777	1120mm	26,5	2968
2U W UGR 5x780lm CRI92	814743	814748	814753	814758	814763	814768	814773	814778	1400mm	33,2	3710
3000K	○	●	○	●	○	●	○	●			
2U W UGR 2x500lm CRI92	814800	814805	814810	814815	814820	814825	814830	814835	560mm	7,5	966
2U W UGR 3x500lm CRI92	814801	814806	814811	814816	814821	814826	814831	814836	840mm	11,25	1449
2U W UGR 4x500lm CRI92	814802	814807	814812	814817	814822	814827	814832	814837	1120mm	15	1932
2U W UGR 5x500lm CRI92	814803	814808	814813	814818	814823	814828	814833	814838	1400mm	18,75	2415
2U W UGR 2x780lm CRI92	814840	814845	814850	814855	814860	814865	814870	814875	560mm	13,3	1510
2U W UGR 3x780lm CRI92	814841	814846	814851	814856	814861	814866	814871	814876	840mm	19,9	2265
2U W UGR 4x780lm CRI92	814842	814847	814852	814857	814862	814867	814872	814877	1120mm	26,5	3020
2U W UGR 5x780lm CRI92	814843	814848	814853	814858	814863	814868	814873	814878	1400mm	33,2	3775
4000K	○	●	○	●	○	●	○	●			
2U W UGR 2x500lm CRI92	814900	814905	814910	814915	814920	814925	814930	814935	560mm	7,5	1042
2U W UGR 3x500lm CRI92	814901	814906	814911	814916	814921	814926	814931	814936	840mm	11,25	1563
2U W UGR 4x500lm CRI92	814902	814907	814912	814917	814922	814927	814932	814937	1120mm	15	2084
2U W UGR 5x500lm CRI92	814903	814908	814913	814918	814923	814928	814933	814938	1400mm	18,75	2605
2U W UGR 2x780lm CRI92	814940	814945	814950	814955	814960	814965	814970	814975	560mm	13,3	1632
2U W UGR 3x780lm CRI92	814941	814946	814951	814956	814961	814966	814971	814976	840mm	19,9	2448
2U W UGR 4x780lm CRI92	814942	814947	814952	814957	814962	814967	814972	814977	1120mm	26,5	3264
2U W UGR 5x780lm CRI92	814943	814948	814953	814958	814963	814968	814973	814978	1400mm	33,2	4080

2U W UGR

profiles

Module Ledline/m CR (convertor can be incorporated)

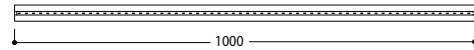

24V DC



i polycarbonate diffuser included

color temperature	2700K			3000K			4000K		
	medium power	high power	very high power	medium power	high power	very high power	medium power	high power	very high power
REFERENCE DIFFUSER W	819610	819650	819611	819620	819660	819621	819630	819670	819631
REFERENCE DIFFUSER H	N/A	N/A	N/A	N/A	N/A	N/A	N/A	N/A	N/A
power	9,6W/m	14,4W/m	19,2W/m	9,6W/m	14,4W/m	19,2W/m	9,6W/m	14,4W/m	19,2W/m
lumen output	672 lm/m	1010 lm/m	2208 lm/m	710 lm/m	1060 lm/m	2208 lm/m	740 lm/m	1100 lm/m	2323 lm/m
CRI	92	92	92	92	92	92	92	92	92
max. length 1 powerfeed	5 metres	5 metres	5 metres	5 metres	5 metres	5 metres	5 metres	5 metres	5 metres
min. cutting length	50 mm	33,33 mm	33,33 mm	50 mm	33,33 mm	33,33 mm	50 mm	33,33 mm	33,33 mm

Integrated converter (for ledline CR)

input 230 V-AC
output 24V-DC
power 20W

i fits in 2U profile
(no extra space required)

	1-10 V DIMM
2U Convertor module	692910

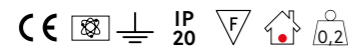

Integrated converter (for ledline CR)

input 230 V-AC
output 24V-DC
power 60W

i fits in 2U profile
(no extra space required)

	NOT DIMM	1-10 V	DALI DIMM
2U Convertor module	692930	692940	692950

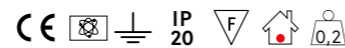

Module Ledline/m WC (no space for convertor)

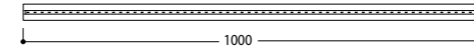

24V DC



i polycarbonate diffuser included

color temperature	2700K			3000K			4000K		
	medium power	high power	very high power	medium power	high power	very high power	medium power	high power	very high power
REFERENCE DIFFUSER W	819710	819750	819711	819720	819760	819721	819730	819770	819731
REFERENCE DIFFUSER H	819216	819256	819217	819226	819266	819227	819236	819276	819237
power	9,6W/m	14,4W/m	19,2W/m	9,6W/m	14,4W/m	19,2W/m	9,6W/m	14,4W/m	19,2W/m
lumen output	672 lm/m	1010 lm/m	2208 lm/m	710 lm/m	1060 lm/m	2208 lm/m	740 lm/m	1100 lm/m	2323 lm/m
CRI	92	92	92	92	92	92	92	92	92
max. length 1 powerfeed	5 metres	5 metres	5 metres	5 metres	5 metres	5 metres	5 metres	5 metres	5 metres
min. cutting length	50 mm	33,33 mm	33,33 mm	50 mm	33,33 mm	33,33 mm	50 mm	33,33 mm	33,33 mm

i Converter matrix, see back flap



Private house Pittem

Module 1 x Luxeon M

LUXEON M - 3,82W - 230V 50-60Hz AC

400 lumen 2700K CRI90

429 lumen 3000K CRI90

dimmability: mains dim LC

HALOSPHERE - 4,25W - 230V 50-60Hz AC

455 lumen 1800K ▶ 3000K CRI90

dimmability: mains dim LC

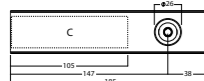

finish	2700K	3000K	1800K-3000K
○	815202	815262	815362
●	815203	815263	815363
●	815205	815265	815365
🚫	Cover Textured White P/M		810847
🚫	Cover Textured Black P/M		810826



Module 2 x Luxeon M

LUXEON M - (2x) 3,82W - 230V 50-60Hz AC

2x 400 lumen 2700K CRI90

2x 429 lumen 3000K CRI90

dimmability: mains dim LC

HALOSPHERE - (2x) 4,25W - 230V 50-60Hz AC

2x 455 lumen 1800K ▶ 3000K CRI90

dimmability: mains dim LC

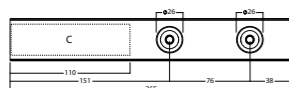

finish	2700K	3000K	1800K-3000K
○	815206	815266	815366
●	815207	815267	815367
●	815209	815269	815369
🚫	Cover Textured White P/M		810847
🚫	Cover Textured Black P/M		810826



Module 3 x Luxeon M

LUXEON M - (3x) 3,82W - 230V 50-60Hz AC

3x 400 lumen 2700K CRI90

3x 429 lumen 3000K CRI90

dimmability: mains dim LC

HALOSPHERE - (3x) 4,25W - 230V 50-60Hz AC

3x 455 lumen 1800K ▶ 3000K CRI90

dimmability: mains dim LC

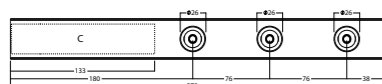

finish	2700K	3000K	1800K-3000K
○	815212	815272	815372
●	815213	815273	815373
●	815215	815275	815375
🚫	Cover Textured White P/M		810847
🚫	Cover Textured Black P/M		810826



Module 4 x Luxeon M

LUXEON M - (4x) 3,82W - 230V 50-60Hz AC

4x 400 lumen 2700K CRI90

4x 429 lumen 3000K CRI90

dimmability: mains dim LC

HALOSPHERE - (4x) 4,25W - 230V 50-60Hz AC

4x 455 lumen 1800K ▶ 3000K CRI90

dimmability: mains dim LC

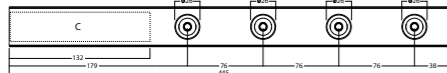

finish	2700K	3000K	1800K-3000K
○	815216	815276	815376
●	815217	815277	815377
●	815219	815279	815379
🚫	Cover Textured White P/M		810847
🚫	Cover Textured Black P/M		810826



🚫 All distances between led modules are always minimum dimensions



Lammertyn Ardoois

M10 Module

Module	Part Number	Options
M10 Module 230V	815299	
M10 Module 1x 250mA mains dimm	815290	🚫 Cover profile/m 810847 / 810826 / 810812
M10 Module 1x 350mA mains dimm	815291	🚫 Fall protection 815295
M10 Module 1x 700mA mains dimm	815292	

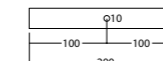



HasHotel Hasselt

How to compose 2U

REQUEST CUSTOMER

SMALL SINGLE LAMP PROFILE
 1 CIRCUIT
 TEXT. BLACK COLOR
 L SHAPE
 COLOR TEMPERATURE 4000K
 LED T5 HE EQUIVALENT

TAL

Orderform

REF	DESCRIPTION	PCS/M
810026	PROFILE	2,544 + 0,864
810967	ENDCAP	2
810915	MODULE LEDSYSTEM 3X650LM 4000K	1
810995	MODULE LEDSYSTEM 9X650LM 4000K	1
892100	CORNER 90°	1
810104	DIFFUSER W	0,48

Drawing

TOP VIEW

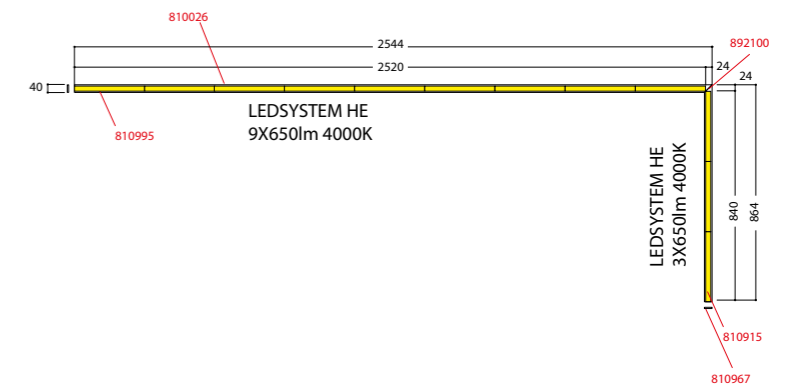

Section view

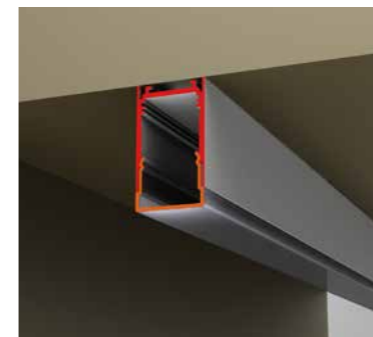
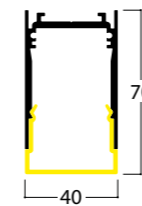

Profile/m

finish	
○	840047
●	840026



Endcap S+H

finish	ENDCAP S+H
○	840247
●	840226

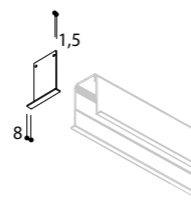

Diffuser/m & Alu Cover/m

finish	S	H
Frosted Polycarbonate	810106	810105
○	810147	-
●	810126	-

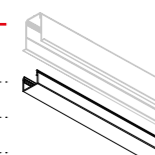

❗ To be used in empty profile space ;

Extra Circuit/m

Common neutral	892630
No common neutral	892631



❗ Same length as profile

Mounting Bracket

Mounting Bracket	894900
------------------	--------



❗ 1 bracket / 1 m profile
min. 2 brackets

Straight Connection

Straight Connection	891910
---------------------	--------

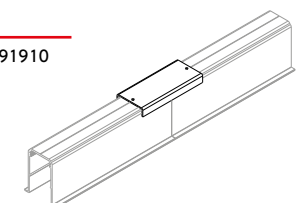

❗ Installation

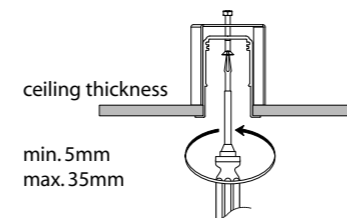

Corner

Corner 90°	892110
------------	--------

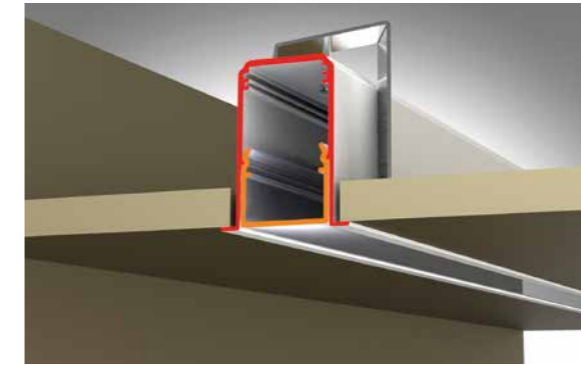
❗ Cut out dimensions

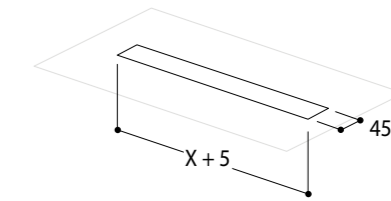

❗ X = Length of profile (measured without endcaps)
Installation depth: 95 mm

2U Recessed S vs 2U Recessed H

❗ 2U Recessed S

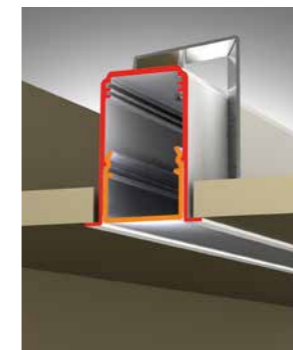

❗ 2U Recessed H

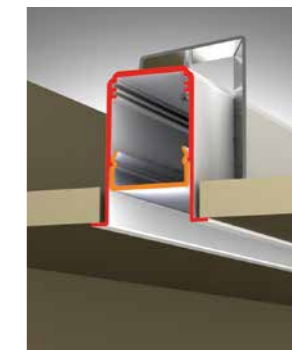

❗ Section view S

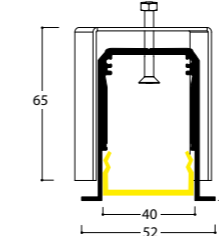

❗ Section view H

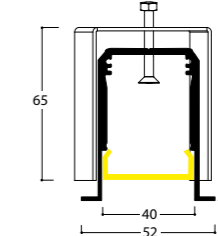

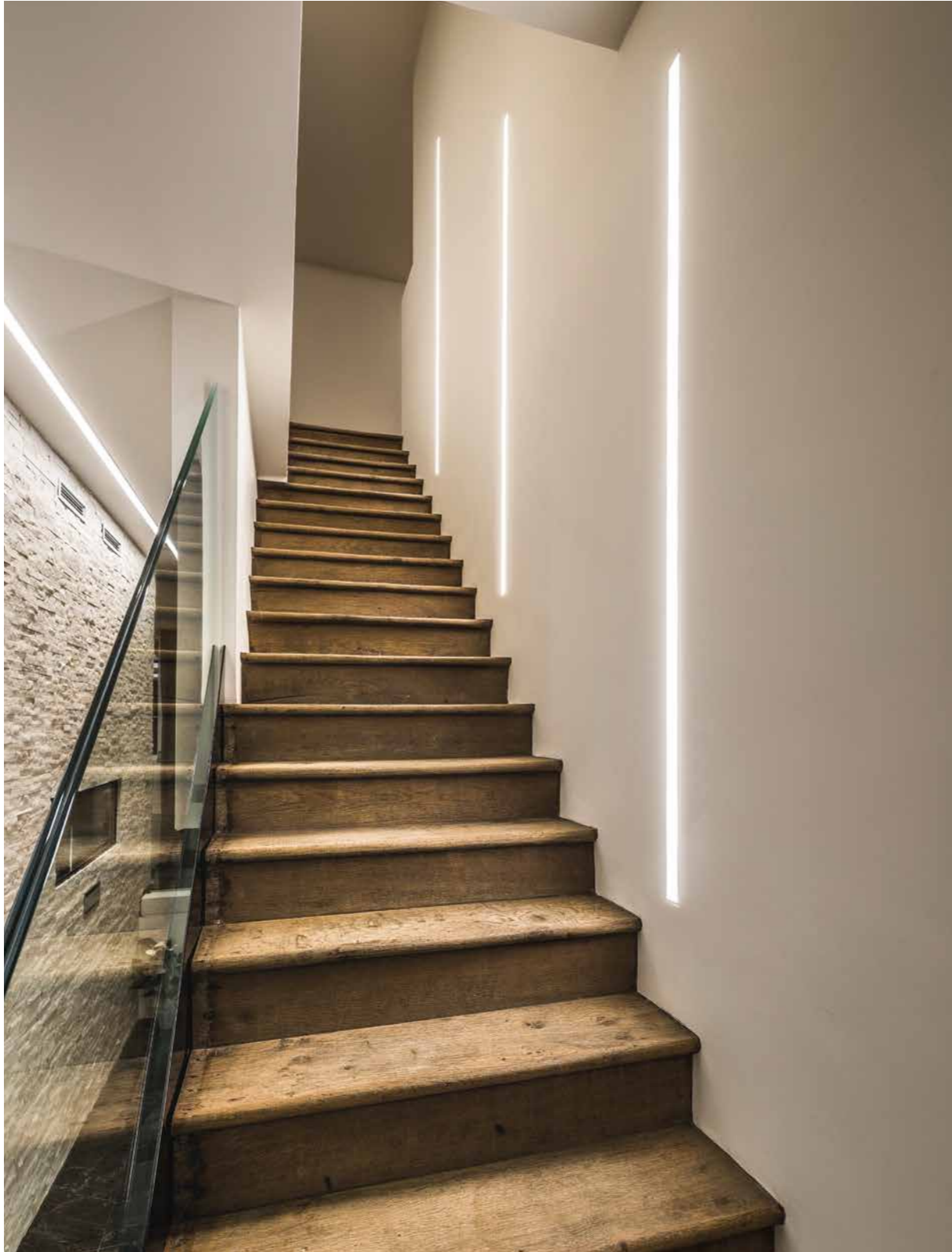

Private house Etalle

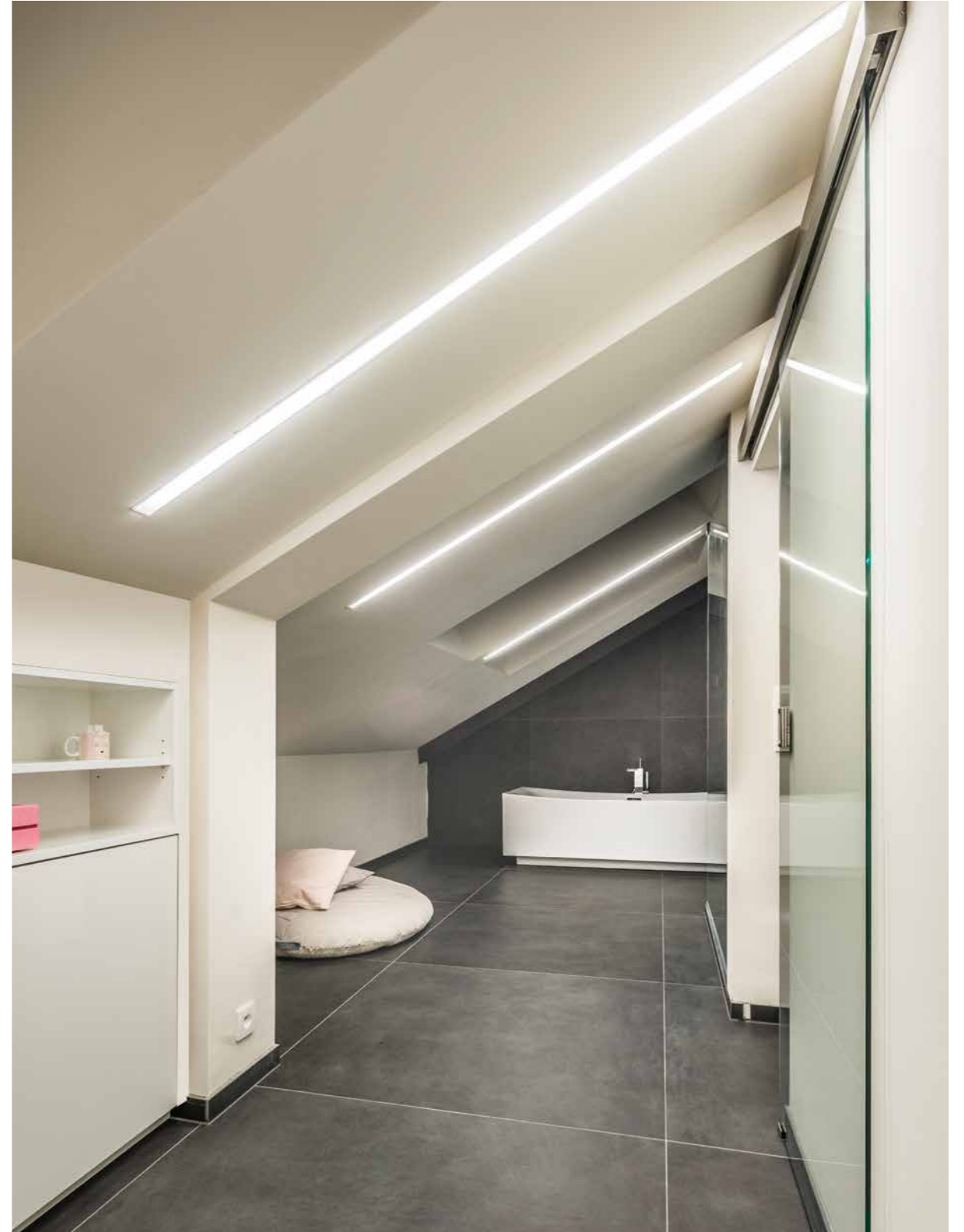

Private house Etalle



Private house Virton

LEDSYSTEM HE - 2315 lm/meter



INPUT VOLTAGE 230V AC

Min. required space in profile



		2700K					
led lamps	diffuser	IP	not dimm	dali/touch	power /W	length/mm	length/ft
2UR H Ledsystem 2x650lm	Frosted polycarbonate H	IP40	813724	813720	7	560	2
2UR H Ledsystem 3x650lm	Frosted polycarbonate H	IP40	813714	813710	10,5	840	3
2UR H Ledsystem 4x650lm	Frosted polycarbonate H	IP40	813744	813740	14	1120	4
2UR H Ledsystem 5x650lm	Frosted polycarbonate H	IP40	813754	813750	17,5	1400	5
2UR H Ledsystem 6x650lm	Frosted polycarbonate H	IP40	813764	813760	21	1680	6
2UR H Ledsystem 7x650lm	Frosted polycarbonate H	IP40	813774	813770	24,5	1960	7
2UR H Ledsystem 8x650lm	Frosted polycarbonate H	IP40	813784	813780	28	2240	8
2UR H Ledsystem 9x650lm	Frosted polycarbonate H	IP40	813794	813790	31,5	2520	9
2UR H Ledsystem 10x650lm	Frosted polycarbonate H	IP40	813704	813700	35	2800	10

		3000K					
led lamps	diffuser	IP	not dimm	dali/touch	power /W	length/mm	length/ft
2UR H Ledsystem 2x650lm	Frosted polycarbonate H	IP40	811724	811720	7	560	2
2UR H Ledsystem 3x650lm	Frosted polycarbonate H	IP40	811714	811710	10,5	840	3
2UR H Ledsystem 4x650lm	Frosted polycarbonate H	IP40	811744	811740	14	1120	4
2UR H Ledsystem 5x650lm	Frosted polycarbonate H	IP40	811754	811750	17,5	1400	5
2UR H Ledsystem 6x650lm	Frosted polycarbonate H	IP40	811764	811760	21	1680	6
2UR H Ledsystem 7x650lm	Frosted polycarbonate H	IP40	811774	811770	24,5	1960	7
2UR H Ledsystem 8x650lm	Frosted polycarbonate H	IP40	811784	811780	28	2240	8
2UR H Ledsystem 9x650lm	Frosted polycarbonate H	IP40	811794	811790	31,5	2520	9
2UR H Ledsystem 10x650lm	Frosted polycarbonate H	IP40	811704	811700	35	2800	10

		4000K					
led lamps	diffuser	IP	not dimm	dali/touch	power /W	length/mm	length/ft
2UR H Ledsystem 2x650lm	Frosted polycarbonate H	IP40	811725	811721	7	560	2
2UR H Ledsystem 3x650lm	Frosted polycarbonate H	IP40	811715	811711	10,5	840	3
2UR H Ledsystem 4x650lm	Frosted polycarbonate H	IP40	811745	811741	14	1120	4
2UR H Ledsystem 5x650lm	Frosted polycarbonate H	IP40	811755	811751	17,5	1400	5
2UR H Ledsystem 6x650lm	Frosted polycarbonate H	IP40	811765	811761	21	1680	6
2UR H Ledsystem 7x650lm	Frosted polycarbonate H	IP40	811775	811771	24,5	1960	7
2UR H Ledsystem 8x650lm	Frosted polycarbonate H	IP40	811785	811781	28	2240	8
2UR H Ledsystem 9x650lm	Frosted polycarbonate H	IP40	811795	811791	31,5	2520	9
2UR H Ledsystem 10x650lm	Frosted polycarbonate H	IP40	811705	811701	35	2800	10

LED SYSTEM HE - 2315 lm/meter



INPUT VOLTAGE 230V AC
 ⓘ Min. required space in profile



		2700K					
led lamps	diffuser	IP	not dimm	dali/touch	power /W	length/mm	length /ft
2UR S Ledsystem 2x650lm	Frosted polycarbonate S	IP40	812724	812720	7	560	2
2UR S Ledsystem 3x650lm	Frosted polycarbonate S	IP40	812714	812710	10,5	840	3
2UR S Ledsystem 4x650lm	Frosted polycarbonate S	IP40	812744	812740	14	1120	4
2UR S Ledsystem 5x650lm	Frosted polycarbonate S	IP40	812754	812750	17,5	1400	5
2UR S Ledsystem 6x650lm	Frosted polycarbonate S	IP40	812764	812760	21	1680	6
2UR S Ledsystem 7x650lm	Frosted polycarbonate S	IP40	812774	812770	24,5	1960	7
2UR S Ledsystem 8x650lm	Frosted polycarbonate S	IP40	812784	812780	28	2240	8
2UR S Ledsystem 9x650lm	Frosted polycarbonate S	IP40	812794	812790	31,5	2520	9
2UR S Ledsystem 10x650lm	Frosted polycarbonate S	IP40	812704	812700	35	2800	10

		3000K					
led lamps	diffuser	IP	not dimm	dali/touch	power /W	length/mm	length /ft
2UR S Ledsystem 2x650lm	Frosted polycarbonate S	IP40	810724	810720	7	560	2
2UR S Ledsystem 3x650lm	Frosted polycarbonate S	IP40	810714	810710	10,5	840	3
2UR S Ledsystem 4x650lm	Frosted polycarbonate S	IP40	810744	810740	14	1120	4
2UR S Ledsystem 5x650lm	Frosted polycarbonate S	IP40	810754	810750	17,5	1400	5
2UR S Ledsystem 6x650lm	Frosted polycarbonate S	IP40	810764	810760	21	1680	6
2UR S Ledsystem 7x650lm	Frosted polycarbonate S	IP40	810774	810770	24,5	1960	7
2UR S Ledsystem 8x650lm	Frosted polycarbonate S	IP40	810784	810780	28	2240	8
2UR S Ledsystem 9x650lm	Frosted polycarbonate S	IP40	810794	810790	31,5	2520	9
2UR S Ledsystem 10x650lm	Frosted polycarbonate S	IP40	810704	810700	35	2800	10

		4000K					
led lamps	diffuser	IP	not dimm	dali/touch	power /W	length/mm	length /ft
2UR S Ledsystem 2x650lm	Frosted polycarbonate S	IP40	810725	810721	7	560	2
2UR S Ledsystem 3x650lm	Frosted polycarbonate S	IP40	810715	810711	10,5	840	3
2UR S Ledsystem 4x650lm	Frosted polycarbonate S	IP40	810745	810741	14	1120	4
2UR S Ledsystem 5x650lm	Frosted polycarbonate S	IP40	810755	810751	17,5	1400	5
2UR S Ledsystem 6x650lm	Frosted polycarbonate S	IP40	810765	810761	21	1680	6
2UR S Ledsystem 7x650lm	Frosted polycarbonate S	IP40	810775	810771	24,5	1960	7
2UR S Ledsystem 8x650lm	Frosted polycarbonate S	IP40	810785	810781	28	2240	8
2UR S Ledsystem 9x650lm	Frosted polycarbonate S	IP40	810795	810791	31,5	2520	9
2UR S Ledsystem 10x650lm	Frosted polycarbonate S	IP40	810705	810701	35	2800	10

LED SYSTEM HO - 3925 lm/meter



INPUT VOLTAGE 230V AC
 ⓘ Min. required space in profile



		2700K					
led lamps	diffuser	IP	not dimm	dali/touch	power /W	length/mm	length /ft
2UR S Ledsystem 2x1100lm	Frosted polycarbonate S	IP40	812726	812722	11,6	560	2
2UR S Ledsystem 3x1100lm	Frosted polycarbonate S	IP40	812736	812732	17,4	840	3
2UR S Ledsystem 4x1100lm	Frosted polycarbonate S	IP40	812746	812742	23,2	1120	4
2UR S Ledsystem 5x1100lm	Frosted polycarbonate S	IP40	812756	812752	29	1400	5
2UR S Ledsystem 6x1100lm	Frosted polycarbonate S	IP40	812766	812762	34,8	1680	6
2UR S Ledsystem 7x1100lm	Frosted polycarbonate S	IP40	812776	812772	40,6	1960	7
2UR S Ledsystem 8x1100lm	Frosted polycarbonate S	IP40	812786	812782	46,4	2240	8
2UR S Ledsystem 9x1100lm	Frosted polycarbonate S	IP40	812796	812792	52,2	2520	9
2UR S Ledsystem 10x1100lm	Frosted polycarbonate S	IP40	812706	812702	58	2800	10

		3000K					
led lamps	diffuser	IP	not dimm	dali/touch	power /W	length/mm	length /ft
2UR S Ledsystem 2x1100lm	Frosted polycarbonate S	IP40	810726	810722	11,6	560	2
2UR S Ledsystem 3x1100lm	Frosted polycarbonate S	IP40	810736	810732	17,4	840	3
2UR S Ledsystem 4x1100lm	Frosted polycarbonate S	IP40	810746	810742	23,2	1120	4
2UR S Ledsystem 5x1100lm	Frosted polycarbonate S	IP40	810756	810752	29	1400	5
2UR S Ledsystem 6x1100lm	Frosted polycarbonate S	IP40	810766	810762	34,8	1680	6
2UR S Ledsystem 7x1100lm	Frosted polycarbonate S	IP40	810776	810772	40,6	1960	7
2UR S Ledsystem 8x1100lm	Frosted polycarbonate S	IP40	810786	810782	46,4	2240	8
2UR S Ledsystem 9x1100lm	Frosted polycarbonate S	IP40	810796	810792	52,2	2520	9
2UR S Ledsystem 10x1100lm	Frosted polycarbonate S	IP40	810706	810702	58	2800	10

		4000K					
led lamps	diffuser	IP	not dimm	dali/touch	power /W	length/mm	length /ft
2UR S Ledsystem 2x1100lm	Frosted polycarbonate S	IP40	810728	810723	11,6	560	2
2UR S Ledsystem 3x1100lm	Frosted polycarbonate S	IP40	810738	810733	17,4	840	3
2UR S Ledsystem 4x1100lm	Frosted polycarbonate S	IP40	810748	810743	23,2	1120	4
2UR S Ledsystem 5x1100lm	Frosted polycarbonate S	IP40	810758	810753	29	1400	5
2UR S Ledsystem 6x1100lm	Frosted polycarbonate S	IP40	810768	810763	34,8	1680	6
2UR S Ledsystem 7x1100lm	Frosted polycarbonate S	IP40	810778	810773	40,6	1960	7
2UR S Ledsystem 8x1100lm	Frosted polycarbonate S	IP40	810788	810783	46,4	2240	8
2UR S Ledsystem 9x1100lm	Frosted polycarbonate S	IP40	810798	810793	52,2	2520	9
2UR S Ledsystem 10x1100lm	Frosted polycarbonate S	IP40	810708	810703	58	2800	10

Module 1 x Luxeon M

LUXEON M - 3,82W - 230V 50-60Hz AC

400 lumen 2700K CRI90

429 lumen 3000K CRI90

dimmability: mains dim LC

HALOSPHERE - 4,25W - 230V 50-60Hz AC

455 lumen 1800K ▶ 3000K CRI90

dimmability: mains dim LC

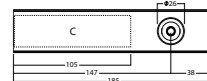

finish	2700K	3000K	1800K-3000K
○	815222	815242	815342
●	815223	815243	815343
●	815225	815245	815345
🚫	Cover Textured White P/M		810847
🚫	Cover Textured Black P/M		810826



Module 2 x Luxeon M

LUXEON M - (2x) 3,82W - 230V 50-60Hz AC

2x 400 lumen 2700K CRI90

2x 429 lumen 3000K CRI90

dimmability: mains dim LC

HALOSPHERE - (2x) 4,25W - 230V 50-60Hz AC

2x 455 lumen 1800K ▶ 3000K CRI90

dimmability: mains dim LC

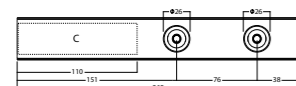

finish	2700K	3000K	1800K-3000K
○	815226	815246	815346
●	815227	815247	815347
●	815229	815249	815349
🚫	Cover Textured White P/M		810847
🚫	Cover Textured Black P/M		810826



Module 3 x Luxeon M

LUXEON M - (3x) 3,82W - 230V 50-60Hz AC

3x 400 lumen 2700K CRI90

3x 429 lumen 3000K CRI90

dimmability: mains dim LC

HALOSPHERE - (3x) 4,25W - 230V 50-60Hz AC

3x 455 lumen 1800K ▶ 3000K CRI90

dimmability: mains dim LC

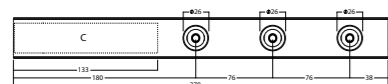

finish	2700K	3000K	1800K-3000K
○	815232	815252	815352
●	815233	815253	815353
●	815235	815255	815355
🚫	Cover Textured White P/M		810847
🚫	Cover Textured Black P/M		810826



Module 4 x Luxeon M

LUXEON M - (4x) 3,82W - 230V 50-60Hz AC

4x 400 lumen 2700K CRI90

4x 429 lumen 3000K CRI90

dimmability: mains dim LC

HALOSPHERE - (4x) 4,25W - 230V 50-60Hz AC

4x 455 lumen 1800K ▶ 3000K CRI90

dimmability: mains dim LC

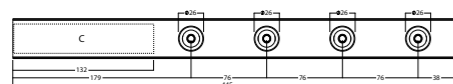

🚫 All distances between led modules are always minimum dimensions

finish	2700K	3000K	1800K-3000K
○	815236	815256	815356
●	815237	815257	815357
●	815239	815259	815359
🚫	Cover Textured White P/M		810847
🚫	Cover Textured Black P/M		810826

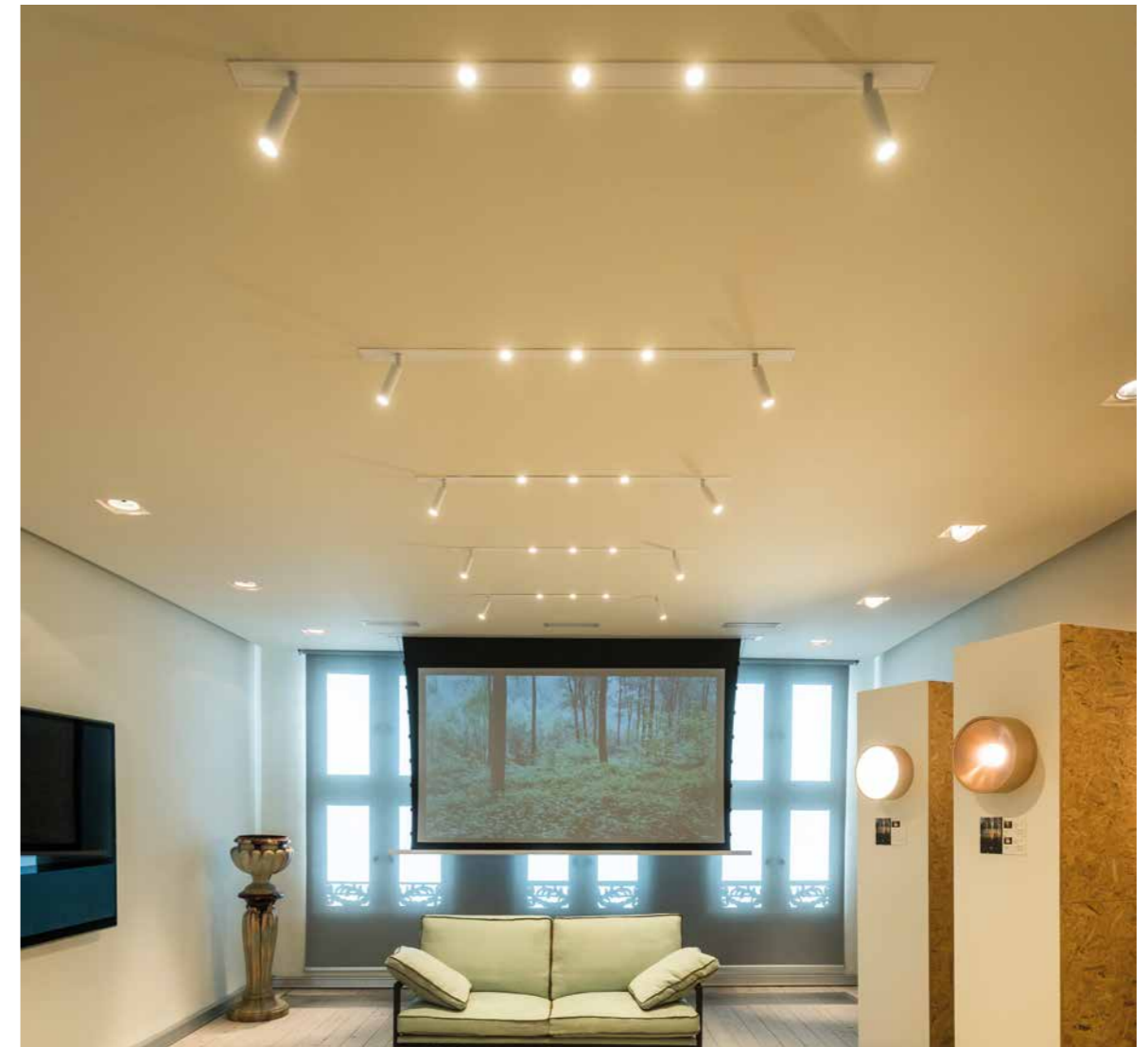

Experience house Antwerp

M10 Module

Module	Part Number	Options	Part Numbers
M10 Module 230V	815299		
M10 Module 1x 250mA mains dimm	815290		
M10 Module 1x 350mA mains dimm	815291	🚫 Cover profile/m	810847 / 810826 / 810812
M10 Module 1x 700mA mains dimm	815292	🚫 Fall protection	815295

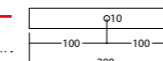

Module Ledline/m CR (convertor can be incorporated)

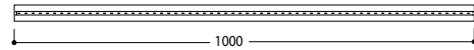

24V DC



i polycarbonate diffuser included

color temperature	2700K			3000K			4000K		
	medium power	high power	very high power	medium power	high power	very high power	medium power	high power	very high power
REFERENCE DIFFUSER S	819410	819450	819411	819420	819460	819421	819430	819470	819431
REFERENCE DIFFUSER H	N/A	N/A	N/A	N/A	N/A	N/A	N/A	N/A	N/A
power	9,6W/m	14,4W/m	19,2W/m	9,6W/m	14,4W/m	19,2W/m	9,6W/m	14,4W/m	19,2W/m
lumen output	672 lm/m	1010 lm/m	2208 lm/m	710 lm/m	1060 lm/m	2208 lm/m	740 lm/m	1100 lm/m	2323 lm/m
CRI	92	92	92	92	92	92	92	92	92
max. length 1 powerfeed	5 metres	5 metres	5 metres	5 metres	5 metres	5 metres	5 metres	5 metres	5 metres
min. cutting length	50 mm	33,33 mm	33,33 mm	50 mm	33,33 mm	33,33 mm	50 mm	33,33 mm	33,33 mm

Integrated convertor (for ledline CR)

input 230 V-AC
output 24V-DC
power 20W

i fits in 2U profile
(no extra space required)

	1-10V DIMM
2U Convertor module	692910

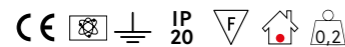

Integrated convertor (for ledline CR)

input 230 V-AC
output 24V-DC
power 60W

i fits in 2U profile
(no extra space required)

	NOT DIMM	1-10V	DALI DIMM
2U Convertor module	692930	692940	692950

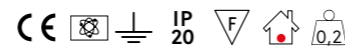

Module Ledline/m WC (no space for convertor)

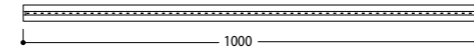

24V DC



i polycarbonate diffuser included

color temperature	2700K			3000K			4000K		
	medium power	high power	very high power	medium power	high power	very high power	medium power	high power	very high power
REFERENCE DIFFUSER S	819211	819251	819212	819221	819261	819222	819231	819271	819232
REFERENCE DIFFUSER H	819216	819256	819217	819226	819266	819227	819236	819276	819237
power	9,6W/m	14,4W/m	19,2W/m	9,6W/m	14,4W/m	19,2W/m	9,6W/m	14,4W/m	19,2W/m
lumen output	672 lm/m	1010 lm/m	2208 lm/m	710 lm/m	1060 lm/m	2208 lm/m	740 lm/m	1100 lm/m	2323 lm/m
CRI	92	92	92	92	92	92	92	92	92
max. length 1 powerfeed	5 metres	5 metres	5 metres	5 metres	5 metres	5 metres	5 metres	5 metres	5 metres
min. cutting length	50 mm	33,33 mm	33,33 mm	50 mm	33,33 mm	33,33 mm	50 mm	33,33 mm	33,33 mm

i Converter matrix, see back flap

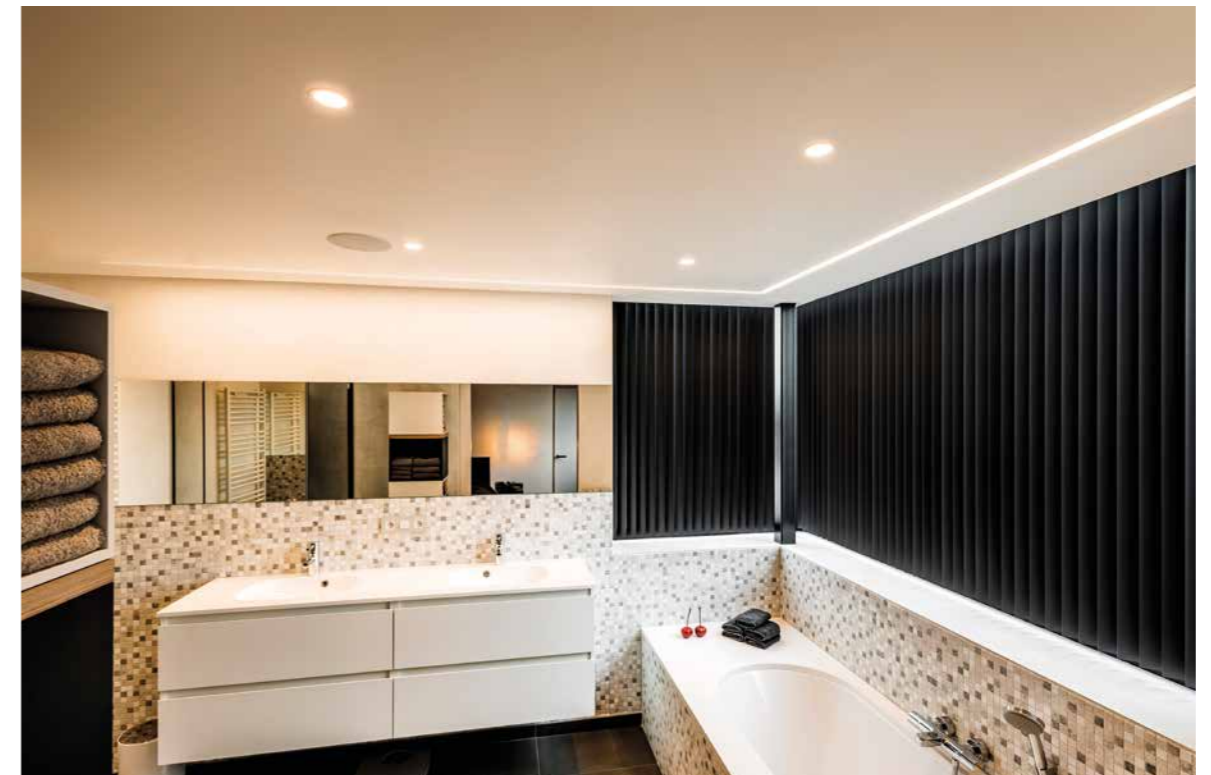

Private house Rumbeke

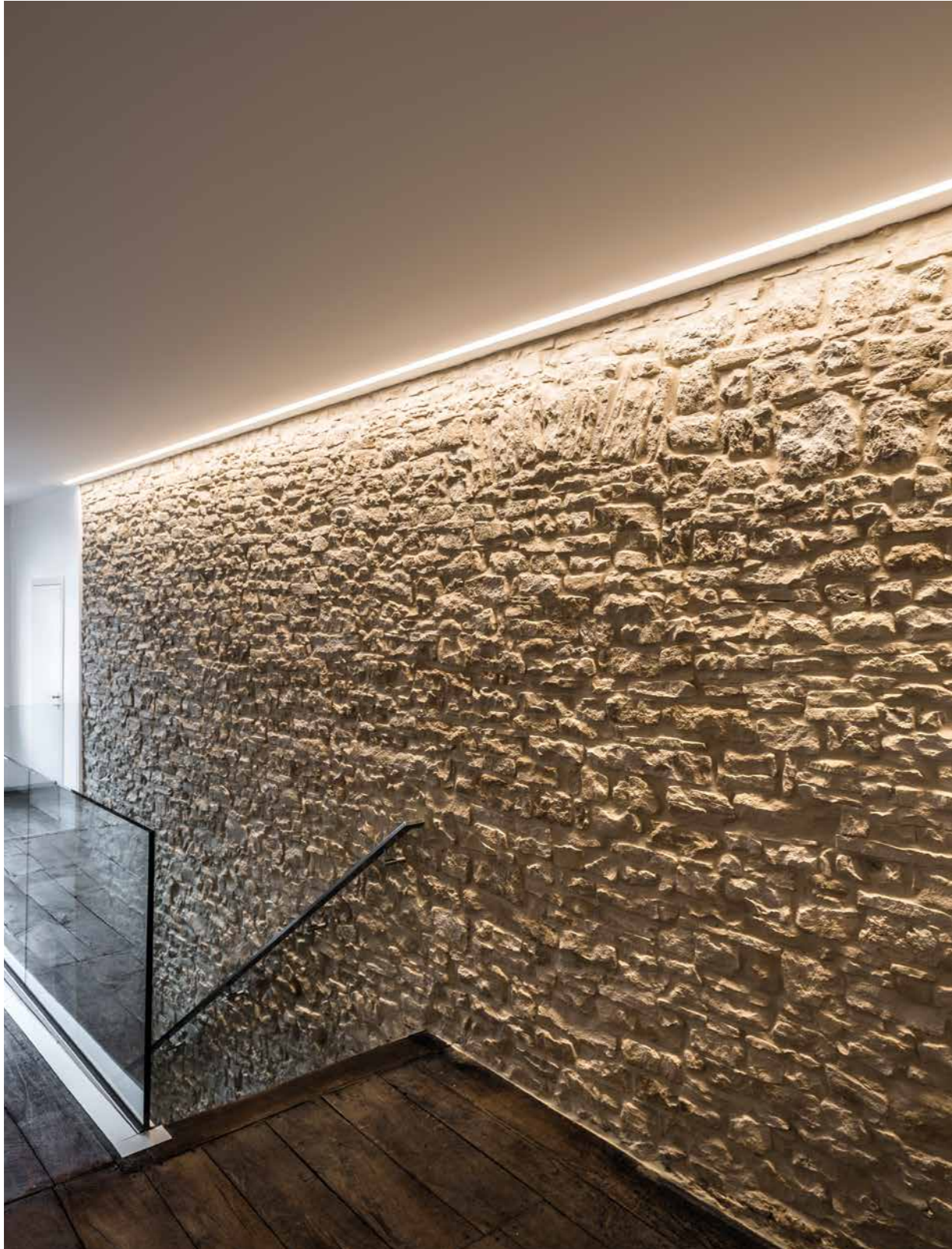

Private house Etalle

How to compose 2U Recessed

REQUEST CUSTOMER

SMALL RECESSED PROFILE
 WHITE COLOR
 TOTAL LIGHT OUTPUT ± 7500 LM
 TOTAL LENGTH ± 2M
 DALI DIMMABLE

TAL

Orderform

REF	DESCRIPTION	PCS/M
840047	PROFILE	1,96
840247	ENDCAP	2
894900	MOUNTING BRACKET	3
810772	MODULE 7X1100LM HO DALI DIMMABLE	1

Drawing

TOP VIEW

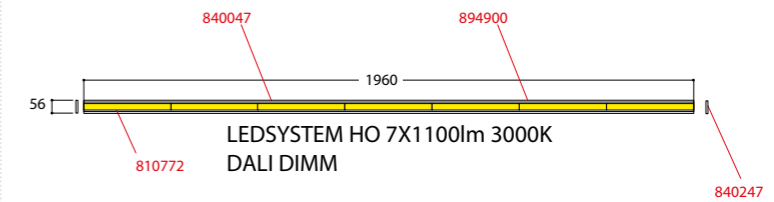

Section view

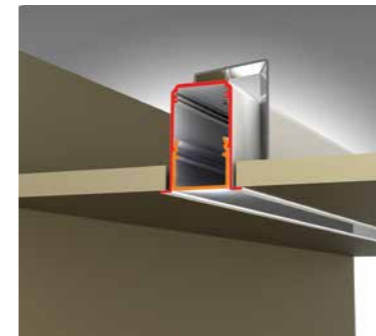
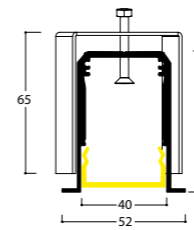

Profile/m

finish	
○	970047
●	970012
●	970026

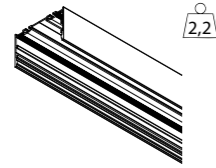

Endcap

finish	
○	970247
●	970212
●	970226

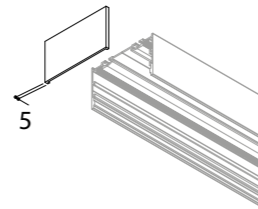

Diffuser/m & Alu Cover/m

finish	
Frosted Polycarbonate	860106
Prismatic Polycarbonate	860107
○	860147
●	860112
●	860126

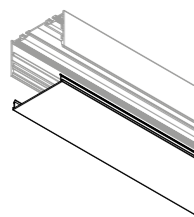

i To be used in empty profile spaces

Straight Connection

Straight Connection 979100

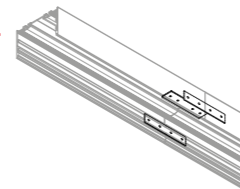

Corner

Corner 90°	979200
Corner 135°	979300
Corner 45°-85° on request	979400

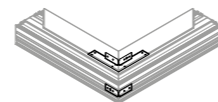

Extra Circuit/m

Common neutral	892630
No common neutral	892631



i Same length as profile

Wall Fixation

finish	
○	979047
●	979003
●	979026

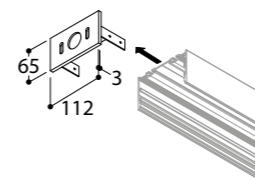

Boriti Surface & Boriti Suspended

i Surface



i Suspended



i Section view Surface

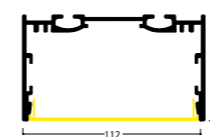

i Section view Suspended

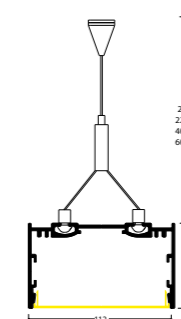

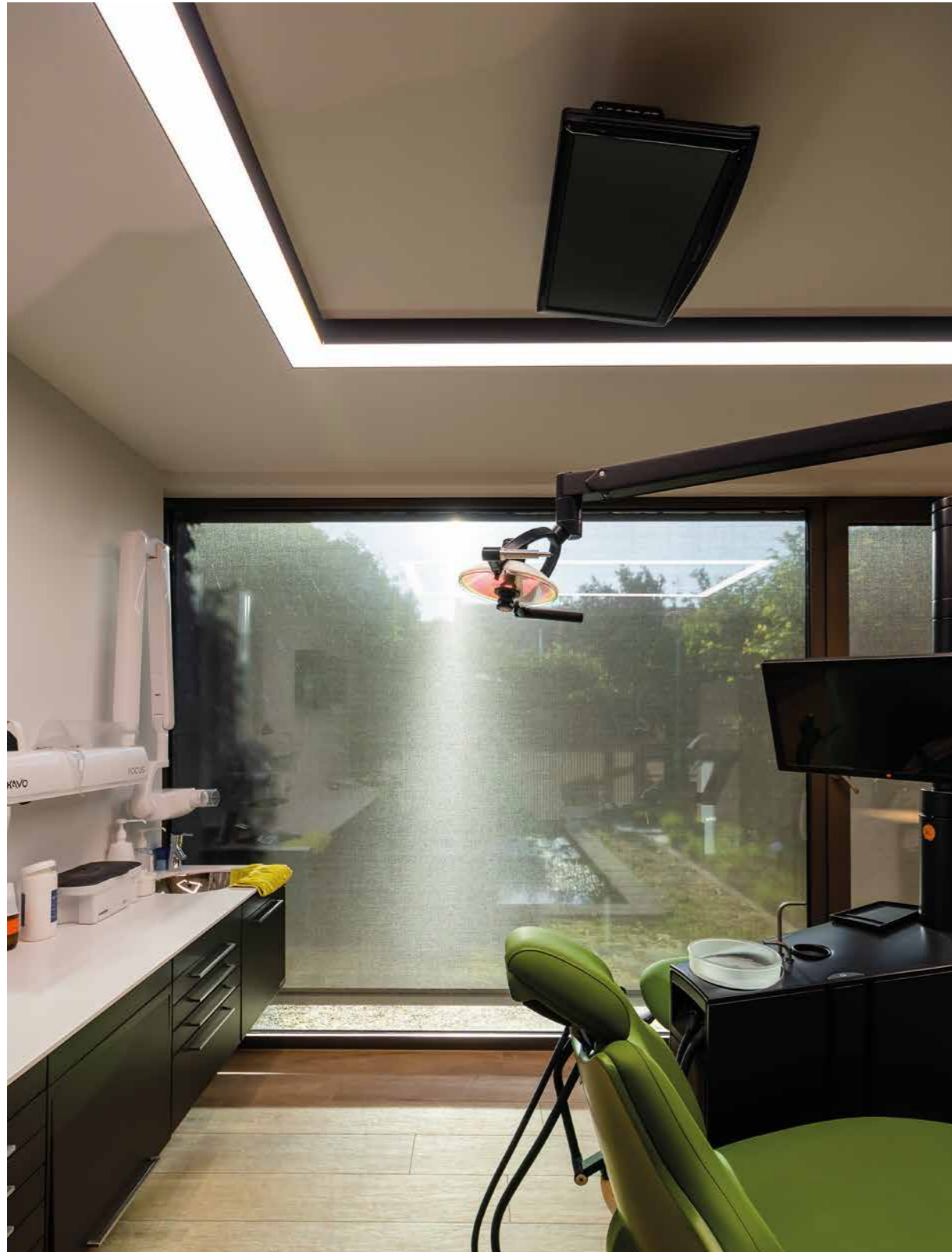

Dentist Brugge

Suspension Set

finish	2,25 M	4 M	6 M
○	895047	895147	895247
●	895030	895130	895230
●	895026	895126	895226

1 suspension/ 1 m profile
min. 2 suspensions

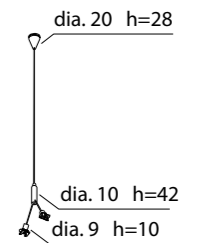

Connection Set Square

finish	3P			5P		
	2,25 m	4 m	6 m	2,25 m	4 m	6 m
○	890847	890947	891047	891147	891247	891347
●	890826	890926	891026	891126	891226	891326

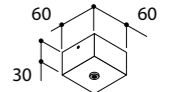

Connection Set Round

finish	3P			5P		
	2,25 m	4 m	6 m	2,25 m	4 m	6 m
○	691047	691147	691247	691347	691447	691547
●	691026	691126	691226	691326	691426	691526

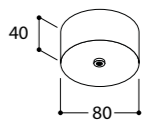

Connection Set Kosmos (recessed)

finish	3P			5P		
	2,25 m	4 m	6 m	2,25 m	4 m	6 m
○	691057	691157	691257	691357	691457	691557
●	691036	691136	691236	691336	691436	691536

56 mm
Installation depth 60 mm

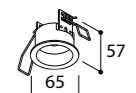

LEDSYSTEM Double Row HE - 4630 lm/meter

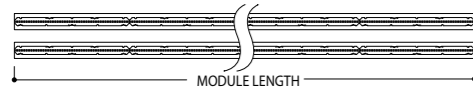

INPUT VOLTAGE 230V AC
 ⓘ Min. required space in profile



led lamps	diffuser	IP	2700K		3000K		4000K		power /W	length/ mm	length/ ft
			not dimm	dali/ touch	not dimm	dali/ touch	not dimm	dali/ touch			
Boriti Double Ledsystem HE 2x1300lm	Frosted PC	IP40	971726	971722	971724	971720	971725	971721	14	560	2
	Prismatic PC	IP40	971626	971622	971624	971620	971625	971621			
Boriti Double Ledsystem HE 3x1300lm	Frosted PC	IP40	971736	971732	971734	971730	971735	971731	21	840	3
	Prismatic PC	IP40	971636	971632	971634	971630	971635	971631			
Boriti Double Ledsystem HE 4x1300lm	Frosted PC	IP40	971746	971742	971744	971740	971745	971741	28	1120	4
	Prismatic PC	IP40	971646	971642	971644	971640	971645	971641			
Boriti Double Ledsystem HE 5x1300lm	Frosted PC	IP40	971756	971752	971754	971750	971755	971751	35	1400	5
	Prismatic PC	IP40	971656	971652	971654	971650	971655	971651			
Boriti Double Ledsystem HE 6x1300lm	Frosted PC	IP40	971766	971762	971764	971760	971765	971761	42	1680	6
	Prismatic PC	IP40	971666	971662	971664	971660	971665	971661			
Boriti Double Ledsystem HE 7x1300lm	Frosted PC	IP40	971776	971772	971774	971770	971775	971771	49	1960	7
	Prismatic PC	IP40	971676	971672	971674	971670	971675	971671			
Boriti Double Ledsystem HE 8x1300lm	Frosted PC	IP40	971786	971782	971784	971780	971785	971781	56	2240	8
	Prismatic PC	IP40	971686	971682	971684	971680	971685	971681			
Boriti Double Ledsystem HE 9x1300lm	Frosted PC	IP40	971796	971792	971794	971790	971795	971791	63	2520	9
	Prismatic PC	IP40	971696	971692	971694	971690	971695	971691			
Boriti Double Ledsystem HE 10x1300lm	Frosted PC	IP40	971706	971702	971704	971700	971705	971701	70	2800	10
	Prismatic PC	IP40	971606	971602	971604	971600	971605	971601			



ⓘ Section view surface

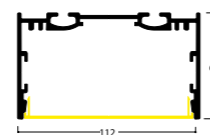

ⓘ Section view suspended

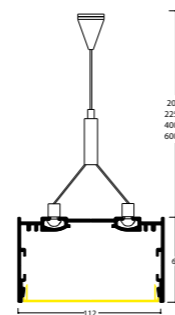

Module 1x Beaufort dali

CITIZEN - 6,22W - 230V 50-60Hz AC
 758 lumen 2700K CRI92
 dimmability: dali
 beam 36°

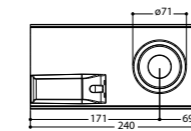

↻ 359° ↻ 30°

finish	2700K	3000K
○	972447	972457
●	972426	972436

- ⓘ Cover Textured White P/M 860147
- ⓘ Cover Ano P/M 860112
- ⓘ Cover Textured Black P/M 860126

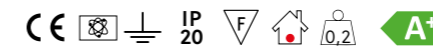

Module 1x Beaufort LC / 1-10V

CITIZEN - 6,22W - 230V 50-60Hz AC
 758 lumen 2700K CRI92
 dimmability: dimmable LC / 1-10V
 beam 36°

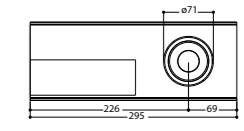

↻ 359° ↻ 30°

finish	2700K	3000K
○	972247	972257
●	972226	972236

- ⓘ Cover Textured White P/M 860147
- ⓘ Cover Ano P/M 860112
- ⓘ Cover Textured Black P/M 860126

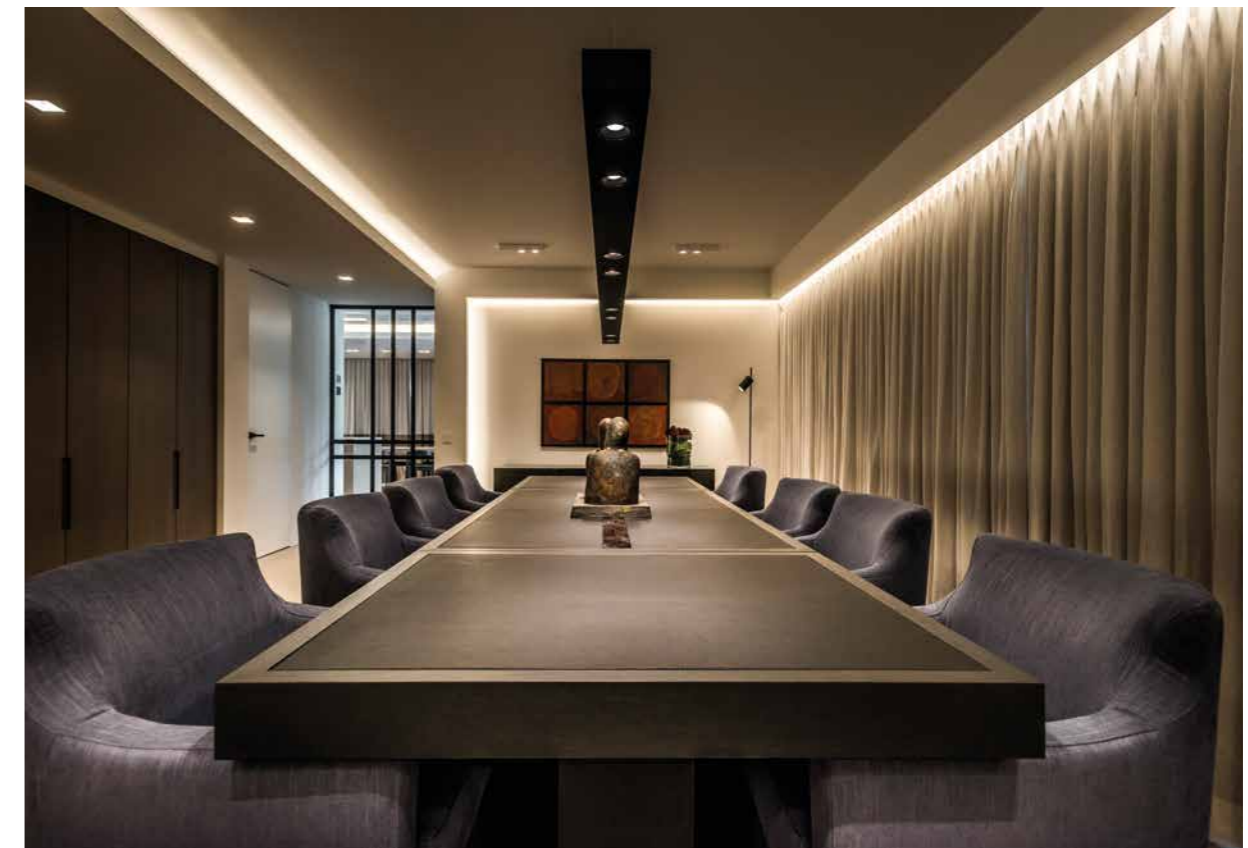

Private house Brussels

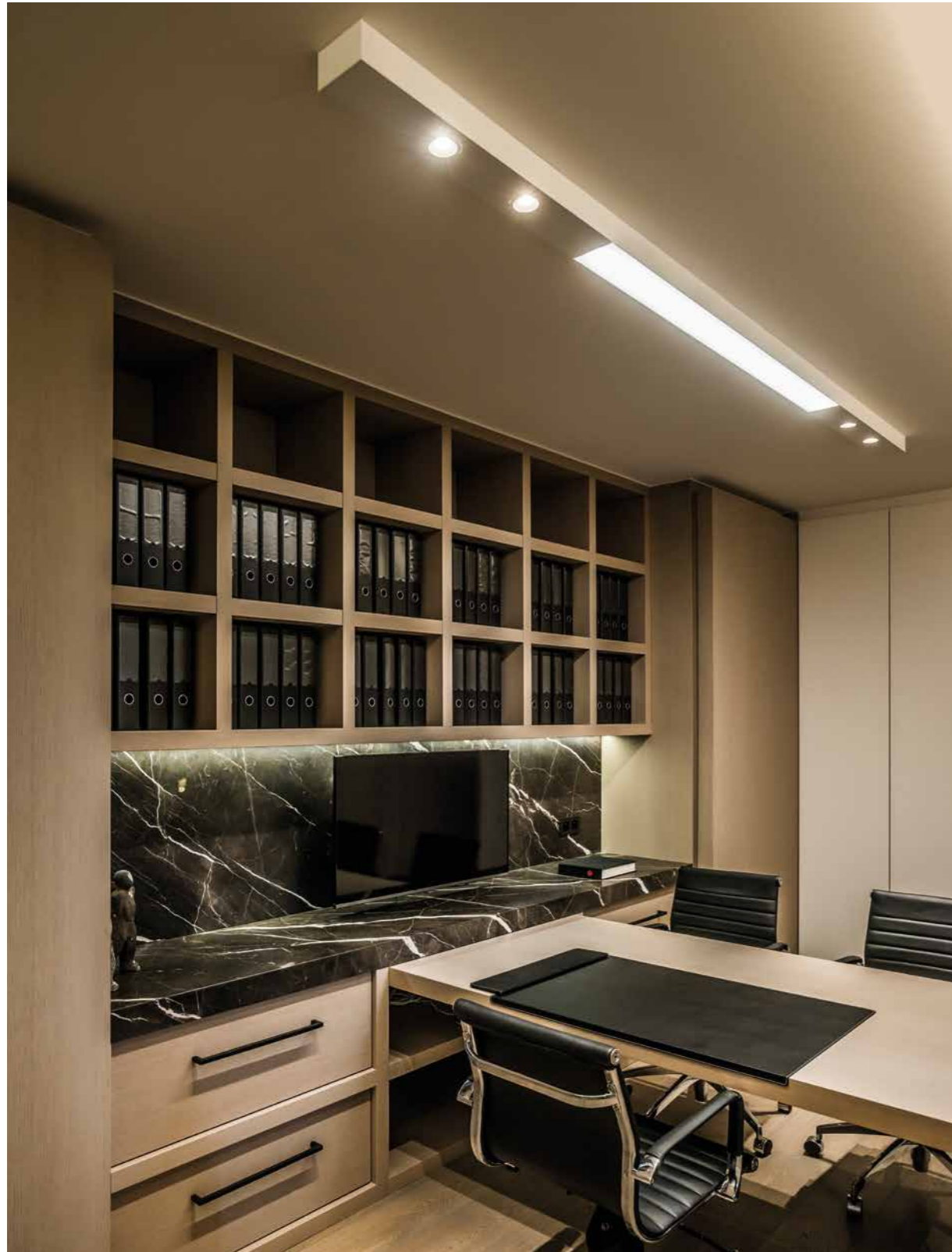

Private house Brussels

How to compose Boriti

REQUEST CUSTOMER

SLIM PROFILE 2,02 M
 BLACK COLOR
 4 ORIENTABLE LED SPOTLIGHTS
 SUSPENDED
 DIM PROTOCOL 1-10V

TAL

Orderform

REF	DESCRIPTION	PCS/M
970026	PROFILE TEXT BLACK	2,02
860126	COVER TEXT BLACK	2,02
970226	ENDCAP TEXT BLACK	2
972226	MODULE 1XBEAUFORT DIM 1-10V	4
895026	SUSPENSION SET	3
891126	BASE + CABLE 5P	1

Section view

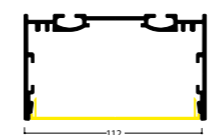

Drawing

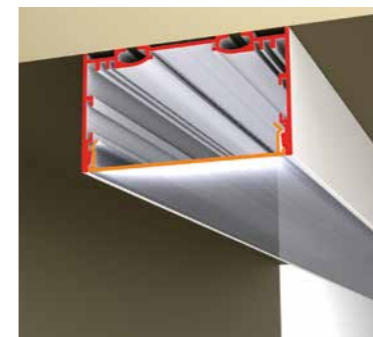
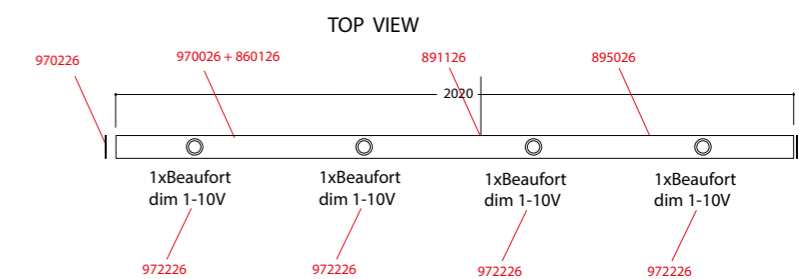

Profile/m

finish	
Silver Ano + Reflector Silver Ano	981012
Silver Ano + Reflector Text. White	981047

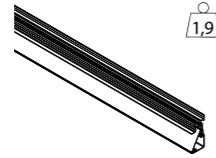

Exclusive PC Diffusor

Endcap

finish	
●	980212
○	980207

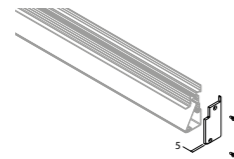

Straight Connection

Straight connection	988100
---------------------	--------

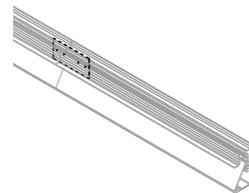

Section view

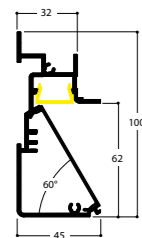

Built in scenario 1

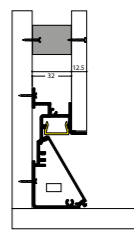

Built in scenario 2

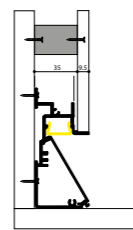

Built in scenario 3

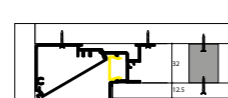

Built in scenario 4

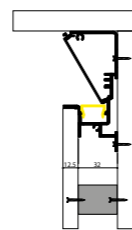

Horizontal Inner Corner

Inner corner 90°	988200
Inner corner 135°	988300
Inner corner 45°-85° on request	988400

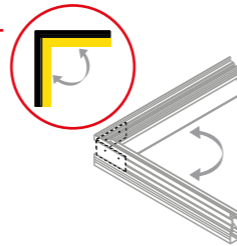

Horizontal Outer Corner

Outer corner 270°	988210
Outer corner 315°	988310
Outer corner 225°-265° on request	988410

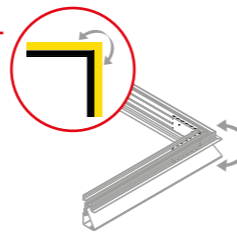

Vertical Corner

Corner 90°	988500
Corner 135°	988600
Corner 45°-85° on request	988700

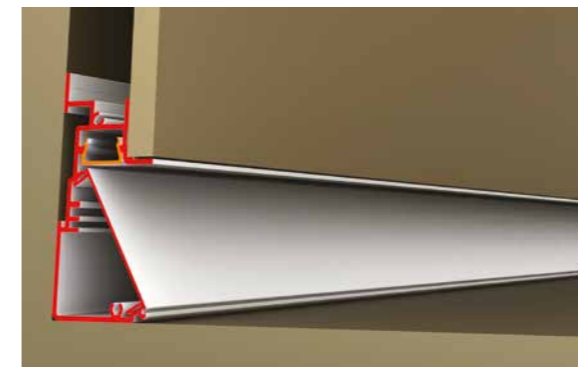
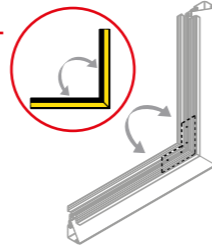

Module Ledline/m

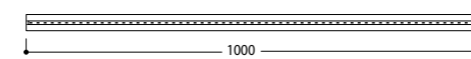

24V DC

polycarbonate diffuser included



color temperature	2700K		3000K		4000K	
	medium power	high power	medium power	high power	medium power	high power
REFERENCE	981179	981173	981172	981175	981170	981174
power	9,6W/m	14,4W/m	9,6W/m	14,4W/m	9,6W/m	14,4W/m
lumen output	672 lm/m	1010 lm/m	710 lm/m	1060 lm/m	740 lm/m	1100 lm/m
CRI	92	92	92	92	92	92
max. length 1 powerfeed	5 metres	5 metres	5 metres	5 metres	5 metres	5 metres
min. cutting length	50 mm	33,33 mm	50 mm	33,33 mm	50 mm	33,33 mm

Convertormodule 230V

Convertormodule 230V LED 24V – 20VA – dimmable 1-10V – IP20

988900

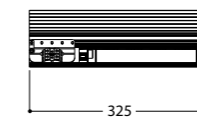

Convertormodule 230V LED 24V – 60VA

692930

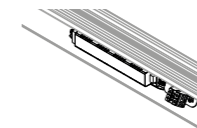
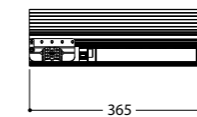

In combination with ledline no extra free space is required

Diffuser

'Through LED' Polycarbonate Diffuser

952006

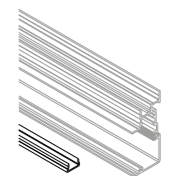

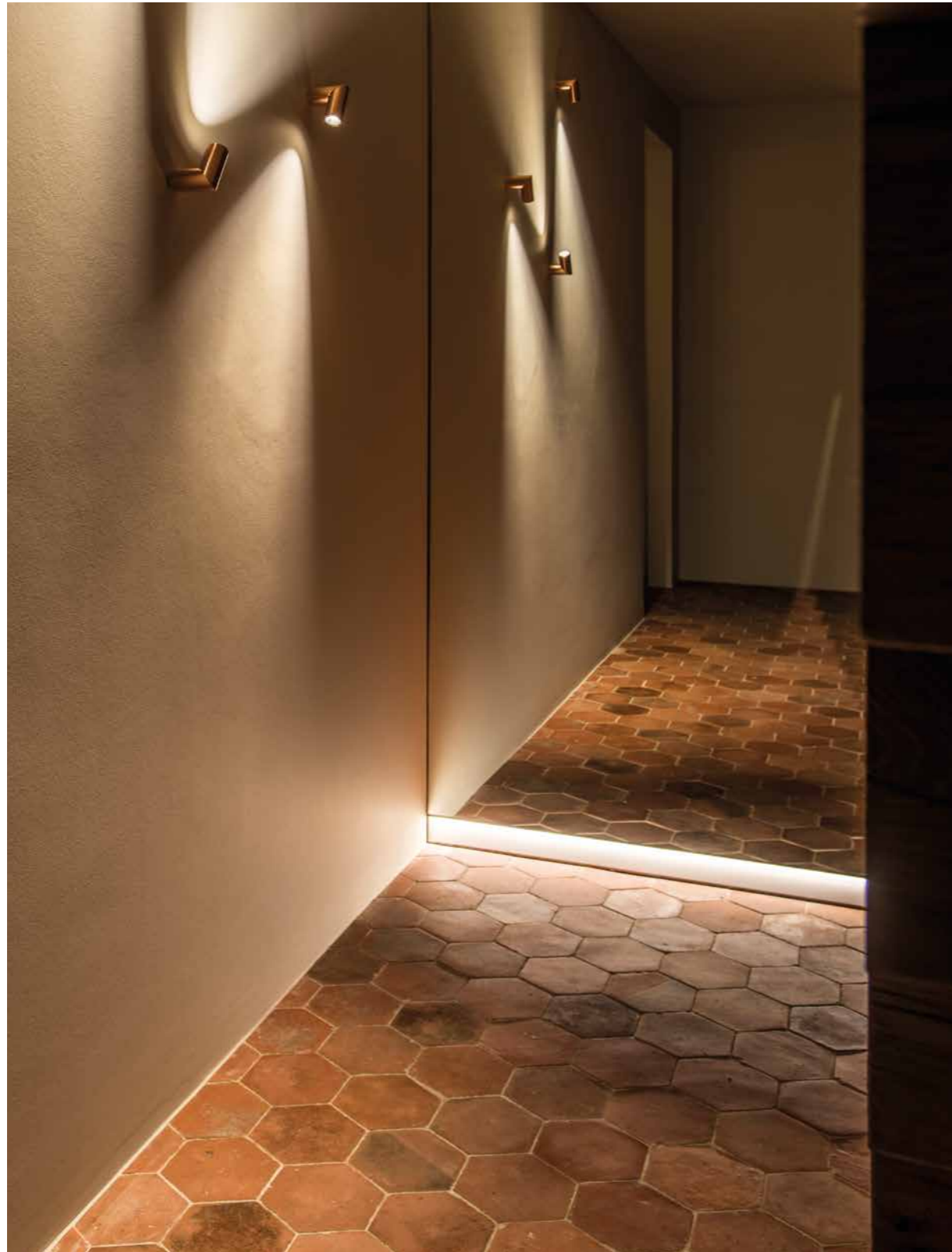

Franco Belge Brugge

How to compose Ductor

REQUEST CUSTOMER

INDIRECT PATHLIGHT
 TOTAL LENGTH = 6,5M
 WARM WHITE (RESIDENTIAL)
 AMBIENT LIGHT (SOFT LIGHT)
 + POWERED DIRECT BY MAINS (230V)

TAL

Orderform

REF	DESCRIPTION	PCS/M
981047	DUCTOR PROFILE TEXTURED WHITE	6,5 (3,5 + 1,5 + 1,5)
981179	LEDLINE 2700K MEDIUM POWER	6,5 (3,5 + 1,5 + 1,5)
988900	BUILT IN CONVERTOR 20W	2
988200	HORIZONTAL INNER CORNER 90°	1
980207	HORIZONTAL OUTER CORNER 270°	1

Drawing

Section view

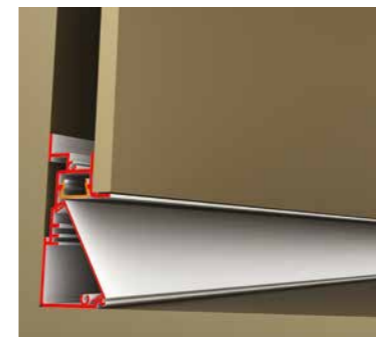
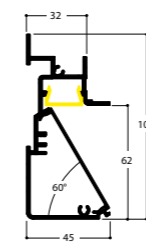

TOP VIEW

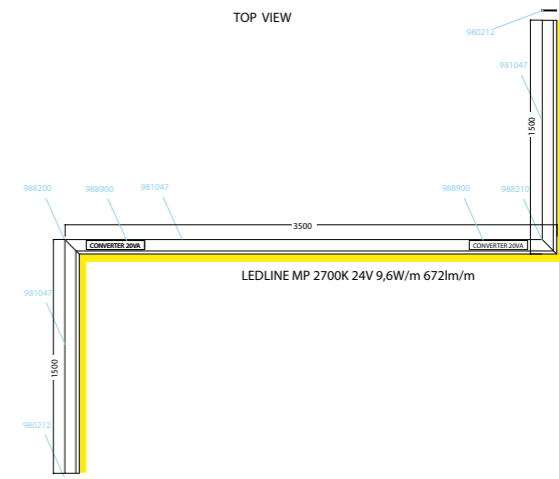

Profile/m

finish	
○	680047
●	680026

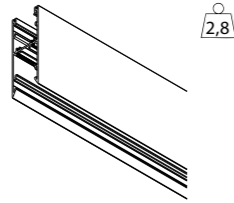

Endcap

finish	
○	680247
●	680226

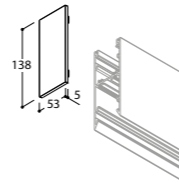

Diffuser/m & Alu Cover/m

finish	DOWN S	UP DIFF H
Frosted Polycarbonate	810106	810105
○	810147	
●	810126	



Diffuser/ Alu cover

Diffuser H



Straight Connection

Straight Connection	
	689101

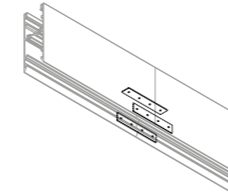

Corner

Corner 90°	950070
Corner 135°	950080
Corner 45° -85° on request	950090

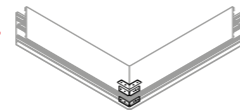

! To be used in empty profile spaces

Extra Circuit/m

Common neutral	892630
No common neutral	892631



! Same length as profile

Wall Fixation

finish	
○	689047
●	689026

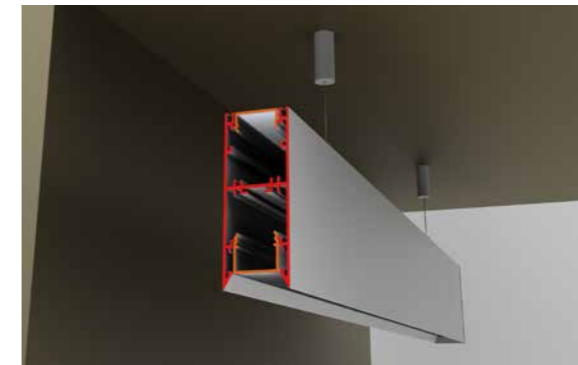
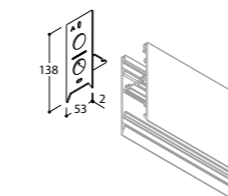

! Section view

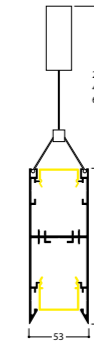

Suspension Set

finish	2,25 M	4 M	6 M
○	685047	685147	685247
●	685026	685126	685226

! 1 suspension/ m profile
min. 2 suspensions

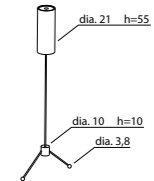

Connection Set Square

finish	3P			5P		
	2,25 m	4 m	6 m	2,25 m	4 m	6 m
○	890847	890947	891047	891147	891247	891347
●	890826	890926	891026	891126	891226	891326

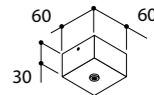

Connection Set Round

finish	3P			5P		
	2,25 m	4 m	6 m	2,25 m	4 m	6 m
○	691047	691147	691247	691347	691447	691547
●	691026	691126	691226	691326	691426	691526

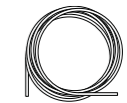
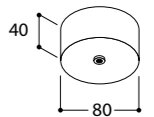

Connection Set Kosmos (recessed)

finish	3P			5P		
	2,25 m	4 m	6 m	2,25 m	4 m	6 m
○	691057	691157	691257	691357	691457	691557
●	691036	691136	691236	691336	691436	691536

! 56 mm
Installation depth 60 mm





Deca Herentals

Ledsystem HE - 2315 lm/meter - Down



INPUT VOLTAGE 230V AC
i Min. required space in profile



Combination table		UP	
		HE	HO
DOWN	HE	✓	✓
	HO	✓	N/A

2700K							
led lamps	diffuser	IP	not dimm		power /W	length/mm	length /ft
				dali/touch			
Ludo Ledsystem Down HE 2x650lm	Frosted PC S	IP40	681724	681720	7	560	2
Ludo Ledsystem Down HE 3x650lm	Frosted PC S	IP40	681734	681730	10,5	840	3
Ludo Ledsystem Down HE 4x650lm	Frosted PC S	IP40	681744	681740	14	1120	4
Ludo Ledsystem Down HE 5x650lm	Frosted PC S	IP40	681754	681750	17,5	1400	5
Ludo Ledsystem Down HE 6x650lm	Frosted PC S	IP40	681764	681760	21	1680	6
Ludo Ledsystem Down HE 7x650lm	Frosted PC S	IP40	681774	681770	24,5	1960	7
Ludo Ledsystem Down HE 8x650lm	Frosted PC S	IP40	681784	681780	28	2240	8
Ludo Ledsystem Down HE 9x650lm	Frosted PC S	IP40	681794	681790	31,5	2520	9
Ludo Ledsystem Down HE 10x650lm	Frosted PC S	IP40	681704	681700	35	2800	10

3000K							
led lamps	diffuser	IP	not dimm		power /W	length/mm	length /ft
				dali/touch			
Ludo Ledsystem Down HE 2x650lm	Frosted PC S	IP40	681824	681820	7	560	2
Ludo Ledsystem Down HE 3x650lm	Frosted PC S	IP40	681834	681830	10,5	840	3
Ludo Ledsystem Down HE 4x650lm	Frosted PC S	IP40	681844	681840	14	1120	4
Ludo Ledsystem Down HE 5x650lm	Frosted PC S	IP40	681854	681850	17,5	1400	5
Ludo Ledsystem Down HE 6x650lm	Frosted PC S	IP40	681864	681860	21	1680	6
Ludo Ledsystem Down HE 7x650lm	Frosted PC S	IP40	681874	681870	24,5	1960	7
Ludo Ledsystem Down HE 8x650lm	Frosted PC S	IP40	681884	681880	28	2240	8
Ludo Ledsystem Down HE 9x650lm	Frosted PC S	IP40	681894	681890	31,5	2520	9
Ludo Ledsystem Down HE 10x650lm	Frosted PC S	IP40	681804	681800	35	2800	10

4000K							
led lamps	diffuser	IP	not dimm		power /W	length/mm	length /ft
				dali/touch			
Ludo Ledsystem Down HE 2x650lm	Frosted PC S	IP40	681924	681920	7	560	2
Ludo Ledsystem Down HE 3x650lm	Frosted PC S	IP40	681934	681930	10,5	840	3
Ludo Ledsystem Down HE 4x650lm	Frosted PC S	IP40	681944	681940	14	1120	4
Ludo Ledsystem Down HE 5x650lm	Frosted PC S	IP40	681954	681950	17,5	1400	5
Ludo Ledsystem Down HE 6x650lm	Frosted PC S	IP40	681964	681960	21	1680	6
Ludo Ledsystem Down HE 7x650lm	Frosted PC S	IP40	681974	681970	24,5	1960	7
Ludo Ledsystem Down HE 8x650lm	Frosted PC S	IP40	681984	681980	28	2240	8
Ludo Ledsystem Down HE 9x650lm	Frosted PC S	IP40	681994	681990	31,5	2520	9
Ludo Ledsystem Down HE 10x650lm	Frosted PC S	IP40	681904	681900	35	2800	10

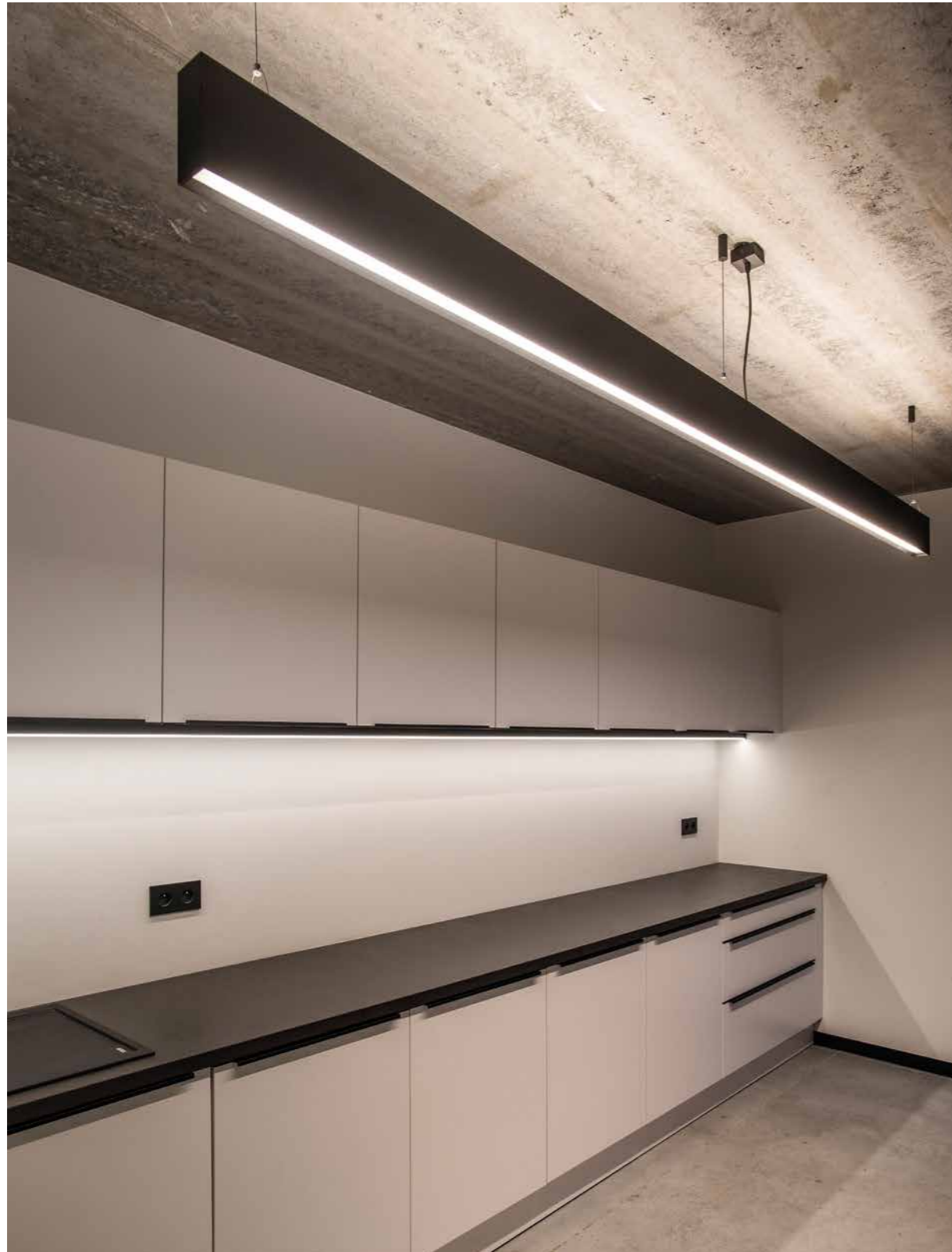

TAL Headquarters

Ledsystem HO - 3925 lm/meter - Down



Zhaga CE RoHS F

INPUT VOLTAGE 230V AC
 ⓘ Min. required space in profile

Combination table		UP	
		HE	HO
DOWN	HE	✓	✓
	HO	✓	N/A

2700K							
led lamps	diffuser	IP			power /W	length/ mm	length /ft
			not dimm	dali/touch			
Ludo Ledsystem Down HO 2x1100lm	Frosted PC S	IP40	681726	681722	11,6	560	2
Ludo Ledsystem Down HO 3x1100lm	Frosted PC S	IP40	681736	681732	17,4	840	3
Ludo Ledsystem Down HO 4x1100lm	Frosted PC S	IP40	681746	681742	23,2	1120	4
Ludo Ledsystem Down HO 5x1100lm	Frosted PC S	IP40	681756	681752	29	1400	5
Ludo Ledsystem Down HO 6x1100lm	Frosted PC S	IP40	681766	681762	34,8	1680	6
Ludo Ledsystem Down HO 7x1100lm	Frosted PC S	IP40	681776	681772	40,6	1960	7
Ludo Ledsystem Down HO 8x1100lm	Frosted PC S	IP40	681786	681782	46,4	2240	8
Ludo Ledsystem Down HO 9x1100lm	Frosted PC S	IP40	681796	681792	52,2	2520	9
Ludo Ledsystem Down HO 10x1100lm	Frosted PC S	IP40	681706	681702	58	2800	10

3000K							
led lamps	diffuser	IP			power /W	length/ mm	length /ft
			not dimm	dali/touch			
Ludo Ledsystem Down HO 2x1100lm	Frosted PC S	IP40	681826	681822	11,6	560	2
Ludo Ledsystem Down HO 3x1100lm	Frosted PC S	IP40	681836	681832	17,4	840	3
Ludo Ledsystem Down HO 4x1100lm	Frosted PC S	IP40	681846	681842	23,2	1120	4
Ludo Ledsystem Down HO 5x1100lm	Frosted PC S	IP40	681856	681852	29	1400	5
Ludo Ledsystem Down HO 6x1100lm	Frosted PC S	IP40	681866	681862	34,8	1680	6
Ludo Ledsystem Down HO 7x1100lm	Frosted PC S	IP40	681876	681872	40,6	1960	7
Ludo Ledsystem Down HO 8x1100lm	Frosted PC S	IP40	681886	681882	46,4	2240	8
Ludo Ledsystem Down HO 9x1100lm	Frosted PC S	IP40	681896	681892	52,2	2520	9
Ludo Ledsystem Down HO 10x1100lm	Frosted PC S	IP40	681806	681802	58	2800	10

4000K							
led lamps	diffuser	IP			power /W	length/ mm	length /ft
			not dimm	dali/touch			
Ludo Ledsystem Down HO 2x1100lm	Frosted PC S	IP40	681926	681922	11,6	560	2
Ludo Ledsystem Down HO 3x1100lm	Frosted PC S	IP40	681936	681932	17,4	840	3
Ludo Ledsystem Down HO 4x1100lm	Frosted PC S	IP40	681946	681942	23,2	1120	4
Ludo Ledsystem Down HO 5x1100lm	Frosted PC S	IP40	681956	681952	29	1400	5
Ludo Ledsystem Down HO 6x1100lm	Frosted PC S	IP40	681966	681962	34,8	1680	6
Ludo Ledsystem Down HO 7x1100lm	Frosted PC S	IP40	681976	681972	40,6	1960	7
Ludo Ledsystem Down HO 8x1100lm	Frosted PC S	IP40	681986	681982	46,4	2240	8
Ludo Ledsystem Down HO 9x1100lm	Frosted PC S	IP40	681996	681992	52,2	2520	9
Ludo Ledsystem Down HO 10x1100lm	Frosted PC S	IP40	681906	681902	58	2800	10

Ledsystem HE - 2315 lm/meter - Up



INPUT VOLTAGE 230V AC
i Min. required space in profile



Combination table		UP	
		HE	HO
DOWN	HE	✓	✓
	HO	✓	N/A

2700K

led lamps	diffuser	IP	not dimm		power /W	length/mm	length/ft
				dali/touch			
Ludo Ledsystem Up HE 2x650lm	Frosted PC H	IP40	682724	682720	7	560	2
Ludo Ledsystem Up HE 3x650lm	Frosted PC H	IP40	682734	682730	10,5	840	3
Ludo Ledsystem Up HE 4x650lm	Frosted PC H	IP40	682744	682740	14	1120	4
Ludo Ledsystem Up HE 5x650lm	Frosted PC H	IP40	682754	682750	17,5	1400	5
Ludo Ledsystem Up HE 6x650lm	Frosted PC H	IP40	682764	682760	21	1680	6
Ludo Ledsystem Up HE 7x650lm	Frosted PC H	IP40	682774	682770	24,5	1960	7
Ludo Ledsystem Up HE 8x650lm	Frosted PC H	IP40	682784	682780	28	2240	8
Ludo Ledsystem Up HE 9x650lm	Frosted PC H	IP40	682794	682790	31,5	2520	9
Ludo Ledsystem Up HE 10x650lm	Frosted PC H	IP40	682704	682700	35	2800	10

3000K

led lamps	diffuser	IP	not dimm		power /W	length/mm	length/ft
				dali/touch			
Ludo Ledsystem Up HE 2x650lm	Frosted PC H	IP40	682824	682820	7	560	2
Ludo Ledsystem Up HE 3x650lm	Frosted PC H	IP40	682834	682830	10,5	840	3
Ludo Ledsystem Up HE 4x650lm	Frosted PC H	IP40	682844	682840	14	1120	4
Ludo Ledsystem Up HE 5x650lm	Frosted PC H	IP40	682854	682850	17,5	1400	5
Ludo Ledsystem Up HE 6x650lm	Frosted PC H	IP40	682864	682860	21	1680	6
Ludo Ledsystem Up HE 7x650lm	Frosted PC H	IP40	682874	682870	24,5	1960	7
Ludo Ledsystem Up HE 8x650lm	Frosted PC H	IP40	682884	682880	28	2240	8
Ludo Ledsystem Up HE 9x650lm	Frosted PC H	IP40	682894	682890	31,5	2520	9
Ludo Ledsystem Up HE 10x650lm	Frosted PC H	IP40	682804	682800	35	2800	10

4000K

led lamps	diffuser	IP	not dimm		power /W	length/mm	length/ft
				dali/touch			
Ludo Ledsystem Up HE 2x650lm	Frosted PC H	IP40	682924	682920	7	560	2
Ludo Ledsystem Up HE 3x650lm	Frosted PC H	IP40	682934	682930	10,5	840	3
Ludo Ledsystem Up HE 4x650lm	Frosted PC H	IP40	682944	682940	14	1120	4
Ludo Ledsystem Up HE 5x650lm	Frosted PC H	IP40	682954	682950	17,5	1400	5
Ludo Ledsystem Up HE 6x650lm	Frosted PC H	IP40	682964	682960	21	1680	6
Ludo Ledsystem Up HE 7x650lm	Frosted PC H	IP40	682974	682970	24,5	1960	7
Ludo Ledsystem Up HE 8x650lm	Frosted PC H	IP40	682984	682980	28	2240	8
Ludo Ledsystem Up HE 9x650lm	Frosted PC H	IP40	682994	682990	31,5	2520	9
Ludo Ledsystem Up HE 10x650lm	Frosted PC H	IP40	682904	682900	35	2800	10

Ledsystem HO - 3925 lm/meter - Up



INPUT VOLTAGE 230V AC
i Min. required space in profile



Combination table		UP	
		HE	HO
DOWN	HE	✓	✓
	HO	✓	N/A

2700K

led lamps	diffuser	IP	not dimm		power /W	length/mm	length/ft
				dali/touch			
Ludo Ledsystem Up HO 2x1100lm	Frosted PC H	IP40	682726	682722	11,6	560	2
Ludo Ledsystem Up HO 3x1100lm	Frosted PC H	IP40	682736	682732	17,4	840	3
Ludo Ledsystem Up HO 4x1100lm	Frosted PC H	IP40	682746	682742	23,2	1120	4
Ludo Ledsystem Up HO 5x1100lm	Frosted PC H	IP40	682756	682752	29	1400	5
Ludo Ledsystem Up HO 6x1100lm	Frosted PC H	IP40	682766	682762	34,8	1680	6
Ludo Ledsystem Up HO 7x1100lm	Frosted PC H	IP40	682776	682772	40,6	1960	7
Ludo Ledsystem Up HO 8x1100lm	Frosted PC H	IP40	682786	682782	46,4	2240	8
Ludo Ledsystem Up HO 9x1100lm	Frosted PC H	IP40	682796	682792	52,2	2520	9
Ludo Ledsystem Up HO 10x1100lm	Frosted PC H	IP40	682706	682702	58	2800	10

3000K

led lamps	diffuser	IP	not dimm		power /W	length/mm	length/ft
				dali/touch			
Ludo Ledsystem Up HO 2x1100lm	Frosted PC H	IP40	682826	682822	11,6	560	2
Ludo Ledsystem Up HO 3x1100lm	Frosted PC H	IP40	682836	682832	17,4	840	3
Ludo Ledsystem Up HO 4x1100lm	Frosted PC H	IP40	682846	682842	23,2	1120	4
Ludo Ledsystem Up HO 5x1100lm	Frosted PC H	IP40	682856	682852	29	1400	5
Ludo Ledsystem Up HO 6x1100lm	Frosted PC H	IP40	682866	682862	34,8	1680	6
Ludo Ledsystem Up HO 7x1100lm	Frosted PC H	IP40	682876	682872	40,6	1960	7
Ludo Ledsystem Up HO 8x1100lm	Frosted PC H	IP40	682886	682882	46,4	2240	8
Ludo Ledsystem Up HO 9x1100lm	Frosted PC H	IP40	682896	682892	52,2	2520	9
Ludo Ledsystem Up HO 10x1100lm	Frosted PC H	IP40	682806	682802	58	2800	10

4000K

led lamps	diffuser	IP	not dimm		power /W	length/mm	length/ft
				dali/touch			
Ludo Ledsystem Up HO 2x1100lm	Frosted PC H	IP40	682926	682922	11,6	560	2
Ludo Ledsystem Up HO 3x1100lm	Frosted PC H	IP40	682936	682932	17,4	840	3
Ludo Ledsystem Up HO 4x1100lm	Frosted PC H	IP40	682946	682942	23,2	1120	4
Ludo Ledsystem Up HO 5x1100lm	Frosted PC H	IP40	682956	682952	29	1400	5
Ludo Ledsystem Up HO 6x1100lm	Frosted PC H	IP40	682966	682962	34,8	1680	6
Ludo Ledsystem Up HO 7x1100lm	Frosted PC H	IP40	682976	682972	40,6	1960	7
Ludo Ledsystem Up HO 8x1100lm	Frosted PC H	IP40	682986	682982	46,4	2240	8
Ludo Ledsystem Up HO 9x1100lm	Frosted PC H	IP40	682996	682992	52,2	2520	9
Ludo Ledsystem Up HO 10x1100lm	Frosted PC H	IP40	682906	682902	58	2800	10

Module Ledline/m CR (convertor can be incorporated)

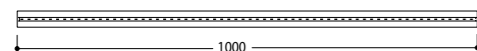

24V DC



i polycarbonate diffuser included

color temperature	2700K			3000K			4000K		
	medium power	high power	very high power	medium power	high power	very high power	medium power	high power	very high power
DOWN (DIFFUSER S)	682179	682173	682176	682172	682175	682177	682170	682174	682178
UP (DIFFUSER H)	682079	682073	682076	682072	682075	682077	682070	682074	682078
power	9,6W/m	14,4W/m	19,2W/m	9,6W/m	14,4W/m	19,2W/m	9,6W/m	14,4W/m	19,2W/m
lumen output	672 lm/m	1010 lm/m	2208 lm/m	710 lm/m	1060 lm/m	2208 lm/m	740 lm/m	1100 lm/m	2323 lm/m
CRI	92	92	92	92	92	92	92	92	92
max. length 1 powerfeed	5 metres	5 metres	5 metres	5 metres	5 metres	5 metres	5 metres	5 metres	5 metres
min. cutting length	50 mm	33,33 mm	33,33 mm	50 mm	33,33 mm	33,33 mm	50 mm	33,33 mm	33,33 mm

Integrated converter

input 230 V-AC
output 24V-DC
power 20W

i fits in Ludo profile
(no extra space required)

	1-10V DIMM
Ludo Converter module	692910

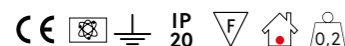

Integrated converter

input 230 V-AC
output 24V-DC
power 60W

i fits in Ludo profile
(no extra space required)

	NOT DIMM	1-10V	DALI DIMM
Ludo Converter module	692930	692940	692950

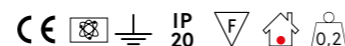

Module 1 x Luxeon M

LUXEON M - 3,82W - 230V 50-60Hz AC

400 lumen 2700K CRI90
429 lumen 3000K CRI90

dimmability: mains dim LC

HALOSPHERE - 4,25W - 230V 50-60Hz AC

455 lumen 1800K ▶ 3000K CRI90

dimmability: mains dim LC

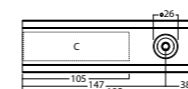

finish	2700K	3000K	1800K-3000K
○	683202	683262	683242
●	683203	683263	683243
●	683205	683265	683245
i Cover Textured White P/M			810847
i Cover Textured Black P/M			810826

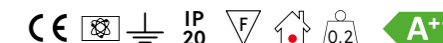

Module 2 x Luxeon M

LUXEON M - (2x) 3,82W - 230V 50-60Hz AC

2x 400 lumen 2700K CRI90

2x 429 lumen 3000K CRI90

dimmability: mains dim LC

HALOSPHERE - (2x) 4,25W - 230V 50-60Hz AC

2x 455 lumen 1800K ▶ 3000K CRI90

dimmability: mains dim LC

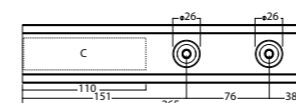

finish	2700K	3000K	1800K-3000K
○	683206	683266	683246
●	683207	683267	683247
●	683209	683268	683248
i Cover Textured White P/M			810847
i Cover Textured Black P/M			810826

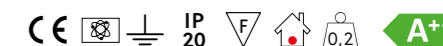

Module 3 x Luxeon M

LUXEON M - (3x) 3,82W - 230V 50-60Hz AC

3x 400 lumen 2700K CRI90

3x 429 lumen 3000K CRI90

dimmability: mains dim LC

HALOSPHERE - (3x) 4,25W - 230V 50-60Hz AC

3x 455 lumen 1800K ▶ 3000K CRI90

dimmability: mains dim LC

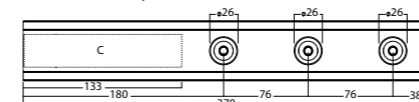

finish	2700K	3000K	1800K-3000K
○	683212	683272	683252
●	683213	683273	683253
●	683215	683275	683255
i Cover Textured White P/M			810847
i Cover Textured Black P/M			810826

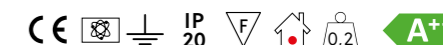

Module 4 x Luxeon M

LUXEON M - (4x) 3,82W - 230V 50-60Hz AC

4x 400 lumen 2700K CRI90

4x 429 lumen 3000K CRI90

dimmability: mains dim LC

HALOSPHERE - (4x) 4,25W - 230V 50-60Hz AC

4x 455 lumen 1800K ▶ 3000K CRI90

dimmability: mains dim LC

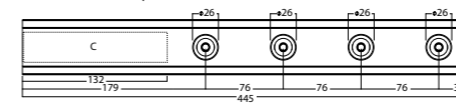

finish	2700K	3000K	1800K-3000K
○	683216	683276	683256
●	683217	683277	683257
●	683219	683279	683259
i Cover Textured White P/M			810847
i Cover Textured Black P/M			810826

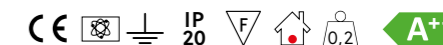

i All distances between led modules are always minimum dimensions

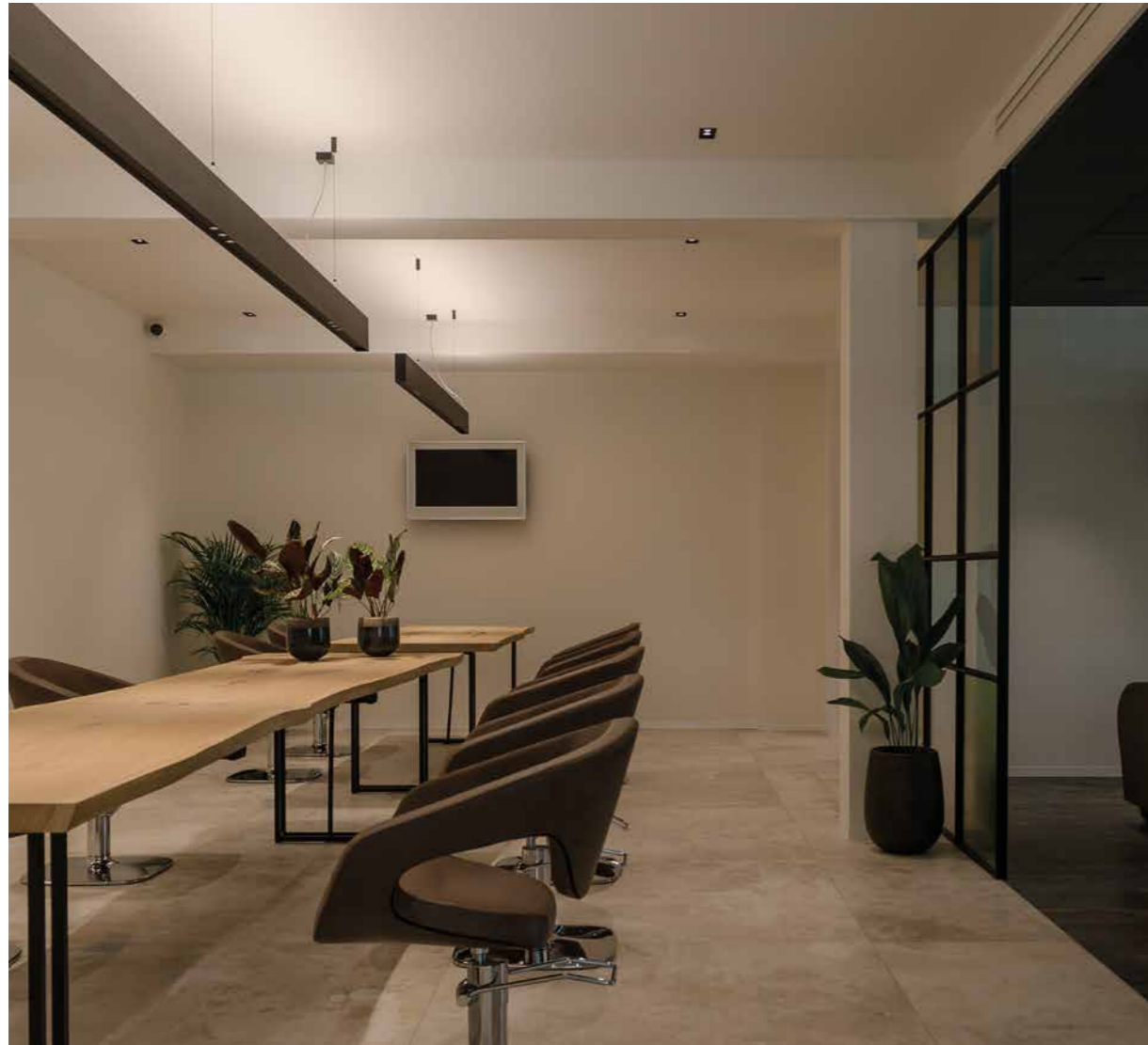

Nelson Hairteam Destelbergen

Maximum tilt angles

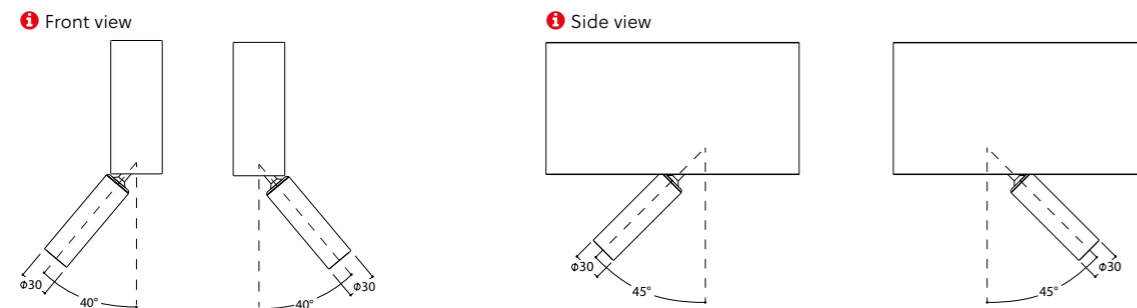

Module 1 x Bulled

LUXEON M - 3,82W - 230V 50-60Hz AC
 400 lumen 2700K CRI90
 429 lumen 3000K CRI90
 dimmability: mains dim LC

HALOSPHERE - 4,25W - 230V 50-60Hz AC
 455 lumen 1800K ▶ 3000K CRI90
 dimmability: mains dim LC



finish	2700K	3000K	1800K-3000K
○	684202	684262	684242
●	684203	684263	684243
●+●	684205	684265	684245
📌	Cover Textured White P/M		810147
📌	Cover Textured Black P/M		810126



Module 2 x Bulled

LUXEON M - (2x) 3,82W - 230V 50-60Hz AC
 2x 400 lumen 2700K CRI90
 2x 429 lumen 3000K CRI90
 dimmability: mains dim LC

HALOSPHERE - (2x) 4,25W - 230V 50-60Hz AC
 2x 455 lumen 1800K ▶ 3000K CRI90
 dimmability: mains dim LC

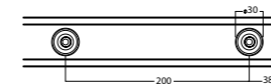

finish	2700K	3000K	1800K-3000K
○	684206	684266	684246
●	684207	684267	684247
●+●	684209	684268	684248
📌	Cover Textured White P/M		810147
📌	Cover Textured Black P/M		810126



Module 3 x Bulled

LUXEON M - (3x) 3,82W - 230V 50-60Hz AC
 3x 400 lumen 2700K CRI90
 3x 429 lumen 3000K CRI90
 dimmability: mains dim LC

HALOSPHERE - (3x) 4,25W - 230V 50-60Hz AC
 3x 455 lumen 1800K ▶ 3000K CRI90
 dimmability: mains dim LC

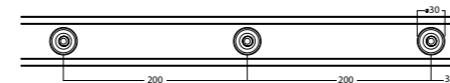

finish	2700K	3000K	1800K-3000K
○	684212	684272	684252
●	684213	684273	684253
●+●	684215	684275	684255
📌	Cover Textured White P/M		810147
📌	Cover Textured Black P/M		810126



Module 4 x Bulled

LUXEON M - (4x) 3,82W - 230V 50-60Hz AC
 4x 400 lumen 2700K CRI90
 4x 429 lumen 3000K CRI90
 dimmability: mains dim LC

HALOSPHERE - (4x) 4,25W - 230V 50-60Hz AC
 4x 455 lumen 1800K ▶ 3000K CRI90
 dimmability: mains dim LC

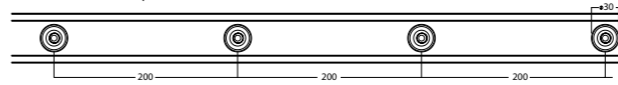

finish	2700K	3000K	1800K-3000K
○	684216	684276	684256
●	684217	684277	684257
●+●	684219	684279	684259
📌	Cover Textured White P/M		810147
📌	Cover Textured Black P/M		810126



📌 All distances between led modules are always minimum dimensions

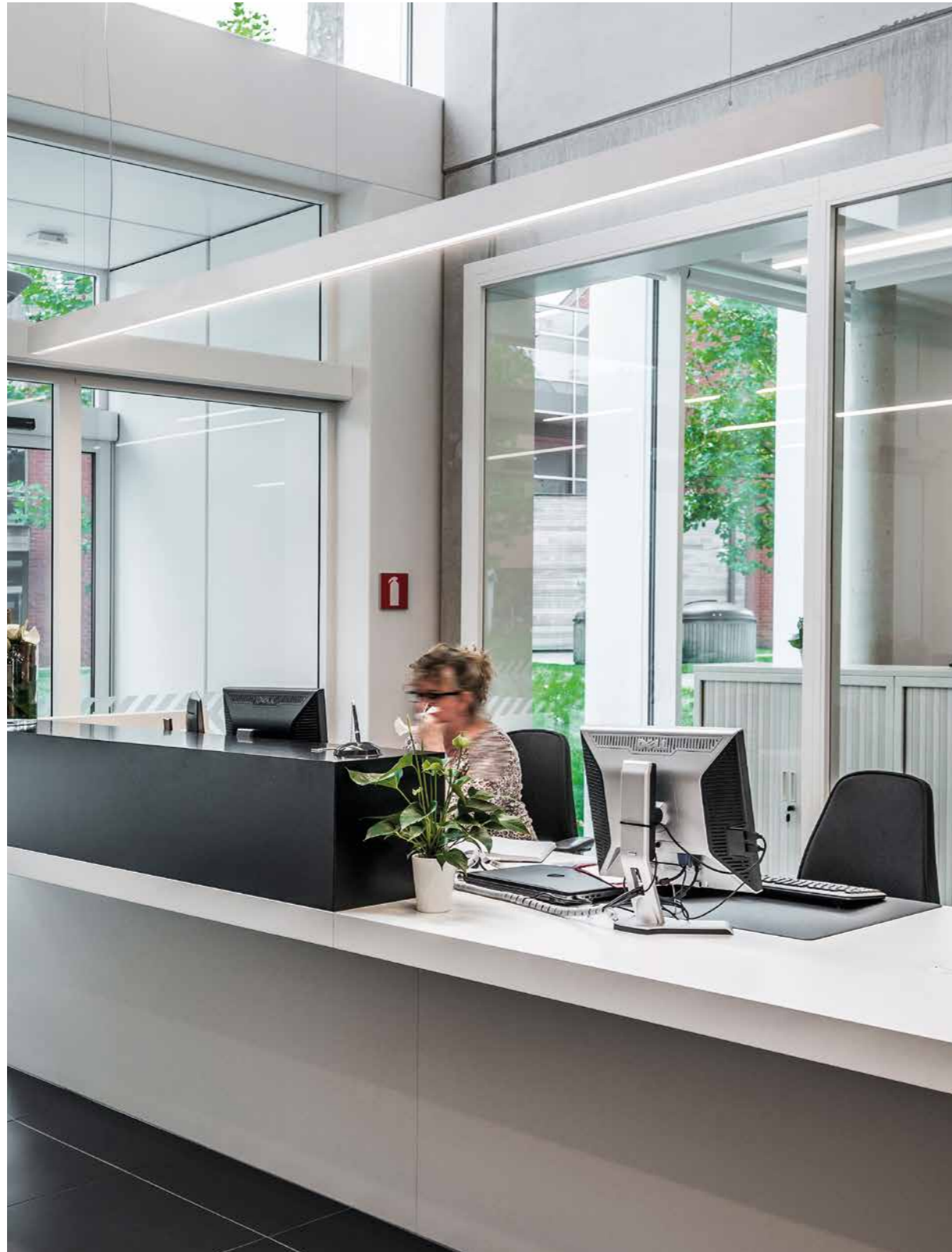

Cepos Duffel

How to compose Ludo

REQUEST CUSTOMER

SMALL UP/DOWN PROFILE
 1 CIRCUIT
 TEXT. WHITE COLOR
 COLOR TEMPERATURE 2700K
 COMBINATION LED SYSTEM AND
 ADJUSTABLE SPOTLIGHT

TAL

Orderform

REF	DESCRIPTION	PCS/M
680047	PROFILE	3
680247	ENDCAP	2
682794	MODULE LEDSYSTEM HE UP 9X650LM 2700K	1
681796	MODULE LEDSYSTEM HO DOWN 9X1100LM 2700K	1
684202	MODULE 1X BULLED	1
810147	ALU COVER	0,48
685047	SUSPENSION SET	3
691047	CONNECTION SET ROUND	1

Section view

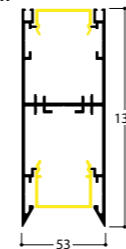

Drawing

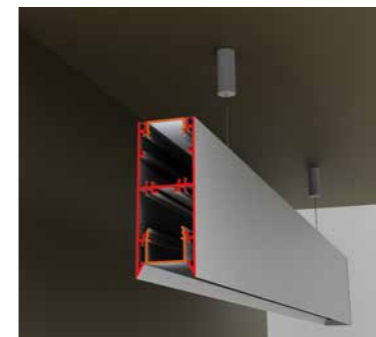
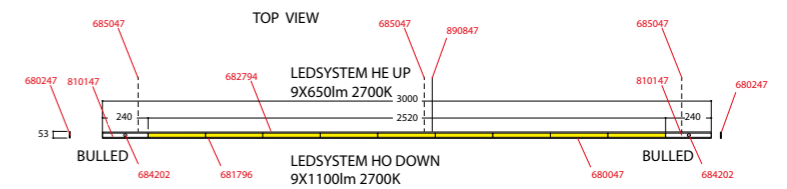

Profile/m

finish	
○	690047
●	690026

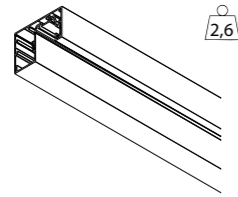

Endcap Left

finish	
○	690957
●	690936

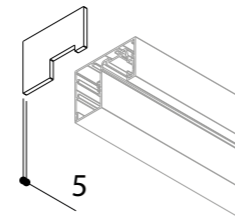

Diffuser/m & Alu Cover/m

finish	
Frosted Polycarbonate	810106
○	810147
●	810126

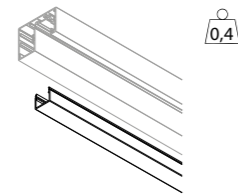

Endcap Right

finish	
○	690947
●	690926

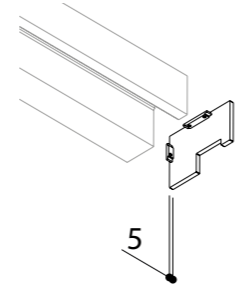

i To be used in empty profile spaces

Extra Circuit/m

Common neutral	892630
No common neutral	892631



i Same length as profile

Straight Connection

Straight Connection	979100
---------------------	--------

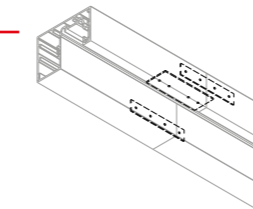

i Section view wall

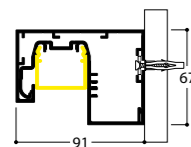

i Section view ceiling

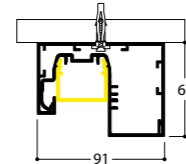

i Section view suspended

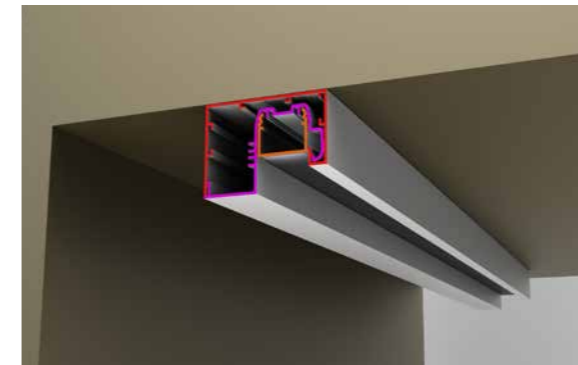
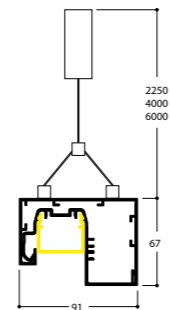

Inner Corner

Corner 90°	979200
Corner 135°	979300
Corner 45°-85° on request	979400

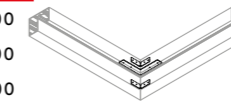

i Not possible to have two adjoining linear led modules in a corner. Always use min. 120mm of alu cover.
Possible scenarios:

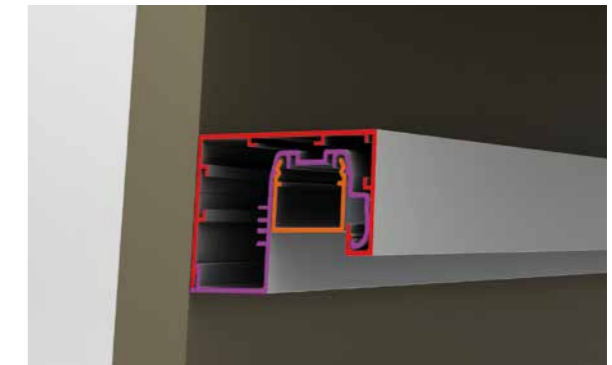
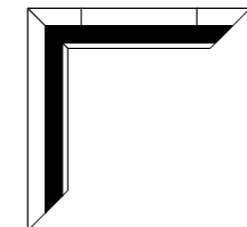
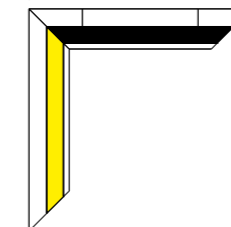
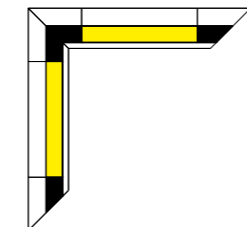
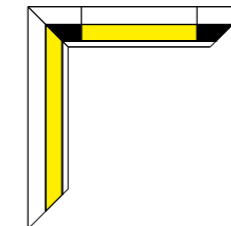
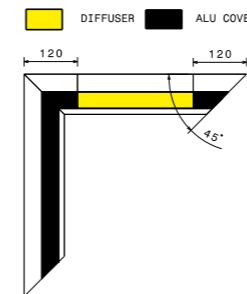

Outer Corner

Corner 270°	979210
Corner 315°	979310
Corner 225°-265° on request	979410

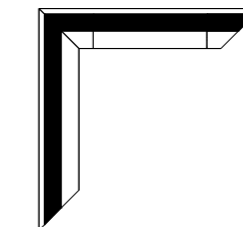
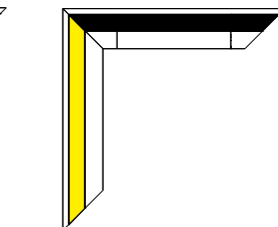
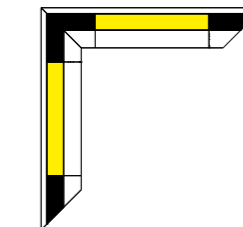
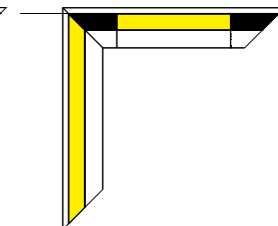
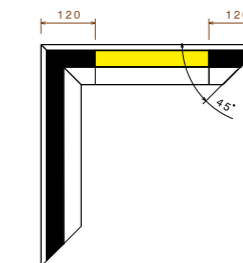
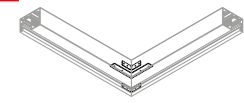



Pharmacy Pittem

Suspension Set

finish	2,25 M	4 M	6 M
○	695047	695147	695247
●	695026	695126	695226

1 suspension/ 1 m profile
min. 2 suspensions

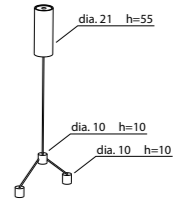

Connection Set Square

finish	3P			5P		
	2,25 m	4 m	6 m	2,25 m	4 m	6 m
○	890847	890947	891047	891147	891247	891347
●	890826	890926	891026	891126	891226	891326

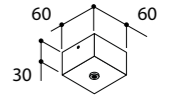

Connection Set Round

finish	3P			5P		
	2,25 m	4 m	6 m	2,25 m	4 m	6 m
○	691047	691147	691247	691347	691447	691547
●	691026	691126	691226	691326	691426	691526

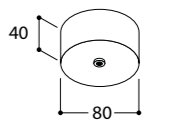

Connection Set Kosmos (recessed)

finish	3P			5P		
	2,25 m	4 m	6 m	2,25 m	4 m	6 m
○	691057	691157	691257	691357	691457	691557
●	691036	691136	691236	691336	691436	691536

56 mm
Installation depth 60 mm

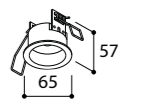

LED SYSTEM HE - 2315 lm/meter

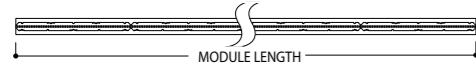

INPUT VOLTAGE 230V AC
 ⓘ Min. required space in profile



		2700K		power /W	length/ mm	length /ft	
led lamps	diffuser	IP	not dimm				dali/touch
Oscar Ledsystem HE 2x650lm	Frosted polycarbonate	IP40	691724	691720	7	560	2
Oscar Ledsystem HE 3x650lm	Frosted polycarbonate	IP40	691734	691730	10,5	840	3
Oscar Ledsystem HE 4x650lm	Frosted polycarbonate	IP40	691744	691740	14	1120	4
Oscar Ledsystem HE 5x650lm	Frosted polycarbonate	IP40	691754	691750	17,5	1400	5
Oscar Ledsystem HE 6x650lm	Frosted polycarbonate	IP40	691764	691760	21	1680	6
Oscar Ledsystem HE 7x650lm	Frosted polycarbonate	IP40	691774	691770	24,5	1960	7
Oscar Ledsystem HE 8x650lm	Frosted polycarbonate	IP40	691784	691780	28	2240	8
Oscar Ledsystem HE 9x650lm	Frosted polycarbonate	IP40	691794	691790	31,5	2520	9
Oscar Ledsystem HE 10x650lm	Frosted polycarbonate	IP40	691704	691700	35	2800	10

		3000K		power /W	length/ mm	length /ft	
led lamps	diffuser	IP	not dimm				dali/touch
Oscar Ledsystem HE 2x650lm	Frosted polycarbonate	IP40	691824	691820	7	560	2
Oscar Ledsystem HE 3x650lm	Frosted polycarbonate	IP40	691834	691830	10,5	840	3
Oscar Ledsystem HE 4x650lm	Frosted polycarbonate	IP40	691844	691840	14	1120	4
Oscar Ledsystem HE 5x650lm	Frosted polycarbonate	IP40	691854	691850	17,5	1400	5
Oscar Ledsystem HE 6x650lm	Frosted polycarbonate	IP40	691864	691860	21	1680	6
Oscar Ledsystem HE 7x650lm	Frosted polycarbonate	IP40	691874	691870	24,5	1960	7
Oscar Ledsystem HE 8x650lm	Frosted polycarbonate	IP40	691884	691880	28	2240	8
Oscar Ledsystem HE 9x650lm	Frosted polycarbonate	IP40	691894	691890	31,5	2520	9
Oscar Ledsystem HE 10x650lm	Frosted polycarbonate	IP40	691804	691800	35	2800	10

		4000K		power /W	length/ mm	length /ft	
led lamps	diffuser	IP	not dimm				dali/touch
Oscar Ledsystem HE 2x650lm	Frosted polycarbonate	IP40	691924	691920	7	560	2
Oscar Ledsystem HE 3x650lm	Frosted polycarbonate	IP40	691934	691930	10,5	840	3
Oscar Ledsystem HE 4x650lm	Frosted polycarbonate	IP40	691944	691940	14	1120	4
Oscar Ledsystem HE 5x650lm	Frosted polycarbonate	IP40	691954	691950	17,5	1400	5
Oscar Ledsystem HE 6x650lm	Frosted polycarbonate	IP40	691964	691960	21	1680	6
Oscar Ledsystem HE 7x650lm	Frosted polycarbonate	IP40	691974	691970	24,5	1960	7
Oscar Ledsystem HE 8x650lm	Frosted polycarbonate	IP40	691984	691980	28	2240	8
Oscar Ledsystem HE 9x650lm	Frosted polycarbonate	IP40	691994	691990	31,5	2520	9
Oscar Ledsystem HE 10x650lm	Frosted polycarbonate	IP40	691904	691900	35	2800	10

LED SYSTEM HO - 3925 lm/meter



INPUT VOLTAGE 230V AC
 ⓘ Min. required space in profile



		2700K		power /W	length/ mm	length /ft	
led lamps	diffuser	IP	not dimm				dali/touch
Oscar Ledsystem HO 2x1100lm	Frosted polycarbonate	IP40	691726	691722	11,6	560	2
Oscar Ledsystem HO 3x1100lm	Frosted polycarbonate	IP40	691736	691732	17,4	840	3
Oscar Ledsystem HO 4x1100lm	Frosted polycarbonate	IP40	691746	691742	23,2	1120	4
Oscar Ledsystem HO 5x1100lm	Frosted polycarbonate	IP40	691756	691752	29	1400	5
Oscar Ledsystem HO 6x1100lm	Frosted polycarbonate	IP40	691766	691762	34,8	1680	6
Oscar Ledsystem HO 7x1100lm	Frosted polycarbonate	IP40	691776	691772	40,6	1960	7
Oscar Ledsystem HO 8x1100lm	Frosted polycarbonate	IP40	691786	691782	46,4	2240	8
Oscar Ledsystem HO 9x1100lm	Frosted polycarbonate	IP40	691796	691792	52,2	2520	9
Oscar Ledsystem HO 10x1100lm	Frosted polycarbonate	IP40	691706	691702	58	2800	10

		3000K		power /W	length/ mm	length /ft	
led lamps	diffuser	IP	not dimm				dali/touch
Oscar Ledsystem HO 2x1100lm	Frosted polycarbonate	IP40	691826	691822	11,6	560	2
Oscar Ledsystem HO 3x1100lm	Frosted polycarbonate	IP40	691836	691832	17,4	840	3
Oscar Ledsystem HO 4x1100lm	Frosted polycarbonate	IP40	691846	691842	23,2	1120	4
Oscar Ledsystem HO 5x1100lm	Frosted polycarbonate	IP40	691856	691852	29	1400	5
Oscar Ledsystem HO 6x1100lm	Frosted polycarbonate	IP40	691866	691862	34,8	1680	6
Oscar Ledsystem HO 7x1100lm	Frosted polycarbonate	IP40	691876	691872	40,6	1960	7
Oscar Ledsystem HO 8x1100lm	Frosted polycarbonate	IP40	691886	691882	46,4	2240	8
Oscar Ledsystem HO 9x1100lm	Frosted polycarbonate	IP40	691896	691892	52,2	2520	9
Oscar Ledsystem HO 10x1100lm	Frosted polycarbonate	IP40	691806	691802	58	2800	10

		4000K		power /W	length/ mm	length /ft	
led lamps	diffuser	IP	not dimm				dali/touch
Oscar Ledsystem HO 2x1100lm	Frosted polycarbonate	IP40	691926	691922	11,6	560	2
Oscar Ledsystem HO 3x1100lm	Frosted polycarbonate	IP40	691936	691932	17,4	840	3
Oscar Ledsystem HO 4x1100lm	Frosted polycarbonate	IP40	691946	691942	23,2	1120	4
Oscar Ledsystem HO 5x1100lm	Frosted polycarbonate	IP40	691956	691952	29	1400	5
Oscar Ledsystem HO 6x1100lm	Frosted polycarbonate	IP40	691966	691962	34,8	1680	6
Oscar Ledsystem HO 7x1100lm	Frosted polycarbonate	IP40	691976	691972	40,6	1960	7
Oscar Ledsystem HO 8x1100lm	Frosted polycarbonate	IP40	691986	691982	46,4	2240	8
Oscar Ledsystem HO 9x1100lm	Frosted polycarbonate	IP40	691996	691992	52,2	2520	9
Oscar Ledsystem HO 10x1100lm	Frosted polycarbonate	IP40	691906	691902	58	2800	10



Pharmacy Pittem



Private house



Pharmacy Pittem

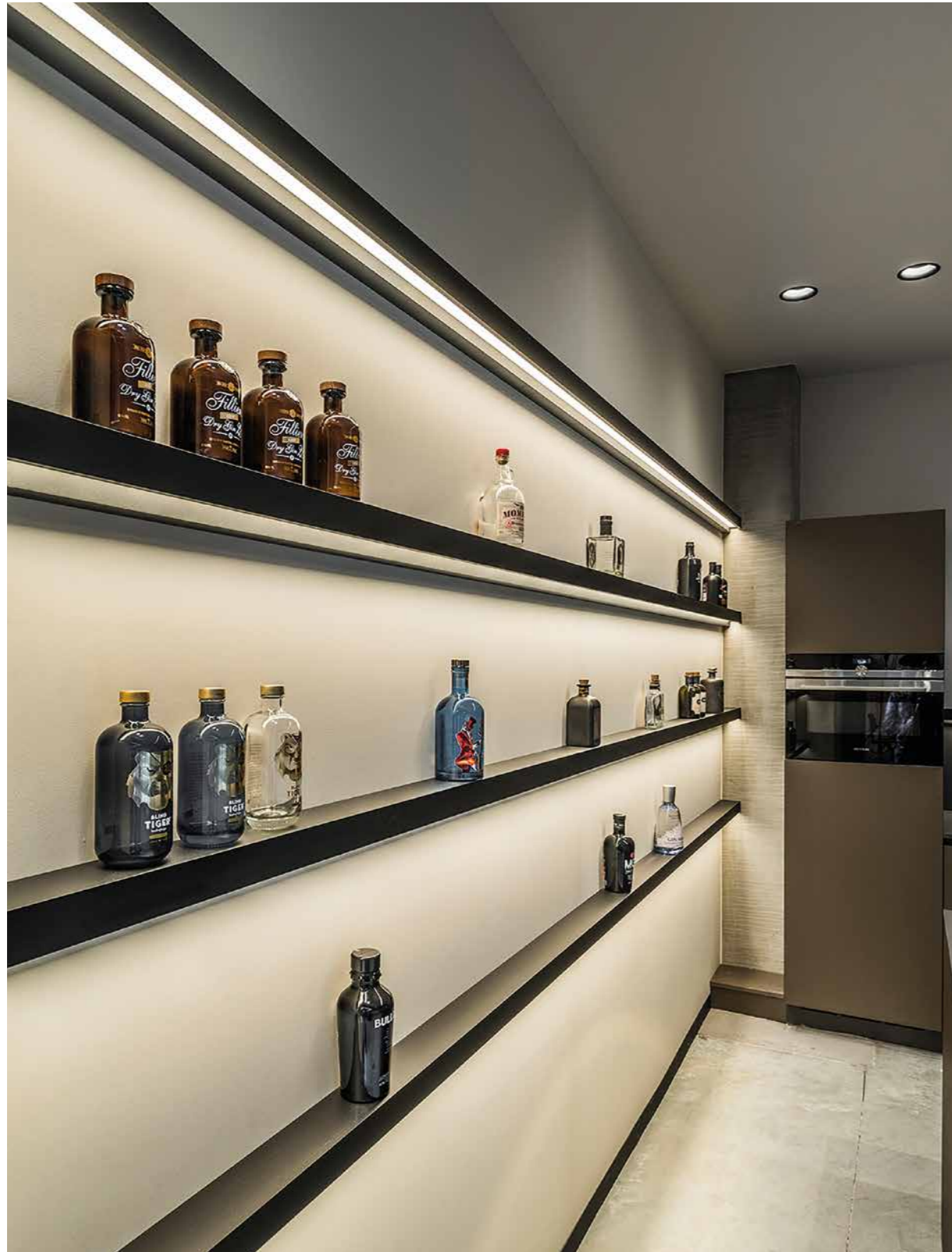

TAL Headquarters

Module Ledline/m

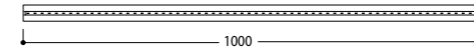

24V DC

i polycarbonate diffuser included

color temperature	2700K			3000K			4000K		
	medium power	high power	very high power	medium power	high power	very high power	medium power	high power	very high power
FROSTED DIFFUSER	692179	692173	692176	692172	692175	692177	692170	692174	692178
power	9,6W/m	14,4W/m	19,2W/m	9,6W/m	14,4W/m	19,2W/m	9,6W/m	14,4W/m	19,2W/m
lumen output	672 lm/m	1010 lm/m	2208lm/m	710 lm/m	1060 lm/m	2208lm/m	740 lm/m	1100 lm/m	2323lm/m
CRI	92	92	92	92	92	92	92	92	92
max. length 1 powerfeed	5 metres	5 metres	5 metres	5 metres	5 metres	5 metres	5 metres	5 metres	5 metres
min. cutting length	50 mm	33,33 mm	33,33 mm	50 mm	33,33 mm	33,33 mm	50 mm	33,33 mm	33,33 mm

Integrated convertor

input 230 V-AC
output 24V-DC
power 20W

i fits in Oscar profile
(no extra space required)

Oscar Convertor module	1-10 V DIMM
	692910

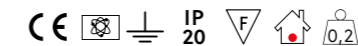

Integrated convertor

input 230 V-AC
output 24V-DC
power 60W

i fits in Oscar profile
(no extra space required)

Oscar Convertor module	NOT DIMM	1-10V	DALI DIMM
	692930	692940	692950

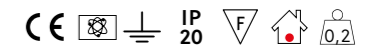

i Converter matrix, see back flap

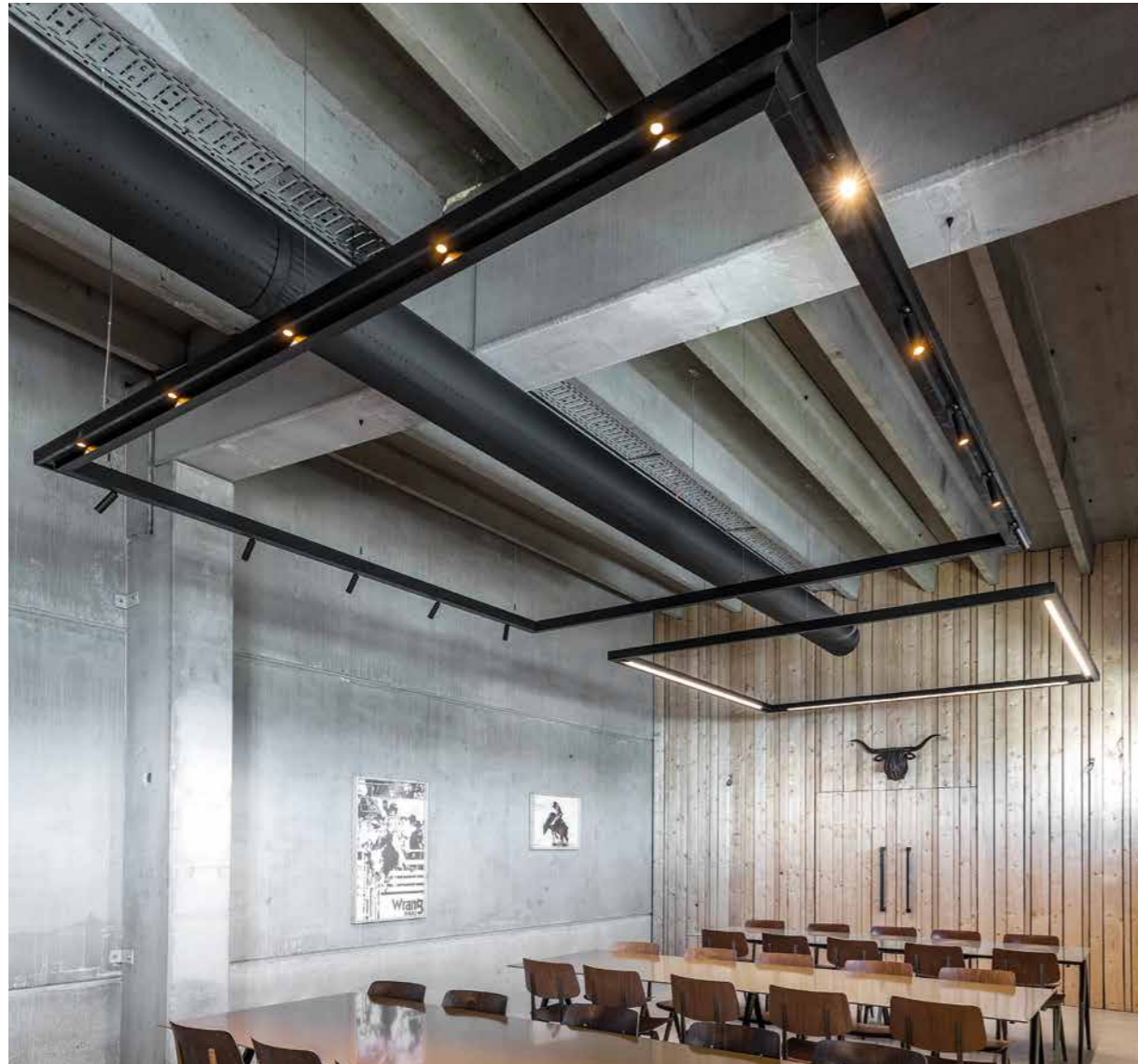

TAL Headquarters

Easy installation & maintenance

i Step 1: Wall

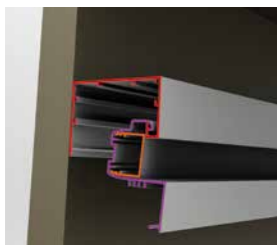

i Step 2: Wall

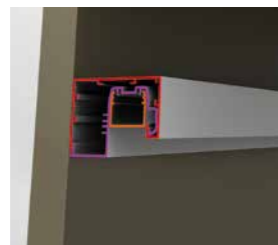

i Step 1: Ceiling

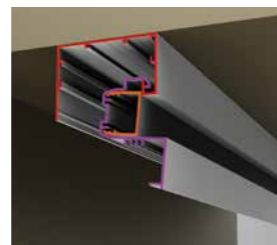

i Step 2: Ceiling

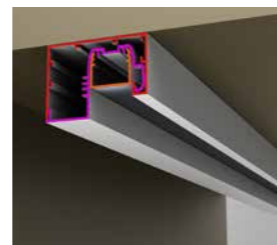

Module 1 x Luxeon M

LUXEON M - 3,82W - 230V 50-60Hz AC
 400 lumen 2700K CRI90
 429 lumen 3000K CRI90
 dimmability: mains dim LC

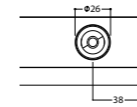

finish	2700K	3000K	1800K-3000K
○	693202	693262	693242
●	693203	693263	693243
●	693205	693265	693245
i	Cover Textured White P/M		810147
i	Cover Textured Black P/M		810126



Module 2 x Luxeon M

LUXEON M - (2x) 3,82W - 230V 50-60Hz AC
 2x 400 lumen 2700K CRI90
 2x 429 lumen 3000K CRI90
 dimmability: mains dim LC

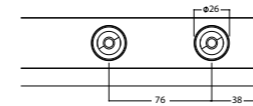

finish	2700K	3000K	1800K-3000K
○	693206	693266	693246
●	693207	693267	693247
●	693209	693269	693249
i	Cover Textured White P/M		810147
i	Cover Textured Black P/M		810126



Module 3 x Luxeon M

LUXEON M - (3x) 3,82W - 230V 50-60Hz AC
 3x 400 lumen 2700K CRI90
 3x 429 lumen 3000K CRI90
 dimmability: mains dim LC

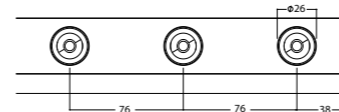

finish	2700K	3000K	1800K-3000K
○	693212	693272	693252
●	693213	693273	693253
●	693215	693275	693255
i	Cover Textured White P/M		810147
i	Cover Textured Black P/M		810126



Module 4 x Luxeon M

LUXEON M - (4x) 3,82W - 230V 50-60Hz AC
 4x 400 lumen 2700K CRI90
 4x 429 lumen 3000K CRI90
 dimmability: mains dim LC

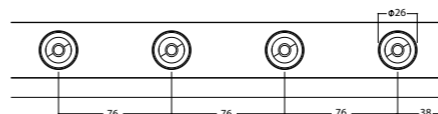

finish	2700K	3000K	1800K-3000K
○	693216	693276	693256
●	693217	693277	693257
●	693219	693279	693259
i	Cover Textured White P/M		810147
i	Cover Textured Black P/M		810126



i All distances between led modules are always minimum dimensions



Loft Waregem

Maximum tilt angles

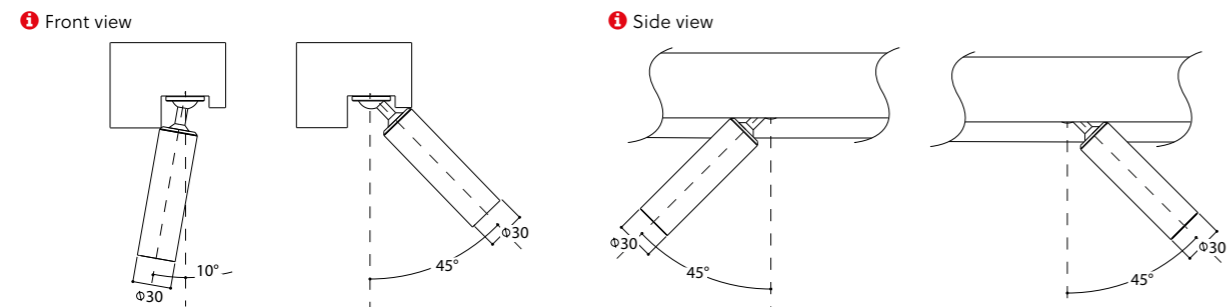

Module 1 x Bulled

LUXEON M - 3,82W - 230V 50-60Hz AC
 400 lumen 2700K CRI90
 429 lumen 3000K CRI90
 dimmability: mains dim LC

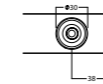

finish	2700K	3000K	1800K-3000K
○	684202	684262	684242
●	684203	684263	684243
●+●	684205	684265	684245
ⓘ	Cover Textured White P/M		810147
ⓘ	Cover Textured Black P/M		810126



Module 2 x Bulled

LUXEON M - (2x) 3,82W - 230V 50-60Hz AC
 2x 400 lumen 2700K CRI90
 2x 429 lumen 3000K CRI90
 dimmability: mains dim LC

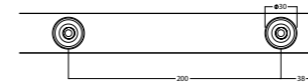

finish	2700K	3000K	1800K-3000K
○	684206	684266	684246
●	684207	684267	684247
●+●	684209	684268	684248
ⓘ	Cover Textured White P/M		810147
ⓘ	Cover Textured Black P/M		810126



Module 3 x Bulled

LUXEON M - (3x) 3,82W - 230V 50-60Hz AC
 3x 400 lumen 2700K CRI90
 3x 429 lumen 3000K CRI90
 dimmability: mains dim LC

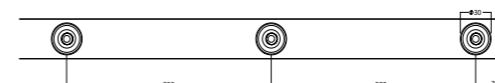

finish	2700K	3000K	1800K-3000K
○	684212	684272	684252
●	684213	684273	684253
●+●	684215	684275	684255
ⓘ	Cover Textured White P/M		810147
ⓘ	Cover Textured Black P/M		810126



Module 4 x Bulled

LUXEON M - (4x) 3,82W - 230V 50-60Hz AC
 4x 400 lumen 2700K CRI90
 4x 429 lumen 3000K CRI90
 dimmability: mains dim LC

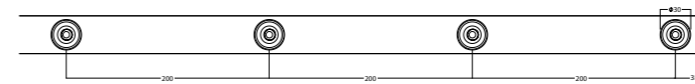

finish	2700K	3000K	1800K-3000K
○	684216	684276	684256
●	684217	684277	684257
●+●	684219	684279	684259
ⓘ	Cover Textured White P/M		810147
ⓘ	Cover Textured Black P/M		810126



ⓘ All distances between led modules are always minimum dimensions



Loft Waregem

How to compose Oscar

REQUEST CUSTOMER

OSCAR PROFILE
 1 CIRCUIT
 TEXT. BLACK COLOR
 SQUARE SHAPE
 COLOR TEMPERATURE 2700K
 COMBINATION OF FIXED AND
 ORIENTABLE SPOTS
 ALL LIGHTS BLACK & GOLD

TAL

Orderform

REF	DESCRIPTION	PCS/M
690026	PROFILE SET (2 PROFILES)	12 (3 + 3 + 3 + 3)
810126	ALU COVER	12 (3 + 3 + 3 + 3)
694209	MODULE 2 X BULLED 2700K	2
694215	MODULE 3 X BULLED 2700K	2
693209	MODULE 2 X LUXEON 2700K	2
693215	MODULE 3 X LUXEON 2700K	2
979210	OUTER CORNER 90°	4

Section view

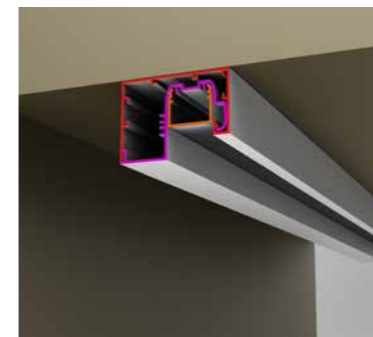
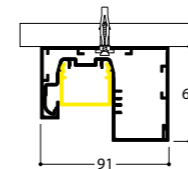

Drawing

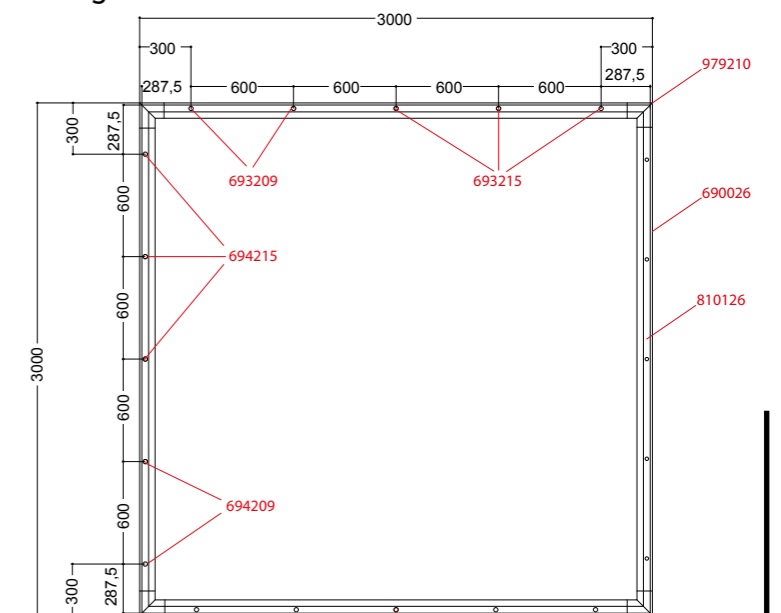

Profile/m

finish	
○	960047
●	960026



Endcap

finish	
○	960148
●	960127

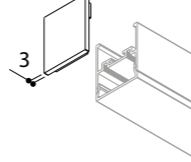

Straight Connection

Straight connection	960060
---------------------	--------

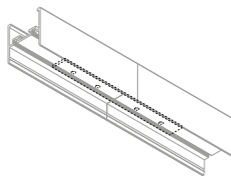

Corner

Corner 90°	960070
Corner 135°	960080
Corner 45° - 85° on request	960090

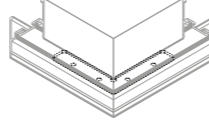

Diffuser/m & Alu Cover/m

finish	
Frosted Polycarbonate	960006
○	960007
●	960008

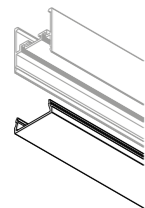

i To be used in empty profile space

i Section view

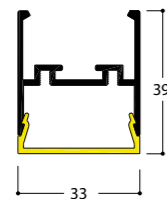

Fixation

Snap	Mounting spring for M10
960050	960055



i Min 2 snaps / springs per m

i Fixation on ceiling or wall

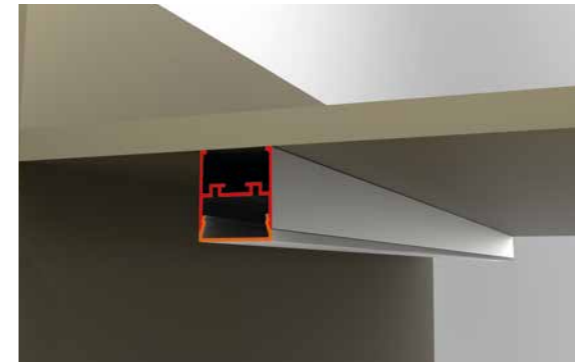
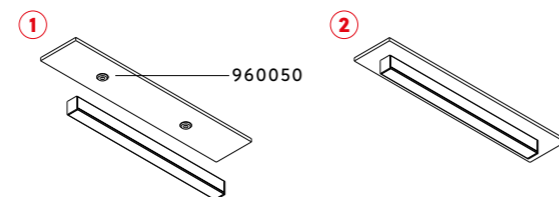

i Protut profile can be used in climate ceilings.



Bouwteam Verstraete Roeselare

Ledsystem HE - 2315 lm/meter

INPUT VOLTAGE 230V AC



led lamps	diffuser	IP	2700K		power /W	length/mm	length/ft
			not dimm	dali/touch			
Protut Ledsystem 3x650lm	Frosted polycarbonate	IP40	960615	960610	10,5	840	3
Protut Ledsystem 4x650lm	Frosted polycarbonate	IP40	960625	960620	14	1120	4
Protut Ledsystem 5x650lm	Frosted polycarbonate	IP40	960635	960630	17,5	1400	5
Protut Ledsystem 6x650lm	Frosted polycarbonate	IP40	960645	960640	21	1680	6
Protut Ledsystem 7x650lm	Frosted polycarbonate	IP40	960655	960650	24,5	1960	7
Protut Ledsystem 8x650lm	Frosted polycarbonate	IP40	960665	960660	28	2240	8
Protut Ledsystem 9x650lm	Frosted polycarbonate	IP40	960675	960670	31,5	2520	9
Protut Ledsystem 10x650lm	Frosted polycarbonate	IP40	960685	960680	35	2800	10

led lamps	diffuser	IP	3000K		power /W	length/mm	length/ft
			not dimm	dali/touch			
Protut Ledsystem 3x650lm	Frosted polycarbonate	IP40	960315	960310	10,5	840	3
Protut Ledsystem 4x650lm	Frosted polycarbonate	IP40	960325	960320	14	1120	4
Protut Ledsystem 5x650lm	Frosted polycarbonate	IP40	960335	960330	17,5	1400	5
Protut Ledsystem 6x650lm	Frosted polycarbonate	IP40	960345	960340	21	1680	6
Protut Ledsystem 7x650lm	Frosted polycarbonate	IP40	960355	960350	24,5	1960	7
Protut Ledsystem 8x650lm	Frosted polycarbonate	IP40	960365	960360	28	2240	8
Protut Ledsystem 9x650lm	Frosted polycarbonate	IP40	960375	960370	31,5	2520	9
Protut Ledsystem 10x650lm	Frosted polycarbonate	IP40	960385	960380	35	2800	10

led lamps	diffuser	IP	4000K		power /W	length/mm	length/ft
			not dimm	dali/touch			
Protut Ledsystem 3x650lm	Frosted polycarbonate	IP40	960415	960410	10,5	840	3
Protut Ledsystem 4x650lm	Frosted polycarbonate	IP40	960425	960420	14	1120	4
Protut Ledsystem 5x650lm	Frosted polycarbonate	IP40	960435	960430	17,5	1400	5
Protut Ledsystem 6x650lm	Frosted polycarbonate	IP40	960445	960440	21	1680	6
Protut Ledsystem 7x650lm	Frosted polycarbonate	IP40	960455	960450	24,5	1960	7
Protut Ledsystem 8x650lm	Frosted polycarbonate	IP40	960465	960460	28	2240	8
Protut Ledsystem 9x650lm	Frosted polycarbonate	IP40	960475	960470	31,5	2520	9
Protut Ledsystem 10x650lm	Frosted polycarbonate	IP40	960485	960480	35	2800	10

Ledsystem HO - 3925 lm/meter

INPUT VOLTAGE 230V AC



led lamps	diffuser	IP	2700K		power /W	length/mm	length/ft
			not dimm	dali/touch			
Protut Ledsystem 3x1100lm	Frosted polycarbonate	IP40	960515	960510	17,4	840	3
Protut Ledsystem 4x1100lm	Frosted polycarbonate	IP40	960525	960520	23,2	1120	4
Protut Ledsystem 5x1100lm	Frosted polycarbonate	IP40	960535	960530	29	1400	5
Protut Ledsystem 6x1100lm	Frosted polycarbonate	IP40	960545	960540	34,8	1680	6
Protut Ledsystem 7x1100lm	Frosted polycarbonate	IP40	960555	960550	40,6	1960	7
Protut Ledsystem 8x1100lm	Frosted polycarbonate	IP40	960565	960560	46,4	2240	8
Protut Ledsystem 9x1100lm	Frosted polycarbonate	IP40	960575	960570	52,2	2520	9
Protut Ledsystem 10x1100lm	Frosted polycarbonate	IP40	960585	960580	58	2800	10

led lamps	diffuser	IP	3000K		power /W	length/mm	length/ft
			not dimm	dali/touch			
Protut Ledsystem 3x1100lm	Frosted polycarbonate	IP40	960115	960110	17,4	840	3
Protut Ledsystem 4x1100lm	Frosted polycarbonate	IP40	960125	960120	23,2	1120	4
Protut Ledsystem 5x1100lm	Frosted polycarbonate	IP40	960135	960130	29	1400	5
Protut Ledsystem 6x1100lm	Frosted polycarbonate	IP40	960145	960140	34,8	1680	6
Protut Ledsystem 7x1100lm	Frosted polycarbonate	IP40	960155	960150	40,6	1960	7
Protut Ledsystem 8x1100lm	Frosted polycarbonate	IP40	960165	960160	46,4	2240	8
Protut Ledsystem 9x1100lm	Frosted polycarbonate	IP40	960175	960170	52,2	2520	9
Protut Ledsystem 10x1100lm	Frosted polycarbonate	IP40	960185	960180	58	2800	10

led lamps	diffuser	IP	4000K		power /W	length/mm	length/ft
			not dimm	dali/touch			
Protut Ledsystem 3x1100lm	Frosted polycarbonate	IP40	960215	960210	17,4	840	3
Protut Ledsystem 4x1100lm	Frosted polycarbonate	IP40	960225	960220	23,2	1120	4
Protut Ledsystem 5x1100lm	Frosted polycarbonate	IP40	960235	960230	29	1400	5
Protut Ledsystem 6x1100lm	Frosted polycarbonate	IP40	960245	960240	34,8	1680	6
Protut Ledsystem 7x1100lm	Frosted polycarbonate	IP40	960255	960250	40,6	1960	7
Protut Ledsystem 8x1100lm	Frosted polycarbonate	IP40	960265	960260	46,4	2240	8
Protut Ledsystem 9x1100lm	Frosted polycarbonate	IP40	960275	960270	52,2	2520	9
Protut Ledsystem 10x1100lm	Frosted polycarbonate	IP40	960285	960280	58	2800	10



Pharmacy Zwevegem



LEDSYSTEM

25° = UGR <12

46° = UGR <19

INPUT VOLTAGE 230V AC

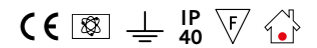

	25°				46°				length	W	lumen
	not dimm		dali		not dimm		dali				
2700k	○	●	○	●	○	●	○	●			
Protut UGR 2x500lm CRI92	960700	960705	960710	960715	960720	960725	960730	960735	560mm	7,5	948
Protut UGR 3x500lm CRI92	960701	960706	960711	960716	960721	960726	960731	960736	840mm	11,25	1422
Protut UGR 4x500lm CRI92	960702	960707	960712	960717	960722	960727	960732	960737	1120mm	15	1896
Protut UGR 5x500lm CRI92	960703	960708	960713	960718	960723	960728	960733	960738	1400mm	18,75	2370
Protut UGR 2x780lm CRI92	960740	960745	960750	960755	960760	960765	960770	960775	560mm	13,3	1484
Protut UGR 3x780lm CRI92	960741	960746	960751	960756	960761	960766	960771	960776	840mm	19,9	2226
Protut UGR 4x780lm CRI92	960742	960747	960752	960757	960762	960767	960772	960777	1120mm	26,5	2968
Protut UGR 5x780lm CRI92	960743	960748	960753	960758	960763	960768	960773	960778	1400mm	33,2	3710
3000K	○	●	○	●	○	●	○	●			
Protut UGR 2x500lm CRI92	960800	960805	960810	960815	960820	960825	960830	960835	560mm	7,5	966
Protut UGR 3x500lm CRI92	960801	960806	960811	960816	960821	960826	960831	960836	840mm	11,25	1449
Protut UGR 4x500lm CRI92	960802	960807	960812	960817	960822	960827	960832	960837	1120mm	15	1932
Protut UGR 5x500lm CRI92	960803	960808	960813	960818	960823	960828	960833	960838	1400mm	18,75	2415
Protut UGR 2x780lm CRI92	960840	960845	960850	960855	960860	960865	960870	960875	560mm	13,3	1510
Protut UGR 3x780lm CRI92	960841	960846	960851	960856	960861	960866	960871	960876	840mm	19,9	2265
Protut UGR 4x780lm CRI92	960842	960847	960852	960857	960862	960867	960872	960877	1120mm	26,5	3020
Protut UGR 5x780lm CRI92	960843	960848	960853	960858	960863	960868	960873	960878	1400mm	33,2	3775
4000K	○	●	○	●	○	●	○	●			
Protut UGR 2x500lm CRI92	960900	960905	960910	960915	960920	960925	960930	960935	560mm	7,5	1042
Protut UGR 3x500lm CRI92	960901	960906	960911	960916	960921	960926	960931	960936	840mm	11,25	1563
Protut UGR 4x500lm CRI92	960902	960907	960912	960917	960922	960927	960932	960937	1120mm	15	2084
Protut UGR 5x500lm CRI92	960903	960908	960913	960918	960923	960928	960933	960938	1400mm	18,75	2605
Protut UGR 2x780lm CRI92	960940	960945	960950	960955	960960	960965	960970	960975	560mm	13,3	1632
Protut UGR 3x780lm CRI92	960941	960946	960951	960956	960961	960966	960971	960976	840mm	19,9	2448
Protut UGR 4x780lm CRI92	960942	960947	960952	960957	960962	960967	960972	960977	1120mm	26,5	3264
Protut UGR 5x780lm CRI92	960943	960948	960953	960958	960963	960968	960973	960978	1400mm	33,2	4080

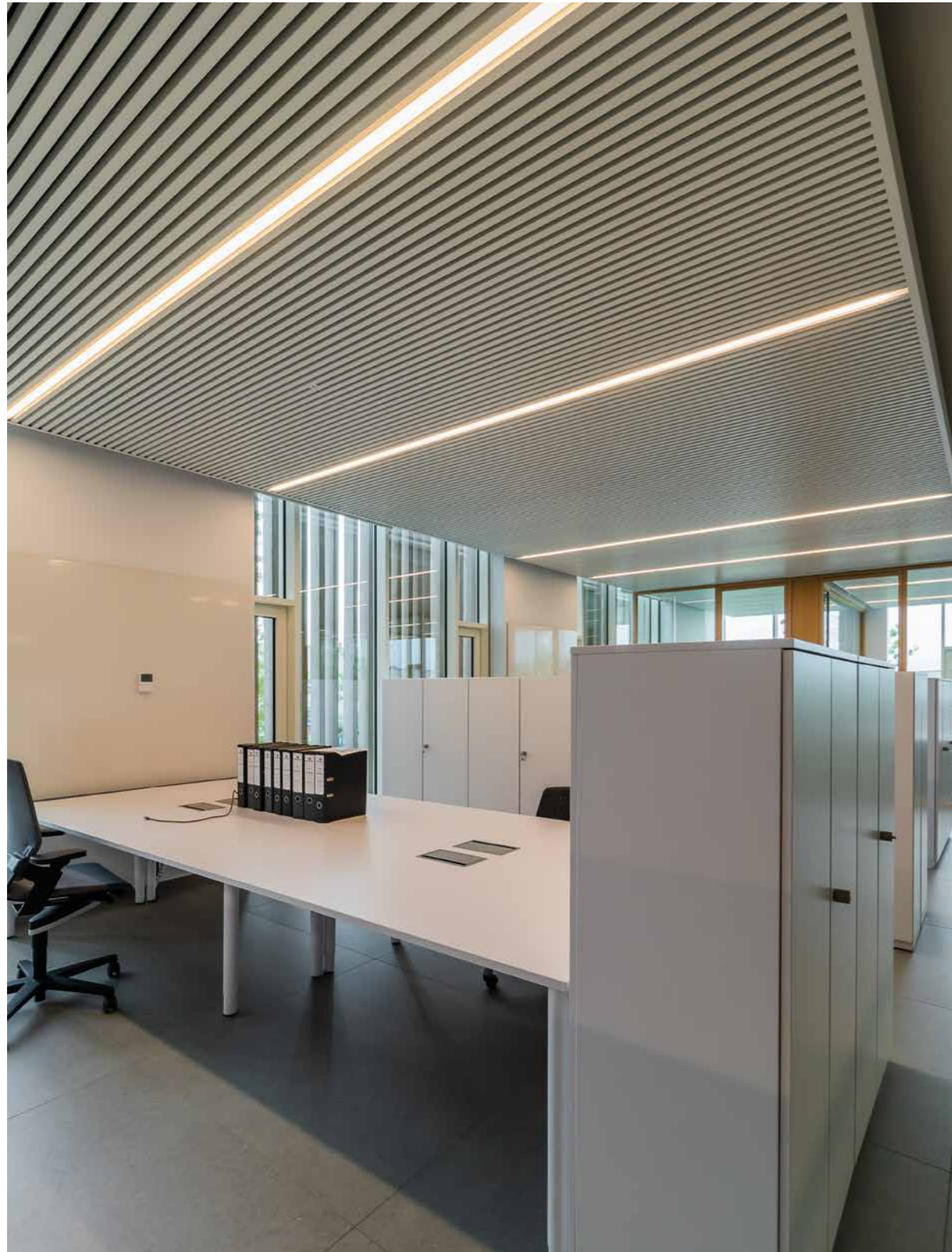

Bouwteam Verstraete Roeselare

Protut Module M10 230V

1X 960780

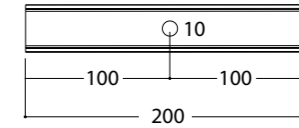

- ❗ Cover profile / m 960007 / 960008 / 960002
- ❗ Mounting spring for M10 960055
- ❗ Fall protection 960065

Protut Module M10 350mA mains dimm

1X 960880

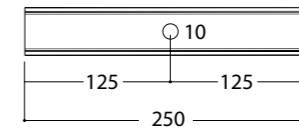

- ❗ cover profile / m 960007 / 960008 / 960002
- ❗ Mounting spring for M10 960055
- ❗ Fall protection 960065

Protut Module M10 350mA dali

1X -
 2X 960981
 3X 960982
 4X 960983

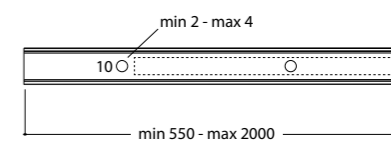

❗ Positioning of M10 modules to be determined by customer.

- ❗ cover profile / m 960007 / 960008 / 960002
- ❗ Mounting spring for M10 960055
- ❗ Fall protection 960065

Profile/m

finish	
○	957047
●	957026

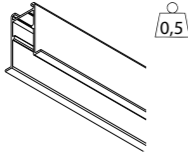

Straight Connection

Straight connection 957060

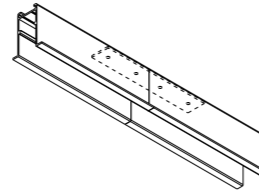

Endcap

finish	REF
○	957247
●	957226

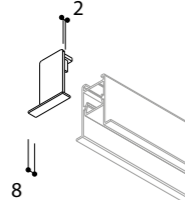

Corner

Corner 90° 957070
 Corner 135° 957080
 Corner on request 957090

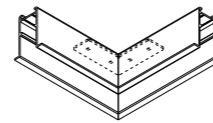

Diffuser

Polycarbonate Diffuser 952006

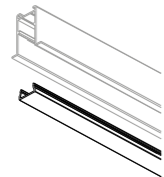

Mounting Spring

Mounting spring 957905

1 spring / 1 m profile
 min. 2 springs

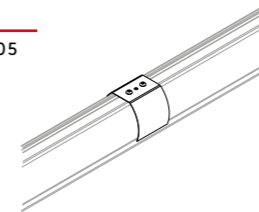

Section view

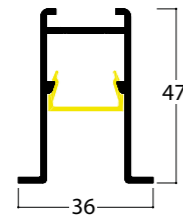

Installation detail

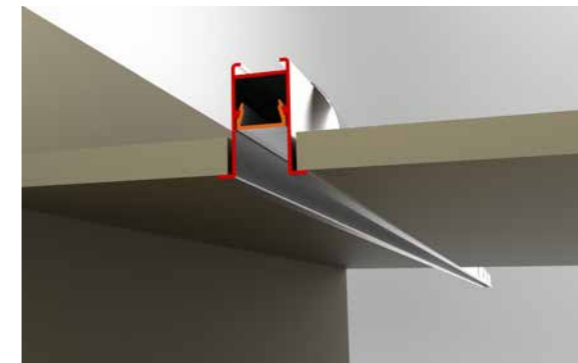
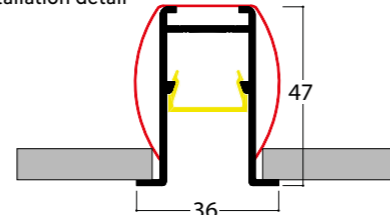

Cut out dimensions

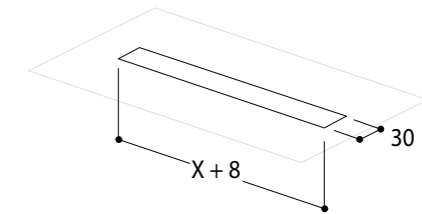

X = Length of profile (measured without endcaps)
 Installation depth: 50 mm

Module Ledline/m

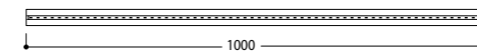

24V DC

Polycarbonate diffuser included

color temperature	2700K			3000K			4000K		
	medium power	high power	very high power	medium power	high power	very high power	medium power	high power	very high power
FROSTED REFERENCE	952211	952251	952311	952221	952261	952321	952231	952271	952331
power	9,6W/m	14,4W/m	19,2W/m	9,6W/m	14,4W/m	19,2W/m	9,6W/m	14,4W/m	19,2W/m
lumen output	672 lm/m	1010 lm/m	2208lm/m	710 lm/m	1060 lm/m	2208lm/m	740 lm/m	1100 lm/m	2323lm/m
CRI	92	92	92	92	92	92	92	92	92
max. length 1 powerfeed	5 metres	5 metres	5 metres	5 metres	5 metres	5 metres	5 metres	5 metres	5 metres
min. cutting length	50 mm	33,33 mm	33,33 mm	50 mm	33,33 mm	33,33 mm	50 mm	33,33 mm	33,33 mm

Converter matrix, see back flap



Winkler Hotel Bolzano

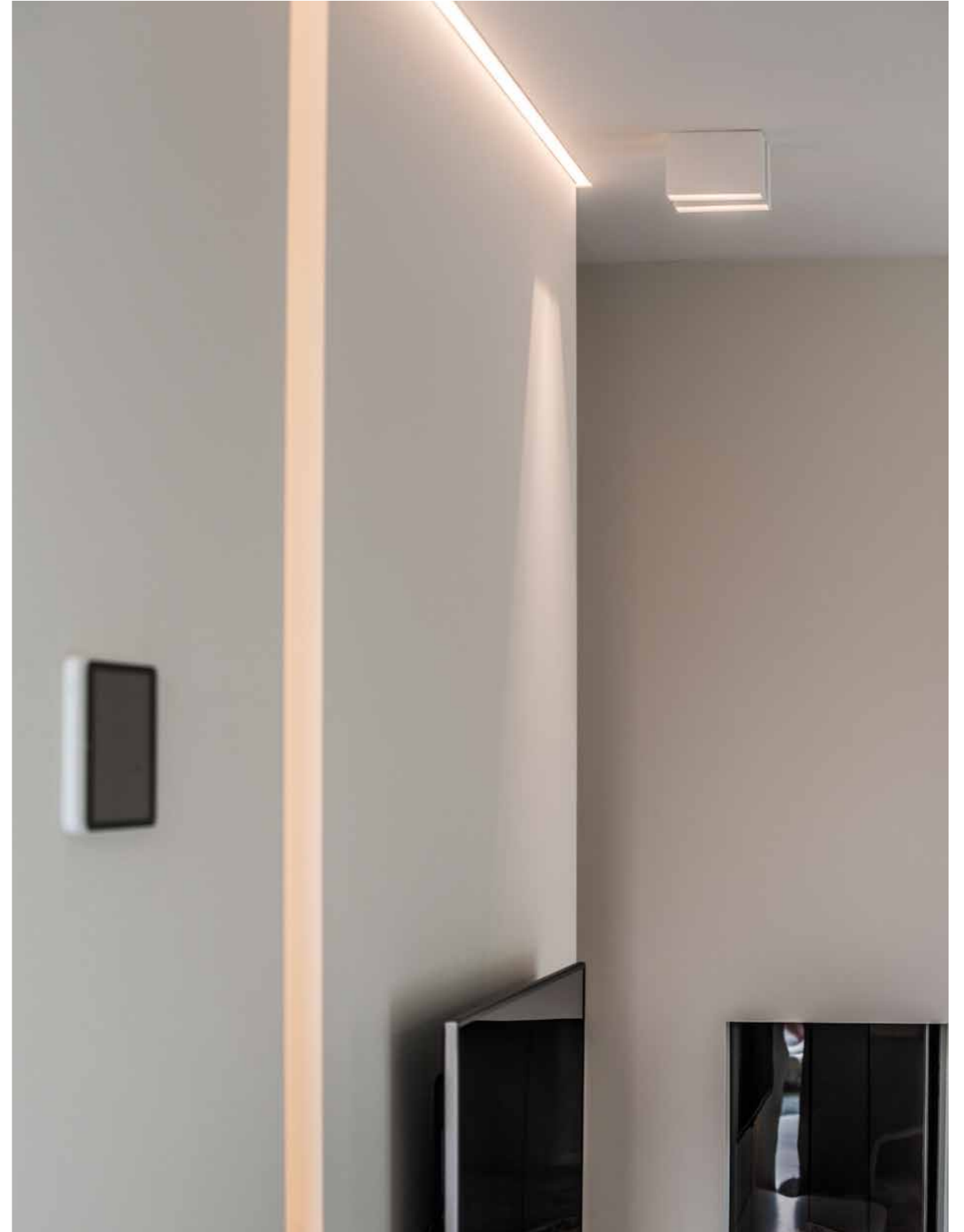

Private House Hasselt

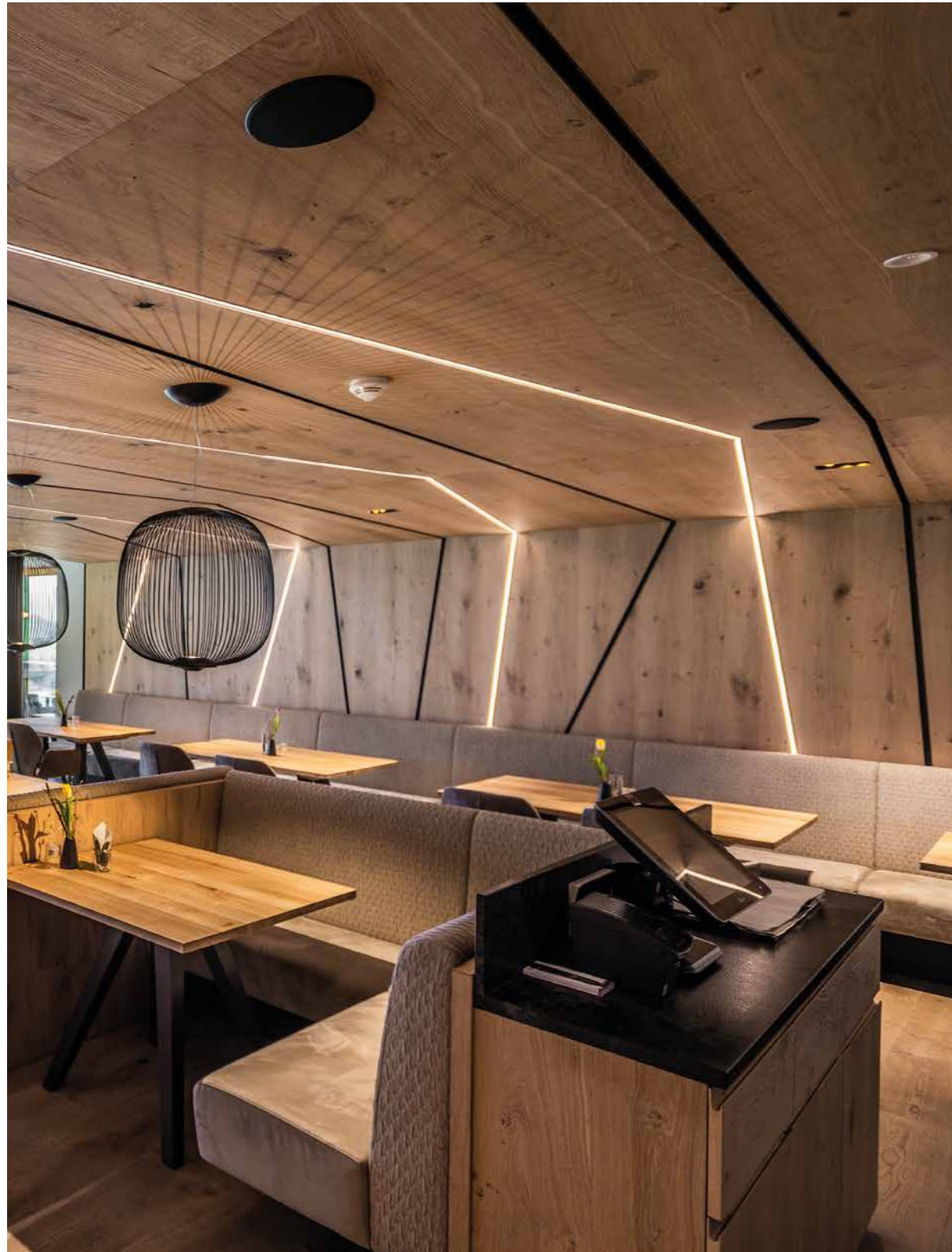

Winkler Hotel Bolzano

How to compose Taglio

REQUEST CUSTOMER

SMALL RECESSED PROFILE 2 M
 FALSE CEILING
 WHITE COLOR
 LED 4000K HP 24V
 CRI >90

+ CONVERTOR

TAL

Orderform

REF	DESCRIPTION	PCS/M
957047	PROFILE TEXT WHITE	2
957247	ENDCAP TEXT WHITE	2
952271	MODULE LEDLINE 4000K HP CRI 92	2
957905	MOUNTING SPRING	3
40070	CONVERTER 35W 24V	1

Drawing

TOP VIEW

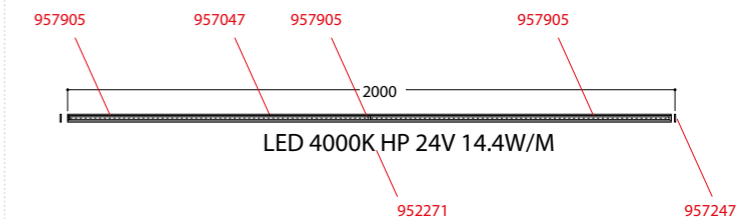

Section view

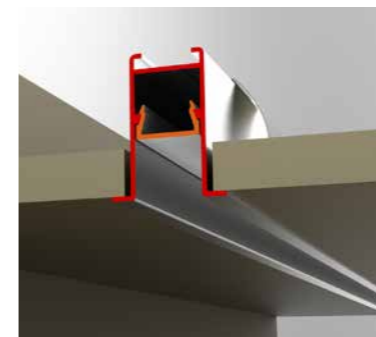
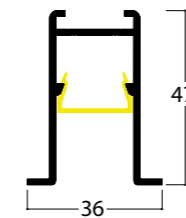

track lighting



NEW 48V

48V Track Components	446
48V Berrier Junior	450
48V Cone Junior	451
48V Funnel Elbow	452
48V Funnel Suspension	453
48V Nobel Elbow	454
48V Nobel Pi	455
48V Kalebas	456
48V Microscoop	457
Magnetic LED 48V Linear	458

230V 3-phase

Track Components	464
Berrier	469
Berrier Suspension	471
NEW Cone Suspension	473
NEW Funnel Elbow	475
Mini Scoop	477
Olijf	479
Paris	481
Sigma Nxt	482
Wodan Beaufort ²	485

Track 48V Surface Mounted or Suspended

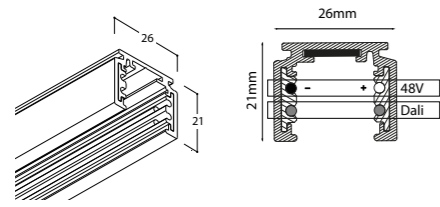

finish	1M	€	2M	€	3M	€
○	TR4147	88,-	TR4247	165,-	TR4347	242,-
●	TR4126	88,-	TR4226	165,-	TR4326	242,-



Live End

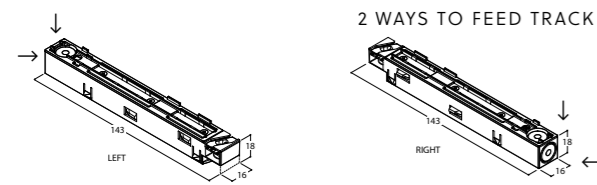

finish	LEFT	€	RIGHT	€
○	TR4757	37,-	TR4747	37,-
●	TR4736	37,-	TR4726	37,-

Endcap

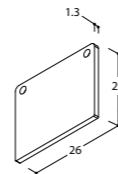

finish		€
○	TR4547	11,-
●	TR4526	11,-

Straight Electrical Coupler

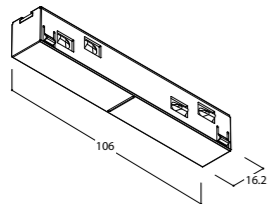

finish		€
○	TR4847	24,-
●	TR4826	24,-

Corner Coupler

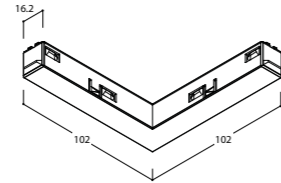

- 90° corners of tracks to be cut on site
- power feed possibility

finish		€
○	TR4647	75,-
●	TR4626	75,-

Pendant Clip + Steel Wire

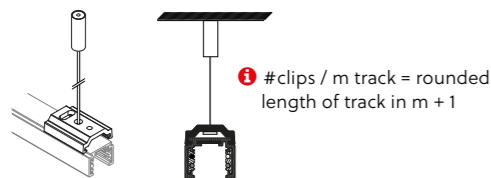

finish	2,25 M	€	4 M	€	6 M	€
○	TR4004	35,-	TR4005	36,-	TR4006	37,-
●	TR4001	35,-	TR4002	36,-	TR4003	37,-

Mechanical Coupler

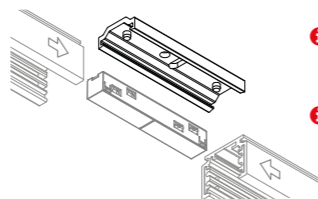

finish		€
○	TR4947	19,-
●	TR4926	19,-

Base + Cable 2P / 4P

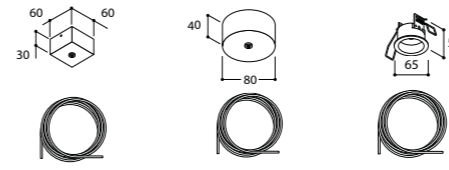

- square
- round
- kosmos
- 56 mm
- Installation depth 60 mm

finish	type	2P			4P								
		2,25 M	€	4 M	€	6M	€						
○	square	691050	45,-	691150	55,-	691250	67,-	691053	79,-	691153	112,-	691253	149,-
○	round	691049	55,-	691149	65,-	691249	77,-	691052	90,-	691152	123,-	691252	160,-
○	kosmos	691048	66,-	691148	76,-	691248	88,-	691051	101,-	691151	134,-	691251	171,-
●	square	691039	45,-	691139	55,-	691239	67,-	691042	79,-	691142	112,-	691242	149,-
●	round	691038	55,-	691138	65,-	691238	77,-	691041	90,-	691141	123,-	691241	160,-
●	kosmos	691037	66,-	691137	76,-	691237	88,-	691040	101,-	691140	134,-	691240	171,-

Flexible Coupler

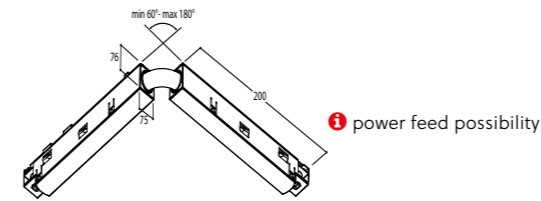

finish		€
○	TR4748	125,-
●	TR4727	125,-

Ceiling Fixation Clip

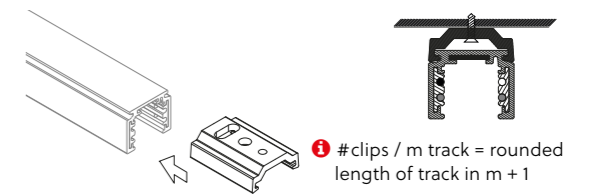

finish		€
○	TR4447	10,-
●	TR4426	10,-

Alternative fixation

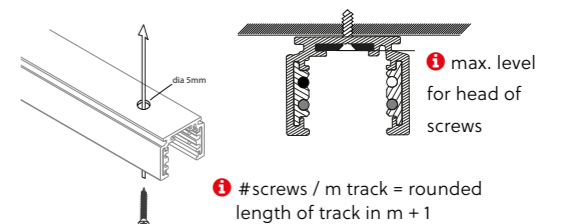

Track 48V Recessed

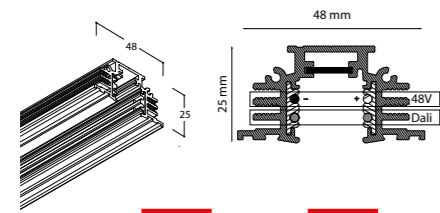

finish	1M	€	2M	€	3M	€
○	TR5147	102,-	TR5247	195,-	TR5347	298,-
●	TR5126	102,-	TR5226	195,-	TR5326	298,-

Live End

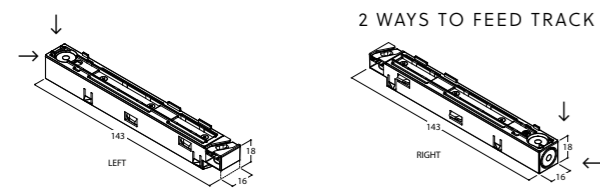

finish	LEFT	€	RIGHT	€
○	TR4757	37,-	TR4747	37,-
●	TR4736	37,-	TR4726	37,-

Straight Electrical Coupler

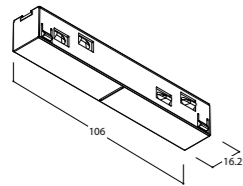

finish		€
○	TR4847	24,-
●	TR4826	24,-

Installation Bracket - set of 2 pcs

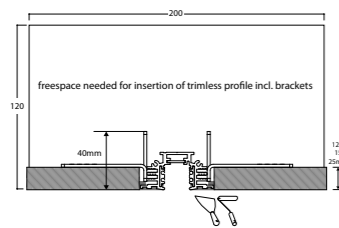

#brackets / m track = rounded length of track in m + 1

finish		€
Galvanised steel	TR5426	27,-

Endcap

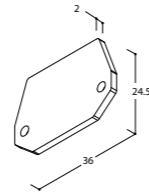

finish		€
○	TR5547	9,-
●	TR5526	9,-

Corner Coupler

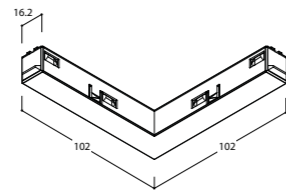

90° corners of tracks to be cut on site
power feed possibility

finish		€
○	TR4647	75,-
●	TR4626	75,-

Mechanical Coupler

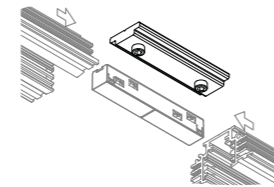

to join tracks in combination with straight electrical coupler

finish		€
○	TR5947	10,-
●	TR5926	10,-

Flexible Coupler

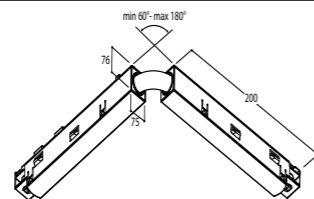

power feed possibility

finish		€
○	TR4748	125,-
●	TR4727	125,-

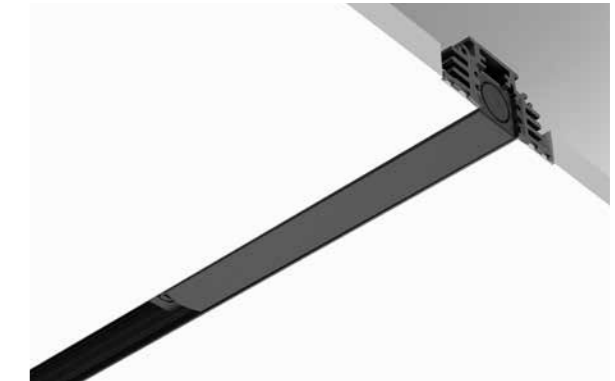
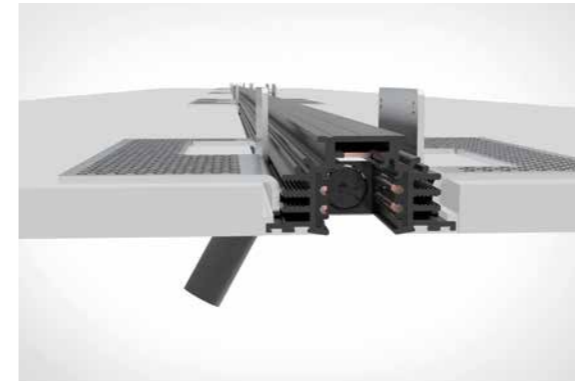

Installation in ceiling thickness of 12.5mm

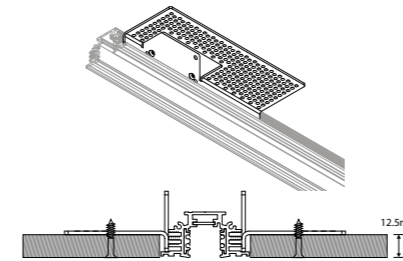

Installation in ceiling thickness of 15mm

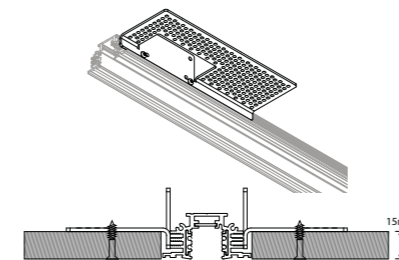

Installation in ceiling thickness of 25mm

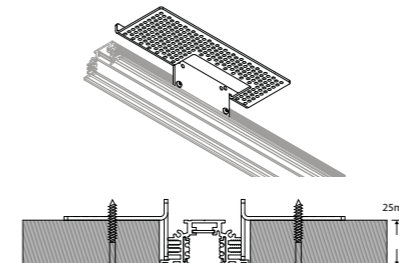



Berrier Junior 48V

LUXEON M - 3,82W
 400 lumen 2700K CRI90
 429 lumen 3000K CRI90
 beam 60°

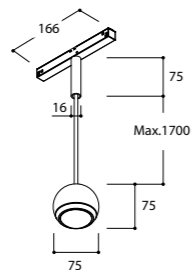

housing	front	main-cord	2700K	3000K	€	2700K	3000K	€
			non dimm		dali			
●	●	●	487302	487312	241,-	487301	487311	263,-
○	○	○	487334	487324	241,-	487333	487323	263,-
●	●	●	487344	487354	241,-	487364	487374	263,-
●	●	●	487345	487355	241,-	487365	487375	263,-
○	●	○	487352	487362	241,-	487372	487384	263,-
●	●	●	487396	487386	245,-	487395	487385	267,-

Family members:



Cone Junior 48V

LUXEON M - 3,82W
 400 lumen 2700K CRI90
 429 lumen 3000K CRI90
 beam 60°

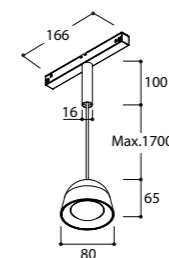

housing	focus	main-cord	2700K	3000K	€	2700K	3000K	€
			non dimm		dali			
●	●	●	450302	450312	273,-	450322	450332	294,-
○	○	○	450334	450324	273,-	450394	450384	294,-
●	●	●	450344	450354	273,-	450364	450374	294,-
●	●	●	450345	450355	273,-	450365	450375	294,-
○	●	○	450352	450362	273,-	450372	450382	294,-
●	●	●	450396	450386	277,-	450356	450366	298,-

Family members:



track lighting

Magnetic LED 48V Spots



Funnel Elbow 48V

LUXEON M - 7,84W

755 lumen 2700K CRI90
810 lumen 3000K CRI90
beam 36°

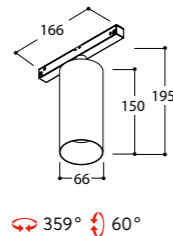

finish	2700K	3000K	€	2700K	3000K	€
	non dimm			dali		
●	484966	484976	211,-	484965	484975	232,-
○	484987	484997	211,-	484986	484996	232,-

Family members:



Funnel Suspension 48V

LUXEON M - 7,84W

755 lumen 2700K CRI90
810 lumen 3000K CRI90
beam 36°

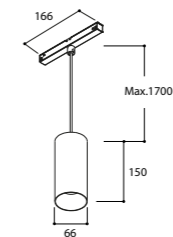

finish	mains-cord	2700K	3000K	€	2700K	3000K	€
		non dimm			dali		
●	●	484971	484972	225,-	484981	484982	248,-
○	○	484973	484974	225,-	484983	484984	248,-

Family members:



Nobel Elbow Single 48V

LUXEON M - 3,82W
 400 lumen 2700K CRI90
 429 lumen 3000K CRI90
 beam 36°

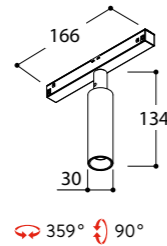

housing	focus	2700K	3000K	€	2700K	3000K	€
		non dimm		dali			
●	●	459626	459636	179,-	459625	459635	200,-
○	○	459647	459657	179,-	459646	459656	200,-
●	●	459696	459686	183,-	459695	459685	204,-

Family members:

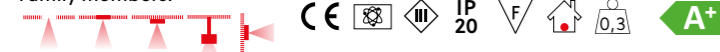

Nobel Elbow Double 48V

LUXEON M (2x) 3,82W
 2x 400 lumen 2700K CRI90
 2x 429 lumen 3000K CRI90
 beam 36°

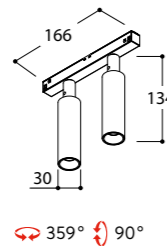

housing	focus	2700K	3000K	€	2700K	3000K	€
		non dimm		dali			
●	●	459624	459634	271,-	459623	459633	291,-
○	○	459645	459655	271,-	459644	459654	291,-
●	●	459694	459684	279,-	459693	459683	299,-

Family members:



Nobel Pi 48V

LUXEON M - 3,82W
 400 lumen 2700K CRI90
 429 lumen 3000K CRI90
 beam 36°

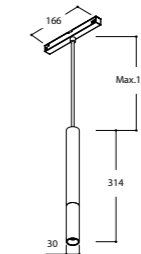

housing	focus	main-cord	2700K	3000K	€	2700K	3000K	€
		non dimm		dali				
●	●	●	418302	418316	210,-	418301	418315	231,-
○	○	○	418334	418308	210,-	418333	418307	231,-
●	●	●	418396	418386	214,-	418395	418385	235,-
○	○	○	418394	418387	210,-	418393	418485	231,-

Family members:

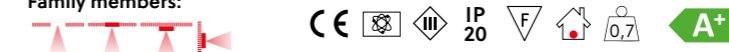



Kalebas LED 48V

LUXEON M - 3,82W
 400 lumen 2700K CRI90
 429 lumen 3000K CRI90
 beam 60°

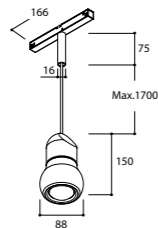

upper part	lower part	mains-cord	2700K	3000K	€	2700K	3000K	€
			non dimm			dali		
oak								
●	●	●	488615	488620	428,-	488614	488619	453,-
●	●	●	488626	488631	397,-	488625	488630	421,-
●	●	●	488636	488641	415,-	488635	488640	440,-
●	○	○	488647	488652	397,-	488646	488651	421,-
●	●	●	488650	488655	428,-	488649	488654	453,-

Family members:

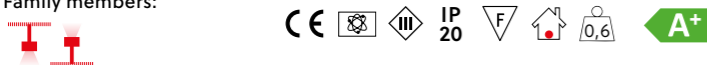

Microscoop Single 48V

LUXEON M - 3,82W
 400 lumen 2700K CRI90
 429 lumen 3000K CRI90
 beam 36°

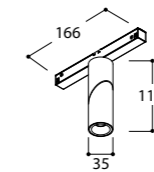

↻ 359° ↻ 359°

housing	focus	2700K	3000K	€	2700K	3000K	€
		non dimm			dali		
●	●	407326	407336	212,-	407325	407335	233,-
○	○	407347	407357	212,-	407346	407356	233,-
●	●	407396	407386	216,-	407395	407385	237,-
○	●	407391	407381	212,-	407390	407380	233,-

Family members:

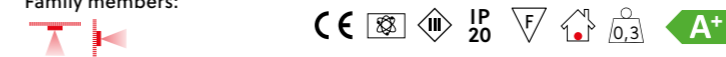

Microscoop Double 48V

LUXEON M (2x) - 3,82W
 2x 400 lumen 2700K CRI90
 2x 429 lumen 3000K CRI90
 beam 36°

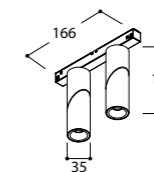

↻ 359° ↻ 359°

housing	focus	2700K	3000K	€	2700K	3000K	€
		non dimm			dali		
●	●	407324	407334	337,-	407323	407333	357,-
○	○	407345	407355	337,-	407344	407354	357,-
●	●	407394	407384	345,-	407393	407383	365,-
○	●	407389	407379	337,-	407388	407378	357,-

Family members:

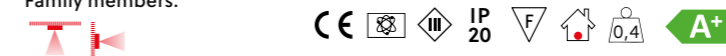

Magnetic LED L286 <19 UGR

SMD LED 5,6W

502 lumen 2700K CRI90
511 lumen 3000K CRI90
547 lumen 4000K CRI90

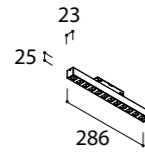

finish	2700K			3000K			4000K			€
	2700K	3000K	4000K	2700K	3000K	4000K	2700K	3000K	4000K	
	non dimm						dali			
●	446711	446709	446710	211,-	446705	446703	446704	262,-		
○	446765	446763	446764	211,-	446759	446757	446758	262,-		



Magnetic LED L567 <19 UGR

SMD LED 10,2W

1003 lumen 2700K CRI90
1021 lumen 3000K CRI90
1093 lumen 4000K CRI90

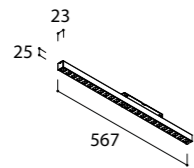

finish	2700K			3000K			4000K			€
	2700K	3000K	4000K	2700K	3000K	4000K	2700K	3000K	4000K	
	non dimm						dali			
●	446723	446721	446722	318,-	446717	446715	446716	368,-		
○	446777	446775	446776	318,-	446771	446769	446770	368,-		



Magnetic LED L847 <19 UGR

SMD LED 15,2W

1505 lumen 2700K CRI90
1532 lumen 3000K CRI90
1640 lumen 4000K CRI90

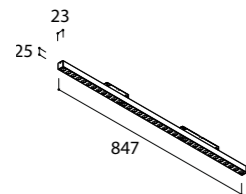

finish	2700K			3000K			4000K			€
	2700K	3000K	4000K	2700K	3000K	4000K	2700K	3000K	4000K	
	non dimm						dali			
●	446735	446733	446734	402,-	446729	446727	446728	452,-		
○	446789	446787	446788	402,-	446783	446781	446782	452,-		



Magnetic LED L1128 <19 UGR

SMD LED 18,2W

1806 lumen 2700K CRI90
1838 lumen 3000K CRI90
1968 lumen 4000K CRI90

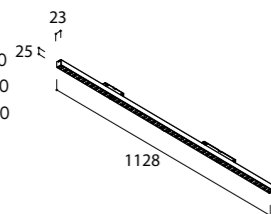

finish	2700K			3000K			4000K			€
	2700K	3000K	4000K	2700K	3000K	4000K	2700K	3000K	4000K	
	non dimm						dali			
●	446747	446745	446746	480,-	446741	446739	446740	529,-		
○	446801	446799	446800	480,-	446795	446793	446794	529,-		



Low UGR

UGR
S = 0.250

Reflectancies	0.7	0.7	0.5	0.5	0.3	0.7	0.7	0.5
Ceiling/Cavity	0.7	0.7	0.5	0.5	0.3	0.7	0.7	0.5
Walls	0.5	0.3	0.5	0.3	0.3	0.5	0.3	0.5
WorkingPlane	0.2	0.2	0.2	0.2	0.2	0.2	0.2	0.2

RoomDimensions	Viewed Crosswise					Viewed Endwise				
x=2H y=2H	17.2	17.8	17.4	18.0	18.2	16.9	17.6	17.2		
x=2H y=3H	17.0	17.6	17.3	17.9	18.1	16.8	17.4	17.1		
x=2H y=4H	17.0	17.5	17.3	17.8	18.1	16.7	17.3	17.0		
x=2H y=6H	16.9	17.4	17.2	17.7	18.0	16.6	17.2	17.0		
x=2H y=8H	16.9	17.4	17.2	17.6	17.9	16.6	17.1	16.9		
x=2H y=12H	16.8	17.3	17.2	17.6	17.9	16.6	17.0	16.9		
x=4H y=2H	17.0	17.5	17.3	17.8	18.1	16.7	17.3	17.0		
x=4H y=3H	16.8	17.3	17.2	17.6	17.9	16.6	17.0	16.9		
x=4H y=4H	16.8	17.2	17.1	17.5	17.8	16.5	16.9	16.9		
x=4H y=6H	16.7	17.0	17.1	17.4	17.8	16.4	16.8	16.8		
x=4H y=8H	16.6	16.9	17.1	17.3	17.7	16.4	16.7	16.8		
x=4H y=12H	16.6	16.9	17.0	17.3	17.7	16.3	16.6	16.8		
x=8H y=4H	16.6	16.9	17.1	17.3	17.7	16.4	16.7	16.8		
x=8H y=6H	16.5	16.8	17.0	17.2	17.6	16.3	16.5	16.7		
x=8H y=8H	16.5	16.7	17.0	17.1	17.6	16.2	16.4	16.7		
x=8H y=12H	16.5	16.6	16.9	17.1	17.6	16.2	16.4	16.7		
x=12H y=4H	16.6	16.9	17.0	17.3	17.7	16.3	16.6	16.8		
x=12H y=6H	16.5	16.7	17.0	17.1	17.6	16.2	16.4	16.7		
x=12H y=8H	16.5	16.6	16.9	17.1	17.6	16.2	16.4	16.7		

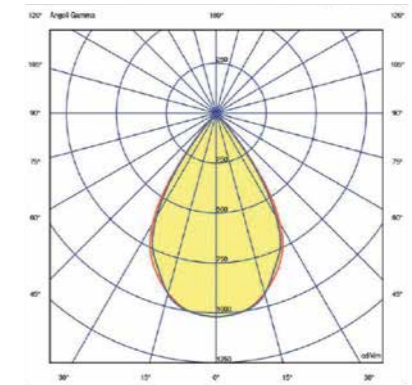

track lighting

Magnetic LED 48V Linear

Magnetic LED L286 Opal

SMD LED 6W
481 lumen 2700K CRI90
490 lumen 3000K CRI90
525 lumen 4000K CRI90

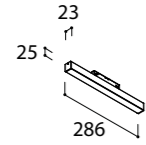

finish	2700K	3000K	4000K	€	2700K	3000K	4000K	€
	non dimm				dali			
●	446708	446706	446707	163,-	446702	446700	446701	208,-
○	446762	446760	446761	163,-	446756	446754	446755	208,-



Magnetic LED L567 Opal

SMD LED 11,9W
987 lumen 2700K CRI90
1005 lumen 3000K CRI90
1078 lumen 4000K CRI90

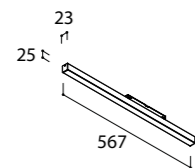

finish	2700K	3000K	4000K	€	2700K	3000K	4000K	€
	non dimm				dali			
●	446720	446718	446719	227,-	446714	446712	446713	273,-
○	446774	446772	446773	227,-	446768	446766	446767	273,-



Magnetic LED L847 Opal

SMD LED 17,8W
1481 lumen 2700K CRI90
1508 lumen 3000K CRI90
1615 lumen 4000K CRI90

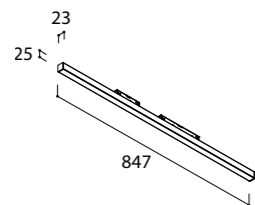

finish	2700K	3000K	4000K	€	2700K	3000K	4000K	€
	non dimm				dali			
●	446732	446730	446731	270,-	446726	446724	446725	315,-
○	446786	446784	446785	270,-	446780	446778	446779	315,-



Magnetic LED L1128 Opal

SMD LED 23,8W
1976 lumen 2700K CRI90
2011 lumen 3000K CRI90
2153 lumen 4000K CRI90

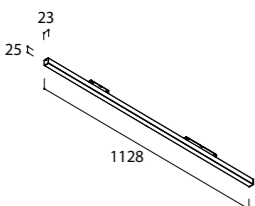

finish	2700K	3000K	4000K	€	2700K	3000K	4000K	€
	non dimm				dali			
●	446744	446742	446743	309,-	446738	446736	446737	354,-
○	446798	446796	446797	309,-	446792	446790	446791	354,-



track lighting

Opal

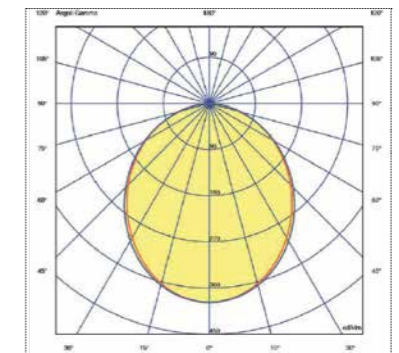

Magnetic LED L1408 Opal

SMD LED 29,8W
2470 lumen 2700K CRI90
2514 lumen 3000K CRI90
2692 lumen 4000K CRI90

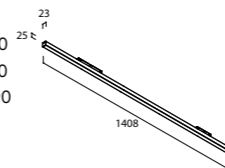

finish	2700K	3000K	4000K	€	2700K	3000K	4000K	€
	non dimm				dali			
●	446753	446751	446752	348,-	446750	446748	446749	393,-
○	446807	446805	446806	348,-	446804	446802	446803	393,-



Magnetic LED 48V Linear

i TAL Track 48V drop voltage table

POWER SUPPLY (W)	A Distance power supply/feed unit (2 X 1,5mm ²)			
	5m	10m	20m	30m
	B Track length with $\Delta V \leq 5,5\%$ (m)			
	(m)	(m)	(m)	(m)
60	50	50	50	50
100	50	50	40	25
150	50	40	20	n/a
200	40	30	n/a	n/a
250	35	20	n/a	n/a

i Information refers to a load equivalent to the power supplied and equally distributed on the relevant length in the table.

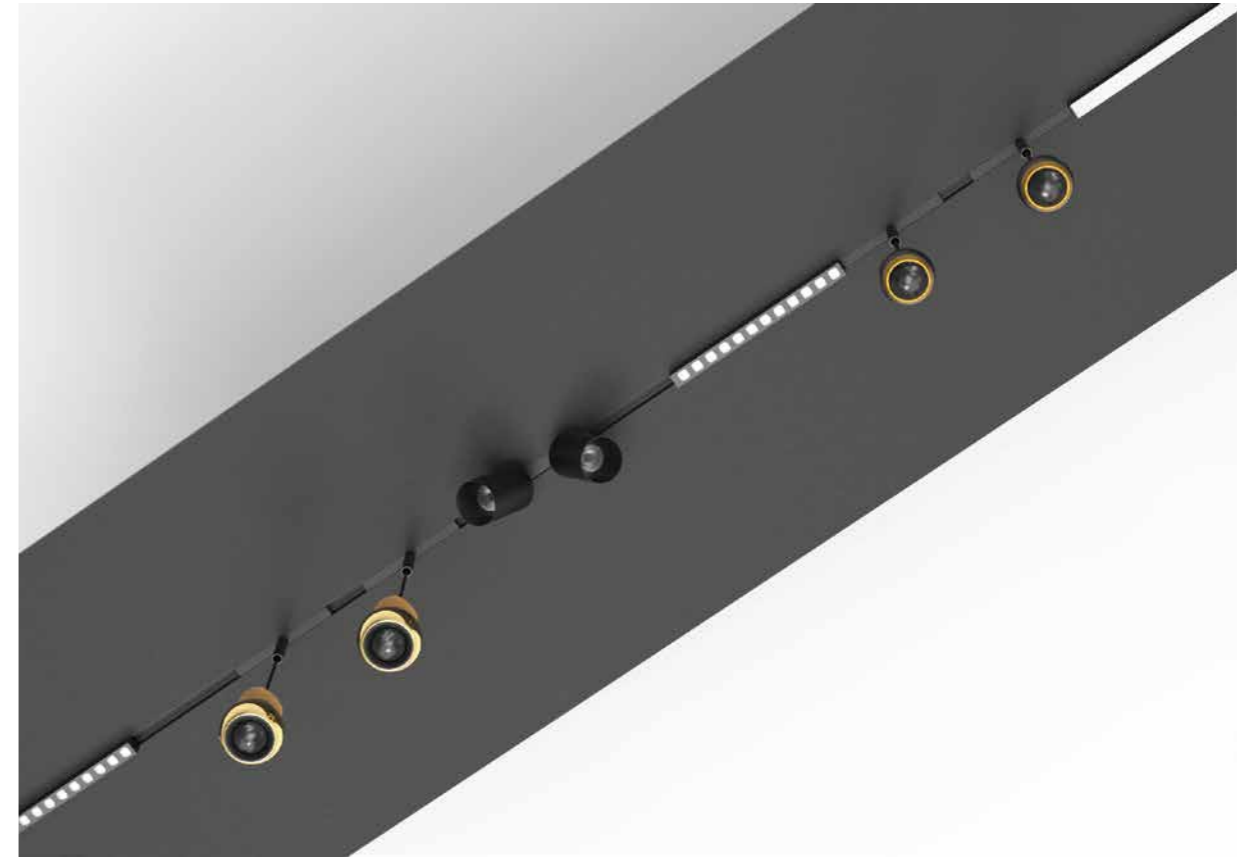
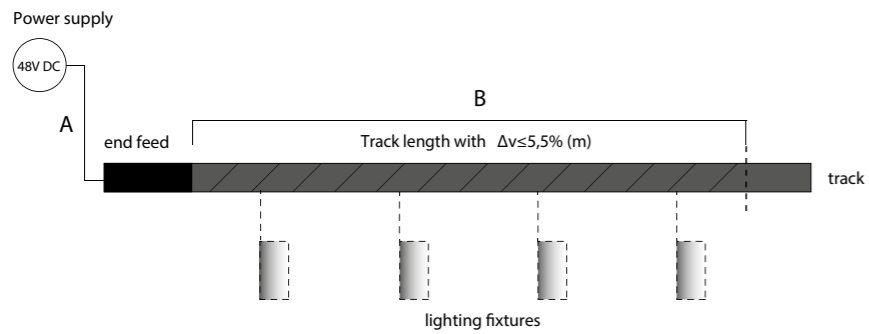

track lighting

i Note A: for track lengths >3m
Use mechanical coupler & electric coupler 180°

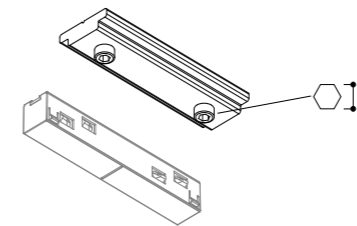

i Note B: for 90° corners use electrical coupler 90° corners of track strobe cut on site (no mechanical coupler involved)

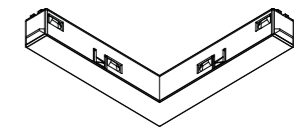

Surface Track 3F

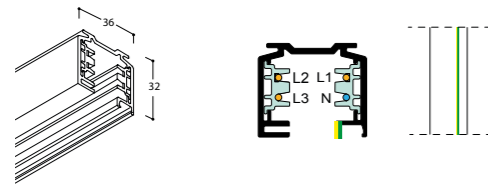

finish	1M	€	2M	€	3M	€
○	TR0147	43,-	TR0247	73,-	TR0347	108,-
●	TR0126	43,-	TR0226	73,-	TR0326	108,-

Live End

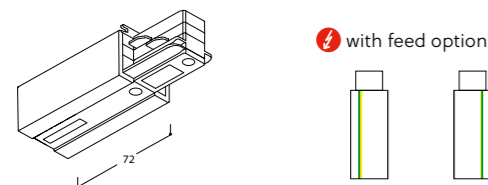

finish	EARTH LEFT	€	EARTH RIGHT	€
○	TR0647	18,-	TR0747	18,-
●	TR0626	18,-	TR0726	18,-

Mechanical Coupler

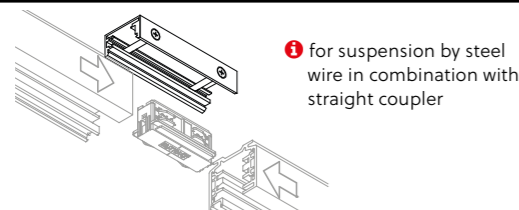

finish		€
○	TR1747	14,-
●	TR1726	14,-

L Coupler - Earth inside

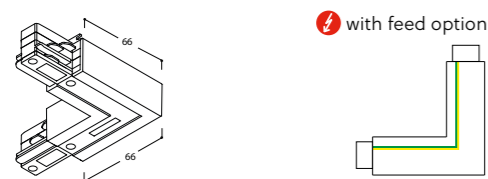

finish		€
○	TR1047	39,-
●	TR1026	39,-

Endcap

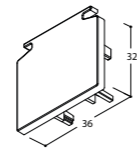

finish		€
○	TR0547	5,-
●	TR0526	5,-

Straight Coupler

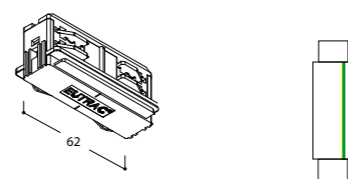

finish		€
○	TR0847	12,-
●	TR0826	12,-

I Coupler

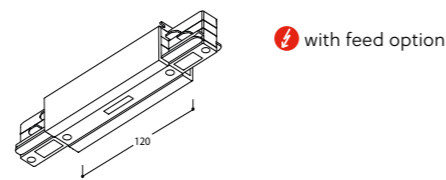

finish		€
○	TR0947	39,-
●	TR0926	39,-

L Coupler - Earth outside

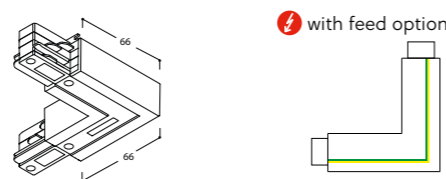

finish		€
○	TR1147	39,-
●	TR1126	39,-

T Coupler - Earth outside

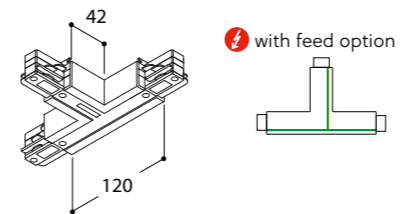

finish	right	€	left	€
○	TR2147	60,-	TR2247	60,-
●	TR2126	60,-	TR2226	60,-

T Coupler - Earth inside

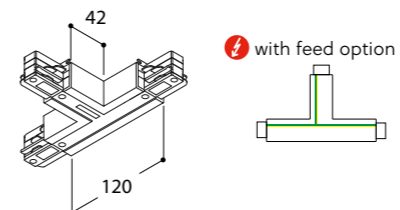

finish	right	€	left	€
○	TR1947	60,-	TR2047	60,-
●	TR1926	60,-	TR2026	60,-

X Coupler

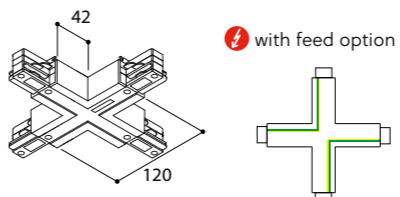

finish		€
○	TR2347	60,-
●	TR2326	60,-

Flex Coupler

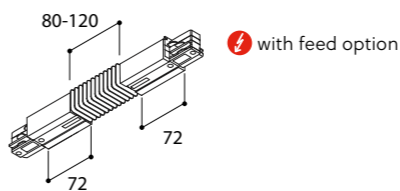

finish		€
○	TR1847	57,-
●	TR1826	57,-

Pendant Clip + Steel Wire

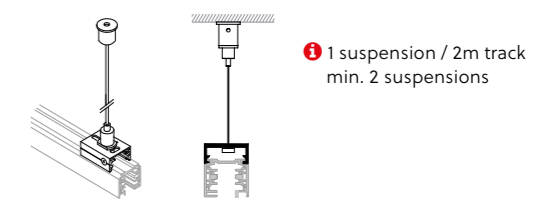

finish	1,5M	€	3M	€	6,2M	€
○	TR1304	32,-	TR1305	33,-	TR1306	39,-
●	TR1301	32,-	TR1302	33,-	TR1303	39,-

Base + Cable 5P

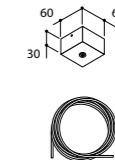

finish	1,5M	€	3M	€	6,2M	€
○	TR1447	47,-	TR1547	54,-	TR1647	84,-
●	TR1426	47,-	TR1526	54,-	TR1626	84,-

Ceiling Fixation Clip

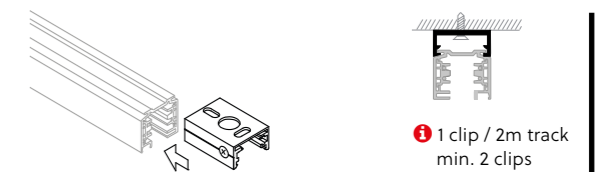

finish		€
○	TR1247	9,-
●	TR1226	9,-

Alternative fixation

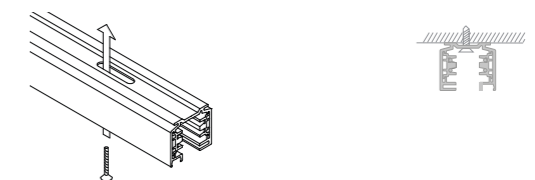

ⓘ Eutrac adapter compatibility: ERCO, Zumtobel, Ivela, Global, Concorde, ASS, ALIVE, Hoffmeister, Power Gear, Stucchi



B&O Kortrijk

How to compose ceiling fixed track in white

Required components

REF	DESCRIPTION	PCS
TR0247	SURFACE TRACK 3F	7
TR0347		1
TR0547	ENDCAP	1
TR0647	LIVE END - EARTH CONTACT LEFT	1
TR1147	L COUPLER - EARTH OUTSIDE	1
TR1047	L COUPLER - EARTH INSIDE	3
TR0847	STRAIGHT COUPLER	3
TR1247	CEILING FIXATION CLIP	12

Drawing

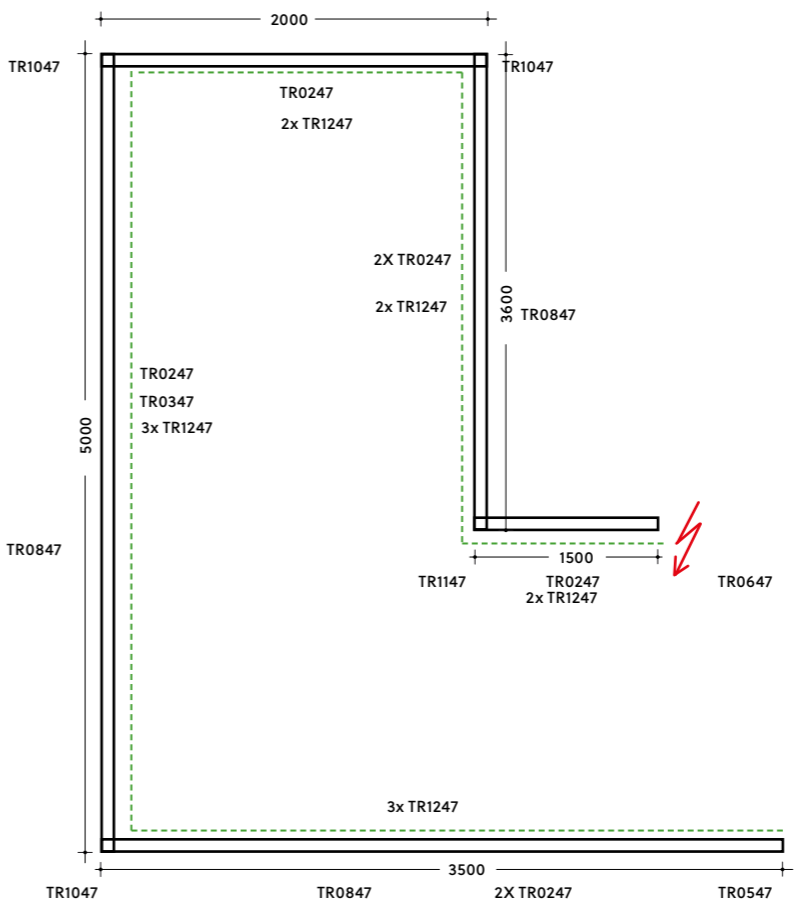

----- EARTH

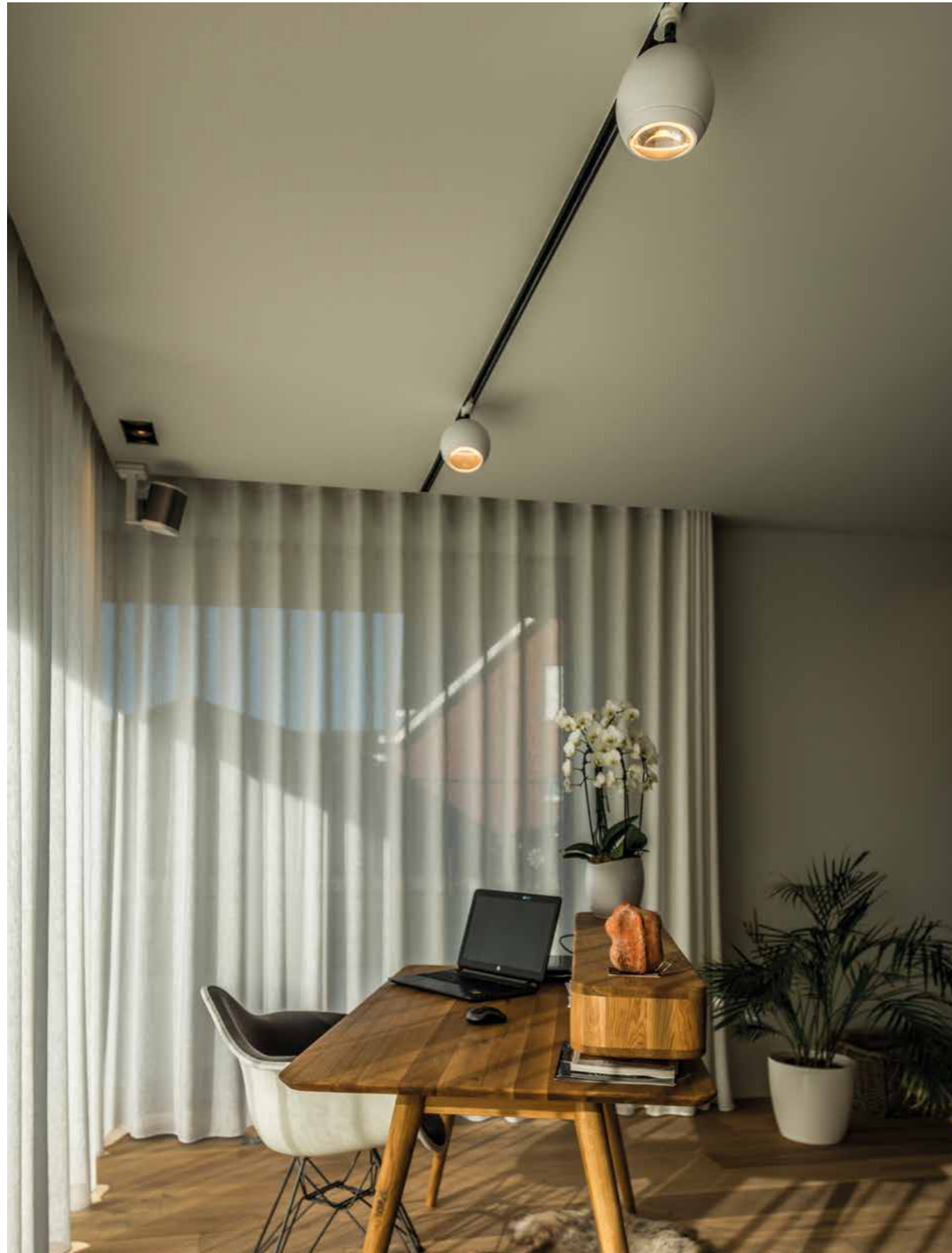

Home office Brugge



Berrier

PREVALED - 12,7W - 230V AC
 1365 lumen 2700K CRI90
 dimmability: mains dim LC
 beam 60°

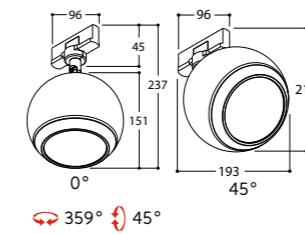

housing	front	2700K	€
○	○	494447	374,-
●	●	494426	374,-
●	●	494419	393,-
●	●	494496	391,-
○	●	494420	393,-
●	●	494450	438,-
●	●	494456	401,-
●	●	494457	416,-
○	●	494494	374,-
●	○	494495	374,-

Family members:

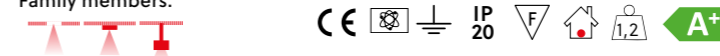



Decat

Berrier Suspension

PREVALED - 12,7W - 230V AC
 1365 lumen 2700K CRI90
 dimmability: mains dim LC
 beam 60°

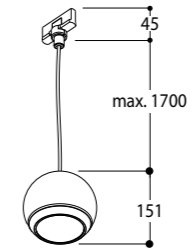

housing	front	mains-cord	2700K	€
○	○	○	494501	320,-
●	●	●	494516	320,-
●	●	●	494519	354,-
●	●	●	494596	350,-
○	●	○	494520	354,-
●	●	●	494550	442,-
●	●	●	494556	362,-
●	●	●	494557	398,-

Family members:

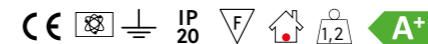

track lighting

Berrier Suspension



Private house Lichtervelde

Cone Suspension

PREVALED - 9W - 230V AC
 1017 lumen 2700K CRI90
 1066 lumen 3000K CRI90
 dimmability: mains dim RC
 beam 60°

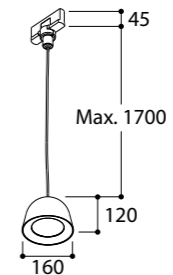

housing	focus	mains-cord	2700K	3000K	€
●	●	●	457402	457412	359,-
●	●	●	457444	457454	359,-
●	●	●	457445	457455	359,-
○	○	○	457434	457424	359,-
○	●	○	457452	457462	359,-
●	●	●	457496	457486	371,-

Family members:

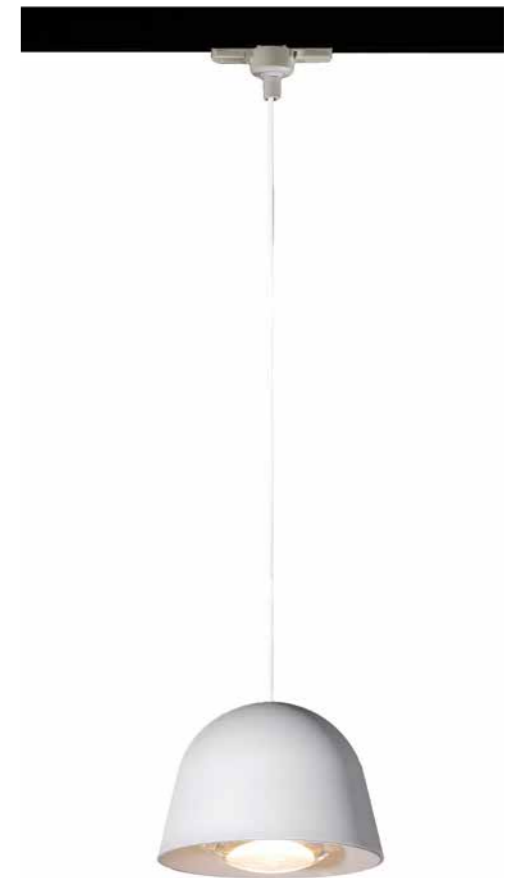

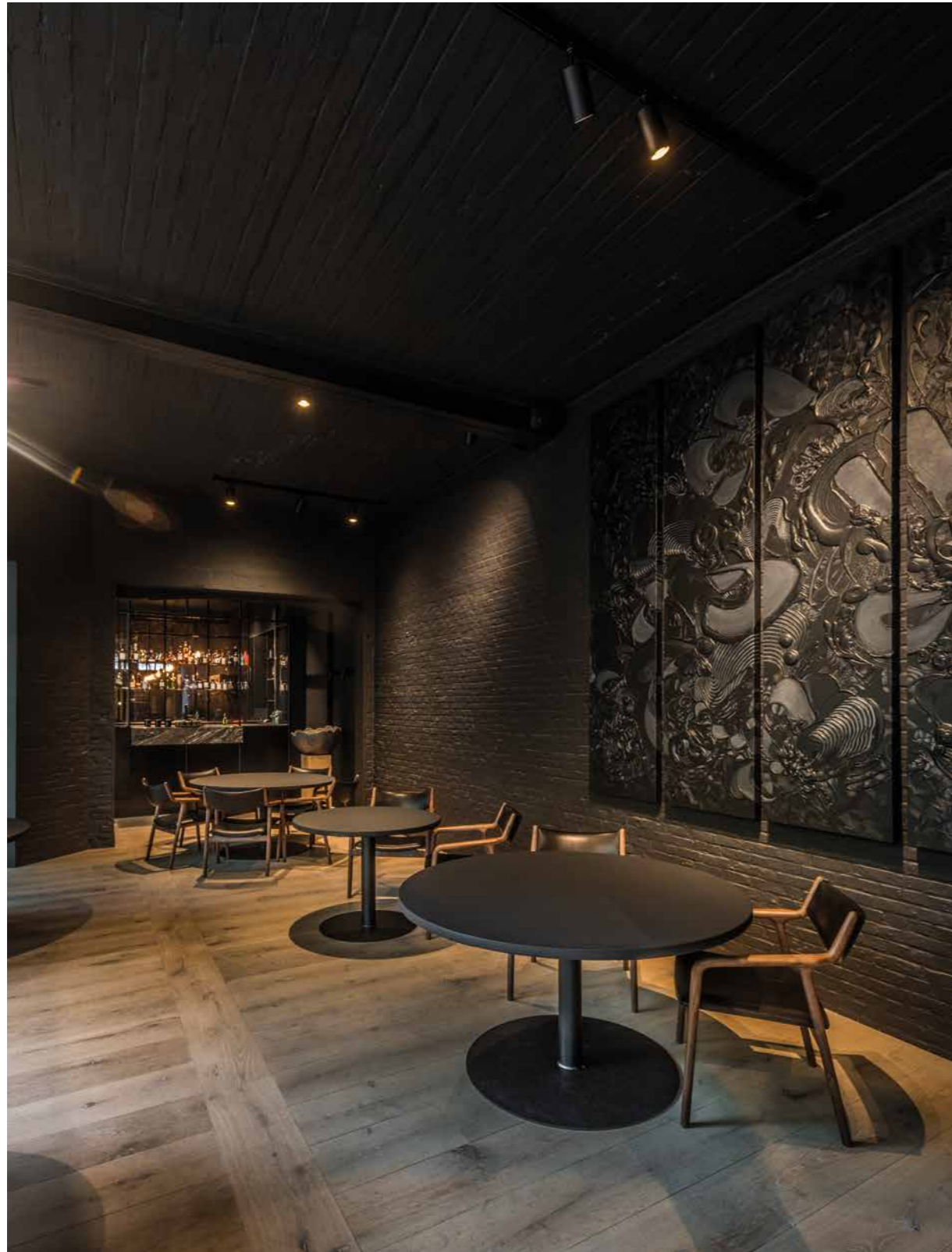

Cuchara Lommel



Funnel Elbow

LUXEON M - 7,84W - 230V AC
 755 lumen 2700K CRI90
 810 lumen 3000K CRI90
 dimmability: mains dim RC
 beam 36°

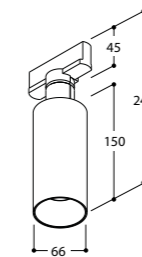

↻ 359° ↻ 90°

housing	focus	2700K	3000K	€
○	○	477647	477657	234,-
●	●	477626	477636	234,-
○	●	477682	477692	238,-
●	●	477686	477696	238,-

Family members:

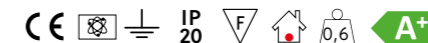

4000K
ON DEMAND



411 Zedelgem

Mini Scoop Deimos

LUXEON M - 7,84W - 230V AC
 755 lumen 2700K CRI90
 810 lumen 3000K CRI90
 dimmability: mains dim LC

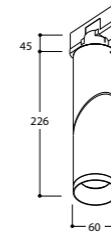

359° 90°

finish	2700K			3000K			€
	9°	38°	60°	9°	38°	60°	
○	279727	279747	279767	279737	279757	279777	286,-
●	279706	279726	279746	279716	279736	279756	286,-

Family members:

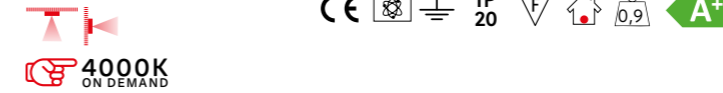

Mini Scoop GU10

LED PAR16 - MAX 10W - 230V - 50/60Hz
 GU10
 dimmability: dependent on bulb



359° 90°

finish	€
○	179547 221,-
●	179526 221,-

Family members:



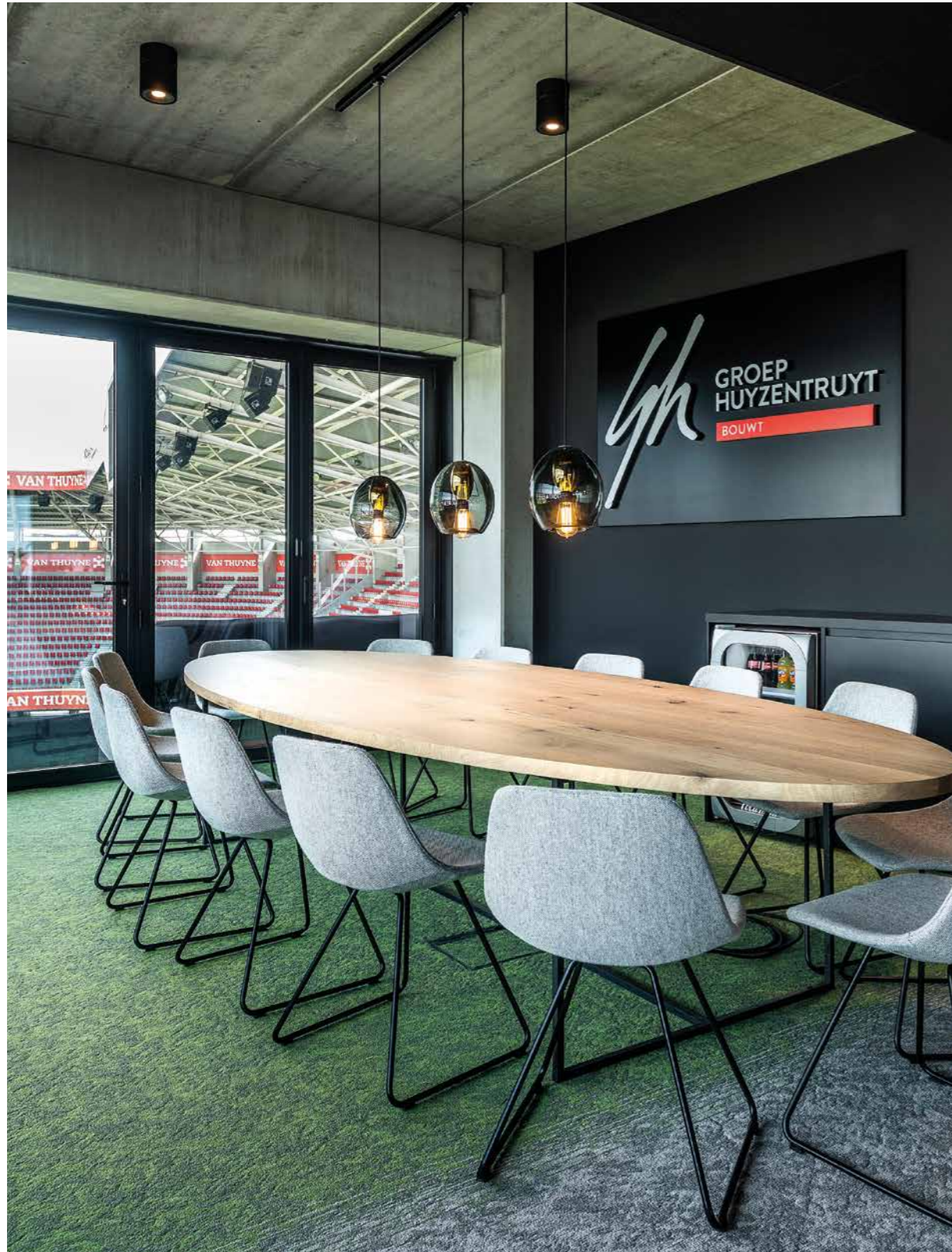

Skybox Regenboogstadium Waregem



Olijf

A60 - MAX. 40W - 230V - 50/60Hz

E27

dimmable: dependent on bulb

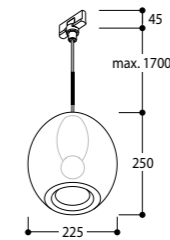

glass	pit	mains-cord		€
○	●	●	480300	389,-
●	●	●	480304	399,-

Family members:





Royce Chocolate Antwerp



Paris

PREVALED - 12,7W - 230V AC
 1365 lumen 2700K CRI90
 dimmability: mains dim LC
 beam 38°

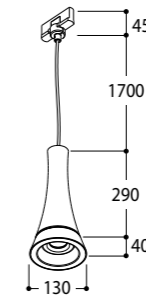

body	cone	focus	mains-cord	2700K	€
			transp.	496521	503,-
				496526	416,-
				496537	416,-
			transp.	496591	455,-
				496596	436,-
				496556	455,-
				496557	503,-

Family members:

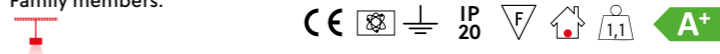



Dresscode Kuurne

Sigma Nxt 17°

PREVALED - 21W - 230V AC
 3000 lumen 3000K CRI80
 3000 lumen 4000K CRI80
 dimmability: not dimmable
 beam 17°

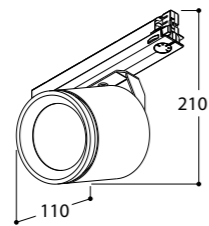

↻ 359° ↕ 60°

finish	3000K	4000K	€
○	482567	482577	298,-
●	482546	482556	298,-

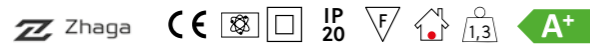

Sigma Nxt 24°

PREVALED - 21W - 230V AC
 3000 lumen 3000K CRI80
 3000 lumen 4000K CRI80
 dimmability: not dimmable
 beam 24°

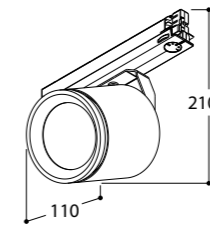

↻ 359° ↕ 60°

finish	3000K	4000K	€
○	482667	482677	298,-
●	482646	482656	298,-



Sigma Nxt 40°

PREVALED - 21W - 230V AC
 3000 lumen 3000K CRI80
 3000 lumen 4000K CRI80
 dimmability: not dimmable
 beam 40°

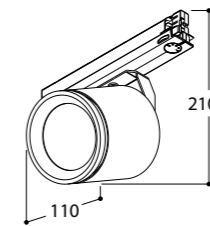

↻ 359° ↕ 60°

finish	3000K	4000K	€
○	482867	482877	298,-
●	482846	482856	298,-



track lighting

Sigma Nxt



Royce Chocolate Antwerp



track lighting

Wodan 1 Beaufort²

CITIZEN - 12,3W - 230V AC
 1508 lumen 2700K CRI90
 1575 lumen 3000K CRI90
 dimmability: mains dim RC
 beam 35°/70°

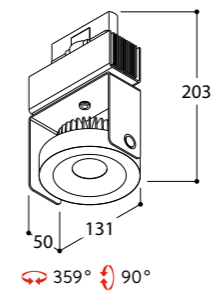

housing	module	2700K		3000K		€
		35°	70°	35°	70°	
○	○	422387	422367	422377	422357	374,-
●	●	422385	422366	422376	422356	374,-
○	●	422382	422364	422374	422354	374,-

Family members:



Wodan Beaufort²

classification of fixtures

IP XX

CODE Degree of protection (solids)

0	No protection
1	Protection against large foreign bodies (diameter <50 mm)
2	Protection against medium foreign bodies (diameter <12,5 mm)
3	Protection against small foreign bodies (diameter <2,5 mm)
4	Protection against small foreign bodies (diameter <1 mm)
5	Dust Protected
6	Dust-tight

CODE Degree of protection (water)

0	No protection
1	Protection against vertical water drops
2	Protection against inclined water drops (15° from vertical)
3	Protection against splash water from all directions (60° from vertical)
4	Protection against splash water from all directions*
5	Protection against water jets from any angle*
6	Protection against temporary flooding*
7	Protection against water submersion to 1 m for 30 min.
8	Protection against high pressure water and submersion for an indefinite time

* Limited ingress permitted

Classification of fixtures

Dust and moisture protection (IP classification)

The IP (International Protection) system drawn up by the IEC classifies fixtures according to the degree of protection afforded against the ingress of foreign bodies, dust and moisture. The term foreign bodies includes such things as tools and fingers coming into contact with live parts.

The designation to indicate the degrees of protection consists of the characteristic letters IP followed by two numerals indicating conformity with the conditions stated in two tables. The first of these so-called 'characteristic numerals' is an indication of the protection against the ingress of foreign bodies and dust, while the second numeral indicates the degree of sealing against the penetration of water.



Overview exterior ≥ IP 54

Helax 70 Out Haloed Leaf

LUXEON M - 7,84W - 700mA DC
755 lumen 2700K CRI90
810 lumen 3000K CRI90
dimmability: PWM or CCR
beam 36°

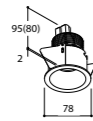

70 mm
Installation depth: 85 mm hollow
ceilings / 100 mm solid ceilings

finish	2700K	3000K
○	249047	249057
●	249046	249056

Converter matrix, see back flap



Helax 70 Out Haloed Torsion

LUXEON M - 7,84W - 700mA DC
755 lumen 2700K CRI90
810 lumen 3000K CRI90
dimmability: PWM or CCR
beam 36°

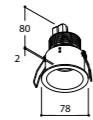

70 mm
Installation depth
85 mm

finish	2700K	3000K
○	249017	249027
●	249016	249026

Converter matrix, see back flap



Helax SML IP54 Leaf

LUXEON M - 7,84W - 350mA DC
400 lumen 2700K CRI90
429 lumen 3000K CRI90
dimmability: PWM or CCR
beam 36°

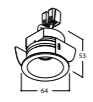

56 mm solid ceilings
55 mm hollow ceilings
Installation depth: 55 mm hollow
ceilings / 70 mm solid ceilings

finish	2700K	3000K
○	178547	178557
●	178526	178536

Converter matrix, see back flap



Helax SML IP54 Torsion

LUXEON M - 7,84W - 350mA DC
400 lumen 2700K CRI90
429 lumen 3000K CRI90
dimmability: PWM or CCR
beam 36°

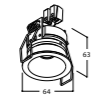

55 mm
Installation depth 65 mm

finish	2700K	3000K
○	178647	178657
●	178626	178636

Converter matrix, see back flap



Helax SML OUT Haloed

LUXEON M - 7,84W - 700mA DC
755 lumen 2700K CRI90
810 lumen 3000K CRI90
dimmability: PWM or CCR
beam 36°

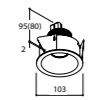

95 mm
Installation depth: 85 mm hollow
ceilings / 100 mm solid ceilings

finish	2700K	3000K
○	249147	249157
●	249146	249156

Converter matrix, see back flap



Overview exterior ≥ IP 65

Brix Single Beam IP 65

LUXEON M - 3,82W - 230V 50-60HZ AC
400 lumen 2700K CRI90
429 lumen 3000K CRI90
dimmability: dimmable L,C
beam 70°
up or down

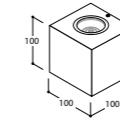

finish	2700K	3000K
●	260941	260931
○	260943	260933
●	260947	260937



Brix Up/down IP 65

LUXEON M - 2x 3,82W - 230V 50-60HZ AC
2x 400 lumen 2700K CRI90
2x 429 lumen 3000K CRI90
dimmability: dimmable L,C
beam 70°
up/down

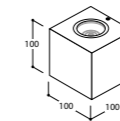

finish	2700K	3000K
●	260942	260932
○	260946	260936
●	260944	260934



Brix Ceiling IP 65

LUXEON M - 3,82W - 230V 50-60HZ AC
400 lumen 2700K CRI90
429 lumen 3000K CRI90
dimmability: dimmable L,C
beam 36°

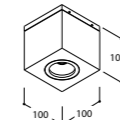

finish	2700K	3000K
●	260972	260982
○	260976	260986
●	260974	260984



Overview exterior ≥ IP 54

Mini Helax Out 400 Lumen

LUXEON M - 7,84W - 350mA DC
400 lumen 2700K CRI90
429 lumen 3000K CRI90
dimmability: PWM or CCR
beam 36°

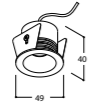

40 mm
Installation depth
60 mm

finish	2700K	3000K
○	178940	178941
●	178946	178947

Converter matrix, see back flap



B4 Out Leaf

CREE XPG - 8W - 700mA DC
832 lumen 2700K CRI92
832 lumen 3000K CRI92
dimmability: PWM or CCR

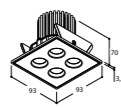

80 mm
Installation depth:
77 mm hollow
ceilings / 92 mm
solid ceilings

finish	2700K			3000K		
	10°	25°	46°	10°	25°	46°
○	294347	294447	294547	294357	294457	294557
●	294326	294426	294526	294336	294436	294536

Converter matrix, see back flap



Overview interior ≥ IP 54

Funnel On Splash IP54

LUXEON M - 3,82W -
230V 50-60HZ AC
400 lumen 2700K CRI90
429 lumen 3000K CRI90
dimmability: dimmable L,C
beam 36°



finish	focus	2700K	3000K
○	○	433947	433948
●	●	433926	433927
○	●	433992	433993
●	●	433996	433997



Micro Tommy

LUXEON M - 3,82W - 350mA DC
400 lumen 2700K CRI90
429 lumen 3000K CRI90
dimmability: PWM or CCR
beam 36°

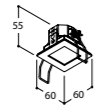

52 x 52 mm
Installation depth 60 mm

finish	focus	2700K	3000K
○	○	472147	472137
●	●	472126	472116
○	●	472194	472184
●	●	472196	472186
○	● inside	472195	472185
○	●	472192	472182

- Micro frame for plaster 419199 140 x 85 x H60 mm
- Micro box for plaster finish 419197 155 x 85 x H90 mm

Converter matrix, see back flap

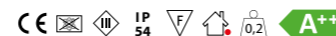

Overview exterior beach ≥ IP 65

Helax SML Torsion Beach

LUXEON M - 3,82W - 350mA DC
400 lumen 2700K CRI90
429 lumen 3000K CRI90
dimmability: PWM/CCR
beam 36°

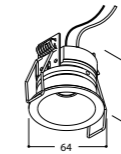

55 mm
Installation depth 65 mm

finish	2700K	3000K
●	178735	178736
○	178756	178757

Suitable for aggressive environments f.ex. coastal areas and swimming pools

Converter matrix, see back flap



Helax SML Leaf Beach

LUXEON M - 3,82W - 350mA DC
400 lumen 2700K CRI90
429 lumen 3000K CRI90
dimmability: PWM/CCR
beam 36°

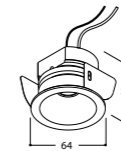

56 mm
Installation depth
55 mm hollow ceilings /
70 mm solid ceilings

finish	2700K	3000K
●	178725	178726
○	178746	178747

Suitable for aggressive environments f.ex. coastal areas and swimming pools

Converter matrix, see back flap



107106	97	150076	315	178336	57	186234	300	249027	295, 488	260943	313, 489	293357	109	348100	73	352426	321	362629	275	369370	285	371944	179
107107	97	150083	315	178347	57	186283	300	249046	295, 488	260944	313, 489	293426	109	348213	75	352433	321	362641	277	369372	285	371945	179
107116	97	150773	315	178357	57	186286	300	249047	295, 488	260946	313, 489	293436	109	348226	75	352436	321	362643	277	369400	281	371946	179
107117	97	150776	315	178426	57	186293	300	249056	295, 488	260947	313, 489	293447	109	348247	75	352503	321	362645	277	369402	281	371951	179
107186	97	150783	315	178436	57	186296	300	249057	295, 488	260972	299, 489	293457	109	348313	75	352513	321	362647	277	369410	281	371952	179
107196	97	168999	300	178447	57	225472	78	249146	297, 488	260974	299, 489	293526	109	348326	75	352523	321	362648	277	369412	281	371953	179
107206	97	175256	177	178457	57	225518	78	249147	297, 488	260976	299, 489	293536	109	348347	75	352526	321	362649	277	369420	285	371954	179
107207	97	175266	177	178526	293, 488	225526	78	249156	297, 488	260982	299, 489	293547	109	348727	73	352533	321	362660	277	369422	285	371955	179
107216	97	175277	177	178536	293, 488	226472	104	249157	297, 488	260984	299, 489	293557	109	348728	73	352536	321	362662	277	369430	285	371956	179
107217	97	175278	177	178547	293, 488	226518	104	250790	106	260986	299, 489	294326	298, 490	348748	73	352603	321	362665	277	369432	285	375527	200, 260
107286	97	175297	177	178557	293, 488	226526	104	253011	140	260990	311, 321, 331, 333	294336	298, 490	348749	73	352613	321	362667	277	369440	281	375548	200, 260
107296	97	175298	177	178626	293, 488	227472	78	253026	140	260991	315, 319	294347	298, 490	348827	73	352623	321	362668	277	369442	281	375627	200, 261
107406	99	175356	177	178636	293, 488	227518	78	253044	140	260992	327, 329, 317	294357	298, 490	348828	73	352626	321	362669	277	369450	281	375648	200, 261
107407	99	175366	177	178647	293, 488	227526	78	253045	140	277016	171	294426	298, 490	348848	73	352633	321	362670	275	369452	281	375727	200, 261
107416	99	175377	177	178657	293, 488	227626	81	253096	140	277026	171	294436	298, 490	348849	73	352636	321	362672	275	369460	285	375748	200, 261
107417	99	175378	177	178725	293, 491	227636	81	253111	140	277036	171	294447	298, 490	351047	191	359800	189	362675	275	369462	285	375827	200, 260
107506	99	175397	177	178726	293, 491	227647	81	253126	140	277037	171	294457	298, 490	351050	191	359818	189	362677	275	369470	285	375848	200, 260
107507	99	175398	177	178735	293, 491	227657	81	253144	140	277047	171	294526	298, 490	351056	191	359820	189	362678	275	369472	285	377116	175
107516	99	175476	177	178736	293, 491	227726	81	253145	140	277057	171	294536	298, 490	351057	191	359826	189	362679	275	369500	281	377126	175
107517	99	175496	177	178746	293, 491	227736	81	253196	140	277116	259	294547	298, 490	351060	191	359828	189	366348	283, 285	369502	281	377137	175
131137	121	175576	177	178747	293, 491	227747	81	253226	140	277126	259	294557	298, 490	351066	191	359846	189	366358	279, 281	369510	281	377147	175
131147	121	175596	177	178756	293, 491	227757	81	253244	140	277136	259	297026	257	351086	191	359850	189	366448	283, 285	369512	281	377316	101
131177	121	177070	125	178757	293, 491	227826	80	253245	140	277137	259	297027	257	351096	191	359856	189	369200	279	369520	285	377326	101
131182	121	177076	125	178927	55	227836	80	253296	140	277147	259	297036	257	351147	191	359857	189	369202	279	369522	285	377337	101
131186	121	177077	125	178928	55	227847	80	253311	140	277157	259	297037	257	351150	191	359870	189	369210	279	369530	285	377347	101
131192	121	177078	125	178930	55	227857	80	253326	140	279706	477	297046	257	351156	191	359876	189	369212	279	369532	285	377626	118
131196	121	177097	125	178931	55	227926	80	253344	140	279716	477	297047	257	351157	191	359877	189	369220	283	369540	281	377636	118
131197	121	177446	115	178936	55	227936	80	253345	140	279726	477	297126	257	351160	191	359882	189	369222	283	369542	281	377647	118
131237	121	177456	115	178937	55	227947	80	253396	140	279727	477	297127	257	351166	191	359892	189	369230	283	369550	281	377657	118
131247	121	177467	115	178940	291, 490	227957	80	253411	140	279736	477	297136	257	351186	191	359900	189	369232	283	369552	281	378527	200, 260
131282	121	177477	115	178941	291, 490	228472	104	253426	140	279737	477	297137	257	351196	191	359918	189	369240	279	369560	285	378548	200, 260
131286	121	177626	171	178946	291, 490	228518	104	253444	140	279746	477	297146	257	352103	321	359920	189	369242	279	369562	285	378627	200, 261
131292	121	177636	171	178947	291, 490	228526	104	253445	140	279747	477	297147	257	352113	321	359926	189	369250	279	369570	285	378648	200, 261
131296	121	177647	171	179090	145	248016	59	253496	140	279756	477	297226	257	352123	321	359928	189	369252	279	369572	285	378727	200, 261
133806	33	177657	171	179091	145	248017	59	253511	140	279757	477	297227	257	352126	321	359946	189	369260	283	369580	275, 286	378748	200, 261
133807	33	177726	171	179226	145	248026	59	253526	140	279767	477	297306	256	352133	321	359950	189	369262	283	369651	277, 286	378827	200, 260
133816	33	177736	171	179247	145	248027	59	253544	140	279777	477	297307	256	352136	321	359956	189	369270	283	369653	277	378848	200, 260
133817	33	177747	171	179526	477	248046	59	253545	140	293026	109	297316	256	352203	321	359970	189	369272	283	371901	181	379527	200, 260
133826	33	177757	171	179547	477	248047	59	253596	140	293036	109	297317	256	352213	321	359976	189	369300	281	371902	181	379548	200, 260
133836	33	177826	258	179706	145	248056	59	253611	141	293047	109	297326	256	352223	321	359982	189	369302	281	371903	181	379627	200, 261
133847	33	177836	258	179716	145	248057	59	253626	141	293057	109	297327	256	352226	321	359992	189	369310	281	371905	180	379648	200, 261
133857	33	177847	258	179726	145	248116	60	253644	141	293126	109	297336	256	352233	321	360526	317	369312	281	371906	180	379727	200, 261
145530	119	177857	258	179727	145	248117	60	253645	141	293136	109	297337	256	352236	321	360530	317	369320	285	371907	180	379748	200, 261
145531	119	177920	125	179736	145	248126	60	253696	141	293147	109	297346	256	352303	321	360533	317	369322	285	371921	181	379827	200, 260
145541	119	177926	258	179737	145	248127	60	260931	313, 489	293157	109	297347	256	352313	321	360726	319	369330	285	371922	181	379848	200, 260
145567	119	177927	125	179746	145	248146	60	260932	313, 489	293226	109	297356	256	352323	321	360734	319	369332	285	371923	181	390626	183
145610	119	177928	125	179747	145	248147	60	260933	313, 489	293236	109	297357	256	352326	321	360764	319	369340	281	371925	180	390636	183
145611	119	177936	258	179756	145	248156	60	260934	313, 489	293247	109	297901	257	352333	321	362621	275	369342	281	371926	180	390647	183
145621	119	177947	258	179757	145	248157	60	260936	313, 489	293257	109	297902	257	352336	321	362623	275	369350	281	371927	180	390657	183
145626	119	177957	258	179767	145	249016	295, 488	260937	313, 489	293326	109	297911	257	352403	321	362625	275	369352	281	371941	179	390726	183
145900	117, 119	178000	57, 63, 65, 101	179777	145	249017	295, 488	260941	313, 489	293336	109	297912	257	352413	321	362627	275	369360	285	371942	179	390736	183
150073	315	178326	57	186224	300	24																	

390757	183	407325	457	411976	262	418256	209	418796	197	419399	91	419874	47	431726	327	446735	458	446787	458	450234	215	450496	131
390826	183	407326	457	411977	262	418257	209	418797	197	419406	92	419875	47	432003	301	446736	460	446788	458	450244	215	450602	131
390836	183	407333	457	416103	323	418266	209	419106	90	419416	92	419876	47	432013	301	446737	460	446789	458	450245	215	450604	131
390847	183	407334	457	416113	323	418267	209	419116	90	419426	92	419884	47	432023	301	446738	460	446790	460	450252	215	450612	131
390857	183	407335	457	416123	323	418284	209	419126	90	419427	92	419885	47	432026	301	446739	458	446791	460	450254	215	450614	131
405416	193	407336	457	416126	323	418286	209	419127	90	419437	92	419886	47	432033	301	446740	458	446792	460	450255	215	450615	131
405426	193	407344	457	416133	323	418294	209	419137	90	419447	92	419894	47	432036	301	446741	458	446793	458	450262	215	450622	131
405437	193	407345	457	416136	323	418296	209	419147	90	419474	92	419895	47	432097	301	446742	460	446794	458	450266	215	450624	131
405447	193	407346	457	416203	325	418301	455	419174	90	419475	92	419896	47	432099	301	446743	460	446795	458	450286	215	450634	131
405482	193	407347	457	416213	325	418302	455	419175	90	419476	92	420654	203	433926	151, 490	446744	460	446796	460	450292	215	450644	131
405485	193	407354	457	416223	325	418307	455	419176	90	419484	92	420656	203	433927	151, 490	446745	458	446797	460	450296	215	450645	131
405492	193	407355	457	416226	325	418308	455	419184	90	419485	92	420657	203	433947	151, 490	446746	458	446798	460	450302	451	450652	131
405495	193	407356	457	416233	325	418315	455	419185	90	419486	92	420664	203	433948	151, 490	446747	458	446799	458	450312	451	450654	131
405916	193	407357	457	416236	325	418316	455	419186	90	419494	92	420666	203	433992	151, 490	446748	461	446800	458	450322	451	450655	131
405926	193	407378	457	416303	325	418333	455	419194	90	419495	92	420667	203	433993	151, 490	446749	461	446801	458	450324	451	450662	131
405937	193	407379	457	416313	325	418334	455	419195	90	419496	92	420674	203	433996	151, 490	446750	461	446802	461	450332	451	450666	131
405947	193	407380	457	416323	325	418385	455	419196	90	419506	93	420676	203	433997	151, 490	446751	461	446803	461	450334	451	450686	131
405982	193	407381	457	416326	325	418386	455	419197	90	419516	93	420677	203	446700	460	446752	461	446804	461	450344	451	450692	131
405985	193	407383	457	416333	325	418387	455	419199	90	419526	93	420682	203	446701	460	446753	461	446805	461	450345	451	450696	131
405992	193	407384	457	416336	325	418393	455	419206	91	419527	93	420685	203	446702	460	446754	460	446806	461	450352	451	452012	117
405995	193	407385	457	416626	271	418394	455	419216	91	419537	93	420687	203	446703	458	446755	460	446807	461	450354	451	452022	117
406216	195	407386	457	416636	271	418395	455	419226	91	419547	93	422354	485	446704	458	446756	460	449003	303	450355	451	452026	117
406226	195	407388	457	416647	271	418396	455	419227	91	419574	93	422356	485	446705	458	446757	458	449013	303	450356	451	452036	117
406237	195	407389	457	416657	271	418402	209	419237	91	419575	93	422357	485	446706	460	446758	458	449023	303	450362	451	452047	117
406247	195	407390	457	416726	271	418408	209	419247	91	419576	93	422364	485	446707	460	446759	458	449026	303	450364	451	452057	117
406282	195	407391	457	416736	271	418409	209	419274	91	419584	93	422366	485	446708	460	446760	460	449033	303	450365	451	453026	239
406285	195	407393	457	416747	271	418410	209	419275	91	419585	93	422367	485	446709	458	446761	460	449036	303	450366	451	453047	239
406292	195	407394	457	416757	271	418412	209	419276	91	419586	93	422374	485	446710	458	446762	460	450102	215	450372	451	453070	239
406295	195	407395	457	418028	209	418418	209	419284	91	419594	93	422376	485	446711	458	446763	458	450104	215	450374	451	453076	239
407026	135	407396	457	418029	209	418419	209	419285	91	419595	93	422377	485	446712	460	446764	458	450112	215	450375	451	453096	239
407027	135	407926	135	418030	209	418420	209	419286	91	419596	93	422382	485	446713	460	446765	458	450114	215	450382	451	453097	239
407044	135	407947	135	418032	209	418446	209	419294	91	419606	93	422385	485	446714	460	446766	460	450115	215	450384	451	453126	235
407045	135	408626	265	418066	209	418447	209	419295	91	419616	93	422387	485	446715	458	446767	460	450122	215	450386	451	453147	235
407057	135	408636	265	418067	209	418456	209	419296	91	419626	93	425021	223	446716	458	446768	460	450124	215	450394	451	453170	237
407095	135	408647	265	418104	209	418457	209	419297	91	419627	93	425026	223	446717	458	446769	458	450134	215	450396	451	453176	237
407096	135	408657	265	418106	209	418484	209	419299	91	419637	93	425047	223	446718	460	446770	458	450144	215	450402	131	453226	235
407144	135	408726	262	418128	209	418485	455	419306	91	419647	93	425050	223	446719	460	446771	458	450145	215	450404	131	453247	235
407145	135	408747	262	418132	209	418486	209	419316	91	419674	93	425521	223	446720	460	446772	460	450152	215	450412	131	453270	237
407157	135	408826	264	418202	209	418494	209	419326	91	419675	93	425526	223	446721	458	446773	460	450154	215	450414	131	453276	237
407216	135	408847	264	418204	209	418496	209	419327	91	419676	93	425547	223	446722	458	446774	460	450155	215	450415	131	453596	233
407217	135	408926	264	418206	209	418716	197	419337	91	419684	93	425550	223	446723	458	446775	458	450162	215	450422	131	453696	233
407226	135	408947	264	418208	209	418726	197	419347	91	419685	93	431203	327	446724	460	446776	458	450166	215	450424	131	454003	329
407227	135	409526	49	418209	209	418737	197	419374	91	419686	93	431223	327	446725	460	446777	458	450186	215	450434	131	454023	329
407244	135	409527	49	418210	209	418747	197	419375	91	419694	93	431226	327	446726	460	446778	460	450192	215	450444	131	454026	329
407245	135	409536	49	418212	209	418782	197	419376	91	419695	93	431303	327	446727	458	446779	460	450196	215	450445	131	454103	329
407257	135	409537	49	418218	209	418784	197	419384	91	419696	93	431323	327	446728	458	446780	460	450202	215	450452	131	454123	329
407285	135	409626	49	418219	209	418785	197	419385	91	419806	47	431326	327	446729	458	446781	460	450204	215	450454	131	454126	329
407286	135	409627	49	418220	209	418786	197	419386	91	419816	47	431603	327	446730	460	446782	458	450212	215	450455	131	454203	329
407295	135	409636	49	418229	209	418787	197	419394	91	419826	47	431623	327	446731	460	446783	458	450214	215	450462	131	454223	329
407296	135	409637	49	418230	209	418792	197	419395	91	419827	47	431626	327	446732	460	446784	460	450215	215	450476	131	454226	329
407323	457	411926	262	418246	209	418794	197	419396	91	419837	47	431703	327	446733	458	446785	460	450222	215	450486	131	454309	329
407324	457	411937	262	418247	209	418795	197	419397	91	419847	47	431723	327	446734	458	446786	460	450224	215	450492	131	454323	329

454326	329	456386	31	457212	227	458557	187	459657	454	467167	163	471147	61	473576	309	478406	228	479496	152	480304	479	484982	453
456002	211	456392	31	457224	227	458612	187	459683	454	467177	163	471156	61	473703	309	478646	146	479526	153	481100	241	484983	453
456004	211	456396	31	457234	227	458622	187	459684	454	467187	163	471157	61	473713	309	478656	146	479536	153	481150	241	484984	453
456012	211	456402	127	457244	227	458626	187	459685	454	467196	163	471176	61	473723	309	478667	146	479547	153	482546	482	484986	452
456014	211	456404	127	457245	227	458636	187	459686	454	467197	163	471177	61	473726	309	478677	146	479557	153	482556	482	484987	452
456015	211	456412	127	457252	227	458647	187	459693	454	467206	161	472106	95	473733	309	478702	146	479582	153	482567	482	484996	452
456022	211	456414	127	457254	227	458657	187	459694	454	467217	161	472116	95	473736	309	478706	146	479586	153	482577	482	484997	452
456024	211	456415	127	457255	227	459016	137	459695	454	467227	161	472126	95	474003	311	478712	146	479592	153	482646	483	485426	270
456034	211	456422	127	457262	227	459026	137	459696	454	467228	161	472127	95	474013	311	478716	146	479596	153	482656	483	485447	270
456044	211	456424	127	457286	227	459036	137	466008	79	467236	161	472137	95	474023	311	478736	228	479626	147	482667	483	485526	270
456045	211	456434	127	457296	227	459037	137	466018	79	467238	161	472147	95	474026	311	478746	228	479636	147	482677	483	485547	270
456052	211	456444	127	457302	227	459047	137	466026	79	467256	161	472172	95	474033	311	478757	228	479647	147	482846	483	485716	158
456054	211	456445	127	457312	227	459057	137	466036	79	467266	161	472174	95	474036	311	478767	228	479657	147	482856	483	485726	157
456055	211	456452	127	457324	227	459066	137	466047	79	467276	161	472175	95	474203	311	478792	228	479682	147	482867	483	485736	157
456062	211	456454	127	457334	227	459086	137	466057	79	467286	161	472176	95	474213	311	478796	228	479686	147	482877	483	485737	158
456066	211	456455	127	457344	227	459096	137	466108	79	467287	161	472182	95	474223	311	478802	228	479692	147	484626	65	485747	157
456086	211	456462	127	457345	227	459102	137	466118	79	467298	161	472184	95	474226	311	478806	228	479696	147	484636	65	485757	157
456092	211	456476	127	457352	227	459106	137	466126	79	467306	163	472185	95	474233	311	479026	152	479726	229	484647	65	485776	158
456096	211	456486	127	457354	227	459107	137	466136	79	467317	163	472186	95	474236	311	479047	152	479736	229	484657	65	485782	157
456102	211	456492	127	457355	227	459112	137	466147	79	467327	163	472192	95	476503	333	479092	152	479747	229	484716	158	485783	158
456104	211	456496	127	457362	227	459116	137	466157	79	467328	163	472194	95	476513	333	479096	152	479757	229	484726	155	485786	157
456112	211	456502	129	457386	227	459117	137	466208	105	467336	163	472195	95	476523	333	479126	153	479782	229	484736	155	485792	157
456114	211	456504	129	457396	227	459137	137	466218	105	467338	163	472196	95	476526	333	479147	153	479786	229	484737	158	485796	157
456115	211	456512	129	457402	473	459156	137	466226	105	467356	163	473043	305	476533	333	479192	153	479792	229	484747	155	485816	159
456122	211	456522	129	457412	473	459166	137	466236	105	467366	163	473053	305	476536	333	479196	153	479796	229	484757	155	485826	157
456124	211	456524	129	457424	473	459516	139	466247	105	467376	163	473063	305	477503	333	479226	147	479826	231	484776	158	485836	157
456134	211	456534	129	457434	473	459526	139	466257	105	467386	163	473066	305	477513	333	479236	148	479836	231	484782	155	485837	159
456144	211	456552	129	457444	473	459536	139	466308	105	467387	163	473073	305	477523	333	479237	149	479847	231	484783	158	485847	157
456145	211	456562	129	457445	473	459537	139	466318	105	467398	163	473076	305	477526	333	479247	147	479857	231	484786	155	485857	157
456152	211	456566	129	457452	473	459547	139	466326	105	468526	199	473143	307	477533	333	479257	148	479882	231	484792	155	485876	159
456154	211	456586	129	457454	473	459557	139	466336	105	468536	199	473153	307	477536	333	479258	149	479886	231	484796	155	485882	157
456155	211	456592	129	457455	473	459566	139	466347	105	468547	199	473163	307	477626	475	479282	148	479892	231	484816	159	485883	159
456162	211	456596	129	457462	473	459567	139	466357	105	468557	199	473166	307	477636	475	479283	149	479896	231	484826	155	485886	157
456166	211	456602	127	457486	473	459577	139	467006	161	471016	61	473173	307	477647	475	479286	148	479926	148	484836	155	485892	157
456186	211	456604	127	457496	473	459586	139	467016	161	471017	61	473176	307	477657	475	479287	149	479927	149	484837	159	485896	157
456192	211	456612	127	457502	133	459596	139	467026	161	471026	61	473203	305	477682	475	479292	147	479936	148	484847	155	487301	450
456196	211	456614	127	457512	133	459597	139	467036	161	471027	61	473213	305	477686	475	479296	147	479937	149	484857	155	487302	450
456302	31	456615	127	457524	133	459623	454	467046	161	471036	61	473223	305	477692	475	479316	231	479947	148	484876	159	487311	450
456304	31	456622	127	457534	133	459624	454	467047	161	471037	61	473226	305	477696	475	479326	229	479948	149	484882	155	487312	450
456312	31	456624	127	457544	133	459625	454	467057	161	471046	61	473233	305	478113	331	479337	231	479957	148	484883	159	487323	450
456314	31	456634	127	457545	133	459626	454	467067	161	471047	61	473236	305	478133	331	479347	229	479958	149	484886	155	487324	450
456315	31	456644	127	457552	133	459633	454	467077	161	471056	61	473303	307	478136	331	479382	231	479982	148	484892	155	487333	450
456322	31	456645	127	457554	133	459634	454	467087	161	471057	61	473313	307	478213	331	479386	231	479983	149	484896	155	487334	450
456324	31	456652	127	457555	133	459635	454	467096	161	471076	61	473323	307	478233	331	479392	229	479986	148	484965	452	487344	450
456334	31	456654	127	457562	133	459636	454	467097	161	471077	61	473326	307	478236	331	479396	229	479987	149	484966	452	487345	450
456344	31	456655	127	457586	133	459644	454	467106	163	471116	61	473333	307	478246	146	479426	152	479992	148	484971	453	487352	450
456345	31	456662	127	457596	133	459645	454	467116	163	471117	61	473336	307	478267	146	479436	152	479993	149	484972	453	487354	450
456352	31	456666	127	458512	187	459646	454	467126	163	471126	61	473543	309	478312	146	479447	152	479996	148	484973	453	487355	450
456354	31	456686	127	458522	187	459647	454	467136	163	471127	61	473553	309	478316	146	479457	152	479997	149	484974	453	487362	450
456355	31	456692	127	458526	187	459654	454	467146	163	471136	61	473563	309	478336	228	479482	152	480100	243	484975	452	487364	450
456362	31	456696	127	458536	187	459655	454	467147	163	471137	61	473566	309	478357	228	479486	152	480104	243	484976	452	487365	450
456376	31	457202	227	458547	187	459656	454	467157	163	471146	61	473573	309	478402	228	479492	152	480300	479	484981	453	487372	450

487374	450	488614	456	491270	249	492350	251	494557	471	498106	71	498595	29	630377	241	650386	40	650786	84	681790	403	681940	403
487375	450	488615	456	491276	249	492356	251	496021	245	498116	71	498596	29	650042	37	650387	40	650787	84	681792	405	681942	405
487384	450	488619	456	491277	249	492357	251	496026	245	498126	71	499077	303	650044	37	650446	41	650796	84	681794	403	681944	403
487385	450	488620	456	491280	249	492360	251	496037	245	498127	71	499097	303	650046	36	650447	41	650797	84	681796	405, 413	681946	405
487386	450	488625	456	491286	249	492366	251	496056	245	498137	71	499099	303	650047	36	650466	41	650846	88	681800	403	681950	403
487395	450	488626	456	491287	249	492367	251	496057	245	498147	71	620146	172	650052	37	650467	41	650847	88	681802	405	681952	405
487396	450	488630	456	491426	165	492916	263	496091	245	498172	71	620147	172	650054	37	650486	41	650866	88	681804	403	681954	403
487903	213	488631	456	491436	165	492917	263	496096	245	498174	71	620156	172	650056	36	650487	41	650867	88	681806	405	681956	405
487926	213	488635	456	491447	165	492976	263	496521	481	498175	71	620157	172	650057	36	650542	87	650886	88	681820	403	681960	403
487947	213	488636	456	491457	165	492977	263	496526	481	498176	71	620166	172	650062	37	650544	87	650887	88	681822	405	681962	405
488015	217	488640	456	491541	247	494001	225	496537	481	498182	71	620167	172	650064	37	650546	85	650946	89	681824	403	681964	403
488025	217	488641	456	491551	247	494016	225	496556	481	498184	71	620176	172	650066	36	650547	85	650947	89	681826	405	681966	405
488026	217	488646	456	491562	247	494019	225	496557	481	498185	71	620177	172	650067	36	650552	87	650966	89	681830	403	681970	403
488036	217	488647	456	491572	247	494020	225	496591	481	498186	71	620346	240	650072	37	650554	87	650967	89	681832	405	681972	405
488047	217	488649	456	491641	247	494050	225	496596	481	498192	71	620347	240	650074	37	650556	85	650986	89	681834	403	681974	403
488050	217	488650	456	491651	247	494056	225	497106	63	498194	71	620356	240	650076	36	650557	85	650987	89	681836	405	681976	405
488060	217	488651	456	491662	247	494057	225	497116	63	498195	71	620357	240	650077	36	650562	87	68026	400	681840	403	681980	403
488115	217	488652	456	491672	247	494096	225	497126	63	498196	71	620366	240	650082	37	650564	87	680047	400, 413	681842	405	681982	405
488125	217	488654	456	491826	167	494101	225	497127	63	498406	71	620367	240	650084	37	650566	85	680226	400	681844	403	681984	403
488126	217	488655	456	491836	167	494116	225	497137	63	498416	71	620376	240	650086	36	650567	85	680247	400, 413	681846	405	681986	405
488136	217	488815	219	491846	167	494119	225	497147	63	498426	71	620377	240	650087	36	650572	87	681700	403	681850	403	681990	403
488147	217	488820	219	491847	167	494120	225	497172	63	498427	71	621146	173	650092	37	650574	87	681702	405	681852	405	681992	405
488150	217	488826	219	491856	167	494150	225	497174	63	498437	71	621147	173	650094	37	650576	85	681704	403	681854	403	681994	403
488160	217	488831	219	491857	167	494156	225	497175	63	498447	71	621156	173	650096	36	650577	85	681706	405	681856	405	681996	405
488217	207	488836	219	491867	167	494157	225	497176	63	498472	71	621157	173	650097	36	650582	87	681720	403	681860	403	682070	408
488226	207	488841	219	491877	167	494196	225	497182	63	498474	71	621166	173	650146	39	650584	87	681722	405	681862	405	682072	408
488237	207	488847	219	491926	246	494219	143	497184	63	498475	71	621167	173	650147	39	650586	85	681724	403	681864	403	682073	408
488240	207	488850	219	491936	246	494220	143	497185	63	498476	71	621176	173	650156	39	650587	85	681726	405	681866	405	682074	408
488247	207	488852	219	491946	246	494226	143	497186	63	498482	71	621177	173	650157	39	650592	87	681730	403	681870	403	682075	408
488250	207	488855	219	491947	246	494247	143	497192	63	498484	71	621346	240	650166	39	650594	87	681732	405	681872	405	682076	408
488290	221	488915	219	491956	246	494250	143	497194	63	498485	71	621347	240	650167	39	650596	85	681734	403	681874	403	682077	408
488291	221	488920	219	491957	246	494256	143	497195	63	498486	71	621347	240	650176	39	650597	85	681736	405	681876	405	682078	408
488292	221	488926	219	491967	246	494257	143	497196	63	498492	71	621357	240	650177	39	650646	86	681740	403	681880	403	682079	408
488293	221	488931	219	491977	246	494294	143	497406	63	498494	71	621366	240	650187	39	650647	86	681742	405	681882	405	682170	408
488323	269	488936	219	492050	169	494295	143	497416	63	498495	71	621367	240	650196	39	650656	86	681744	403	681884	403	682172	408
488333	269	488941	219	492056	169	494296	143	497426	63	498496	71	621376	240	650197	39	650657	86	681746	405	681886	405	682173	408
488356	269	488947	219	492057	169	494419	469	497427	63	498506	29	621377	240	650246	35	650666	86	681750	403	681890	403	682174	408
488366	269	488950	219	492060	169	494420	469	497437	63	498516	29	630146	173	650247	35	650667	86	681752	405	681892	405	682175	408
488377	269	488952	219	492066	169	494426	469	497447	63	498526	29	630147	173	650256	35	650676	86	681754	403	681894	403	682176	408
488387	269	488955	219	492067	169	494447	469	497472	63	498527	29	630156	173	650257	35	650677	86	681756	405	681896	405	682177	408
488403	269	491050	165	492150	251	494450	469	497474	63	498537	29	630157	173	650266	35	650686	86	681760	403	681900	403	682178	408
488413	269	491056	165	492156	251	494456	469	497475	63	498547	29	630166	173	650267	35	650687	86	681762	405	681902	405	682179	408
488436	269	491057	165	492157	251	494457	469	497476	63	498572	29	630167	173	650276	35	650696	86	681764	403	681904	403	682700	406
488446	269	491060	165	492160	251	494494	469	497482	63	498574	29	630176	173	650277	35	650697	86	681766	405	681906	405	682702	407
488457	269	491066	165	492166	251	494495	469	497484	63	498575	29	630177	173	650286	35, 39	650746	84	681770	403	681920	403	682704	406
488467	269	491067	165	492167	251	494496	469	497485	63	498576	29	630346	241	650287	35	650747	84	681772	405	681922	405	682706	407
488516	207	491170	249	492250	169	494501	471	497486	63	498582	29	630347	241	650296	35	650756	84	681774	403	681924	403	682720	406
488526	207	491176	249	492256	169	494516	471	497492	63	498584	29	630356	241	650297	35	650757	84	681776	405	681926	405	682722	407
488537	207	491177	249	492257	169	494519	471	497494	63	498585	29	630357	241	650346	40	650766	84	681780	403	681930	403	682724	406
488540	207	491180	249	492260	169	494520	471	497495	63	498586	29	630366	241	650347	40	650767	84	681782	405	681932	405	682726	407
488547	207	491186	249	492266	169	494550	471	497496	63	498592	29	630367	241	650366	40	650776	84	681784	403	681934	403	682730	406
488550	207	491187	249	492267	169	494556	471	498100	71	498594	29	630376	241	650367	40	650777	84	681786	405	681936	405	682732	407

682734	406	682874	406	683212	409	684257	411, 427	691142	447	691746	419	691886	419	692940	368, 384, 408, 423	750161	106	810750	380	810908	365	810980	364
682736	407	682876	407	683213	409	684259	411, 427	691147	361, 391, 401, 417	691750	418	691890	418	692950	368, 384, 408, 423	750162	106	810751	380	810910	364	810981	364
682740	406	682880	406	683215	409	684262	411, 427	691148	339, 446, 447	691752	419	691892	419	693202	425	750165	106	810752	381	810911	364	810982	365
682742	407	682882	407	683216	409	684263	411, 427	691149	339, 446, 447	691754	418	691894	418	693203	425	750170	106	810753	381	810912	365	810983	365
682744	406	682884	406	683217	409	684265	411, 427	691150	339, 446, 447	691756	419	691896	419	693205	425	750171	106	810754	380	810913	365	810984	364
682746	407	682886	407	683219	409	684266	411, 427	691151	447	691760	418	691900	418	693206	425	750172	106	810755	380	810914	364	810985	364
682750	406	682890	406	683242	409	684267	411, 427	691152	447	691762	419	691902	419	693207	425	750175	106	810756	381	810915	364, 373	810986	365
682752	407	682892	407	683243	409	684268	411, 427	691153	447	691764	418	691904	418	693209	425, 429	810012	358	810758	381	810916	365	810988	365
682754	406	682894	406	683245	409	684272	411, 427	691157	361, 391, 401, 417	691766	419	691906	419	693212	425	810026	358, 373	810760	380	810918	365	810990	364
682756	407	682896	407	683246	409	684273	411, 427	691226	361, 391, 401, 417	691770	418	691920	418	693213	425	810047	358	810761	380	810920	364	810991	364
682760	406	682900	406	683247	409	684275	411, 427	691236	361, 391, 401, 417	691772	419	691922	419	693215	425, 429	810104	358, 373, 400	810762	381	810921	364	810992	365
682762	407	682902	407	683248	409	684276	411, 427	691237	339, 446, 447	691774	418	691924	418	693216	425	810105	374, 400, 414	810763	381	810922	365	810993	365
682764	406	682904	406	683252	409	684277	411, 427	691238	339, 446, 447	691776	419	691926	419	693217	425	810106	374, 400, 414	810764	380	810923	365	810994	364
682766	407	682906	407	683253	409	684279	411, 427	691239	339, 446, 447	691780	418	691930	418	693219	425	810126	358, 374, 429	810765	380	810924	364	810995	364, 373
682770	406	682920	406	683255	409	685026	401	691240	447	691782	419	691932	419	693242	425	810147	374, 400, 411, 414, 425, 427, 429	810766	381	810925	364	810996	365
682772	407	682922	407	683256	409	685047	401, 413	691241	447	691784	418	691934	418	693243	425	810147	374, 400, 411, 413, 414, 425, 427	810768	381	810926	365	810998	365
682774	406	682924	406	683257	409	685126	401	691242	447	691786	419	691936	419	693245	425	810147	374, 400, 411, 413, 414, 425, 427	810770	380	810928	365	811700	363, 379
682776	407	682926	407	683259	409	685147	401	691247	361, 391, 401, 417	691790	418	691940	418	693246	425	810312	358	810771	380	810929	358	811701	363, 379
682780	406	682930	406	683262	409	685226	401	691248	339, 446, 447	691792	419	691942	419	693247	425	810326	358	810772	381, 387	810940	364	811704	363, 379
682782	407	682932	407	683263	409	685247	401	691249	339, 446, 447	691794	418	691944	418	693249	425	810347	358	810773	381	810941	364	811705	363, 379
682784	406	682934	406	683265	409	689026	400	691250	339, 446, 447	691796	419	691946	419	693252	425	810700	380	810774	380	810942	365	811710	363, 379
682786	407	682936	407	683266	409	689047	400	691251	447	691800	418	691950	418	693253	425	810701	380	810775	380	810943	365	811711	363, 379
682790	406	682940	406	683267	409	689101	400	691252	447	691802	419	691952	419	693255	425	810702	381	810776	381	810944	364	811714	363, 379
682792	407	682942	407	683268	409	690026	414, 429	691253	447	691804	418	691954	418	693256	425	810703	381	810778	381	810945	364	811715	363, 379
682794	406, 413	682944	406	683272	409	690047	414	691257	361, 391, 401, 417	691806	419	691956	419	693257	425	810704	380	810780	380	810946	365	811720	363, 379
682796	407	682946	407	683273	409	690926	414	691326	361, 391, 401, 417	691820	418	691960	418	693259	425	810705	380	810781	380	810948	365	811721	363, 379
682800	406	682950	406	683275	409	690936	414	691336	361, 391, 401, 417	691822	419	691962	419	693262	425	810706	381	810782	381	810949	358	811724	363, 379
682802	407	682952	407	683276	409	690947	414	691347	361, 391, 401, 417	691824	418	691964	418	693263	425	810708	381	810783	381	810950	364	811725	363, 379
682804	406	682954	406	683277	409	690957	414	691357	361, 391, 401, 417	691826	419	691966	419	693265	425	810710	380	810784	380	810951	364	811740	363, 379
682806	407	682956	407	683279	409	691026	361, 391, 401, 417	691426	361, 391, 401, 417	691830	418	691970	418	693266	425	810711	380	810785	380	810952	365	811741	363, 379
682820	406	682960	406	684202	411, 413, 427	691036	361, 391, 401, 417	691436	361, 391, 401, 417	691832	419	691972	419	693267	425	810714	380	810786	381	810953	365	811744	363, 379
682822	407	682962	407	684203	411, 427	691037	339, 446, 447	691447	361, 391, 401, 417	691834	418	691974	418	693269	425	810715	380	810788	381	810954	364	811745	363, 379
682824	406	682964	406	684205	411, 427	691038	339, 446, 447	691457	361, 391, 401, 417	691836	419	691976	419	693272	425	810720	380	810790	380	810955	364	811750	363, 379
682826	407	682966	407	684206	411, 427	691039	339, 446, 447	691526	361, 391, 401, 417	691840	418	691980	418	693273	425	810721	380	810791	380	810956	365	811751	363, 379
682830	406	682970	406	684207	411, 427	691040	447	691536	361, 391, 401, 417	691842	419	691982	419	693275	425	810722	381	810792	381	810958	365	811754	363, 379
682832	407	682972	407	684209	411, 427	691041	447	691547	361, 391, 401, 417	691844	418	691984	418	693276	425	810723	381	810793	381	810960	364	811755	363, 379
682834	406	682974	406	684212	411, 427	691042	447	691557	361, 391, 401, 417	691846	419	691986	419	693277	425	810724	380	810794	380	810961	364	811760	363, 379
682836	407	682976	407	684213	411, 427	691047	361, 391, 401, 413, 417	691700	418	691850	418	691990	418	693279	425	810725	380	810795	380	810962	365	811761	363, 379
682840	406	682980	406	684215	411, 427	691048	339, 446, 447	691702	419	691852	419	691992	419	695026	417	810726	381	810796	381	810963	365	811764	363, 379
682842	407	682982	407	684216	411, 427	691049	339, 446, 447	691704	418	691854	418	691994	418	695047	417	810728	381	810798	381	810964	364	811765	363, 379
682844	406	682984	406	684217	411, 427	691050	339, 446, 447	691706	419	691856	419	691996	419	695126	417	810732	381	810812	358, 371, 383	810965	364	811770	363, 379
682846	407	682986	407	684219	411, 427	691051	447	691720	418	691860	418	692170	423	695147	417	810733	381	810826	358, 370, 371, 382, 383, 409	810966	365	811771	363, 379
682850	406	682990	406	684242	411, 427	691052	447	691722	419	691862	419	692172	423	695226	417	810736	381	810847	358, 370, 371, 382, 383, 409	810968	365	811774	363, 379
682852	407	682992	407	684243	411, 427	691053	447	691724	418	691864	418	692173	423	695247	417	810738	381	810847	358, 370, 371, 382, 383, 409	810969	358	811775	363, 379
682854	406	682994	406	684245	411, 427	691057	361, 391, 401, 417	691726	419	691866	419	692174	423	700138	97, 99	810740	380	810970	364	810971	364	811780	363, 379
682856	407	682996	407	684246	411, 427	691126	361, 391, 401, 417	691730	418	691870	418	692175	423	700139	97, 99	810741	380	810900	364	810971	364	811781	363, 379
682860	406	683202	409	684247	411, 427	691136	361, 391, 401, 417	691732	419	691872	419	692176	423	700238	97, 99	810742	381	810901	364	810972	365	811784	363, 379
682862	407	683203	409	684248	411, 427	691137	339, 446, 447	691734	418	691874	418	692177	423	700239	97, 99	810743	381	810902	365	810973	365	811785	363, 379
682864																							

812700	380	812950	364	814717	367	814802	367	814867	367	814952	367	815252	382	819222	385	890926	361, 391, 401, 417	952020	339	954905	348, 353	960225	433
812702	381	812952	365	814718	367	814803	367	814868	367	814953	367	815253	382	819226	369, 385	890947	361, 391, 401, 417	952021	339	955012	354	960230	433
812704	380	812954	364	814720	367	814805	367	814870	367	814955	367	815255	382	819227	369, 385	891026	361, 391, 401, 417	952022	339	955026	354	960235	433
812706	381	812956	365	814721	367	814806	367	814871	367	814956	367	815256	382	819231	385	891047	361, 391, 401, 417	952026	336	955047	354, 357	960240	433
812710	380	812960	364	814722	367	814807	367	814872	367	814957	367	815257	382	819232	385	891126	361, 391, 395, 401, 417	952035	343	955212	354	960245	433
812714	380	812962	365	814723	367	814808	367	814873	367	814958	367	815259	382	819236	369, 385			952040	339	955213	354	960250	433
812720	380	812964	364	814725	367	814810	367	814875	367	814960	367	815262	370	819237	369, 385	891147	361, 391, 401, 417	952041	339	955226	354	960255	433
812722	381	812966	365	814726	367	814811	367	814876	367	814961	367	815263	370	819251	385	891226	361, 391, 401, 417	952042	339	955227	354	960260	433
812724	380	812970	364	814727	367	814812	367	814877	367	814962	367	815265	370	819256	369, 385	891247	361, 391, 401, 417	952047	336, 341	955247	354, 357	960265	433
812726	381	812972	365	814728	367	814813	367	814878	367	814963	367	815266	370	819261	385	891326	361, 391, 401, 417	952050	339	955248	354, 357	960270	433
812732	381	812974	364	814730	367	814815	367	814900	367	814965	367	815267	370	819266	369, 385	891347	361, 391, 401, 417	952051	339	957026	346, 438	960275	433
812736	381	812976	365	814731	367	814816	367	814901	367	814966	367	815269	370	819271	385	891800	358	952052	339	957047	346, 438, 443	960280	433
812740	380	812980	364	814732	367	814817	367	814902	367	814967	367	815272	370	819276	369, 385	891826	358	952060	336, 346	957060	438	960285	433
812742	381	812982	365	814733	367	814818	367	814903	367	814968	367	815273	370	819410	384	891847	358	952070	336, 346	957070	438	960310	432
812744	380	812984	364	814735	367	814820	367	814905	367	814970	367	815275	370	819411	384	891900	358	952080	336, 346	957080	438	960315	432
812746	381	812986	365	814736	367	814821	367	814906	367	814971	367	815276	370	819420	384	891910	374	952090	336, 346	957090	438	960320	432
812750	380	812990	364	814737	367	814822	367	814907	367	814972	367	815277	370	819421	384	892000	358	952211	337, 349, 353, 355, 439	957226	438	960325	432
812752	381	812992	365	814738	367	814823	367	814908	367	814973	367	815279	370	819430	384	892100	358, 373	952212	336	957247	438, 443	960330	432
812754	380	812994	364	814740	367	814825	367	814910	367	814975	367	815290	371, 383	819431	384	892110	374	952213	336	957905	438, 443	960335	432
812756	381	812996	365	814741	367	814826	367	814911	367	814976	367	815291	371, 383	819450	384	892200	358	960006	430	960007	430, 437	960340	432
812760	380	813000	363, 379	814742	367	814827	367	814912	367	814977	367	815292	371, 383	819460	384	892326	361	952221	337, 349, 355, 439	960007	430, 437	960345	432
812762	381	813004	363, 379	814743	367	814828	367	814913	367	814978	367	815295	371, 383	819470	384	892330	361	952222	347	960008	430, 437	960350	432
812764	380	813010	363, 379	814745	367	814830	367	814915	367	815202	370	815299	371, 383	819610	368	892347	361	952223	347	960026	430	960355	432
812766	381	813014	363, 379	814746	367	814831	367	814916	367	815203	370	815342	382	819611	368	892426	361	952226	336, 346	960047	430	960360	432
812770	380	813020	363, 379	814747	367	814832	367	814917	367	815205	370	815343	382	819620	368	892430	361	952231	337, 349, 355, 439	960050	430	960365	432
812772	381	813024	363, 379	814748	367	814833	367	814918	367	815206	370	815345	382	819621	368	892447	361	952235	343	960055	430, 437	960370	432
812774	380	813030	363, 379	814750	367	814835	367	814920	367	815207	370	815346	382	819630	368	892526	361	952247	336, 341, 346	960060	430	960375	432
812776	381	813034	363, 379	814751	367	814836	367	814921	367	815209	370	815347	382	819631	368	892530	361	952251	337, 341, 349, 355, 439	960065	437	960380	432
812780	380	813038	363, 379	814752	367	814837	367	814922	367	815212	370	815349	382	819650	368	892547	361	952253	347	960070	430	960385	432
812782	381	813042	363, 379	814753	367	814838	367	814923	367	815213	370	815352	382	819660	368			952255	347	960080	430	960410	432
812784	380	813046	363, 379	814755	367	814840	367	814925	367	815215	370	815353	382	819670	368	892630	257, 358, 374, 388, 400, 414	952261	337, 349, 355, 439	960090	430	960415	432
812786	381	813050	363, 379	814756	367	814841	367	814926	367	815216	370	815355	382	819710	369	892631	257, 358, 374, 388, 400, 414	952263	347	960110	433	960420	432
812790	380	813054	363, 379	814757	367	814842	367	814927	367	815217	370	815356	382	819711	369	894512	358	952271	337, 349, 355, 439, 443	960115	433	960425	432
812792	381	813058	363, 379	814758	367	814843	367	814928	367	815219	370	815357	382	819720	369	894526	358	960120	433	960430	432		
812794	380	813062	363, 379	814760	367	814845	367	814930	367	815222	382	815359	382	819721	369	894547	358	952311	337, 355, 439	960125	433	960435	432
812796	381	813066	363, 379	814761	367	814846	367	814931	367	815223	382	815362	370	819730	369	894900	374, 387	952321	337, 355, 439	960127	430	960440	432
812900	364	813070	363, 379	814762	367	814847	367	814932	367	815225	382	815363	370	819731	369	895026	391, 395	952331	337, 355, 439	960130	433	960445	432
812902	365	813074	363, 379	814763	367	814848	367	814933	367	815226	382	815365	370	819750	369	895030	391	952900	343	960135	433	960450	432
812904	364	814700	367	814765	367	814850	367	814935	367	815227	382	815366	370	819760	369	895047	391	952901	343	960140	433	960455	432
812906	365	814701	367	814766	367	814851	367	814936	367	815229	382	815367	370	819770	369	895126	391	952902	343	960145	433	960460	432
812910	364	814702	367	814767	367	814852	367	814937	367	815232	382	815369	370	840026	374	895130	391	952903	343	960148	430	960465	432
812912	365	814703	367	814768	367	814853	367	814938	367	815233	382	815372	370	840047	374, 387	895147	391	952905	336, 341, 346, 354, 357	960150	433	960470	432
812914	364	814705	367	814770	367	814855	367	814940	367	815235	382	815373	370	840226	374	895226	391	954012	348	960155	433	960475	432
812916	365	814706	367	814771	367	814856	367	814941	367	815236	382	815375	370	840247	374, 387	895226	391	954026	348, 353	960160	433	960480	432
812920	364	814707	367	814772	367	814857	367	814942	367	815237	382	815376	370	860106	388	895230	391	954047	348	960165	433	960485	432
812922	365	814708	367	814773	367	814858	367	814943	367	815239	382	815377	370	860107	388	895247	391	954077	348	960170	433	960510	433
812924	364	814710	367	814775	367	814860	367	814945	367	815242	382	815379	370	860112	388, 393	950070	400	954212	348	960175	433	960515	433
812926	365	814711	367	814776	367	814861	367	814946	367	815243	382	815381	385	860126	388, 393, 395	950080	400	954226	348, 353	960180	433	960520	433
812940	364	814712	367	814777	367	814862	367	814947	367	815245	382	815382	385	860147	388, 393	950090	400	954247	348	960185	433	960525	433
812942	365	814713	367	814778	367	814863	367	814948	367	815246	382	815383	385	890826	361, 391, 401, 417	950090	400	954312	348	960210	433	960530	433
812944	364	814715	367	814800																			

960545	433	960733	435	960817	435	960901	435	960966	435	971662	392	971760	392	988100	396	TR1647	465
960550	433	960735	435	960818	435	960902	435	960967	435	971664	392	971761	392	988200	396, 399	TR1726	464
960555	433	960736	435	960820	435	960903	435	960968	435	971665	392	971762	392	988210	396, 399	TR1747	464
960560	433	960737	435	960821	435	960905	435	960970	435	971666	392	971764	392	988300	396	TR4001	446
960565	433	960738	435	960822	435	960906	435	960971	435	971670	392	971765	392	988310	396	TR4002	446
960570	433	960740	435	960823	435	960907	435	960972	435	971671	392	971766	392	988400	396	TR4003	446
960575	433	960741	435	960825	435	960908	435	960973	435	971672	392	971770	392	988410	396	TR4004	446
960580	433	960742	435	960826	435	960910	435	960975	435	971674	392	971771	392	988500	396	TR4005	446
960585	433	960743	435	960827	435	960911	435	960976	435	971675	392	971772	392	988600	396	TR4006	446
960610	432	960745	435	960828	435	960912	435	960977	435	971676	392	971774	392	988700	396	TR4126	446
960615	432	960746	435	960830	435	960913	435	960978	435	971680	392	971775	392	988900	397, 399	TR4147	446
960620	432	960747	435	960831	435	960915	435	960981	437	971681	392	971776	392	MX13xxxx	76, 77, 102, 103	TR4226	446
960625	432	960748	435	960832	435	960916	435	960982	437	971682	392	971777	392	MX26xxxx	82, 83, 110, 111	TR4247	446
960630	432	960750	435	960833	435	960917	435	960983	437	971684	392	971780	392	MX-T13xxxx	22, 23, 42, 43	TR4326	446
960635	432	960751	435	960835	435	960918	435	970012	388	971685	392	971781	392	MX-T26xxxx	26, 27, 44, 46	TR4347	446
960640	432	960752	435	960836	435	960920	435	970026	388, 395	971686	392	971782	392	MX130097	22	TR4426	447
960645	432	960753	435	960837	435	960921	435	970047	388	971690	392	971784	392	MX170097	42	TR4447	447
960650	432	960755	435	960838	435	960922	435	970212	388	971691	392	971785	392	MX230097	26	TR4526	446
960655	432	960756	435	960840	435	960923	435	970226	388, 395	971692	392	971786	392	MX270097	44	TR4547	446
960660	432	960757	435	960841	435	960925	435	970247	388	971694	392	971790	392	TR0126	464	TR4626	446
960665	432	960758	435	960842	435	960926	435	971600	392	971695	392	971791	392	TR0147	464	TR4647	446
960670	432	960760	435	960843	435	960927	435	971601	392	971696	392	971792	392	TR0226	464	TR4726	446
960675	432	960761	435	960845	435	960928	435	971602	392	971700	392	971794	392	TR0247	464	TR4727	447
960680	432	960762	435	960846	435	960930	435	971604	392	971701	392	971795	392	TR0326	464	TR4736	448
960685	432	960763	435	960847	435	960931	435	971605	392	971702	392	971796	392	TR0347	464	TR4747	446, 448
960700	435	960765	435	960848	435	960932	435	971606	392	971704	392	972226	393, 395	TR0526	464	TR4748	447, 448
960701	435	960766	435	960850	435	960933	435	971620	392	971705	392	972227	393	TR0547	464	TR4757	446, 448
960702	435	960767	435	960851	435	960935	435	971621	392	971706	392	972257	393	TR0626	464	TR4826	446, 448
960703	435	960768	435	960852	435	960936	435	971622	392	971720	392	972426	393	TR0647	464	TR4847	446, 448
960705	435	960770	435	960853	435	960937	435	971624	392	971721	392	972436	393	TR0726	464	TR4926	446
960706	435	960771	435	960855	435	960938	435	971625	392	971722	392	972447	393	TR0747	464	TR4947	446
960707	435	960772	435	960856	435	960940	435	971626	392	971724	392	972457	393	TR0826	464	TR5126	448
960708	435	960773	435	960857	435	960941	435	971630	392	971725	392	979003	388	TR0847	464	TR5147	448
960710	435	960775	435	960858	435	960942	435	971631	392	971726	392	979026	388	TR0926	464	TR5226	448
960711	435	960776	435	960860	435	960943	435	971632	392	971730	392	979047	388	TR0947	464	TR5247	448
960712	435	960777	435	960861	435	960945	435	971634	392	971731	392	979100	414	TR1026	464	TR5326	448
960713	435	960778	435	960862	435	960946	435	971635	392	971732	392	979200	388, 415	TR1047	464	TR5347	448
960715	435	960780	437	960862	435	960947	435	971636	392	971734	392	979210	415, 429	TR1126	464	TR5426	448
960716	435	960800	435	960865	435	960948	435	971640	392	971735	392	979300	388, 415	TR1147	464	TR5526	448
960717	435	960801	435	960866	435	960950	435	971641	392	971736	392	979310	415	TR1226	465	TR5547	448
960718	435	960802	435	960867	435	960951	435	971642	392	971740	392	979400	388, 415	TR1247	465, 467	TR5926	448
960720	435	960803	435	960868	435	960952	435	971644	392	971741	392	979410	415	TR1301	465	TR5947	448
960721	435	960805	435	960870	435	960953	435	971645	392	971742	392	980207	396, 399	TR1302	465		
960722	435	960806	435	960871	435	960955	435	971646	392	971744	392	980212	396, 399	TR1303	465		
960723	435	960807	435	960872	435	960956	435	971650	392	971745	392	981012	396	TR1304	465		
960725	435	960808	435	960873	435	960957	435	971651	392	971746	392	981047	396, 399	TR1305	465		
960726	435	960810	435	960875	435	960958	435	971652	392	971750	392	981170	397	TR1306	465		
960727	435	960811	435	960876	435	960960	435	971654	392	971751	392	981172	397	TR1426	465		
960728	435	960812	435	960877	435	960961	435	971655	392	971752	392	981173	397	TR1447	465		
960730	435	960813	435	960878	435	960962	435	971656	392	971754	392	981174	397	TR1526	465		
960731	435	960815	435	960880	437	960963	435	971660	392	971755	392	981175	397	TR1547	465		
960732	435	960816	435	960900	435	960965	435	971661	392	971756	392	981179	397, 399	TR1626	465		

Notes

A series of horizontal dotted lines for writing notes.

Notes

A series of horizontal dotted lines for writing notes.

Notes

A series of horizontal dotted lines for writing notes.

Notes

A series of horizontal dotted lines for writing notes.



All rights reserved
The information in this catalogue is provided without liability.
TAL reserves the right to change materials, prices, characteristics and dimensions without prior notice. Read all instructions carefully. TAL general conditions of sale apply.
TAL shall not be held liable for any discrepancies between the illustrations or descriptions given and the actual product neither for any misprints and/ or typing errors.
We took the liberty of editing some original images to give you an impression of how our luminaires improve living, office, outdoor, and other spaces.
Nothing in this catalogue may be reproduced without written permission from TAL.
This catalogue supersedes and replaces all previous catalogues.
Concept & creation: ab.be























**Our
light
makes
you
shine.**

Finishes

-  Amber Glass
-  Anodic Bronze
-  Anodic Brown
-  Anodic Gold
-  Black Ano
-  Black Oak
-  Brass
-  Brushed Alu
-  Chrome
-  Clear Glass
-  Cu₂₉
-  Frosted Grey Glass
-  Frosted White Glass
-  Gold 24k
-  Gold Ano
-  Grey Glass
-  Oak
-  Silver Ano
-  Silver Anthracite
-  Stainless Steel
-  Textured Black
-  Textured Grey
-  Textured White



Properties

APPLICATION	
	Interior use
	Exterior use
	Normally flammable surface
IP XX	IP rating
	Obligatory accessory
	Optional accessory
	Conformance EU
	Rotation
	Tilt
	Gimble
	Cut out round
	Cut out round
	Efficiency > 100 lm/W
	90 lm/W < efficiency < 100 lm/W
	80 lm/W < efficiency < 90 lm/W
	70 lm/W < efficiency < 80 lm/W
	Weight
	Class 1
	Class 2
	Class 3
	Electronical gear
	Mains voltage
	Electronical gear required
C	Dimmable with trailing edge dimmer
L,C	Dimmable with universal dimmer
L	Dimmable with leading edge dimmer
R	Dimmable with standard dimmer
PWM	Pulse width modulation



How to use

Lamp type - power - supply Product name

Mini Tommy 1 Haloled

Lamp type - power - supply: **LUXEON M - 7,84W - 700mA DC - (11,2 Vf)**

Light output: **755 lumen 2700K CRI90**
810 lumen 3000K CRI90

Dim protocol: **dimmiability: PWM/CCR**

Beam angle: **beam 36°**

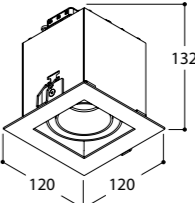
Product dimensions: 



GU10 availability: **GU 10** versions: see website

Cut out dimensions + Installation depth: **110 x 110 mm**
Installation depth **135 mm**

Adjustability: **30°**

Color temperature (for LED only): **2700K** **3000K**

Beam angle: **35°** **70°** **35°** **70°**

Finish of the product:  **123456** **123456** **123456** **123456**
 **123456** **123456** **123456** **123456**

Reference number







Obligatory accessories to be ordered separately: **Installation frame for plaster** **123456** **200 x 235 mm**

Cut out dimensions

Optional accessories to be ordered separately: **+**

Family members: 

Same product to be found in different product categories

European conformity:       

Energy class



Product weight

Indoor/outdoor use

Flammability index

Gear type IP rate Electrical class

4000K product on demand Recommended drivers

 **4000K ON DEMAND**  **Converter matrix, see back flap**

TAL

OUR LIGHT
MAKES
YOU SHINE

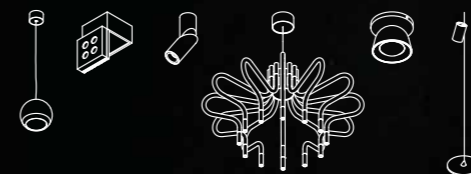

TAL

TAL Belgium

Moortelmeers 23 • 8740 Pittem
tel +32 (0)51 46 43 41 • fax +32 (0)51 46 43 42
info@tal.be • www.tal.be

TAL dealers, see website