

**&tradition**  
**The Collection 2018**

**Classics and new icons**



**&tradition<sup>®</sup>**



**We strive for timeless designs  
born out of tradition and revolution.  
We honour old masters,  
who were avant-garde in their time  
and welcome new designers creating  
icons of tomorrow.**



( ABOVE )

Mezcla JH19 by Jaime Hayon, 2018

## Product overview

*Click on product for details*

### Furniture

Catch JH1  
 Catch JH2  
 Catch JH13  
 Catch JH14  
 Catch JH15  
 Catch JH16  
 Catch JH17

Cloud LN1  
 Cloud LN2  
 Cloud LN3.2  
 Cloud LN4  
 Cloud LN5  
 Cloud LN6  
 Cloud LN7

Develius EV1–EV7

Fly SC1  
 Fly SC2  
 Fly SC3  
 Fly SC4  
 Fly SC5  
 Fly SC9  
 Fly SC10  
 Fly SC11  
 Fly SC12

Hoof SW1  
 Hoof SW2

Isole NN1

In Between SK1  
 In Between SK2  
 In Between SK3  
 In Between SK4  
 In Between SK5  
 In Between SK6  
 In Between SK7  
 In Between SK8  
 In Between SK9  
 In Between SK10

Lato LN8  
 Lato LN9

Little Petra VB1

Loafer SC23

Mayor AJ5  
 Mayor AJ6

Mezcla JH19  
 Mezcla JH20  
 Mezcla JH21  
 Mezcla JH22

Norm NA3  
 Norm NA8

Nærvær NA9  
 Nærvær NA10  
 Nærvær NA11

Palette JH6  
 Palette JH7  
 Palette JH8  
 Palette JH9

Palette JH25  
 Palette JH26

Pavilion AV1  
 Pavilion AV2  
 Pavilion AV3  
 Pavilion AV4  
 Pavilion AV5  
 Pavilion AV6  
 Pavilion AV7  
 Pavilion AV9

Shuffle MH1

### Accessories

Amore SC17–AC19  
 Amore SC20–SC22

The Moor AP5  
 The Moor AP6  
 The Moor AP7  
 The Moor AP8

True Colours LP1–LP7

Tricolore SH1–SH3

### Lighting

Bellevue AJ7  
 Bellevue AJ8  
 Bellevue AJ9  
 Bellevue AJ10  
 Bellevue AJ11

Blown SW3  
 Blown SW4  
 Blown SW5

Bulb SR1

Mega Bulb SR2

Copenhagen SC6

Copenhagen SC7

Copenhagen SC8

Copenhagen SC13

Copenhagen SC14

Copenhagen SC15

Copenhagen SC16

Flowerpot VP1

Flowerpot VP2

Flowerpot VP3

Flowerpot VP4

Formakami JH3

Formakami JH4

Formakami JH5

Formakami JH18

Fornell ABF1

Ice SR3

Ice SR4

Journey SHY1

Journey SHY2

Marble Light SV2

Marble Light SV3

Marble Light SV4

Marble Light SV5

Marble Light SV6

Marble Light SV7

Mass Light NA5

Mass Light NA6

Milk NA1

Passepartout JH10

Passepartout JH11

Passepartout JH12

Spinning BH1

Spinning BH2

Topan VP6

Utzon JU1

Working Title HK1

( RIGHT )

Loafer SC23 by Space Copenhagen, 2018  
Copenhagen SC13 by Space Copenhagen, 2018

( LEFT )

Little Petra VB1 by Viggo Boesen, 1938  
Bellevue AJ7 by Arne Jacobsen, 1929  
Palette JH25 by Jaime Hayon, 2018





We all collect the things we love, objects, designs, furniture and accessories that echo different facets of our personality. But collecting goes beyond the tangible. It encompasses intangibles, like new experiences. An appreciation of art, fashion and music. It's about being open to meeting new people and seeing things from a different perspective. Reflecting on the past and creating new memories now to cherish in the future. That is why we wanted to shoot our novelties and exist-

ing collection in stunning surroundings in the Belgian port city, Antwerp. A city blessed with cool street art, diverse architecture and not least a city that can't be untangled from art and design. Being the home town for creative masters like Peter Paul Rubens and Dries Van Noten, it's a city with a strong sense of its past but keeping an eye on the future. Inspired by the vibrant surroundings in Antwerp, we've captured our classics from the past and our future icons.

## Antwerp

( LEFT )

Pavilion AV4 by Anderssen & Voll, 2018  
In Between SK4 by Sami Kallio, 2014

( RIGHT )

Tricolore SH1-SH3 by Sebastian Herkner, 2017  
In Between SK4 by Sami Kallio, 2014





( LEFT )

In Between SK4 by Sami Kallio, 2014

( RIGHT )

Pavilion AV4 by Anderssen & Voll, 2018

In Between SK4 by Sami Kallio, 2014

Catch JH13 by Jaime Hayon, 2017





( LEFT )

Blown SW5 by Samuel Wilkinson, 2018  
Loafer SC23 by Space Copenhagen, 2018

( RIGHT )

Formakami JH18 by Jaime Hayon, 2018  
Fly SC4 by Space Copenhagen, 2013  
Little Petra VB1 by Viggo Boesen, 1938





( LEFT )

Amore SC20 by Space Copenhagen, 2018  
In Between SK1 by Sami Kallio, 2013

( RIGHT )

Pavilion AV4 by Anderssen & Voll, 2018  
Mezcla JH22 by Jaime Hayon, 2018  
Copenhagen SC13 by Space Copenhagen, 2018

Pavilion AV1 by Anderssen & Voll, 2018





( LEFT )

Little Petra VB1 by Viggo Boesen, 1938  
Mezcla JH19 by Jaime Hayon, 2018

Bellevue AJ7 by Arne Jacobsen, 1929  
Little Petra VB1 by Viggo Boesen, 1938  
Mezcla JH19 by Jaime Hayon, 2018

( RIGHT )

Journey SHY1 by Signe Hytte, 2018

Loafer SC23 by Space Copenhagen, 2018  
Copenhagen SC13 by Space Copenhagen, 2018





( LEFT )

Flowerpot VP3 by Verner Panton, 1969

( RIGHT )

Utzon JU1 By Jørn Utzon, 1947



( LEFT )

Develius EV1A & EV1G by Edward Van Vliet, 2018  
Mezcla JH20 by Jaime Hayon, 2018

( RIGHT )

Journey SHY1 by Signe Hytte, 2018  
The Moor AP7 by All the Way to Paris, 2016

Develius EV1C & EV1D by Edward Van Vliet, 2018  
Little Petra VB1 by Viggo Boesen, 1938  
The Moor AP8 by All the Way to Paris, 2016  
Palette JH25 & JH26 by Jaime Hayon, 2018



( LEFT )

Palette JH26 by Jaime Hayon, 2018  
Journey SHY2 by Signe Hytte, 2018

Working Title HK1 by Harri Koskinen, 2017

( RIGHT )

Pavilion AV6 by Anderssen & Voll, 2018  
Ice SR3 by Sofie Refer, 2018  
The Moor AP6 by All the Way to Paris, 2016  
Lato LN9 by Luca Nichetto, 2018



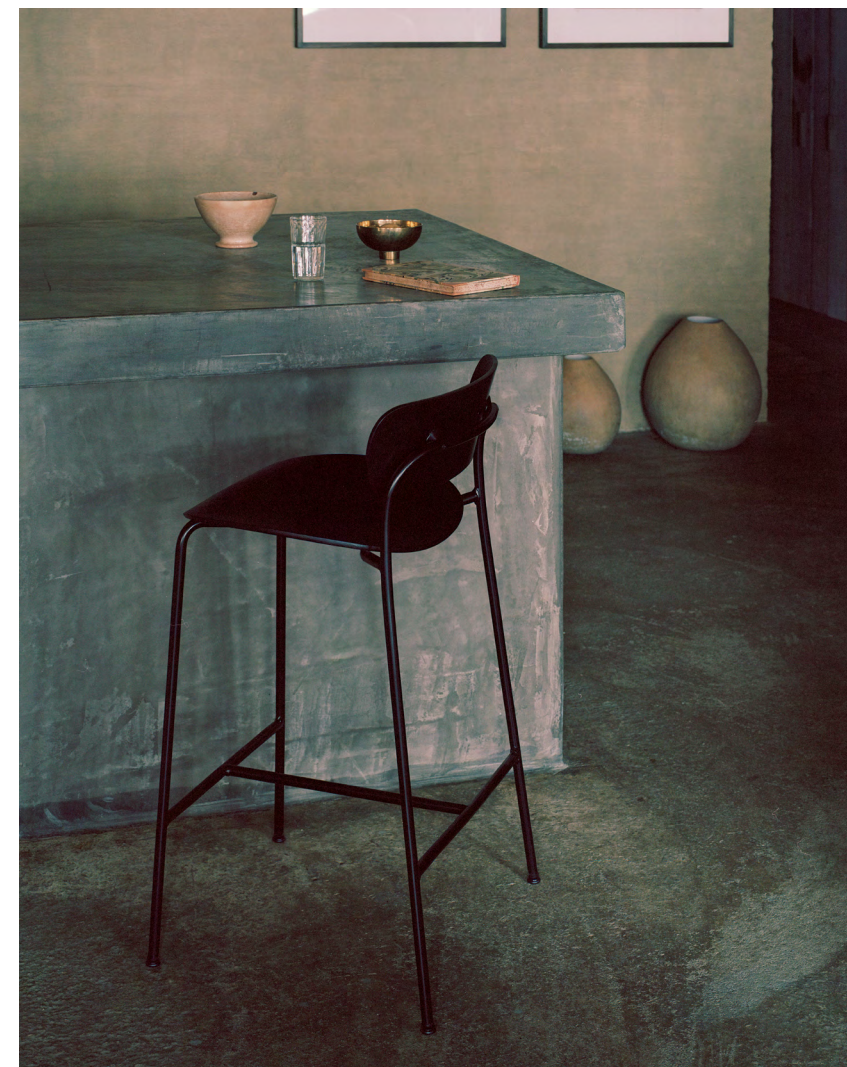

( LEFT )

Pavilion AV4 by Anderssen & Voll, 2018  
In Between SK5 by Sami Kallio, 2015  
Flowerpot VP2 by Verner Panton, 1968

( RIGHT )

Pavilion AV7 by Anderssen & Voll, 2018  
Pavilion AV7 by Anderssen & Voll, 2018  
Mezcla JH22 by Jaime Hayon, 2018





( LEFT )

Working Title HK1 by Harri Koskinen, 2017  
Pavilion AV6 by Anderssen & Voll, 2018

( RIGHT )

Copenhagen SC13 by Space Copenhagen 2018  
In Between SK1 by Sami Kallio, 2013  
In Between SK4 by Sami Kallio, 2014





## Cloud LN1

BY LUCA NICHETTO  
2015

**Category** LOUNGE CHAIR

**Materials** Structure in wood and metal with no-zag springs. HR foam, polyester fibers and feather pillows. Solid steel legs. Fabric or leather upholstery.

**Dimensions (cm/in)** H: 75cm/29.5in, D: 84cm/33in, L: 100cm/39.3in. Seat height: 40cm/15.7in.

**6-8 wks. lead-time** All fabrics, leathers and COM available with chromed, bronzed or warm black powder coated legs.

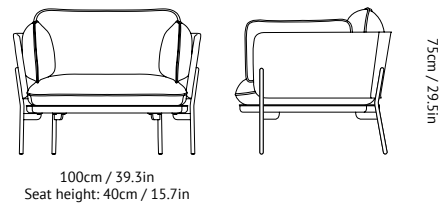

## Cloud LN4

BY LUCA NICHETTO  
2015

**Category** POUF

**Materials** Base in wood and pillow in HR foam, polyester fibers and feather. Solid steel legs. Fabric or leather upholstery.

**Dimensions (cm/in)** H: 40cm/15.7in, D: 72cm/28.3in, L: 78cm/30.7in. Seat height: 40cm/15.7in.

**6-8 wks. lead-time** All fabrics, leathers and COM available with chromed, bronzed or warm black powder coated legs.

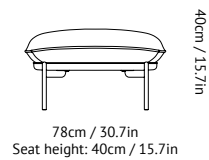

## Cloud LN2

BY LUCA NICHETTO  
2015

**Category** SOFA

**Materials** Structure in wood and metal with no-zag springs. HR foam, polyester fibers and feather pillows. Solid steel legs. Fabric or leather upholstery.

**Dimensions (cm/in)** H: 75cm/29.5in, D: 84cm/33in, L: 168cm/66in. Seat height: 40cm/15.7in.

**6-8 wks. lead-time** All fabrics, leathers and COM available with chromed, bronzed or warm black powder coated legs.

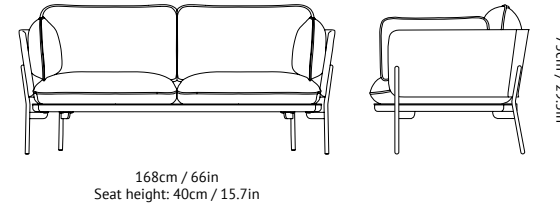

## Cloud LN3.2

BY LUCA NICHETTO  
2015

**Category** SOFA

**Materials** Structure in wood and metal with no-zag springs. HR foam, polyester fibers and feather pillows. Solid steel legs. Fabric or leather upholstery.

**Dimensions (cm/in)** H: 75cm/29.5in, D: 84cm/33in, L: 220cm/86.5in. Seat height: 40cm/15.7in.

**6-8 wks. lead-time** All fabrics, leathers and COM available with chromed, bronzed or warm black powder coated legs.

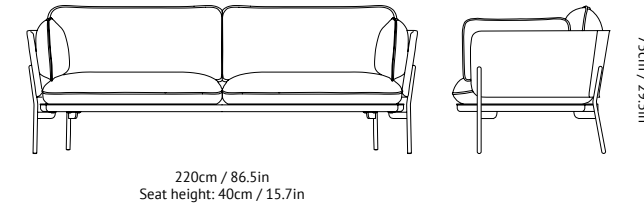

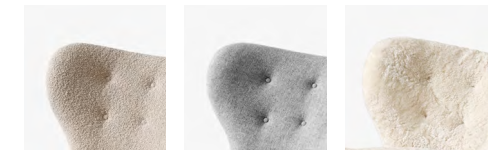

## Cloud LN5

BY LUCA NICHETTO  
2018

**Category** HIGH BACK LOUNGE CHAIR

**Materials** Structure in wood and metal with no-zag springs. HR foam, polyester fibers and feather pillows. Fabric or leather upholstery.

**Dimensions (cm/in)** H: 120cm/47.3in, D: 90cm/35.5in, L: 120cm/47.2in. Seat Height: 40cm/15.7in

**6-8 wks. lead-time** All fabrics, leathers and COM available with chromed, bronzed or warm black powder coated legs.

## Cloud LN6

BY LUCA NICHETTO  
2017

**Category** HIGH BACK SOFA

**Materials** Structure in wood and metal with no-zag springs. HR foam, polyester fibers and feather pillows. Fabric or leather upholstery.

**Dimensions (cm/in)** H: 115 cm/45.3in, D: 90cm/35.4in, L: 180cm/70.9in. Seat height: 40cm/15.7in.

**6-8 wks. lead-time** All fabrics, leathers and COM available with chromed, bronzed or warm black powder coated legs.

## Cloud LN7

BY LUCA NICHETTO  
2017

**Category** HIGH BACK SOFA

**Materials** Structure in wood and metal with no-zag springs. HR foam, polyester fibers and feather pillows. Fabric or leather upholstery.

**Dimensions (cm/in)** H: 115cm/45.3in, D: 90cm/35.4in, L: 232cm/91.3in. Seat height: 40cm/15.7in.

**6-8 wks. lead-time** All fabrics, leathers and COM available with chromed, bronzed or warm black powder coated legs.

## Little Petra VB1

BY VIGGO BOESEN  
1938

**Category** LOUNGE CHAIR

**Materials** Wood, CMHR foam, polyester wadding, fabric upholstery.

**Dimensions (cm/in)** H: 75cm/29.5in, D: 83cm/32.7in, L: 81cm/31.9in, Seat height: 40cm/15.7in, Seating depth: 55cm/21.6in.

**6-8 wks. lead-time** All fabrics available with white oiled oak or oiled walnut legs.

**4 wks. lead-time** Karakorum 003, Hallingdal 130 and Sheepskin Moonlight 17mm with white oiled oak or oiled walnut legs.

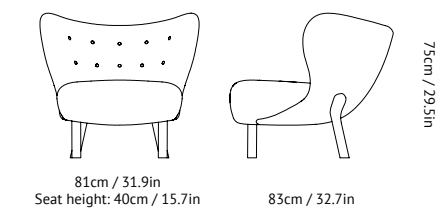
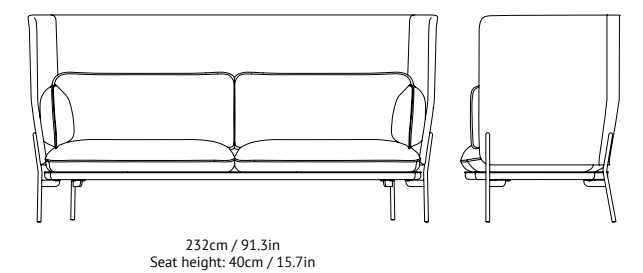
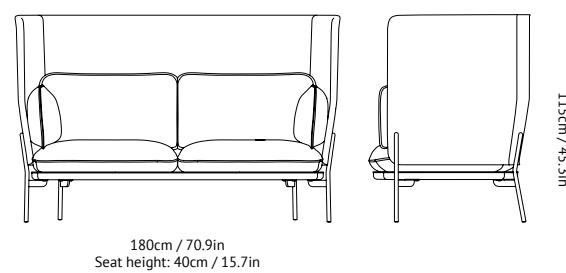
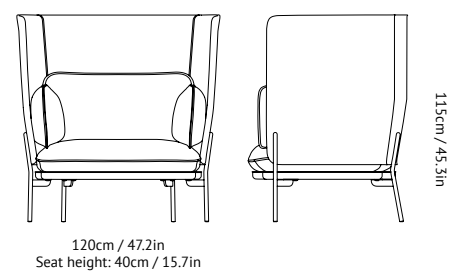





## Fly SC10

BY SPACE COPENHAGEN  
2017

<b>Category</b>	LOUNGE CHAIR
<b>Materials</b>	Oak frame and base. CMHR foam and feather pillows. Fabric upholstery.
<b>Dimensions (cm/in)</b>	H: 68.5cm/26.9in, D: 70cm/27.6in, L: 73cm/28.7in. Seating height: 40cm/15.7in.
<b>Stock items</b>	White oiled oak/Chivasso Hot Madison (CH1249/094), Smoked oiled oak/Chivasso Hot Madison (CH1249/093), Smoked oiled oak/Harald 182.
<b>6 wks. lead-time</b>	All other fabrics and COM available with white oiled or smoked oiled oak base and frame.

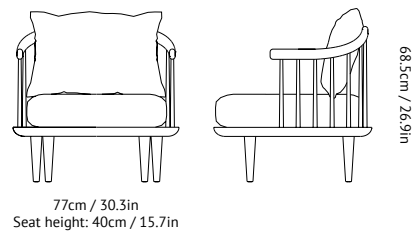

## Fly SC1

BY SPACE COPENHAGEN  
2013

<b>Category</b>	LOUNGE CHAIR
<b>Materials</b>	Oak frame and base. CMHR foam and feather pillows. Fabric upholstery.
<b>Dimensions (cm/in)</b>	H: 68.5cm/26.9in, D: 80cm/31.5in, L: 87cm/34.3in, Seat height: 40cm/15.7in.
<b>Stock items</b>	White oiled oak/Chivasso Hot Madison (CH1249/094), Smoked oiled oak/Chivasso Hot Madison (CH1249/093), Smoked oiled oak/Harald 182.
<b>6 wks. lead-time</b>	All other fabrics and COM available with white oiled or smoked oiled oak base and frame.

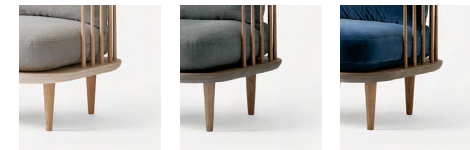
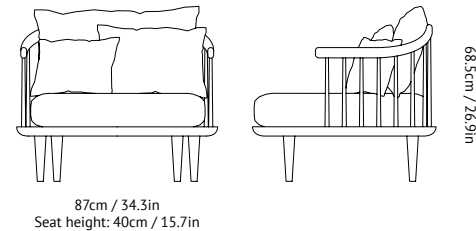

## Fly SC2

BY SPACE COPENHAGEN  
2013

<b>Category</b>	SOFA
<b>Materials</b>	Oak frame and base. CMHR foam and feather pillows. Fabric upholstery.
<b>Dimensions (cm/in)</b>	H: 68.5cm/26.9in, D: 80cm/31.5in, L: 162cm/63.8in. Seat height: 40cm/15.7in.
<b>Stock items</b>	White oiled oak/Chivasso Hot Madison (CH1249/094), Smoked oiled oak/Chivasso Hot Madison (CH1249/093), Smoked oiled oak/Harald 182.
<b>6 wks. lead-time</b>	All other fabrics and COM available with white oiled or smoked oiled oak base and frame.

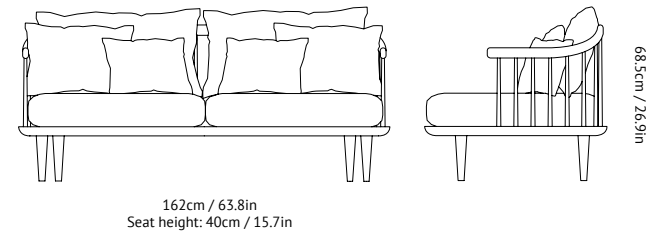

## Fly SC3

BY SPACE COPENHAGEN  
2013

<b>Category</b>	SOFA
<b>Materials</b>	Oak frame and base. CMHR foam and feather pillows. Fabric upholstery.
<b>Dimensions (cm/in)</b>	H: 68.5cm/26.9in, D: 80cm/31.5in, L: 240cm/94.5in. Seat height: 40cm/15.7in.
<b>Stock items</b>	White oiled oak/Chivasso Hot Madison (CH1249/094), Smoked oiled oak/Chivasso Hot Madison (CH1249/093), Smoked oiled oak/Harald 182.
<b>6 wks. lead-time</b>	All other fabrics and COM available with white oiled or smoked oiled oak base and frame.

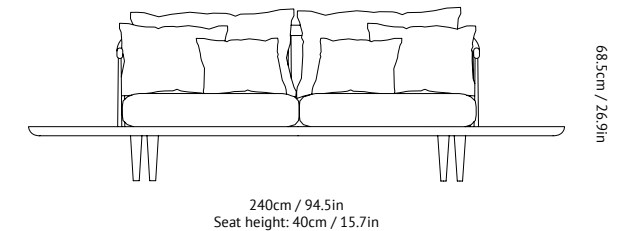



## Fly SC12

BY SPACE COPENHAGEN  
2017

<b>Category</b>	SOFA
<b>Materials</b>	Oiled oak frame and base. CMHR foam and feather pillows. Fabric upholstery.
<b>Dimensions (cm/in)</b>	H: 70cm/27.6in, D: 80cm/31.5in, L: 240cm/94.4in. Seating height: 40cm/15.7in.
<b>Stock items</b>	White oiled oak/Chivasso Hot Madison (CH1249/094), Smoked oiled oak/Chivasso Hot Madison (CH1249/093), Smoked oiled oak/Harald 182.
<b>6 wks. lead-time</b>	All other fabrics and COM available with white oiled or smoked oiled oak base and frame.

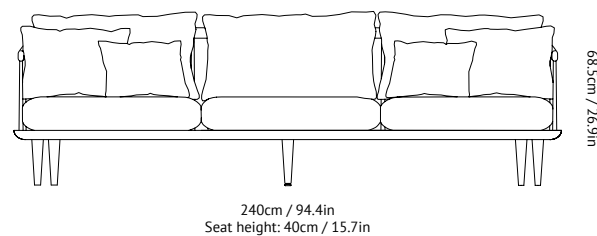

## Fly SC9

BY SPACE COPENHAGEN  
2014

<b>Category</b>	POUF
<b>Materials</b>	Oak base. CMHR foam and feather pillow. Fabric upholstery.
<b>Dimensions (cm/in)</b>	H: 40cm/15.7in, D: 80cm/31.5in, L: 80cm/31.5in. Seat height: 40cm/15.7in.
<b>Stock items</b>	White oiled oak/Chivasso Hot Madison (CH1249/094), Smoked oiled oak/Chivasso Hot Madison (CH1249/093), Smoked oiled oak/Harald 182.
<b>6 wks. lead time</b>	All other fabrics and COM available with white oiled or smoked oiled oak base and frame.

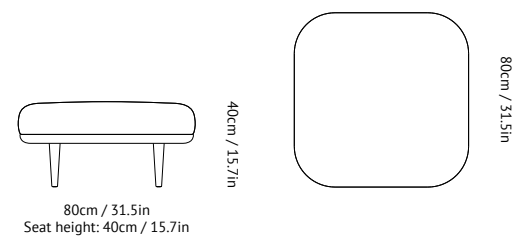

## Fly SC4 & SC11

BY SPACE COPENHAGEN  
2013

<b>Category</b>	LOUNGE TABLE
<b>Materials</b>	Oak base with marble table top.
<b>Dimensions (cm/in)</b>	SC4: H: 26cm/10.2in, D: 80cm/31.5in, L: 80cm/31.5in. SC11: H: 32cm/12.6in, D: 120cm/47.2in, L: 120cm/47.2in.
<b>Colours</b>	White oiled oak & honed Bianco Carrara marble, White oiled oak & honed Pietra di Fossena, Smoked oiled oak & honed Pietra di Fossena, Smoked oiled oak & honed Nero Marquina marble.

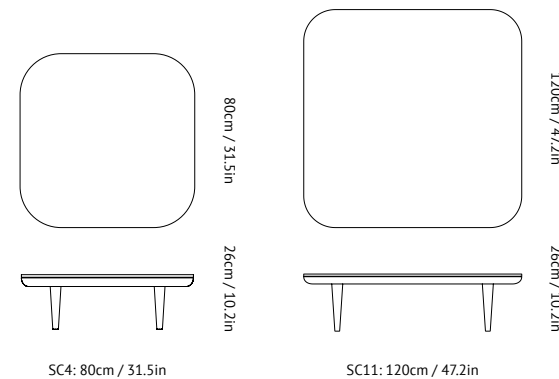

## Fly SC5

BY SPACE COPENHAGEN  
2013

<b>Category</b>	LOUNGE TABLE
<b>Materials</b>	Oak base with marble table top.
<b>Dimensions (cm/in)</b>	H: 26cm/10.2in, D: 60cm/23.6in, L: 120cm/47.2in.
<b>Stock items</b>	White oiled oak & honed Bianco Carrara marble, White oiled oak & honed Pietra di Fossena, Smoked oiled oak & honed Pietra di Fossena, Smoked oiled oak & honed Nero Marquina marble.

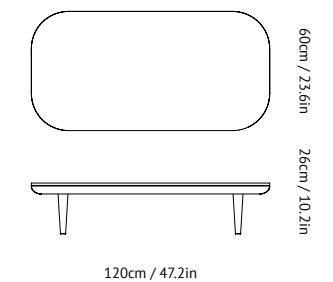



## Develius EV1-EV7

BY EDWARD VAN VLIET  
2018

**Category** MODULAR SOFA

**Materials** Wooden frame, no-zag springs, HR foam and polyester wadding. Metal brackets for connecting modules.

**6-8 wks. lead-time** Available in fabric and COM.

**Pillows (cm/in)** Optional on EV1 and EV2 modular sofa.

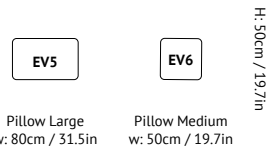

### EV1 Modules (cm/in) Seating Depth: 89cm/35in.

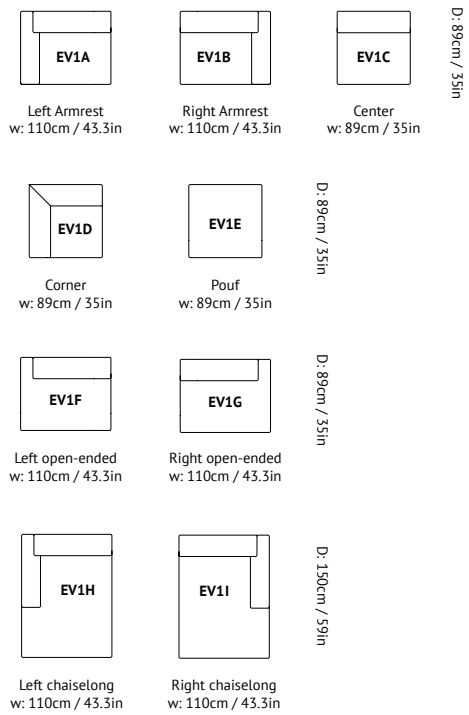

### EV2 Modules (cm/in) Seating Depth: 110cm/43.3in.

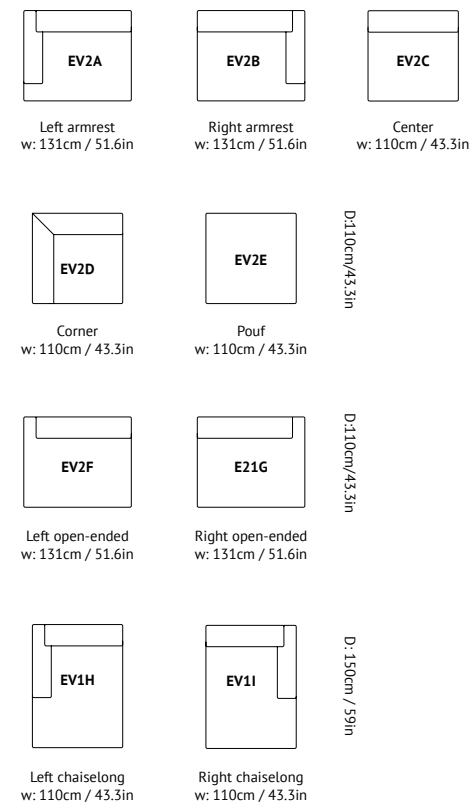

### Configurations examples

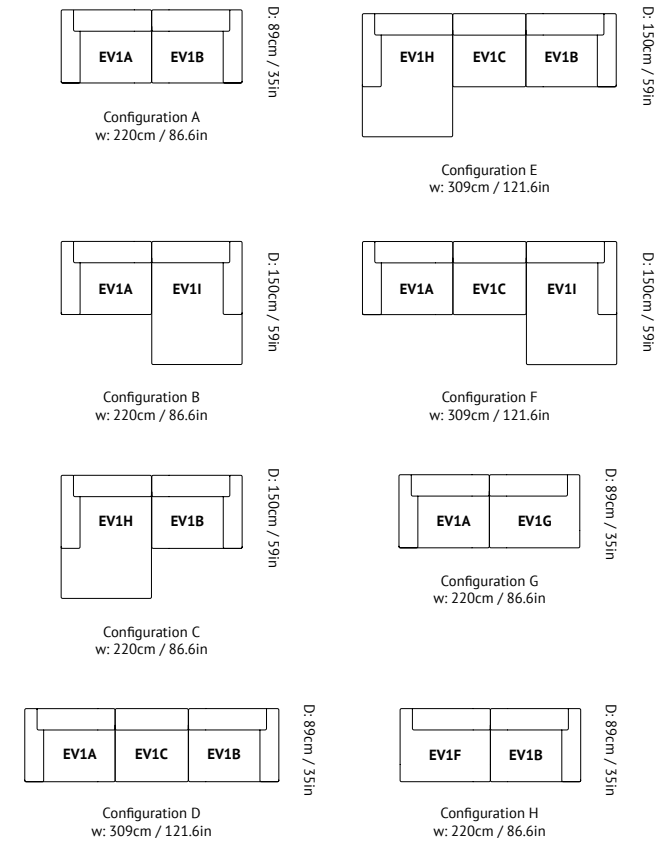



# Isole NN1

BY NENDO & LUCA NICHETTO  
2017

**Category** MODULAR SOFA

**Materials** Powder coated steel base, moulded CMHR foam seat, backrest and armrest. Black MDF table tops with nano laminate surface.

**Dimensions (cm/in)**

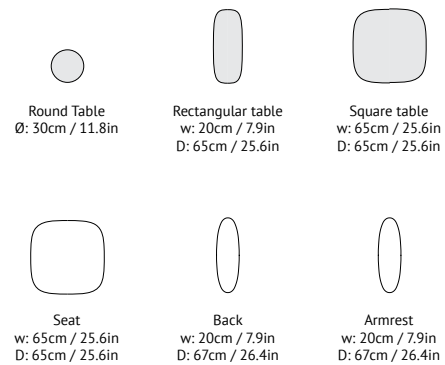

**Standard table top** Black  
**Standard upholstery** Uniform, Uniform Melange from Febrik.  
**8 wks. lead-time** All fabrics available with black powder coated steel base.

## Configurations examples

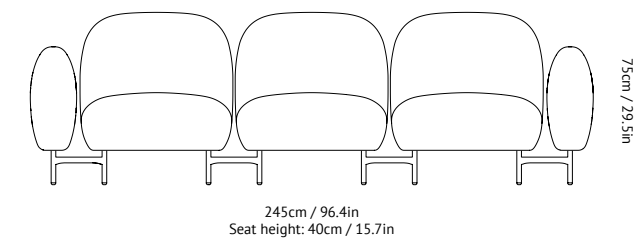
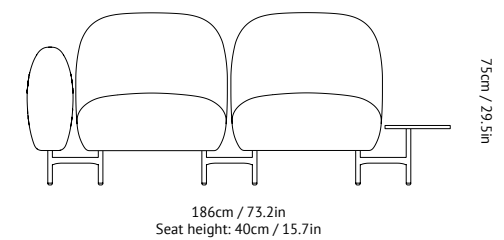
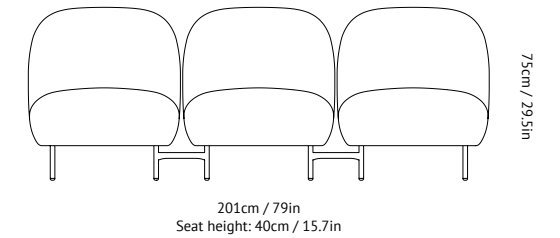
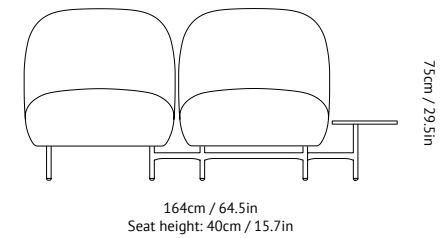
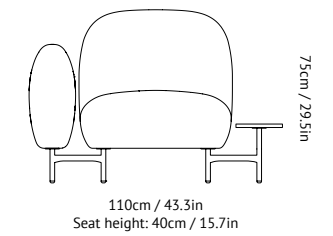
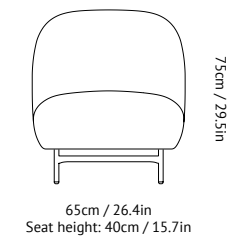
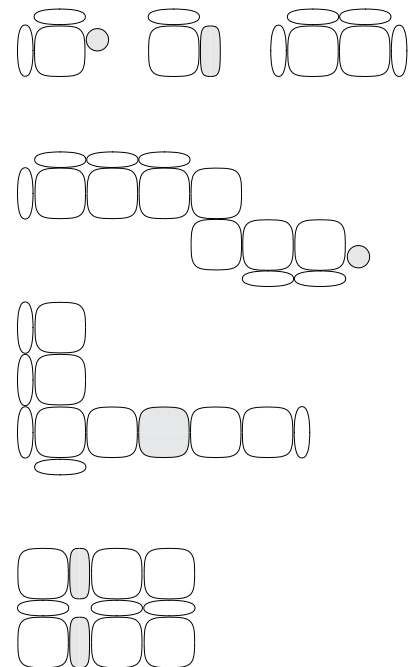



## Mayor AJ5

BY ARNE JACOBSEN & FLEMMING LASSEN  
1939

**Category** SOFA

**Materials** Solid oak or walnut base, solid beech frame, CMHR foam, fabric or leather upholstery.

**Dimensions (cm/in)** H: 82cm/32.3in, D: 62cm/24.4in, L: 200cm/78.7in, Seat height: 43cm/16.9in.

**Stock item** White oiled oak with Hallingdal 130.

**6 wks. lead-time** All fabrics, leathers and COM available with white oiled, smoked oiled or black lacquered solid oak or walnut base.

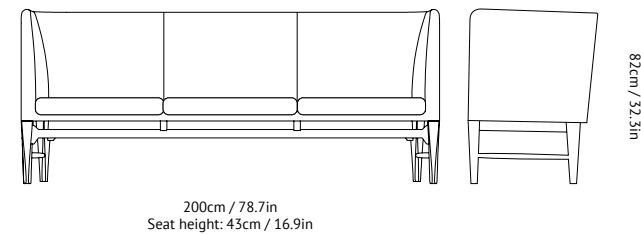

## Mayor AJ6

BY ARNE JACOBSEN & FLEMMING LASSEN  
1939

**Category** SOFA

**Materials** Solid oak or walnut base, solid beech frame, CMHR foam, fabric or leather upholstery.

**Dimensions (cm/in)** H: 82cm/32.3in, D: 62cm/24.4in, L: 137.5cm/54.1 in, Seat height: 43cm/16.9in.

**6 wks. lead-time** All fabrics, leathers and COM available with white oiled, smoked oiled or black lacquered solid oak or walnut base.

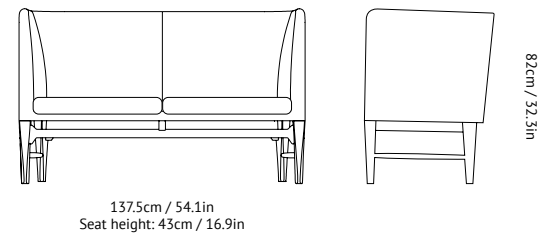

## Loafer SC23

BY SPACE COPENHAGEN  
2018

**Category** LOUNGE CHAIR

**Materials** Wood, HR foam, polyester wadding, fabric upholstery.

**Dimensions (cm/in)** H: 75cm/29.5in, D: 65cm/25.6in, L: 70cm/27.5in, Seat height: 42cm/16.5in.

**6-8 wks. lead-time** Available in fabric and COM.

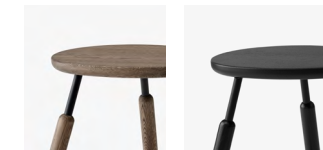
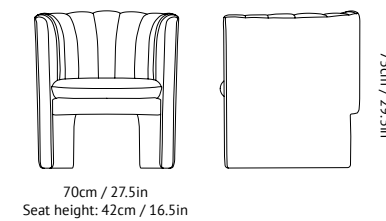

## Norm NA3 & NA8

BY NORM ARCHITECTS  
2011

**Category** STOOL & BAR STOOL

**Materials** Powdercoated steel and solid oak.

**Dimensions (cm/in)** NA3: H: 46cm/18.1in, D: 40.5cm/16in, W: 49cm/19.3in. NA8: H: 75cm/29.6in, D: 42cm/16.6in, W: 52cm/20.5in.

**Colours** Smoked oiled oak or Black lacquered oak with black powder coated steel (RAL 9005).

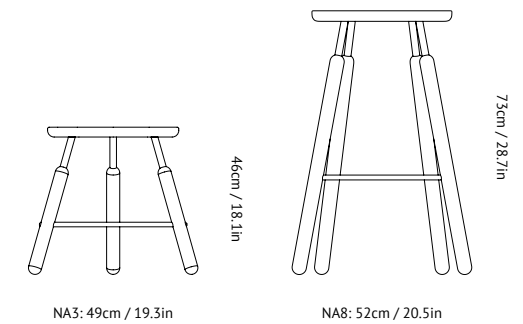

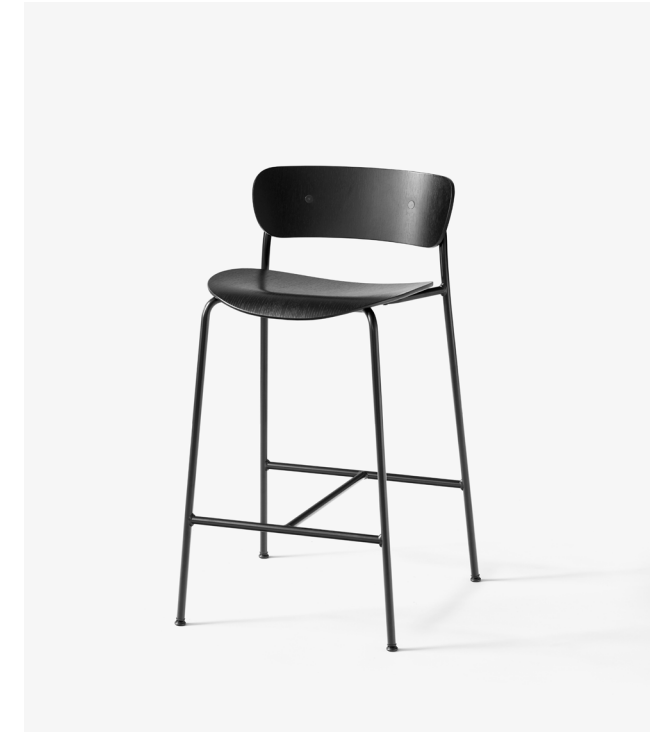
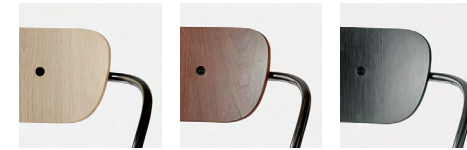

## Pavilion AV1 & AV3

BY ANDERSSSEN & VOLL  
2018

**Category** CHAIR

**Materials** AV1: Steel tubes and formpressed veneer.  
AV3: Steel tubes and formpressed veneer with upholstered seat.  
Brass fittings for the front side of the back rest available upon request.

**Dimensions (cm/in)** H: 76cm/29.9in, D: 50cm/19.7in, W: 52,5cm/20.7in, Seat height: 46cm/18.1in.

**AV1 in stock** Black base and frame with lacquered oak, black lacquered oak, lacquered walnut.

**AV3 colours** All fabrics, leathers and COM available for seat upholstery with black metal base and either lacquered oak, black lacquered oak or lacquered walnut back.

**6-8 wks. lead-time**

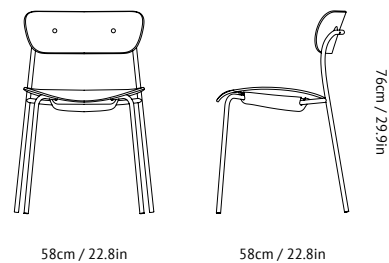

58cm / 22.8in

58cm / 22.8in

76cm / 29.9in

## Pavilion AV2 & AV4

BY ANDERSSSEN & VOLL  
2018

**Category** CHAIR WITH ARMRESTS

**Materials** AV2: Steel tubes and formpressed veneer.  
AV4: Steel tubes and formpressed veneer with upholstered seat.  
Brass fittings for the front side of the back rest available upon request.

**Dimensions (cm/in)** H: 76cm/29.9in, D: 52cm/20.5in, W: 56cm/22.1in, Seat H: 46cm/18.1in, Armrest H: 76cm/29.9in.

**AV2 in stock** Black base and frame with lacquered oak, black lacquered oak, lacquered walnut.

**AV4 colours** All fabrics, leathers and COM available for seat upholstery with black metal base and either lacquered oak, black lacquered oak or lacquered walnut back.

**6-8 wks. lead-time**

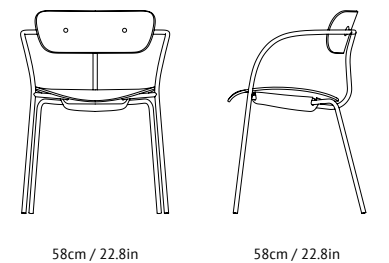

58cm / 22.8in

58cm / 22.8in

76cm / 29.9in

## Pavilion AV5 & AV6

BY ANDERSSSEN & VOLL  
2018

**Category** LOUNGE CHAIR

**Materials** Steel tubes and formpressed veneer.  
Brass fittings for the front side of the back rest available upon request.

**Dimensions (cm/in)** H: 70cm/27.6in, D: 65cm/25.6in, W: 69cm/27.2in, Seat H: 38cm/15in, Armrest H: 59cm/23.2in.

**AV5 in stock** Black base and frame with lacquered oak, black lacquered oak, lacquered walnut.

**AV6 colours** All fabrics, leathers and COM available for seat upholstery with black metal base and either lacquered oak, black lacquered oak or lacquered walnut back.

**6-8 wks. lead-time**

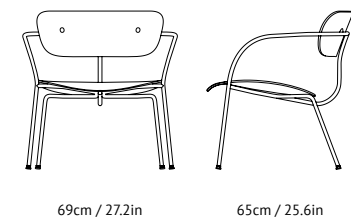

69cm / 27.2in

65cm / 25.6in

70cm / 27.6in

## Pavilion AV7 & AV9

BY ANDERSSSEN & VOLL  
2018

**Category** COUNTER STOOL OR BAR STOOL

**Materials** Steel tubes and formpressed veneer.  
Brass fittings for the front side of the back rest available upon request.

**Dimensions (cm/in)** AV7: H: 85cm/33.5in, D: 48cm/18.9in, W: 50cm/19.7in, Seat height: 65cm/25.6in.  
AV9: H: 95cm/37.4in, D: 50cm/19.7in, W: 52cm/20.5in, Seat height: 75cm/29.5in.

**Colours** Black base and frame with lacquered oak, Black base and frame with black lacquered oak, Black base and frame with lacquered walnut.

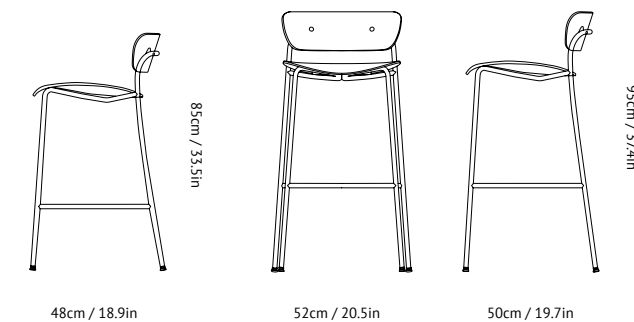

48cm / 18.9in

52cm / 20.5in

50cm / 19.7in

85cm / 33.5in

95cm / 37.4in

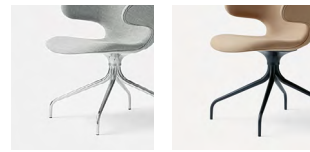

## Catch JH1

BY JAIME HAYON  
2014

**Category** CHAIR WITH ARMRESTS

**Materials** Molded PU foam, CMHR foam, oak legs, fabric or leather upholstery.

**Dimensions (cm/in)** H: 90cm/35.4in, D: 58cm/22.8in, W: 58cm/22.8in. Armrest height: 68cm/26.8in. Seat height: 45cm/17.7in.

**6-8 wks. lead-time** Available in fabrics, leathers and as COM with white oiled, smoked oiled, or black lacquered solid oak legs.

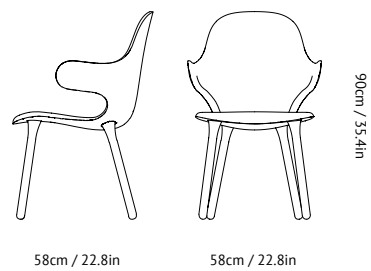

## Catch JH2

BY JAIME HAYON  
2014

**Category** CHAIR WITH ARMRESTS

**Materials** Molded PU foam, CMHR foam, aluminium swivel base, fabric or leather upholstery.

**Dimensions (cm/in)** H: 90cm/35.4in, D: 58cm/22.8in, W: 58cm/22.8in. Armrest height: 68cm/26.8in. Seat height: 45cm/17.7in.

**6-8 wks.lead-time** Available in fabrics, leathers and as COM with polished or black powder coated aluminium swivel base.

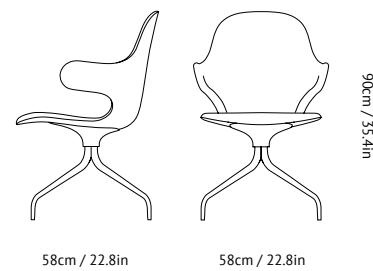

## Catch JH13

BY JAIME HAYON  
2017

**Category** LOUNGE CHAIR

**Materials** Molded PU foam, CMHR foam, steel base, fabric.

**Dimensions (cm/in)** H: 86cm/33.9in, W: 82cm/32.3in, D: 92cm/36.2in. Armrest height: 58cm/22.8in. Seat height: 36cm/14.2in.

**6-8 wks. lead-time** Available in fabrics, leathers and COM with warm black powder coated base.

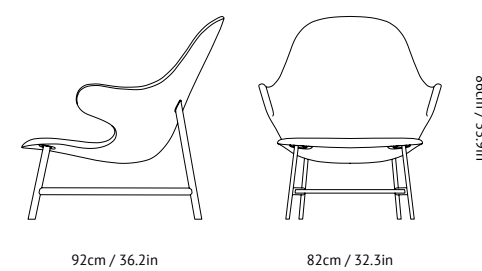

## Catch JH14

BY JAIME HAYON  
2017

**Category** LOUNGE CHAIR

**Materials** Molded PU foam, CMHR foam, steel base, fabric.

**Dimensions (cm/in)** H: 86cm/33.9in, W: 82cm/32.3in, D: 92cm/36.2in. Armrest height: 58cm/22.8in. Seat height: 36cm/14.2in.

**6-8 wks. lead-time** Available in fabrics, leathers and COM with warm black powder coated base.

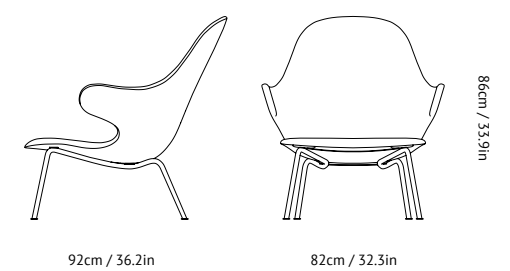



## Catch JH15

BY JAIME HAYON  
2017

**Category** CHAIR WITH ARMRESTS  
**Materials** Molded PU foam, CMHR foam, steel tube base, fabric or leather upholstery.  
**Dimensions (cm/in)** H: 90cm/35.4in, D: 58cm/22.8in, W: 58cm/22.8in. Armrest height: 68cm/26.8in. Seat height: 45cm/17.7in.  
**6-8 wks. lead-time** Available in fabrics, leathers and as COM with black powder coated tube base.

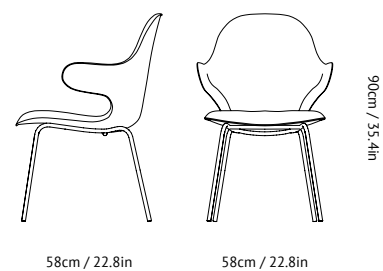

## Catch JH16 & JH17

BY JAIME HAYON  
2017

**Category** COUNTER STOOL OR BAR STOOL WITH ARMRESTS  
**Materials** Molded PU foam, CMHR foam, steel tube base, fabric or leather upholstery.  
**Dimensions (cm/in)** JH16: H: 107 cm/42.1in, D: 63cm/24.8in, W: 58cm/22.8in. Armrest height: 88 cm/34.6 in. Seating height: 66cm/26in. JH17: H: 117 cm/46in, D: 63cm/24.8in, W: 58cm/22.8in. Armrest height: 98 cm/38.6 in. Seating height: 76 cm/30in.  
**6-8 wks. lead-time** Available in fabrics, leathers and as COM with black powder coated tube base.

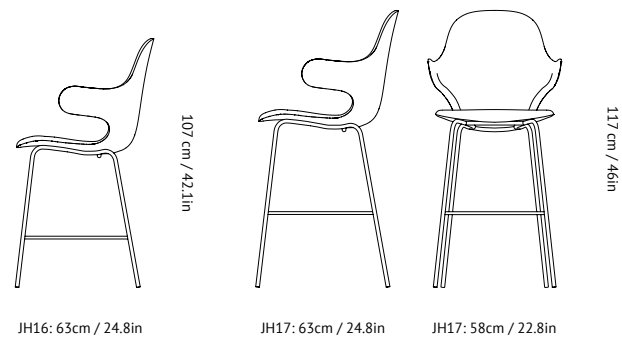

## In Between SK1 & SK2

BY SAMI KALLIO  
2013

**Category** CHAIR WITH ARMRESTS  
**Materials** Solid oak and formpressed oak veneer.  
**Dimensions (cm/in)** H: 77cm/30.3in, W: 58cm/22.8in, D: 54cm/21.2in. Armrest height: 70cm/27.6in. Seat height: 45cm/17.7in.  
**SK1 in stock** White oiled oak, Smoked oiled oak, Black lacquered oak.  
**SK2 in stock** White oiled oak with Fiord 251, White oiled oak with Cognac Silk leather, Smoked oiled oak with Fiord 171, Smoked oiled oak with Black Silk leather, Black lacquered ash with Fiord 191, Black lacquered ash with Black Silk leather.  
**SK2 6-8 wks. lead-time** Available in fabrics, leathers and COM with white oiled, smoked oiled or black lacquered oak frame.

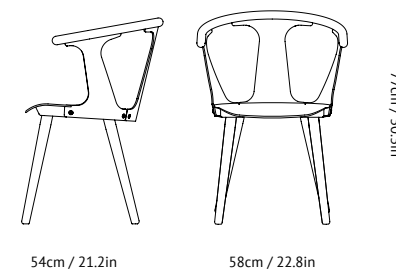

## In Between SK7-SK10

BY SAMI KALLIO  
2017

**Category** COUNTER STOOL OR BAR STOOL  
**Materials** Solid oak and formpressed oak veneer.  
**Dimensions (cm/in)** SK7 & SK9: H: 92cm/36.2in, W: 58cm/22.8in, D: 54cm/21.2in. Armrest height: 88cm/34.6in. Seat height: 65cm/26.3in. SK8 & SK10: H: 102cm/40.2in, W: 58cm/22.8in, D: 54cm/21.2in. Armrest height: 98cm/38.6in. Seat height: 75cm/30.2in.  
**SK7 & SK9 in stock** White oiled oak, Smoked oiled oak, Black lacquered oak.  
**SK8 & SK10 6-8 wks. lead-time** Available in fabrics, leathers and COM with white oiled, smoked oiled or black lacquered oak frame.

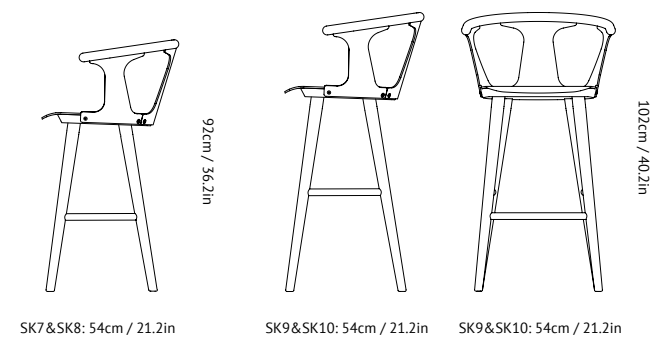





## In Between SK3 & SK4

BY SAMI KALLIO  
2014

**Category** DINING TABLE

**Materials** Solid oak.

**Dimensions (cm/in)** SK3: Ø: 90cm/35.4in, H: 73cm/28.7in.  
SK4: Ø: 120cm/47.2in, H: 73cm/28.7in.

**Colours** White oiled oak, Smoked oiled oak, Black lacquered oak (RAL 9005).

## In Between SK5 & SK6

BY SAMI KALLIO  
2015

**Category** DINING TABLE

**Materials** Oak veneer table top and lacquered solid oak legs.

**Dimensions (cm/in)** SK5: H: 73cm/28.7in, D: 200cm/78.7in, W: 90cm/35.4in.  
SK6: H: 73cm/28.7in, D: 250cm/98.4in, W: 100cm/39.4in.

**Colours** Clear lacquered oak, Smoked stained oak, Black lacquered oak.

**6-8 wks. lead-time** Available in custom sizes with veneer, laminate, nano laminate and linoleum table top upon request.

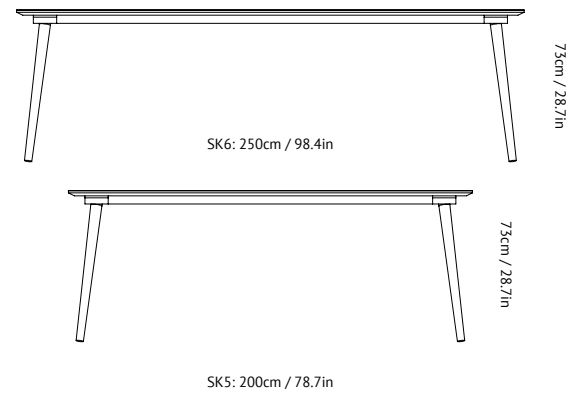
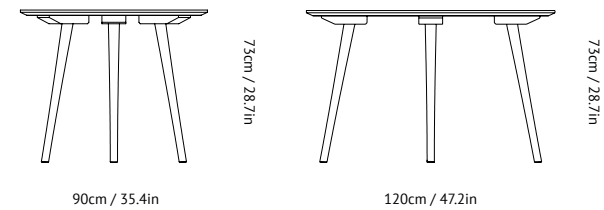

## Hoof SW1

BY SAMUEL WILKINSON  
2012

**Category** COFFEE TABLE

**Materials** Solid oak with a brushed surface.

**Dimensions (cm/in)** Ø: 50cm/19.7in, H: 50cm/19.7in.

**Colours** Solid white oiled oak, Solid smoked oiled oak, Solid black lacquered oak (RAL 9005).

## Hoof SW2

BY SAMUEL WILKINSON  
2012

**Category** COFFEE TABLE

**Materials** Solid oak with a brushed surface.

**Dimensions (cm/in)** Ø: 90cm/35.4in, H: 40cm/15.7in.

**Colours** Solid white oiled oak, Solid smoked oiled oak, Solid black lacquered oak (RAL 9005).

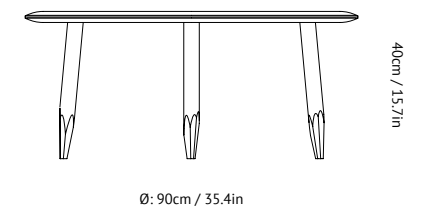
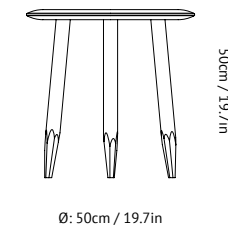

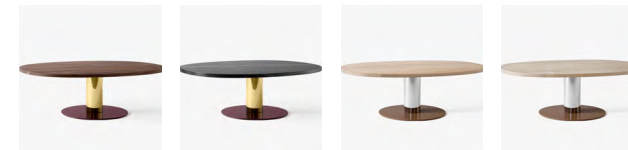
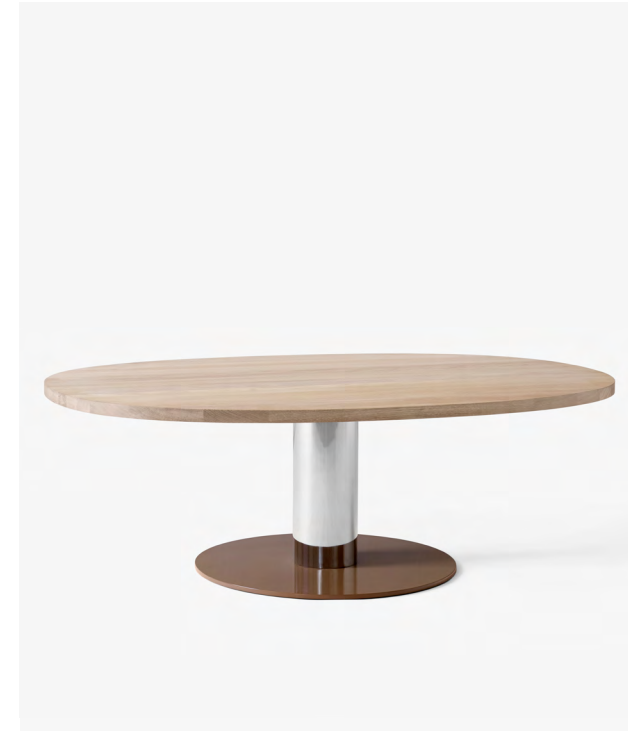
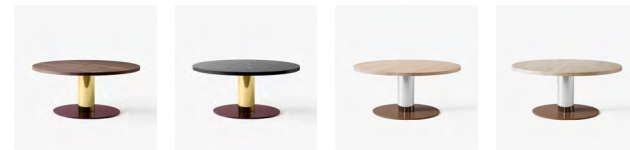
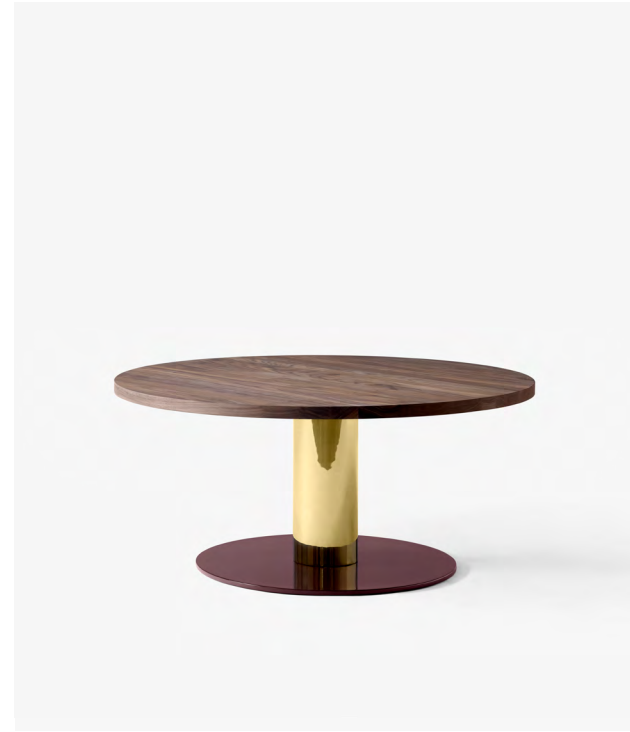
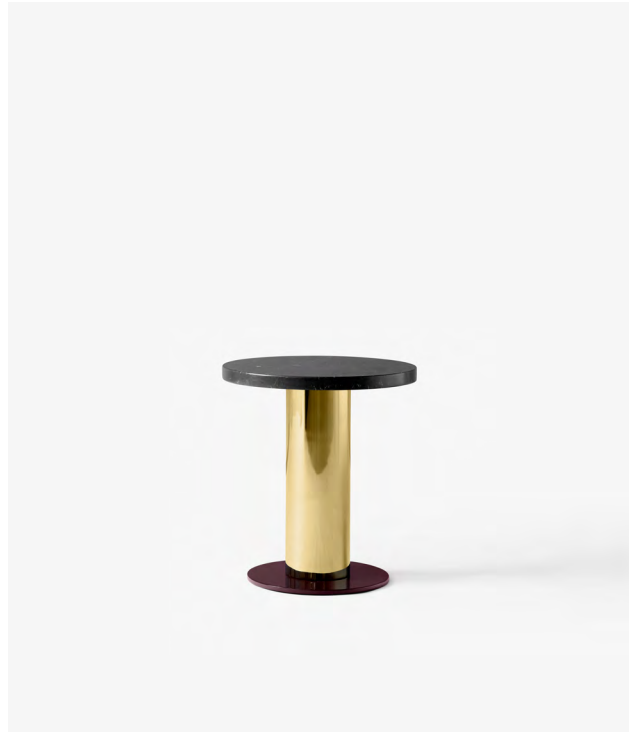

## Mezcla JH19

BY JAIME HAYON  
2018

**Category** SIDE TABLE

**Materials** Marble or solid wood with electro plated and powder coated steel.

**Dimensions (cm/in)** H: 45cm/17.7in, Ø: 42cm/16.5in.

**Colours** Oiled walnut with brass & burgundy.  
Honed Nero Marquina with brass & burgundy.  
White oiled oak with chrome & clay.  
Honed Travertine with chrome & clay.

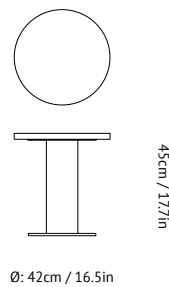

Ø: 42cm / 16.5in

## Mezcla JH20

BY JAIME HAYON  
2018

**Category** LOUNGE TABLE

**Materials** Marble or solid wood with electro plated and powder coated steel.

**Dimensions (cm/in)** H: 40cm/15.7in, Ø: 80cm/31.5in.

**Colours** Oiled walnut with brass & burgundy.  
Honed Nero Marquina with brass & burgundy.  
White oiled oak with chrome & clay.  
Honed Travertine with chrome & clay.

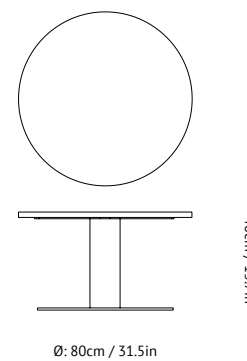

Ø: 80cm / 31.5in

## Mezcla JH21

BY JAIME HAYON  
2018

**Category** LOUNGE TABLE

**Materials** Marble or solid wood with electro plated and powder coated steel.

**Dimensions (cm/in)** H: 40cm/15.7in, D: 90cm/35.5in, L: 120cm/47.2in.

**Colours** Oiled walnut with brass & burgundy.  
Honed Nero Marquina with brass & burgundy.  
White oiled oak with chrome & clay.  
Honed Travertine with chrome & clay.

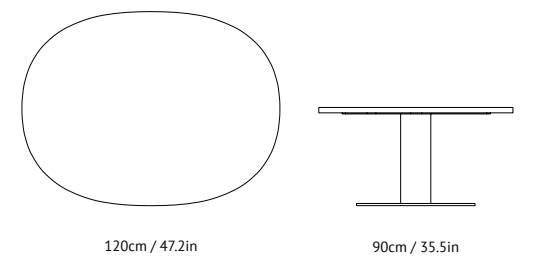

120cm / 47.2in

90cm / 35.5in

## Mezcla JH22

BY JAIME HAYON  
2018

**Category** DINING TABLE

**Materials** Marble or solid wood with electro plated and powder coated steel.

**Dimensions (cm/in)** H: 73cm/28.7in, D: 90cm/35.5in, L: 120cm/47.2in.

**Colours** Oiled walnut with brass & burgundy.  
Honed Nero Marquina with brass & burgundy.  
White oiled oak with chrome & clay.  
Honed Travertine with chrome & clay.

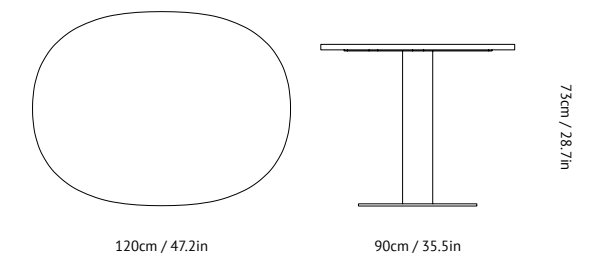

120cm / 47.2in

90cm / 35.5in

73cm / 28.7in

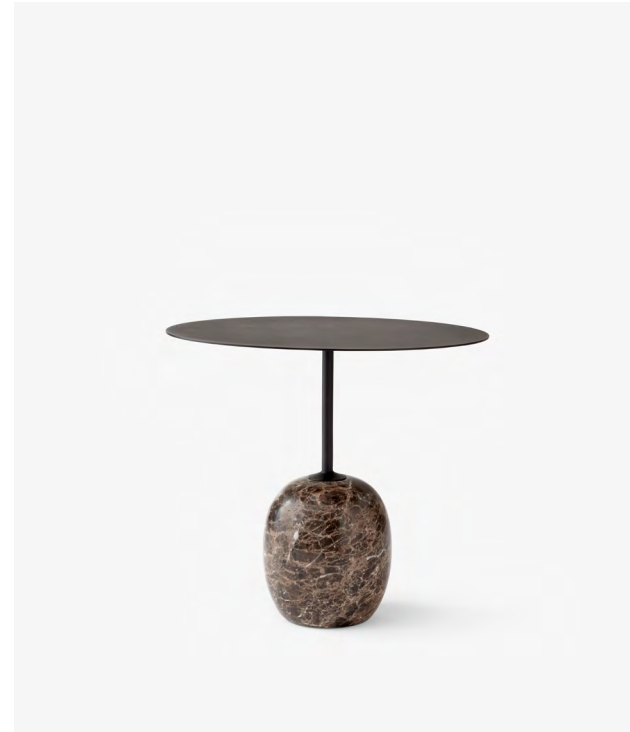

## Lato LN8

BY LUCA NICHETTO  
2018

**Category** COFFEE TABLE

**Materials** Marble and steel.

**Dimensions (cm/in)** Ø: 40cm/15.7in, H: 50cm/19.7in.

**Colours** Warm black & Emparador marble, Ivory white & Crema Diva marble.

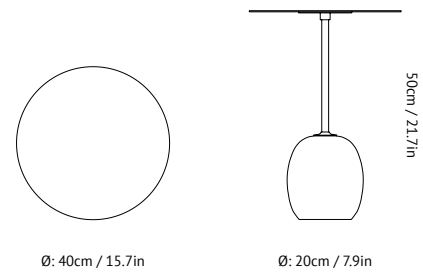

## Lato LN9

BY LUCA NICHETTO  
2018

**Category** COFFEE TABLE

**Materials** Marble and steel.

**Dimensions (cm/in)** H: 45cm/17.7in, D: 40cm/15.7in, L: 50cm/19.7in.

**Colours** Warm black & Emparador marble, Ivory white & Crema Diva marble.

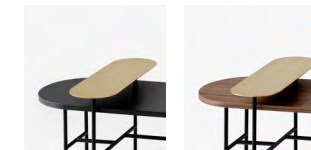
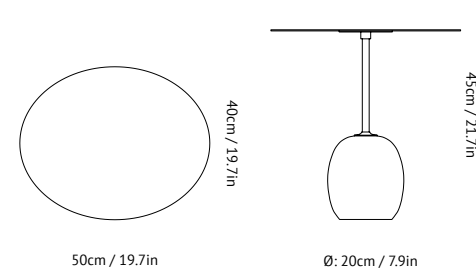

## Palette JH6

BY JAIME HAYON  
2015

**Category** LOUNGE TABLE

**Materials** Stainless steel, Bianco Carrara marble, pale pink stained ash.

**Dimensions (cm/in)** H: 46.7cm/18.4in, W: 70.8cm/27.9in, D: 82.5cm/32.5in.

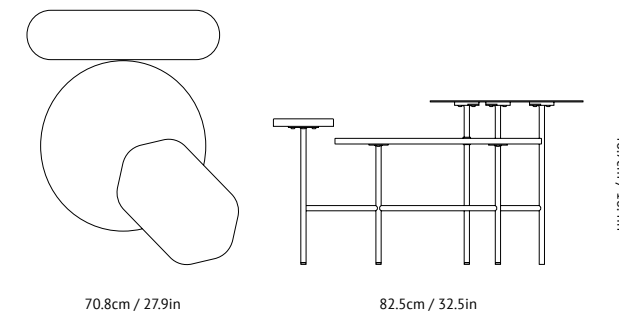

## Palette JH7

BY JAIME HAYON  
2015

**Category** LOUNGE TABLE

**Materials** Brass, Nero Marquina marble, lacquered ash veneer, lacquered walnut veneer.

**Dimensions (cm/in)** H: 47cm/18.5in, W: 67.8cm/26.7in, D: 115.2cm/45.4in.

**Colours** Brass, Nero Marquina marble, black lacquered ash. Brass, Nero Marquina marble, lacquered walnut.

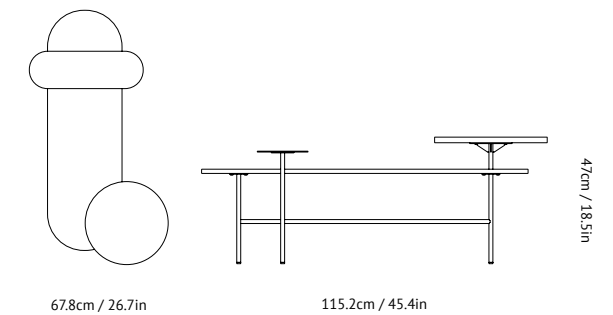

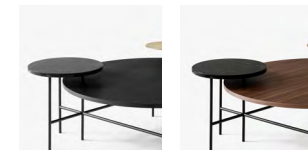

## Palette JH8

BY JAIME HAYON  
2015

**Category** LOUNGE TABLE

**Materials** Brass, Rosso Levanto marble, lacquered ash veneer, Nero Marquina marble, lacquered walnut veneer.

**Dimensions (cm/in)** H: 57cm/22.4in, W: 54.9cm/21.6in, D: 66.3cm/26in.

**Colours** Brass, Rosso Levanto marble, blue lacquered ash.  
Brass, Nero Marquina marble, lacquered walnut.

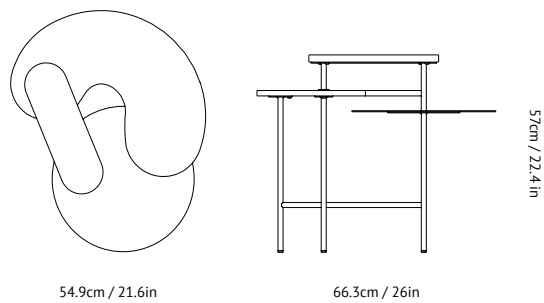

## Palette JH9

BY JAIME HAYON  
2015

**Category** DESK

**Materials** Brass, Nero Marquina marble, lacquered ash veneer, lacquered walnut veneer.

**Dimensions (cm/in)** H: 73-83cm/28.7-32.7in, W: 146cm/57.5in, D: 62cm/24.4in.

**Colours** Nero Marquina marble, black lacquered ash.  
Brass, grey green stained ash.  
Brass, lacquered walnut.

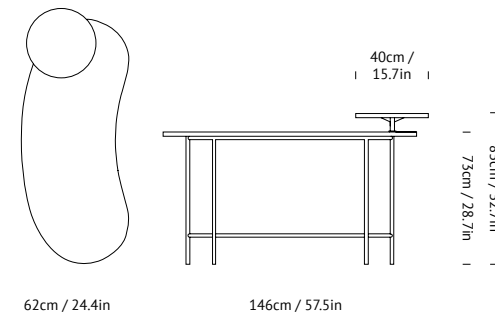

## Palette JH25

BY JAIME HAYON  
2018

**Category** LOUNGE TABLE

**Materials** Brass, Nero Marquina marble, lacquered ash veneer, lacquered walnut veneer.

**Dimensions (cm/in)** H: 42cm/16.5in, W: 118cm/46.5in, D: 103cm/40.6in.

**Colours** Brass, Nero Marquina, black lacquered ash.  
Brass, Nero Marquina, lacquered walnut.

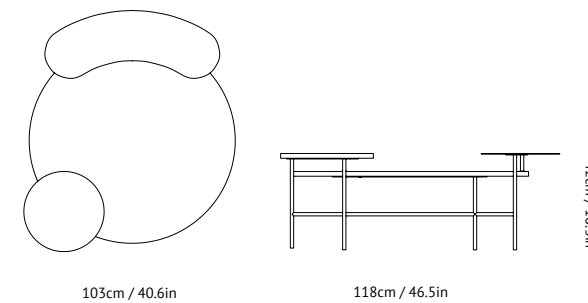

## Palette JH26

BY JAIME HAYON  
2018

**Category** SIDE TABLE

**Materials** Nero Marquina marble, lacquered ash veneer, lacquered walnut veneer.

**Dimensions (cm/in)** H: 67cm/26.4in, W: 47cm/18.5in, D: 46cm/18.1in.

**Colours** Nero Marquina, black lacquered ash.  
Nero Marquina, lacquered walnut.

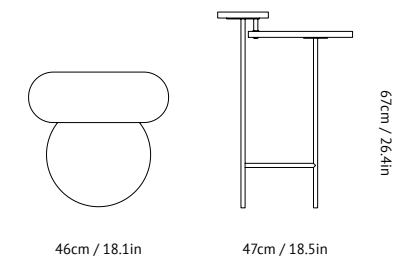

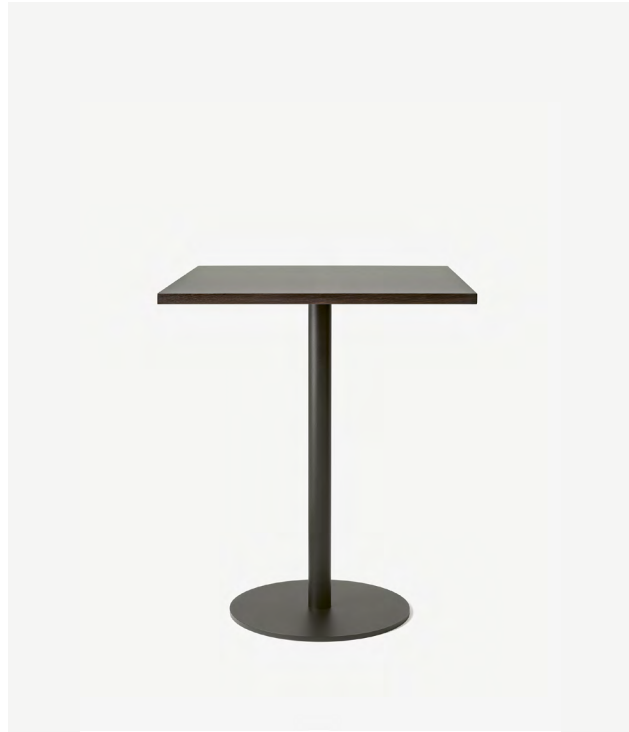

## Nærvær NA9-NA10

BY NORM ARCHITECTS  
2018

<b>Category</b>	CAFÉ TABLE
<b>Materials</b>	Powder coated steel base, Nano laminate table top with veneered edges.
<b>Dimensions (cm/in)</b>	NA9: Ø: 60cm/23.6in, H: 74cm / 29.1in. NA10: H: 70cm/27.6in, D: 70cm/27.6in, W: 60cm/23.6in.
<b>Colours</b>	Black & Smoked oiled oak.

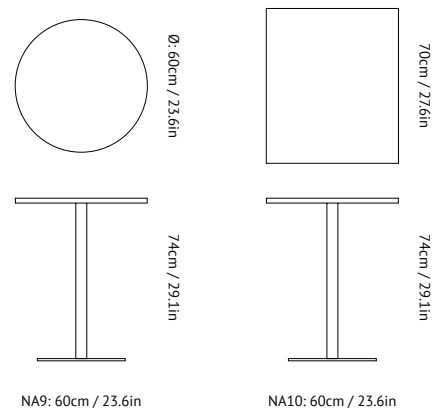

## Nærvær NA11

BY NORM ARCHITECTS  
2018

<b>Category</b>	SIDE TABLE
<b>Materials</b>	Powder coated steel base, Nano laminate table top with veneered edges.
<b>Dimensions (cm/in)</b>	Ø: 42cm/16.5in, H: 42cm/16.5in.
<b>Colours</b>	Black & Smoked oiled oak.

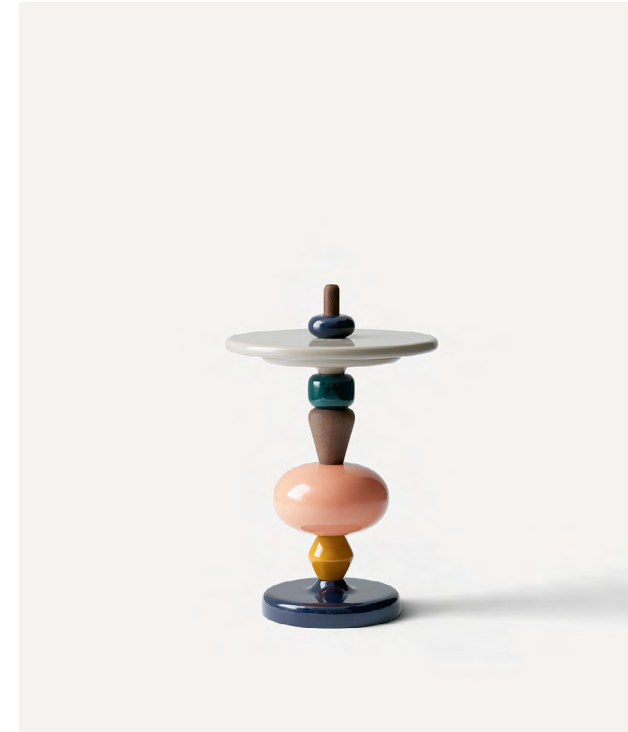
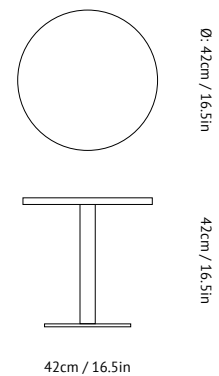

## Shuffle MH1

BY MIA HAMBORG  
BLACK EDITION BY PETER HAGEN  
2010

<b>Category</b>	SIDE TABLE
<b>Materials</b>	PU Lacquered MDF, polished marble, PU lacquered solid beech, solid oiled oak.
<b>Dimensions (cm/in)</b>	Ø: 45cm/17.7in, H: 69cm/27.2in.
<b>Colours</b>	Black lacquered wood and polished Nero Marquina marble or Spectrum.

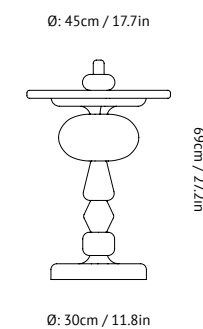

## True Colours LP1-LP7

BY LEX POTT  
2013

<b>Category</b>	VASES
<b>Materials</b>	Brass, Aluminium, Copper, Steel.
<b>Dimensions (cm/in)</b>	H: 190cm/74.8in, W: 10cm/4in, D: 3cm/1.2in.
<b>Colours</b>	White aluminium, Terracotta brass, Green copper, Brown aluminium, Blue brass, Black brass, Brown steel.

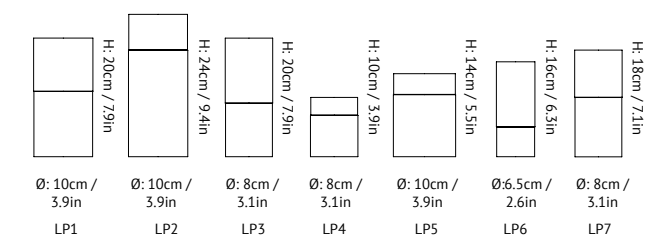



## Amore SC17-SC19

BY SPACE COPENHAGEN  
2018

<b>Category</b>	MIRROR
<b>Materials</b>	Bronzed brass frame, silver colored mirror, adjustable wall bracket.
<b>Dimensions (cm/in)</b>	SC17: H: 90cm/35.5in, D: 3cm/1.2in, W: 10cm/4in. SC18: H: 90cm/35.5in, D: 3cm/1.2in, W: 20cm/7.9in, SC19: H: 90cm/35.5in, D: 3cm/1.2in, W: 30cm/11.9in.
<b>Colours</b>	Bronzed brass.

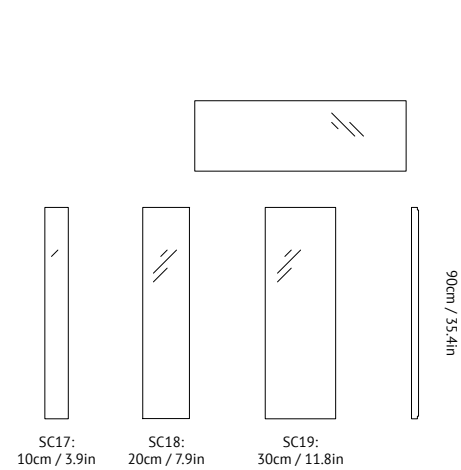

## Amore SC20-SC22

BY SPACE COPENHAGEN  
2018

<b>Category</b>	MIRROR
<b>Materials</b>	Bronzed brass frame, silver colored mirror, adjustable wall bracket.
<b>Dimensions (cm/in)</b>	SC20: H: 190cm/74.8in, D: 3cm/1.2in, W: 10cm/4in. SC21: H: 190cm/74.8in, D: 3cm/1.2in, W: 20cm/7.9in. SC22: H: 190cm/74.8in, D: 3cm/1.2in, W: 30cm/11.9in.
<b>Colours</b>	Bronzed brass.

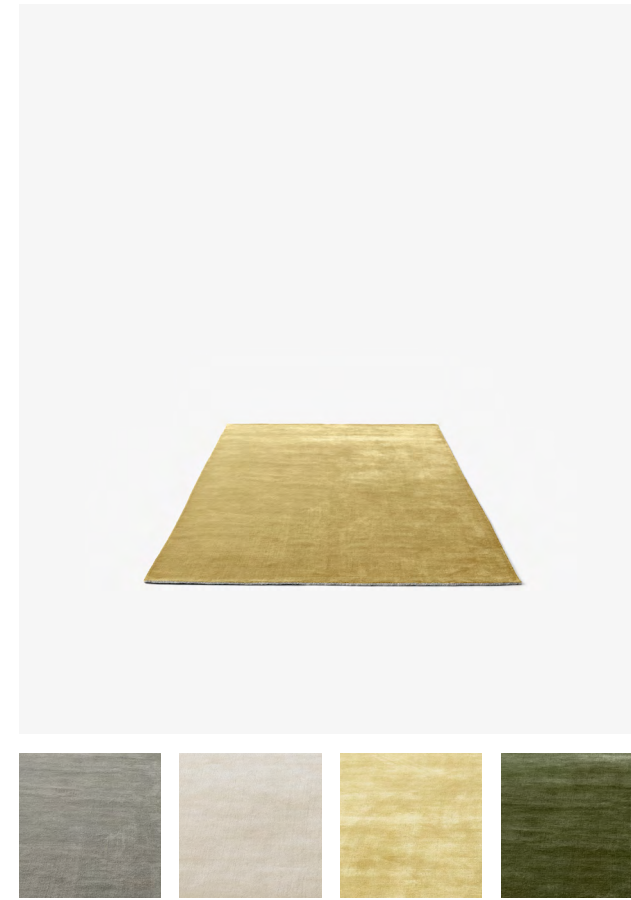
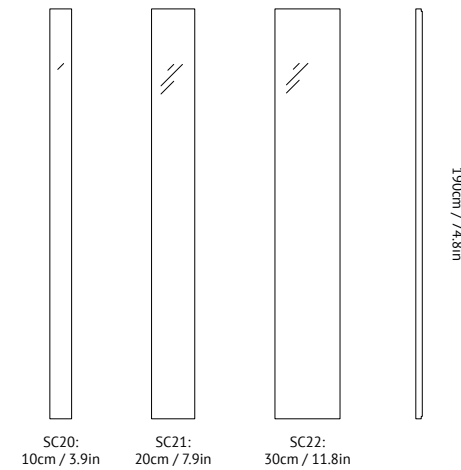

## The Moor AP5 & AP7

BY ALL THE WAY TO PARIS  
2016

<b>Category</b>	RUG
<b>Materials</b>	Handloom-woven rug with a dense, soft and highly exclusive velvet-like expression made from 85% pure New Zealand wool, 15% viscose.
<b>Dimensions (cm/in)</b>	AP5: W: 170cm/66.9in, L: 240cm/94.5in. AP7: W: 200cm/78.7in, L: 300cm/118.1in.
<b>Colours</b>	Grey moss, Beige dew, Yellow field, Green pine.

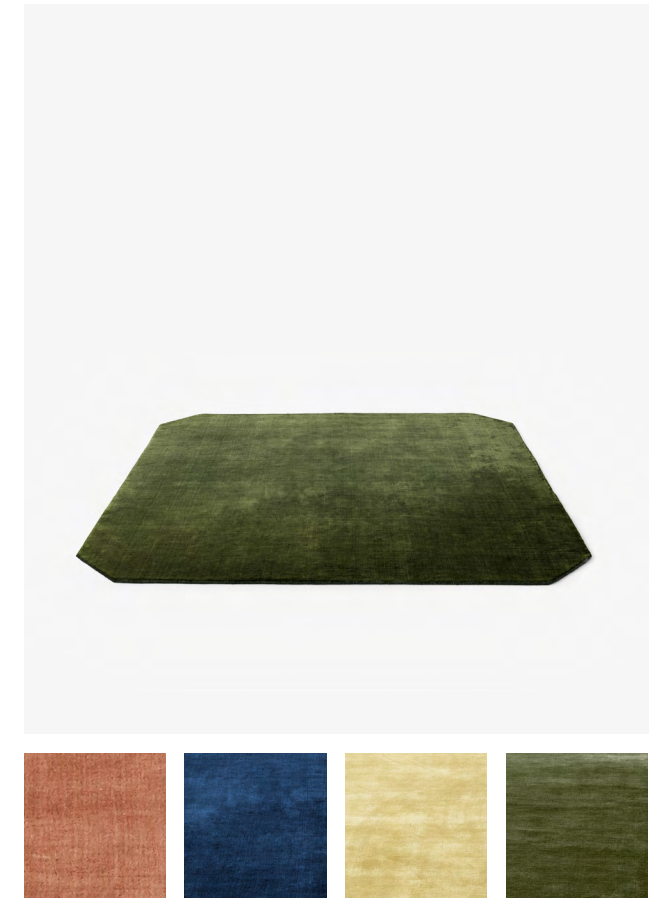
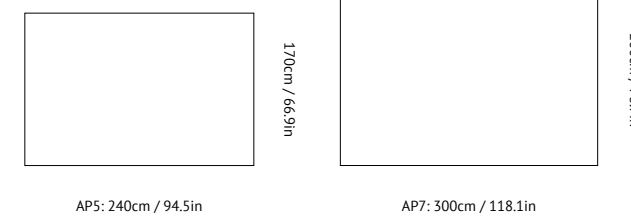

## The Moor AP6 & AP8

BY ALL THE WAY TO PARIS  
2016

<b>Category</b>	RUG
<b>Materials</b>	Handloom-woven rug with a dense, soft and highly exclusive velvet-like expression made from 85% pure New Zealand wool, 15% viscose.
<b>Dimensions (cm/in)</b>	AP6: W: 240cm/94.5in, L: 240cm/94.5in. AP8: W: 300cm/118.1in, L: 300cm/118.1in.
<b>Colours</b>	Red heather, Blue midnight, Yellow field, Green pine.

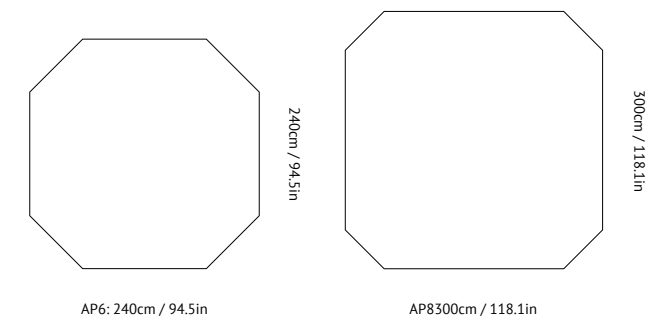

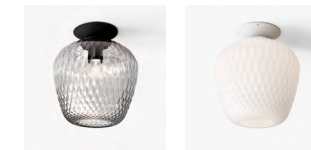
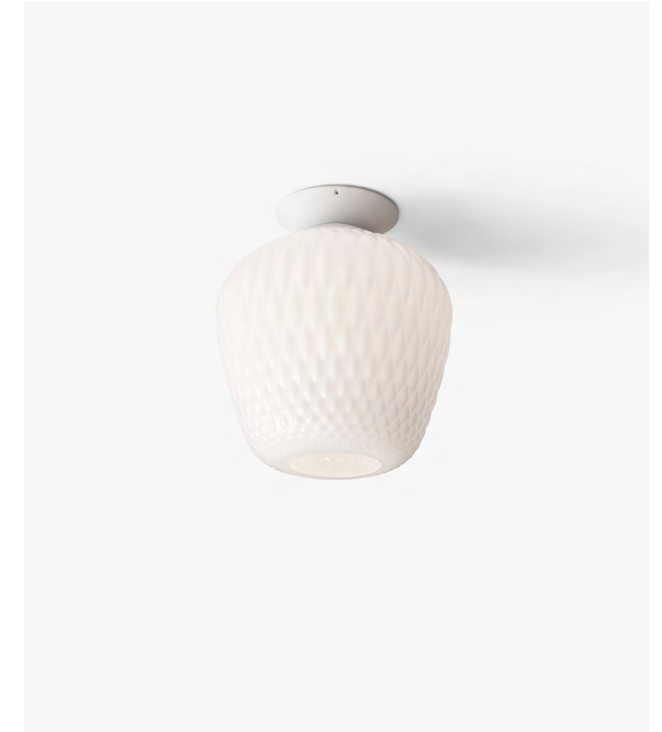
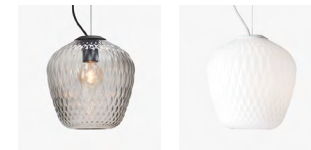
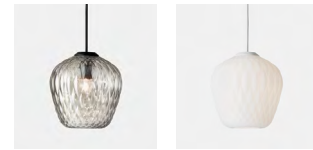
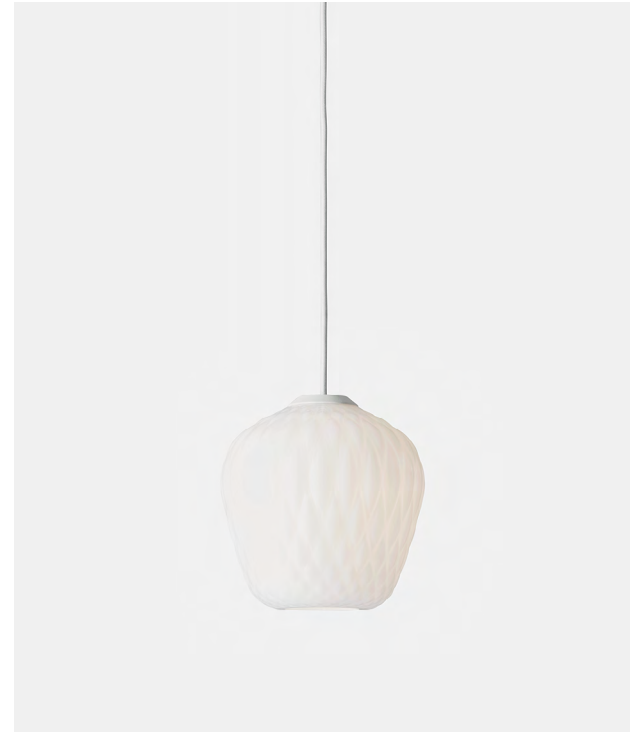

## Tricolore SH1-SH3

BY SEBASTIAN HERKNER  
2017

**Category** VASES

**Materials** Mouth-blown coloured bohemian glass.  
**Dimensions (cm/in)** SH1: Inner vase: Ø: 18cm/7.1in, H: 20cm/7.9in.  
Bottom vase: Ø: 17cm/6.7in, H: 9cm/3.5in.  
SH2: Inner vase: Ø: 14cm/5.5in, H: 25cm/9.8in.  
Bottom vase: Ø: 13cm/5.1in, H: 17cm/6.7in.  
SH3: Inner vase: Ø: 22cm/8.7in, H: 9cm/3.5in.  
Bottom vase: Ø: 21cm/8.3in, H: 6cm/2.3in.

**Colours** SH1: Malachite & Cornaline  
SH2: Amber & Lapis  
SH3: Topaz & Rubis

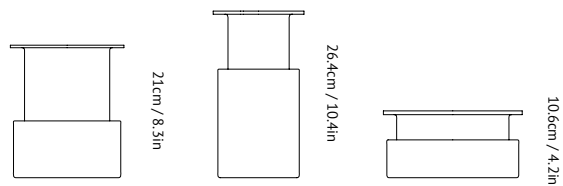

SH1: 18cm / 7.1in

SH2: 14.4cm / 5.7in

SH3: 22cm / 8.7in

## Blown SW4

BY SAMUEL WILKINSON  
2018

**Category** PENDANT

**Materials** Mouth-blown glass, metal fitting, 4m fabric cord.  
**Dimensions (cm/in)** Ø: 23cm/9in, H: 23cm/9in.  
**Colours** Silver lustre glass with black textile cord,  
Opal glass with white textile cord.  
**Light source** E14 Max 40W. The luminaire is compatible with  
bulbs of the energy classes: A++ - E.  
Bulb is not included.

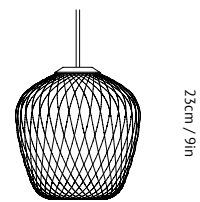

23cm / 9in

## Blown SW3

BY SAMUEL WILKINSON  
2014

**Category** PENDANT

**Materials** Mouth-blown glass, powdercoated metal  
suspension, coated wire, 4-meter fabric cord.  
**Dimensions (cm/in)** Ø: 28cm/11in, H: 28cm/11in.  
**Colours** Silver lustre glass with black textile cord,  
Opal glass with white textile cord.  
**Light source** E27 Max 100W. The luminaire is compatible with  
bulbs of the energy classes: A++ - E.  
Bulb is not included.

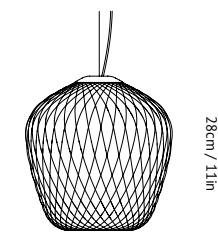

28cm / 11in

## Blown SW5

BY SAMUEL WILKINSON  
2018

**Category** CEILING LAMP

**Materials** Mouth-blown glass, metal fitting.  
**Dimensions (cm/in)** Ø: 28cm/11in, H: 34cm/13.38in.  
**Colours** Silver lustre & black metal fitting,  
Opal glass & white fitting.  
**Light source** E27 Max 60W. The luminaire is compatible with  
bulbs of the energy classes: A++ - E.  
Bulb is not included.

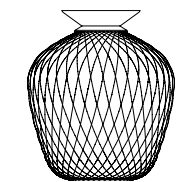

28cm / 11in

34cm / 13.38in



## Marble Light <sup>SV2</sup>

BY STUDIO VIT  
2014

<b>Category</b>	PENDANT
<b>Materials</b>	White Bianco Carrara marble and clear mouth blown borosilicate glass with 4-meter white fabric cord.
<b>Dimensions (cm/in)</b>	Marble: Ø: 8cm/3.1in, H: 10cm/3.9in. Glass: Ø: 13cm/5.1in.
<b>Light source</b>	G9 Max 25W. This luminaire is compatible with bulbs of the energy classes: A++ - E. Bulb is not included.

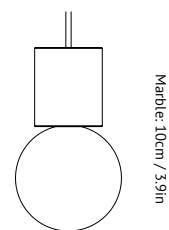

Marble: 10cm / 3.9in

Marble: Ø: 8cm / 3.1in, Glass: Ø: 13cm / 5.1in

## Marble Light <sup>SV3</sup>

BY STUDIO VIT  
2014

<b>Category</b>	PENDANT
<b>Materials</b>	White Bianco Carrara marble and clear mouth blown borosilicate glass with 4-meter white fabric cord.
<b>Dimensions (cm/in)</b>	Marble: Ø: 7cm/2.7in, H: 5cm/1.9in. Glass: Ø: 8cm/3.1in.
<b>Light source</b>	G9 Max 25W. This luminaire is compatible with bulbs of the energy classes: A++ - E. Bulb is not included.

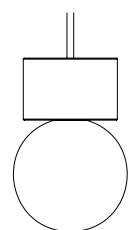

Marble: 5cm / 1.9in

Marble: Ø: 7cm / 2.7in, Glass: Ø: 8cm / 3.1in

## Marble Light <sup>SV4</sup>

BY STUDIO VIT  
2014

<b>Category</b>	PENDANT
<b>Materials</b>	White Bianco Carrara marble and clear mouth blown borosilicate glass with 4-meter white fabric cord.
<b>Dimensions (cm/in)</b>	Marble: Ø: 9cm/3.5in, H: 6cm/2.3in. Glass: Ø: 11cm/4.3in.
<b>Light source</b>	G9 Max 25W. This luminaire is compatible with bulbs of the energy classes: A++ - E. Bulb is not included.

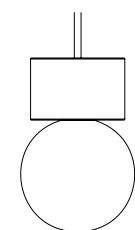

Marble: 6cm / 2.3in

Marble: Ø: 9cm / 3.5in, Glass: Ø: 11cm / 4.3in

## Marble Light <sup>SV5</sup>

BY STUDIO VIT  
2014

<b>Category</b>	PENDANT
<b>Materials</b>	White Bianco Carrara marble and clear mouth blown borosilicate glass with 4-meter white fabric cord.
<b>Dimensions (cm/in)</b>	Marble: Ø: 5cm/1.9in, H: 16cm/6.3in. Glass: Ø: 16cm/6.3in.
<b>Light source</b>	G9 Max 25W. This luminaire is compatible with bulbs of the energy classes: A++ - E. Bulb is not included.

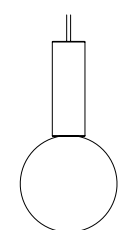

Marble: 16cm / 6.3in

Marble: Ø: 5cm / 1.9in, Glass: Ø: 16cm / 6.3in





## Marble Light <sup>SV6</sup>

BY STUDIO VIT  
2014

**Category** TABLE LAMP

**Materials** White Bianco Carrara marble and clear mouth blown borosilicate glass with 2-meter white fabric cord with dimmer.

**Dimensions (cm/in)** Marble: Ø: 7cm/2.7in, H: 5cm/1.9in.  
Glass: Ø: 16cm/6.3in.

**Light source** G9 Max 25W. This luminaire is compatible with bulbs of the energy classes: A++ - E. Bulb is not included.

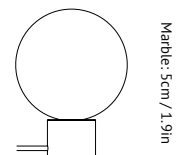

Marble: Ø: 7cm / 2.7in, Glass: Ø: 16cm / 6.3in

## Marble Light <sup>SV7</sup>

BY STUDIO VIT  
2014

**Category** PENDANT (SV2) WITH MARBLE FLOOR WEIGHT

**Materials** White bianco carrara marble with 10-meter white fabric cord fitted with G9 lamp holder. The floor weight is delivered with a white metal hook for ceiling installation and a self-assembly CE plug.

**Dimensions (cm/in)** Marble: Ø: 20cm/7.8in, H: 8cm/3.1in.

**Light source** G9 Max 25W. This luminaire is compatible with bulbs of the energy classes: A++ - E. Bulb is not included.

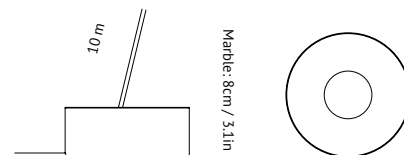

Ø: 20cm / 7.8in

## Fornell <sup>ABF1</sup>

BY ANDREAS BOZARTH FORNELL  
2017

**Category** PENDANT

**Materials** Mirror polished & matt lacquered stainless steel, PC diffuser, 6m cable & stainless steel wires

**Dimensions (cm/in)** Lamp shade: H: 6cm/2.4in, L: 120cm/47.2in, W: 7.5cm/2.9in. Canopy: H: 4cm/1.6in, L: 49cm/19.3in, W: 5cm/1.9in.

**Colours** Mirror polished stainless steel & matt black. Mirror polished stainless steel & matt white.

**Light source** 24W dimmable LED. The luminaire is compatible with bulbs of the energy classes: A++ - A. The built-in LEDs cannot be changed in this luminaire.

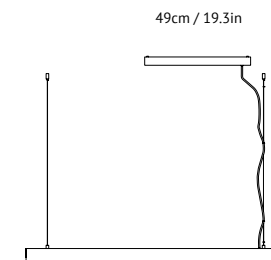

120cm / 47.2in

## Working Title <sup>HK1</sup>

BY HARRI KOSKINEN  
2017

**Category** DESK LAMP

**Materials** Die-cast and extruded aluminium, polycarbonate non-glare diffuser, 2 meter black PVC cable, 24V power supply.

**Dimensions (cm/in)** H: 45cm/17.7in, L: 30cm/11.8in, W: 15cm/5.9in.

**Colours** Hand polished aluminium & black PVC cord. Satin polished aluminium & black PVC cord.

**Light source** 8W LED. The luminaire is compatible with bulbs of the energy classes: A++ - A. The built-in LEDs cannot be changed in this luminaire.

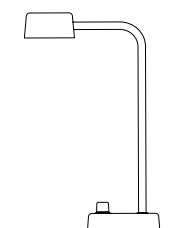

30cm / 11.8in

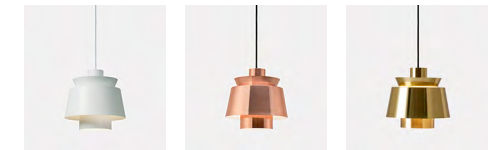

## Passepartout JH10

BY JAIME HAYON  
2016

**Category** CEILING & WALL LAMP

**Materials** Aluminium, Polycarbonate, ABS.

**Dimensions (cm/in)** Ø: 15.5cm/6.1in, H: 17cm/6.7in.

**Colours** Matt white, Gold.

**Light source** 11.5W LED dimmable through wall dimmer.  
The luminaire is compatible with bulbs of the energy classes: A++ - A. The built-in LEDs cannot be changed in this luminaire.

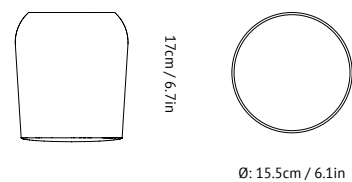

## Passepartout JH11

BY JAIME HAYON  
2016

**Category** CEILING & WALL LAMP

**Materials** Aluminium, Polycarbonate, ABS.

**Dimensions (cm/in)** Ø: 20cm/7.9in, H: 15.5cm/6.1in.

**Colours** Matt white, Gold.

**Light source** 11.5W LED dimmable through wall dimmer.  
The luminaire is compatible with bulbs of the energy classes: A++ - A. The built-in LEDs cannot be changed in this luminaire.

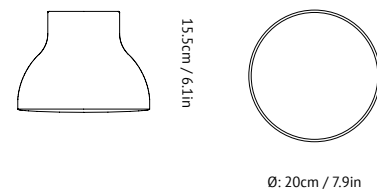

## Passepartout JH12

BY JAIME HAYON  
2016

**Category** CEILING & WALL LAMP

**Materials** Aluminium, Polycarbonate, ABS.

**Dimensions (cm/in)** Ø: 28cm/11in, H: 12.5cm/4.9in.

**Colours** Matt white, Gold.

**Light source** 11.5W LED dimmable through wall dimmer.  
The luminaire is compatible with bulbs of the energy classes: A++ - A. The built-in LEDs cannot be changed in this luminaire.

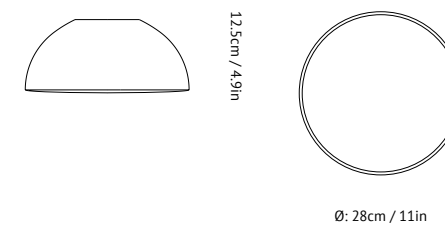

## Utzon JU1

BY JØRN UTZON  
1947

**Category** PENDANT

**Materials** Lacquered metal, 3-meter fabric cord.

**Dimensions (cm/in)** Ø: 22cm/8.7in, H: 23cm/9.1in.

**Colours** White lacquered steel with white fabric cord,  
Brass with black fabric cord, Lacquered copper  
with black fabric cord.

**Light source** E27 Max 60W. The luminaire is compatible with  
bulbs of the energy classes: A++ - E.  
Bulb is not included.

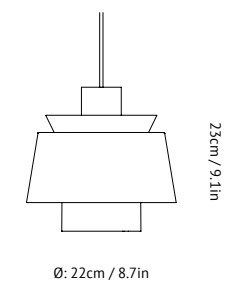

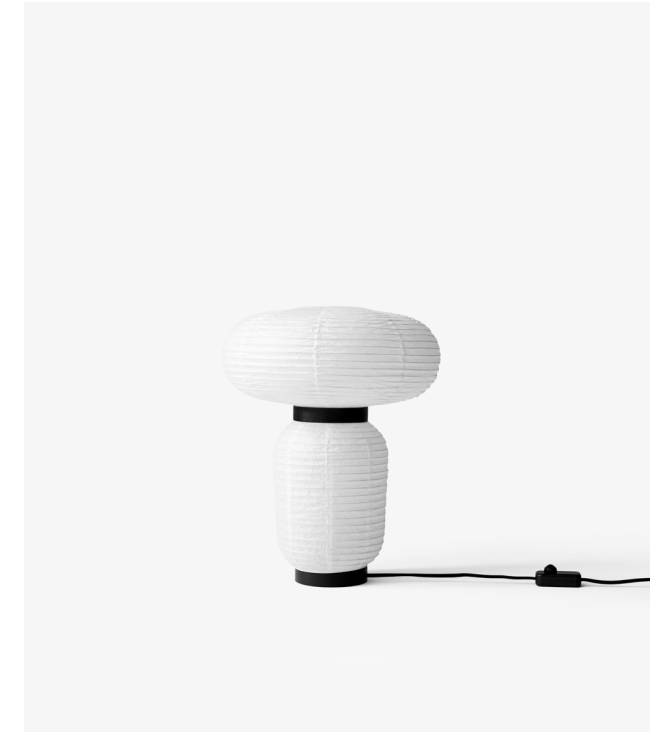
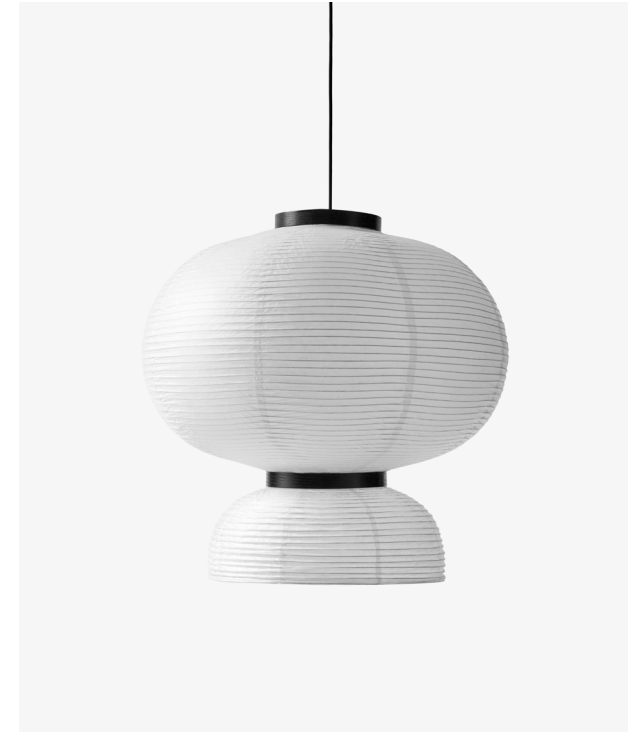

## Formakami JH3

BY JAIME HAYON  
2015

<b>Category</b>	PENDANT
<b>Materials</b>	Ivory white paper, black stained oak, 4-meter black fabric cord.
<b>Dimensions (cm/in)</b>	Ø: 46cm/18.1in, H: 68cm/26.7in.
<b>Colours</b>	Ivory white paper with black stained oak.
<b>Light source</b>	2 × E27 Max 60W. The luminaire is compatible with bulbs of the energy classes: A++ - E. Bulbs are not included.

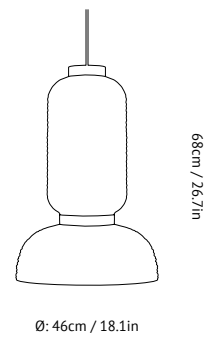

## Formakami JH4

BY JAIME HAYON  
2015

<b>Category</b>	PENDANT
<b>Materials</b>	Ivory white paper, black stained oak, 4-meter black fabric cord.
<b>Dimensions (cm/in)</b>	Ø: 50cm/19.7in, H: 50cm/19.7in.
<b>Colours</b>	Ivory white paper with black stained oak.
<b>Light source</b>	2 × E27 Max 60W. The luminaire is compatible with bulbs of the energy classes: A++ - E. Bulbs are not included.

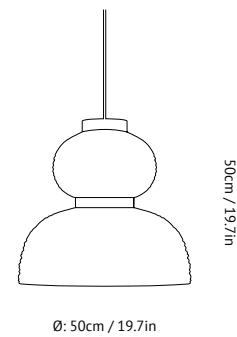

## Formakami JH5

BY JAIME HAYON  
2015

<b>Category</b>	PENDANT
<b>Materials</b>	Ivory white paper, black stained oak, 4-meter black fabric cord.
<b>Dimensions (cm/in)</b>	Ø: 70cm/27.6in, H: 74cm/29.1in.
<b>Colours</b>	Ivory white paper with black stained oak.
<b>Light source</b>	2 × E27 Max 60W. The luminaire is compatible with bulbs of the energy classes: A++ - E. Bulbs are not included.

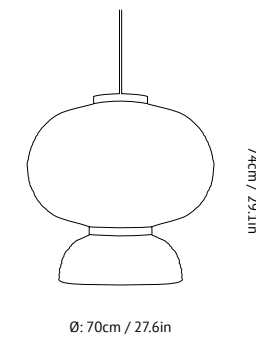

## Formakami JH18

BY JAIME HAYON  
2015

<b>Category</b>	TABLE LAMP
<b>Materials</b>	Ivory white paper, black stained oak, 2-meter black fabric cord with dimmer.
<b>Dimensions (cm/in)</b>	Ø: 38cm/14.9in, H: 50cm/19.6in.
<b>Colours</b>	Ivory white paper with black stained oak.
<b>Light source</b>	2 × E27 Max 60W. The luminaire is compatible with bulbs of the energy classes: A++ - E. Bulbs are not included.

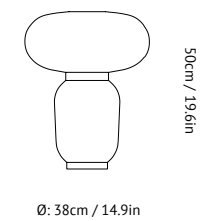



## Copenhagen SC6

BY SPACE COPENHAGEN  
2014

<b>Category</b>	PENDANT
<b>Materials</b>	Lacquered steel shade with plated steel suspension or satinized opal glass shade with bronzed brass suspension, 4-meter black fabric cord.
<b>Dimensions (cm/in)</b>	Ø: 20cm/7.8in, H: 25cm/9.8in.
<b>Colours</b>	Opal glass, Matt white, Matt blush, Matt black.
<b>Light source</b>	G9 Max 40W. This luminaire is compatible with bulbs of the energy classes: A++ - E. Bulb is not included.

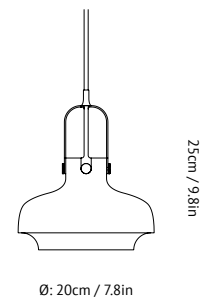

Ø: 20cm / 7.8in

25cm / 9.8in

## Copenhagen SC7

BY SPACE COPENHAGEN  
2014

<b>Category</b>	PENDANT
<b>Materials</b>	Lacquered steel shade with plated steel suspension or satinized opal glass shade with bronzed brass suspension, 4-meter black fabric cord.
<b>Dimensions (cm/in)</b>	Ø: 35cm/13.8in, H: 40cm/15.7in.
<b>Colours</b>	Opal glass, Matt black, Matt white.
<b>Light source</b>	E27 Max 100W. The luminaire is compatible with bulbs of the energy classes: A++ - E. Bulb is not included.

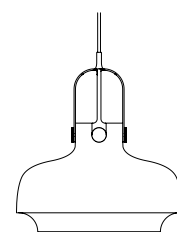

Ø: 35cm / 13.8in

40cm / 15.7in

## Copenhagen SC8

BY SPACE COPENHAGEN  
2014

<b>Category</b>	PENDANT
<b>Materials</b>	Lacquered aluminum shade with plated steel suspension, 6-meter fabric cord with safety wire.
<b>Dimensions (cm/in)</b>	Ø: 60cm/23.6in, H: 53cm/20.7in.
<b>Colours</b>	Matt black, Matt white.
<b>Light source</b>	E27 Max 150W. The luminaire is compatible with bulbs of the energy classes: A++ - E. Bulb is not included.

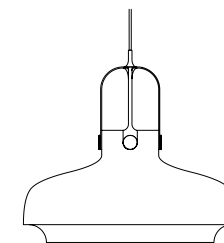

Ø: 60cm / 23.6in

53cm / 20.7in

## Copenhagen SC14

BY SPACE COPENHAGEN  
2018

<b>Category</b>	FLOOR LAMP
<b>Materials</b>	Mouth-blown glass and bronzed brass.
<b>Dimensions (cm/in)</b>	Lamp: Ø: 50cm/15.7in. Base: Ø: 30cm/11.8in. H: 150cm/59.5in.
<b>Colours</b>	Satinized opal glass and bronzed brass.
<b>Light source</b>	18 Watt LED. The luminaire is energy class: A+. The built-in LED module can be replaced in this luminaire. Available upon request.

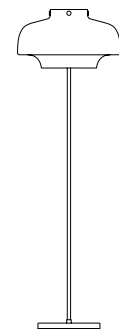

Lamp: Ø: 50cm / 15.7in  
Base: Ø: 30cm / 11.8in

150cm / 59.5in



## Copenhagen SC16

BY SPACE COPENHAGEN  
2018

<b>Category</b>	WALL LAMP
<b>Materials</b>	Mouth-blown glass and bronzed brass.
<b>Dimensions (cm/in)</b>	Lamp Ø: 16cm/6.3in, Base Ø: 9cm/3.5in. H: 13cm/5.2in, L: 27cm/10.6in.
<b>Colours</b>	Satinized opal glass and bronzed brass.
<b>Light source</b>	5,5W LED. The luminaire is energy class: A. The built-in LED module can't be replaced in this luminaire.

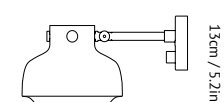

27cm / 10.6in  
lamp: 16cm / 6.3in

## Copenhagen SC13

BY SPACE COPENHAGEN  
2018

<b>Category</b>	TABLE LAMP
<b>Materials</b>	Mouth-blown glass and bronzed brass.
<b>Dimensions (cm/in)</b>	Lamp: Ø: 33cm/13in. Base: Ø: 17.5cm/6.9in. H: 42cm/16.5in.
<b>Colours</b>	Satinized opal glass and bronzed brass.
<b>Light source</b>	8W LED. The luminaire is energy class: A+. The built-in LED module can be replaced in this luminaire. Available upon request.

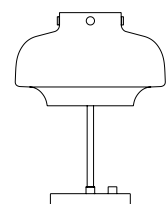

Lamp: Ø: 33cm / 13in  
Base: Ø: 17.5cm / 6.9in

## Copenhagen SC15

BY SPACE COPENHAGEN  
2018

<b>Category</b>	DESK LAMP
<b>Materials</b>	Mouth-blown glass and bronzed brass.
<b>Dimensions (cm/in)</b>	Lamp: Ø: 16cm/6.3in. Base: Ø: 17.5cm/6.8in. H: 37cm/14.5in, L: 38cm/14.9in.
<b>Colours</b>	Satinized opal glass and bronzed brass.
<b>Light source</b>	5,5W LED. The luminaire is energy class: A. The built-in LED module can't be replaced in this luminaire.

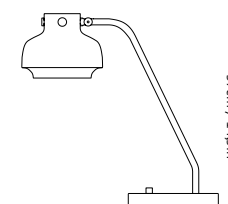

38cm / 14.9in

## Milk NA1

BY NORM.ARCHITECTS  
2010

<b>Category</b>	TABLE LAMP
<b>Materials</b>	Mouth blown opal glass, solid ash legs, 2-meter fabric cord with dimmer.
<b>Dimensions (cm/in)</b>	Ø: 20cm/7.9in, H: 25cm/9.8in.
<b>Colours</b>	Untreated ash legs with white fabric cord, Untreated ash legs with black fabric cord, Smoked oiled ash legs with black fabric cord. Black lacquered ash legs with black fabric cord.
<b>Light source</b>	G9 Max 40W. This luminaire is compatible with bulbs of the energy classes: A++ - E. Bulb is not included.

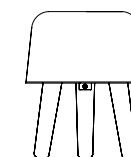

20cm / 7.9in

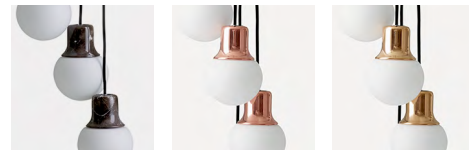
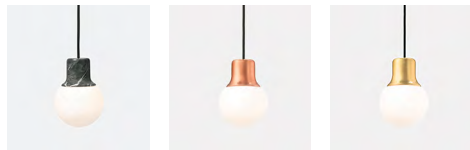

## Mass Light NA5

BY NORM ARCHITECTS  
2012

**Category** PENDANT

**Materials** Nero Marquina marble, copper or brass, white acid-etched opal glass, 4-meter black fabric cord. Mass Light can also be bought as a chandelier with a canopy for 9 pendants.

**Dimensions (cm/in)** Ø: 12.6cm/5in, H: 18.3cm/7.2in.

**Light Source** G9 Max 40W. This luminaire is compatible with bulbs of the energy classes: A++ - E. Bulb is not included.

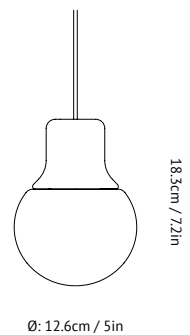

Ø: 12.6cm / 5in

18.3cm / 7.2in

## Mass Light NA6

BY NORM ARCHITECTS  
2012

**Category** CHANDELIER

**Materials** Nero Marquina marble, copper or brass, white acid-etched opal glass, 4-meter black fabric cord.

**Dimensions (cm/in)** Ø: 12.6cm/5in, H: 18.3cm/7.2in, L: Min 80cm/31.5in Max 175cm/68.9in. W: 40cm/15.7in. Base: 16cm.

**Light source** 9 × G9 Max 40W. This luminaire is compatible with bulbs of the energy classes: A++ - E. Bulbs are not included.

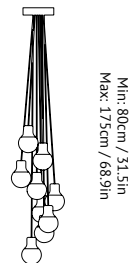

40cm / 15.7in  
Base: 16cm / 6.3in

Min: 80cm / 31.5in  
Max: 175cm / 68.9in



## Journey SHY1

BY SIGNE HYTTE  
2018

**Category** TABLE & WALL LAMP

**Materials** Mouth-blown opal glass and steel with dimmer knob.

**Dimensions (cm/in)** L: 26cm/10.2in, W: 18cm/7in, H: 24cm/9.4in.

**Colours** Mirror, Black, Clay.

**Light source** 4,8W LED. The luminaire is energy class: A+. The built-in LEDs cannot be changed in this luminaire.

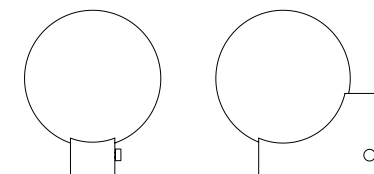

18cm / 7in

26cm / 10.2in

24cm / 9.4in

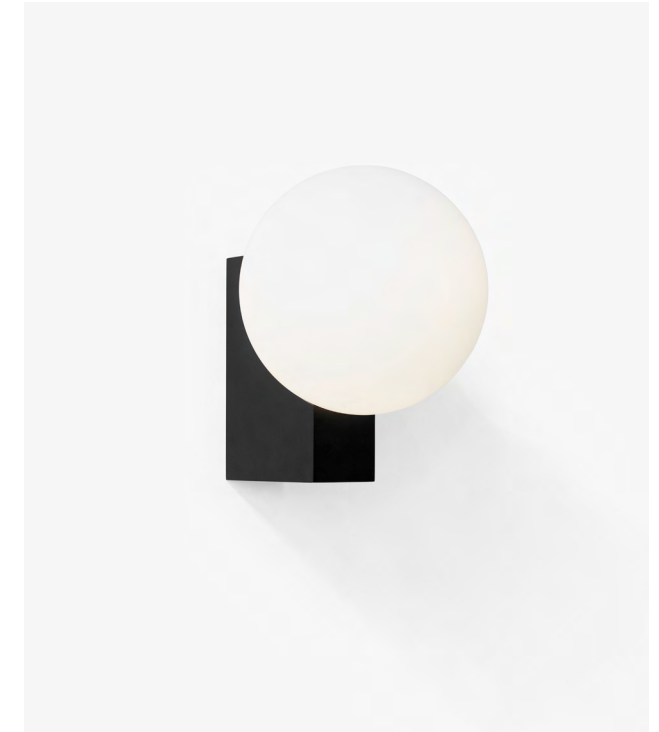

## Journey SHY2

BY SIGNE HYTTE  
2018

**Category** WALL LAMP

**Materials** Mouth-blown opal glass and steel.

**Dimensions (cm/in)** L: 26cm/10.2in, W: 18cm/7in, H: 24cm/9.4in.

**Colours** Mirror, Black, Clay.

**Light source** G9 Max 33W. The luminaire is compatible with bulbs of the energy class: A++ - E. Bulb is not included.

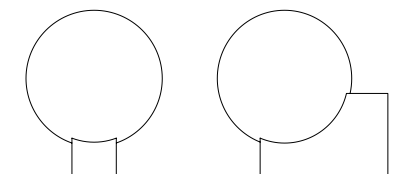

18cm / 7in

26cm / 10.2in

24cm / 9.4in

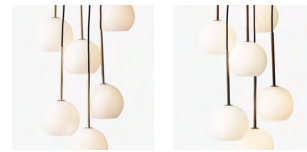
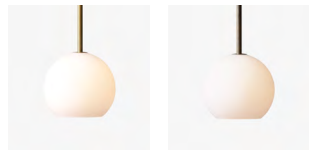

## Ice SR3

BY **SOFIE REFER**  
2018

<b>Category</b>	PENDANT
<b>Materials</b>	Mouth-blown satinized opal glass and brass with 4-meter fabric cord.
<b>Dimensions (cm/in)</b>	Ø: 14cm/5.5in, L: 30cm/11.8in.
<b>Colours</b>	Satinized opal glass & brass, Satinized opal glass & bronzed brass.
<b>Light source</b>	G9 Max 25W. The luminaire is compatible with bulbs of the energy class: A++ - E. Bulb is not included.

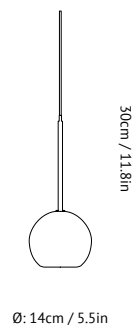

Ø: 14cm / 5.5in

## Ice SR4

BY **SOFIE REFER**  
2018

<b>Category</b>	CHANDELIER
<b>Materials</b>	Mouth-blown satinized opal glass and brass with 4-meter fabric cord.
<b>Dimensions (cm/in)</b>	Ø: 38cm/14.9in, L: 180cm/70.8in.
<b>Colours</b>	Satinized opal glass & brass, Satinized opal glass & bronzed brass.
<b>Light source</b>	9 × G9 Max 25W. The luminaire is compatible with bulbs of the energy class: A++ - E. Bulbs are not included.

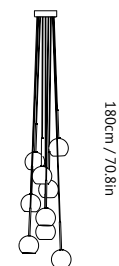

Ø: 38cm / 14.9in

## Bulb SR1

BY **SOFIE REFER**  
2001

<b>Category</b>	PENDANT
<b>Materials</b>	Mouth blown glass with 3-meter cord and porcelain lamp holder.
<b>Dimensions (cm/in)</b>	Ø: 11cm/4.3in, H: 16.3cm/6.4in.
<b>Colours</b>	Clear glass with clear PVC cord, Clear glass with black fabric cord.
<b>Light source</b>	E27 Max 60W. The luminaire is compatible with bulbs of the energy classes: A++ - E. Bulb is not included.

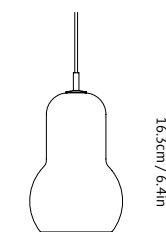

Ø: 11cm / 4.3in

## Mega Bulb SR2

BY **SOFIE REFER**  
2006

<b>Category</b>	PENDANT
<b>Materials</b>	Mouth blown glass with 3-meter cord and porcelain lamp holder.
<b>Dimensions (cm/in)</b>	Ø: 18cm/7.1in, H: 23cm/9in.
<b>Colours</b>	Clear glass with black fabric cord, Clear glass with clear cord, Silver lustre glass with black fabric cord, Silver lustre glass with clear PVC cord, Gold lustre glass with white fabric cord, Gold lustre glass with clear PVC cord.
<b>Light source</b>	E27 Max 60W. The luminaire is compatible with bulbs of the energy classes: A++ - E. Bulb is not included.

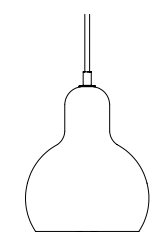

Ø: 18cm / 7.1in

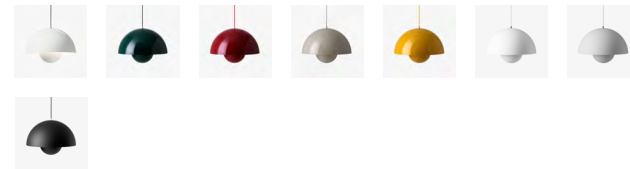
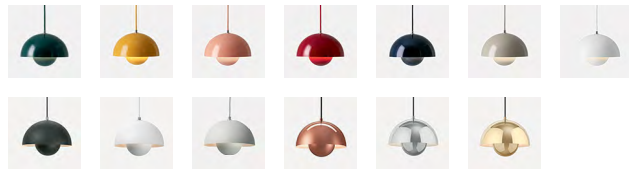
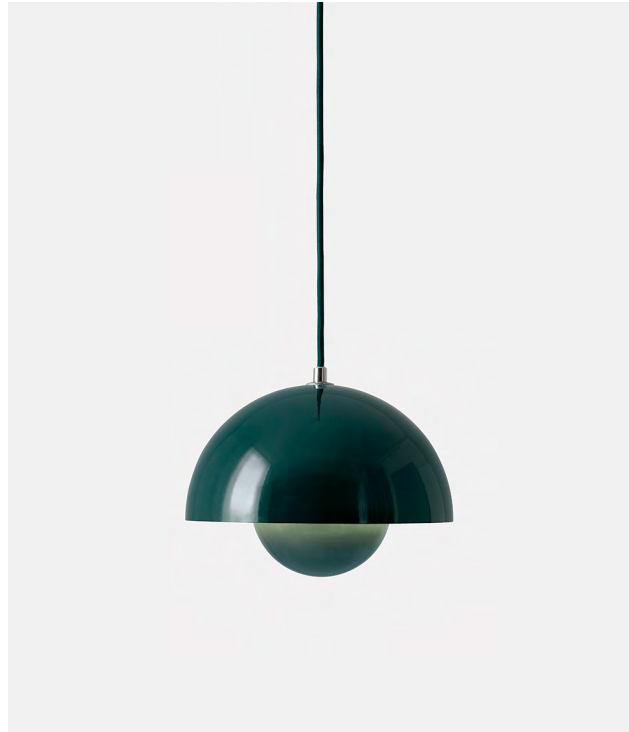

## Flowerpot VP1

BY VERNER PANTON  
1968

<b>Category</b>	PENDANT
<b>Materials</b>	Lacquered metal with 3-meter fabric cord.
<b>Dimensions (cm/in)</b>	Ø: 23cm/9.1in, H: 16cm/6.3in.
<b>Colours</b>	Dark green, Mustard, Beige red, Deep red, Black blue, Grey beige, White, Matt black, Matt white, Matt light grey, Polished copper, Polished stainless steel, Polished brass.
<b>Light source</b>	E27 Max 40W. The luminaire is compatible with bulbs of the energy classes: A++ - E. Bulb is not included.

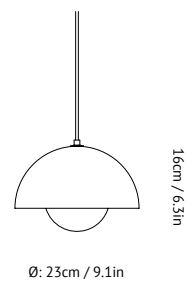

## Flowerpot VP2

BY VERNER PANTON  
1968

<b>Category</b>	PENDANT
<b>Materials</b>	Lacquered metal with 3-meter fabric cord.
<b>Dimensions (cm/in)</b>	Ø: 50cm/19.7in, H: 36cm/14.2in.
<b>Colours</b>	White, Dark green, Deep red, Grey beige, Mustard, Matt white, Matt light grey, Matt black. Other colours available upon request min 5pc with an 15% upcharge. Lacquered Copper and lacquered Brass 25% upcharge.
<b>Light source</b>	E27 Max 60W. The luminaire is compatible with bulbs of the energy classes: A++ - E. Bulb is not included.

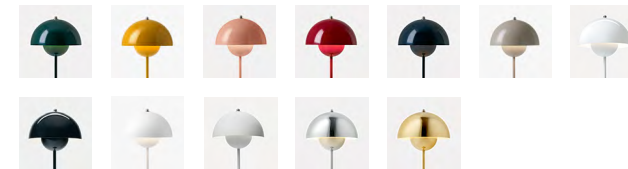
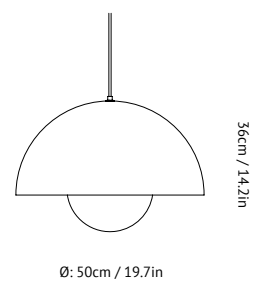

## Flowerpot VP3

BY VERNER PANTON  
1969

<b>Category</b>	TABLE LAMP
<b>Materials</b>	Lacquered steel with 2-meter clear PVC cord.
<b>Cord Dimensions</b>	Ø: 23cm/9.1in, H: 50cm/19.7in.
<b>Colours</b>	Dark green, Mustard, Beige red, Deep red, Black blue, Grey beige, White, Matt black, Matt light grey, Matt white, Polished stainless steel, Polished brass.
<b>Light source</b>	E27 Max 40W. The luminaire is compatible with bulbs of the energy classes: A++ - E. Bulb is not included.

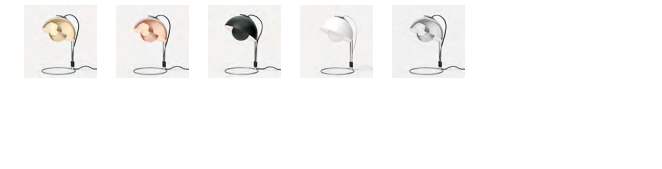
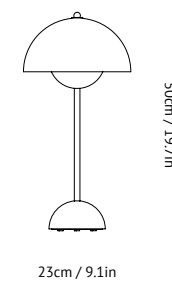

## Flowerpot VP4

BY VERNER PANTON  
1968

<b>Category</b>	TABLE LAMP
<b>Materials</b>	Lacquered metal with 3-meter fabric cord.
<b>Dimensions (cm/in)</b>	Ø: 23cm/9.1in, H: 36cm/14.1in.
<b>Colours</b>	Polished brass, Polished copper, Matt black, Matt white, Polished stainless steel.
<b>Light source</b>	E 27 Max 40W. The luminaire is compatible with bulbs of the energy classes: A++ - E. Bulb is not included.

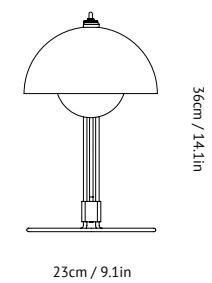



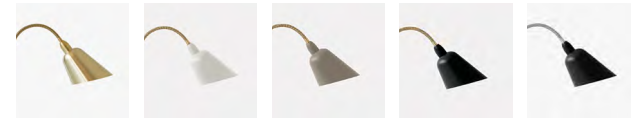

## Bellevue AJ7

BY ARNE JACOBSEN  
1929

<b>Category</b>	FLOOR LAMP
<b>Materials</b>	Satin polished and lacquered metal, cast iron base, 2 meter fabric cord with on-off switch.
<b>Dimensions (cm/in)</b>	Lamp D: 60cm/23.6in. Base Ø: 27.3cm/10.7in. H: 130cm/51.2in.
<b>Colours</b>	Brass, Ivory white & brass, Grey beige & brass, Black & brass, Black & steel.
<b>Light source</b>	E27 Max 60W. The luminaire is compatible with bulbs of the energy classes: A++ - E. Bulb is not included.

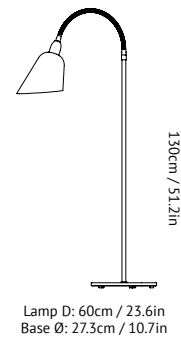

## Bellevue AJ9

BY ARNE JACOBSEN  
1929

<b>Category</b>	WALL LAMP
<b>Materials</b>	Satin polished and lacquered metal, cast iron base, 2 meter fabric cord. On-off switch on wall mount base.
<b>Dimensions (cm/in)</b>	Lamp D: 28cm/11in. Wall Mount Ø: 8.5cm/3.3in. W: 16.5cm/6.5in, H: 30cm/11.8in.
<b>Colours</b>	Brass, Ivory white & brass, Grey beige & brass, Black & brass, Black & steel.
<b>Light source</b>	E14 Max 40W. The luminaire is compatible with bulbs of the energy classes: A++ - E. Bulb is not included.

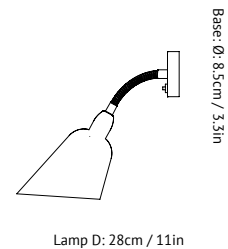

## Bellevue AJ8

BY ARNE JACOBSEN  
1929

<b>Category</b>	TABLE LAMP
<b>Materials</b>	Satin polished and lacquered metal, cast iron base, 2-meter fabric cord. On-off switch on base.
<b>Dimensions (cm/in)</b>	Lamp D: 42cm/16.5in. Base Ø: 17.5cm/6.9in. W: 16.5cm/6.5in, H: 42cm/16.5in.
<b>Colours</b>	Brass, Ivory white & brass, Grey beige & brass, Black & brass, Black & steel.
<b>Light source</b>	E14 Max 40W. The luminaire is compatible with bulbs of the energy classes: A++ - E. Bulb is not included.

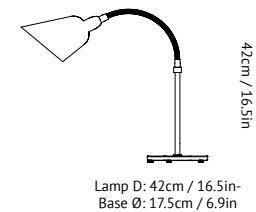

## Bellevue AJ10 & AJ11

BY ARNE JACOBSEN  
1929

<b>Category</b>	PLUG-IN TABLE LAMP
<b>Materials</b>	Satin polished and lacquered metal, cast iron base, 2-meter fabric cord. On-off switch on base.
<b>Dimensions (cm/in)</b>	AJ10: Lamp D: 42cm/16.5in. Base Ø: 7cm/2.83in. W: 16.5cm/6.5in, H: 42cm/16.5in. AJ11: Lamp D: 42cm/16.5in. Base Ø: 9.5cm/3.8in. W: 16.5cm/6.5in, H: 42cm/16.5in.
<b>Colours</b>	Brass, Black & brass.
<b>Light source</b>	E14 Max 40W. The luminaire is compatible with bulbs of the energy classes: A++ - E. Bulb is not included.

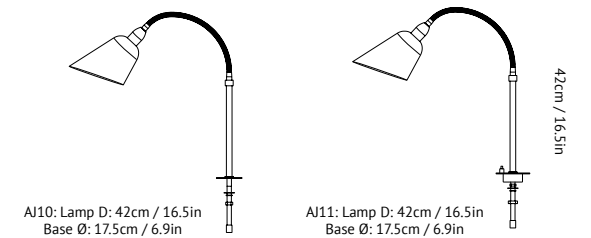

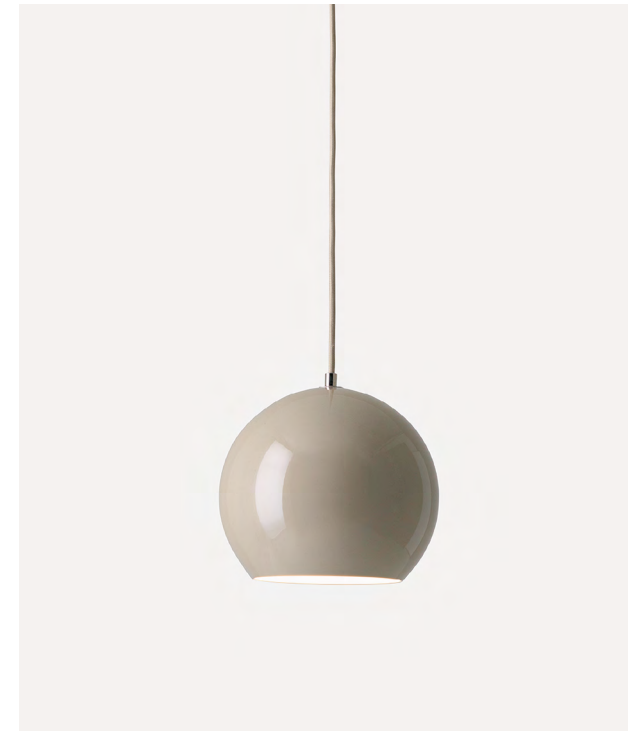

## Spinning <sup>BH1</sup>

BY BENJAMIN HUBERT  
2010

**Category** PENDANT

**Materials** Lacquered aluminium with 4-meter PVC cord.

**Dimensions (cm/in)** H: 45cm/17.7in, Ø: 25cm/9.8in.

**Colours** Matt white, Matt dark grey, Matt black.

**Light source** E27 Max 60W. The luminaire is compatible with bulbs of the energy classes: A++ - E. Bulb is not included.

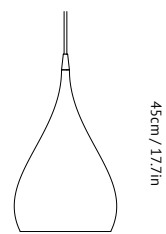

45cm / 17.7in

Ø: 25cm / 9.8in

## Spinning <sup>BH2</sup>

BY BENJAMIN HUBERT  
2010

**Category** PENDANT

**Materials** Lacquered aluminium with 4-meter PVC cord.

**Dimensions (cm/in)** Ø: 40cm/15.7in, H: 34cm/13.4in.

**Colours** Matt white, Matt dark grey, Matt black.

**Light source** E27 Max 60W. The luminaire is compatible with bulbs of the energy classes: A++ - E. Bulb is not included.

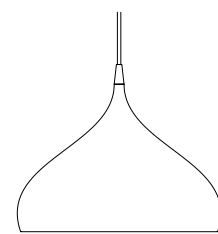

34cm / 13.4in

Ø: 40cm / 15.7in

## Topan <sup>VP6</sup>

BY VERNER PANTON  
1959

**Category** PENDANT

**Materials** Lacquered aluminium with 3-meter fabric cord.

**Dimensions (cm/in)** Ø: 21cm/8.3in, H: 19cm/7.5in.

**Colours** Grey beige, White, Black blue, Dark green, Deep red.

**Light source** E27 Max 40W. The luminaire is compatible with bulbs of the energy classes: A++ - E. Bulb is not included.

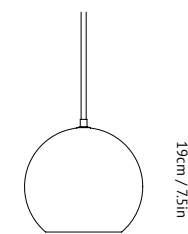

19cm / 7.5in

Ø: 21cm / 8.3in



&tradition  
Kronprinsessegade 4  
DK - 1306 Copenhagen K  
andtradition.com

©&tradition 2018

#andtradition

CONCEPT /  
CREATIVE DIRECTION  
All the Way to Paris

GRAPHIC DESIGN  
All the Way to Paris

PHOTOGRAPHY  
Brian Buchard  
Mikkel Rahr Mortensen

