

& Tradition[®]







Paying homage to Denmark's long-standing design heritage, &Tradition bridges old and new by creating furniture, lighting and interior objects with timeless appeal.

From reissuing design icons to creating future classics in collaboration with acclaimed international designers, the collection combines craftsmanship with creativity and shapes carefully considered pieces with purpose and meaning.

Always respectfully. Always made to last.

CLASSICS AND NEW ICONS

Functionality, minimalism and pure, sleek lines defined Danish Modernism throughout the 50s and 60s, where design and furniture-making were the product of meticulous craftsmanship and resulted in the creation of timeless products.

Here at &Tradition we collect iconic works by modernist mid-century artists, including Arne Jacobsen and Verner Panton, and match them with designs by some of the most acclaimed contemporary designers. This year, we are expanding our collection with pieces from the 50s to today.

A series of tables, chairs and lamps by modernists Peter Hvidt and Orla Mølgaard Nielsen were retrieved through old sketches and will join the &Tradition family – some produced for the first time ever. Both Copenhagen natives and trained furniture makers, the duo are renowned for the simplicity of their work and were among the first to introduce relatively inexpensive pieces to produce and export on an international scale. The line includes Hvidt & Mølgaard's elegant Drawn chair, different editions of the Drop Leaf table, and the sculptural Tripod lamp.

We are also adding a brand-new collection of accessories – ranging from cushions, to throws and planters – named &Tradition Collect, introducing a whole set of smaller-scale home objects designed by Space Copenhagen. Each piece from &Tradition Collect can be easily mixed and matched with others and reflects our commitment to crafting high quality and long-lasting products.

Our collection of contemporary furnishing and lighting will also see several new entries: Space Copenhagen's newly-designed Lucca portable lamp is inspired by the dreamy, smooth glow of a lantern where the light source is enclosed in a white opal glass and Hee Welling's Patch is an extendable dining table built out of high quality wood and employs a butterfly extension technique to provide extra seating.

Browse the following pages and let yourself be inspired by an ever-evolving collection blending reissued timeless classics with newly-designed contemporary works.



Tripod HM8 floor lamp | Little Petra VB2 Sheepskin Sahara sofa | Laro LN8 & LN9 side table
| The Moor rug AP8 | & Tradition Collect Planter SC44



Drop Leaf HM5 lounge table | Copenhagen SC15 desk lamp | &Tradition Collect
Indigo Cushion SC28 & SC30, Linen Cushion SC27 & SC28, Linen Bedspread SC31.
Right: Drop Leaf HM6 table | Drawn HM3 & HM4 chair | Flowerpot VP7 pendant
| The Moor AP7 rug | Amore SC50 mirror | Loafer SC23 Velvet 03 Maroon lounge chair





Drawn HM3 chair | Drop Leaf HM6 table. Right: &Tradition Collect Heavy Linen Cushion SC27, SC28 & SC30, Linen Cushion SC27 & SC28, Cotton Throw SC32 & SC33, Linen Bedspread SC31 | Bellevue AJ9 wall lamp | The Moor AP5 rug





Formakami JH5 pendant | Drop Leaf HM6 table | Loafer SC24 Velvet 10 Twilight chair
| Copenhagen SC13 table lamp | &Tradition Collect Planter SC44

Journey SHY1 table lamp





Little Petra VB2 Sheepskin Moonlight sofa | Drop Leaf HM5 lounge table | Tripod HM8 floor lamp | Loafer SC23 Velvet 03 Maroon lounge chair | Lucca SC51 table lamp | Amore SC50 mirror. Right: Formakami JH3 & JH5 pendant | Formakami JH18 table lamp | The Moor AP6 rug | Develius EV1E Ruskin Elk pouf





&Tradition Collect Heavy Linen Cushion SC28, Linen Cushion SC28, Cotton Throw SC33,
Linen Bedspread SC31. Left: BelleVue AJ7 floor lamp | Mezda JH19 side table
| Lucca SC51 table lamp | &Tradition Collect Heavy Linen Cushion SC28, Linen Cushion
SC27 & SC28, Cotton Throw SC33, Linen Bedspread SC31





Pinwheel HM7 lounge table | The Moor AP6 rug

Formakami JH3-JH5 pendant | Formakami JH18 table lamp |
Cloud chair LN1 & LN3.2 Ruskin Elk sofa | Pinwheel HM7 lounge table | The Moor AP6 rug
| & Tradition Collect SC32 Cotton Throw, Linen Cushion SC28



A century of great design

All the Way to Paris
Anderssen & Voll
Andreas Bozarth Fornell
Arne Jacobsen
Arne Jacobsen & Flemming Lassen
Benjamin Hubert
Edward van Vliet
Hee Welling
Hvidt & Mølgaard
Jaime Hayon
John Astbury
Jørn Utzon
Kastholm & Fabricius
Luca Nichetto
Mia Hamborg
Nendo & Luca Nichetto
Norm Architects
Sami Kallio
Samuel Wilkinson
Sebastian Herkner
Signe Hytte
Sofie Refer
Space Copenhagen
Thau & Kallio
Verner Panton
Viggo Boesen



1929



1938



1956



2015



2013



1939



1968

Spanning decades of timeless design icons – from Verner Panton’s norm-breaking Flowerpot lamp first produced in the late 1960s to Arne Jacobsen and Flemming Lassen’s Mayor sofa designed specifically for Søllerød’s city hall located in the outskirts of Copenhagen - &Tradition’s collection of furniture, lighting and interior objects ranges from reissued mid-century classics to contemporary pieces.

Once fought-over by design appreciators at auctions around the world and available to only a handful of people, many of our products - including the Mayor sofa, Viggo Boesen’s Little Petra chair and some of the newly-added Hvidt & Mølgaard designs - are retrieved from original sketches and produced on a large scale for the first time ever.



2013



2018



2020

Alongside such mid-century gems are a number of contemporary pieces, the work of some of today’s most acclaimed international artists: Valencia-based Jaime Hayon, local studio Space Copenhagen, Swedish-raised designer Sami Kallio and Norwegian duo Anderssen & Voll – to name a few.



Hee Welling

An award-winning furniture designer, Hee Welling was raised in the Danish countryside and attended The Royal Danish Academy of Fine Arts before setting up his own Copenhagen studio in the early 2000s. His works, exhibited at multiple fairs and museums, can be found in building interiors around the world, from Oslo's Opera House to Australia's Parliament in Canberra.

Welling's designs are characterised by clean lines and simple silhouettes, and involve a wide array of materials, with wood and metals used alongside non-natural elements like plastic. While decidedly modern, Welling's work draws inspiration from some of Denmark's most renowned designers, including Arne Jacobsen and Hans J. Wegner, and seek to continue their legacy with carefully crafted pieces that prioritize logic.

This year, &Tradition is adding Hee Welling's Patch to the collection: an extendable dining table that melds minimalist form with a user-friendly design and is built out of high-quality wood. In designing the piece, Welling was inspired by the Danish concept of 'umage' – roughly translated as "making a bit more effort," – by ensuring that Patch's design was considered to provide optimal practicality.



Detail of Patch's metal fittings

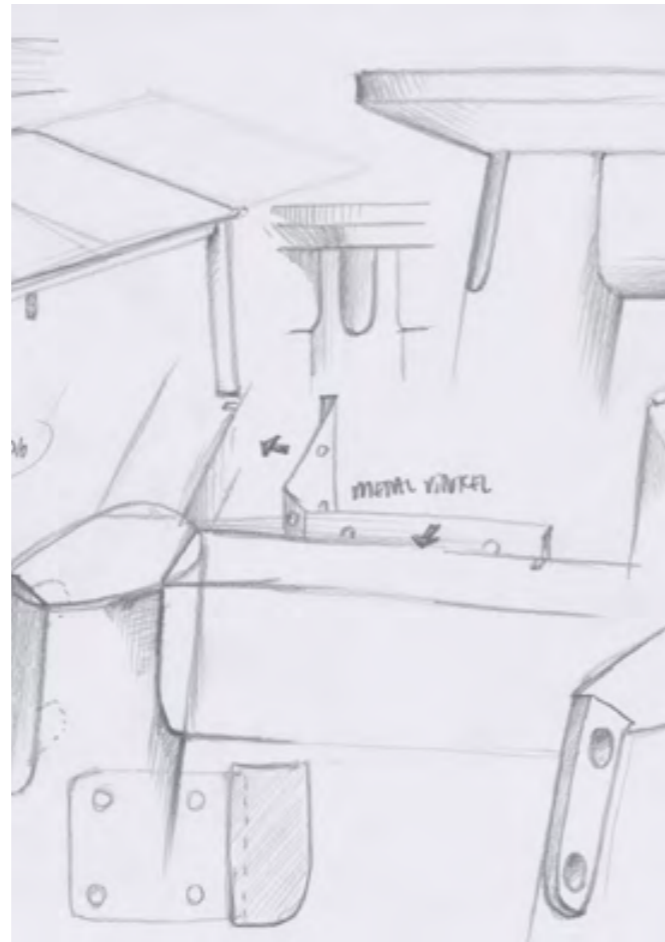

Drawing of Patch table's fittings

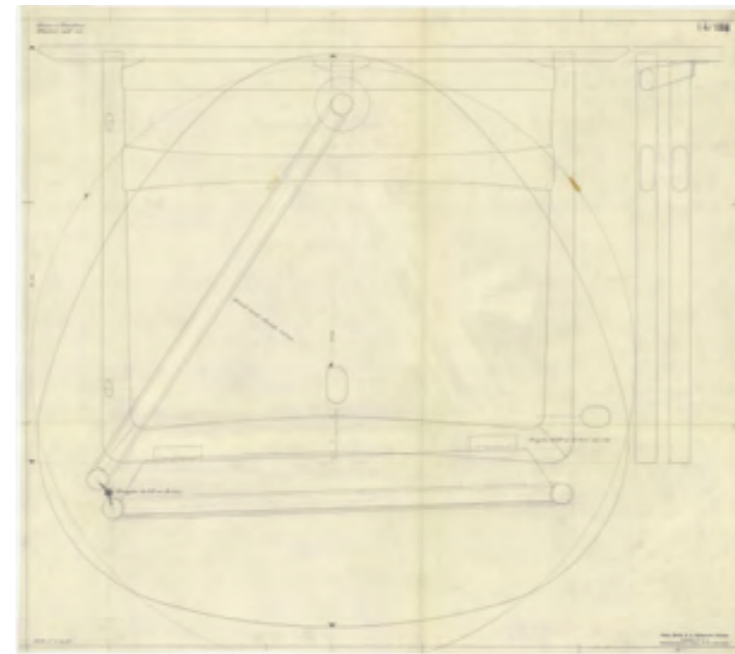

Original drawing of Drop Leaf HM5 lounge table



Original drawing of Vejlefordbroen



Hvidt & Mølgaard

Both Copenhagen natives and passionate furniture designers, Peter Hvidt and Orla Mølgaard Nielsen met while teaching at the Danish School of Arts and Crafts and established their own practice in 1944. Hvidt and Mølgaard's work was a pioneering force in 1950s Danish design and in the advancement of industrialized production of furniture. They introduced products that were easy to produce on a mass scale and were relatively inexpensive to export: their 1944 Portex was the first-ever stackable chair and the 1950 AX collection won international praise.

Throughout their career, the duo's work received significant appreciation, leading to the production of as many as 250 different pieces of furniture and lighting designs and collaborations with important carpenters and firms. Some of their most relevant works are now being reissued by &Tradition, including the elegant Drawn chair, different editions of the Drop Leaf table, and the black sculptural Tripod floor lamp - strictly following and respecting Hvidt and Mølgaard's craftsmanship and design.



Tripod HM8 floor lamp

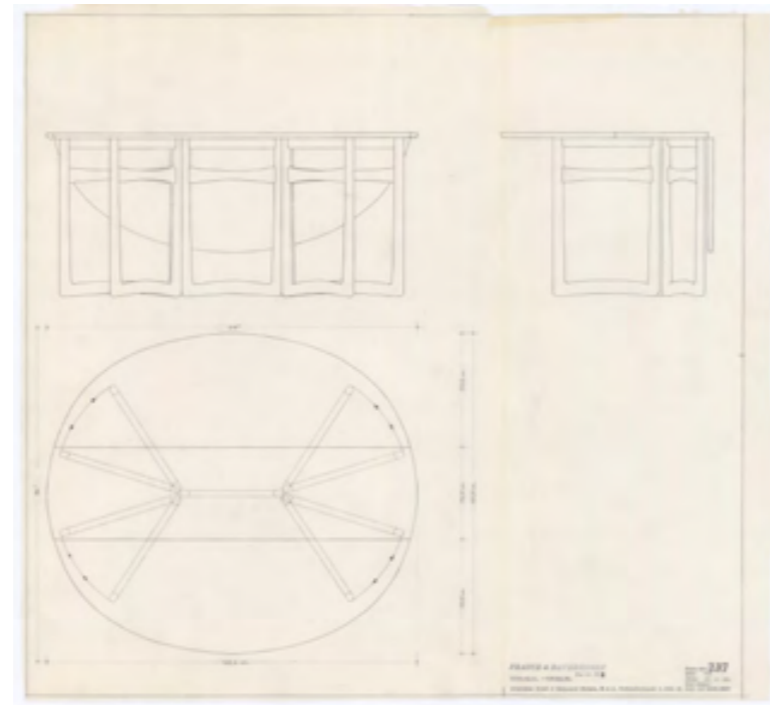

Original drawing, Drop Leaf HM6 dining table

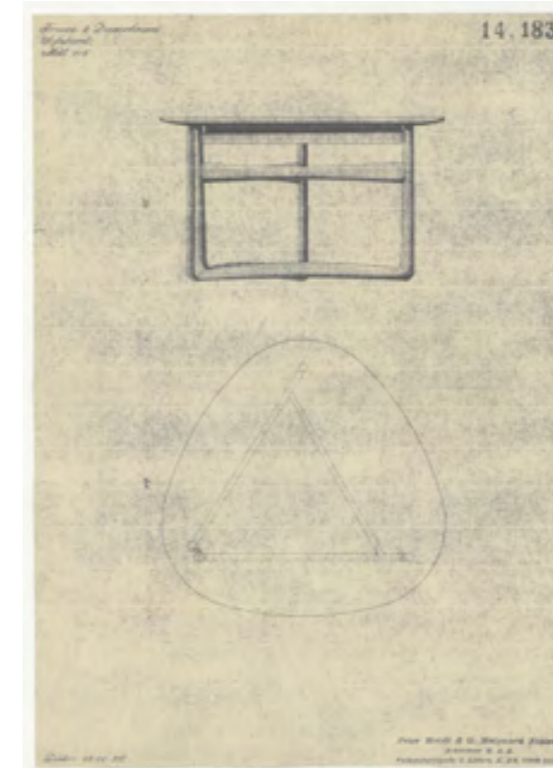

Original drawing, Drop Leaf HM5 lounge table

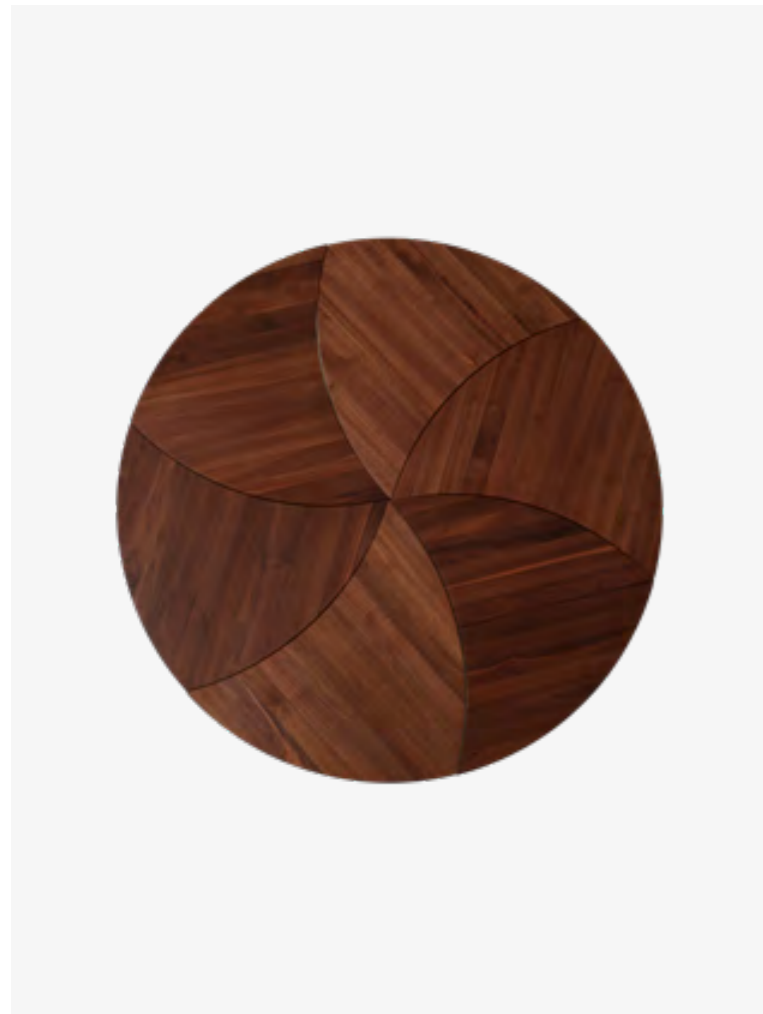

Pinwheel HM7 lounge table



Pinwheel HM7 lounge table

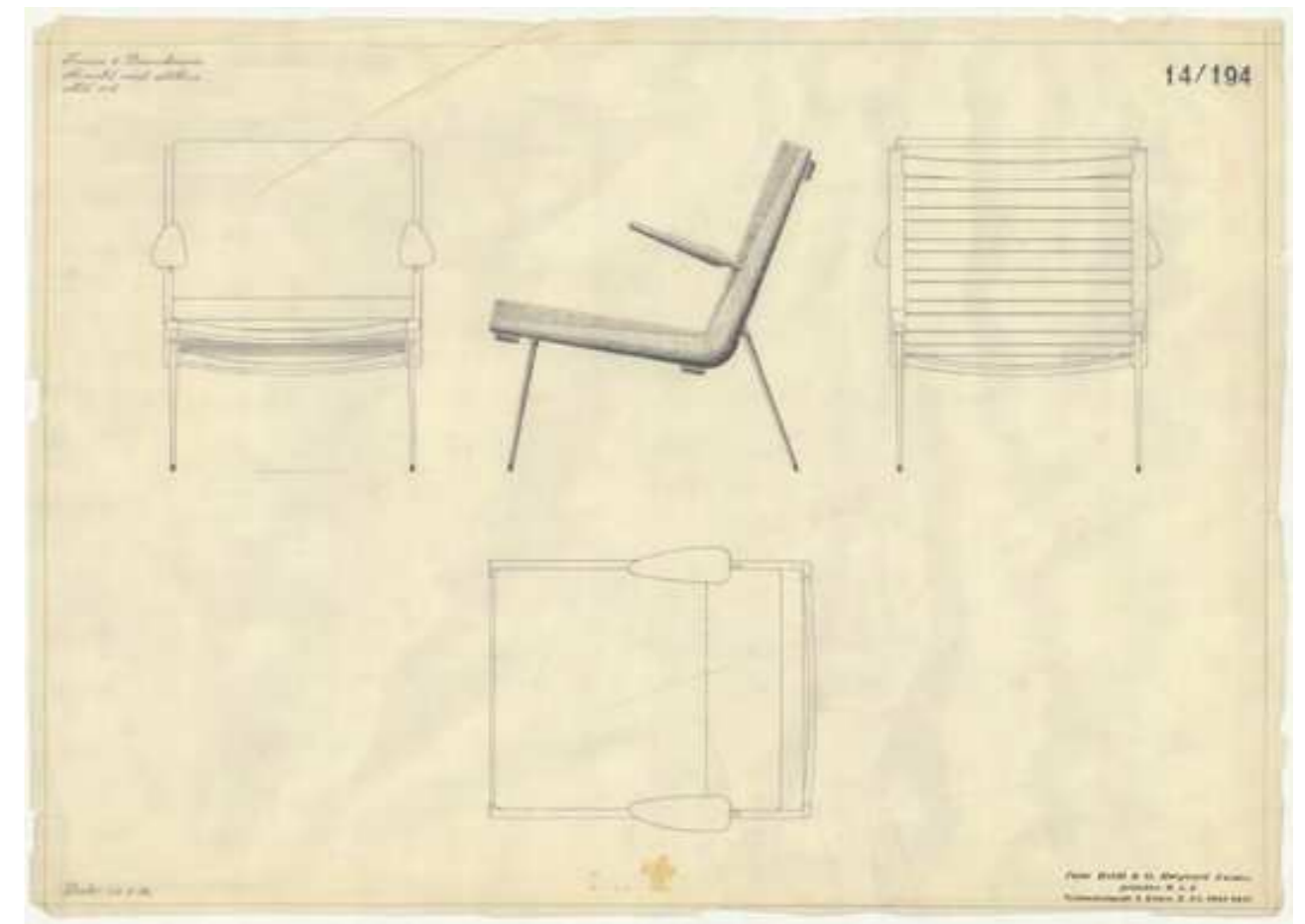

Original drawing, Boomerang HM2 lounge chair



Marianne Panton & Verner Panton



Drawing, Catch JH1 chair



Jaime Hayon

Verner Panton

Verner Panton started out as a painter and went on to study architecture at the Royal Academy of Fine Arts in Copenhagen. Following an apprenticeship with architect and designer Arne Jacobsen, he dedicated his time to furniture and interior design, becoming known for a series of norm-breaking works - including chairs without legs and sofas placed vertically against walls. Throughout the 60s and 70s, his passion for designing environments led to the creation of immersive interiors featuring hypnotic patterns and futuristic-looking furniture, lighting, wallpapers, posters and rugs.

Panton's pioneering use of materials, colours and shapes earned him the reputation as a visionary.

One of his best-known designs, the Flowerpot lamp, was emblematic of the Flower Power peace movement during the 60s and, with its range of vivid colours, it remains an enduring classic. "Verner's intention was to create an interesting new lamp which had never been seen before," recalls the artist's wife Marianne, who had a significant influence on her husband's creative process over the years. "The bright, shiny enamel, and the coloured cable had never been seen in lighting fixtures before."



Flowerpot VP4 table lamp



Klunderbie, 2016: Hayon Studio Valencia

Valencia-born artist and designer Jamie Hayon opened his own studio in 2000 and has designed countless pieces of furniture, lighting fixtures and home accessories, decorating hotel interiors and retail spaces around the world. Hayon is at the forefront of a new wave of talents blurring the lines between art, decoration and design.

Now operating offices in Italy, Spain and Japan, the designer is keen on exploring new and expressive forms, while maintaining a deep respect for artisan skills, finely-crafted details and a passion for play.

"The collaboration with &Tradition has for me always been interesting," says Hayon. "It has been a dialogue on my style and their style, proper collaborative approach and a real exchange of knowledge."



Anderssen & Voll

Based in Oslo, partners Torbjørn Anderssen and Espen Voll have been instrumental in putting Norway on the global design map since joining forces in 2009. Anderssen & Voll have received numerous international awards for their work within furniture, lighting and home accessories, including the Wallpaper* Design Award, the Red Dot and iF Awards.

Rather than feeling defined by and confined to a specific way of being, Anderssen and Voll prefer to be open, by developing emotionally-driven designs. *“We’re not dogmatic about it,”* they say. *“We’re quite open. We start designing and watch a piece take on its own personality. It’s almost like breathing life into it.”*

Among their most relevant projects, the duo designed the graceful and elegant Pavilion chair specifically for Copenhagen’s Langelinie Pavilion, a multi-functional venue housed in an all-glass modernist building. *“We wanted to bridge the old and the new with a curvaceous chair as opposed to the typical rigid lines you often find,”* add Anderssen and Voll. *“With its slim lines flowing through the air, it’s a bit poetic. Almost like a delicate rope that came undone.”*



The Langelinie Pavilion, Copenhagen



Pavilion AV1 chair



The Moor AP5-AP8 rug

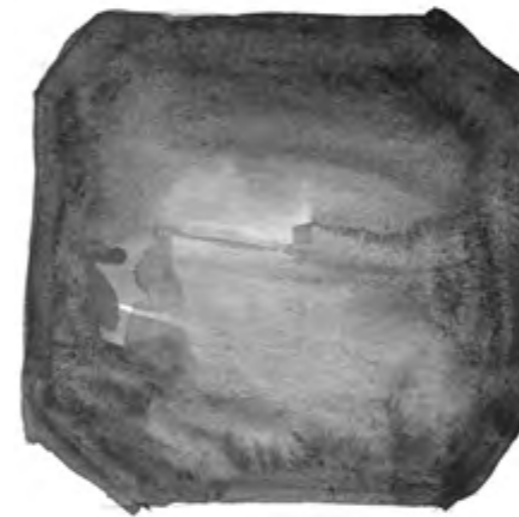

Sketch of The Moor rugs



All the Way to Paris

All the Way to Paris started as a graphic design duo in 2004 and has since evolved into an award-winning group with a passion for pushing boundaries by exploring a broad spectrum of projects within visual communications - from graphic identities, to museum catalogues, exhibition graphics and intriguing design objects.

For founding partners Tanja Vibe and Petra Olsson Gendt, their raison d’être stems from a Scandinavian no-nonsense approach to design, where they continuously seek to eliminate the unnecessary.

With The Moor, a collection of rugs carefully hand-woven with a loom machine through hours of meticulous work, the duo focused on the shape, colour and texture, leaving out patterns and decorative elements. *“For us, a rug brings all the elements of a room together in harmony, creating a feeling of closeness,”* notes Tanja Vibe and Petra Olsson Gendt, Founders and Partners.



Arne Jacobsen

Widely considered as one of the most influential Danish architects and designers to date, Arne Jacobsen defined Modernism with his clean, pure lines, coupled with classic craftsmanship. One of his most celebrated buildings is the 1960 SAS Royal Hotel, where he designed every detail from sculptural furnishings, such as his elegant Swan and Egg chairs to the lighting, textiles, ashtrays and cutlery.

&Tradition's collection includes two of Arne Jacobsen's most early designs; the Bellevue lamp and the Mayor sofa.

Bellevue, with its characteristic slender swan-neck and sculptural figure, reflects Jacobsen's purity and sense of proportions, which he believed was the fundamental factor in design. Originally launched in 1929, the lamp was inspired by Bauhaus and signalled the dawn of Scandinavian minimalism.

The Mayor sofa was designed in the late 1930s together with architect Flemming Larsen specifically for Søllerød's city hall in the outskirts of Copenhagen. With a simple look and a distinguishing stiff-backed shape, the Mayor sofa keeps captivating design lovers today.

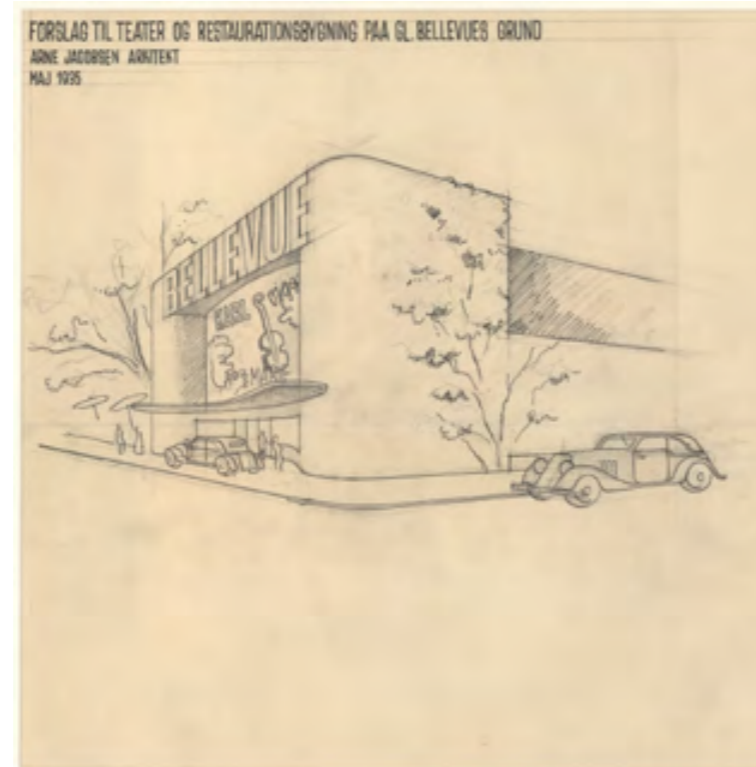

Original drawing, Bellevue Theater

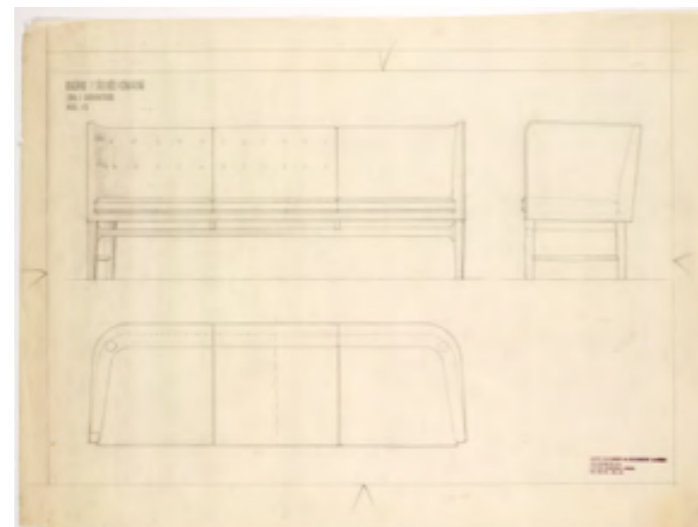

Original drawing, Mayor AJ5 sofa



&Tradition Collect Planter SC43



Drawing, &Tradition Collect Planter SC43-45



Space Copenhagen

Established in 2005 by Signe Bindslev Henriksen and Peter Bundgaard Rützou, Space Copenhagen is a design studio working across multiple disciplines from furniture, lighting and refined objects, to art installations, art direction and interior design for private homes, hotels and restaurants all over the world.

The ambition is to forge new paths by balancing opposites: classic and modern, industrial and organic, sculptural and minimal. The studio's intuitive approach embodies designs that are distinctively shaped by the given circumstances, functional needs, and a fundamental interest in human behaviour. It is a sense of and belief in slow aesthetic that centres quality and longevity.

Among numerous designs for &Tradition, Space Copenhagen is behind &Tradition Collect, an offering of carefully crafted soft furnishings and home objects, ranging from cushions to throws and planters.

CRAFTSMANSHIP

Before entering living rooms, bedrooms and backyards, our products are handcrafted to the finest detail by highly skilled and experienced artisans. From Little Petra's rigorous hand stitching, to mouth-blown lamps with a unique and distinctive look, and handloom woven rugs, each piece carries its own story.

Some of our products are retrieved from original hand-drawn sketches and produced for the first time in decades – the newly-launched collection by Hvidt & Mølgaard, for example - others are newly-designed works by acclaimed contemporary artists. But there is one aspect that both reissued mid-century pieces and today's designs have in common: an enduring reliance on high-quality craftsmanship. Through an extreme and tireless attention to detail, we strive to put out products that are built to last and result from the passion and dedication of skilled craftsmen.

HAND-WOVEN FOR HOURS

First designed by duo Hvidt & Mølgaard in the 1950s, the Drawn chair is a recent addition to the &Tradition collection and is the result of attentive and meticulous hand-weaving techniques. The chair boasts a solid form built out of oak or walnut and its sculptural backrest is produced from a special formpressed and milled oak or walnut veneer.

The chair's comfortable seat is built out of more than 100 meters of unbleached natural paper cord, carefully handwoven through hours of dedicated manual work.



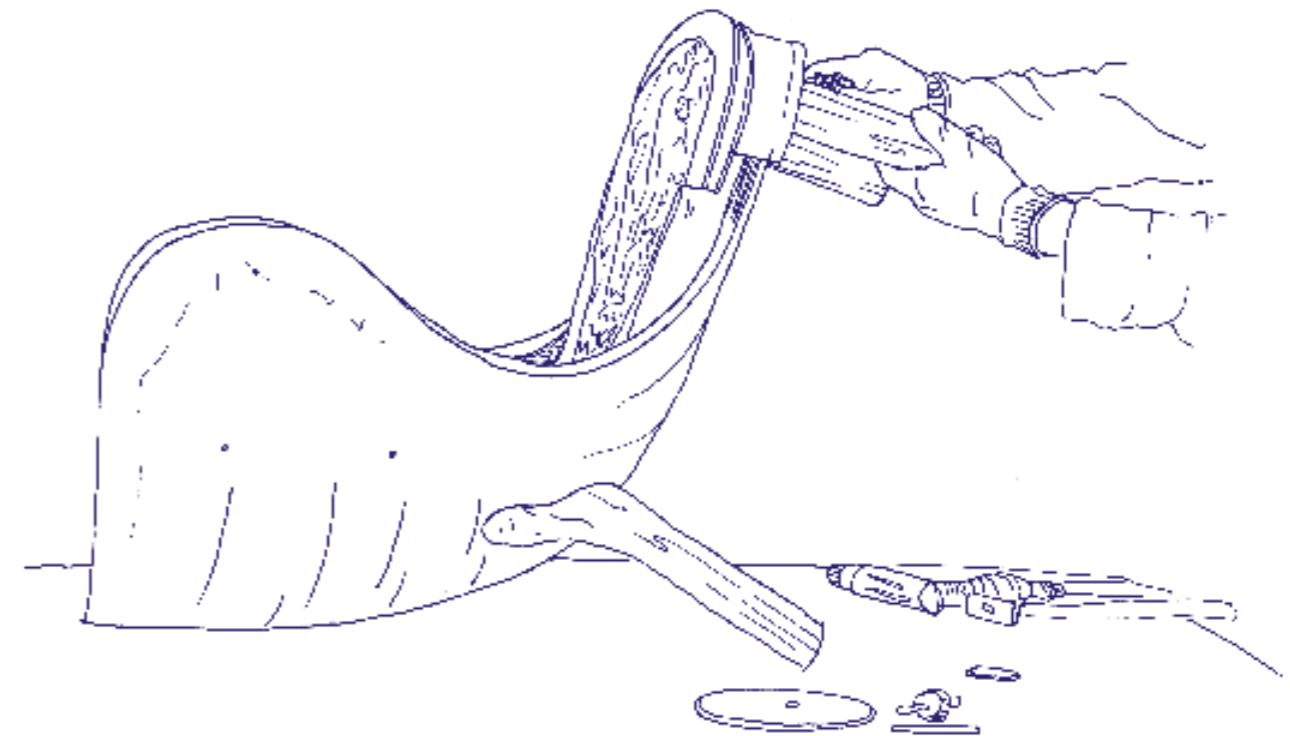
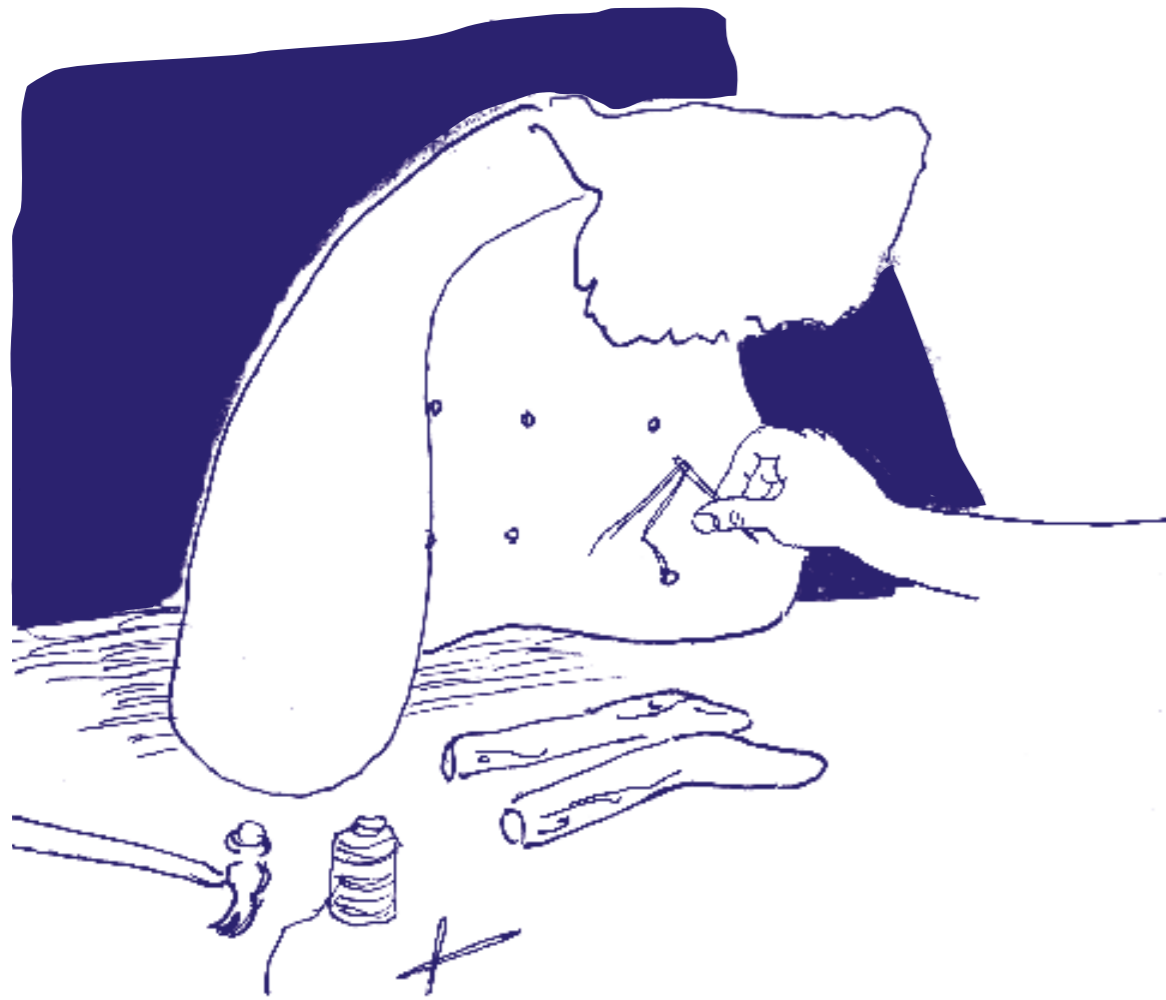

THE CRAFT BEHIND LITTLE PETRA

Viggo Boesen's Little Petra, characterised by its compact size and an open, embracing shape, was first exhibited at Copenhagen's Cabinetmakers Guild Exhibition in 1938. But while its production at the time was limited to a handful of samples, fought over by design-savvy auctioneers around the world, Boesen's quality-focussed craftsmanship endured over the years.

Today, Little Petra's components are carefully crafted and assembled following special techniques. The chair's resistant inner frame and structure, which enables its open, round shape and comfortable seating, is hand built from high quality wood; the short yet sturdy legs are carefully milled into shape from one piece of solid oak or walnut; and the chair's upholstery is attentively cut and stitched – all exclusively done by hand.

HANDSPUN LAMPS

Designed by Arne Jacobsen in 1929, the Bellevue lamp blends early 20th-century Scandinavian minimalism and the functionalism of Bauhaus. The lamp's production respects Jacobsen's rigorous attention to craftsmanship and detail: most notably, Bellevue's distinctive 45-degree cut light shade is built out of a single piece of metal and is hand-spun following traditional spinning techniques.

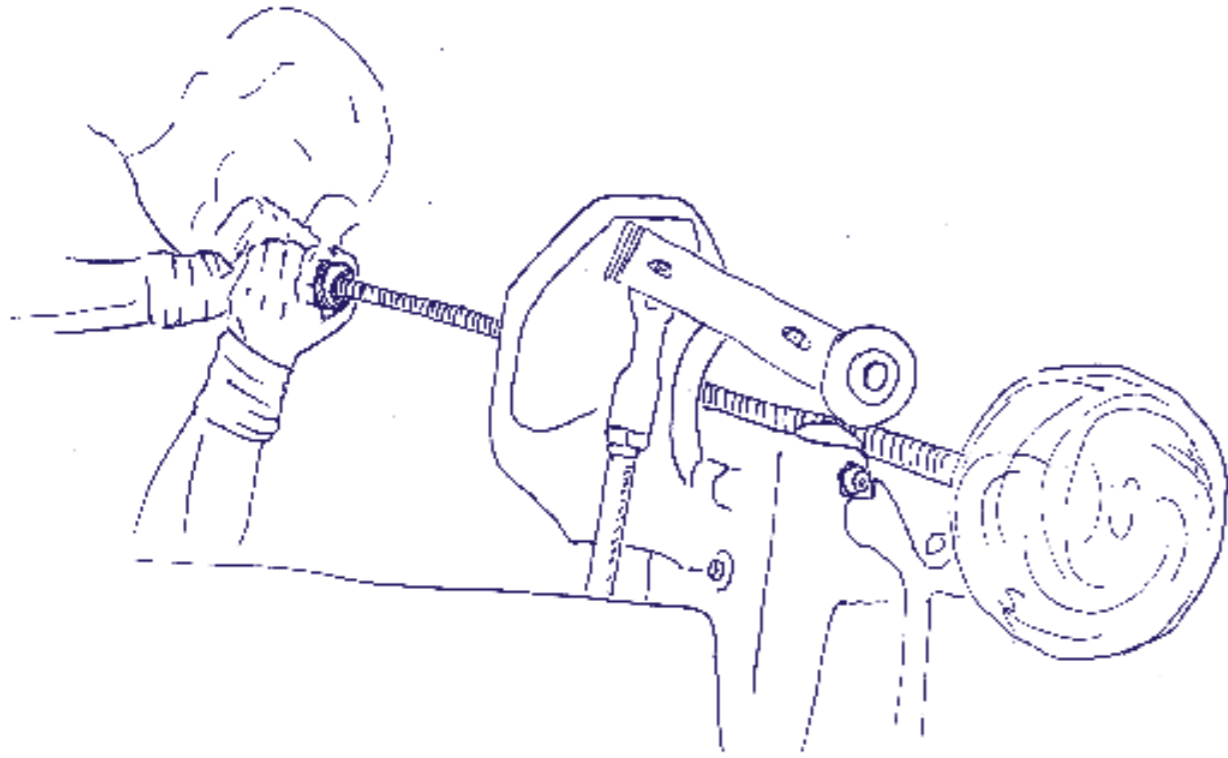

MOUTH-BLOWN GLASS

As the name suggests, Samuel Wilkinson's Blown lamp is made from artisanal mouth-blown glass, meaning that each piece looks unique, and is the work of highly-qualified glass masters. The pendant is attentively blown into a fixed mould that embellishes the glass with a quilted pattern, and one of the variants is decorated with silver tones through a traditional lustre painting technique.

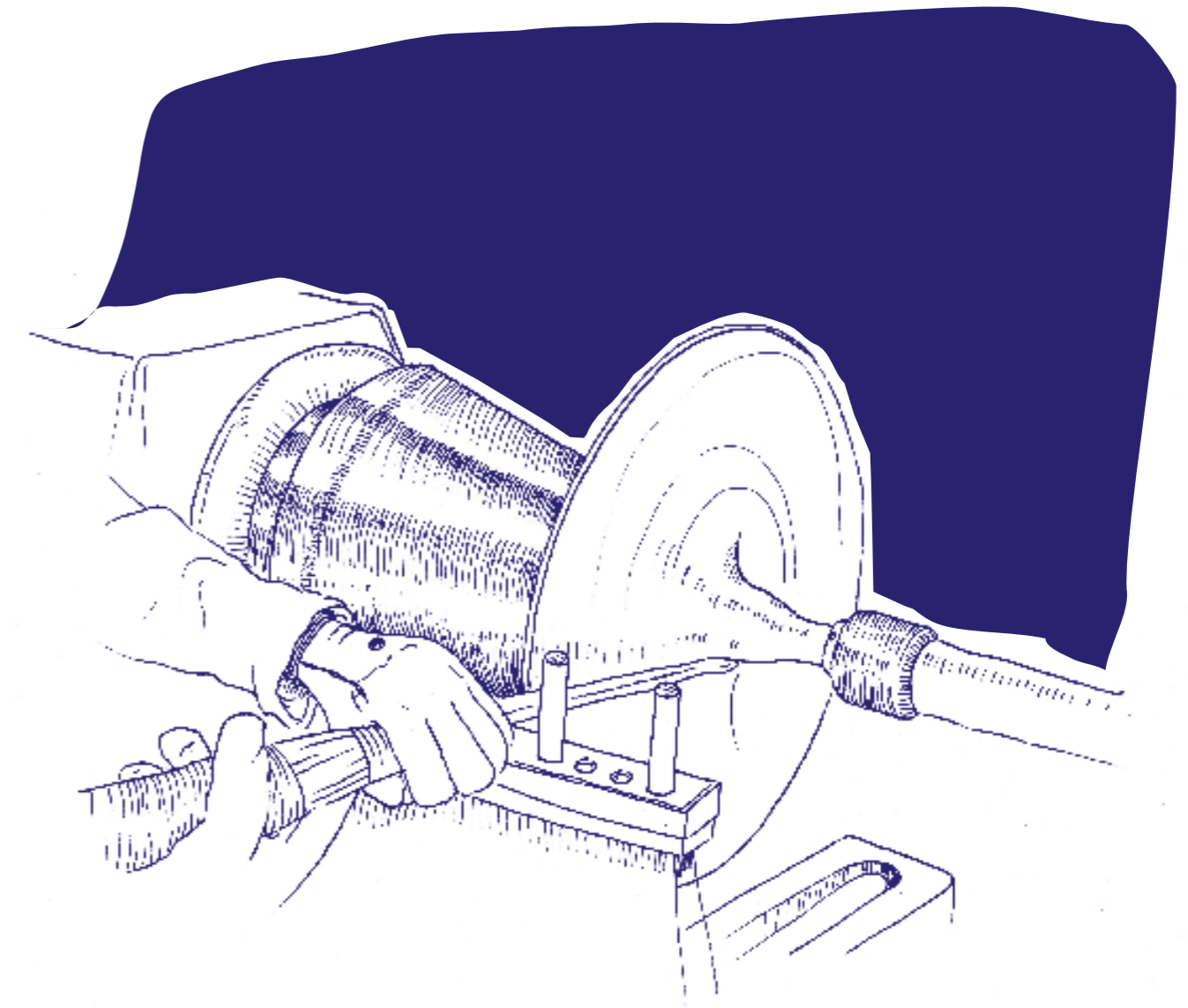

Serago JH27 table lamp





Develius EV1 Ruskin Elk sofa | Boomerang HM1 Karakorun 003 lounge chair | Pinwheel HM7 lounge table | Amore SC49 mirror | Tripod HM8 floor lamp | The Moor AP5 rug | Journey SHY1 table lamp | Mezcla JH19 side table. Right: Eleyf JH34 Ruskin Elk chair | In Between SK5 table | Flowerpot VP3 table lamp | Flowerpot VP7 pendant | &Tradition Collect Planter SC44





Flowerpot VP3 table lamp | In Between SK5 table | Elefy JH34 Ruskin Elk chair

Betty TK1 & TK2 chair | In Between SK4 table | Tripod HM8 floor lamp |
Luca SC51 table lamp





Urzon JU1 pendant | Laro LN8 side table | Betty TK1 chair

Flowerpot VP1 pendant





P376 KF2 pendant | Eleafy JH28 chair | Eleafy JH29 Karakorum 003 chair | In Between SK12 table.
Right: Eleafy JH34 Karandash 006 chair | Flowerpot VP4 table lamp | Palette JH9 desk





Develius EV1 Orion Mineral sofa | Develius EV1 Loop Cream chair | Mezcla JH21 Lounge table
| Drop Leaf HM5 lounge table | Formakami JH18 table lamp | Bellevue AJ7 floor lamp |
The Moor AP5 rug | Little Petra VB1 Sheepskin Moonlight lounge chair. Right: Develius EV1 Orion
Mineral sofa | The Moor AP5 rug

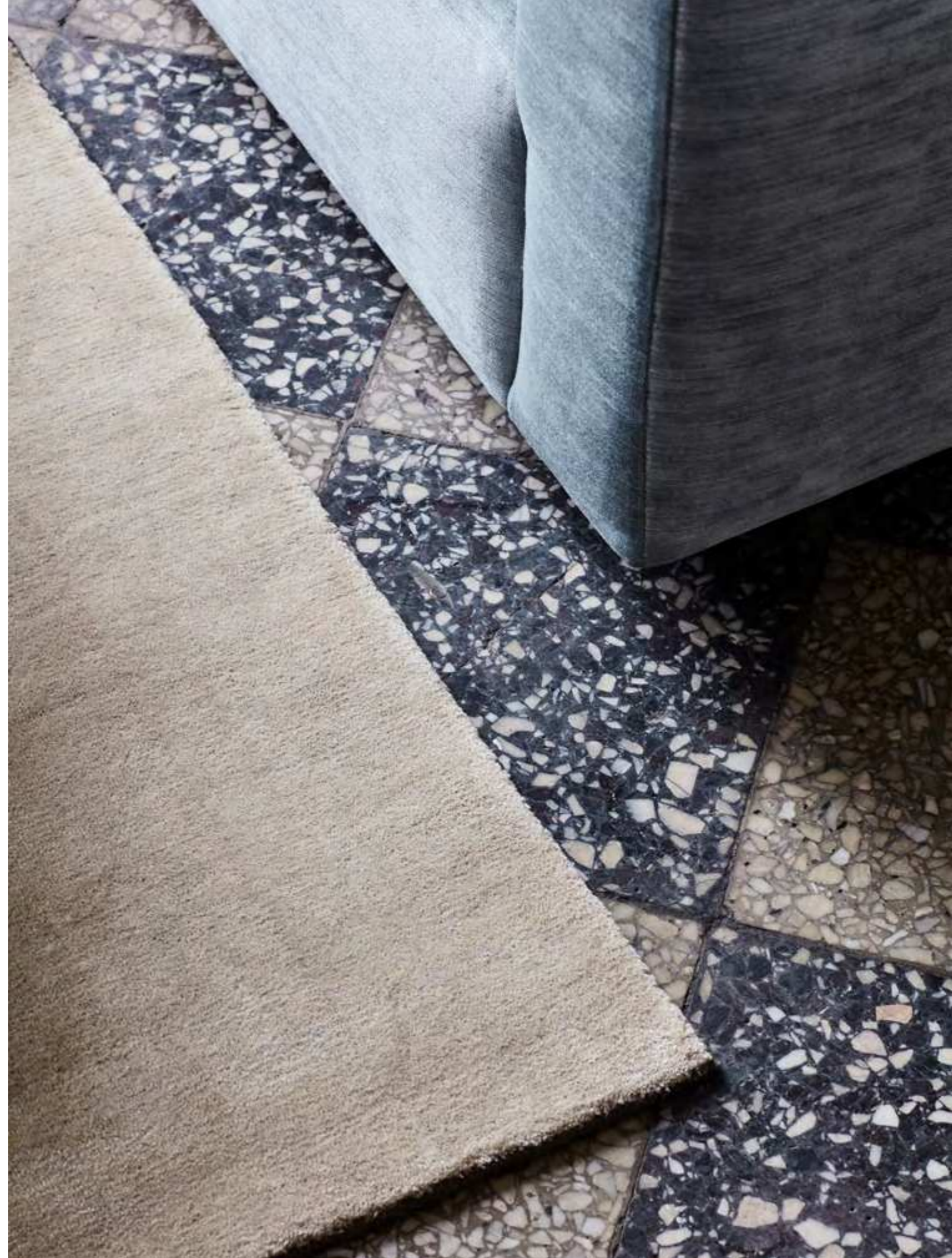

Drawn HM3 & HM4 chair | Mezcla JH22 table |
Mass Light NAG chandelier | &Tradition Collect
Planter SC43 & SC44 | Mezcla JH19 side table |
Lofter SC25 Karakorunum 003 | Lucca SC51 table lamp





Drawn HM4 chair | Lucca SC51 table lamp | Mezcla JH22 table. Right: Lucca SC51 table lamp





Elefy JH34 Karandash 006 chair | Flowerpot VP4 table lamp | Palette JH9 desk

In Between SK1 chair | In Between SK4 table | Lucca SC51 table lamp





Copenhagen SC6 pendant | &Tradition Collect Boucle Cushion SC28, Linen Cushion SC28,
Cotton Throw SC32, Linen Bedspread SC31

Bellevue A18 table lamp | Drop Leaf H1M6 table | Betty TK2 chair





Parch HW2 table. Left: P376 KF2 pendant | Parch HW2 table | Betty TK1 & TK2 chair | Drop Leaf HM6 table | Bellevue A18 table lamp | The Moor AP6 rug





Fly SC12 Orion Elephant sofa | Boomerang HM2 Hallingdal 130 lounge chair | Tripod HM8 floor lamp | Fly SC4 lounge table | Copenhagen SC7 pendant | Sillon SH5 mirror



Boomerang HM2 Hallingdal 130 lounge chair. Right: Little Petra VB2 Sheepskin Sahara sofa | Lato LN8 & LN9 side table | Boomerang HM1 Duke 004 lounge chair | The Moor AP8 rug | Tripod HM8 floor lamp | &Tradition Collect Planter SC44, Cotton Throw SC32 | Formakami JH5 pendant | Loafer SC24
Velvet 10 Twilight chair | Drop Leaf HM6 table | Copenhagen SC13 table lamp





Formakami JH18 table lamp | Drop Leaf HMS lounge table | Develius EV1 Orion Mineral sofa
| The Moor AP5 rug

Drop Leaf HMS lounge table





Right: &Tradition Collect Planter SC43-SC45. Left: Patch HW1 table |
Drawn HM3 & HM4 chair | Betty TK2 chair | Copenhagen SC7 pendant | &Tradition Collect
Planter SC44 & SC45 | Amore SC49 mirror | Loafer SC23 Velvet 03 Maroon lounge chair





Topan VD6 pendant. Right: Formakami JH5 pendant | In Between SK4 table
| Elefy JH30 chair





Copenhagen SC15 desk lamp

P376 KF2 pendant | Drop Leaf HM6 table | Eleafy JH31 Ruskin Elk chair
| Flowerpot VP3 table lamp | Sillon SH4 mirror





Right: Formakami JH3 & JH5 pendant | Fly SC10 Chelsea Jute lounge chair
| Sillon SH5 mirror | Fly SC4 lounge table | Flowerpot VP3 table lamp. Left: Journey SHY2
wall lamp | Lato LN8 side table





In Between SK6 table | In Between SK2 Fiord 251 chair | Flowerpot VP7 pendant
Right: Mezcla JH22 table | Loafer SC24 Vidar 972 chair





Lucca SC51 table lamp

Boomerang HM2 Karakorum 003 lounge chair | Tripod HM8 floor lamp |
Lato LN8 side table



Night watches calmly with her starry eyes
All tremulous with love

– Albert Lighton

Photographer Casper Sejersen
Art Direction All the Way to Paris



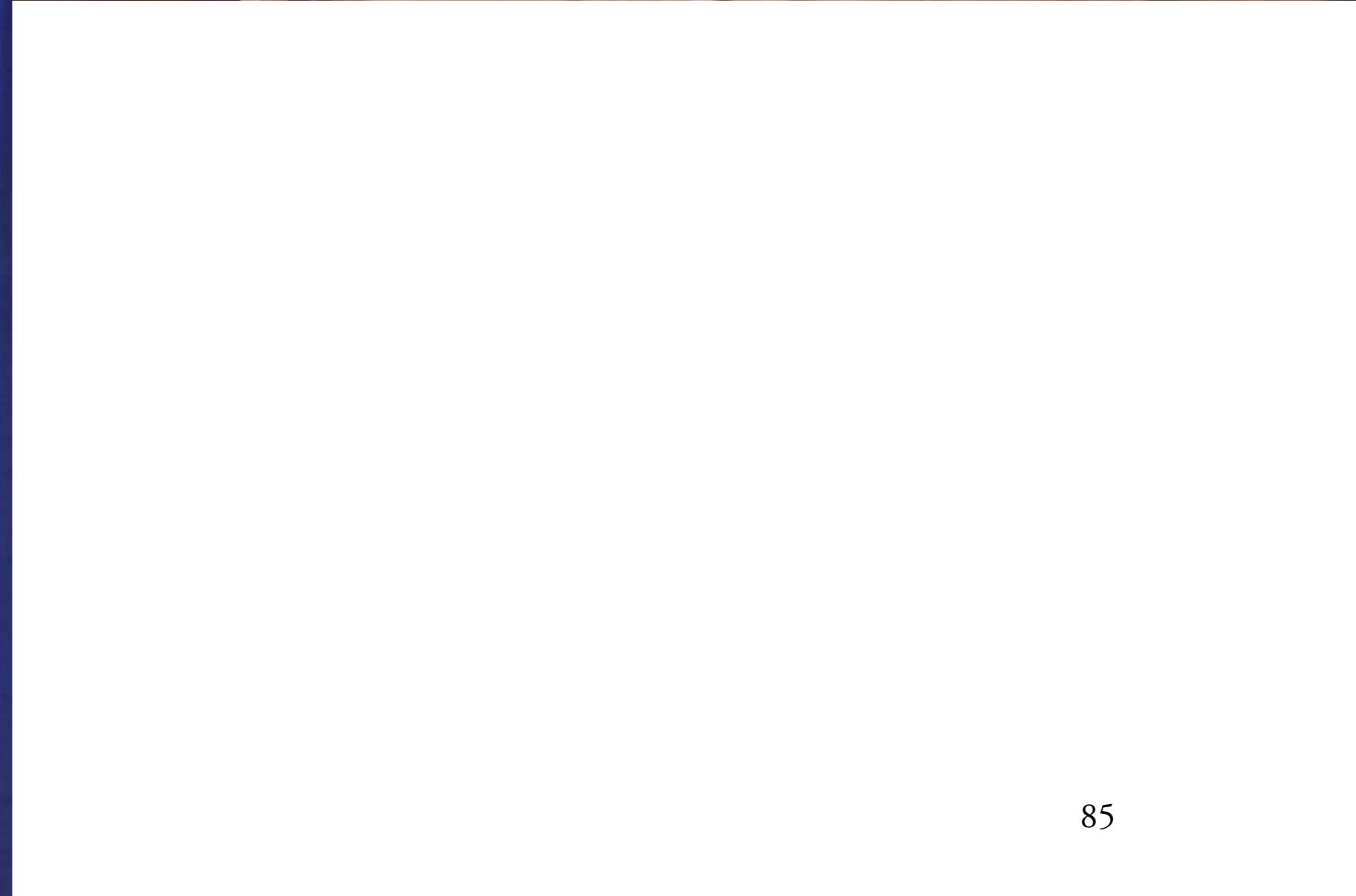













&Tradition showrooms



COPENHAGEN
Kronprinsesgade 4
DK-1106 København
+45 39 20 02 33



AMSTERDAM
Aalsmeerderdijk 640
1435 BW Rijsenhout
Netherlands
+31 29 73 74 747



ANTWERP
Hofstraat 24
BE-2000 Antwerp
Belgium
+32 47 07 84 138

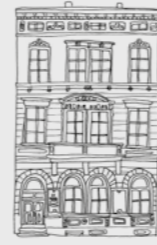

DÜSSELDORF
Fürstenwall 65
DE-40219 Düsseldorf
Germany
+49 17 24 82 12 19



GOTHENBURG
Drottninggatan 13
411 14 Gothenburg
Sweden
+46 84 10 32 502



HELSINKI
Eteläranta 14
00130 Helsinki
Finland
+35 85 05 02 02 75



LONDON
34 Queen Anne's Gate
SW1H 9AB London
United Kingdom
+44 73 78 77 33 30



MÁLAGA
C/Argelia 2
29140 Málaga
Spain
+34 67 00 66 296



MALMÖ
Slussgatan 10
211 30 Malmö
Sweden
+46 84 10 32 502



OSLO
Parkveien 41B
NO 0250, Oslo
Norway
+47 47 61 15 13



PARIS
3, Avenue du Président Wilson
75016 Paris
France
+33 07 85 40 99 84

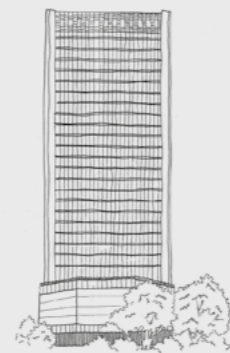

SHANGHAI
F14 No.100 East Yan An Road
Shanghai
China
+86 13 81 72 50 436



STOCKHOLM
Rosenlundsgatan 38
118 53 Stockholm
Sweden
+46 84 10 32 502

The Collection

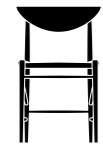

Chairs

From dining and lounge to counter and bar chairs the collection is available in a variety of different styles, colours and upholstery.



Catch JH1 ■ ■ ■

Design Jaime Hayon | 2013
Category Chair
Materials Molded PU foam, CMHR foam, oak legs, fabric or leather upholstery.
MTO Available in fabrics, leathers and as COM with White oiled, Smoked oiled, or Black lacquered solid oak legs.
(6-8 weeks)

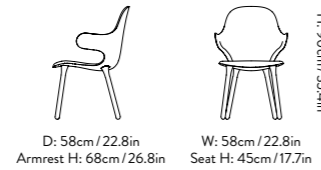

D: 58cm / 22.8in
Armrest H: 68cm / 26.8in
W: 58cm / 22.8in
Seat H: 45cm / 17.7in
H: 90cm / 35.4in



Catch JH2 ■ ■

Design Jaime Hayon | 2013
Category Chair
Materials Molded PU foam, CMHR foam, aluminium swivel base, fabric or leather upholstery.
MTO Available in fabrics, leathers and as COM with Polished or Black powder coated aluminium swivel base.
(6-8 weeks)

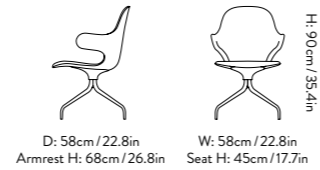

D: 58cm / 22.8in
Armrest H: 68cm / 26.8in
W: 58cm / 22.8in
Seat H: 45cm / 17.7in
H: 90cm / 35.4in

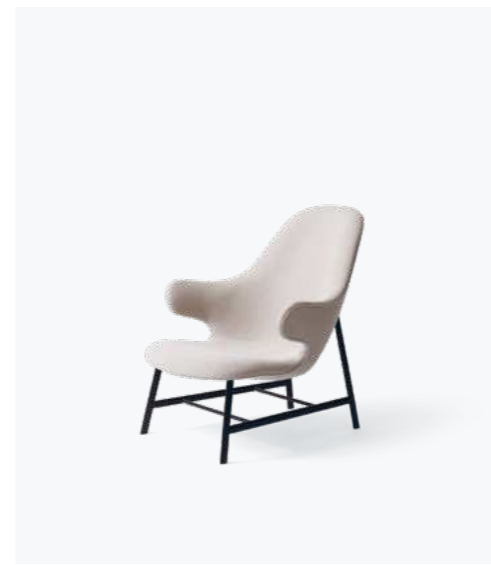

Catch JH13

Design Jaime Hayon | 2017
Category Lounge chair
Materials Molded PU foam, CMHR foam, steel base, fabric.
MTO Available in fabrics, leathers and COM with warm black powder coated base.
(6-8 weeks)

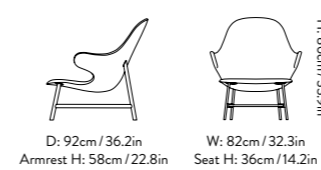

D: 92cm / 36.2in
Armrest H: 58cm / 22.8in
W: 82cm / 32.3in
Seat H: 36cm / 14.2in
H: 86cm / 33.9in

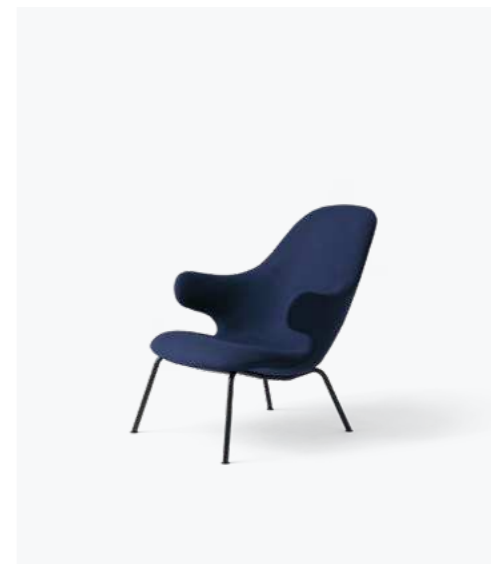

Catch JH14

Design Jaime Hayon | 2017
Category Lounge chair
Materials Molded PU foam, CMHR foam, steel base, fabric.
MTO Available in fabrics, leathers and COM with warm black powder coated base.
(6-8 weeks)

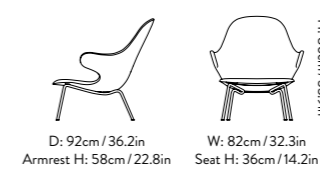

D: 92cm / 36.2in
Armrest H: 58cm / 22.8in
W: 82cm / 32.3in
Seat H: 36cm / 14.2in
H: 86cm / 33.9in



Elefy JH28 ■ ■ ■ ■

Design Jaime Hayon | 2019
Category Chair
Materials Polypropylene, black powder coated steel or brass legs.
Stock White with White or Brass legs, Black, Midnight blue, Soft beige & Copper brown with Black or Brass legs.

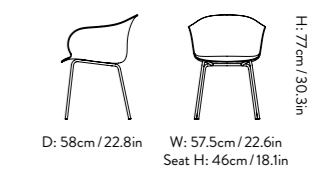

D: 58cm / 22.8in
W: 57.5cm / 22.6in
Seat H: 46cm / 18.1in
H: 77cm / 30.3in

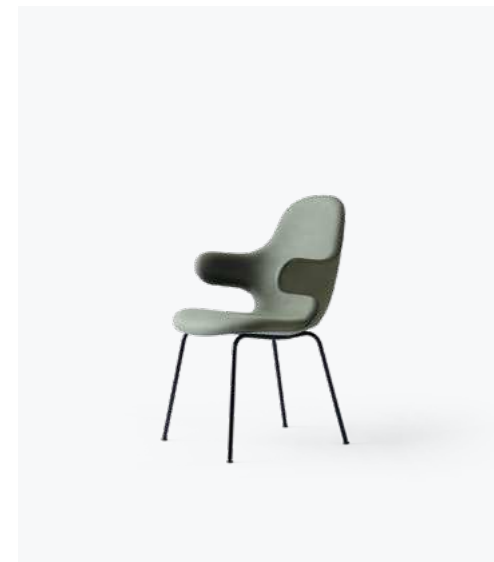

Catch JH15

Design Jaime Hayon | 2017
Category Chair
Materials Molded PU foam, CMHR foam, steel tube base, fabric or leather upholstery.
MTO Available in fabrics, leathers and as COM with black powder coated tube base.
(6-8 weeks)

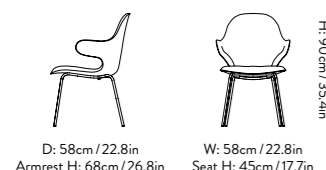

D: 58cm / 22.8in
Armrest H: 68cm / 26.8in
W: 58cm / 22.8in
Seat H: 45cm / 17.7in
H: 90cm / 35.4in



Catch JH16

Design Jaime Hayon | 2017
Category Counter chair
Materials Molded PU foam, CMHR foam, steel tube base, fabric or leather upholstery.
MTO Available in fabrics, leathers and as COM with black powder coated tube base.
(6-8 weeks)



D: 63cm / 24.8in, W 58cm / 22.8in
Armrest H: 88 cm / 34.6 in
H: 107 cm / 42.1in
Seat H: 66cm / 26in



Catch JH17

Design Jaime Hayon | 2017
Category Bar chair
Materials Molded PU foam, CMHR foam, steel tube base, fabric or leather upholstery.
MTO Available in fabrics, leathers and as COM with black powder coated tube base.
(6-8 weeks)

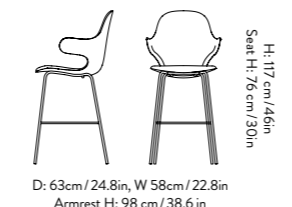

D: 63cm / 24.8in, W 58cm / 22.8in
Armrest H: 98 cm / 38.6 in
H: 117 cm / 46in
Seat H: 76 cm / 30in

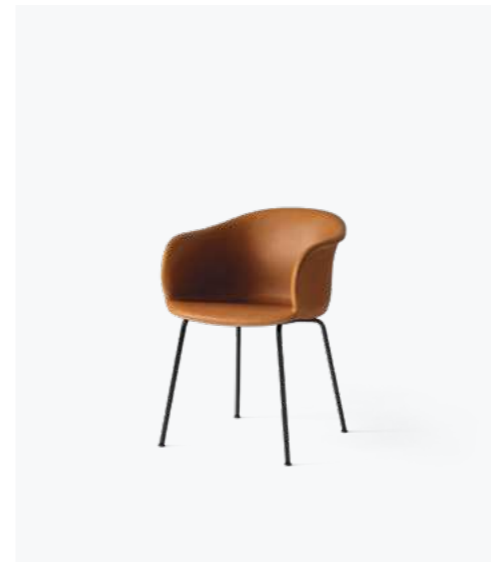

Elefy JH29 ■ ■

Design Jaime Hayon | 2019
Category Chair
Materials Polypropylene, HR foam, fabric or leather upholstery, black powder coated steel or brass legs.
Stock Cognac silk leather & Black silk leather with Black legs.
MTO Available in fabrics, leathers and as COM.
(6-8 weeks)

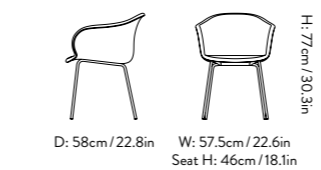

D: 58cm / 22.8in
W: 57.5cm / 22.6in
Seat H: 46cm / 18.1in
H: 77cm / 30.3in



Elefy JH30 ■ ■ ■ ■

Design Jaime Hayon | 2019
Category Chair
Materials Polypropylene, lacquered oak, black lacquered oak or lacquered walnut.
Stock White, Black, Midnight blue, Soft beige & Copper brown with Oak or Walnut legs.

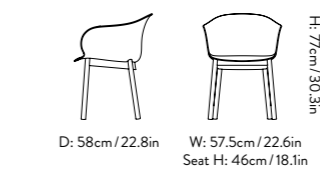

D: 58cm / 22.8in
W: 57.5cm / 22.6in
Seat H: 46cm / 18.1in
H: 77cm / 30.3in



Elefy JH31 ■ ■ ■ ■

Design Jaime Hayon | 2019
Category Chair
Materials Polypropylene, HR foam, fabric or leather upholstery, lacquered oak, black lacquered oak or lacquered walnut.
Stock Cognac silk leather with Oak legs, Cognac silk leather & Black silk leather with Walnut legs.
MTO Available in fabrics, leathers and as COM.
(6-8 weeks)

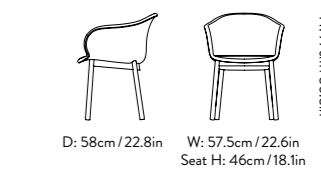

D: 58cm / 22.8in
W: 57.5cm / 22.6in
Seat H: 46cm / 18.1in
H: 77cm / 30.3in



Elefy JH32 & JH34



Design Jaime Hayon | 2020
Category Chair
Materials Polypropylene and aluminium base. JH34 has a swivel base with return function.
MTO White, Black, Midnight blue, Soft beige & Copper brown Black, White or Polished aluminium legs.
(6-8 weeks)

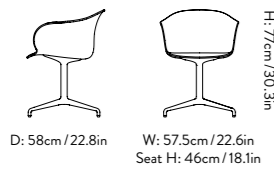

D: 58cm / 22.8in
W: 57.5cm / 22.6in
Seat H: 46cm / 18.1in
H: 77cm / 30.3in

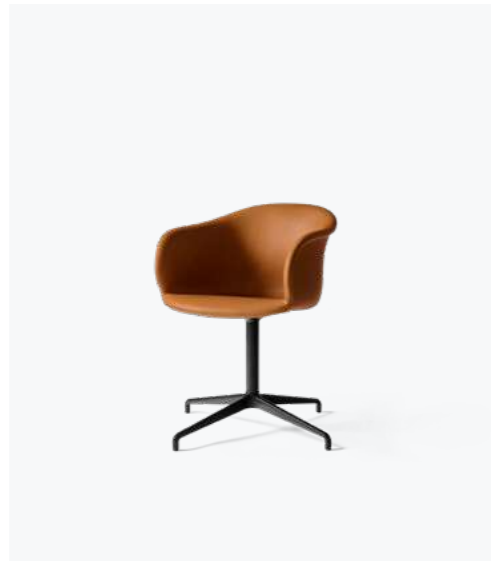

Elefy JH33 & JH35

Design Jaime Hayon | 2020
Category Chair
Materials Polypropylene, HR foam, aluminium base, fabric or leather upholstery. JH35 has a swivel base with return function.
MTO Available in fabrics, leathers and as COM with Black, White or Polished aluminium legs.
(6-8 weeks)



D: 58cm / 22.8in
W: 57.5cm / 22.6in
Seat H: 46cm / 18.1in
H: 77cm / 30.3in



Elefy JH36



Design Jaime Hayon | 2020
Category Chair
Materials Polypropylene and aluminium base with matching castors.
MTO White, Black, Midnight blue, Soft beige & Copper brown Black, White or Polished aluminium legs.
(6-8 weeks)

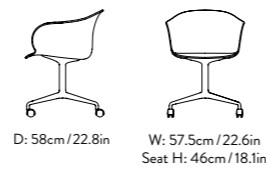

D: 58cm / 22.8in
W: 57.5cm / 22.6in
Seat H: 46cm / 18.1in
H: 77cm / 30.3in



In Between SK1



Design Sami Kallio | 2013
Category Chair
Materials Solid wood and formpressed wood veneer.
Stock White oiled oak, Smoked oiled oak, Black lacquered oak, Oiled walnut.

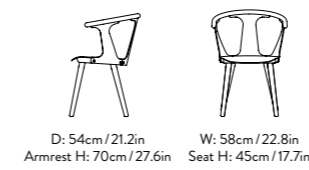

D: 54cm / 21.2in
Armrest H: 70cm / 27.6in
W: 58cm / 22.8in
Seat H: 45cm / 17.7in
H: 77cm / 30.3in



In Between SK2

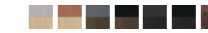

Design Sami Kallio | 2013
Category Chair
Materials Solid wood, formpressed veneer and CMHR foam, fabric or leather upholstery.
Stock White oiled oak w. Fiord 251 or Cognac silk leather, Smoked oiled oak w. Fiord 171 or Black silk leather, Black lacquered oak with Fiord 191 or Black silk leather, Walnut with Black silk leather.
MTO Available in fabrics, leathers and COM with White oiled, Smoked oiled, Black lacquered oak or Oiled walnut.
(6-8 weeks)

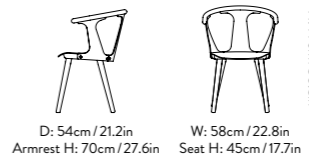

D: 54cm / 21.2in
Armrest H: 70cm / 27.6in
W: 58cm / 22.8in
Seat H: 45cm / 17.7in
H: 77cm / 30.3in



In Between SK7



Design Sami Kallio | 2017
Category Counter chair
Materials Solid oak and formpressed oak veneer.
Stock White oiled oak, Smoked oiled oak, Black lacquered oak.

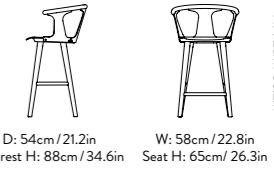

D: 54cm / 21.2in
Armrest H: 88cm / 34.6in
W: 58cm / 22.8in
Seat H: 65cm / 26.3in
H: 92cm / 36.2in



Elefy JH37

Design Jaime Hayon | 2020
Category Chair
Materials Polypropylene and aluminium base with matching castors.
MTO Available in fabrics, leathers and as COM with Black, White or Polished aluminium legs.
(6-8 weeks)

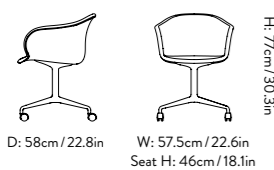

D: 58cm / 22.8in
W: 57.5cm / 22.6in
Seat H: 46cm / 18.1in
H: 77cm / 30.3in



Drawn HM3



Design Hvidt & Mølgaard | 1956
Category Chair
Materials Solid wood, formpressed wood veneer & paper cord.
Stock White oiled oak or Oiled walnut with natural paper cord.

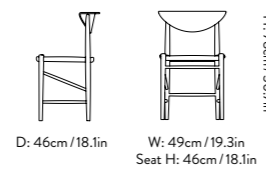

D: 46cm / 18.1in
W: 49cm / 19.3in
Seat H: 46cm / 18.1in
H: 78cm / 30.7in

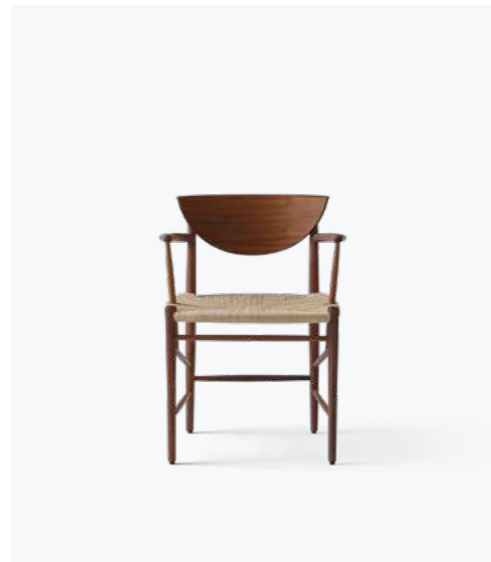

Drawn HM4



Design Hvidt & Mølgaard | 1956
Category Chair
Materials Solid wood, formpressed wood veneer & paper cord.
Stock White oiled oak or Oiled walnut with natural paper cord.

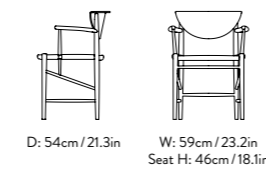

D: 54cm / 21.3in
W: 59cm / 23.2in
Seat H: 46cm / 18.1in
H: 78cm / 30.7in

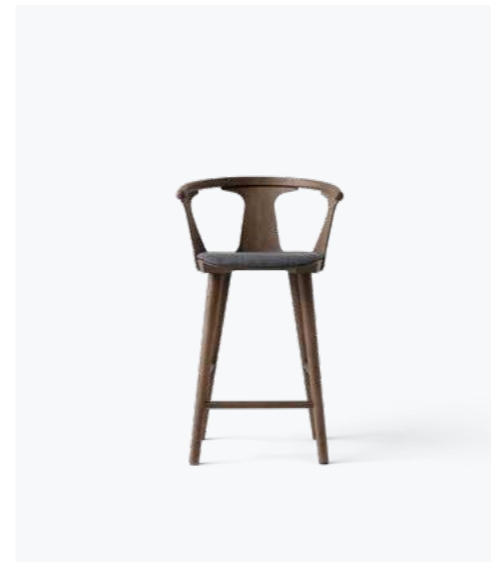

In Between SK8



Design Sami Kallio | 2017
Category Counter chair
Materials Solid wood, formpressed veneer and CMHR foam, fabric or leather upholstery.
MTO Available in fabrics, leathers and COM with White oiled oak, Smoked oiled oak or Black lacquered oak.
(6-8 weeks)

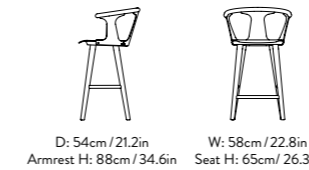

D: 54cm / 21.2in
Armrest H: 88cm / 34.6in
W: 58cm / 22.8in
Seat H: 65cm / 26.3in
H: 92cm / 36.2in



In Between SK9



Design Sami Kallio | 2017
Category Bar chair
Materials Solid oak and formpressed oak veneer.
Stock White oiled oak, Smoked oiled oak, Black lacquered oak.

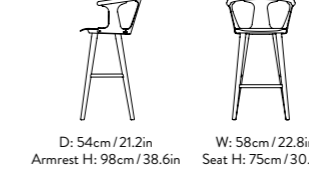

D: 54cm / 21.2in
Armrest H: 98cm / 38.6in
W: 58cm / 22.8in
Seat H: 75cm / 30.2in
H: 102cm / 40.2in



In Between SK10



Design Sami Kallio | 2017
Category Bar chair
Materials Solid wood, formpressed veneer and CMHR foam, fabric or leather upholstery.
MTO Available in fabrics, leathers and COM with White oiled oak, Smoked oiled oak or Black lacquered oak.
(6-8 weeks)

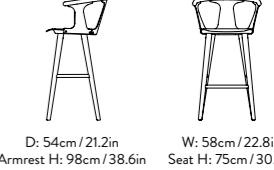

D: 54cm / 21.2in
Armrest H: 98cm / 38.6in
W: 58cm / 22.8in
Seat H: 75cm / 30.2in
H: 102cm / 40.2in



Pavilion AV1 ■■■

Design Anderssen & Voll | 2018
Category Stackable chair
Materials Steel tubes and formpressed veneer. Brass fittings for the front side of the back rest available upon request.
Stock Lacquered oak, Lacquered walnut or Black lacquered oak.

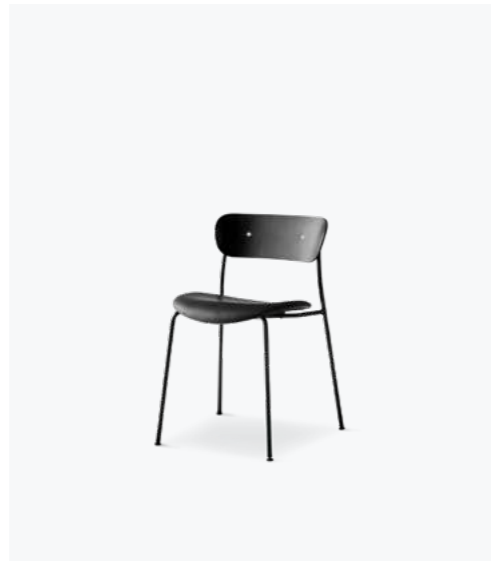
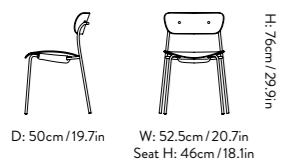

Pavilion AV3 ■■■

Design Anderssen & Voll | 2018
Category Stackable chair
Materials Steel tubes and formpressed veneer, CMHR foam, fabric or leather seat upholstery. Brass fittings for the front side of the back rest available upon request.
MTO (6-8 weeks) All fabrics, leathers and COM available for seat upholstery with Lacquered oak, Lacquered walnut or Black lacquered oak back.

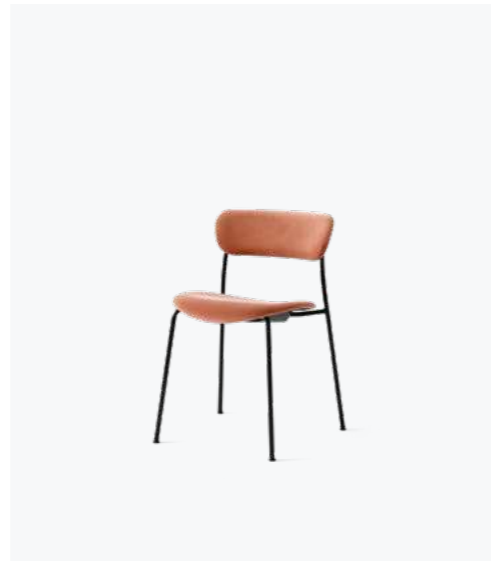
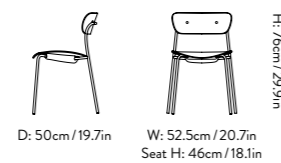

Pavilion AV12 ■■■

Design Anderssen & Voll | 2018
Category Stackable chair
Materials Steel tubes, formpressed veneer, CMHR foam, fabric upholstery.
MTO (6-8 weeks) Available in various fabrics and COM.

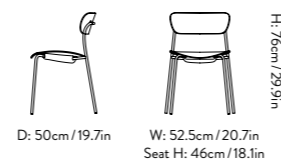

Pavilion AV5 ■■■

Design Anderssen & Voll | 2018
Category Lounge chair
Materials Steel tubes and formpressed veneer. Brass fittings for the front side of the back rest available upon request.
Stock Lacquered oak, Lacquered walnut or Black lacquered oak.

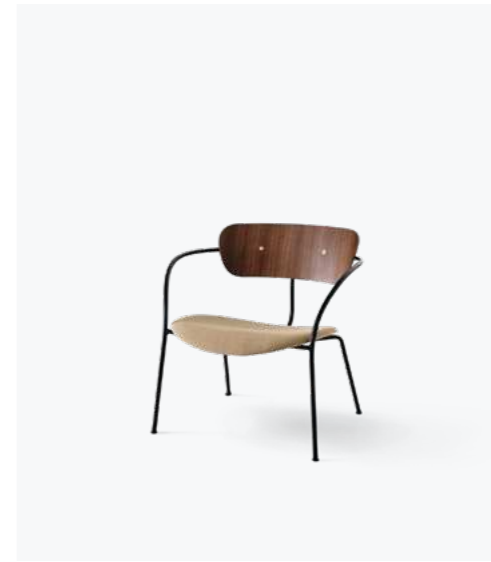
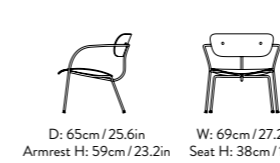

Pavilion AV6 ■■■

Design Anderssen & Voll | 2018
Category Lounge chair
Materials Steel tubes, formpressed veneer, CMHR foam, fabric or leather seat upholstery.
Stock Black oak & Canvas 174 w. black fittings, Black oak & Black silk leather w. black or brass fittings, Walnut & Canvas 174 w. black fittings, Walnut & Vidar 333 w. brass fittings, Walnut & Cognac Silk leather w. brass fittings.
MTO (6-8 weeks) Available in fabrics, leathers and COM with Lac. Oak, Black lacquered oak or Lacquered walnut.

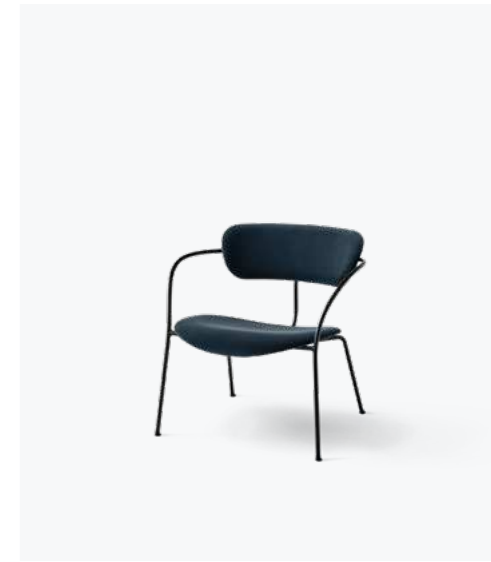
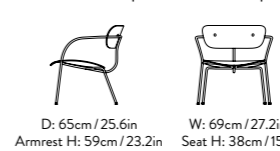

Pavilion AV11 ■■■

Design Anderssen & Voll | 2018
Category Lounge chair
Materials Steel tubes, formpressed veneer, CMHR foam, fabric seat upholstery.
MTO (6-8 weeks) Available in various fabrics and COM.



Pavilion AV2 ■■■

Design Anderssen & Voll | 2018
Category Stackable chair with armrests
Materials Steel tubes and formpressed veneer. Brass fittings for the front side of the back rest available upon request.
Stock Lacquered oak, Lacquered walnut or Black lacquered oak.

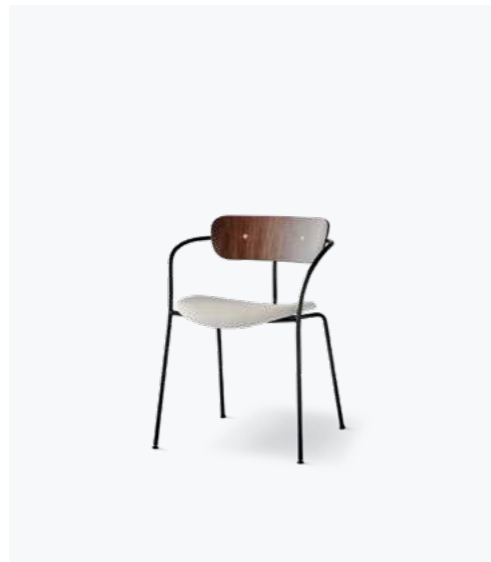
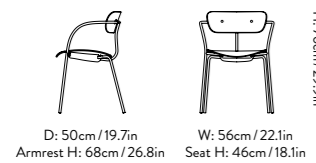

Pavilion AV4 ■■■

Design Anderssen & Voll | 2018
Category Stackable chair with armrests
Materials Steel tubes and formpressed veneer, CMHR foam, fabric or leather seat upholstery. Brass fittings for the front side of the back rest available upon request.
MTO (6-8 weeks) All fabrics, leathers and COM available for seat upholstery with Lacquered oak, Lacquered walnut or Black lacquered oak back.

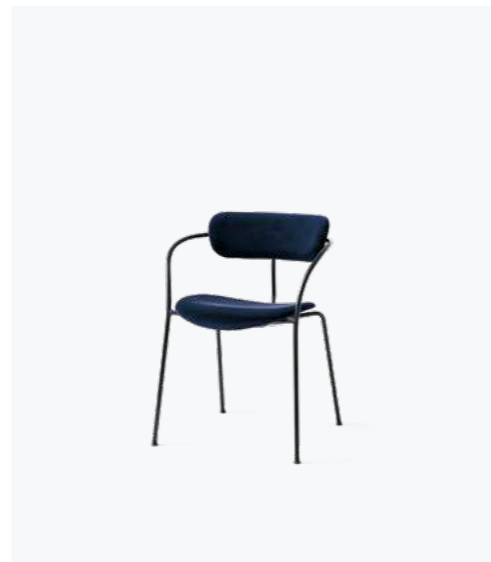
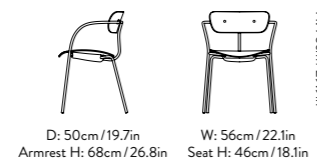

Pavilion AV13 ■■■

Design Anderssen & Voll | 2018
Category Stackable chair with armrests
Materials Steel tubes, formpressed veneer, CMHR foam, fabric upholstery.
MTO (6-8 weeks) Available in various fabrics and COM.

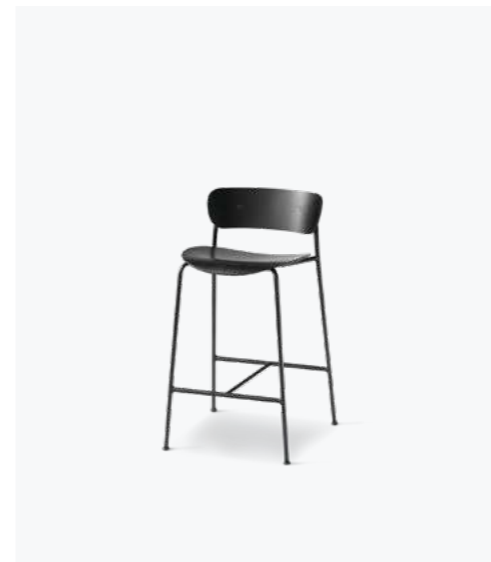
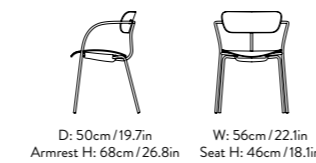

Pavilion AV7 ■■■

Design Anderssen & Voll | 2018
Category Counter chair
Materials Steel tubes and formpressed veneer. Brass fittings for the front side of the back rest available upon request.
Stock Lacquered oak, Lacquered walnut or Black lacquered oak.

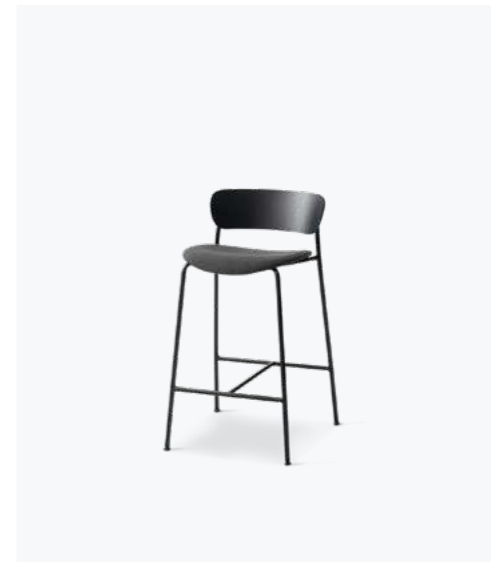
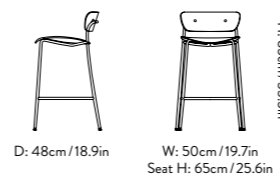

Pavilion AV8 ■■■

Design Anderssen & Voll | 2018
Category Counter chair
Materials Steel tubes and formpressed veneer, CMHR foam, fabric or leather seat upholstery. Brass fittings for the front side of the back rest available upon request.
MTO (6-8 weeks) All fabrics, leathers and COM available for seat upholstery with Lacquered oak, Lacquered walnut or Black lacquered oak back.

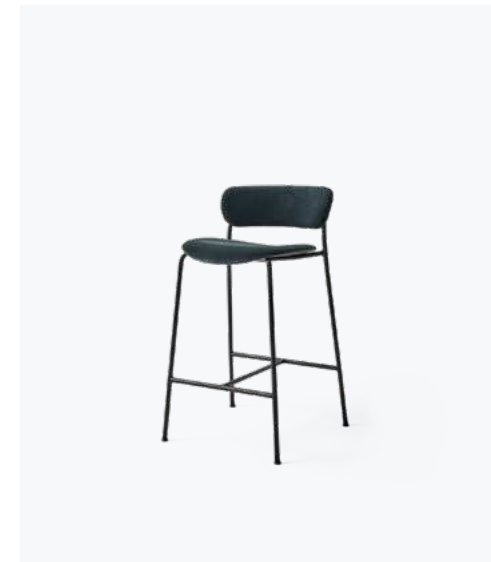
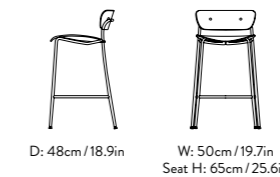

Pavilion AV14 ■■■

Design Anderssen & Voll | 2018
Category Counter chair
Materials Steel tubes, formpressed veneer, CMHR foam, fabric upholstery.
MTO (6-8 weeks) Available in various fabrics and COM.

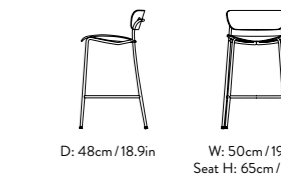



Pavilion AV9 ■■■

Design Anderssen & Voll | 2018
Category Bar chair
Materials Steel tubes and formpressed veneer. Brass fittings for the front side of the back rest available upon request.
Stock Lacquered oak, Lacquered walnut or Black lacquered oak.

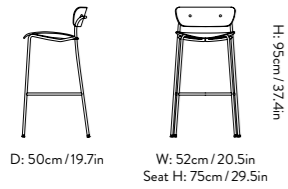

D: 50cm / 19.7in
W: 52cm / 20.5in
Seat H: 75cm / 29.5in
H: 95cm / 37.4in

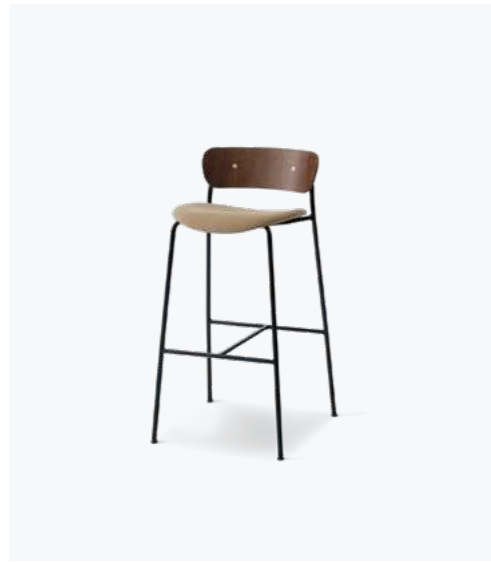

Pavilion AV10 ■■■

Design Anderssen & Voll | 2018
Category Bar chair
Materials Steel tubes and formpressed veneer, CMHR foam, fabric or leather seat upholstery. Brass fittings for the front side of the back rest available upon request.
MTO (6-8 weeks) All fabrics, leathers and COM available for seat upholstery with Lacquered oak, Lacquered walnut or Black lacquered oak back.

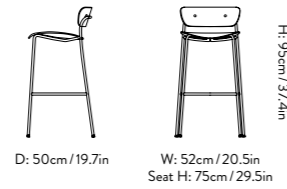

D: 50cm / 19.7in
W: 52cm / 20.5in
Seat H: 75cm / 29.5in
H: 95cm / 37.4in

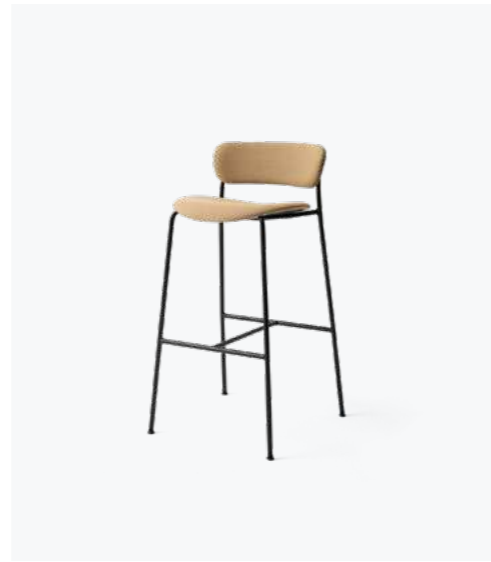

Pavilion AV15 ■■■

Design Anderssen & Voll | 2018
Category Bar chair
Materials Steel tubes, formpressed veneer, CMHR foam, fabric upholstery.
MTO (6-8 weeks) Available in various fabrics and COM.

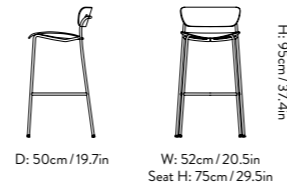

D: 50cm / 19.7in
W: 52cm / 20.5in
Seat H: 75cm / 29.5in
H: 95cm / 37.4in

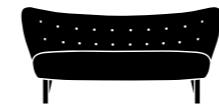

Lounges & Sofas

A collection including lounge chairs, sofas and poufs. Most pieces can be customised and upholstered with a wide range of materials and colours.

Boomerang HM1 ■■■

Design Hvidt & Mølgaard | 1956
Category Lounge chair
Materials Wood, HR foam, polyester wadding, fabric upholstery, brass.
Stock Hallingdal 130, Loop Marine K5042/40, Loop Cream K5042/33, Karakorum 003, Duke 004, Nouvelles Vagues Silver Rock, Serafino Snow col. 2, with Oak or Walnut frame.
MTO (6-8 weeks) All other fabrics and COM available with Oak or Walnut frame.

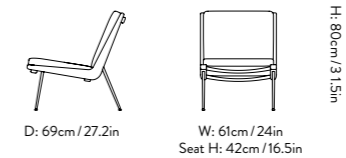

D: 69cm / 27.2in
W: 61cm / 24in
Seat H: 42cm / 16.5in
H: 80cm / 31.5in

Boomerang HM2 ■■■

Design Hvidt & Mølgaard | 1956
Category Lounge chair
Materials Wood, HR foam, polyester wadding, fabric upholstery, brass.
Stock Hallingdal 130, Loop Marine K5042/40, Loop Cream K5042/33, Karakorum 003, Duke 004, Nouvelles Vagues Silver Rock, Serafino Snow col. 2, with Oak or Walnut frame.
MTO (6-8 weeks) All other fabrics and COM available with Oak or Walnut frame.

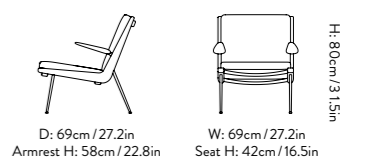

D: 69cm / 27.2in
W: 69cm / 27.2in
Armrest H: 58cm / 22.8in
Seat H: 42cm / 16.5in
H: 80cm / 31.5in



Betty TK1 ■■■■

Design Thau & Kallio | 2019
Category Stackable chair
Materials Solid wood and formpressed veneer with a linnen webbing seat.
Stock Black, Twilight, Maroon.

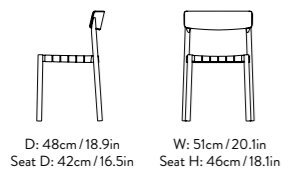

D: 48cm / 18.9in
Seat D: 42cm / 16.5in
W: 51cm / 20.1in
Seat H: 46cm / 18.1in
H: 77cm / 30.3in



Betty TK2 ■■■■

Design Thau & Kallio | 2020
Category Stackable chair
Materials Solid wood and formpressed veneer.
Stock Black, Twilight, Maroon, Oak.

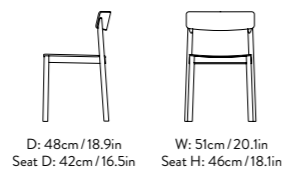

D: 48cm / 18.9in
Seat D: 42cm / 16.5in
W: 51cm / 20.1in
Seat H: 46cm / 18.1in
H: 77cm / 30.3in



Loafer SC24 ■■■■

Design Space Copenhagen | 2019
Category Chair
Materials Wood, HR foam, polyester wadding, fabric upholstery.
MTO (6-8 weeks) Available in various fabric and COM.

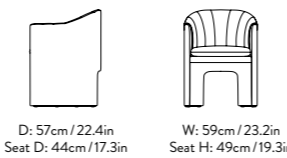

D: 57cm / 22.4in
Seat D: 44cm / 17.3in
W: 59cm / 23.2in
Seat H: 49cm / 19.3in
H: 76cm / 30.3in

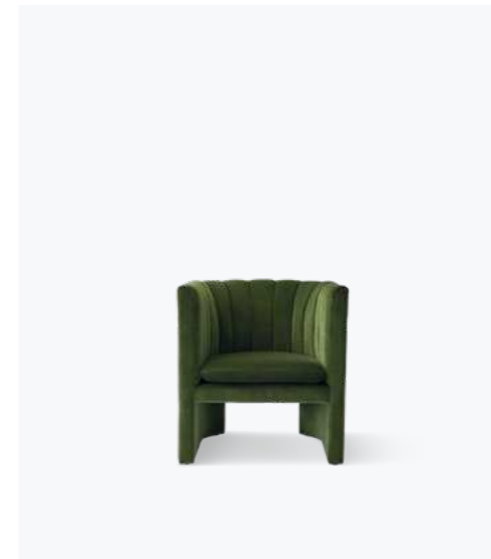

Loafer SC23 ■■■■

Design Space Copenhagen | 2018
Category Lounge chair
Materials Wood, HR foam, polyester wadding, fabric upholstery.
MTO (6-8 weeks) Available in various fabric and COM.

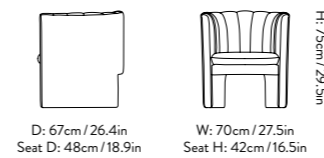

D: 67cm / 26.4in
Seat D: 48cm / 18.9in
W: 70cm / 27.5in
Seat H: 42cm / 16.5in
H: 75cm / 29.5in

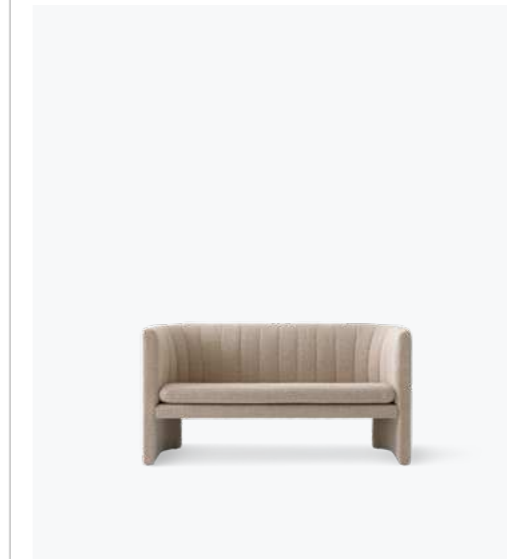

Loafer SC25 ■■■■

Design Space Copenhagen | 2019
Category Sofa
Materials Wood, HR foam, polyester wadding, fabric upholstery.
MTO (6-8 weeks) Available in various fabric and COM.

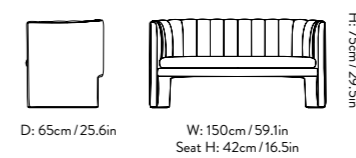

D: 65cm / 25.6in
W: 150cm / 59.1in
Seat H: 42cm / 16.5in
H: 75cm / 29.5in



Loafer SC26 ■■■■

Design Space Copenhagen | 2019
Category Sofa
Materials Wood, HR foam, polyester wadding, fabric upholstery.
MTO (6-8 weeks) Available in various fabric and COM.

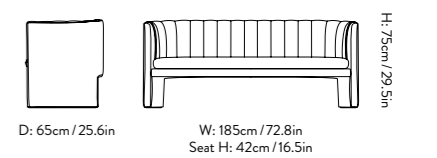

D: 65cm / 25.6in
W: 185cm / 72.8in
Seat H: 42cm / 16.5in
H: 75cm / 29.5in



Little Petra VB1

Design Viggo Boesen | 1938
 Category Lounge chair
 Materials Wood, HR foam, polyester wadding, fabric.
 Stock Hallingdal 130, Karakorum 003, Sheepskin Moonlight 17mm and Sheepskin Sahara 17mm with White oiled oak or Oiled walnut legs.
 MTO All other fabrics and COM available with White oiled oak or Oiled walnut legs.
 (6-8 weeks)

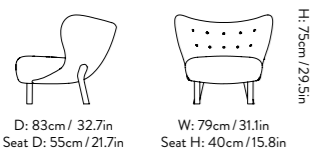

Little Petra VB2

Design Viggo Boesen | 1938
 Category Sofa
 Materials Wood, HR foam, polyester wadding, fabric.
 Stock Karakorum 003, Sheepskin Moonlight 17mm and Sheepskin Sahara 17mm with White oiled oak or Oiled walnut legs.
 MTO All other fabrics and COM available with White oiled oak or Oiled walnut legs.
 (6-8 weeks)

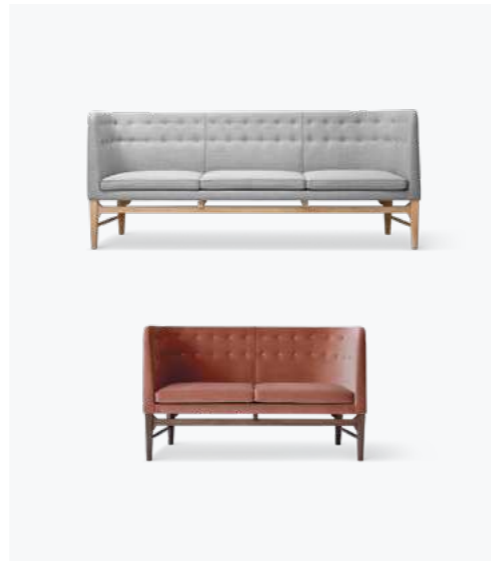
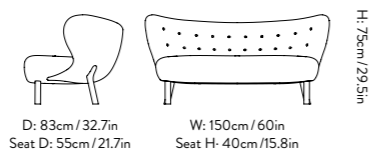

Mayor AJ5 & AJ6

Design Arne Jacobsen & Flemming Lassen | 1939
 Category Sofa
 Materials Solid oak or walnut base, solid beech frame, CMHR foam, fabric or leather upholstery.
 Stock White oiled oak with Hallingdal 130.
 MTO All fabrics, leathers and COM available with White oiled, Smoked oiled, Black lacquered oak or Walnut base.
 (6-8 weeks)

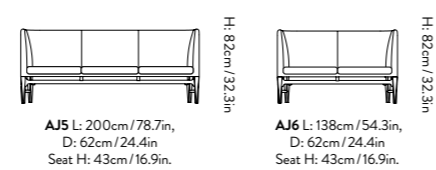

Cloud LN5

Design Luca Nichetto | 2018
 Category High back lounge chair
 Materials Plywood, solid wood and steel base with no-zag springs. HR foam, polyester fibers and feather pillows. Solid steel legs. Fabric or leather upholstery.
 MTO All fabrics, leathers and COM available with Chrome, Bronzed or Warm black powder coated legs.
 (6-8 weeks)

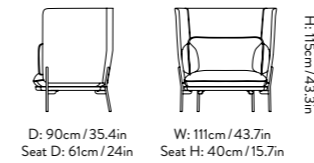

Cloud LN6

Design Luca Nichetto | 2017
 Category High back sofa
 Materials Plywood, solid wood and steel base with no-zag springs. HR foam, polyester fibers and feather pillows. Solid steel legs. Fabric or leather upholstery.
 MTO All fabrics, leathers and COM available with Chrome, Bronzed or Warm black powder coated legs.
 (6-8 weeks)

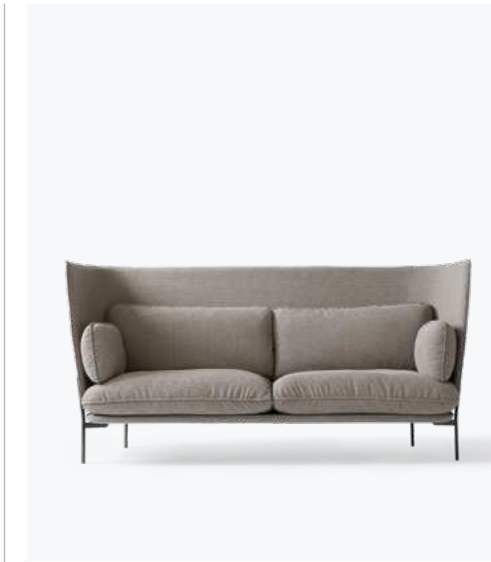
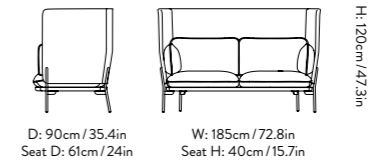

Cloud LN7

Design Luca Nichetto | 2017
 Category High back sofa
 Materials Plywood, solid wood and steel base with no-zag springs. HR foam, polyester fibers and feather pillows. Solid steel legs. Fabric or leather upholstery.
 MTO All fabrics, leathers and COM available with Chrome, Bronzed or Warm black powder coated legs.
 (6-8 weeks)

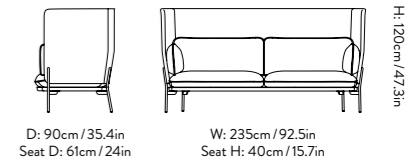

Cloud LN1

Design Luca Nichetto | 2015
 Category Lounge chair
 Materials Plywood, solid wood and steel base with no-zag springs. HR foam, polyester fibers and feather pillows. Solid steel legs. Fabric or leather upholstery.
 MTO All fabrics, leathers and COM available with Chrome, Bronzed or Warm black powder coated legs.
 (6-8 weeks)

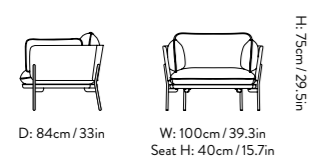

Cloud LN2

Design Luca Nichetto | 2015
 Category Sofa
 Materials Plywood, solid wood and steel base with no-zag springs. HR foam, polyester fibers and feather pillows. Solid steel legs. Fabric or leather upholstery.
 MTO All fabrics, leathers and COM available with Chrome, Bronzed or Warm black powder coated legs.
 (6-8 weeks)

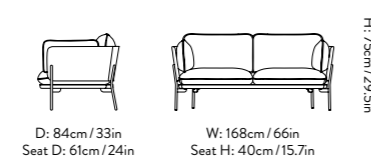

Cloud LN3.2

Design Luca Nichetto | 2015
 Category Sofa
 Materials Plywood, solid wood and steel base with no-zag springs. HR foam, polyester fibers and feather pillows. Solid steel legs. Fabric or leather upholstery.
 MTO All fabrics, leathers and COM available with Chrome, Bronzed or Warm black powder coated legs.
 (6-8 weeks)

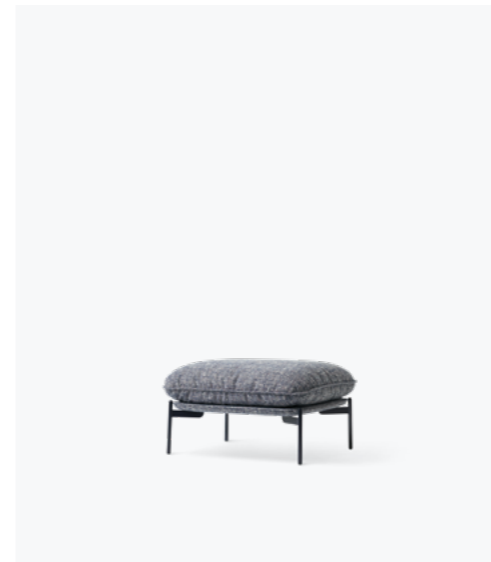
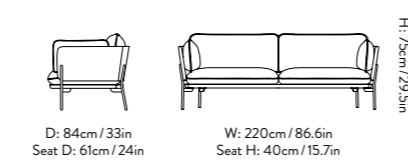

Cloud LN4

Design Luca Nichetto | 2015
 Category Pouf
 Materials Plywood base. HR foam, polyester fibers and feather pillows. Solid steel legs. Fabric or leather upholstery.
 MTO All fabrics, leathers and COM available with Chrome, Bronzed or Warm black powder coated legs.
 (6-8 weeks)

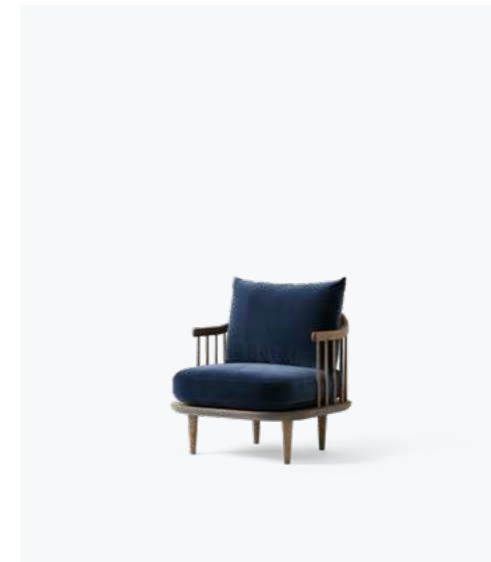
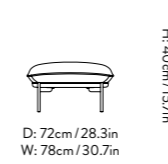

Fly SC10

Design Space Copenhagen | 2017
 Category Lounge chair
 Materials Oak frame and base. CMHR foam and feather pillows. Fabric upholstery.
 Stock White oiled oak/Hot Madison 094, Smoked oiled oak/Chivasso Madison 093, Smoked oiled oak/Velvet 10 Twilight.
 MTO All other fabrics and COM available with White oiled or Smoked oiled oak base and frame.
 (6-8 weeks)

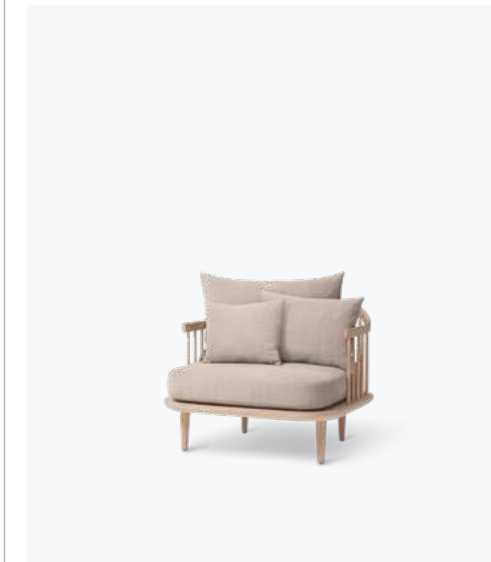
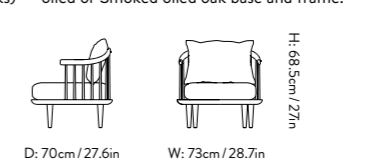

Fly SC1

Design Space Copenhagen | 2013
 Category Lounge chair
 Materials Oak frame and base. CMHR foam and feather pillows. Fabric upholstery.
 Stock White oiled oak/Hot Madison 094, Smoked oiled oak/Chivasso Madison 093, Smoked oiled oak/Velvet 10 Twilight.
 MTO All other fabrics and COM available with White oiled or Smoked oiled oak base and frame.
 (6-8 weeks)





Fly SC9



Design Space Copenhagen | 2014
Category Pouf
Materials Oak base. CMHR foam and feather pillow. Fabric upholstery.
Stock White oiled oak/Hot Madison 094, Smoked oiled oak/Chivasso Madison 093, Smoked oiled oak/Velvet 10 Twilight.
MTO All other fabrics and COM available with White oiled or Smoked oiled oak base and frame.
 (6-8 weeks)

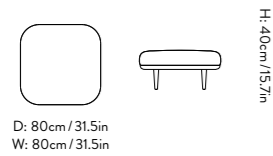

Fly SC2



Design Space Copenhagen | 2013
Category Sofa
Materials Oak frame and base. CMHR foam and feather pillows. Fabric upholstery.
Stock White oiled oak/Hot Madison 094, Smoked oiled oak/Chivasso Madison 093, Smoked oiled oak/Velvet 10 Twilight.
MTO All other fabrics and COM available with White oiled or Smoked oiled oak base and frame.
 (6-8 weeks)

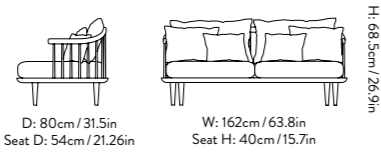

Isole NNIA-NNIG

Design Nendo & Luca Nichetto | 2017
Category Modular sofa
Materials Powder coated steel base, moulded CMHR foam seat, backrest and armrest. Black MDF table tops with nano laminate surface.
Table top Black
Upholstery Uniform Melange, Planum & Nitto.
MTO All fabrics available with black powder coated steel base.
 (6-8 weeks)

Modules

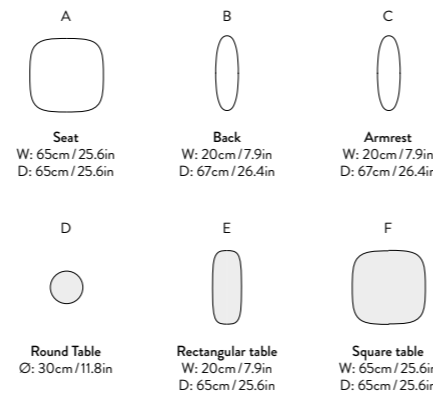

Configuration examples

Go to: <https://isole.andtradition.com>

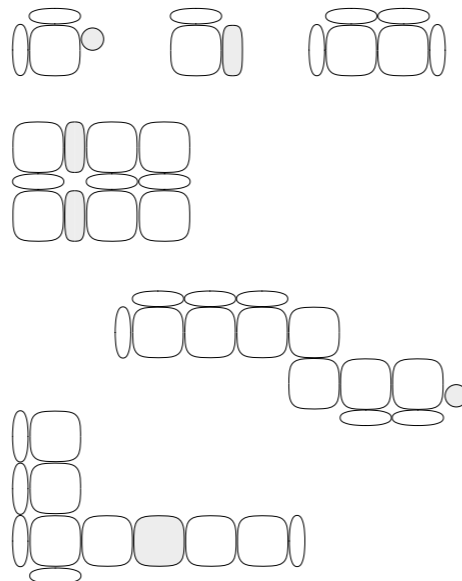

Develius EV1-EV7

Design Edward van Vliet | 2018
Category Modular sofa
Materials Wooden frame, no-zag springs, HR foam and polyester wadding. Metal brackets for connecting modules.
Pillows Optional on EV1 and EV2 modules.
Stock 8 configurations in Fiord 151. Pillows included in each configuration.
MTO All modules are available in a variety of fabrics and COM.
 (6-8 weeks)

Pillows: 3 variants



EV1 Modules

Seating Depth: 70cm/27.5in, Seating Height: 42cm/16.5in, Armrest Height: 60cm/23.6in.

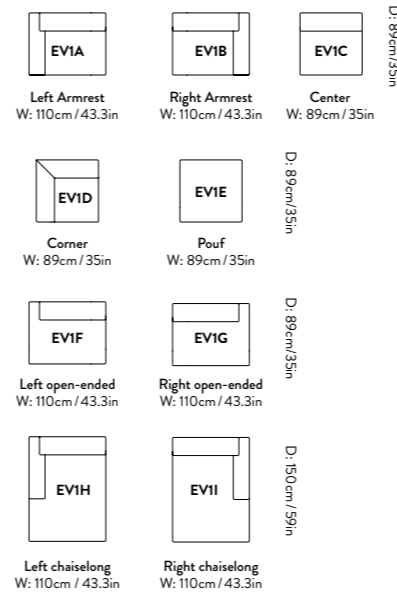

EV2 Modules

Seating Depth: 91cm/35.8in, Seating Height: 42cm/16.5in, Armrest Height: 60cm/23.6in.

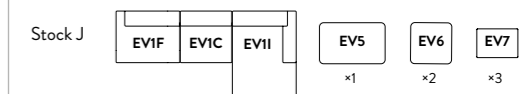
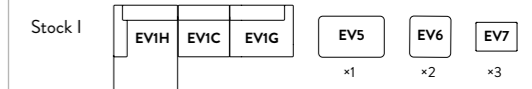
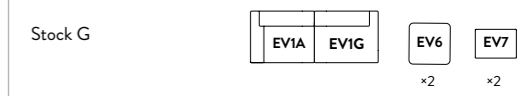
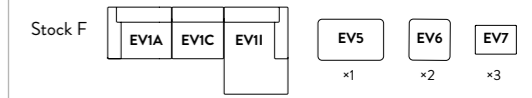
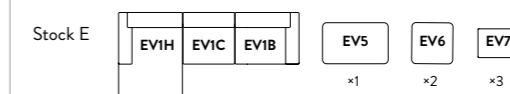
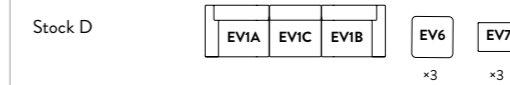
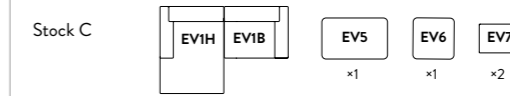
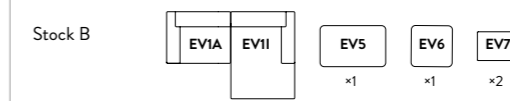
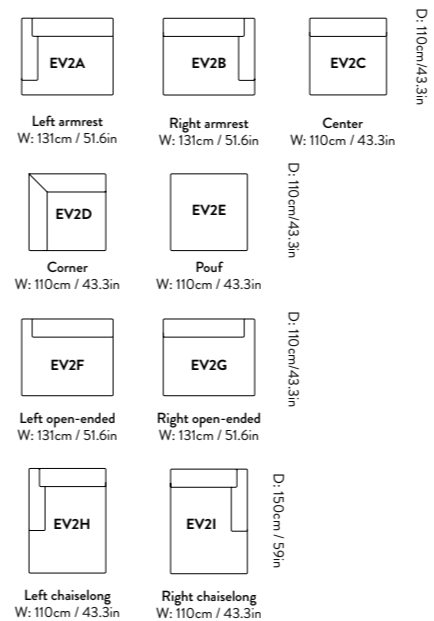

Fly SC3



Design Space Copenhagen | 2013
Category Sofa
Materials Oak frame and base. CMHR foam and feather pillows. Fabric upholstery.
Stock White oiled oak/Hot Madison 094, Smoked oiled oak/Chivasso Madison 093, Smoked oiled oak/Velvet 10 Twilight.
MTO All other fabrics and COM available with White oiled or Smoked oiled oak base and frame.
 (6-8 weeks)

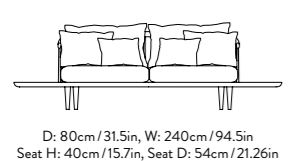

Fly SC12

Design Space Copenhagen | 2017
Category Sofa
Materials Oiled oak frame and base. CMHR foam and feather pillows. Fabric upholstery.
MTO All fabrics and COM available with White oiled or Smoked oiled oak base and frame.
 (6-8 weeks)

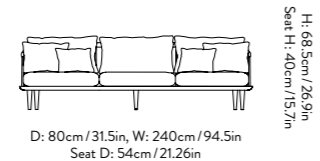



Tables

A collection of side, lounge and dining tables designed to fit different spaces and styles.



Fly SC4



Design Space Copenhagen | 2013
Category Lounge table
Materials Oak base with marble table top.
Stock White oiled oak & honed Bianco Carrara marble, White oiled oak & Azul Valverde marble, Smoked oiled oak & Azul Valverde marble, Smoked oiled oak & honed Nero Marquina marble.

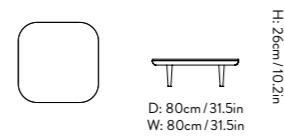

Fly SC11



Design Space Copenhagen | 2017
Category Lounge table
Materials Oak base with marble table top.
Stock White oiled oak & honed Bianco Carrara marble, White oiled oak & Azul Valverde marble, Smoked oiled oak & Azul Valverde marble, Smoked oiled oak & honed Nero Marquina marble.

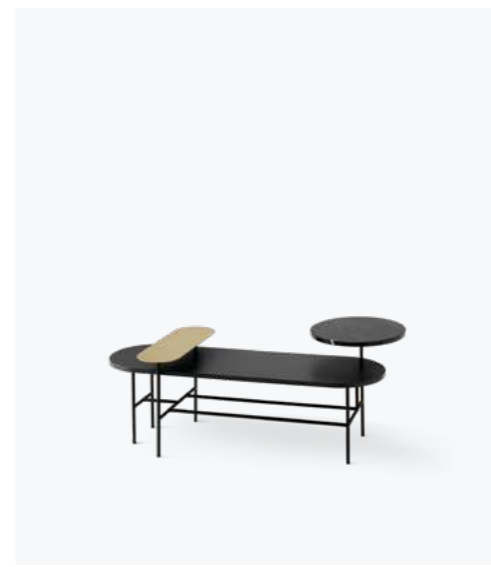
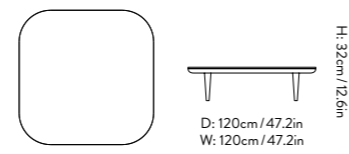

Palette JH7



Design Jaime Hayon | 2015
Category Lounge table
Materials Brass, Nero Marquina marble, lacquered ash veneer, lacquered walnut veneer.
Stock Brass, Nero Marquina marble, Black lacquered ash, Brass, Nero Marquina marble, Lacquered walnut.

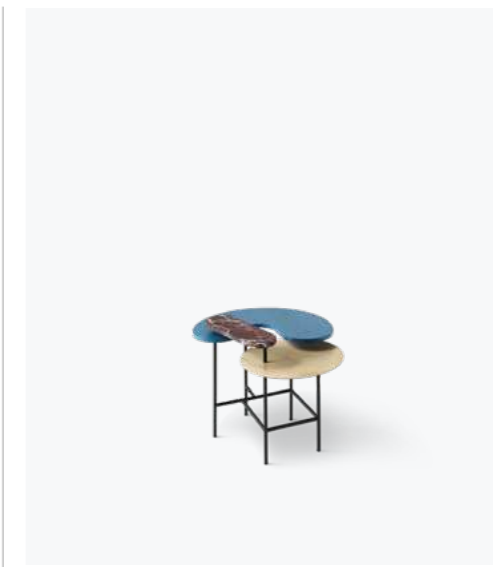
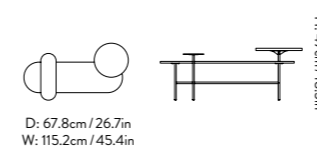

Palette JH8



Design Jaime Hayon | 2015
Category Lounge table
Materials Brass, Rosso Levanto marble, lacquered ash veneer, Nero Marquina marble, lacquered walnut veneer.
Stock Brass, Rosso Levanto marble, Blue lacquered ash, Brass, Nero Marquina marble, Lacquered walnut.

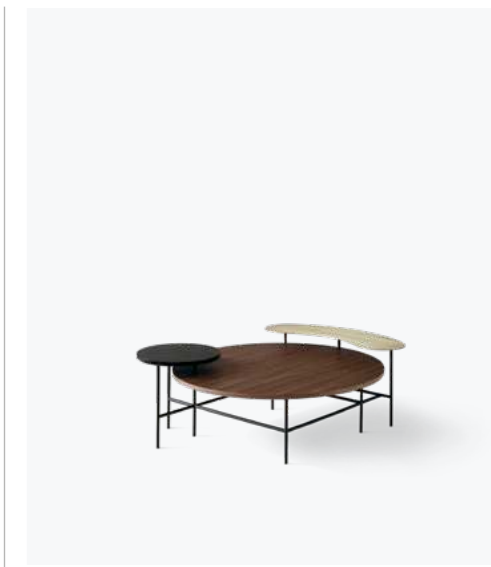
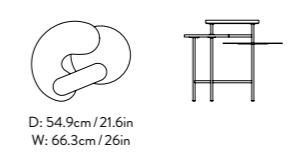

Palette JH25



Design Jaime Hayon | 2018
Category Lounge table
Materials Brass, Nero Marquina marble, lacquered ash veneer, lacquered walnut veneer.
Stock Brass, Nero Marquina, black lacquered ash, Brass, Nero Marquina, lacquered walnut.

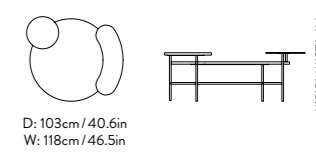

Drop Leaf HM5



Design Hvidt & Mølgaard | 1956
Category Lounge table
Materials Solid wood & brass.
Stock White oiled oak, Oiled walnut.

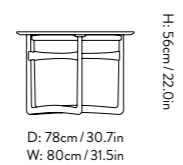

Pinwheel HM7



Design Hvidt & Mølgaard | 1953
Category Lounge table
Materials Solid oak or walnut & brass.
Stock White oiled oak, Oiled walnut.

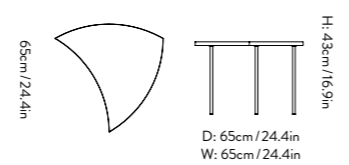

Fly SC5



Design Space Copenhagen | 2013
Category Lounge table
Materials Oak base with marble table top.
Stock White oiled oak & honed Bianco Carrara marble, White oiled oak & Azul Valverde marble, Smoked oiled oak & Azul Valverde marble, Smoked oiled oak & honed Nero Marquina marble.

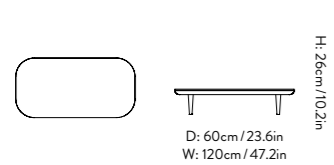

Palette JH26



Design Jaime Hayon | 2018
Category Side table
Materials Nero Marquina marble, lacquered ash veneer, lacquered walnut veneer.
Stock Nero Marquina, Black lacquered ash, Nero Marquina, Lacquered walnut.

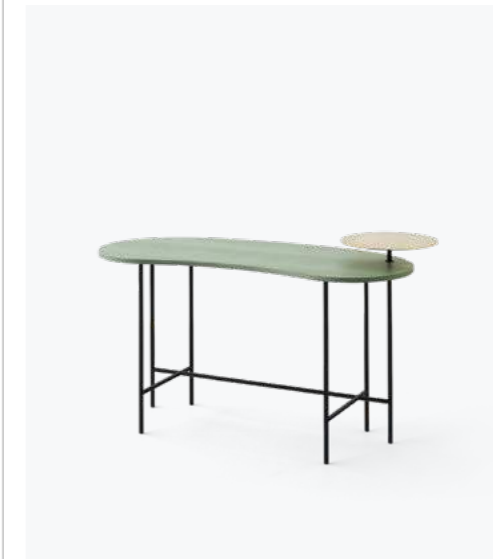
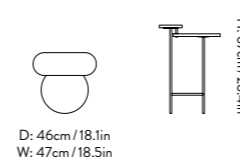

Palette JH9



Design Jaime Hayon | 2015
Category Desk
Materials Brass, Nero Marquina marble, lacquered ash veneer, lacquered walnut veneer.
Stock Nero Marquina marble & Black lacquered ash, Brass & Grey green lacquered ash, Brass & lacquered walnut.

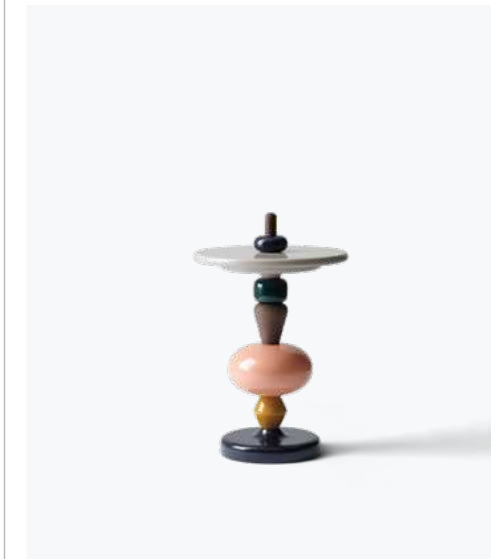
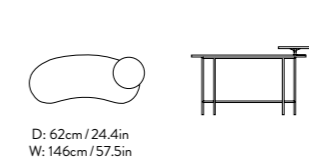

Shuffle MH1



Design Mia Hamborg | 2010
Category Side table
Materials PU Lacquered MDF, PU lacquered solid beech, solid oiled oak.
Stock Spectrum.

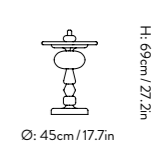



Lato LN8 

Design Luca Nichetto | 2018
 Category Side table
 Materials Marble and steel.
 Stock Warm black & Emparador marble, Ivory white & Crema Diva marble.

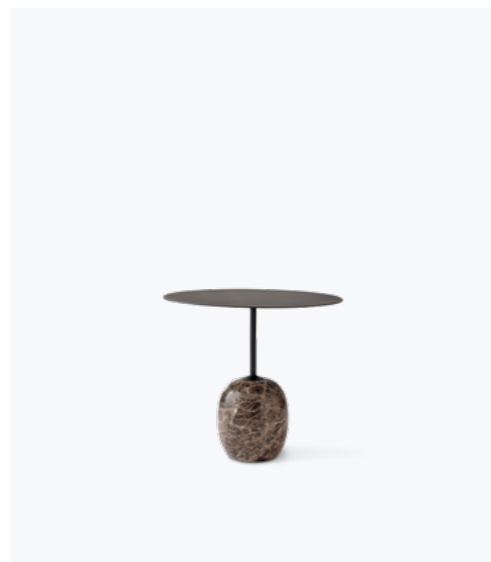
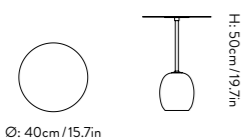

Lato LN9 

Design Luca Nichetto | 2018
 Category Side table
 Materials Marble and steel.
 Stock Warm black & Emparador marble, Ivory white & Crema Diva marble.

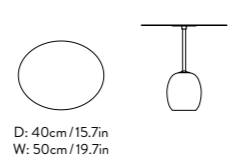

Hoof SW1 & SW2 

Design Samuel Wilkinson | 2012
 Category Lounge table
 Materials Solid oak with a brushed surface.
 Stock White oiled oak, Smoked oiled oak.

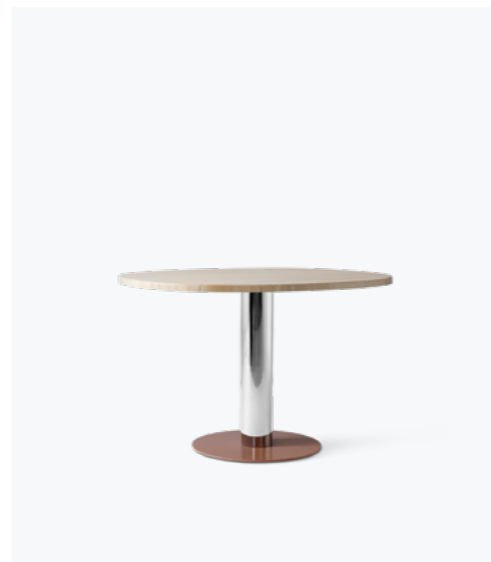
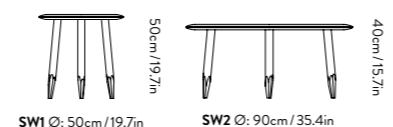

Mezcla JH22 

Design Jaime Hayon | 2018
 Category Table
 Materials Marble or solid wood with electro plated and powder coated steel.
 Stock Oiled walnut with brass & burgundy, Honed Nero Marquina with brass & burgundy, White oiled oak with chrome & clay, Honed Travertine with chrome & clay.

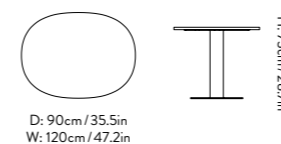

In Between SK3 

Design Sami Kallio | 2014
 Category Table
 Materials Solid wood table top with solid wood legs.
 Stock White oiled oak, Smoked oiled oak, Oiled walnut, Black lacquered oak (RAL 9005).

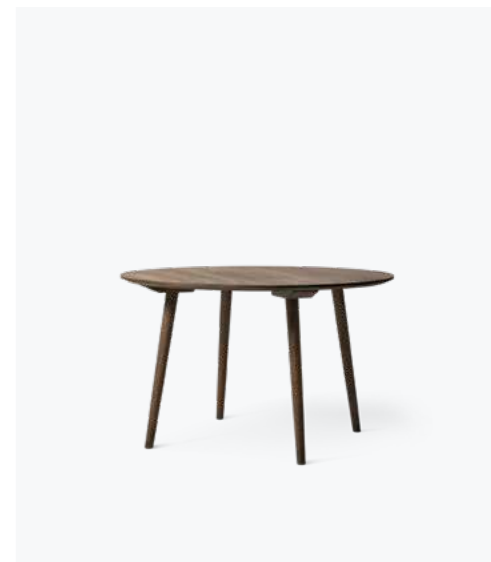

In Between SK4 

Design Sami Kallio | 2014
 Category Table
 Materials Solid wood table top with solid wood legs.
 Stock White oiled oak, Smoked oiled oak, Oiled walnut, Black lacquered oak (RAL 9005).

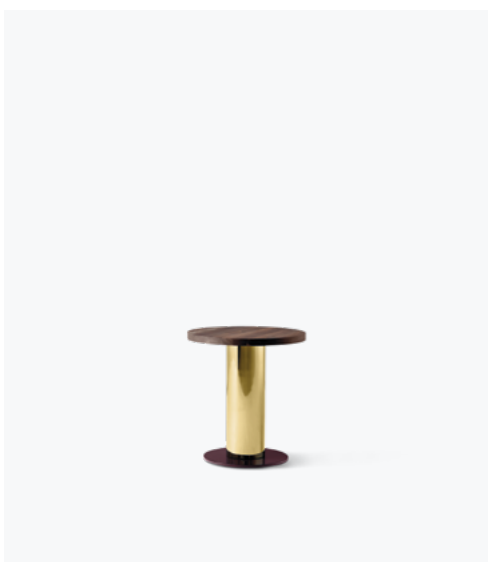
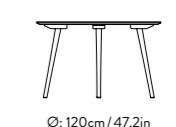

Mezcla JH19 

Design Jaime Hayon | 2018
 Category Side table
 Materials Marble or solid wood with electro plated and powder coated steel.
 Stock Oiled walnut with brass & burgundy, Honed Nero Marquina with brass & burgundy, White oiled oak with chrome & clay, Honed Travertine with chrome & clay.

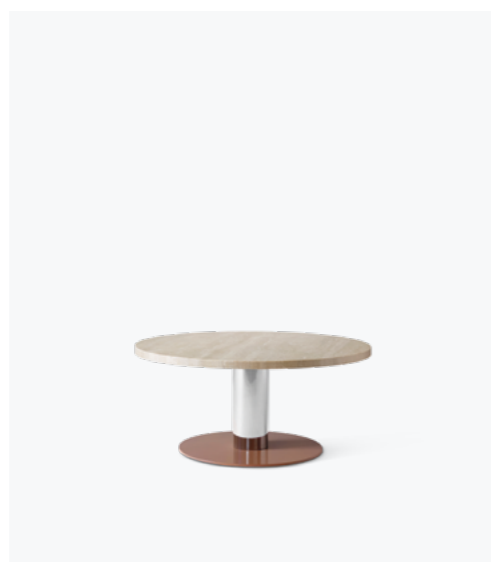
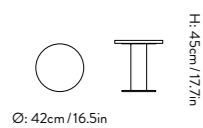

Mezcla JH20 

Design Jaime Hayon | 2018
 Category Lounge table
 Materials Marble or solid wood with electro plated and powder coated steel.
 Stock Oiled walnut with brass & burgundy, Honed Nero Marquina with brass & burgundy, White oiled oak with chrome & clay, Honed Travertine with chrome & clay.

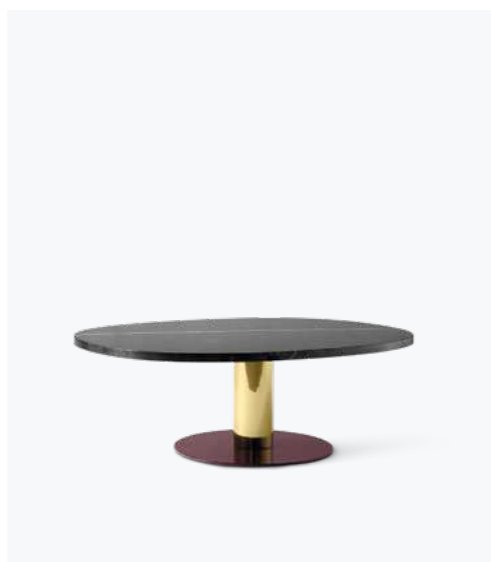
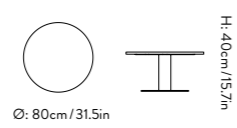

Mezcla JH21 

Design Jaime Hayon | 2018
 Category Lounge table
 Materials Marble or solid wood with electro plated and powder coated steel.
 Stock Oiled walnut with brass & burgundy, Honed Nero Marquina with brass & burgundy, White oiled oak with chrome & clay, Honed Travertine with chrome & clay.

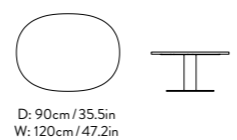

In Between SK11 

Design Sami Kallio | 2019
 Category Table
 Materials Solid wood table top with matt black metal center base.
 Stock White oiled oak, Smoked oiled oak, Oiled walnut, Black lacquered oak (RAL 9005).
 MTO Available in custom sizes with veneer, laminate, nano laminate and linoleum table top.
 (6-8 weeks)

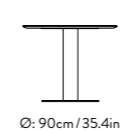

In Between SK12 

Design Sami Kallio | 2019
 Category Table
 Materials Solid wood table top with matt black metal center base.
 Stock White oiled oak, Smoked oiled oak, Oiled walnut, Black lacquered oak (RAL 9005).
 MTO Available in custom sizes with veneer, laminate, nano laminate and linoleum table top.
 (6-8 weeks)

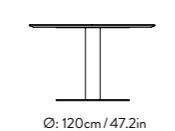

In Between SK5 & SK6 

Design Sami Kallio | 2015
 Category Table
 Materials Oak veneer table top and lacquered solid oak legs.
 Stock Clear lacquered oak, Smoked lacquered oak, Black lacquered oak (RAL 9005).
 MTO Available in custom sizes with veneer, laminate, nano laminate and linoleum table top.
 (6-8 weeks)

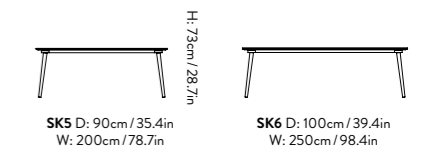



Drop Leaf HM6



Design Hvidt & Mølgaard | 1956
 Category Table
 Materials Solid wood & Brass.
 Stock White oiled oak, Oiled walnut.

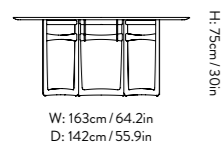

Patch HW1



Design Hee Welling | 2020
 Category Extendable table
 Materials Solid wood with Fenix NTM nano laminate table top and brass fittings.
 Stock White oiled oak w. Fenix Beige Arizona & Brass, Smoked oiled oak w. Fenix Griogio Londra & Brass, Oiled walnut w. Fenix Cacao Orinoco & Brass.

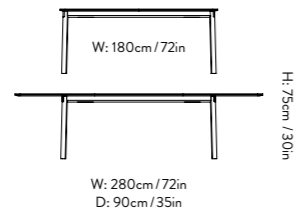

Patch HW2



Design Hee Welling | 2020
 Category Extendable table
 Materials Solid wood with Fenix NTM nano laminate table top and brass fittings.
 Stock White oiled oak w. Fenix Beige Arizona & Brass, Smoked oiled oak w. Fenix Griogio Londra & Brass, Oiled walnut w. Fenix Cacao Orinoco & Brass.

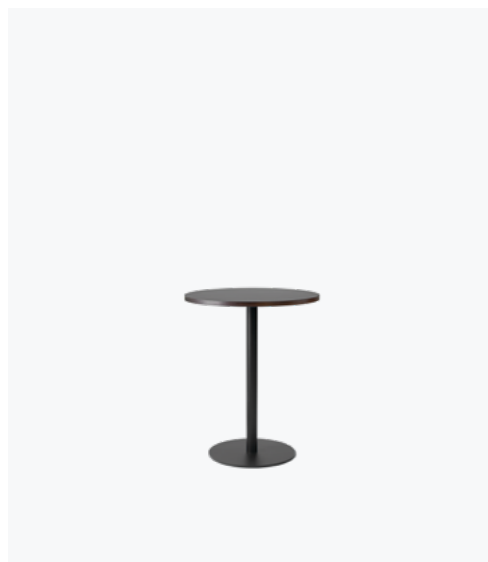
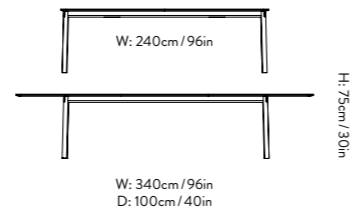

Nærvær NA9

Design Norm Architects | 2018
 Category Café table
 Materials Powder coated steel base, Nano laminate table top with veneered edges.
 Stock Black & Smoked oiled oak.
 MTO Available in custom sizes with nano laminate table top. (6-8 weeks)

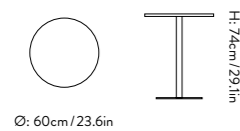

Nærvær NA10

Design Norm Architects | 2018
 Category Café table
 Materials Powder coated steel base, Nano laminate table top with veneered edges.
 Stock Black & Smoked oiled oak.
 MTO Available in custom sizes with nano laminate table top. (6-8 weeks)

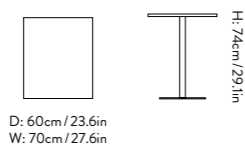

Nærvær NA12 & NA13

Design Norm Architects | 2019
 Category Bar table
 Materials Powder coated steel base, Nano laminate table top with veneered edges.
 Stock Black & Smoked oiled oak.
 MTO Available in custom sizes with nano laminate table top. (6-8 weeks)

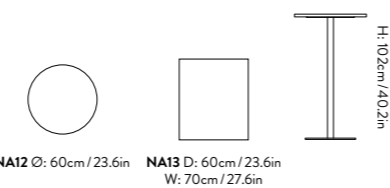

T

Objects

A line of home objects including mirrors of different sizes and shapes, archetypal-designed shelves and handloom-woven rugs.



Sillon SH4



Design Sebastian Herkner | 2019
 Category Mirror
 Materials Plated steel & silver coloured mirror.
 Stock Brass, Chrome.



Sillon SH5



Design Sebastian Herkner | 2019
 Category Mirror
 Materials Plated steel & silver coloured mirror.
 Stock Brass, Chrome.



Sillon SH6



Design Sebastian Herkner | 2019
 Category Mirror
 Materials Plated steel & silver coloured mirror.
 Stock Brass, Chrome.

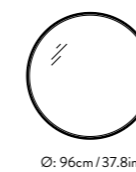

Sillon SH7



Design Sebastian Herkner | 2019
 Category Mirror
 Materials Plated steel & silver coloured mirror.
 Stock Brass, Chrome.

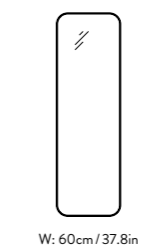

Amore SC49



Design Space Copenhagen | 2020
 Category Mirror
 Materials Bronzed Brass & silver coloured mirror.
 Stock Bronzed Brass.

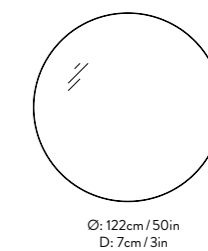



Amore SC50 ■ ■

Design Space Copenhagen | 2020
 Category Mirror
 Materials Bronzed Brass & silver coloured mirror.
 Stock Bronzed Brass.

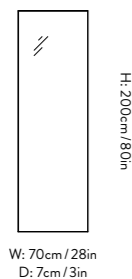

Column JA1 ■ ■

Design John Astbury | 2019
 Category Shelf
 Materials Waxed aluminium, Black anodized aluminium with solid walnut.
 Stock Aluminium, Walnut & Black aluminium.

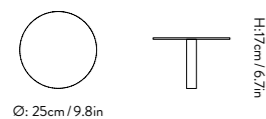

The Moor AP5 & AP7 ■ ■ ■ ■

Design All the Way to Paris | 2016
 Category Rug
 Materials Handloom-woven rug with a dense, soft and highly exclusive velvet-like expression made from 85% pure New Zealand wool, 15% viscose.
 Stock Grey moss, Beige dew, Yellow field, Green pine.
 MTO Available in custom sizes upon request.
 (22-24 weeks)

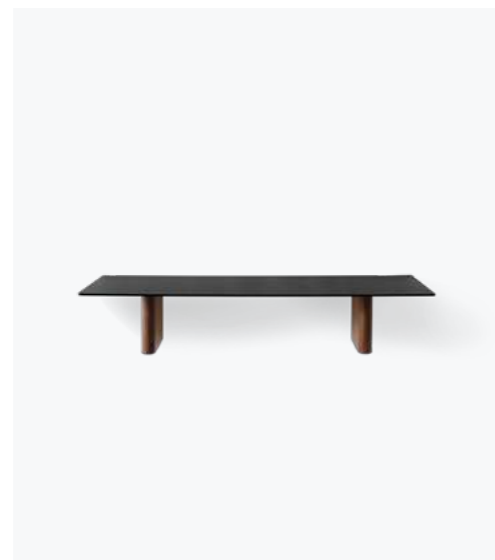
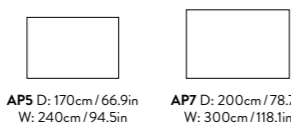

Column JA2 ■ ■ ■ ■

Design John Astbury | 2019
 Category Shelf
 Materials Waxed aluminium, Black anodized aluminium with solid walnut.
 Stock Aluminium, Walnut & Black aluminium.

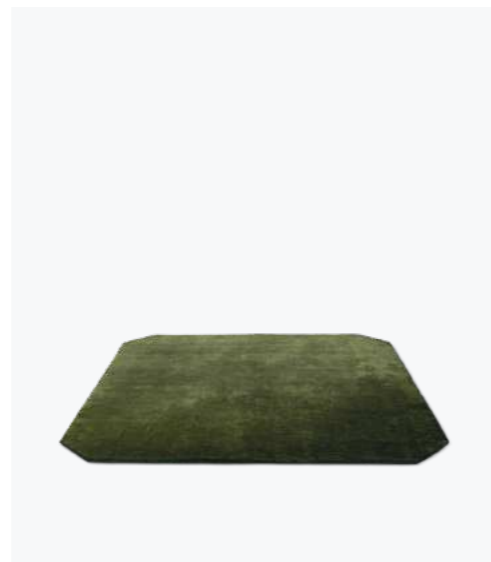
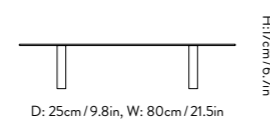

The Moor AP6 & AP8 ■ ■ ■ ■

Design All the Way to Paris | 2016
 Category Rug
 Materials Handloom-woven rug with a dense, soft and highly exclusive velvet-like expression made from 85% pure New Zealand wool, 15% viscose.
 Stock Red heather, Blue midnight, Yellow field, Green pine.
 MTO Available in custom sizes upon request.
 (22-24 weeks)

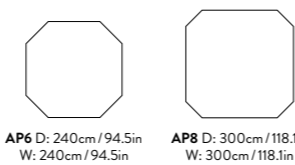

& Tradition Collect

Designed by Space Copenhagen, this elegantly understated collection reflects the studio's commitment to quality and longevity. An emphasis on natural textures – including linen and organic cotton – accentuated this luxuriously rustic aesthetic further.

Space Copenhagen | 2020



Planter SC43 ■ ■

Category Planter, Indoor and outdoor use
 Materials Fiber Concrete
 Stock Silver grey, Shadow grey.

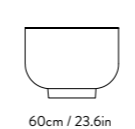

Planter SC44 ■ ■

Category Planter, Indoor and outdoor use
 Materials Fiber Concrete
 Stock Silver grey, Shadow grey.

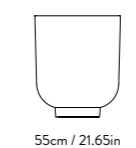

Planter SC45 ■ ■

Category Planter, Indoor and outdoor use
 Materials Fiber Concrete
 Stock Silver grey, Shadow grey.

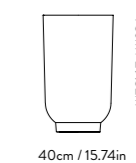



Linen SC27-SC30

Category Pillow
 Materials The cover is 100% pure linen, the inner sham is 100% cotton and the filling consist of 50% feather, 50% down.
 Stock Burgundy, Milk, Cloud, Powder, Sand, Slate.



Heavy Linen SC27-SC30

Category Pillow
 Materials The cushion cover is made from 91% heavy linen, and 9% polyamide, the inner sham is 100% cotton and the filling consist of 50% feather, 50% down.
 Stock Burgundy, Powder, Slate.



Boucle SC28-SC30

Category Pillow
 Materials The cushion cover is made from 40% polyacrylic, 29% viscose, 15% nylon, 9% polyester, 7% wool, the inner sham is 100% cotton and the filling consist of 50% feather, 50% down.
 Stock Ivory & Granite, Ivory, Ivory & Sand.



Indigo SC28-SC30

Category Pillow
 Materials The cushion cover is made from 100% pure linen, the inner sham is 100% cotton and the filling consists of 50% feather, 50% down.
 Stock Milk & Powder, Milk & Sand, Cloud & Slate, Cloud & Burgundy.



Linen SC31

Category Bedspread
 Materials The cover is 100% pure linen.
 Stock Burgundy, Milk, Cloud, Powder, Sand, Slate.

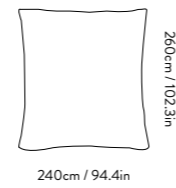

Cotton Throw SC32 & SC33

Category Throw
 Materials 100% Organic Cotton.
 Stock Cloud & Burgundy, Cloud & Milk, Cloud & Slate, Cloud & Blue.

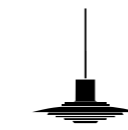
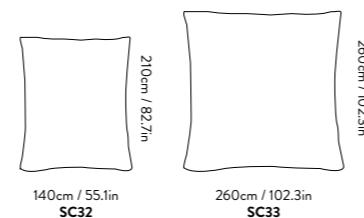

Lighting

A collection of timeless pieces, from sculptural floor lamps to elegant pendants and distinctive table lamps.

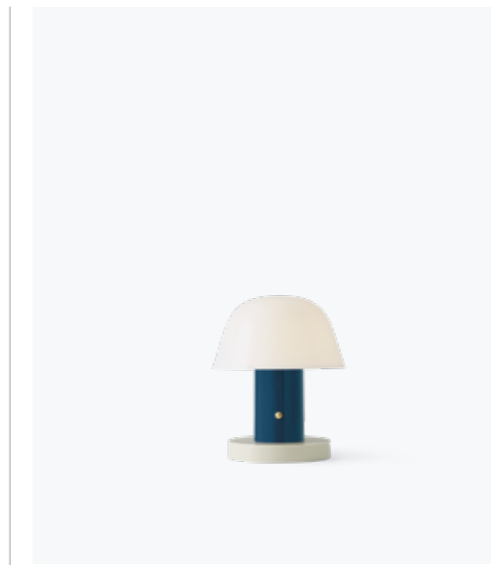

Setago JH27

Design Jaime Hayon | 2019
 Category Portable table lamp
 Materials Molded polycarbonate (PC) and brass.
 Colours Nude & Forest, Twilight & Sand, Rust & Thunder.
 Light source GY4 3,6V Max 3W LED. Dimmable LED bulb (3W, 2800K, CRI80, 225lm) is included. Compatible with bulbs of energy classes: A++ - A. Estimated LED lifetime 25.000 hours.

Stock All colours

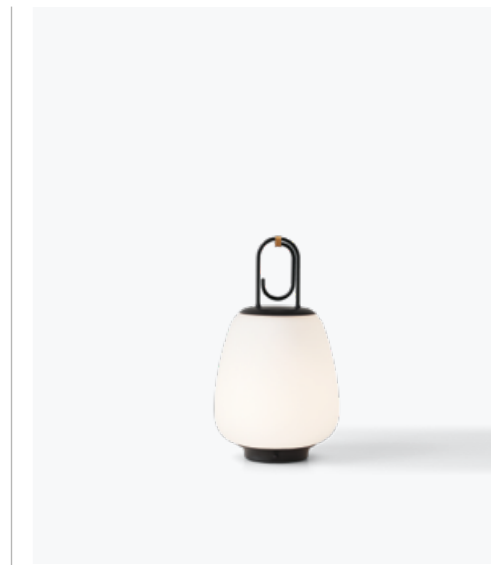
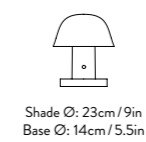

Lucca SC51

Design Space Copenhagen | 2020
 Category Portable table lamp, Indoor and outdoor use
 Materials Satinized opal glass, powder coated metal, brass.
 Colours Moss, Maroon & Black.
 Light source Operating time when fully charged: 12 hours. CRI: >80. Color temperature (Kelvin): 2700 K. Dimmability: 3 levels (40% - 70% - 100%). Micro USB charging cable 200 cm/78.7 in. IP44 rated

Stock All colours

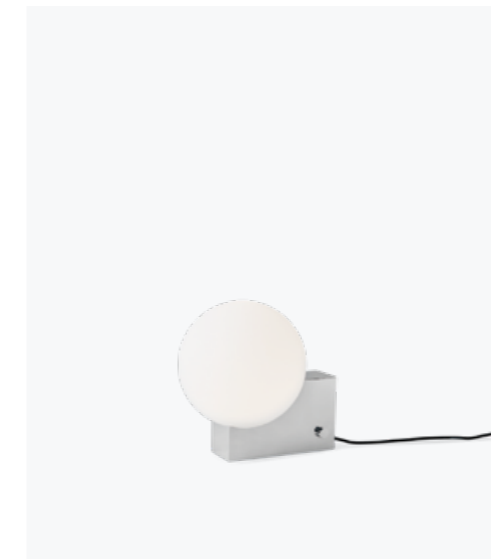
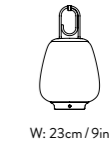

Journey SHY1

Design Signe Hytte | 2018
 Category Table & wall lamp
 Materials Mouth-blown opal glass and steel with dimmer knob.
 Colours Mirror, Black, Clay.
 Light source 4,8W LED. The luminaire is energy class: A+. The built-in LEDs cannot be changed in this luminaire.

Stock All colours

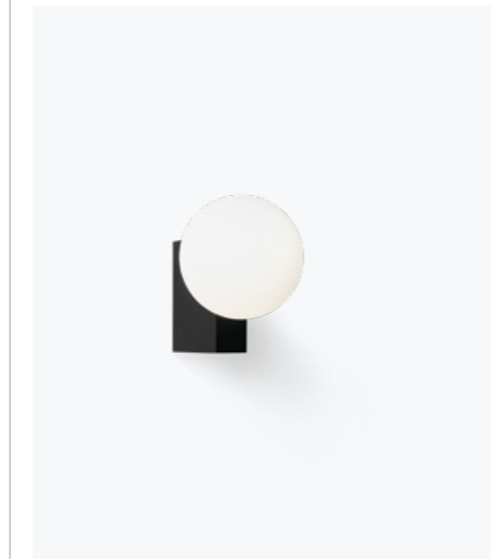
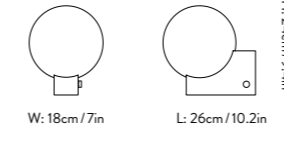

Journey SHY2

Design Signe Hytte | 2018
 Category Wall lamp
 Materials Mouth-blown opal glass and steel. Hardwired
 Colours Mirror, Black, Clay.
 Light source G9 Max 33W. The luminaire is compatible with bulbs of the energy class: A++ - E. Bulb is not included.

Stock All colours

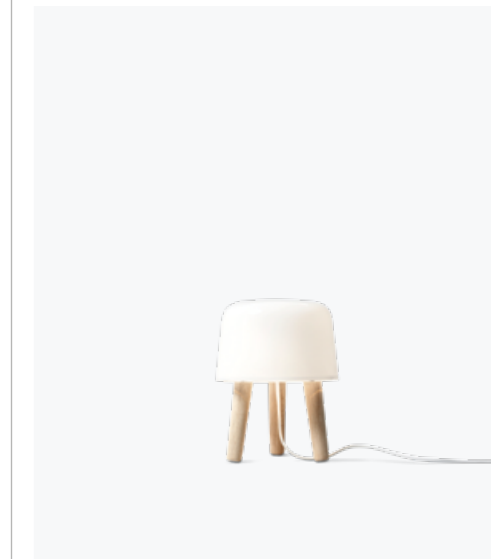
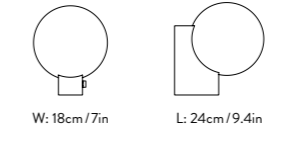

Milk NA1

Design Norm Architects | 2010
 Category Table lamp
 Materials Mouth blown opal glass, solid ash legs, 2-meter fabric cord with dimmer.
 Colours Untreated ash legs with white fabric cord, Smoked oiled ash legs with black fabric cord.
 Light source G9 Max 40W. Compatible with bulbs of the energy classes: A++ - E. Bulb is not included.

Stock All colours





Passepartout JH10



Design Jaime Hayon | 2016
 Category Ceiling & wall lamp
 Materials Aluminium, Polycarbonate, ABS.
 Colours Matt white, Gold.
 Light source 11.5W LED dimmable through wall dimmer. Compatible with bulbs of the energy classes: A++ - A. The built-in LEDs cannot be changed in this luminaire.
 Stock All colours

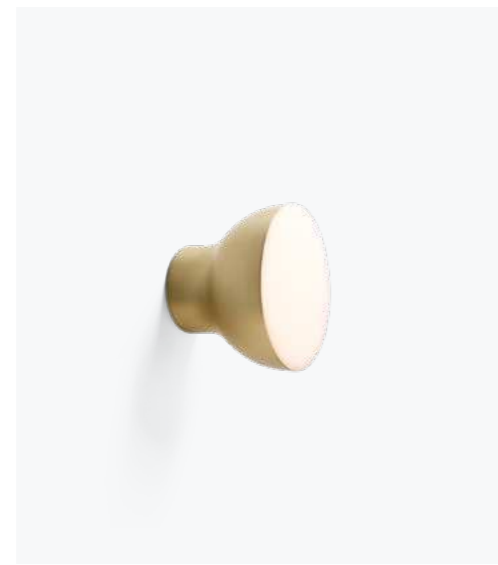
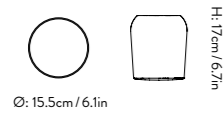

Passepartout JH11



Design Jaime Hayon | 2016
 Category Ceiling & wall lamp
 Materials Aluminium, Polycarbonate, ABS.
 Colours Matt white, Gold.
 Light source 11.5W LED dimmable through wall dimmer. Compatible with bulbs of the energy classes: A++ - A. The built-in LEDs cannot be changed in this luminaire.
 Stock All colours

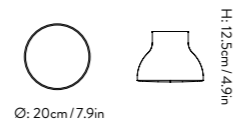

Passepartout JH12



Design Jaime Hayon | 2016
 Category Ceiling & wall lamp
 Materials Aluminium, Polycarbonate, ABS.
 Colours Matt white, Gold.
 Light source 11.5W LED dimmable through wall dimmer. Compatible with bulbs of the energy classes: A++ - A. The built-in LEDs cannot be changed in this luminaire.
 Stock All colours

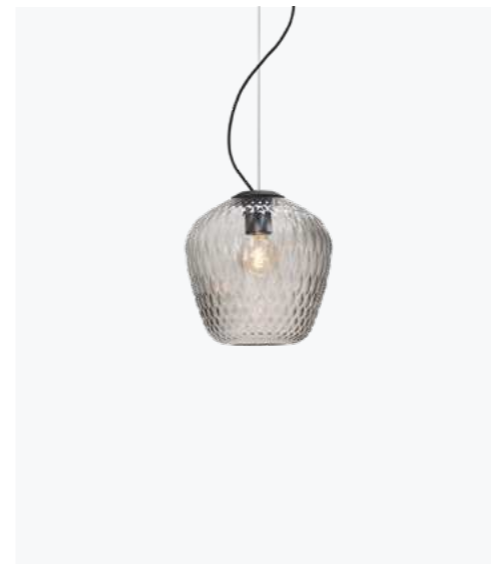
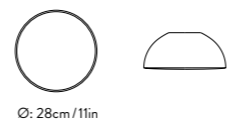

Blown SW3



Design Samuel Wilkinson | 2014
 Category Pendant
 Materials Mouth-blown glass, powder coated metal suspension, coated wire, 4-meter fabric cord.
 Colours Silver lustre, Opal.
 Light source E27 Max 100W. Compatible with bulbs of the energy classes: A++ - E. Bulb is not included.
 Stock All colours

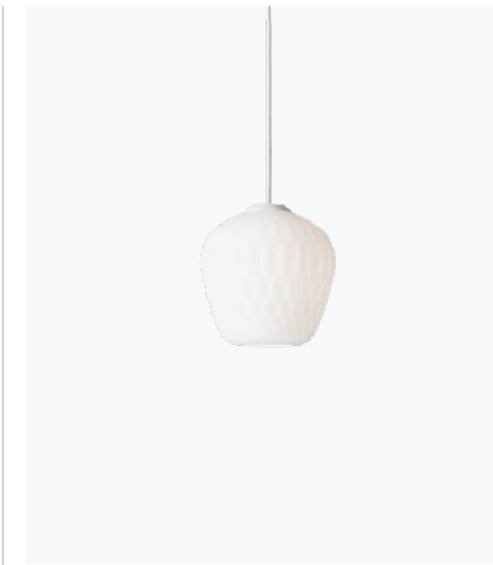
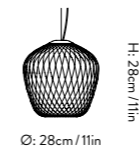

Blown SW4



Design Samuel Wilkinson | 2018
 Category Pendant
 Materials Mouth-blown glass, metal fitting, 4m fabric cord.
 Colours Silver lustre, Opal.
 Light source E14 Max 40W. Compatible with bulbs of the energy classes: A++ - E. Bulb is not included.
 Stock All colours

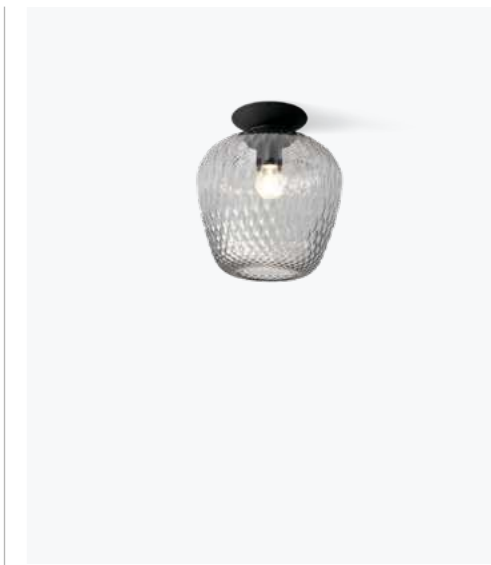

Blown SW5



Design Samuel Wilkinson | 2018
 Category Ceiling lamp
 Materials Mouth-blown glass, metal fitting.
 Colours Silver lustre, Opal.
 Light source E27 Max 60W. Compatible with bulbs of the energy classes: A++ - E. Bulb is not included.
 Stock All colours



Utzon JU1



Design Jørn Utzon | 1947
 Category Pendant
 Materials Lacquered metal, 3-meter fabric cord.
 Colours White, Brass.
 Light source E27 Max 60W. Compatible with bulbs of the energy classes: A++ - E. Bulb is not included.
 Stock All colours

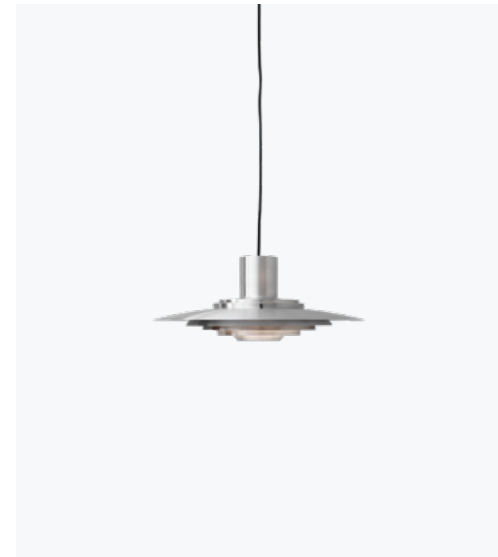
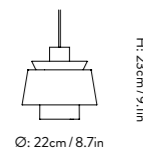

P376 KF1



Design Kastholm & Fabricius | 1963
 Category Pendant
 Materials Lacquered metal with fabric cord.
 Colours Matt white, Aluminium.
 Light source 220-240V - 50Hz. E27 Max 100W. Compatible with bulbs of energy classes: A++ - E. Bulb is not included.
 Stock All colours

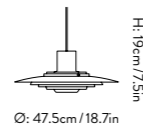

P376 KF2



Design Kastholm & Fabricius | 1963
 Category Pendant
 Materials Lacquered metal with fabric cord.
 Colours Matt white, Aluminium.
 Light source 220-240V - 50Hz. E27 Max 150W. Compatible with bulbs of energy classes: A++ - E. Bulb is not included.
 Stock All colours

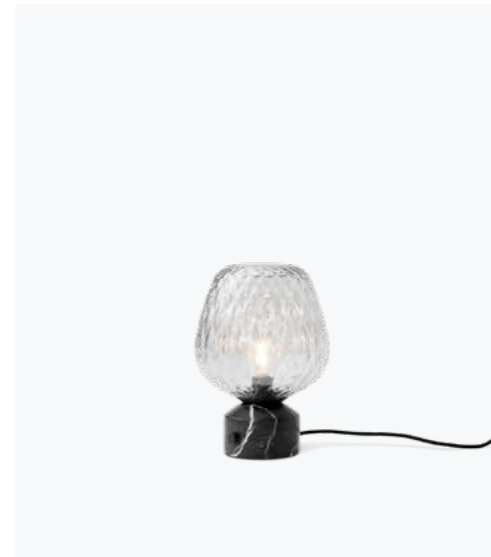
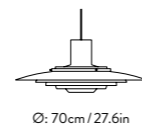

Blown SW6



Design Samuel Wilkinson | 2019
 Category Table lamp
 Materials Mouth-blown glass & Black marble base
 Light source E14 Max. 40 W. Compatible with bulbs of the energy classes: A++ - E. Bulb is not included.
 Stock All colours

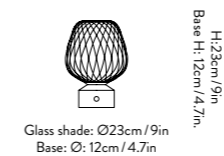

Tripod HM8



Design Hvidt & Mølgaard | 1953
 Category Floor lamp
 Materials Lacquered metal shade and base, lacquered brass, fabric cord with on/off switch.
 Colours Black, Maroon.
 Light source E27 Max 60W. The luminaire is compatible with bulbs of energy classes: A++ - E. Bulb is not included.
 Stock All colours

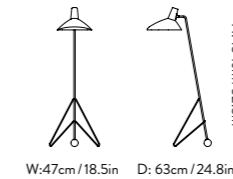

Bellevue AJ7



Design Arne Jacobsen | 1929
 Category Floor lamp
 Materials Satin polished and lacquered metal, cast iron base, 2 meter fabric cord with on-off switch.
 Colours Brass, Black & Brass, Black & Steel, White & Brass, Copper brown & Brass.
 Light source E27 Max 60W. Compatible with bulbs of the energy classes: A++ - E. Bulb is not included.
 Stock All colours

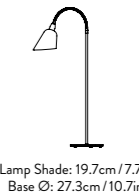

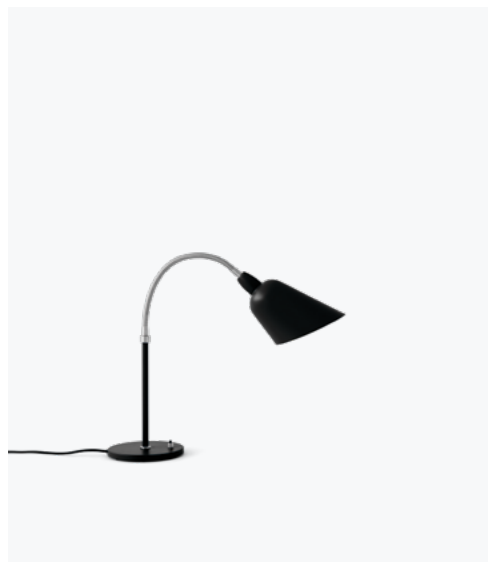

Bellevue AJ8



Design Arne Jacobsen | 1929
 Category Table lamp
 Materials Satin polished and lacquered metal, cast iron base, 2-meter fabric cord. On-off switch on base.
 Colours Brass, Black & Brass, Black & Steel, White & Brass, Copper brown & Brass.
 Light source E14 Max 40W. Compatible with bulbs of the energy classes: A++ - E. Bulb is not included.
 Stock All colours

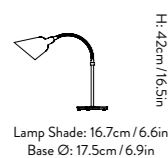

H: 42cm / 16.5in

Lamp Shade: 16.7cm / 6.6in
Base Ø: 17.5cm / 6.9in

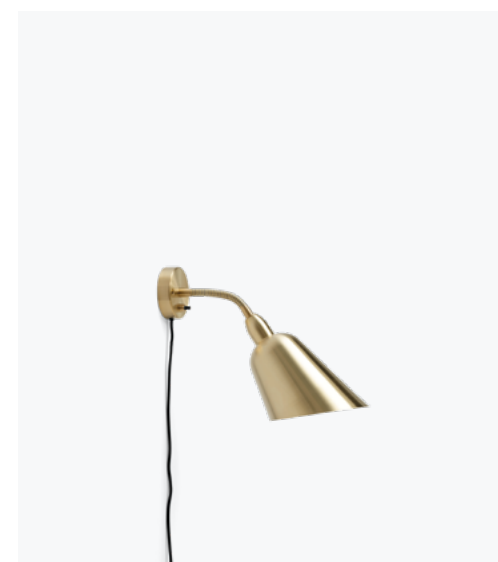

Bellevue AJ9



Design Arne Jacobsen | 1929
 Category Wall lamp
 Materials Satin polished and lacquered metal, cast iron base, 2 meter fabric cord. On-off switch on wall mount base.
 Colours Brass, Black & Brass, Black & Steel, White & Brass, Copper brown & Brass.
 Light source E14 Max 40W. Compatible with bulbs of the energy classes: A++ - E. Bulb is not included.
 Stock All colours

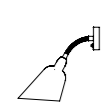

H: 30cm / 11.8in
Base Ø: 8.5cm / 3.3in

Lamp Shade: 16.7cm / 6.6in

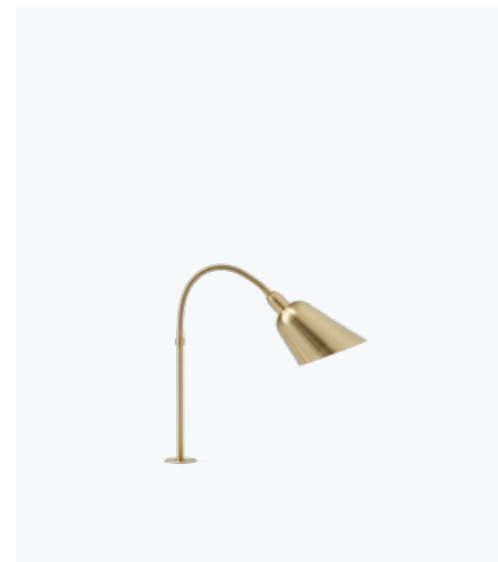

Bellevue AJ10



Design Arne Jacobsen | 1929
 Category Plug-in table lamp
 Materials Satin polished and lacquered metal, cast iron base, 2-meter fabric cord.
 Colours Brass, Black & Brass.
 Light source E14 Max 40W. The luminaire is compatible with bulbs of the energy classes: A++ - E. Bulb is not included.
 MTO (6-8 weeks)



Lamp Shade: 16.7cm / 6.6in
Base Ø: 12.5cm / 4.9in
W: 16.5cm / 6.5in



Fornell ABF1



Design Andreas Bozarth Fornell | 2017
 Category Pendant
 Materials Mirror polished & matt lacquered stainless steel, PC diffuser, 6m cable & stainless steel wires
 Colours Matt Black, Matt White.
 Light source 24W dimmable LED. Compatible with bulbs of the energy classes: A++ - A. The built-in LEDs cannot be changed in this luminaire.
 Stock All colours

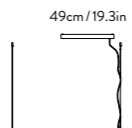

H: 49cm / 19.3in
W: 7.5cm / 2.9in
L: 120cm / 47.2in

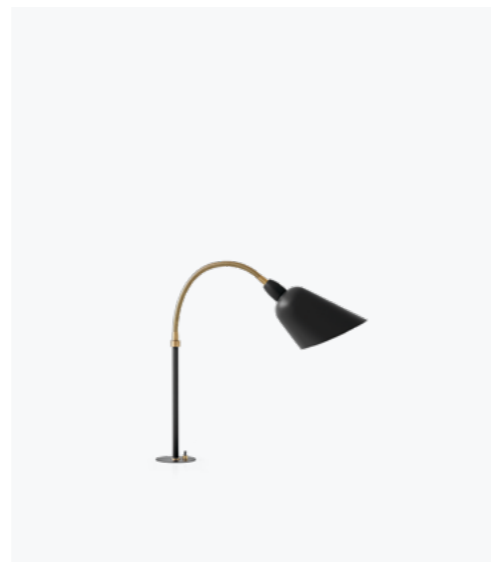

Bellevue AJ11



Design Arne Jacobsen | 1929
 Category Plug-in table lamp
 Materials Satin polished and lacquered metal, cast iron base, 2-meter fabric cord. On-off switch on base.
 Colours Brass, Black & Brass.
 Light source E14 Max 40W. The luminaire is compatible with bulbs of the energy classes: A++ - E. Bulb is not included.
 MTO (6-8 weeks)



H: 42cm / 16.5in
Base Ø: 8.5cm / 3.3in

Lamp Shade: 16.7cm / 6.6in
Base Ø: 9.5cm / 3.8in
W: 16.5cm / 6.5in



Topan VP6



Design Verner Panton | 1959
 Category Pendant
 Materials Lacquered aluminium with 3-meter fabric cord.
 Colours Matt white, Matt black, Mustard, Light blue, Red brown.
 Light source E27 Max 40W. Compatible with bulbs of the energy classes: A++ - E. Bulb is not included.
 Stock All colours



H: 19cm / 7.5in

Ø: 21cm / 8.3in

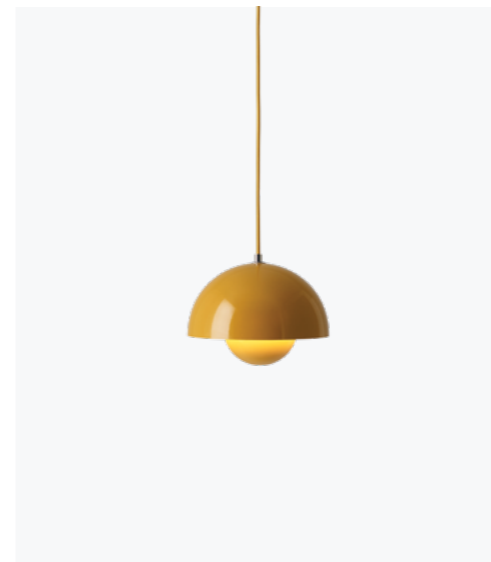

Flowerpot VP1



Design Verner Panton | 1968
 Category Pendant
 Materials Lacquered metal with 3-meter fabric cord.
 Colours Dark green, Mustard, Beige red, Red brown, Light blue, Grey beige, White, Matt white, Matt black, Matt light grey, Polished brass, Polished stainless steel, Polished copper.
 Light source E27 Max 40W. Compatible with bulbs of the energy classes: A++ - E. Bulb is not included.
 Stock All colours



H: 16cm / 6.3in

Ø: 23cm / 9.1in

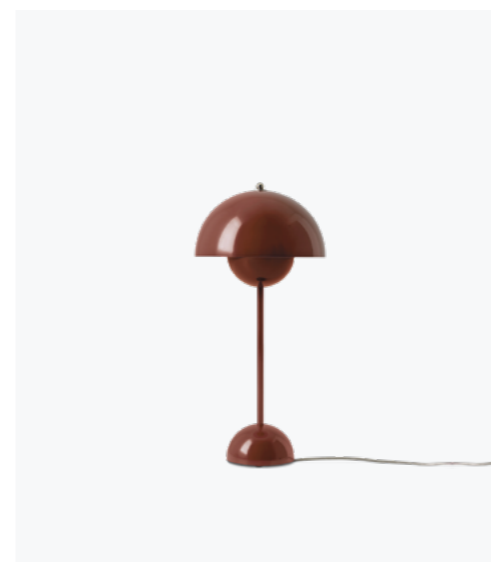

Flowerpot VP3



Design Verner Panton | 1969
 Category Table lamp
 Materials Lacquered steel with 2-meter clear PVC cord.
 Colours Dark green, Mustard, Beige red, Red brown, Light blue, Grey beige, White, Matt white, Matt black, Matt light grey, Polished stainless steel, Polished brass.
 Light source E27 Max 40W. Compatible with bulbs of the energy classes: A++ - E. Bulb is not included.
 Stock All colours



H: 50cm / 19.7in

Ø: 23cm / 9.1in

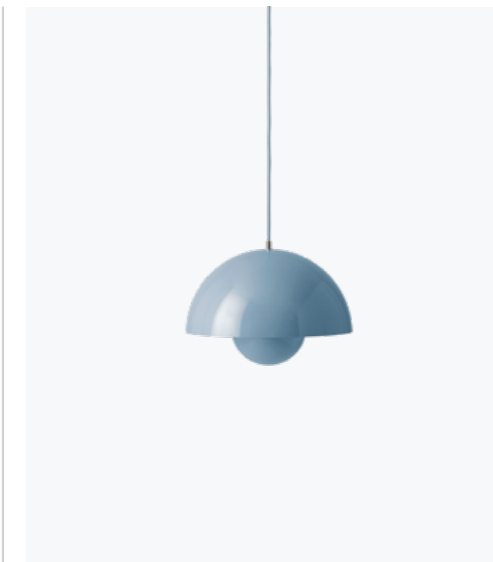

Flowerpot VP7



Design Verner Panton | 1968
 Category Pendant
 Materials Lacquered metal with 3-meter fabric cord.
 Colours Dark green, Mustard, Beige red, Red brown, Light blue, Grey beige, White, Matt white, Matt black, Matt light grey.
 Light source E27 Max 40W. The luminaire is compatible with bulbs of the energy classes: A++ - E. Bulb is not included.
 Stock All colours



H: 27cm / 10.6in

Ø: 37cm / 14.6in



Flowerpot VP4



Design Verner Panton | 1969
 Category Table lamp
 Materials Lacquered metal with 3-meter fabric cord.
 Colours Matt black, Matt white, Polished brass, Polished stainless steel.
 Light source E27 Max 40W. Compatible with bulbs of the energy classes: A++ - E. Bulb is not included.
 Stock All colours



H: 36cm / 14.2in

Ø: 23cm / 9.1in

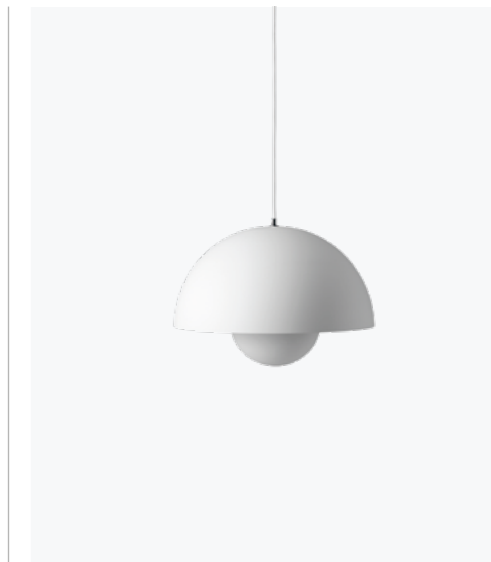

Flowerpot VP2



Design Verner Panton | 1968
 Category Pendant
 Materials Lacquered metal with 3-meter fabric cord.
 Colours Dark green, Mustard, Red brown, Grey beige, White, Matt white, Matt black, Matt light grey.
 Light source E27 Max 60W. Compatible with bulbs of the energy classes: A++ - E. Bulb is not included.
 Stock All colours



H: 36cm / 14.2in

Ø: 50cm / 19.7in

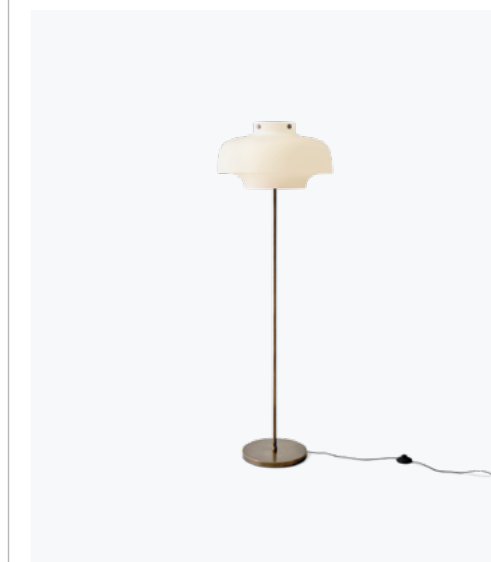

Copenhagen SC14

Design Space Copenhagen | 2014
 Category Floor lamp
 Materials Mouth-blown glass and bronzed brass.
 Colour Opal glass & Bronzed brass.
 Light source 18 Watt LED. The luminaire is energy class: A+. The built-in LED module can be replaced in this luminaire.
 Stock item All colours

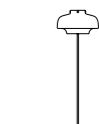

H: 150cm / 59.5in

Lamp: Ø: 50cm / 19.7in
Base: Ø: 30cm / 11.8in



Copenhagen SC6



Design Space Copenhagen | 2014
 Category Pendant
 Materials Lacquered steel shade or satinized opal glass shade with bronzed brass suspension, 4-meter black fabric cord.
 Colours Opal glass, Matt stone, Matt plum, Matt black.
 Light source G9 Max 40W. Compatible with bulbs of the energy classes: A++ - E. Bulb is not included.
 Stock All colours

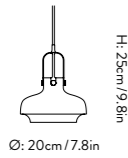

H: 25cm / 9.8in
 Ø: 20cm / 7.8in

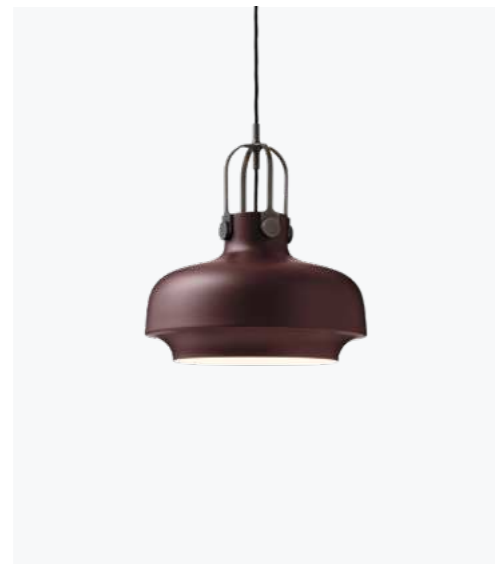

Copenhagen SC7



Design Space Copenhagen | 2014
 Category Pendant
 Materials Lacquered steel shade or satinized opal glass shade with bronzed brass suspension, 4-meter black fabric cord.
 Colours Opal glass, Matt stone, Matt plum, Matt black.
 Light source E27 Max 100W. Compatible with bulbs of the energy classes: A++ - E. Bulb is not included.
 Stock All colours

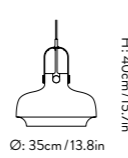

H: 40cm / 15.7in
 Ø: 35cm / 13.8in



Copenhagen SC8



Design Space Copenhagen | 2014
 Category Pendant
 Materials Lacquered aluminum shade with bronzed brass suspension, 6-meter fabric cord with safety wire.
 Colours Matt stone, Matt plum, Matt black.
 Light source E27 Max 150W. Compatible with bulbs of the energy classes: A++ - E. Bulb is not included.
 Stock All colours

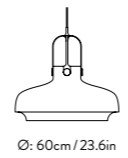

H: 53cm / 20.7in
 Ø: 60cm / 23.6in

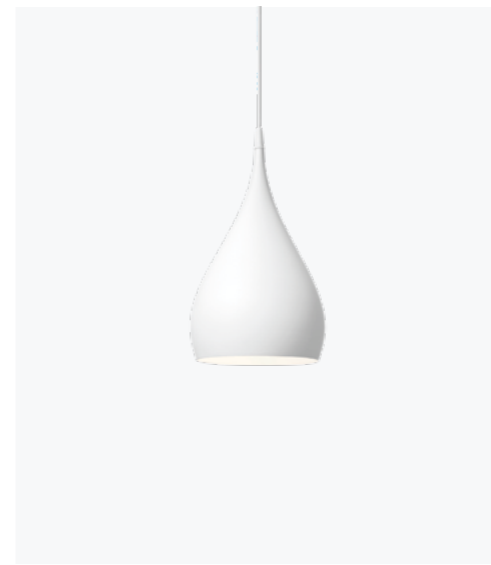

Spinning BH1



Design Benjamin Hubert | 2010
 Category Pendant
 Materials Lacquered aluminium with 4-meter PVC cord.
 Colours Matt white, Matt dark grey, Matt black.
 Light source E27 Max 60W. Compatible with bulbs of the energy classes: A++ - E. Bulb is not included.
 Stock All colours

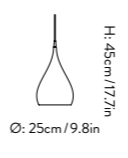

H: 45cm / 17.7in
 Ø: 25cm / 9.8in

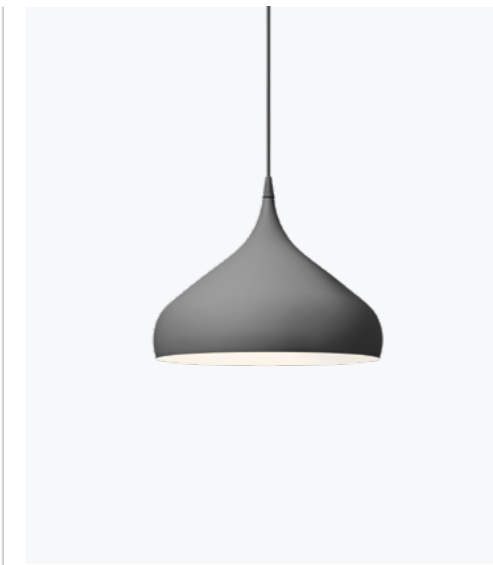

Spinning BH2



Design Benjamin Hubert | 2010
 Category Pendant
 Materials Lacquered aluminium with 4-meter PVC cord.
 Colours Matt white, Matt dark grey, Matt black.
 Light source E27 Max 60W. Compatible with bulbs of the energy classes: A++ - E. Bulb is not included.
 Stock All colours

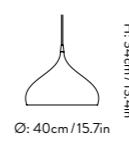

H: 34cm / 13.4in
 Ø: 40cm / 15.7in

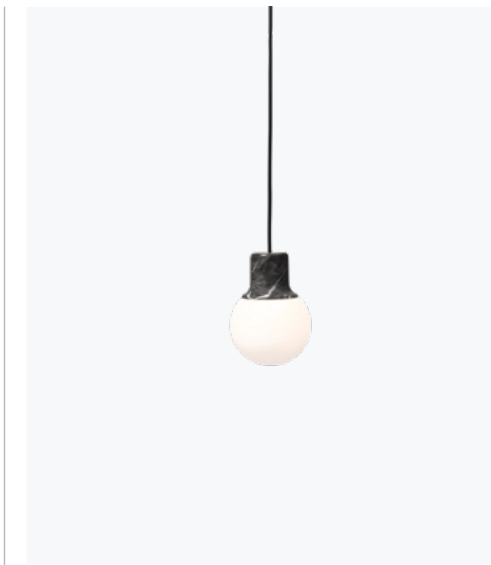

Mass Light NA5



Design Norm Architects | 2012
 Category Pendant
 Materials Nero Marquina marble or brass, opal glass, 4-meter black fabric cord.
 Colours Nero Marquina, Brass.
 Light Source G9 Max 40W. Compatible with bulbs of the energy classes: A++ - E. Bulb is not included.
 Stock All colours

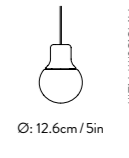

H: 18.3cm / 7.2in
 Ø: 12.6cm / 5in



Copenhagen SC13

Design Space Copenhagen | 2018
 Category Table lamp
 Materials Mouth-blown glass and bronzed brass.
 Colour Opal glass & Bronzed brass.
 Light source 8W LED. The luminaire is energy class: A+. The built-in LED module can be replaced in this luminaire.
 Stock item All colours



H: 42cm / 16.5in
 Lamp: Ø: 33cm / 13in
 Base: Ø: 17.5cm / 6.9in



Copenhagen SC15

Design Space Copenhagen | 2018
 Category Desk lamp
 Materials Mouth-blown glass and bronzed brass.
 Colour Opal glass & Bronzed brass.
 Light source 5,5W LED. The luminaire is energy class: A. The built-in LED module cannot be replaced in this luminaire.
 Stock item All colours



H: 37cm / 14.6in
 Lamp: Ø: 16cm / 6.3in
 Base: Ø: 17.5cm / 6.9in
 L: 38cm / 15in

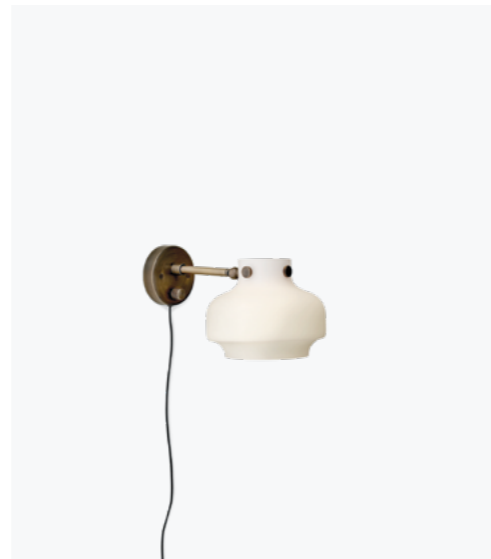

Copenhagen SC16

Design Space Copenhagen | 2018
 Category Wall lamp
 Materials Mouth-blown glass and bronzed brass.
 Colour Opal glass & Bronzed brass.
 Light source 5,5W LED. The luminaire is energy class: A. The built-in LED module cannot be replaced in this luminaire.
 Stock item All colours

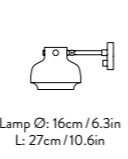

Base Ø: 9cm / 3.5in
 Lamp Ø: 16cm / 6.3in
 L: 27cm / 10.6in

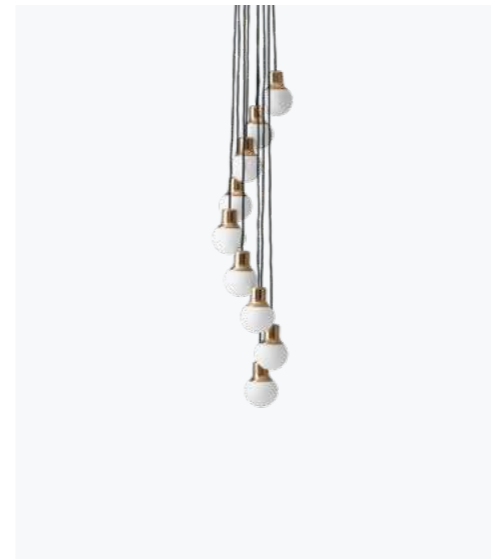

Mass Light NA6



Design Norm Architects | 2012
 Category Chandelier
 Materials Nero Marquina marble or brass, opal glass, 4-meter black fabric cord.
 Colours Nero Marquina, Brass.
 Light source 9 x G9 Max 40W. Compatible with bulbs of the energy classes: A++ - E. Bulbs are not included.
 Stock All colours

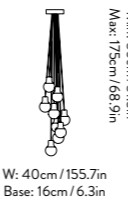

W: 40cm / 15.7in
 Base: 16cm / 6.3in
 Min: 80cm / 31.5in
 Max: 175cm / 68.9in

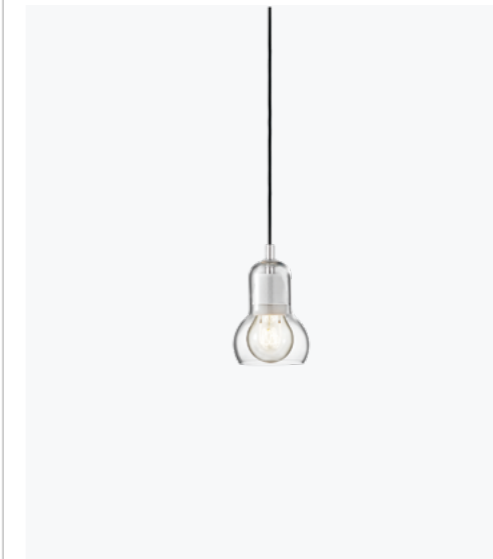

Bulb SR1



Design Sofie Refer | 2001
 Category Pendant
 Materials Mouth blown glass with 3-meter cord and porcelain lamp holder.
 Colours Clear glass with clear cord, Clear glass with black fabric cord.
 Light source E27 Max 60W. Compatible with bulbs of the energy classes: A++ - E. Bulb is not included.
 Stock All colours

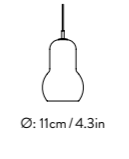

H: 16.3cm / 6.4in
 Ø: 11cm / 4.3in

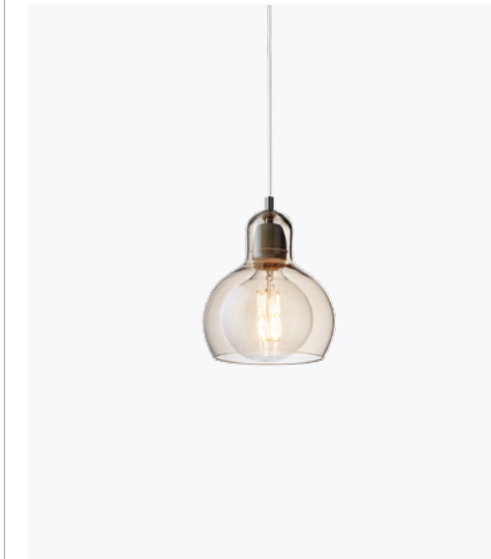

Mega Bulb SR2



Design Sofie Refer | 2006
 Category Pendant
 Materials Mouth blown glass with 3-meter cord and porcelain lamp holder.
 Colours Clear glass with black fabric cord or clear cord, Silver lustre glass with black fabric cord or clear cord, Gold glass with white fabric cord or clear cord.
 Light source E27 Max 60W. Compatible with bulbs of the energy classes: A++ - E. Bulb is not included.
 Stock All colours

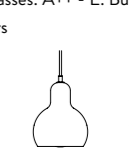

H: 23cm / 9in
 Ø: 18cm / 7.1in



Formakami JH3

Design Jaime Hayon | 2015
 Category Pendant
 Materials Ivory white paper, black stained oak, 4-meter black fabric cord.
 Colours Ivory white.
 Light source 2 × E27 Max 60W. Compatible with bulbs of the energy classes: A++ - E. Bulbs are not included.
 Stock All colours

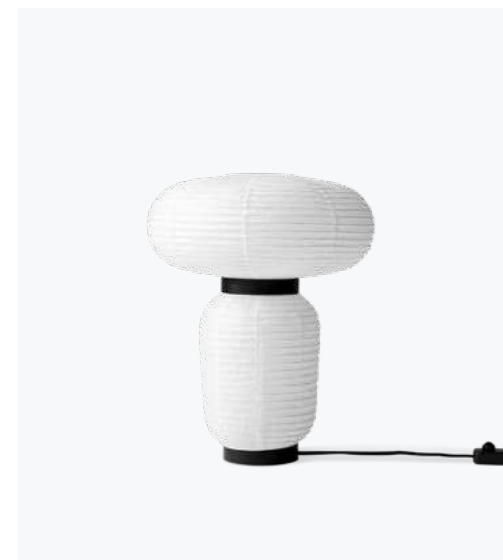
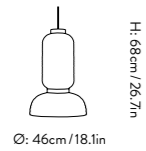

Formakami JH18

Design Jaime Hayon | 2018
 Category Table lamp
 Materials Ivory white paper, black stained oak, 2-meter black fabric cord with dimmer.
 Colours Ivory white.
 Light source 2 × E27 Max 60W. Compatible with bulbs of the energy classes: A++ - E. Bulbs are not included.
 Stock All colours



Formakami JH4

Design Jaime Hayon | 2015
 Category Pendant
 Materials Ivory white paper, black stained oak, 4-meter black fabric cord.
 Colours Ivory white.
 Light source 2 × E27 Max 60W. Compatible with bulbs of the energy classes: A++ - E. Bulbs are not included.
 Stock All colours

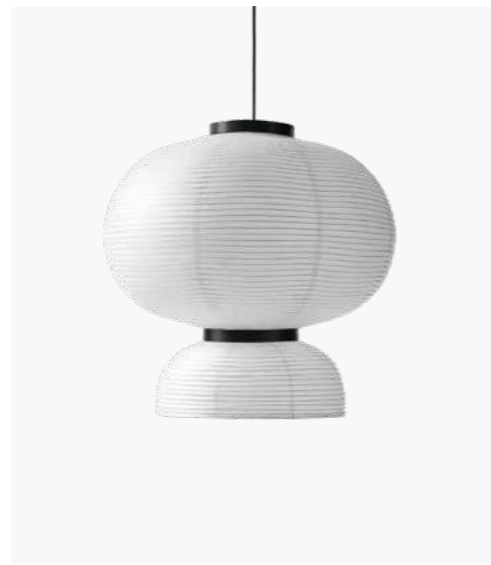
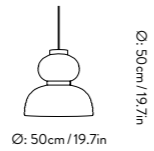

Formakami JH5

Design Jaime Hayon | 2015
 Category Pendant
 Materials Ivory white paper, black stained oak, 4-meter black fabric cord.
 Colours Ivory white.
 Light source 2 × E27 Max 60W. Compatible with bulbs of the energy classes: A++ - E. Bulbs are not included.
 Stock All colours

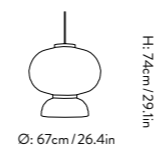

© &Tradition 2020

Creative direction & Graphic design: All the Way to Paris
 Photography: Anders Schönemann | Casper Sejersen |
 Brian Buchard | Klunderbie | Yellows Studio
 Styling: All the Way to Paris | Sofie Brünnner
 Archive images: Langelinie Pavilion | © Verner Pantton Design |
 Hvidt & Mølgaard Furniture

