

CATALOGO 2019

ENGLISH

Alfa, Alfia, Alice, Andrea, Anna, Ara, Arcadia, Bea, Beta, Camilla, Cassiopea, Chiara, Cielo, Clio, Delta, Dooku, Eclipse, Emma, Epsilon, Franco, Gamma, Giulia, Hyperion, Idra, Iota, Jackie, K12, Kamino, Kirk, LaDina, Leila, Leo, Marco, Martina, Martina Aqua, Melrie, Memi, Midna, Naboo, New Torcia, Pan, Paola, Pat, Perseo, Petra, Pi, Rho, Sam, Sandro, Sigma, Silvia, Spock, Talia, Tapioca, Tau, Trixie, Vincenza, Viviana, Yama, Zefiro.



ares

THE OUTDOOR BY FLOS

MADE IN ITALY

ares
THE OUTDOOR BY FLOS



COMPANY

Established in 1994, Aresis is a manufacturing company specialized in architectural outdoor lighting. Our Aim is to offer to our customers products of actual design representative of our time, thanks to a strong commitment and great creativity. The attentive selection of materials and accurate finishing, as well as the research and development of the manufacturing

process; make our products durable and reliable; a cutting – edge for the market worldwide. Each creation is a challenge: understanding, analyzing and projecting to reach harmony and fusion of structure, light, architecture and setting.



LIGHTING DESIGN OFFICE

Light is an essential tool in the Architectural language. Our Lighting Design projects are the results of a careful analysis of the spaces, along with the attention to the customer's need; in order to offer comfort, safety and efficiency.



TECHNICAL OFFICE

When engineering a new luminaire, there are several factors to consider: aesthetic and functional needs of the final fixture; accurate selection of the light sources, the materials and their heat sink capacity, and technologies to be used; achievement of the best lighting emission. The creation of a functional prototype is an important step, that allows the

improvements of all the elements and a precise balance of the creative stages progression.

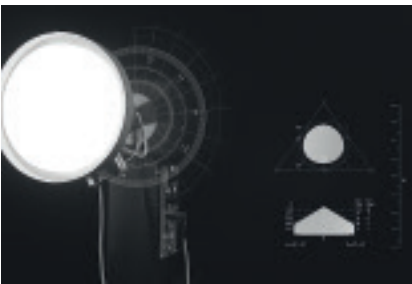

LABORATORY

In our laboratory we test lighting fixtures safety and performances, to refine both technical and quality characteristics of all our products.



ALUMINIUM DIE CASTING

Die casting process is one of the most considerable and important steps during the manufacturing of our products. With passion, we follow each step of productive process, from the mould manufacturing to the die casted item and the quality checks that assure the solidity and the mechanical property.

We choose Aluminium as main material and we only use top quality alloy with low-copper content, to guarantee a high resistance to corrosion.



TURNING

Versatility and definition are the basic elements of our production. What identify and characterize our Luminaires, is the High quality and the elaborate manufacturing that requires the application of different material such as, primary aluminium, 316L stainless steel and methacrylate.



RAW MATERIALS STOCK

The raw material is attentively selected, all the incoming goods are tested following the in force directives, and stored in the main warehouse for direct use.



PAINTING PROCESS

ARES has done an important investment in a new and implemented painting facility and coating procedure, that guarantees good resistance even in extreme climatic conditions. A controlled conversion treatment, a first layer of epoxy powder coating and a second layer of polyester powder coating, offer high mechanical solidity and UV resistance, a warranty of

high quality and performances for the whole selection of 5 standard colours. The thickness and the adherence of the film are constantly measured by specific tests. It is our commitment to respect the environment and the directives in force; Coating procedures are followed by daily careful tests.



LED

A direct and deep knowledge of LED light sources, of the engineering and assembly of printed circuits and boards, allows Ares to take care of each productive step: from the design of the circuit, to the realization of the luminaire. "Ares LED" is an internal productive unit, entirely dedicated to the development, production and assembly of high technology LED fixtures. The main characteristics are

an high efficiency in lighting emission and reduced power consumption. A warehouse where thousands of LED and components are stored is precisely managed and controlled in order to offer products with the highest colour uniformity and quality possible. The unit consists of different and specialized areas and each of these areas is focused on a single step of the production.



ASSEMBLY

Electrical and Mechanical assembly lines follow procedures and operating instructions to assemble luminaires.

A trained and specialized staff is in charge for the tests of quality of the products that have to be in compliance with regulation in force.

Particular attention is given to the electrical safety checks on the luminaires.



PACKING AND DELIVERY

Each single products is carefully prepared and packed with extremely care. A piece of truly Italian style is now ready to be delivered all over the world.

Ares sales distribution reaches all 5 continents, which represents the 75% of the turnover.

LED TECHNOLOGY

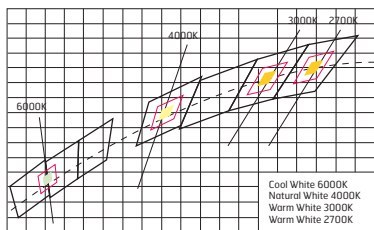
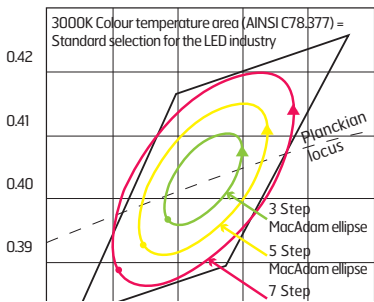
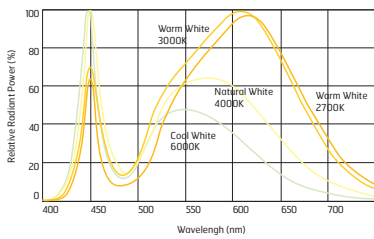
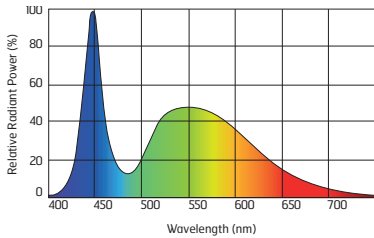
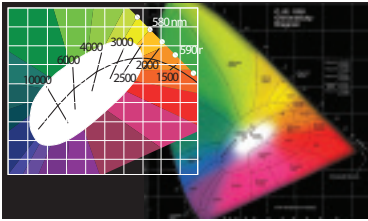

In order to get a white LED, nowadays just as 20 years ago, one is made which emits a light blue known as royal blue, and it is given a coating by mixing phosphorus types, that is a mix of components which are excited by the wave length of Royal Blue and can emit white light, the color temperature (CCT) depends on the specifics of the mix. Diode technology underlies LEDs, a diode being an electronic component whose functioning depends on the behavior of two regions next to each other with different chemical characteristics. On the basis of the various twinned regions, a LED will be able to emit a precise wave length, in other words generate a specific color; as white is not a color but a mix of all of them together, it is clear why conversions of some kind cannot be avoided. Given the growth in the availability of different selections of CCT, and the market's desire for quality, a universal and standardized method of cataloging was soon codified as ANSI 78.377-2008.

It was necessary to define a space on which the light emitted by a LED could be defined, and within this space a series of regions could be delimited in order to define their different color temperatures. The space of the colors C.I.E. xyz was used, one of the first to be defined mathematically (1931), while to delimit the different color regions, it was natural to extend the Planckian place (in other words, the group of various shades of white which a Black Body assumes if taken to various temperatures), and thus a series of rhombuses was created, each of which was next to another and centered on the black body curve known as the ANSI BIN. By means of the mathematics of conversion of the same color space and the spectral distribution of the light emitted by a LED, it can be inserted into the graph and then described precisely. While in so-called cold LEDs the blue contribution is greater (obviously on the 460nm characteristics of the LED on which the white has been constructed), as the temperature is reduced if a warm LED is observed it is clear that the phosphorus have a more important role to play in lowering the blue component and gene rating a new component at the same time, which becomes predominant around 600nm (typical of yellow). For these purposes the percentage of 'Rare Lands' in the phosphorus mix is altered.

is very similar to the BlackBody. There are also different color tables which can be used for the comparison and increasing the number of 'color samples' obviously improves the definition of the CRI. As well as the standard, nowadays the LED leads the main manufacturers to compare themselves to each other and improve the light efficiency and quality on a daily basis. Two different strategies are becoming important for the selection of the BINs. The simpler, which has been more commonly used for some time, divides the ANSI BINs into narrower and narrower sub-regions in order to obtain portions which are 1/16 the size of the standard. This gives companies assembling LEDs a refined degree of selection for the finished product. The second possibility undertaken by manufacturers was that of reintroducing an old model based on a more favorable geometry, namely MacAdam's Ellipses. The advantage of this proposal is the geometry involved which, with the same surface area as ANSI automatically excludes the points which are further from the geometric center, that is the tops of the rhombuses which as a result of their construction are the regions with more variation in chromatic homogeneity. Clearly this is not sufficient to guarantee that the selections have a high degree of precision. In fact the quality of this system depends once again on the dimensions of the geometric places themselves and to complete the model different ellipses must be type-tested, all of them centered on precise chromatic coordinates (and so always referable to C.I.E. 1931), more and more reduced in surface area. For these purposes they are defined as MacAdam's Steps. Step3 is currently important in the marketplace since, if directly compared to the ANSI Standard, it is equal to half an ANSI BIN.

As is normal for any Energy transformation when the conversion work is increased the efficiency decreases, and this explains why warm white LEDs are less efficient than cold ones. This is also true for LEDs with a high color rendering index (CRI). The CRI, as its name suggests, is an index and it expresses how a light source, when compared to a reference sample, can reproduce colors. By definition the reference sample should be Plank's Black Body, obviously in the same CCT conditions. In any event, for practical purposes it is possible to use an incandescent lamp which by definition and construction

SPD: Protection against excess voltage for outdoor LED fixtures



The use of light-emitting diodes (LEDs) and electronics in lighting equipment has highlighted the problem of excessive voltage caused by direct or indirect electrical charges. In the cases studied 80% of damage refer to improper/abnormal feeding.

These problems may arise from:
 - disturbances inherent in the electricity mains; insertion or removal of strongly reactive charges, faults in the cables, or a strong harmonic distortion in the mains;
 - excessive charges arising from the environment: direct or indirect atmospheric discharges or unexpected and excessive

accumulation of electrostatic charges on the equipment.
 ARES offers an SPD (Surge Protector Device) which can be connected near the appliances requiring protection or above the derivation box.



This device functions in common and differential manner at the same time, by absorbing any excessive voltage and discharging it, depending on its nature, towards earth or neutral.
 The closer it is installed to the appliances requiring protection, the more effective this type of protection is, and it should be remembered that an earth connection is needed to protect the appliance effectively.

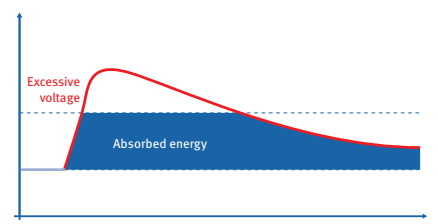

Operating Ac Voltage	275V
Maximun Discharge Current 8/20µs Waveform (Imax)	10KA
Maximun Operating Current	5A
IP Protection	66

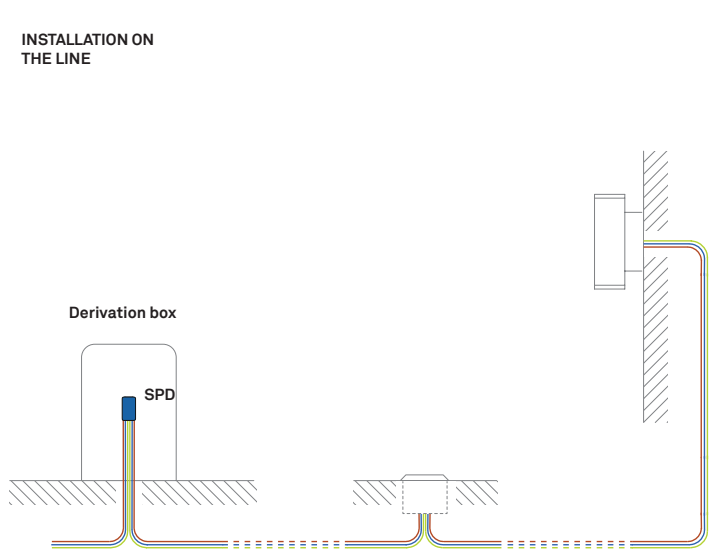
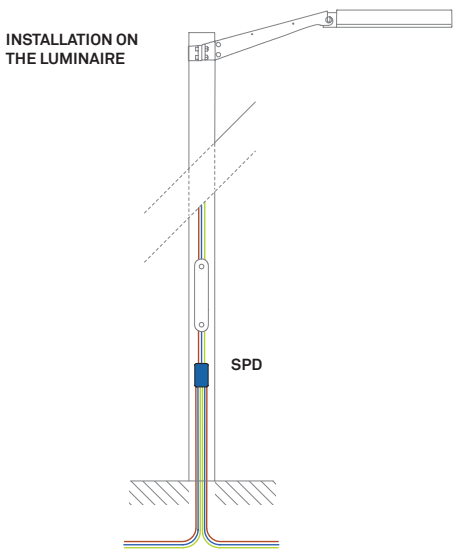

ARES shall not be held liable for the installation of plants not complying with the regulation in force.

H2O STOP: how to stop water ingress - in ground recessed luminaires

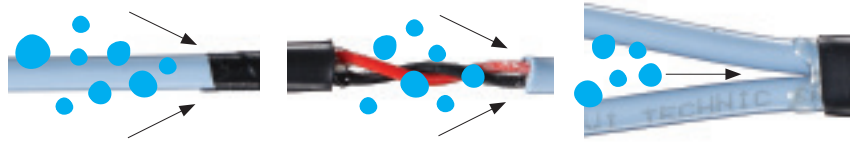

An inaccurate installation of the luminaire with ineffective connection (insulating tape, self-amalgamating tape or sheath inaccurately used) may lead to water passage along the cable and consequently water ingress in the fitting.



All ground recessed luminaires are equipped with a H2O STOP system or resin coated devices giving effective protection against water passage along connecting cables.

FINISHING COLOURS: double layer coating for high resistance to corrosion.

Double layer coating for high resistance to corrosion: The aluminium components are painted with a double coat using powders which are compliant with QUALICOAT standards: a first layer of epoxy powder (with excellent chemical and mechanical resistance) and a second finishing layer of polyester powder (resistant to UV rays and atmospheric agents). The entire painting process of the aluminium fitting starts from components which have been sand-blasted in advance to make the surface more porous and increase the adherence of the paint. Ares effects alkaline and acid washing to clean the surfaces completely, then rinses with demineralised water to remove any residue particles, subsequently a chemical conversion treatment is done to protect against rusting.

Corrosion tests in artificial atmospheres: salt spray test passed at 1500 hrs

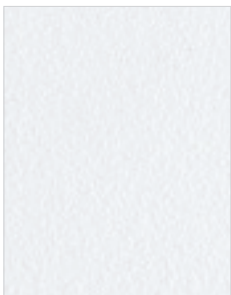

.1 White



.6 Grey

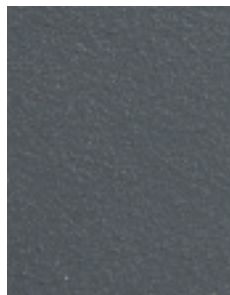

.3 Anthracite

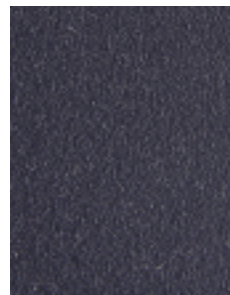

.4 Black



.18 Deep Brown

During the installation and the maintenance of the fixtures it is important to be careful and avoid damages on the paint coating. Damages on the coating exposed to outdoor conditions or water, could cause corrosion. Chemical substances affect the anticorrosion covering protection.

INDEX

DECORATIVE

LADINA
28



GROUND RECESSED

NABOO
32



KAMINO
48



K12
56



TAPIOCA
68



CASSIOPEA
82



CIELO
90



GROUND RECESSED

RHO
102



SIGMA
110



BEA
120



CHIARA
124



CLIO
130



PETRA
136



IDRA
140



WALL RECESSED

K12
56



TAPIOCA
68



RHO
102



SIGMA
110



CHIARA
124



TRIXIE
146



CAMILLA
152



ALICE
158



ALFIA
164



CEILING RECESSED

TAPIOCA

68



CIELO

90



RHO

102



SIGMA

110



LEILA

170



ARA

184



BOLLARD

VINCENZA
190



NEW TORCIA
220



ZEFIRO
198



SILVIA
226



TALIA
204



PAN
368



SANDRO
210



HYPERION
378



VIVIANA
214



LEO
418



POLE TOP

DOOKU
238



PERSEO
290



FRANCO
314



ANDREA
338



PROJECTOR

DOOKU
238



FRANCO
314



SPOCK
266



MARTINA
344



KIRK
260



PI
362



IOTA
278



PAN
368



PERSEO
290



UNDERWATER

MARTINA AQUA
354



WALL/CEILING

ANNA
18



GIULIA
384



ARCADIA
388



TAU
410



ALFA
504



BETA
508



PAT
532



SAM
538



PAOLA
542



WALL

ZEFIRO
198



EMMA
470



NEW TORCIA
220



EPSILON
492



ECLIPSE
374



DELTA
498



HYPERION
378



GAMMA
512



LEO
418



MARCO
516



MIDNA
454



JACKIE
524



MELRIE
462



MEMI
528



CEILING

YAMA
548





- Outdoor / Indoor round luminaire for installation on ceiling or wall – surface mounted.
- Configuration: opal plastic diffuser with satin finish for a high light emission uniformity ratio. Die-cast aluminium fixing back-plate and turned aluminium structure and heat sink. Magnetic finish frame to hide the fixing screws. The luminaire is coated with polyester powders in single or double colour.
- Protection rating: IP66
- In compliance with EN 60598-1 standards
- Class of Insulation: I
- Installation: the luminaire is equipped with two IP65 cable holders for rubber cables 5\times10mm (Anna Ø210 and Ø310) or cables 6\times13mm (Anna Ø410) and a quick-connect 2-pole terminal block. Outdoor installation requires suitable flexible cables assuring the watertightness of the cable holder.
- During the installation and the maintenance of the fixtures it is important to be careful and avoid damages on the paint coating. Damages on the coating exposed to outdoor conditions or water, could cause corrosion. Chemical substances affect the anticorrosion covering protection.

EU Regulation 874/2012 - Illumination equipment energy classes



LED VERSION:
Class A/A+/A++
Luminaire supplied with integrated LED modules that cannot be replaced



Ceiling fitting



Wall fitting



The fitting is equipped with 2 cable input.



Protection against impact.
IK 10- 20,00 joule

Anna 210

Light Source: Mid-Power LED / 8,8W / Total power 11W / CRI>80 / 220÷240V / Integral electronic power supply



533050
White 2700K
lm LED 1202 ≈ lm OUTPUT 732

533002
White 3000K
lm LED 1292 ≈ lm OUTPUT 787

533001
White 4000K
lm LED 1334 ≈ lm OUTPUT 812

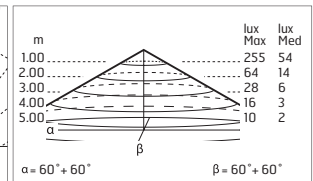
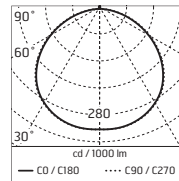

@ 4000K

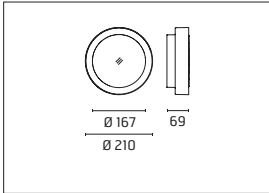

IP66

Anna 210 - Bicolour Structure White-Yellow

Light Source: Mid-Power LED / 8,8W / Total power 11W CRI>80 / 220÷240V / Integral electronic power supply

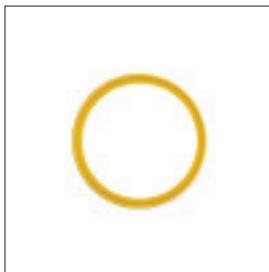

533053
White 2700K
lm LED 1261 ≈ lm OUTPUT 765

533007
White 3000K
lm LED 1292 ≈ lm OUTPUT 787

533003
White 4000K
lm LED 1334 ≈ lm OUTPUT 812

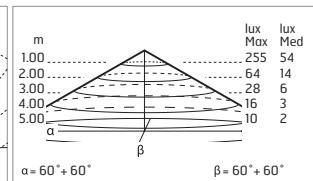
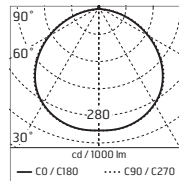

@ 4000K

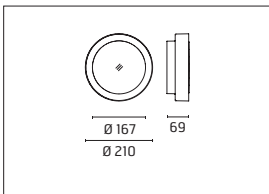

IP66

Anna 210 - Bicolour Structure White-Orange

Light Source: Mid-Power LED / 8,8W / Total power 11W / CRI>80 / 220÷240V / Integral electronic power supply

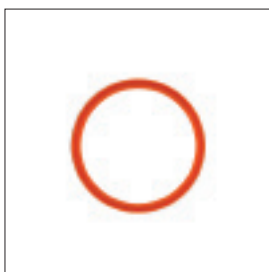

533054
White 2700K
lm LED 1202 ≈ lm OUTPUT 732

533008
White 3000K
lm LED 1292 ≈ lm OUTPUT 787

533004
White 4000K
lm LED 1334 ≈ lm OUTPUT 812

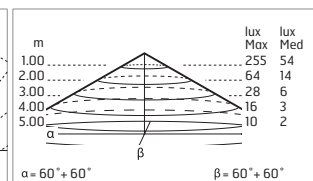
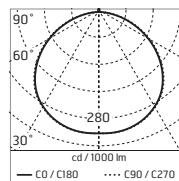

@ 4000K

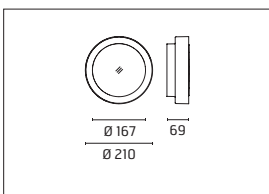

IP66

Anna 210 - Bicolour Structure White-Brown

Light Source: Mid-Power LED / 8,8W / Total power 11W / CRI>80 / 220÷240V / Integral electronic power supply

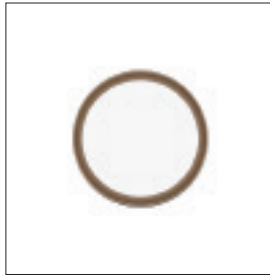

533055
White 2700K
lm LED 1202 ≠ lm OUTPUT 732

533009
White 3000K
lm LED 1292 ≠ lm OUTPUT 787

533005
White 4000K
lm LED 1334 ≠ lm OUTPUT 812

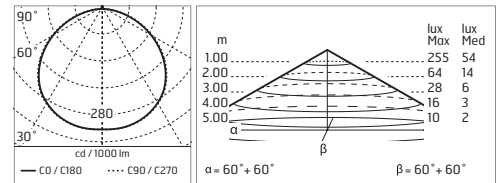
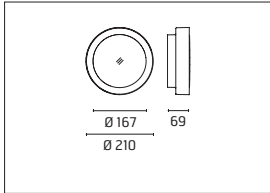

@ 4000K

IP66

Anna 210 - Bicolour Structure White-Green

Light Source: Mid-Power LED / 8,8W / Total power 11W / CRI>80 / 220÷240V / Integral electronic power supply

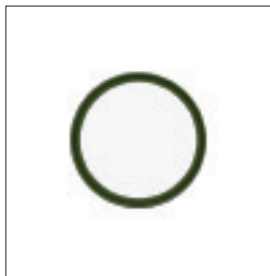

533056
White 2700K
lm LED 1202 ≠ lm OUTPUT 732

533010
White 3000K
lm LED 1292 ≠ lm OUTPUT 787

533006
White 4000K
lm LED 1325 ≠ lm OUTPUT 812

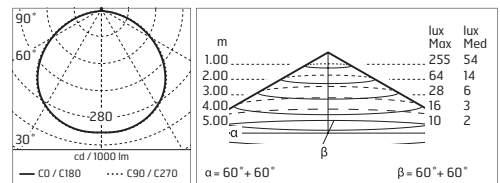
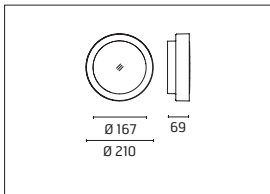

@ 4000K

IP66

Anna310

Light Source: Mid-Power LED / 14,1W / Total power 18W / CRI>80 / 220÷240V / Integral electronic power supply



533051
533051-300 Dimmable Dali
533051-310 Dimmable 1-10
 White 2700K
 lm LED 1874 ≠ lm OUTPUT 1150

533012
533012-300 Dimmable Dali
533012-310 Dimmable 1-10
 White 3000K
 lm LED 2015 ≠ lm OUTPUT 1237

533011
533011-300 Dimmable Dali
533011-310 Dimmable 1-10
 White 4000K
 lm LED 2168 ≠ lm OUTPUT 1330

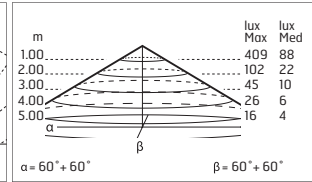
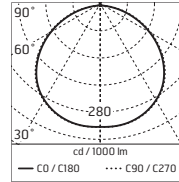
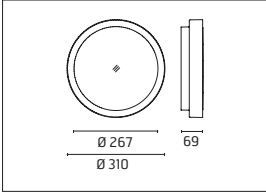

@ 4000K

IP66

Anna310 - Bicolour Structure White-Yellow

Light Source: Mid-Power LED / 14,1W / Total power 18W / CRI>80 / 220÷240V / Integral electronic power supply



533057
533057-300 Dimmable Dali
533057-310 Dimmable 1-10
 White 2700K
 lm LED 1874 ≠ lm OUTPUT 1150

533017
533017-300 Dimmable Dali
533017-310 Dimmable 1-10
 White 3000K
 lm LED 2015 ≠ lm OUTPUT 1237

533013
533013-300 Dimmable Dali
533013-310 Dimmable 1-10
 White 4000K
 lm LED 2168 ≠ lm OUTPUT 1330

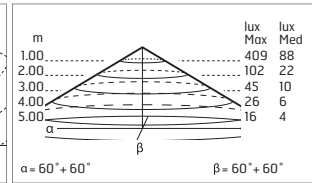
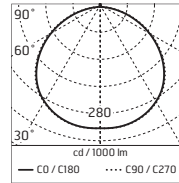
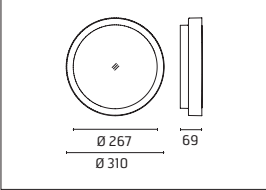

@ 4000K

IP66

Anna310 - Bicolour Structure White-Orange

Light Source: Mid-Power LED / 14,3W / Total power 15,5W / CRI>80 / 220÷240V / Integral electronic power supply



533058
533058-300 Dimmable Dali
533058-310 Dimmable 1-10
 White 2700K
 lm LED 1874 ≠ lm OUTPUT 1150

533018
533018-300 Dimmable Dali
533018-310 Dimmable 1-10
 White 3000K
 lm LED 2015 ≠ lm OUTPUT 1237

533014
533014-300 Dimmable Dali
533014-310 Dimmable 1-10
 White 4000K
 lm LED 2168 ≠ lm OUTPUT 1330

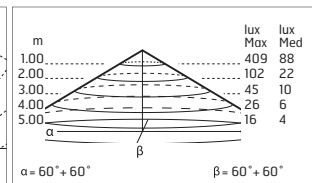
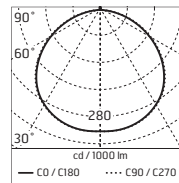
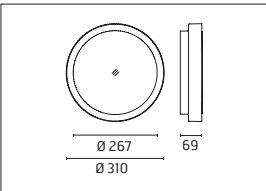

@ 4000K

IP66

Anna310 - Bicolour Structure White-Brown

Light Source: Mid-Power LED / 14,1W / Total power 18W / CRI>80 / 220÷240V / Integral electronic power supply

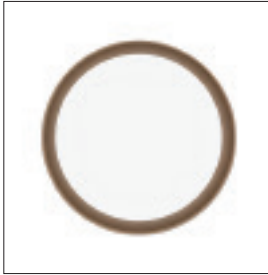

533059
533059-300 Dimmable Dali
533059-310 Dimmable 1-10
 White 2700K
 lm LED 1874 ≠ lm OUTPUT 1150

533019
533019-300 Dimmable Dali
533019-310 Dimmable 1-10
 White 3000K
 lm LED 2015 ≠ lm OUTPUT 1237

533015
533015-300 Dimmable Dali
533015-310 Dimmable 1-10
 White 4000K
 lm LED 2168 ≠ lm OUTPUT 1330

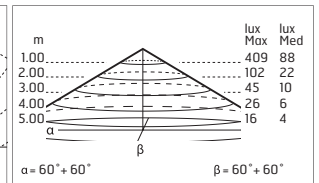
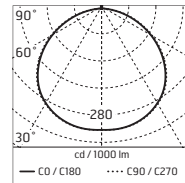
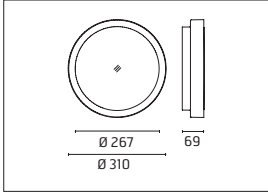

@ 4000K

IP66

Anna310 - Bicolour Structure White-Green

Light Source: Mid-Power LED / 14,1W / Total power 18W / CRI>80 / 220÷240V / Integral electronic power supply

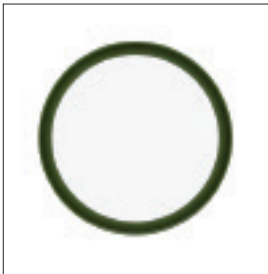

533060
533060-300 Dimmable Dali
533060-310 Dimmable 1-10
 White 2700K
 lm LED 1874 ≠ lm OUTPUT 1150

533016
533016-300 Dimmable Dali
533016-310 Dimmable 1-10
 White 3000K
 lm LED 2015 ≠ lm OUTPUT 1237

533020
533020-300 Dimmable Dali
533020-310 Dimmable 1-10
 White 4000K
 lm LED 2168 ≠ lm OUTPUT 1330

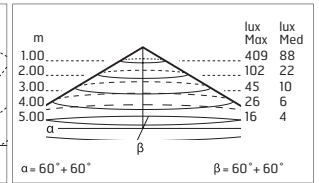
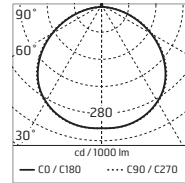
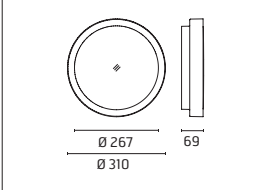

@ 4000K

IP66

Anna410

Light Source: Mid-Power LED / 27,9W / Total power 34W / CRI>80 / 220÷240V / Integral electronic power supply



533052
533052-300 Dimmable Dali
533052-310 Dimmable 1-10
 White 2700K
 lm LED 3590 ≠ lm OUTPUT 2345

533022
533022-300 Dimmable Dali
533022-310 Dimmable 1-10
 White 3000K
 lm LED 3860 ≠ lm OUTPUT 2521

533021
533021-300 Dimmable Dali
533021-310 Dimmable 1-10
 White 4000K
 lm LED 4152 ≠ lm OUTPUT 2712

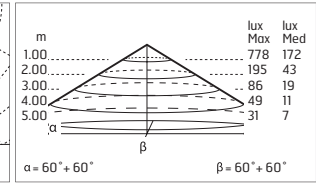
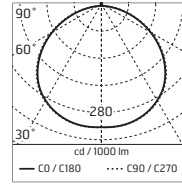
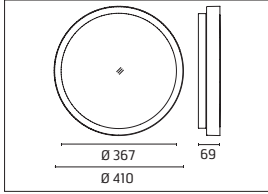

@ 4000K

IP66

Anna410 - Bicolour Structure White-Yellow

Light Source: Mid-Power LED / 27,9W / Total power 34W / CRI>80 / 220÷240V / Integral electronic power supply

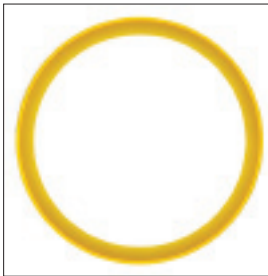

533061
533061-300 Dimmable Dali
533061-310 Dimmable 1-10
 White 2700K
 lm LED 3590 ≠ lm OUTPUT 2345

533023
533023-300 Dimmable Dali
533023-310 Dimmable 1-10
 White 3000K
 lm LED 3860 ≠ lm OUTPUT 2521

533027
533027-300 Dimmable Dali
533027-310 Dimmable 1-10
 White 4000K
 lm LED 4152 ≠ lm OUTPUT 2712

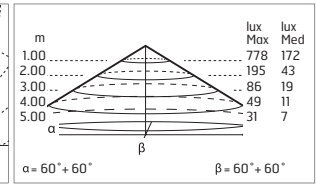
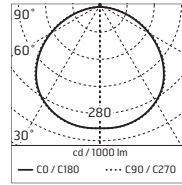
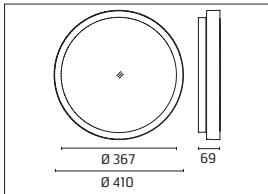

@ 4000K

IP66

Anna410 - Bicolour Structure White-Orange

Light Source: Mid-Power LED / 27,9W / Total power 34W / CRI>80 / 220÷240V / Integral electronic power supply

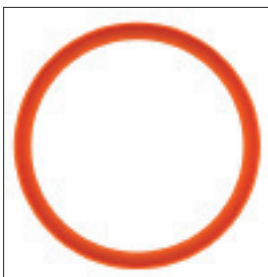

533062
533062-300 Dimmable Dali
533062-310 Dimmable 1-10
 White 2700K
 lm LED 3590 ≠ lm OUTPUT 2345

533024
533024-300 Dimmable Dali
533024-310 Dimmable 1-10
 White 3000K
 lm LED 3860 ≠ lm OUTPUT 2521

533028
533028-300 Dimmable Dali
533028-310 Dimmable 1-10
 White 4000K
 lm LED 4152 ≠ lm OUTPUT 2712

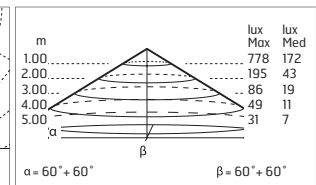
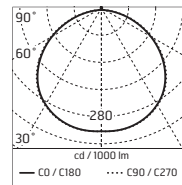
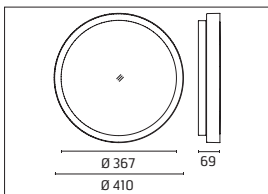

@ 4000K

IP66

Anna410 - Bicolour Structure White-Brown

Light Source: Mid-Power LED / 27,9W / Total power 34W / CRI>80 / 220÷240V / Integral electronic power supply

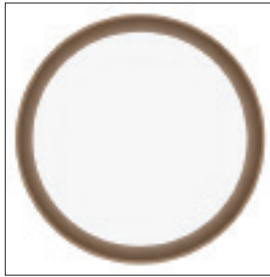

533063
533063-300 Dimmable Dali
533063-310 Dimmable 1-10
 White 2700K
 lm LED 3590 ≠ lm OUTPUT 2345

533029
533029-300 Dimmable Dali
533029-310 Dimmable 1-10
 White 3000K
 lm LED 3860 ≠ lm OUTPUT 2521

533025
533025-300 Dimmable Dali
533025-310 Dimmable 1-10
 White 4000K
 lm LED 4152 ≠ lm OUTPUT 2712

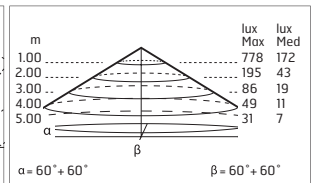
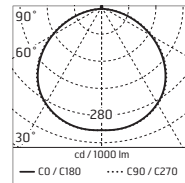
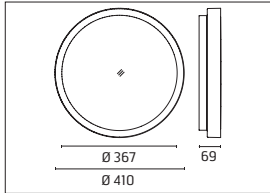

@ 4000K

IP66

Anna410 - Bicolour Structure White-Green

Light Source: Mid-Power LED / 27,9W / Total power 34W / CRI>80 / 220÷240V / Integral electronic power supply

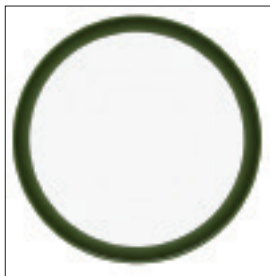

533064
533064-300 Dimmable Dali
533064-310 Dimmable 1-10
 White 2700K
 lm LED 3590 ≠ lm OUTPUT 2345

533030
533030-300 Dimmable Dali
533030-310 Dimmable 1-10
 White 3000K
 lm LED 3860 ≠ lm OUTPUT 2521

533026
533026-300 Dimmable Dali
533026-310 Dimmable 1-10
 White 4000K
 lm LED 4152 ≠ lm OUTPUT 2712

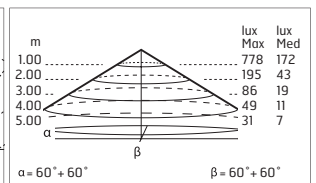
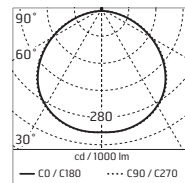
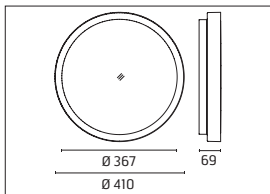

@ 4000K

IP66



Accessories: Anna

237

SPD: (SURGE PROTECTION DEVICE) 275Vac
 MAXIMUM DISCHARGE CURRENT 10KA (8/20µs)
 MAXIMUM OPERATING CURRENT 5A
 SUITABLE FOR SERIES CONNECTION - IP66

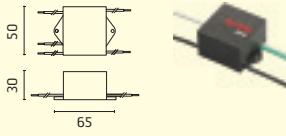

acc. code ▶	dimm DALI	dimm 1-10	237
533001			•
533002			•
533003			•
533004			•
533005			•
533006			•
533007			•
533008			•
533009			•
533010			•
533011	-300	-310	•
533012	-300	-310	•
533013	-300	-310	•
533014	-300	-310	•
533015	-300	-310	•
533016	-300	-310	•
533017	-300	-310	•
533018	-300	-310	•
533019	-300	-310	•
533020	-300	-310	•
533021	-300	-310	•
533022	-300	-310	•
533023	-300	-310	•
533024	-300	-310	•
533025	-300	-310	•
533026	-300	-310	•
533028	-300	-310	•
533027	-300	-310	
533029	-300	-310	•
533030	-300	-310	•
533050			•
533051			•
533052	-300	-310	•
533053	-300	-310	•
533054			•
533055			•
533056			•
533057	-300	-310	•
533058	-300	-310	•
533059	-300	-310	•
533060	-300	-310	•
533061	-300	-310	•
533062	-300	-310	•
533063	-300	-310	•
533064	-300	-310	•



LaDina

- Decorative portable/ suspended lamp.
- Configuration: polyethylene structure with satin white emitting unit and colour closing screw-on cap. Anti-loosening system.
- Protection rating: IP44
- In compliance with EN60598-1 standards
- Class of Insulation: II
- Installation: the luminaire is equipped with a 5000mm black neoprene cable, a CEE 7/17 plug (schuko compatible) and a Velcro strap to coil the cable up or to be wrapped around the handle for a quick fixing as suspended lamp.

EU Regulation 874/2012 - Illumination equipment energy classes

A

FLUORESCENT VERSION:
Class A
TC-TSE/E27

LamegaDina

- Decorative portable floor lamp.
- Configuration: polyethylene structure with satin white emitting unit and colour closing screw-on cap. Anti-loosening system.
- Protection rating: IP44
- In compliance with EN60598-1 standards
- Class of Insulation: II
- Installation: the luminaire is equipped with a 5000mm black neoprene cable and a CEE 7/17 plug (schuko compatible).



Floor Lamp
LamegaDina



Suspended Lamp
LaDina



The fitting is
equipped with
1 cable input
with plug.
Cable length: 5000mm

Snow



Sand



Fuchsia



Land



Night



Carrot



LaDina



- 500001 - Snow
- 500002 - Sand
- 500003 - Fuchsia
- 500004 - Land
- 500005 - Night
- 500006 - Carrot

TC-TSE 20Wmax/230V E27
(Ø max bulb 53mm)

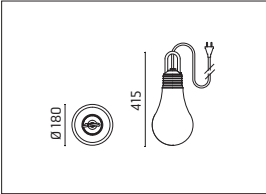
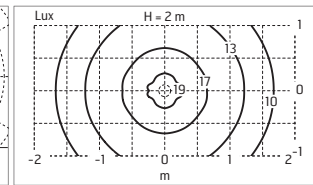
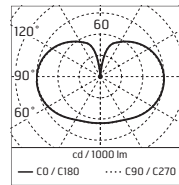

Photometric curve not available

IP44

LamegaDina



- 500007 - Snow
- 500008 - Sand
- 500009 - Fuchsia
- 5000010 - Land
- 5000011 - Night
- 5000012 - Carrot

TC-TSE 30Wmax/230V E27
(Ø max bulb 87mm)

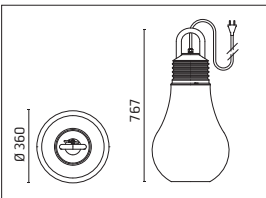
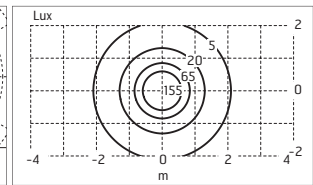
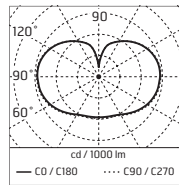

Photometric curve not available

IP44





- Round luminaire for installation in-ground – recessed.
- Configuration: three sizes available. Die-cast aluminium structure and heat sink, EN AB-47100 alloy (low copper content). AISI 316L stainless steel outer frame. Glass diffuser: transparent with silkscreen border.
- Double layer coating for high resistance to corrosion: the aluminium components are painted with a double coat using powders which are compliant with QUALICOAT standards: a first layer of epoxy powder (with excellent chemical and mechanical resistance) and a second finishing layer of polyester powder (resistant to UV rays and atmospheric agents). The entire painting process of the aluminium fitting starts from components which have been sandblasted in advance to make the surface more porous and increase the adherence of the paint. Ares effects alkaline and acid washing to clean the surfaces completely, then rinses with demineralised water to remove any residue particles, subsequently a chemical conversion treatment is done to protect against rusting.
- Light Emission: Fully adjustable optic, different beams
- Protection rating: IP67
- In compliance with EN60598-1 standards
- Class of insulation: II
- Installation: the luminaire is equipped with a watertight M12 screw-connector providing optimal insulation against water ingress and quick connection to the power supply unit (supplied with the luminaire as a remote IP67 Kit with electronic power supply). The power supply unit is equipped with a piece of cable of 400mm with screw connector towards the luminaire and a piece of cable of 300mm to be used for wiring. Outdoor use requires suitable flexible cables. Installation requires a dedicated box to be ordered separately. It is important to provide a >300mm gravel layer or a drain system (for concrete surface) to ensure good drainage and to avoid water stagnation.
- We recommend the use of a connection system with a protection degree greater than or equal to the protection degree of the luminaire.
- During the installation and the maintenance of the fixtures it is important to be careful and avoid damages on the paint coating. Damages on the coating exposed to outdoor conditions or water, could cause corrosion. Chemical substances affect the anticorrosion covering protection.

EU Regulation 874/2012 - Illumination equipment energy classes

A++
A+
A

LED VERSION:
Class A/A+/A++
Luminaire supplied with integrated LED modules that cannot be replaced



.0 Inox



Recessed ground fitting



Installation requires a 30cm water drainage layer (gravel)



Do not install in hollow areas



Pre-wired with approx 250mm of cable



Protection against water ingress from the cable



Naboo 145 - Naboo 225
Static load: 2000Kg walk over
Naboo 290
Static load: 3000Kg walk over



Drive over



Glass surface temperature <70°C



Protection against impact
IK 10 - 20,00 joule

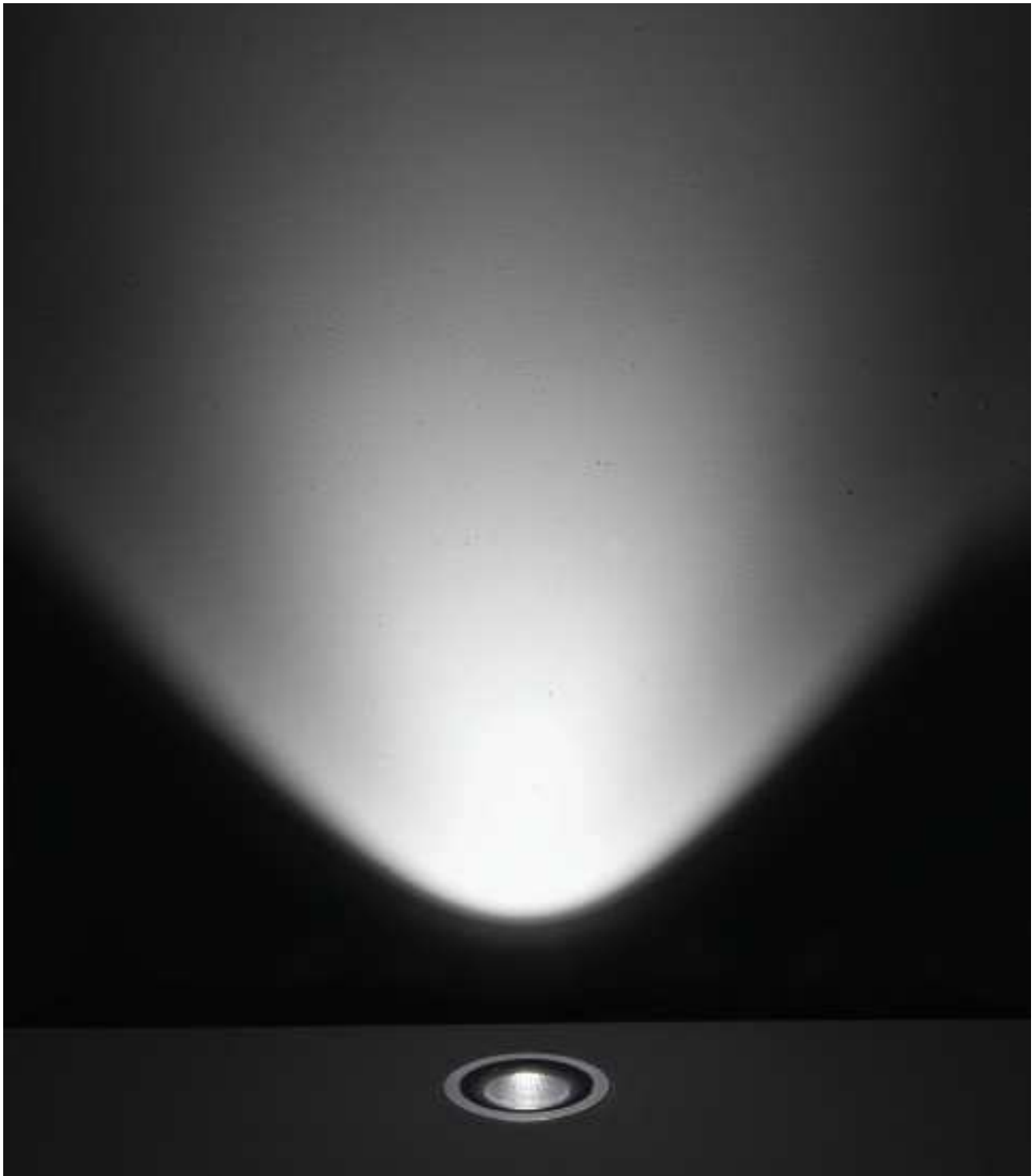

Adjustment on the horizontal axis: max 15°

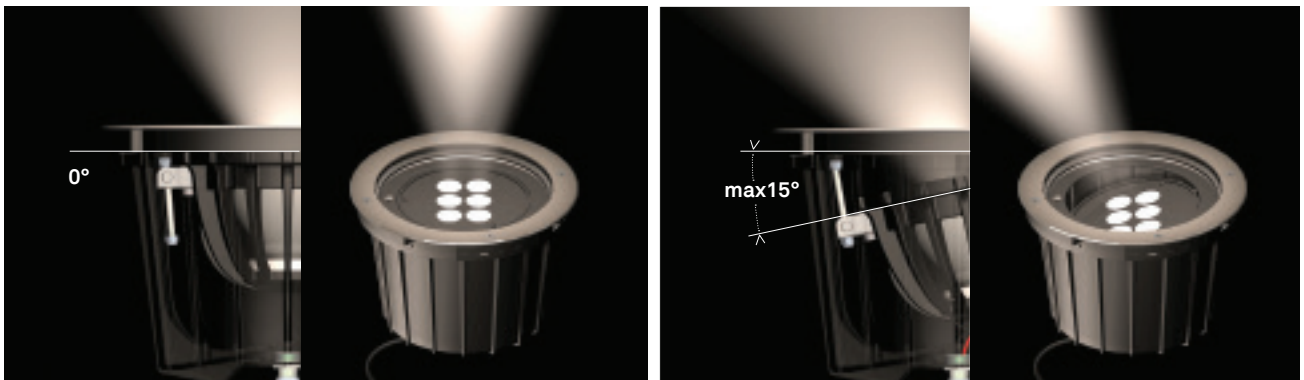



Rotation around the vertical axis: max 359°

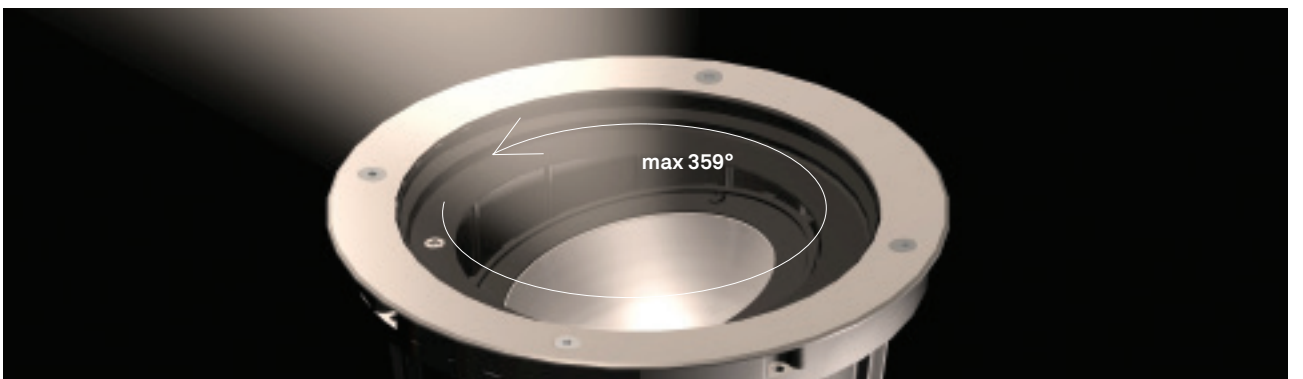

Naboo



Naboo145 - Adjustable Optic - 10°

Light Source: Power LED / 6W / Total power 8W / CRI>80 / 220÷240V / Kit with remote electronic power supply included

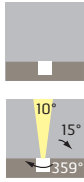

534051
White 2700K
lm LED 509 ≠ lm OUTPUT 541

534003
White 3000K
lm LED 547 ≠ lm OUTPUT 485

534002
White 4000K
lm LED 630 ≠ lm OUTPUT 558

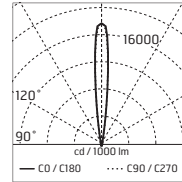

m	α	β	lux	
			Max	Med
5.00	5.0° + 5.0°	5.0° + 5.0°	408	273
4.00			638	426
3.00			1134	757
2.00			2552	1704
1.00			10206	6815

@ 4000K

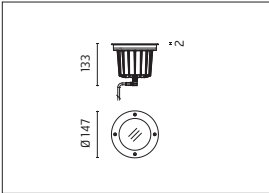

Dimmable on request

IP67

Naboo145 - Adjustable Optic - 24°

Light Source: Power LED / 6W / Total power 8W / CRI>80 / 220÷240V / Kit with remote electronic power supply included

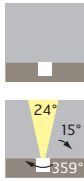

534052
White 2700K
lm LED 509 ≠ lm OUTPUT 472

534006
White 3000K
lm LED 547 ≠ lm OUTPUT 507

534005
White 4000K
lm LED 630 ≠ lm OUTPUT 583

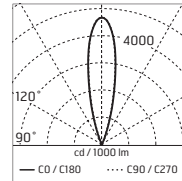

m	α	β	lux	
			Max	Med
5.00	12.0° + 12.0°	12.0° + 12.0°	110	70
4.00			172	109
3.00			306	194
2.00			689	437
1.00			2756	1747

@ 4000K

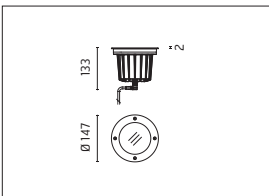

Dimmable on request

IP67

Naboo145 - Adjustable Optic - 50°

Light Source: Power LED / 6W / Total power 8W / CRI>80 / 220÷240V / Kit with remote electronic power supply included

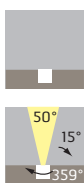

534053
White 2700K
lm LED 509 ≠ lm OUTPUT 433

534009
White 3000K
lm LED 547 ≠ lm OUTPUT 466

534008
White 4000K
lm LED 630 ≠ lm OUTPUT 536

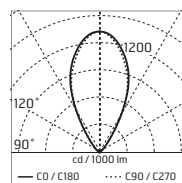

m	α	β	lux	
			Max	Med
5.00	25.0° + 25.0°	25.0° + 25.0°	25	14
4.00			40	21
3.00			70	38
2.00			158	85
1.00			633	338

@ 4000K

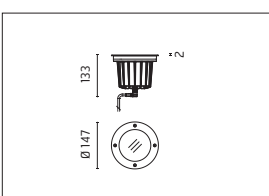

Dimmable on request

IP67

Naboo145 - Adjustable Optic- Asymmetric 54°x 66°

Light Source: Power LED / 6W / Total power 8W / CRI>80 / 220÷240V / Kit with remote electronic power supply included

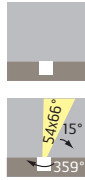

534054
White 2700K
lm LED 509 ≈ lm OUTPUT 413

534012
White 3000K
lm LED 547 ≈ lm OUTPUT 444

534011
White 4000K
lm LED 630 ≈ lm OUTPUT 511

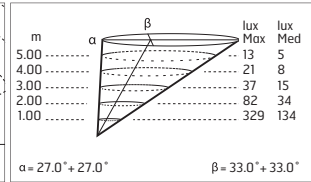
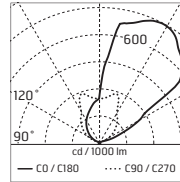

@ 4000K

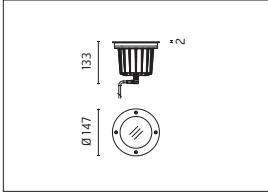

Dimmable on request

IP67

Naboo145 - Adjustable Optic - 16°

Light Source: CoB LED / 6W / Total power 9W / CRI>80 / 220÷240V / Kit with remote electronic power supply included

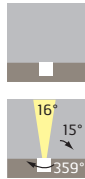
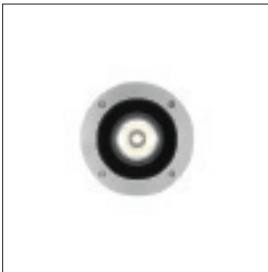

534055
White 2700K
lm LED 857 ≈ lm OUTPUT 518

534015
White 3000K
lm LED 547 ≈ lm OUTPUT 444

534014
White 4000K
lm LED 922 ≈ lm OUTPUT 557

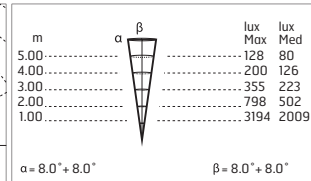
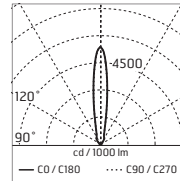

@ 4000K

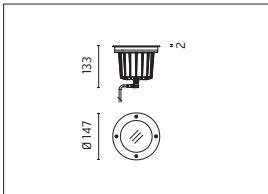

Dimmable on request

IP67

Naboo145 - Adjustable Optic - 50°

Light Source: CoB LED / 6W / Total power 9W / CRI>80 / 220÷240V / Kit with remote electronic power supply included

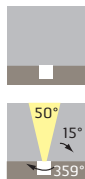
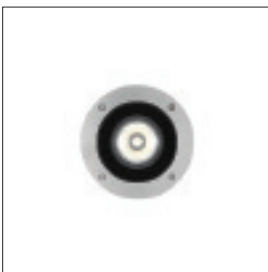

534056
White 2700K
lm LED 857 ≈ lm OUTPUT 545

534018
White 3000K
lm LED 922 ≈ lm OUTPUT 586

534017
White 4000K
lm LED 959 ≈ lm OUTPUT 610

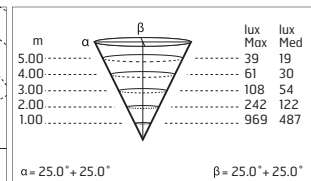
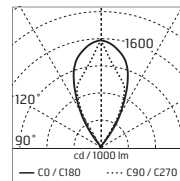

@ 4000K

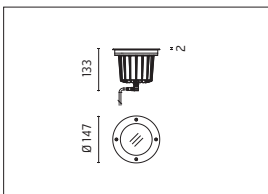

Dimmable on request

IP67

Naboo225 - Adjustable Optic - 10°

Light Source: Power LED / 16,8W / Total power 21W / CRI>80 / 220÷240V / Kit with remote electronic power supply included

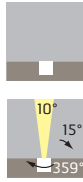

534057
534057-300 Dimmable Dali
534057-310 Dimmable 1-10
 White 2700K
 lm LED 1691 ≠ lm OUTPUT 1373

534021
534021-300 Dimmable Dali
534021-310 Dimmable 1-10
 White 3000K
 lm LED 1818 ≠ lm OUTPUT 1476

534020
534020-300 Dimmable Dali
534020-310 Dimmable 1-10
 White 4000K
 lm LED 1935 ≠ lm OUTPUT 1572

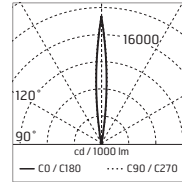

m	lux	
	Max	Med
5.00	1185	679
4.00	1852	1060
3.00	3292	1885
2.00	7408	4242
1.00	29631	16967

$\alpha = 5.0^\circ + 5.0^\circ$ $\beta = 5.0^\circ + 5.0^\circ$

@ 4000K

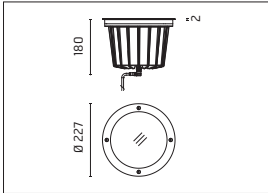

IP67

Naboo225 - Adjustable Optic - 35°

Light Source: Power LED / 16,8W / Total power 21W / CRI>80 / 220÷240V / Kit with remote electronic power supply included

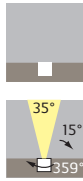

534058
534058-300 Dimmable Dali
534058-310 Dimmable 1-10
 White 2700K
 lm LED 1691 ≠ lm OUTPUT 1141

534024
534024-300 Dimmable Dali
534024-310 Dimmable 1-10
 White 3000K
 lm LED 1818 ≠ lm OUTPUT 1227

534023
534023-300 Dimmable Dali
534023-310 Dimmable 1-10
 White 4000K
 lm LED 1935 ≠ lm OUTPUT 1306

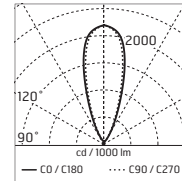

m	lux	
	Max	Med
5.00	114	68
4.00	178	107
3.00	317	189
2.00	714	426
1.00	2854	1704

$\alpha = 17.0^\circ + 17.0^\circ$ $\beta = 17.0^\circ + 17.0^\circ$

@ 4000K

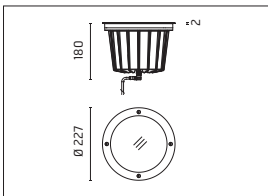

IP67

Naboo225 - Adjustable Optic - 70°

Light Source: Power LED / 16,8W / Total power 21W / CRI>80 / 220÷240V / Kit with remote electronic power supply included

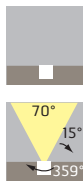

534059
534059-300 Dimmable Dali
534059-310 Dimmable 1-10
 White 2700K
 lm LED 1691 ≠ lm OUTPUT 1380

534027
534027-300 Dimmable Dali
534027-310 Dimmable 1-10
 White 3000K
 lm LED 1818 ≠ lm OUTPUT 1484

534026
534026-300 Dimmable Dali
534026-310 Dimmable 1-10
 White 4000K
 lm LED 1935 ≠ lm OUTPUT 1580

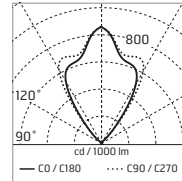

m	lux	
	Max	Med
5.00	54	26
4.00	85	40
3.00	151	71
2.00	341	160
1.00	1362	638

$\alpha = 35.0^\circ + 35.0^\circ$ $\beta = 35.0^\circ + 35.0^\circ$

@ 4000K

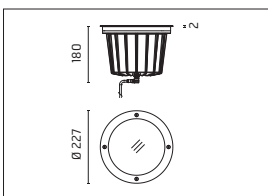

IP67

Naboo225 -Adjustable Optic - Asymmetric 54°x 66°

Light Source: Power LED / 16,8W / Total power 21W / CRI>80 / 220÷240V / Kit with remote electronic power supply included

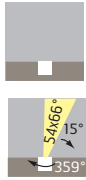

534060
534060-300 Dimmable Dali
534060-310 Dimmable 1-10
 White 2700K
 lm LED 1691 ≠ lm OUTPUT 1373

534030
534030-300 Dimmable Dali
534030-310 Dimmable 1-10
 White 3000K
 lm LED 1818 ≠ lm OUTPUT 1476

534029
534029-300 Dimmable Dali
534029-310 Dimmable 1-10
 White 4000K
 lm LED 1935 ≠ lm OUTPUT 1572

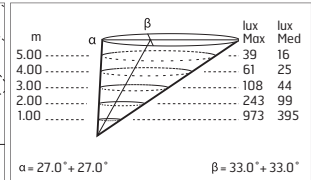
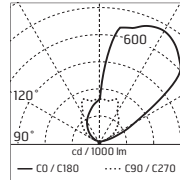

@ 4000K

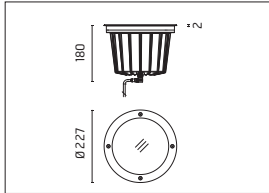

IP67

Naboo225 -Adjustable Optic - 16°

Light Source: CoB LED / 17W / Total power 21W / CRI>80 / 220÷240V / Kit with remote electronic power supply included

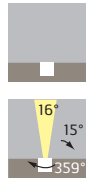

534061
534061-300 Dimmable Dali
534061-310 Dimmable 1-10
 White 2700K
 lm LED 2246 ≠ lm OUTPUT 1739

534032
534032-300 Dimmable Dali
534032-310 Dimmable 1-10
 White 3000K
 lm LED 2415 ≠ lm OUTPUT 1870

534031
534031-300 Dimmable Dali
534031-310 Dimmable 1-10
 White 4000K
 lm LED 2533 ≠ lm OUTPUT 1961

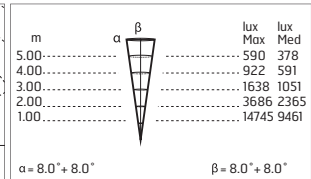
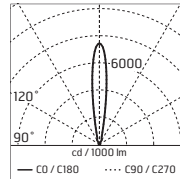

@ 4000K

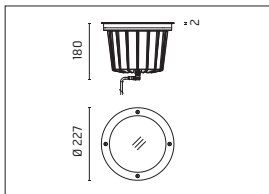

IP67

Naboo225 - Adjustable Optic - 40°

Light Source: CoB LED / 17W / Total power 21W / CRI>80 / 220÷240V / Kit with remote electronic power supply included

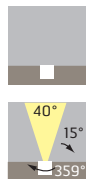

534062
534062-300 Dimmable Dali
534062-310 Dimmable 1-10
 White 2700K
 lm LED 2246 ≠ lm OUTPUT 1673

534034
534034-300 Dimmable Dali
534034-310 Dimmable 1-10
 White 3000K
 lm LED 2415 ≠ lm OUTPUT 1799

534033
534033-300 Dimmable Dali
534033-310 Dimmable 1-10
 White 4000K
 lm LED 2533 ≠ lm OUTPUT 1886

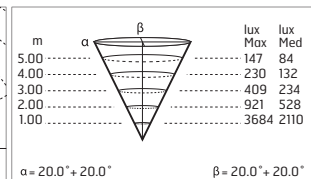
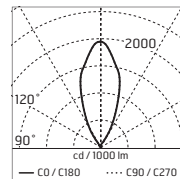

@ 4000K

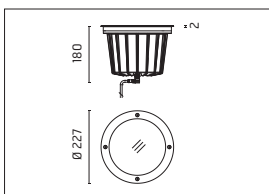

IP67

Naboo290 - Adjustable Optic - 10°

Light Source: Power LED / 33,5W / Total power 39W / CRI>80 / 220÷240V / Kit with remote electronic power supply included

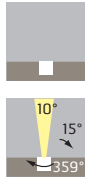

534063
534063-300 Dimmable Dali
534063-310 Dimmable 1-10
 White 2700K
 lm LED 3381 ≠ lm OUTPUT 2737

534037
534037-300 Dimmable Dali
534037-310 Dimmable 1-10
 White 3000K
 lm LED 3636 ≠ lm OUTPUT 2943

534036
534036-300 Dimmable Dali
534036-310 Dimmable 1-10
 White 4000K
 lm LED 3871 ≠ lm OUTPUT 3134

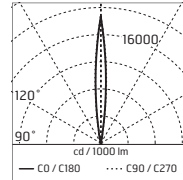

m	lux	
	Max	Med
5.00	2363	1353
4.00	3692	2114
3.00	6564	3759
2.00	14769	8457
1.00	59074	33827

$\alpha = 5.0^\circ + 5.0^\circ$ $\beta = 5.0^\circ + 5.0^\circ$

@ 4000K

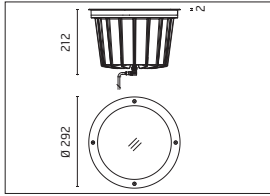

IP67

Naboo290 - Adjustable Optic - 35°

Light Source: Power LED / 33,5W / Total power 39W / CRI>80 / 220÷240V / Kit with remote electronic power supply included

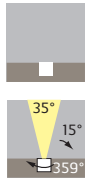
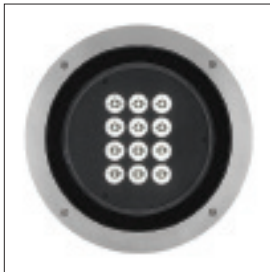

534064
534064-300 Dimmable Dali
534064-310 Dimmable 1-10
 White 2700K
 lm LED 3381 ≠ lm OUTPUT 2275

534040
534040-300 Dimmable Dali
534040-310 Dimmable 1-10
 White 3000K
 lm LED 3636 ≠ lm OUTPUT 2446

534039
534039-300 Dimmable Dali
534039-310 Dimmable 1-10
 White 4000K
 lm LED 3871 ≠ lm OUTPUT 2604

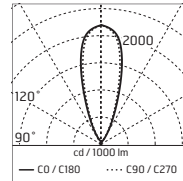

m	lux	
	Max	Med
5.00	227	136
4.00	355	212
3.00	632	377
2.00	1422	849
1.00	5687	3395

$\alpha = 17.0^\circ + 17.0^\circ$ $\beta = 17.0^\circ + 17.0^\circ$

@ 4000K

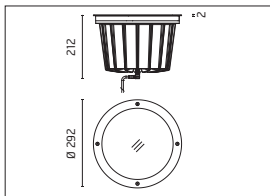

IP67

Naboo290 - Adjustable Optic - 70°

Light Source: Power LED / 33,5W / Total power 39W / CRI>80 / 220÷240V / Kit with remote electronic power supply included

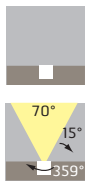
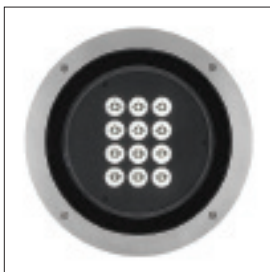

534065
534065-300 Dimmable Dali
534065-310 Dimmable 1-10
 White 2700K
 lm LED 3381 ≠ lm OUTPUT 2417

534043
534043-300 Dimmable Dali
534043-310 Dimmable 1-10
 White 3000K
 lm LED 3636 ≠ lm OUTPUT 2599

534042
534042-300 Dimmable Dali
534042-310 Dimmable 1-10
 White 4000K
 lm LED 3871 ≠ lm OUTPUT 2768

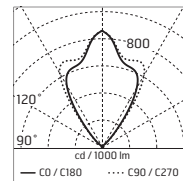

m	lux	
	Max	Med
5.00	95	45
4.00	149	70
3.00	265	124
2.00	597	280
1.00	2387	1119

$\alpha = 35.0^\circ + 35.0^\circ$ $\beta = 35.0^\circ + 35.0^\circ$

@ 4000K

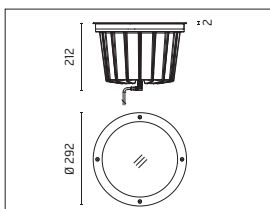

IP67

Naboo290 - Adjustable Optic - Asymmetric - 54°x 66°

Light Source: Power LED / 33,5W / Total power 39W / CRI>80 / 220÷240V / Kit with remote electronic power supply included

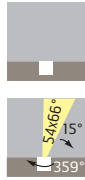
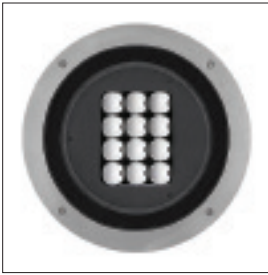

534066
534066-300 Dimmable Dali
534066-310 Dimmable 1-10
 White 2700K
 lm LED 3381 ≠ lm OUTPUT 2405

534046
534046-300 Dimmable Dali
534046-310 Dimmable 1-10
 White 3000K
 lm LED 3636 ≠ lm OUTPUT 2586

534045
534045-300 Dimmable Dali
534045-310 Dimmable 1-10
 White 4000K
 lm LED 3871 ≠ lm OUTPUT 2754

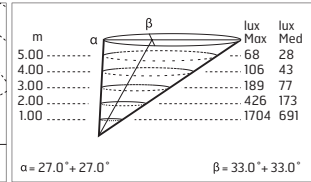
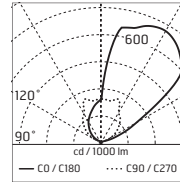

@ 4000K

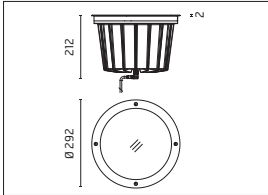

IP67

Naboo225 - Adjustable Optic - 40°

Light Source: CoB LED / 32W / Total power 38W / CRI>80 / 220÷240V / Kit with remote electronic power supply included

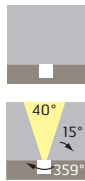

534067
534067-300 Dimmable Dali
534067-310 Dimmable 1-10
 White 2700K
 lm LED 4078 ≠ lm OUTPUT 3093

534048
534048-300 Dimmable Dali
534048-310 Dimmable 1-10
 White 3000K
 lm LED 4385 ≠ lm OUTPUT 3326

534047
534047-300 Dimmable Dali
534047-310 Dimmable 1-10
 White 4000K
 lm LED 4496 ≠ lm OUTPUT 3411

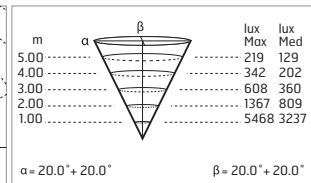
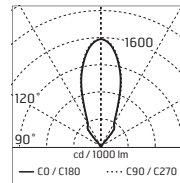

@ 4000K

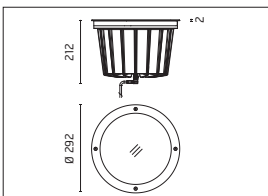

IP67









220÷240V
Kit with remote
electronic power
supply included

215
3/4 Way terminal block
3 poles IP68 H₂O stop
(ø5,5÷12mm cable)



Accessories: Naboo

188
BOX FOR INSTALLATION
Ø 210 x H 190mm

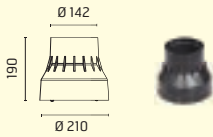

189
BOX FOR INSTALLATION
Ø 222 x H 280mm



190
BOX FOR INSTALLATION
Ø 286 x H 280mm

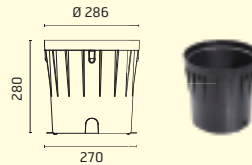

215
3/4 WAY TERMINAL BLOCK 4 POLES
IP68 H₂O STOP (Ø5,5÷12mm CABLE)

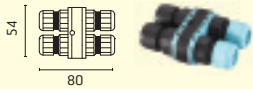

236
2 WAY TERMINAL BLOCK 4 POLES
IP68 H₂O STOP (Ø5,5÷12mm CABLE)



237
SPD: (SURGE PROTECTION DEVICE)
275Vac.
MAXIMUM DISCHARGE CURRENT
10KA (8/20µs) .
MAXIMUM OPERATING CURRENT 5A
SUITABLE FOR SERIES CONNEC-
TION - IP66

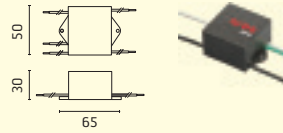

acc. code ▶	dim	dim	188	189	190	215	236	237
prod. code ▼	DALI	1-10						
534002			•			•	•	•
534003			•			•	•	•
534005			•			•	•	•
534006			•			•	•	•
534008			•			•	•	•
534009			•			•	•	•
534011			•			•	•	•
534012			•			•	•	•
534014			•			•	•	•
534015			•			•	•	•
534017			•			•	•	•
534018			•			•	•	•
534020	-300	-310		•		•	•	•
534021	-300	-310		•		•	•	•
534023	-300	-310		•		•	•	•
534024	-300	-310		•		•	•	•
534026	-300	-310		•		•	•	•
534027	-300	-310		•		•	•	•
534029	-300	-310		•		•	•	•
534030	-300	-310		•		•	•	•
534031	-300	-310		•		•	•	•
534032	-300	-310		•		•	•	•
534033	-300	-310		•		•	•	•
534034	-300	-310		•		•	•	•
534036	-300	-310			•	•	•	•
534037	-300	-310			•	•	•	•

acc. code ▶	dim	dim	188	189	190	215	236	237
prod. code ▼	DALI	1-10						
534039	-300	-310			•	•	•	•
534040	-300	-310			•	•	•	•
534042	-300	-310			•	•	•	•
534043	-300	-310			•	•	•	•
534045	-300	-310			•	•	•	•
534046	-300	-310			•	•	•	•
534047	-300	-310			•	•	•	•
534048	-300	-310			•	•	•	•
534051			•			•	•	•
534052			•			•	•	•
534053			•			•	•	•
534054			•			•	•	•
534055			•			•	•	•
534056			•			•	•	•
534057	-300	-310		•		•	•	•
534058	-300	-310		•		•	•	•
534059	-300	-310		•		•	•	•
534060	-300	-310		•		•	•	•
534061	-300	-310		•		•	•	•
534062	-300	-310		•		•	•	•
534063	-300	-310			•	•	•	•
534064	-300	-310			•	•	•	•
534065	-300	-310			•	•	•	•
534066	-300	-310			•	•	•	•
534067	-300	-310			•	•	•	•











- Round luminaire with radial emission for installation in-ground – recessed.
- Configuration: two sizes available. Die-cast aluminium structure, EN AB-47100 alloy (low copper content). Transparent borosilicate glass.
- Double layer coating for high resistance to corrosion: the aluminium components are painted with a double coat using powders which are compliant with QUALICOAT standards: a first layer of epoxy powder (with excellent chemical and mechanical resistance) and a second finishing layer of polyester powder (resistant to UV rays and atmospheric agents). The entire painting process of the aluminium fitting starts from components which have been sandblasted in advance to make the surface more porous and increase the adherence of the paint. Ares effects alkaline and acid washing to clean the surfaces completely, then rinses with demineralised water to remove any residue particles, subsequently a chemical conversion treatment is done to protect against rusting.
- Light emission: one emission, two opposite emissions, four emissions.
- Protection rating: IP67
- In compliance with EN60598-1 standards
- Class of insulation: II; version 24V: III
- Installation: the luminaire is equipped with a watertight M12 screw-connector providing optimal insulation against water ingress. 220-240V: the power supply unit is equipped with a piece of cable of 400mm with screw connector towards the luminaire and a piece of cable of 300mm to be used for wiring. 24V: the luminaire is supplied with a piece of cable with screw-connector to be used for wiring. Outdoor use requires suitable flexible cables. Installation requires a dedicated box to be ordered separately. It is important to provide a >300mm gravel layer or a drain system (for concrete surface) to ensure good drainage and to avoid water stagnation. Kamino 24V is equipped with a dc/dc highly efficient resin-coated converter that removes electromagnetic interference and allows parallel wiring and is protected against polarity reversal and sudden voltage peak.
- We recommend the use of a connection system with a protection degree greater than or equal to the protection degree of the luminaire.
- During the installation and the maintenance of the fixtures it is important to be careful and avoid damages on the paint coating. Damages on the coating exposed to outdoor conditions or water, could cause corrosion. Chemical substances affect the anticorrosion covering protection.

EU Regulation 874/2012 - Illumination equipment energy classes

A++
A+
A

LED VERSION:
Class A/A+/A++
Luminaire supplied with integrated LED modules that cannot be replaced



	Recessed ground fitting		Installation requires a 30cm water drainage layer (gravel)
	Do not install in hollow areas		Pre-wired with approx 250mm of cable
	Protection against water ingress from the cable		Static load: 2000Kg walk over
	Drive over		Glass surface temperature <70°C
	Protection against impact IK 09- 10,00 joule		

Kamino130 - One Emission - 230V

Light Source: Power LED / CRI>80



1,1W / Total power 4W / 220÷240V

535041

White 2700K
lm LED 129 ≈ lm OUTPUT 35

535003

White 3000K
lm LED 1x139 ≈ lm OUTPUT 1x38

535002

White 4000K
lm LED 1x148 ≈ lm OUTPUT 1x41

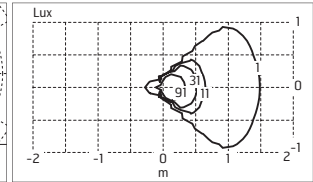
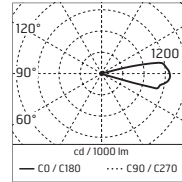

@ 4000K

Kit with remote electronic power supply included

Dimmable on request

1,1W / Total power 1,9W / 24Vdc

535042

White 2700K
lm LED 129 ≈ lm OUTPUT 35

535021

White 3000K
lm LED 1x139 ≈ lm OUTPUT 1x38

535020

White 4000K
lm LED 1x148 ≈ lm OUTPUT 1x41

Remote electronic power supply to be ordered

IP67

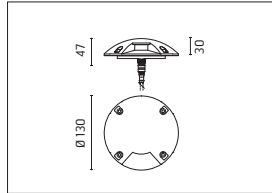

Kamino130 - Two Emissions - 230V

Light Source: Power LED / CRI>80



2,2W / Total power 5W / 220÷240V

535043

White 2700K
lm LED 2x129 ≈ lm OUTPUT 2x35

535006

White 3000K
lm LED 2x139 ≈ lm OUTPUT 2x38

535005

White 4000K
lm LED 2x148 ≈ lm OUTPUT 2x41

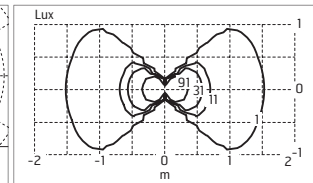
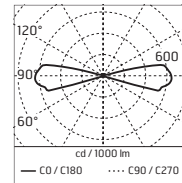

@ 4000K

Kit with remote electronic power supply included

Dimmable on request

2,2W / Total power 3,5W / 24Vdc

535044

White 2700K
lm LED 2x129 ≈ lm OUTPUT 2x35

535024

White 3000K
lm LED 2x139 ≈ lm OUTPUT 2x38

535023

White 4000K
lm LED 2x148 ≈ lm OUTPUT 2x41

Remote electronic power supply to be ordered

IP67

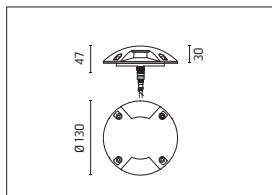

Kamino130 - Omnidirectional

Light Source: Power LED / CRI>80

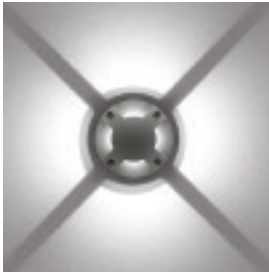

4,4W / Total power 7W / 220÷240V

535045

White 2700K
lm LED 4x129 ≈ lm OUTPUT 4x35

535009

White 3000K
lm LED 4x139 ≈ lm OUTPUT 4x38

535008

White 4000K
lm LED 4x141 ≈ lm OUTPUT 4x41

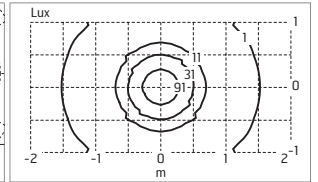
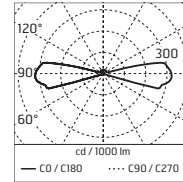

@ 4000K

Kit with remote electronic power supply included

Dimmable on request

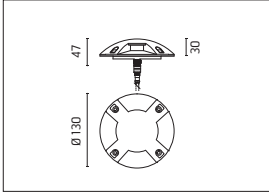

4,4W / Total power 5,8W / 24Vdc

535046

White 2700K
lm LED 4x129 ≈ lm OUTPUT 4x35

535027

White 3000K
lm LED 4x139 ≈ lm OUTPUT 4x38

535026

White 4000K
lm LED 4x141 ≈ lm OUTPUT 4x41

Remote electronic power supply to be ordered

IP67

Kamino180 - One Emission

Light Source: Power LED / CRI>80



2,2W / Total power 5W / 220÷240V

535047

White 2700K
lm LED 233 ≈ lm OUTPUT 64

535012

White 3000K
lm LED 1x250 ≈ lm OUTPUT 1x69

535011

White 4000K
lm LED 1x266 ≈ lm OUTPUT 1x74

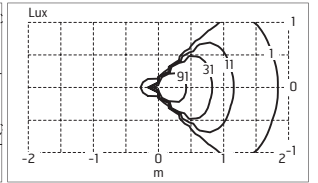
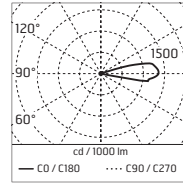

@ 4000K

Kit with remote electronic power supply included

Dimmable on request

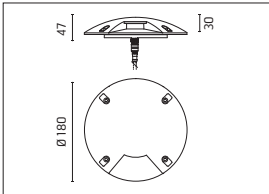

2,2W / Total power 3,4W / 24Vdc

535048

White 2700K
lm LED 233 ≈ lm OUTPUT 64

535030

White 3000K
lm LED 1x250 ≈ lm OUTPUT 1x69

535029

White 4000K
lm LED 1x266 ≈ lm OUTPUT 1x74

Remote electronic power supply to be ordered

IP67

Kamino180 - Two Emissions

Light Source: Power LED / CRI>80



4,4W / Total power 7W / 220÷240V

535049

White 2700K
lm LED 2x233 ≈ lm OUTPUT 2x64

535015

White 3000K
lm LED 2x250 ≈ lm OUTPUT 2x69

535014

White 4000K
lm LED 2x266 ≈ lm OUTPUT 2x74

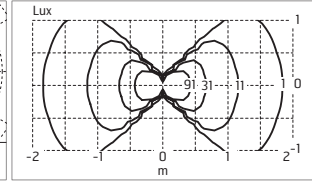
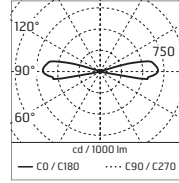

@ 4000K

 Kit with remote electronic power supply included

Dimmable on request

4,4W / Total power 6,4W / 24Vdc

535050

White 2700K
lm LED 2x233 ≈ lm OUTPUT 2x64

535033

White 3000K
lm LED 2x250 ≈ lm OUTPUT 2x69

535032

White 4000K
lm LED 2x266 ≈ lm OUTPUT 2x74

 Remote electronic power supply to be ordered

IP67  

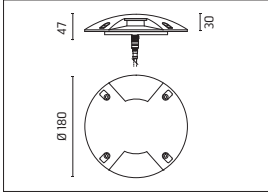

Kamino180 - Omnidirectional

Light Source: Power LED / CRI>80

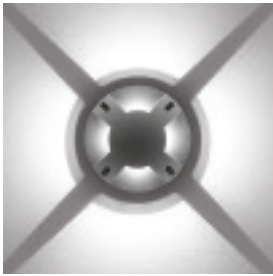

8,8W / Total power 12W / 220÷240V

535051

White 2700K
lm LED 4x233 ≈ lm OUTPUT 4x64

535018

White 3000K
lm LED 4x250 ≈ lm OUTPUT 4x69

535017

White 4000K
lm LED 4x266 ≈ lm OUTPUT 4x74

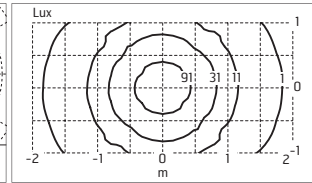
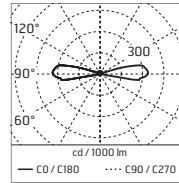

@ 4000K

 Kit with remote electronic power supply included

Dimmable on request

8,8W / Total power 11,2W / 24Vdc

535052

White 2700K
lm LED 4x233 ≈ lm OUTPUT 4x64

535036

White 3000K
lm LED 4x250 ≈ lm OUTPUT 4x69

535035

White 4000K
lm LED 4x266 ≈ lm OUTPUT 4x69

 Remote electronic power supply to be ordered

IP67  

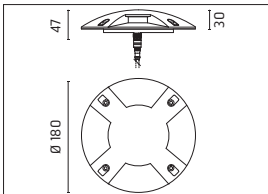



Accessories: Kamino

192
BOX FOR INSTALLATION
225 x 128 H 85mm

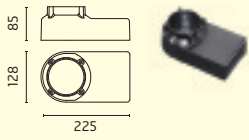

193
HIGH RESISTANCE IN-GROUND BOX
FOR INSTALLATION 200 H 150mm

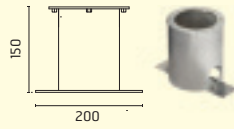

194
BOX FOR INSTALLATION
263 x 173 H 85mm

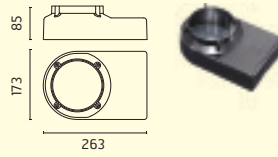

195
HIGH RESISTANCE IN-GROUND BOX
FOR INSTALLATION 250 H 150mm

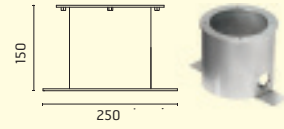

219
SPLITTER M12 CONNECTOR

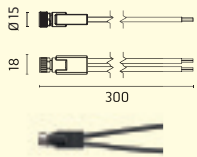

220
M12 CONNECTOR L.5000mm



215
3/4 WAY TERMINAL BLOCK 4 POLES
IP68 H2O STOP (Ø5,5÷12mm CABLE)

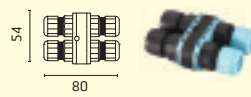

236
2 WAY TERMINAL BLOCK 4 POLES
IP68 H2O STOP (Ø5,5÷12mm CABLE)



269
2 WAY TERMINAL BLOCK 2 POLES IP68
(Ø4÷6,9mm Cable)
*it can't be placed in the recessed box
for installation



147
POWER SUPPLY 20W/220÷240V - 24Vdc
IP67 CLASS II SELV.

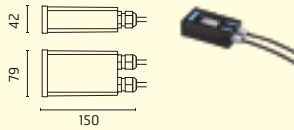

155
POWER SUPPLY 50W/120÷240V -
24Vdc
IP67 CLASS II SELV.

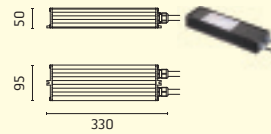

110
POWER SUPPLY 70W/220÷240V
- 24Vdc
IP67 CLASS II SELV EQ.

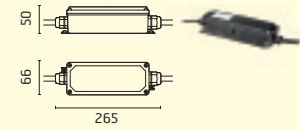

237
SPD: (SURGE PROTECTION DEVICE)
275Vac
MAXIMUM DISCHARGE CURRENT
10KA (8/20µs)
MAXIMUM OPERATING CURRENT 5A
SUITABLE FOR SERIES CONNEC-
TION - IP66

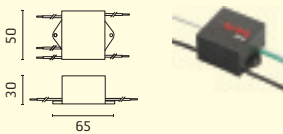

Accessories: Kamino

Version 24Vdc
Remote electronic power supply to be ordered



acc. code ▶	192	193	194	195	219	220	215	236	147	155	110	237	269
prod. code ▼													
535002	•	•					•	•				•	•
535003	•	•					•	•				•	•
535005	•	•					•	•				•	•
535006	•	•					•	•				•	•
535008	•	•					•	•				•	•
535009	•	•					•	•				•	•
535011			•	•			•	•				•	•
535012			•	•			•	•				•	•
535014			•	•			•	•				•	•
535015			•	•			•	•				•	•
535017			•	•			•	•				•	•
535018			•	•			•	•				•	•
535020	•	•			•	•			5	16	33		
535021	•	•			•	•			5	16	33		
535023	•	•			•	•			2	10	19		
535024	•	•			•	•			2	10	19		
535026	•	•			•	•			1	7	12		
535027	•	•			•	•			1	7	12		
535029			•	•	•	•			3	8	16		
535030			•	•	•	•			3	8	16		
535032			•	•	•	•			2	5	8		
535033			•	•	•	•			2	5	8		
535035			•	•	•	•			1	3	6		
535036			•	•	•	•			1	3	6		
535041	•	•					•	•				•	•
535042	•	•			•	•			5	16	33		
535043	•	•					•	•				•	•
535044	•	•			•	•			2	10	19		
535045	•	•					•	•				•	•
535046	•	•			•	•			1	7	12		
535047			•	•			•	•				•	•
535048			•	•	•	•			3	8	16		
535049			•	•			•	•				•	•
535050			•	•	•	•			2	5	8		
535051			•	•			•	•				•	•
535052			•	•	•	•			1	3	6		

Version 220÷240V
Kit with remote electronic power supply included

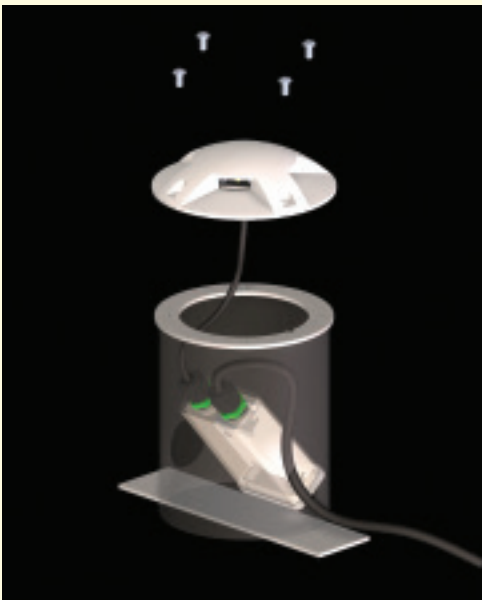

Max fixtures for each power supply (Vin 220÷240). Data in the chart are provided as a guide only. Please verify according to your installation.













- Square luminaire for installation in wall and ground – recessed.
- Configuration: die-cast aluminium structure, EN AB-47100 alloy (low copper content). Glass diffuser fixed to the aluminium body through a robotic gluing system.
- Double layer coating for high resistance to corrosion: the aluminium components are painted with a double coat using powders which are compliant with QUALICOAT standards: a first layer of epoxy powder (with excellent chemical and mechanical resistance) and a second finishing layer of polyester powder (resistant to UV rays and atmospheric agents). The entire painting process of the aluminium fitting starts from components which have been sandblasted in advance to make the surface more porous and increase the adherence of the paint. Ares effects alkaline and acid washing to clean the surfaces completely, then rinses with demineralised water to remove any residue particles, subsequently a chemical conversion treatment is done to protect against rusting.
- Protection rating: IP67
- In compliance with EN 60598-1 standards
- Class of insulation: III
- Installation: the luminaire is equipped with 300mm of cable for a quick connection. K12 Power LED is equipped with a dc/dc highly efficient converter that removes electromagnetic interference and allows parallel wiring. The whole range is protected against polarity reversal and sudden voltage peak. Outdoor use requires suitable flexible cables. Installation requires a dedicated box to be ordered separately. It is important to provide a >200mm gravel layer or a drain system (for concrete surface) to ensure good drainage and to avoid water stagnation.
- We recommend the use of a connection system with a protection degree greater than or equal to the protection degree of the luminaire.
- During the installation and the maintenance of the fixtures it is important to be careful and avoid damages on the paint coating. Damages on the coating exposed to outdoor conditions or water, could cause corrosion. Chemical substances affect the anticorrosion covering protection.

EU Regulation 874/2012 - Illumination equipment energy classes



LED VERSION:
Class A/A+/A++
Luminaire supplied with integrated LED modules that cannot be replaced

	Recessed ground fitting		Recessed wall fitting
	Do not install in hollow areas		Installation requires a 20cm water drainage layer (gravel).
	Pre-wired with approx 300mm of cable.		Protection against water ingress from the cable (not for RGB versions)
	Remote device required.		Static load: 1500Kg walk over
	Glass surface temperature <70°C		Protection against impact. IK 10 - 20,00 joule

K12sq - 10°

Light Source: Power LED / 6,2W / Total power 7,5W / CRI>80 / 24Vdc / Remote electronic power supply to be ordered

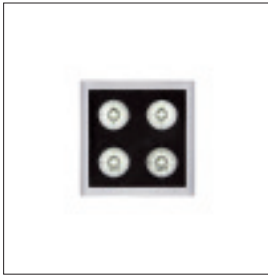

524015
White 2700K
lm LED 637 ≈ lm OUTPUT 475

524013
White 3000K
lm LED 685 ≈ lm OUTPUT 511

524012
White 4000K
lm LED 730 ≈ lm OUTPUT 545

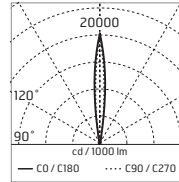

m	α	β	lux	
			Max	Med
5.00			444	268
4.00			693	419
3.00			1233	745
2.00			2773	1677
1.00			11093	6709

α = 5.0° + 5.0°

β = 5.0° + 5.0°

@ 4000K

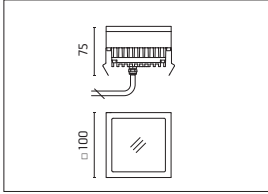

IP67

K12sq - 40°

Light Source: Power LED / 6,2W / Total power 7,5W / CRI>80 / 24Vdc / Remote electronic power supply to be ordered

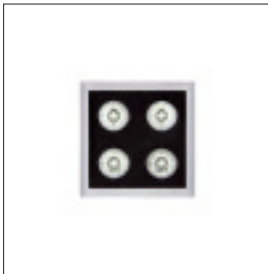

524025
White 2700K
lm LED 637 ≈ lm OUTPUT 406

524023
White 3000K
lm LED 685 ≈ lm OUTPUT 437

524022
White 4000K
lm LED 730 ≈ lm OUTPUT 462

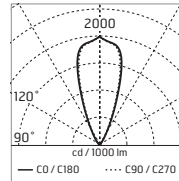

m	α	β	lux	
			Max	Med
5.00			37	23
4.00			57	35
3.00			101	63
2.00			228	141
1.00			913	565

α = 20.0° + 20.0°

β = 20.0° + 20.0°

@ 4000K

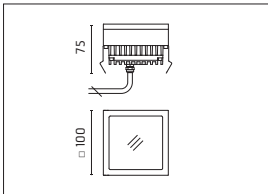

IP67

K12sq - Diffused Light

Light Source: Mid-Power LED / 5,2W / Total power 6,8W / CRI>80 / 24Vdc / Remote electronic power supply to be ordered

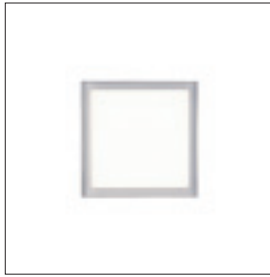

524005
White 2700K
lm LED 720 \approx lm OUTPUT 396
... Acc. 144, 176 or 252

524003
White 3000K
lm LED 774 \approx lm OUTPUT 426
... Acc. 144, 176 or 252

524002
White 4000K
lm LED 813 \approx lm OUTPUT 447
... Acc. 144, 176 or 252

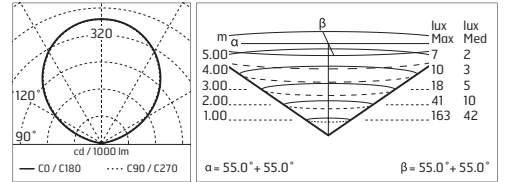

@ 4000K

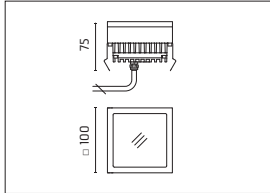

IP67

K12sq - Diffused Light

Light Source: RGB Low-Power LED / 4,6W / Total power 6,8W / CRI>80 / 3CH 24Vdc / Remote electronic power supply to be ordered



524004

Wiring diagram and installation scheme RGB

Max 8 luminaires K12sq
for each code 148

>> See Page 560
Wiring Diagram n.6

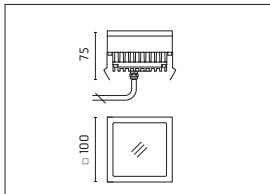

IP67

K12rc - 10°

Light Source: Power LED / 12,4W / Total power 15W / CRI>80 / 24Vdc / Remote electronic power supply to be ordered

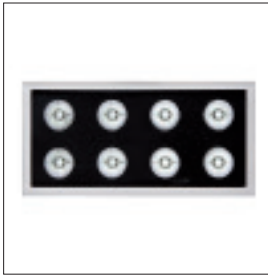

524515
White 2700K
lm LED 1274 \approx lm OUTPUT 907

524513
White 3000K
lm LED 1459 \approx lm OUTPUT 1031

524512
White 4000K
lm LED 1370 \approx lm OUTPUT 975

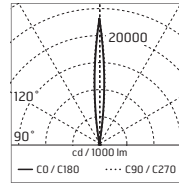

m	α	β	lux	
			Max	Med
5.00			955	531
4.00			1493	830
3.00			2654	1476
2.00			5972	3321
1.00			23887	13284

α = 5.0° + 5.0° β = 5.0° + 5.0°

@ 4000K

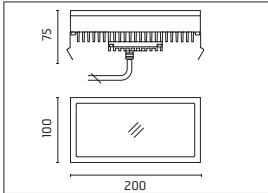

IP67

K12rc - 40°

Light Source: Power LED / 12,4W / Total power 15W / CRI>80 / 24Vdc / Remote electronic power supply to be ordered

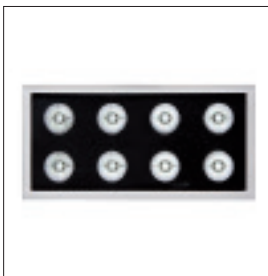

524525
White 2700K
lm LED 1274 \approx lm OUTPUT 797

524523
White 3000K
lm LED 1370 \approx lm OUTPUT 857

524522
White 4000K
lm LED 1459 \approx lm OUTPUT 906

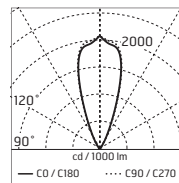

m	α	β	lux	
			Max	Med
5.00			76	46
4.00			118	73
3.00			210	129
2.00			472	290
1.00			1888	1161

α = 20.0° + 20.0° β = 20.0° + 20.0°

@ 4000K

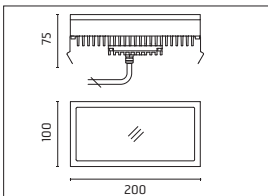

IP67

K12rc - Diffused Light

Light Source: Mid-Power LED / 11,7W / Total power 15,8W / CRI>80 / 24Vdc / Remote electronic power supply to be ordered



524505
White 2700K
lm LED 1620 \approx lm OUTPUT 939
... Acc. 144, 176 or 252

524503
White 3000K
lm LED 774 \approx lm OUTPUT 426
... Acc. 144, 176 or 252

524502
White 4000K
lm LED 1742 \approx lm OUTPUT 1010
... Acc. 144, 176 or 252

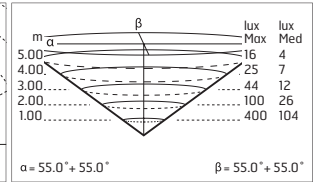
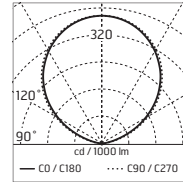

@ 4000K

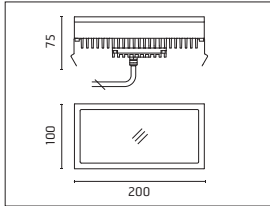

IP67

K12rc - Diffused Light

Light Source: RGB Low-Power LED / 10W / Total power 10,5W / CRI>80 / 3CH 24Vdc / Remote electronic power supply to be ordered



524504

Wiring diagram and installation scheme RGB

Max 4 luminaires K12rc
for each code 148

>> See Page 560
Wiring Diagram n.6

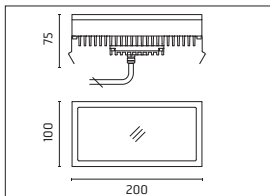

IP67

K12ln - 10°

Light Source: Power LED / 9,3W / Total power 11,8W / CRI>80 / 24Vdc / Remote electronic power supply to be ordered

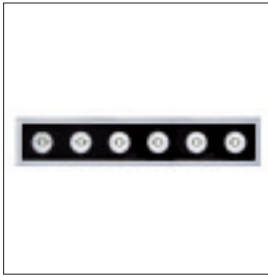

524115
White 2700K
lm LED 955 ≠ lm OUTPUT 852

524113
White 3000K
lm LED 1027 ≠ lm OUTPUT 916

524112
White 4000K
lm LED 1094 ≠ lm OUTPUT 967

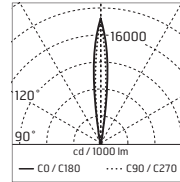

m	α	β	lux	
			Max	Med
5.00			710	444
4.00			1110	694
3.00			1973	1234
2.00			4440	2776
1.00			17761	11104

α = 5.0° + 5.0° β = 5.0° + 5.0°

@ 4000K

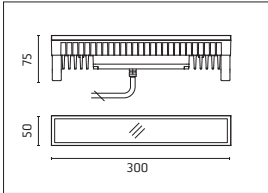

IP67

K12ln - 40°

Light Source: Power LED / 9,3W / Total power 11,8W / CRI>80 / 24Vdc / Remote electronic power supply to be ordered

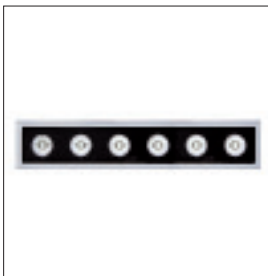

524125
White 2700K
lm LED 955 ≠ lm OUTPUT 648

524123
White 3000K
lm LED 1027 ≠ lm OUTPUT 697

524122
White 4000K
lm LED 1094 ≠ lm OUTPUT 737

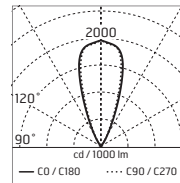

m	α	β	lux	
			Max	Med
5.00			58	36
4.00			90	57
3.00			161	101
2.00			362	228
1.00			1447	912

α = 20.0° + 20.0° β = 20.0° + 20.0°

@ 4000K

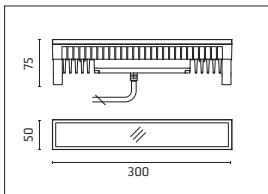

IP67

K12In - Diffused light

Light Source: Mid-Power LED / 7,8W / Total power 10,5W / CRI>80 / 24Vdc / Remote electronic power supply to be ordered



524105
White 2700K
lm LED 1080 \approx lm OUTPUT 538
... Acc. 144, 176 or 252

524103
White 3000K
lm LED 1161 \approx lm OUTPUT 578
... Acc. 144, 176 or 252

524102
White 4000K
lm LED 1219 \approx lm OUTPUT 607
... Acc. 144, 176 or 252

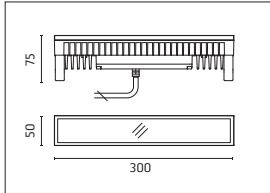
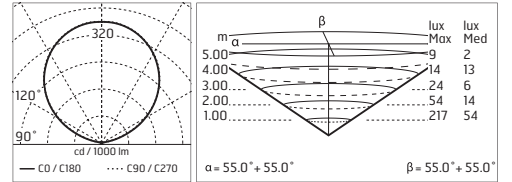

IP67 CE

K12rc - Diffused light

Light Source: RGB Low-Power LED / 7,5W / Total power 8W / CRI>80 / 3CH 24Vdc / Remote electronic power supply to be ordered



524104

Wiring diagram and installation scheme RGB

Max 5 luminaires K12In
for each code 148

>> See Page 560
Wiring Diagram n.6

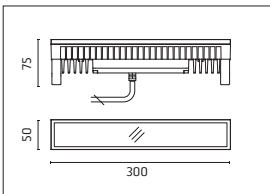

IP67 CE





Accessories: K12

151
BOX FOR INSTALLATION
120 x 120 x H 95mm



152
BOX FOR INSTALLATION
220 x 120 x H 95mm

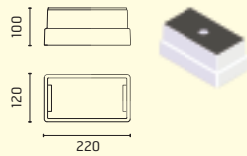

183
BOX FOR INSTALLATION
322 x 70 x H 95mm

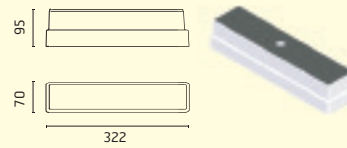

153
SUCTION CUP TO PULL THE LUMI-NAIRE

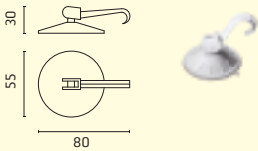

87
POWER SUPPLY 10W/110÷240V - 24Vdc IP20 CLASS II SELV.

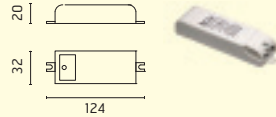

175
POWER SUPPLY 10W/110÷240V - 24Vdc IP67 CLASS II SELV.

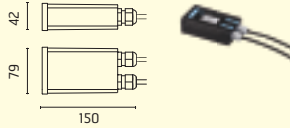

144
POWER SUPPLY 17W/110÷240V - 24Vdc (15W@110V) IP20 CLASS II SELV.

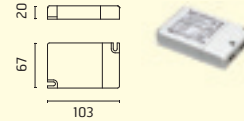

176
POWER SUPPLY 17W/110÷240V - 24Vdc (15W@110V) IP67 CLASS II SELV.

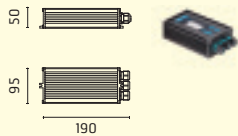

252
POWER SUPPLY 20W/110-240Vdc (15W@110V) IP67 CLASS II SELV.

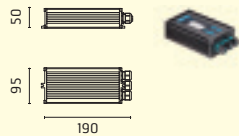

147
POWER SUPPLY 20W/220÷240V - 24Vdc IP67 CLASS II SELV.

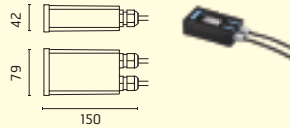

155
POWER SUPPLY 50W/120÷240V - 24Vdc IP67 CLASS II SELV.

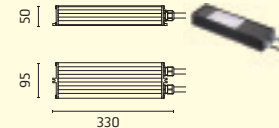

... DIMMABLE: PUSH-DIM OR 1...10V
See Page 558 Wiring Diagram n.4

... DIMMABLE: DALI
See Page 558 Wiring Diagram n.4

110
POWER SUPPLY 70W/220÷240V - 24Vdc IP67 CLASS II SELV EQ.

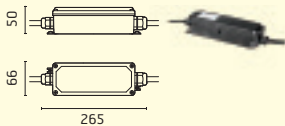

156
POWER SUPPLY 96W /120÷277V - 24Vdc IP67 CLASS II SELV.

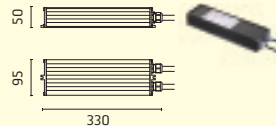

148
POWER SUPPLY WITH DMX INTERFACE FOR RGB FIXTURES 55W/220÷230V-3CHx24Vdc (3CHx18W) DMX CONTROLLER ALLOWED IP67 CLASS I SELV EQ.

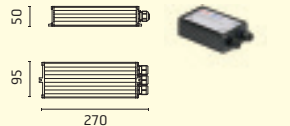

142
DMX CONTROLLER; DIMMER SWITCH FOR RECESSED BOX (60mm HOLE CENTRES)



143
DMX CONTROLLER; STAND-ALONE/PC INTERFACE

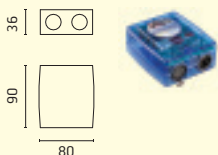

186
DMX CABLE - SHIELDED TWISTED PAIR WITH 110 Ohm CONSTANT IMPEDANCE.



187
DMX SPLITTER 512 - ELECTRONIC DEVICE TO REGENERATE THE MONODIRECTIONAL DMX SIGNAL 1 INPUT AND 7 OUTPUT, 12-24V dc

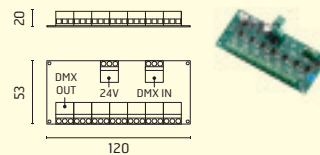

269
2 WAY TERMINAL BLOCK 2 POLES IP68 (Ø4÷6,9mm Cable) *it can't be placed in the recessed box for installation



POWER SUPPLY TO BE ORDERED (87 OR 175 RECOMMENDED)

Accessories: K12

acc. code ► prod. code ▼	151	152	183	153	87	175	144	176	252	147	155	110	156	148	142	143	186	187	269
524002	•			•	1	1	2	2	1	2	6	9	13						•
524003	•			•	1	1	2	2	1	2	6	9	13						•
524004	•			•										8	•	•	•	•	
524005	•			•	1	1	2	2	1	2	6	9	13						•
524012	•			•	1	1					5	8							•
524013	•			•	1	1					5	8							•
524015	•			•	1	1					5	8							•
524022	•			•	1	1					5	8							•
524023	•			•	1	1					5	8							•
524025	•			•	1	1					5	8							•
524102			•	•			1	1	1	1	4	6	9						•
524103			•	•			1	1	1	1	4	6	9						•
524104			•	•										5	•	•	•	•	
524105			•	•			1	1	1	1	4	6	9						•
524112			•	•						1	3	6							•
524113			•	•						1	3	6							•
524115			•	•						1	3	6							•
524122			•	•						1	3	6							•
524123			•	•						1	3	6							•
524125			•	•						1	3	6							•
524502		•		•			1	1	1	1	3	4	6						•
524503		•		•			1	1	1	1	3	4	6						•
524504		•		•										4	•	•	•	•	
524505		•		•			1	1	1	1	3	4	6						•
524512		•		•						1	2	4							•
524513		•		•						1	2	4							•
524515		•		•						1	2	4							•
524522		•		•						1	2	4							•
524523		•		•						1	2	4							•
524525		•		•						1	2	4							•

Max fixtures for each power supply (Vin 220÷240). Data in the chart are provided as a guide only. Please verify according to your installation.



- Square or round luminaire – for installation in wall, ceiling or ground – recessed.
- Configuration: die-cast aluminium structure, EN AB-47100 alloy (low copper content). Anodized aluminium frame – only round. Glass diffuser: transparent or sandblasted, fixed to the aluminium body through a robotic gluing system.
- Double layer coating for high resistance to corrosion: the aluminium components are painted with a double coat using powders which are compliant with QUALICOAT standards: a first layer of epoxy powder (with excellent chemical and mechanical resistance) and a second finishing layer of polyester powder (resistant to UV rays and atmospheric agents). The entire painting process of the aluminium fitting starts from components which have been sandblasted in advance to make the surface more porous and increase the adherence of the paint. Ares effects alkaline and acid washing to clean the surfaces completely, then rinses with demineralised water to remove any residue particles, subsequently a chemical conversion treatment is done to protect against rusting.
- Protection rating: IP67
- In compliance with EN 60598-1 standards
- Class of insulation: III
- Installation: the luminaire is equipped with a piece of cable for an easy-to-make connection and an H₂O STOP device. Tapioca 24V is equipped with a dc/dc highly efficient resin-coated converter that removes electromagnetic interference and allows parallel wiring. The luminaire is protected against polarity reversal and sudden voltage peak. Installation requires a dedicated box to be ordered separately. It is important to provide a >200mm gravel layer or a drain system (for concrete surface) to ensure good drainage and to avoid water stagnation.
- We recommend the use of a connection system with a protection degree greater than or equal to the protection degree of the luminaire.
- During the installation and the maintenance of the fixtures it is important to be careful and avoid damages on the paint coating. Damages on the coating exposed to outdoor conditions or water, could cause corrosion. Chemical substances affect the anticorrosion covering protection.

EU Regulation 874/2012 - Illumination equipment energy classes

A++
A+
A

LED VERSION:
Class A/A+/A++
Luminaire supplied with integrated LED modules that cannot be replaced



.8 Anodized Aluminium



Recessed ground fitting



Recessed wall fitting



Do not install in hollow areas



Installation in concrete ceiling: box for installation required



Installation requires a 20cm water drainage layer (gravel).



Pre-wired with approx 200mm of cable



Protection against water ingress from the cable (not for RGB versions)



Remote device required



Static load: 500Kg walk over (version without frame)
Static load: 2000Kg walk over (version with frame)



Glass surface temperature <70°C



Protection against impact.
IK 08 - 5,00 joule
IK 06 - 1,00 joule*
*(only version ø 55 mm)

Tapioca Ø 40mm - Transparent Glass - 10°

Light Source: Power LED / 1,6W / Total power 2,3W / CRI>80 / 12÷24Vdc / Remote electronic power supply to be ordered

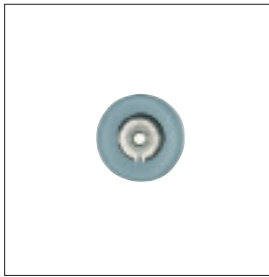

10018112
White 2700K
lm LED 167 ≈ lm OUTPUT 118

10017612
White 3000K
lm LED 180 ≈ lm OUTPUT 127

10017712
White 4000K
lm LED 195 ≈ lm OUTPUT 138

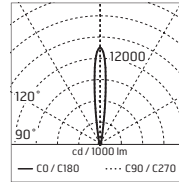

m	α	β	lux	
			Max	Med
5.00			77	51
4.00			121	80
3.00			214	141
2.00			482	318
1.00			1928	1273

α = 6.0° + 6.0° β = 6.0° + 6.0°

@ 4000K

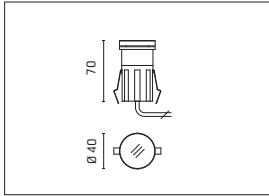

Dimmable on request

IP67

Tapioca Ø 40mm - Transparent Glass - 45°

Light Source: Power LED / 1,6W / Total power 2,3W / CRI>80 / 12÷24Vdc / Remote electronic power supply to be ordered

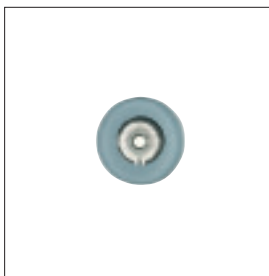

10018140
White 2700K
lm LED 167 ≈ lm OUTPUT 112

10017640
White 3000K
lm LED 180 ≈ lm OUTPUT 120

10017740
White 4000K
lm LED 195 ≈ lm OUTPUT 130

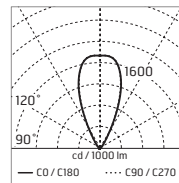

m	α	β	lux	
			Max	Med
5.00			9	5
4.00			14	8
3.00			25	15
2.00			56	33
1.00			225	131

α = 23.0° + 23.0° β = 23.0° + 23.0°

@ 4000K

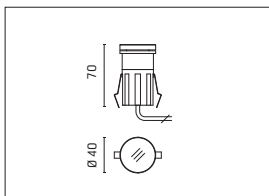

Dimmable on request

IP67

Tapioca Ø 40mm - Sandblasted Glass - Diffused Light

Light Source: Power LED / 1,6W / Total power 2,3W / CRI>80 / 12÷24Vdc / Remote electronic power supply to be ordered

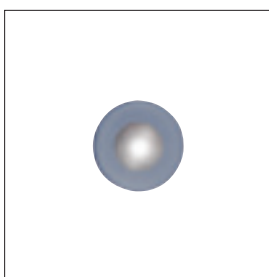

10018118
White 2700K
lm LED 167 ≈ lm OUTPUT 47

10017618
White 3000K
lm LED 180 ≈ lm OUTPUT 50

10017718
White 4000K
lm LED 195 ≈ lm OUTPUT 54

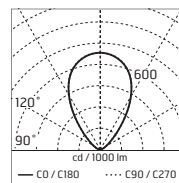

m	α	β	lux	
			Max	Med
5.00			1	1
4.00			2	1
3.00			4	2
2.00			9	5
1.00			37	18

α = 35.0° + 35.0° β = 35.0° + 35.0°

@ 4000K

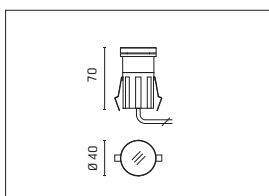

Dimmable on request

IP67

Tapioca Ø 55mm -Anodized Aluminium Frame - Transparent Glass - 10°

Light Source: Power LED / 1,6W / Total power 2,3W / CRI>80 / 12÷24Vdc / Remote electronic power supply to be ordered

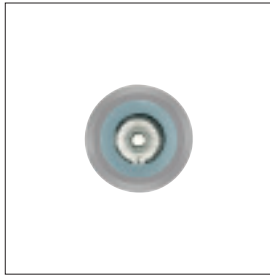

100181119
White 2700K
lm LED 167 ≠ lm OUTPUT 118

100176119
White 3000K
lm LED 180 ≠ lm OUTPUT 127

100177119
White 4000K
lm LED 195 ≠ lm OUTPUT 138

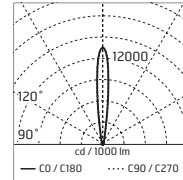
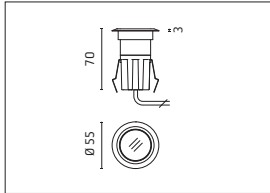

m	lux	
	Max	Med
5.00	77	51
4.00	121	80
3.00	214	141
2.00	482	318
1.00	1928	1273

α = 6.0° + 6.0° β = 6.0° + 6.0°

@ 4000K

Dimmable on request

IP67

Tapioca Ø 55mm -Anodized Aluminium Frame - Transparent Glass - 45°

Light Source: Power LED / 1,6W / Total power 2,3W / CRI>80 / 12÷24Vdc / Remote electronic power supply to be ordered

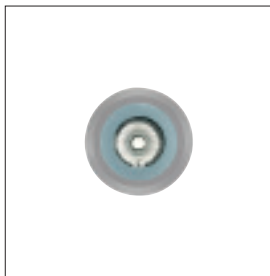

10018100
White 2700K
lm LED 167 ≠ lm OUTPUT 112

10017600
White 3000K
lm LED 180 ≠ lm OUTPUT 120

10017700
White 4000K
lm LED 195 ≠ lm OUTPUT 130

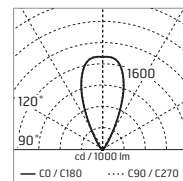
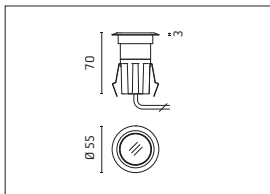

m	lux	
	Max	Med
5.00	9	5
4.00	14	8
3.00	25	15
2.00	56	33
1.00	225	131

α = 23.0° + 23.0° β = 23.0° + 23.0°

@ 4000K

Dimmable on request

IP67

Tapioca Ø 55mm -Anodized Aluminium Frame - Sandblasted Glass - Diffused Light

Light Source: Power LED / 1,6W / Total power 2,3W / CRI>80 / 12÷24Vdc / Remote electronic power supply to be ordered

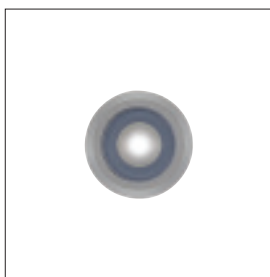

100181120
White 2700K
lm LED 167 ≠ lm OUTPUT 47

100177120
White 3000K
lm LED 180 ≠ lm OUTPUT 50

100176120
White 4000K
lm LED 195 ≠ lm OUTPUT 54

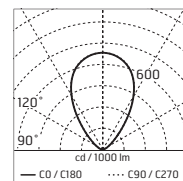
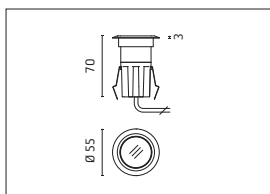

m	lux	
	Max	Med
5.00	1	1
4.00	2	1
3.00	4	2
2.00	9	5
1.00	37	18

α = 35.0° + 35.0° β = 35.0° + 35.0°

@ 4000K

Dimmable on request

IP67

Tapioca Ø 70mm - Transparent Glass - 10°

Light Source: Power LED / 4,8W / Total power 5,9W / CRI>80 / 24Vdc / Remote electronic power supply to be ordered



10018212
White 2700K
lm LED 403 ± lm OUTPUT 320

10017912
White 3000K
lm LED 433 ± lm OUTPUT 344

10018012
White 4000K
lm LED 461 ± lm OUTPUT 367

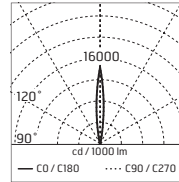

m	lux	
	Max	Med
5.00	210	128
4.00	328	200
3.00	583	356
2.00	1312	802
1.00	5248	3208

$\alpha = 5.0^\circ + 5.0^\circ$ $\beta = 5.0^\circ + 5.0^\circ$

@ 4000K

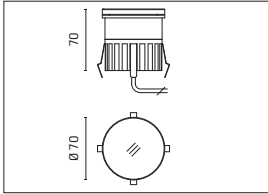

Dimmable on request

IP67

Tapioca Ø 70mm - Transparent Glass - 10°

Light Source: RGB Power LED / 3,4W / 3CHx350mA / Total power 3,4W / Remote electronic power supply to be ordered

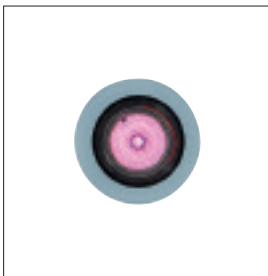

10017412

Wiring diagram and installation scheme RGB

Max 10 luminaires TAPIOCA LED RGB for each code 141

>> See Page 560
Wiring Diagram n.5

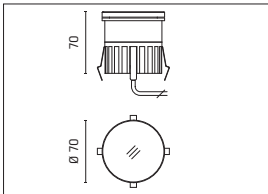

IP67

Tapioca Ø 70mm - Transparent Glass - 35°

Light Source: RGB Power LED / 3,4W / 3CHx350mA / Total power 3,4W / Remote electronic power supply to be ordered

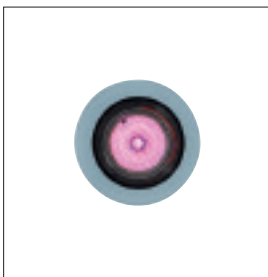

10017440

Wiring diagram and installation scheme RGB

Max 10 luminaires TAPIOCA LED RGB for each code 141

>> See Page 560
Wiring Diagram n.5

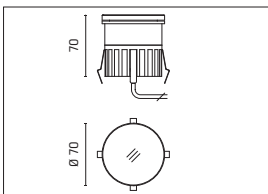

IP67

Tapioca Ø 70mm - Transparent Glass - 50°

Light Source: Power LED 4,8W / Total power 5,9W / CRI>80 / 24Vdc / Remote electronic power supply to be ordered

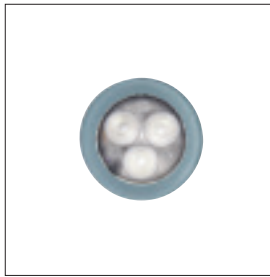

10018240
White 2700K
lm LED 403 ≈ lm OUTPUT 286

10017940
White 3000K
lm LED 433 ≈ lm OUTPUT 308

10018040
White 4000K
lm LED 461 ≈ lm OUTPUT 329

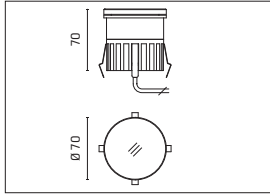

Dimmable on request

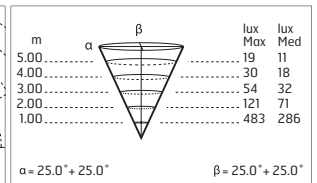
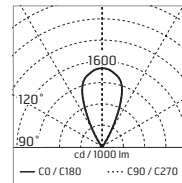

@ 4000K

IP67

Tapioca Ø 70mm - Sandblasted Glass - Diffused Light

Light Source: RGB Power LED / 4,8W / Total power 5,9W / 24Vdc / Remote electronic power supply to be ordered

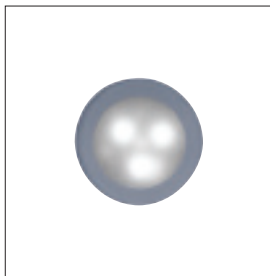

100182122
White 2700K
lm LED 403 ≈ lm OUTPUT 141

100179122
White 3000K
lm LED 433 ≈ lm OUTPUT 152

100180122
White 4000K
lm LED 461 ≈ lm OUTPUT 162

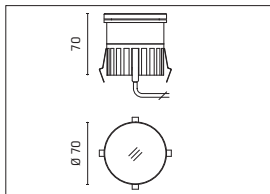

Dimmable on request

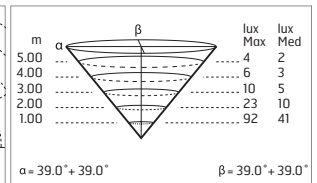
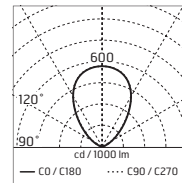

@ 4000K

IP67

Tapioca Ø 70mm - Sandblasted Glass

Light Source: RGB Power LED / 3,4W / 3CHx350mA / Total power 3,4W / Remote electronic power supply to be ordered

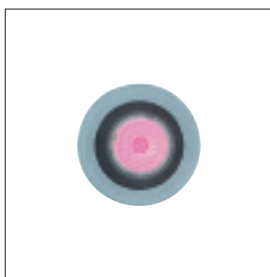

100174122

Wiring diagram and installation scheme RGB

Max 10 luminaires TAPIOCA LED RGB for each code 141

>> See Page 560
Wiring Diagram n.5

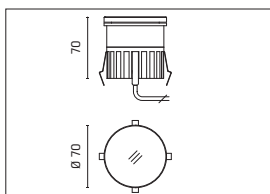

IP67

Tapioca Ø 90mm - Anodized Aluminium Frame - Transparent Glass - 10°

Light Source: Power LED / 4,8W / Total power 5,9W / CRI>80 / 24Vdc / Remote electronic power supply to be ordered

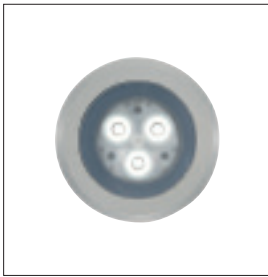

100182123
White 2700K
lm LED 403 ± lm OUTPUT 320

100179123
White 3000K
lm LED 433 ± lm OUTPUT 344

100180123
White 4000K
lm LED 461 ± lm OUTPUT 367

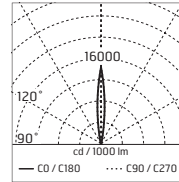

m	α	β	lux	
			Max	Med
5.00			210	128
4.00			328	200
3.00			583	356
2.00			1312	802
1.00			5248	3208

α = 5.0° + 5.0° β = 5.0° + 5.0°

@ 4000K

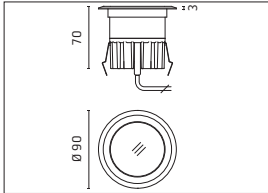

Dimmable on request

IP67

Tapioca Ø 90mm - Anodized Aluminium Frame - Transparent Glass - 10°

Light Source: RGB Power LED / 3,4W / 3CHx350mA / Total power 3,4W / Remote electronic power supply to be ordered

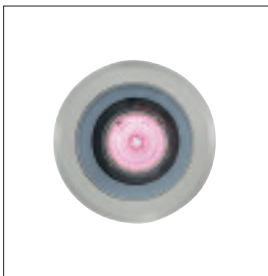

100174123

Wiring diagram and installation scheme RGB

Max 10 luminaires TAPIOCA LED RGB
for each code 141

>> See Page 560
Wiring Diagram n.5

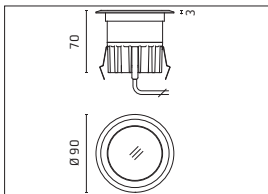

IP67

Tapioca Ø 90mm - Anodized Aluminium Frame - Transparent Glass - 35°

Light Source: RGB Power LED / 3,4W / 3CHx350mA / Total power 3,4W / Remote electronic power supply to be ordered

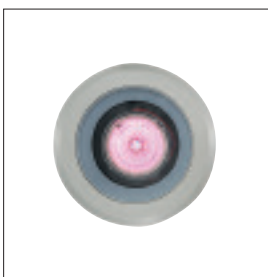

10017427

Wiring diagram and installation scheme RGB

Max 10 luminaires TAPIOCA LED RGB
for each code 141

>> See Page 560
Wiring Diagram n.5

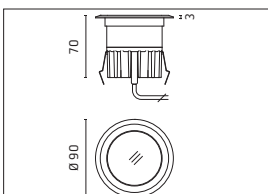

IP67

Tapioca Ø 90mm - Anodized Aluminium Frame - Transparent Glass - 50°

Light Source: Power LED / 4,8W / 24Vdc / Total power 5,9W / CRI>80 / Remote electronic power supply to be ordered

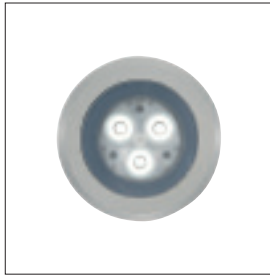

10018227
White 2700K
lm LED 403 ≈ lm OUTPUT 286

10017927
White 3000K
lm LED 433 ≈ lm OUTPUT 308

10018027
White 4000K
lm LED 461 ≈ lm OUTPUT 329

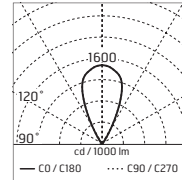
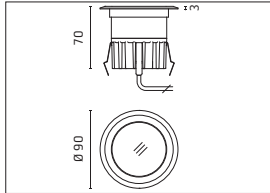

m	lux	
	Max	Med
5.00	19	11
4.00	30	18
3.00	54	32
2.00	121	71
1.00	483	286

$\alpha = 25.0^\circ + 25.0^\circ$ $\beta = 25.0^\circ + 25.0^\circ$

@ 4000K

Dimmable on request

IP67

Tapioca Ø 90mm - Anodized Aluminium Frame - Sandblasted Glass - Diffused Light

Light Source: Power LED / 4,8W / Total power 5,9W / CRI>80 / 24Vdc / Remote electronic power supply to be ordered

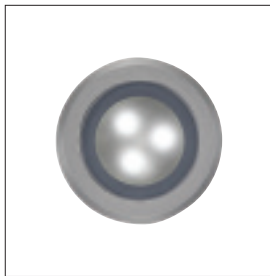

100182121
White 2700K
lm LED 403 ≈ lm OUTPUT 147

100179121
White 3000K
lm LED 433 ≈ lm OUTPUT 152

100180121
White 4000K
lm LED 461 ≈ lm OUTPUT 162

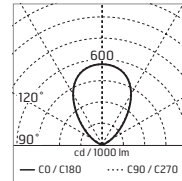
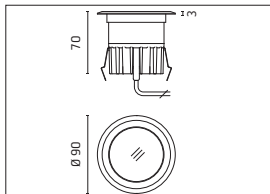

m	lux	
	Max	Med
5.00	4	2
4.00	6	3
3.00	10	5
2.00	23	10
1.00	92	41

$\alpha = 39.0^\circ + 39.0^\circ$ $\beta = 39.0^\circ + 39.0^\circ$

@ 4000K

Dimmable on request

IP67

Tapioca Ø 90mm - Anodized Aluminium Frame - Sandblasted Glass - Diffused Light

Light Source: RGB Power LED / 3,4W / 3CHx350mA / Total power 3,4W / Remote electronic power supply to be ordered

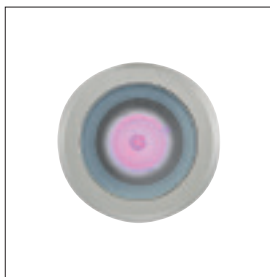

100174121

Wiring diagram and installation scheme RGB

Max 10 luminaires TAPIOCA LED RGB for each code 141

>> See Page 560
Wiring Diagram n.5

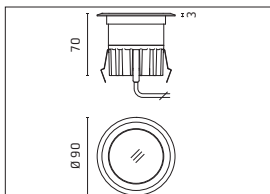

IP67

Tapioca 40x40mm - Transparent Glass - 10°

Light Source: Power LED / 1,6W / Total power 2,3W / CRI>80 / 12÷24Vdc / Remote electronic power supply to be ordered

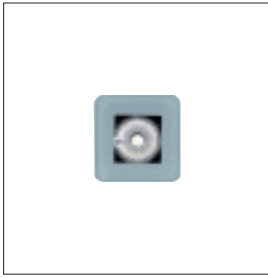

100181133
White 2700K
lm LED 167 ≈ lm OUTPUT 118

100176133
White 3000K
lm LED 180 ≈ lm OUTPUT 127

100177133
White 4000K
lm LED 195 ≈ lm OUTPUT 138

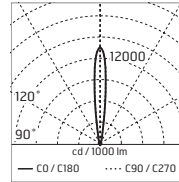

m	α	β	lux	lux
			Max	Med
5.00			77	51
4.00			121	80
3.00			214	141
2.00			482	318
1.00			1928	1273

α = 6.0° + 6.0° β = 6.0° + 6.0°

@ 4000K

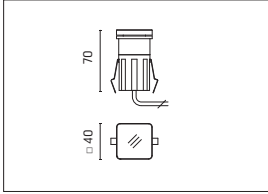

Dimmable on request

IP67

Tapioca 40x40mm - Transparent Glass - 45°

Light Source: Power LED / 1,6W / Total power 2,3W / CRI>80 / 12÷24Vdc / Remote electronic power supply to be ordered

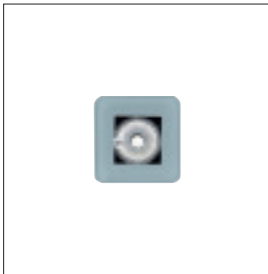

10018141
White 2700K
lm LED 167 ≈ lm OUTPUT 112

10017641
White 3000K
lm LED 180 ≈ lm OUTPUT 120

10017741
White 4000K
lm LED 195 ≈ lm OUTPUT 130

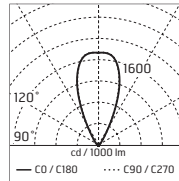

m	α	β	lux	lux
			Max	Med
5.00			9	5
4.00			14	8
3.00			25	15
2.00			56	33
1.00			225	131

α = 23.0° + 23.0° β = 23.0° + 23.0°

@ 4000K

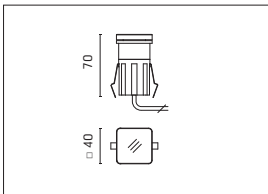

Dimmable on request

IP67

Tapioca 40x40mm - Sandblasted Glass - Diffused Light

Light Source: Power LED / 1,6W / Total power 2,3W / CRI>80 / 12÷24Vdc / Remote electronic power supply to be ordered

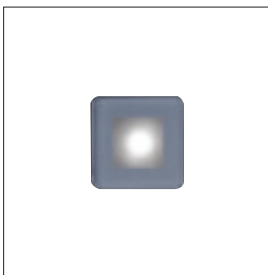

100181124
White 2700K
lm LED 167 ≈ lm OUTPUT 47

100176124
White 3000K
lm LED 180 ≈ lm OUTPUT 50

100177124
White 4000K
lm LED 195 ≈ lm OUTPUT 54

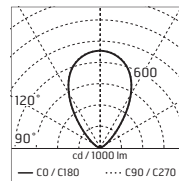

m	α	β	lux	lux
			Max	Med
5.00			1	1
4.00			2	1
3.00			4	2
2.00			9	5
1.00			37	18

α = 35.0° + 35.0° β = 35.0° + 35.0°

@ 4000K

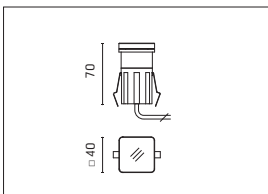

Dimmable on request

IP67

Tapioca 70x70mm - Transparent Glass - 10°

Light Source: Power LED / 4,8W / Total power 5,9W / CRI>80 / 24Vdc / Remote electronic power supply to be ordered



100182132
White 2700K
lm LED 403 ≈ lm OUTPUT 320

100179132
White 3000K
lm LED 433 ≈ lm OUTPUT 344

100180132
White 4000K
lm LED 461 ≈ lm OUTPUT 367

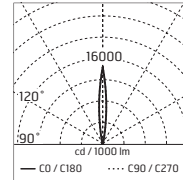

m	lux	
	Max	Med
5.00	210	128
4.00	328	200
3.00	583	356
2.00	1312	802
1.00	5248	3208

α = 5.0° + 5.0° β = 5.0° + 5.0°

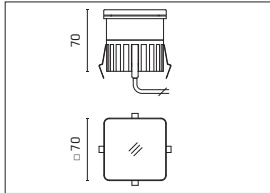

Dimmable on request

IP67

@ 4000K

Tapioca 70x70mm - Transparent Glass - 10°

Light Source: RGB Power LED / 3,4W / 3CHx350mA / Total power 3,4W / Remote electronic power supply to be ordered

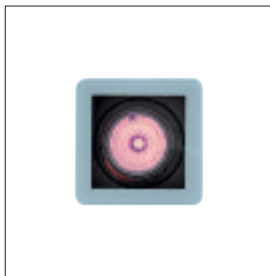

100174132

Wiring diagram and installation scheme RGB

Max 10 luminaires TAPIOCA LED RGB
for each code 141

>> See Page 560
Wiring Diagram n.5

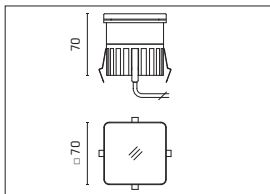

IP67

Tapioca 70x70mm - Transparent Glass - 35°

Light Source: RGB Power LED / 3,4W / 3CHx350mA / Total power 3,4W / Remote electronic power supply to be ordered



10017441

Wiring diagram and installation scheme RGB

Max 10 luminaires TAPIOCA LED RGB
for each code 141

>> See Page 560
Wiring Diagram n.5

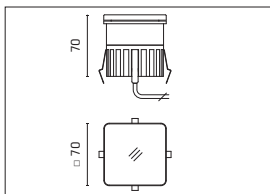

IP67

Tapioca 70x70mm - Transparent Glass - 50°

Light Source: Power LED / 4,8W / Total power 5,9W / CRI>80 / 24Vdc / Remote electronic power supply to be ordered



10018241
White 2700K
lm LED 403 ≠ lm OUTPUT 286

10017941
White 3000K
lm LED 433 ≠ lm OUTPUT 308

10018041
White 4000K
lm LED 461 ≠ lm OUTPUT 329

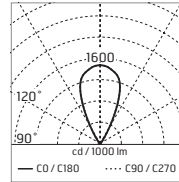

m	α	lux	
		Max	Med
5.00		19	11
4.00		30	18
3.00		54	32
2.00		121	71
1.00		483	286

α = 25.0° + 25.0° β = 25.0° + 25.0°

@ 4000K

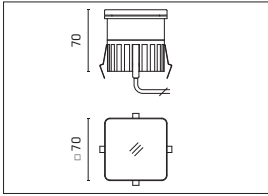

Dimmable on request

IP67

Tapioca 70x70mm - Sandblasted Glass - Diffused Light

Light Source: Power LED / 4,8W / Total power 5,9W / CRI>80 / 24Vdc / Remote electronic power supply to be ordered

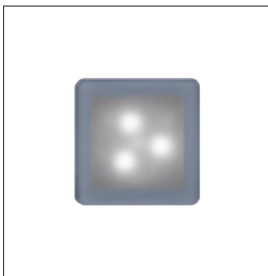

100182125
White 2700K
lm led 403 ≠ lm output 147

100179125
White 3000K
lm LED 433 ≠ lm OUTPUT 158

100180125
White 4000K
lm LED 461 ≠ lm OUTPUT 162

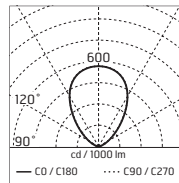

m	α	lux	
		Max	Med
5.00		4	2
4.00		6	3
3.00		10	5
2.00		23	10
1.00		92	41

α = 39.0° + 39.0° β = 39.0° + 39.0°

@ 4000K

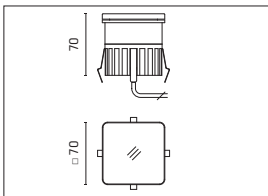

Dimmable on request

IP67

Tapioca 70x70mm - Sandblasted Glass - Diffused Light

Light Source: Power LED / 3,4W / 3CHx350mA / Total power 3,4W / Remote electronic power supply to be ordered



100174125

Wiring diagram and installation scheme RGB

Max 10 luminaires TAPIOCA LED RGB for each code 141

>> See Page 560
Wiring Diagram n.5

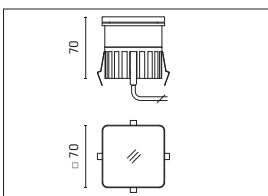

IP67



Accessories: Tapioca

98
BOX FOR INSTALLATION
Ø 75 H 90mm

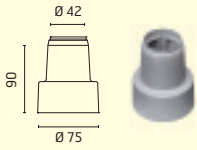

99
BOX FOR INSTALLATION
75 x 75 H 90mm

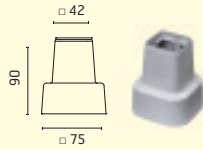

101
BOX FOR INSTALLATION
Ø 130 H 110mm

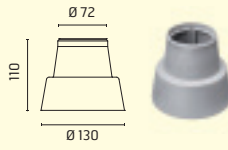

102
BOX FOR INSTALLATION
125 x 125 H 110mm

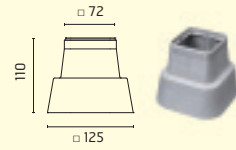

150
POWER SUPPLY DUAL FUNCTION
Vout 24Vdc: 8W/100÷240V
Iout 350mA: 6x1W/100÷240V
IP20 CLASS II SELV EQ.

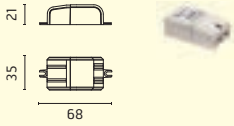

106
POWER SUPPLY DUAL FUNCTION
Vout 24Vdc: 8W/100÷240V
Iout 350mA: 6x1W/100÷240V
IP65 CLASS II SELV EQ.

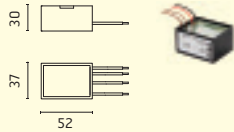

87
POWER SUPPLY 10W/110÷240V -
24Vdc IP20 CLASS II SELV.

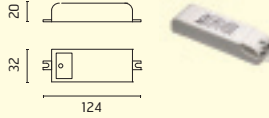

175
POWER SUPPLY 10W/110÷240V -
24Vdc
IP67 CLASS II SELV.

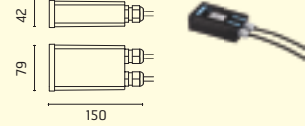

acc. code ▶	98	99	101	102	150	106	87	175	147	155	110	141	142	143	187	186	269
prod. code ▼																	
10017412			•									10*	•	•	•	•	
10017427			•									10*	•	•	•	•	
10017440			•									10*	•	•	•	•	
10017441				•								10*	•	•	•	•	
10017600	•				1	1	4	4	5	14	29						•
10017612	•				1	1	4	4	5	14	29						•
10017640	•				1	1	4	4	5	14	29						•
10017641		•			1	1	4	4	5	14	29						•
10017700	•				1	1	4	4	5	14	29						•
10017712	•				1	1	4	4	5	14	29						•
10017740	•				1	1	4	4	5	14	29						•
10017741		•			1	1	4	4	5	14	29						•
10017912			•				1	1	2	6	12						•
10017927			•				1	1	2	6	12						•
10017940			•				1	1	2	6	12						•
10017941				•			1	1	2	6	12						•
10018012			•				1	1	2	6	12						•
10018027			•				1	1	2	6	12						•
10018040			•				1	1	2	6	12						•
10018041				•			1	1	2	6	12						•
10018100	•				1	1	4	4	5	14	29						•
10018112	•				1	1	4	4	5	14	29						•
10018140	•				1	1	4	4	5	14	29						•
10018141		•			1	1	4	4	5	14	29						•
10018212			•				1	1	2	6	12						•
10018227			•				1	1	2	6	12						•
10018240			•				1	1	2	6	12						•
10018241				•			1	1	2	6	12						•
100174121			•									10*	•	•	•	•	
100174122			•									10*	•	•	•	•	
100174123			•									10*	•	•	•	•	
100174125				•								10*	•	•	•	•	
100174132				•								10*	•	•	•	•	

Accessories: Tapioca

147
POWER SUPPLY 20W/220÷240V -
24Vdc IP67 CLASS II SELV.

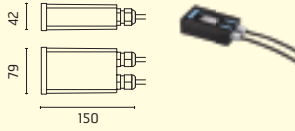

155
POWER SUPPLY 50W/120÷240V -
24Vdc
IP67 CLASS II SELV.

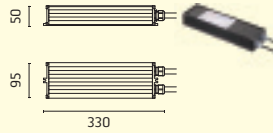

110
POWER SUPPLY 70W/220÷240V -
24Vdc
IP67 CLASS II SELV EQ.

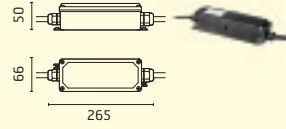

141
POWER SUPPLY WITH DMX
INTERFACE FOR RGB FIXTURES
36W/220÷240V-3CHx350mA
(3CHx10x1W) DMX CONTROL ALLOWED
IP67 CLASS I SELV EQ.

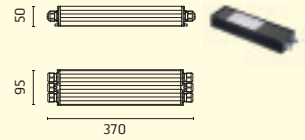

142
DMX CONTROLLER;
DIMMER SWITCH FOR RECESSED BOX
(60mm HOLE CENTRES)



143
DMX CONTROLLER;
STAND-ALONE/PC INTERFACE

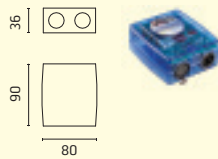

187
DMX SPLITTER 512 - ELECTRONIC DEVICE
TO REGENERATE THE MONODIRECTIONAL
DMX SIGNAL
1 INPUT AND 7 OUTPUT, 12-24Vdc

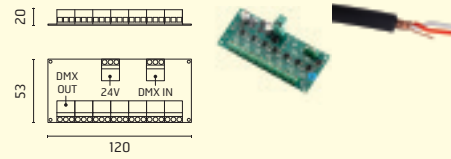

186
DMX CABLE - SHIELDED TWISTED PAIR
WITH 110 Ohm CONSTANT IMPEDANCE.

**POWER SUPPLY TO BE ORDERED (87 OR
175 RECOMMENDED)**

269
2 WAY TERMINAL BLOCK 2 POLES IP68
(Ø4÷6,9mm Cable)
*it can't be placed in the recessed box
for installation



acc. code ▶	98	99	101	102	150	106	87	175	147	155	110	141	142	143	187	186	269
prod. code ▼																	
100176118	•				1	1	4	4	5	14	29						•
100176119	•				1	1	4	4	5	14	29						•
100176120	•				1	1	4	4	5	14	29						•
100176124		•			1	1	4	4	5	14	29						•
100176133		•			1	1	4	4	5	14	29						•
100177118	•				1	1	4	4	5	14	29						•
100177119	•				1	1	4	4	5	14	29						•
100177120	•				1	1	4	4	5	14	29						•
100177124		•			1	1	4	4	5	14	29						•
100177133		•			1	1	4	4	5	14	29						•
100179121			•				1	1	2	6	12						•
100179122			•				1	1	2	6	12						•
100179123			•				1	1	2	6	12						•
100179125				•			1	1	2	6	12						•
100179132				•			1	1	2	6	12						•
100180121			•				1	1	2	6	12						•
100180122			•				1	1	2	6	12						•
100180123			•				1	1	2	6	12						•
100180125				•			1	1	2	6	12						•
100180132				•			1	1	2	6	12						•
1w00181118	•				1	1	4	4	5	14	29						•
100181119	•				1	1	4	4	5	14	29						•
100181120	•				1	1	4	4	5	14	29						•
100181124		•			1	1	4	4	5	14	29						•
100181133		•			1	1	4	4	5	14	29						•
100182121			•				1	1	2	6	12						•
100182122			•				1	1	2	6	12						•
100182123			•				1	1	2	6	12						•
100182125		•					1	1	2	6	12						•
100182132				•			1	1	2	6	12						•

Max fixtures for each power supply (Vin 220÷240). Data in the chart are provided as a guide only. Please verify according to your installation.
* The voltage at the end of the system depends on the number of fixtures connected in series, please comply with CEI 64-8 standards.



- Square or round luminaire – for installation in-ground where recessing depth are limited (up to 120mm) – recessed.
- Configuration: die-cast aluminium structure, EN AB-47100 alloy (low copper content). AISI 316L stainless steel outer frame. Glass diffuser: transparent with silkscreen border.
- Double layer coating for high resistance to corrosion: the aluminium components are painted with a double coat using powders which are compliant with QUALICOAT standards: a first layer of epoxy powder (with excellent chemical and mechanical resistance) and a second finishing layer of polyester powder (resistant to UV rays and atmospheric agents). The entire painting process of the aluminium fitting starts from components which have been sandblasted in advance to make the surface more porous and increase the adherence of the paint. Ares effects alkaline and acid washing to clean the surfaces completely, then rinses with demineralised water to remove any residue particles, subsequently a chemical conversion treatment is done to protect against rusting.
- Protection rating: IP67
- In compliance with EN 60598-1 standards
- Class of insulation: I
- Installation: the luminaire is equipped with a piece of cable with a 2-way connector for 3-conductor cables (H2O STOP) for an easy-to-make connection. RGB version: the luminaire is equipped with 2 pieces of cable, no H2O STOP connector provided. Outdoor use requires suitable flexible cables. Installation requires a dedicated box to be ordered separately. It is important to provide a >300mm gravel layer or a drain system (for concrete surfaces) to ensure good drainage and to avoid water stagnation.
- We recommend the use of a connection system with a protection degree greater than or equal to the protection degree of the luminaire.
- During the installation and the maintenance of the fixtures it is important to be careful and avoid damages on the paint coating. Damages on the coating exposed to outdoor conditions or water, could cause corrosion. Chemical substances affect the anticorrosion covering protection.

EU Regulation 874/2012 - Illumination equipment energy classes



LED VERSION:
Class A/A+/A++
Luminaire supplied
with integrated LED modules
that cannot be replaced



.0 Inox



Recessed ground fitting



Installation requires a 30cm water drainage layer (gravel)



Do not install in hollow areas



Pre-wired with approx 250mm of cable (RGB: pre-wired with 2x250mm cables)



Protection against water ingress from the cable (not for RGB versions)



Static load: 2000Kg walk over (round version)
Static load: 3000Kg walk over (square version)



Drive over



Glass surface temperature <70°C



Protection against impact.
IK 09 - 10,00 joule

Cassiopea Round Version - 10°

Light Source: Power LED / 22W / Total power 28W / CRI>80 / 110÷240V / Integral electronic power supply

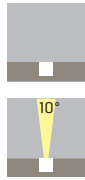
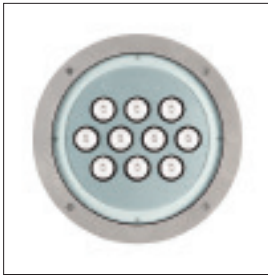

7511512
7511512-300 Dimmable Dali
7511512-310 Dimmable 1-10
 White 2700K
 lm LED 2327 ≠ lm OUTPUT 1883

7511312
7511312-300 Dimmable Dali
7511312-310 Dimmable 1-10
 White 3000K
 lm LED 2502 ≠ lm OUTPUT 2025

7518412
7518412-300 Dimmable Dali
7518412-310 Dimmable 1-10
 White 4000K
 lm LED 2664 ≠ lm OUTPUT 2156

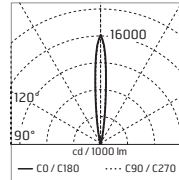

m	lux	
	Max	Med
5.00	1400	884
4.00	2188	1381
3.00	3890	2455
2.00	8753	5525
1.00	35011	22099

$\alpha = 5.0^\circ + 5.0^\circ$ $\beta = 5.0^\circ + 5.0^\circ$

@ 4000K

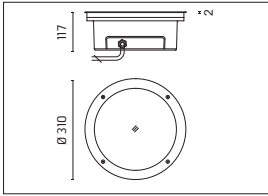

IP67

Cassiopea Round Version - 30°

Light Source: Power LED / 22W / Total power 28W / CRI>80 / 110÷240V / Integral electronic power supply

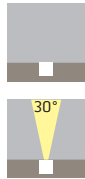
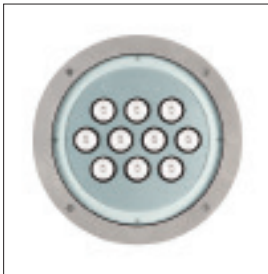

7511413
7511413-300 Dimmable Dali
7511413-310 Dimmable 1-10
 White 2700K
 lm LED 2327 ≠ lm OUTPUT 1783

7511313
7511313-300 Dimmable Dali
7511313-310 Dimmable 1-10
 White 3000K
 lm LED 2502 ≠ lm OUTPUT 1917

7518413
7518413-300 Dimmable Dali
7518413-310 Dimmable 1-10
 White 4000K
 lm LED 2664 ≠ lm OUTPUT 2041

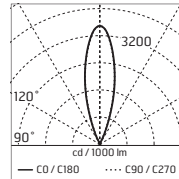

m	lux	
	Max	Med
5.00	287	173
4.00	449	270
3.00	798	479
2.00	1795	1079
1.00	7181	4314

$\alpha = 15.0^\circ + 15.0^\circ$ $\beta = 15.0^\circ + 15.0^\circ$

@ 4000K

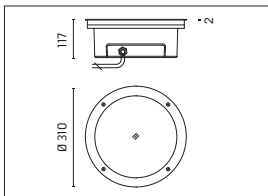

IP67

Cassiopea Round Version - 10°

Light Source: RGB Power LED / 34W / Total power 40W / 230V with DMX - RDM / 110÷240V / Integral electronic power supply

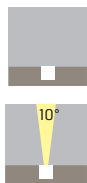
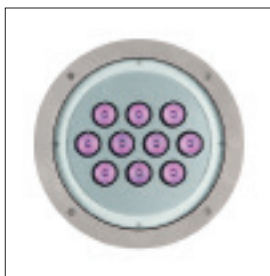

7518512.A

Wiring diagram and installation scheme RGB

>> See Page 561
Wiring Diagram n.8

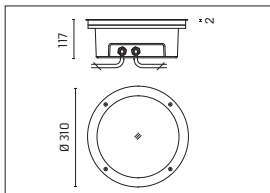

IP67   CE

Cassiopea Round Version - 35°

Light Source: RGB Power LED / 34W / Total power 40W / 230V with DMX - RDM / 110÷240V / Integral electronic power supply

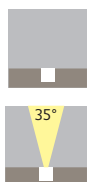
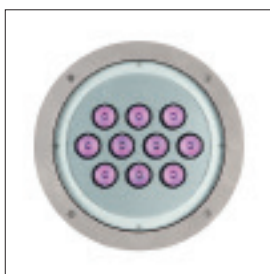

7518513.A

Wiring diagram and installation scheme RGB

>> See Page 561
Wiring Diagram n.8

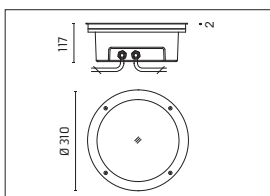

IP67   CE

Cassiopea Square Version - 10°

Light Source: Power LED / 22W / Total power 28W / CRI>80 / 110÷240V / Integral electronic power supply

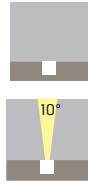

7611512
7611512-300 Dimmable Dali
7611512-310 Dimmable 1-10
 White 2700K
 lm LED 2327 ≠ lm OUTPUT 1883

7611312
7611312-300 Dimmable Dali
7611312-310 Dimmable 1-10
 White 3000K
 lm LED 2502 ≠ lm OUTPUT 2025

7618412
7618412-300 Dimmable Dali
7618412-310 Dimmable 1-10
 White 4000K
 lm LED 2664 ≠ lm OUTPUT 2156

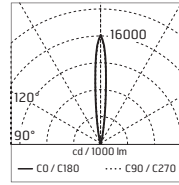

m	lux	
	Max	Med
5.00	1400	884
4.00	2188	1381
3.00	3890	2455
2.00	8753	5525
1.00	35011	22099

$\alpha = 5.0^\circ + 5.0^\circ$ $\beta = 5.0^\circ + 5.0^\circ$

@ 4000K

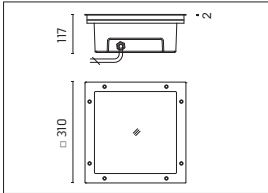

IP67

Cassiopea Square Version - 30°

Light Source: Power LED / 22W / Total power 28W / CRI>80 / 110÷240V / Integral electronic power supply

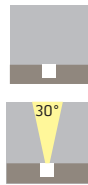
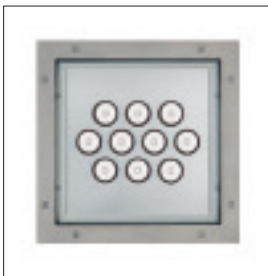

7611513
7611513-300 Dimmable Dali
7611513-310 Dimmable 1-10
 White 2700K
 lm LED 2327 ≠ lm OUTPUT 1783

7611313
7611313-300 Dimmable Dali
7611313-310 Dimmable 1-10
 White 3000K
 lm LED 2502 ≠ lm OUTPUT 1917

7618413
7618413-300 Dimmable Dali
7618413-310 Dimmable 1-10
 White 4000K
 lm LED 2664 ≠ lm OUTPUT 2041

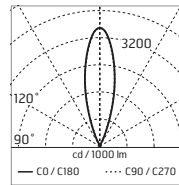

m	lux	
	Max	Med
5.00	287	173
4.00	449	270
3.00	798	479
2.00	1795	1079
1.00	7181	4314

$\alpha = 15.0^\circ + 15.0^\circ$ $\beta = 15.0^\circ + 15.0^\circ$

@ 4000K

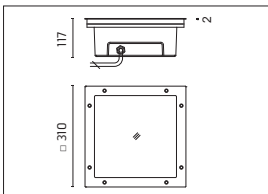

IP67

Cassiopea Square Version - 10°

Light Source: RGB Power LED / 34W / Total power 40W / 230V with DMX - RDM / 110÷240V / Integral electronic power supply

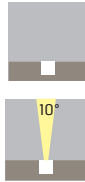
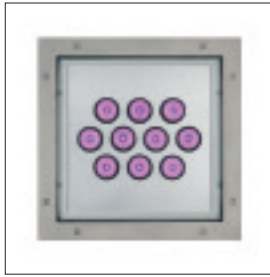

7618512.A

Wiring diagram and installation scheme RGB

>> See Page 561
Wiring Diagram n.8

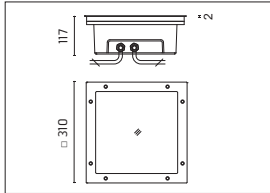

IP67   CE

Cassiopea Square Version - 35°

Light Source: RGB Power LED / 34W / Total power 40W / 230V with DMX - RDM / 110÷240V / Integral electronic power supply

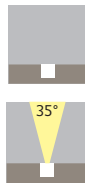
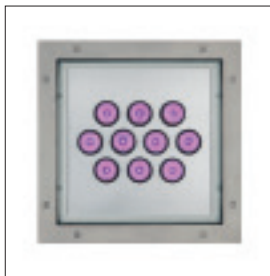

7618513.A

Wiring diagram and installation scheme RGB

>> See Page 561
Wiring Diagram n.8

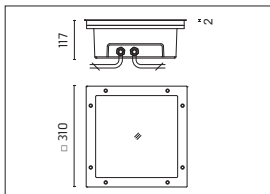

IP67   CE



Accessories: Cassiopea

73
BOX FOR INSTALLATION
405 x 405 H 120mm

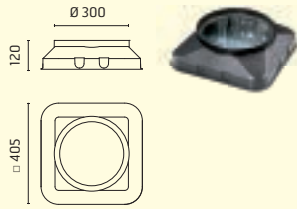

74
BOX FOR INSTALLATION
405 x 405 H 120mm

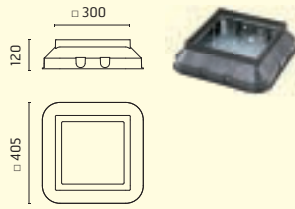

215
3/4 WAY TERMINAL BLOCK 4 POLES
IP68 H₂O STOP (Ø5,5±12mm CABLE)

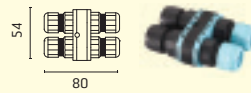

142
DMX CONTROLLER;
DIMMER SWITCH FOR RECESSED BOX
(60mm HOLE CENTRES)



143
DMX CONTROLLER;
STAND-ALONE/PC INTERFACE

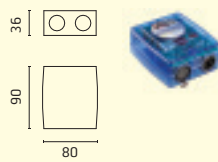

187
DMX SPLITTER 512 - ELECTRONIC DEVICE
TO REGENERATE THE MONODIRECTIONAL
DMX SIGNAL
1 INPUT AND 7 OUTPUT, 12-24V dc

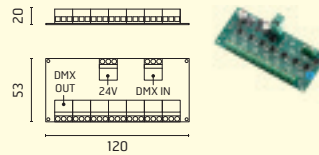

186
DMX CABLE - SHIELDED TWISTED PAIR
WITH 110 Ohm CONSTANT IMPEDANCE.



237
SPD: (SURGE PROTECTION DEVICE)
275Vac
MAXIMUM DISCHARGE CURRENT 10KA
(8/20µs)
MAXIMUM OPERATING CURRENT 5A
SUITABLE FOR SERIES CONNECTION
- IP66

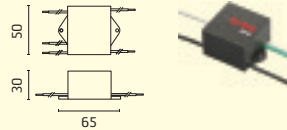

POWER SUPPLY TO BE ORDERED (87 OR 175 RECOMMENDED)

acc. code ▶ prod. code ▼	dim 1 DALI	dim 1-10	73	74	215	142	143	187	186	237
7511312	-300	-310	•		•					•
7511313	-300	-310	•		•					•
7511413	-300	-310	•		•					•
7511512	-300	-310	•		•					•
7518412	-300	-310	•		•					•
7518413	-300	-310	•		•					•
7518512.A			•			•	•	•	•	•
7518513.A			•			•	•	•	•	•
7611312	-300	-310		•	•					•
7611313	-300	-310		•	•					•
7611512	-300	-310		•	•					•
7611513	-300	-310		•	•					•
7618412	-300	-310		•	•					•
7618413	-300	-310		•	•					•
7618512.A				•		•	•	•	•	•
7618513.A				•		•	•	•	•	•



- Linear luminaire for installation in ground or ceiling – recessed.
- Configuration: extruded aluminium body and die-cast double closing end on each side. Glass diffuser: 8mm thick transparent or sandblasted with silkscreen border, fixed to the aluminium body through a robotic gluing system.
- Double layer coating for high resistance to corrosion: the aluminium components are painted with a double coat using powders which are compliant with QUALICOAT standards: a first layer of epoxy powder (with excellent chemical and mechanical resistance) and a second finishing layer of polyester powder (resistant to UV rays and atmospheric agents). The entire painting process of the aluminium fitting starts from components which have been sandblasted in advance to make the surface more porous and increase the adherence of the paint. Ares effects alkaline and acid washing to clean the surfaces completely, then rinses with demineralised water to remove any residue particles, subsequently a chemical conversion treatment is done to protect against rusting.
- Protection rating: IP67
- In compliance with EN 60598-1 standards
- Class of insulation: fluorescent lamp: II; LED module: I
- Installation: the electrical components are installed on a removable frame. Wiring through two plastic M20 cable glands (6\times12mm cables) placed on one of the two closing ends where a plastic box allows connection to the removable electric module. RGB version: the luminaire is equipped with two pieces of cable for an easy-to-make connection. Outdoor use requires suitable flexible cables assuring the watertightness of the cable gland. Installation requires a dedicated box to be ordered separately. It is important to provide a >200mm gravel layer or a drain system (for concrete surfaces) to ensure good drainage and to avoid water stagnation.
- We recommend the use of a connection system with a protection degree greater than or equal to the protection degree of the luminaire.
- During the installation and the maintenance of the fixtures it is important to be careful and avoid damages on the paint coating.
Damages on the coating exposed to outdoor conditions or water, could cause corrosion.
Chemical substances affect the anticorrosion covering protection.

EU Regulation 874/2012 - Illumination equipment energy classes

A++
A+
A
A+

LED VERSION:
Class A/A+/A++
Luminaire supplied with integrated LED modules that cannot be replaced

FLUORESCENT VERSION:
Class A+
T16/G5



	Recessed ground fitting		Ceiling recessed installation (for L 645 and L 1245 version only)
	Do not install in hollow areas		Installation requires a 20cm water drainage layer (gravel)
	The fitting is equipped with 2 cable input.		Version RGB: Pre-wired with approx 200mm of cable
	Static load: 1500Kg walk over		Check that diffuser's temperature "T max °C"(tested at 25°C) complies with your local regulation Glass surface temperature <70°C for LED source
	Protection against impact. IK 09 - 10,00 joule		

Cielo L 645 mm - Transparent Glass - Symmetric Optic

Light Source: T16 / 14W / G5 / T 40°C / Electronic ballast

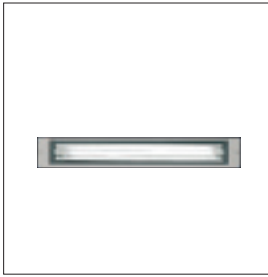

944213
944213-300 Dimmable Dali

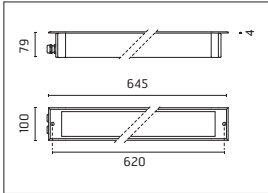
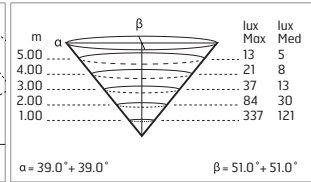
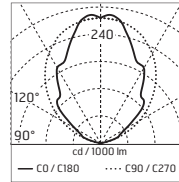

IP67

Cielo L 645 mm - Sandblasted Glass - Symmetric Optic

Light Source: T16 / 14W / G5 / T 40°C / Electronic ballast



944257
944257-300 Dimmable Dali

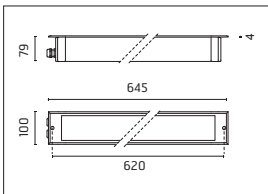
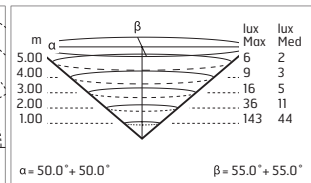
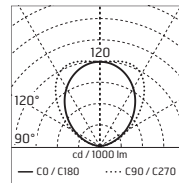

IP67

Cielo L 645 mm - Transparent Glass - Asymmetric Optic

Light Source: T16 / 14W / G5 / T 40°C / Electronic ballast

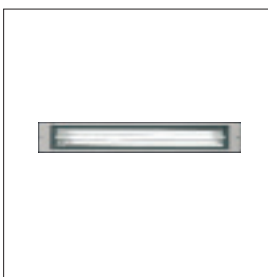

944214
944214-300 Dimmable Dali

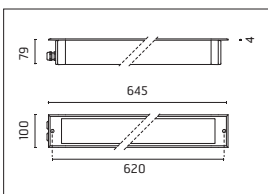
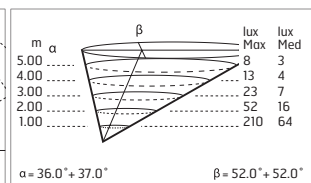
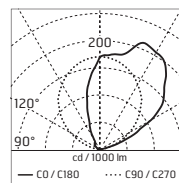

IP67

Cielo L 645 mm - Transparent Glass - Adjustable Optic - 10°

Light Source: Power LED / 13,2W / Total power 16W / CRI >80 / 220÷240V / Integral electronic power supply

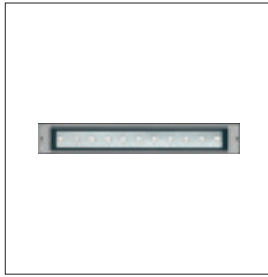

948512
948512-300 Dimmable Dali
948512-310 Dimmable 1-10
 White 2700K
 lm LED 1339 ≠ lm OUTPUT 1222

948312
948312-300 Dimmable Dali
948312-310 Dimmable 1-10
 White 3000K
 lm LED 1440 ≠ lm OUTPUT 1314

9418612
9418612-300 Dimmable Dali
9418612-310 Dimmable 1-10
 White 4000K
 lm LED 1560 ≠ lm OUTPUT 1423

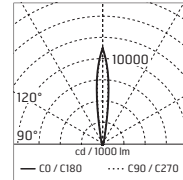

m	lux	
	Max	Med
5.00	637	397
4.00	995	621
3.00	1769	1104
2.00	3980	2484
1.00	15922	9936

$\alpha = 6.0^\circ + 6.0^\circ$ $\beta = 6.0^\circ + 6.0^\circ$

@ 4000K

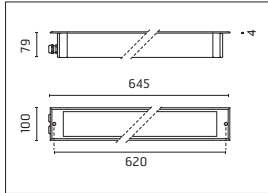

IP67

Cielo L 645 mm - Transparent Glass - Adjustable Optic - 45°

Light Source: Power LED / 13,2W / Total power 16W / CRI >80 / 220÷240V / Integral electronic power supply

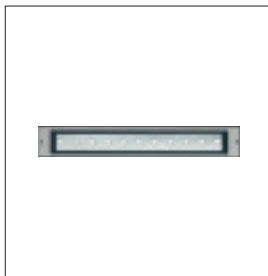

948513
948513-300 Dimmable Dali
948513-310 Dimmable 1-10
 White 2700K
 lm LED 1339 ≠ lm OUTPUT 1071

948313
948313-300 Dimmable Dali
948313-310 Dimmable 1-10
 White 3000K
 lm LED 1440 ≠ lm OUTPUT 1152

9418613
9418613-300 Dimmable Dali
9418613-310 Dimmable 1-10
 White 4000K
 lm LED 1560 ≠ lm OUTPUT 1248

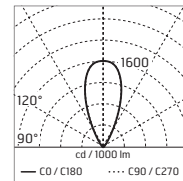

m	lux	
	Max	Med
5.00	80	49
4.00	125	76
3.00	223	135
2.00	502	303
1.00	2007	1213

$\alpha = 22.0^\circ + 22.0^\circ$ $\beta = 22.0^\circ + 22.0^\circ$

@ 4000K

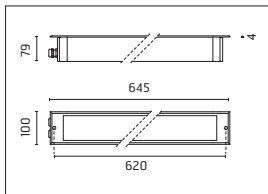

IP67

Cielo L 645 mm - Sandblasted Glass

Light Source: RGB Power LED / 28W / Total power 26W / 220÷240V with DMX-RDM interface / Integral electronic power supply

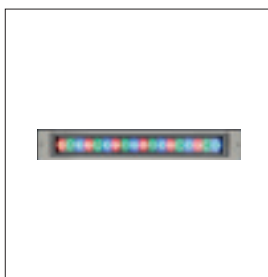

9418713.A

Wiring diagram and installation scheme RGB

>> See Page 561
 Wiring Diagram n.8

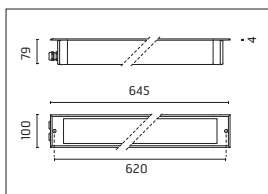

IP67

Cielo L 645 mm - Transparent Glass - Adjustable Optic - 12°+ 54°

Light Source: Power LED / 13,2W / Total power 16W / CRI >80 / 220÷240V / Integral electronic power supply

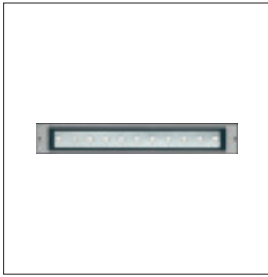

9485131
9485131-300 Dimmable Dali
9485131-310 Dimmable 1-10
 White 2700K
 Im LED 1339 ≈ Im OUTPUT 1074

9483131
9483131-300 Dimmable Dali
9483131-310 Dimmable 1-10
 White 3000K
 Im LED 1440 ≈ Im OUTPUT 1155

94186131
94186131-300 Dimmable Dali
94186131-310 Dimmable 1-10
 White 4000K
 Im LED 1560 ≈ Im OUTPUT 1251

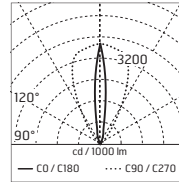

m	α	β	lux	
			Max	Med
5.00			184	113
4.00			287	176
3.00			511	313
2.00			1149	704
1.00			4597	2816

α = 6.0° + 6.0° β = 27.0° + 27.0°

@ 4000K

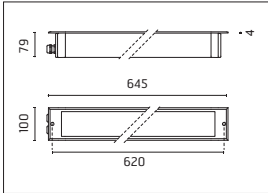

IP67

Cielo L 1245 mm - Transparent Glass - Symmetric Optic

Light Source: T16 / 28W / G5 / T 40°C / Electronic ballast

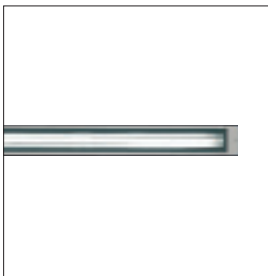

944813
944813-300 Dimmable Dali

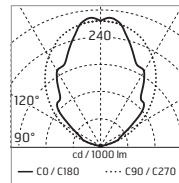

m	α	β	lux	
			Max	Med
5.00			29	10
4.00			46	16
3.00			81	29
2.00			183	66
1.00			731	262

α = 39.0° + 39.0° β = 51.0° + 51.0°

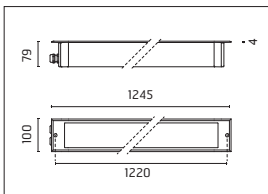

IP67

Cielo L 1245 mm - Sandblasted Glass - Symmetric Optic

Light Source: T16 / 28W / G5 / T 40°C / Electronic ballast

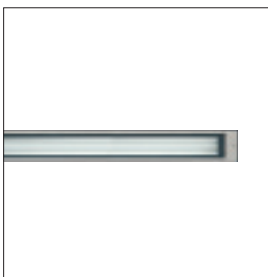

944857
944857-300 Dimmable Dali

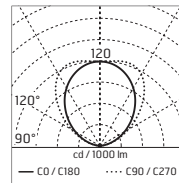

m	α	β	lux	
			Max	Med
5.00			12	4
4.00			19	6
3.00			34	11
2.00			77	24
1.00			310	95

α = 50.0° + 50.0° β = 55.0° + 55.0°

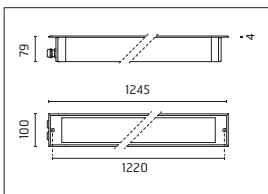

IP67

Cielo L 1245 mm - Transparent Glass - Asymmetric Optic

Light Source: T16 / 28W / G5 / T 40°C / Electronic ballast

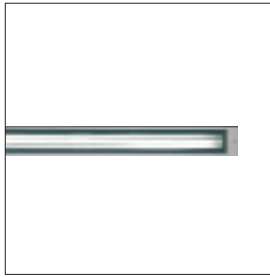

944814
944814-300 Dimmable Dali

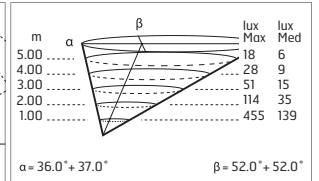
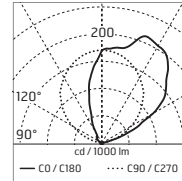
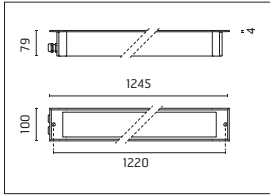

IP67

Cielo L 1245 mm - Transparent Glass - Adjustable Optic - 10°

Light Source: Power LED / 26,4W / Total power 32W / CRI >80 / 220÷240V / Integral electronic power supply

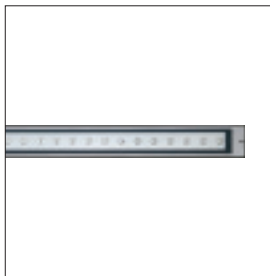

948612
948612-300 Dimmable Dali
948612-310 Dimmable 1-10
 White 2700K
 lm LED 2678 ≈ lm OUTPUT 2444

948012
948012-300 Dimmable Dali
948012-310 Dimmable 1-10
 White 3000K
 lm LED 2880 ≈ lm OUTPUT 2628

9418812
9418812-300 Dimmable Dali
9418812-310 Dimmable 1-10
 White 4000K
 lm LED 3120 ≈ lm OUTPUT 2847

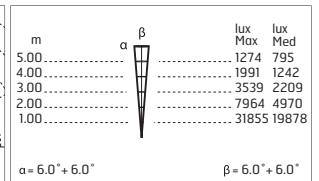
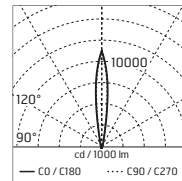
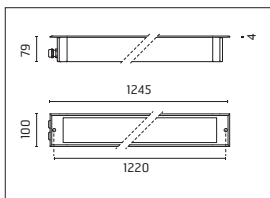

@ 4000K

IP67

Cielo L 1245 mm - Transparent Glass - Adjustable Optic - 45°

Light Source: Power LED / 26,4W / Total power 32W / CRI >80 / 220÷240V / Integral electronic power supply

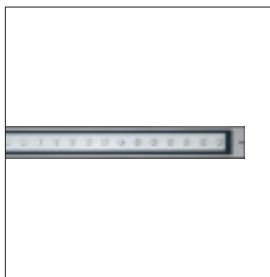

948613
948613-300 Dimmable Dali
948613-310 Dimmable 1-10
 White 2700K
 lm LED 2678 ≈ lm OUTPUT 2142

948013
948013-300 Dimmable Dali
948013-310 Dimmable 1-10
 White 3000K
 lm LED 2880 ≈ lm OUTPUT 2303

9418813
9418813-300 Dimmable Dali
9418813-310 Dimmable 1-10
 White 4000K
 lm LED 3120 ≈ lm OUTPUT 2495

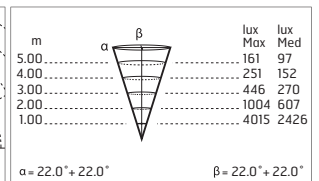
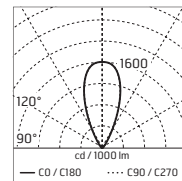
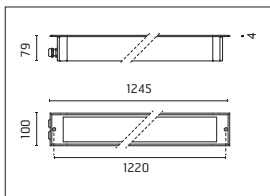

@ 4000K

IP67

Cielo L 1245 mm - Sandblasted Glass

Light Source: RGB Power LED / 48W / Total power 44W / 220÷240V with DMX-RDM interface / Integral electronic power supply

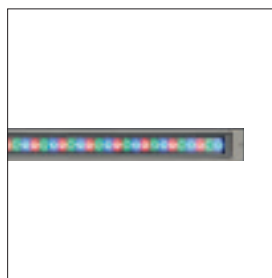

9418913.A

Wiring diagram and installation scheme RGB

>> See Page 561
Wiring Diagram n.8

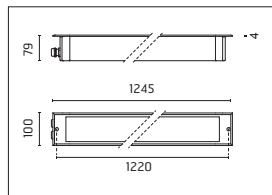

IP67

Cielo L 1245 mm - Transparent Glass - Adjustable Optic - 12° + 54°

Light Source: Power LED / 26,4W / Total power 32W / CRI >80 / 220÷240V / Integral electronic power supply

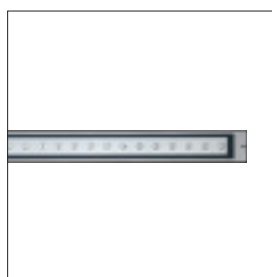

9486131
9486131-300 Dimmable Dali
9486131-310 Dimmable 1-10
White 2700K
lm LED 2678 ≈ lm OUTPUT 2148

9480131
9480131-300 Dimmable Dali
9480131-310 Dimmable 1-10
White 3000K
lm LED 2880 ≈ lm OUTPUT 2310

94188131
94188131-300 Dimmable Dali
94188131-310 Dimmable 1-10
White 4000K
lm LED 3120 ≈ lm OUTPUT 2503

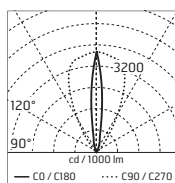

m	lux Max	lux Med
5.00	368	225
4.00	575	352
3.00	1022	626
2.00	2299	1408
1.00	9194	5632

α = 6.0° + 6.0° β = 27.0° + 27.0°
@ 4000K

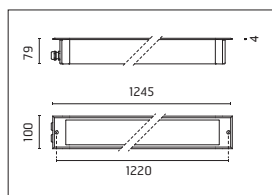

IP67

Cielo L 1545 mm - Transparent Glass - Symmetric Optic

Light Source: T16 / 35W / G5 / T 40°C / Electronic ballast

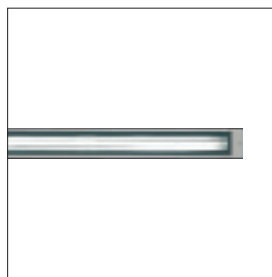

945413
945413-300 Dimmable Dali

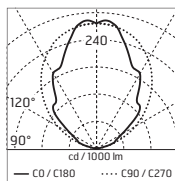

m	lux Max	lux Med
5.00	57	13
4.00	58	21
3.00	103	37
2.00	232	83
1.00	927	333

α = 39.0° + 39.0° β = 51.0° + 51.0°

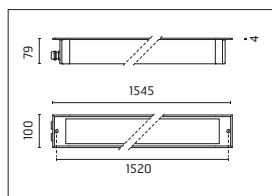

IP67

Cielo L 1545 mm - Sandblasted Glass - Symmetric Optic

Light Source: T16 / 35W / G5 / T 40°C / Electronic ballast



945457
945457-300 Dimmable Dali

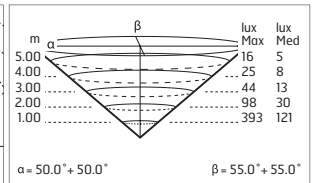
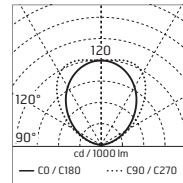
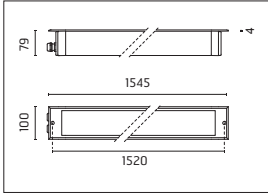

IP67

Cielo L 1545 mm - Transparent Glass - Asymmetric Optic

Light Source: T16 / 35W / G5 / T 40°C / Electronic ballast

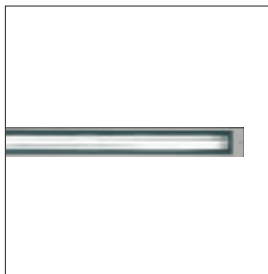

945414
945414-300 Dimmable Dali

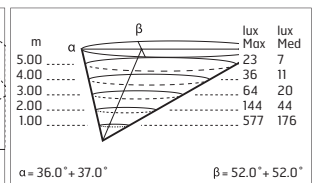
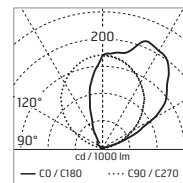
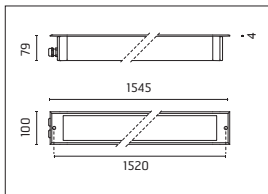

IP67





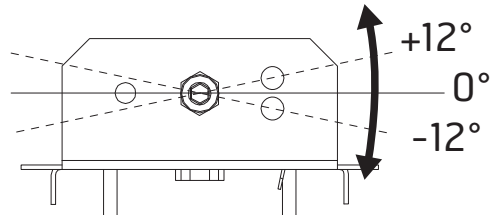
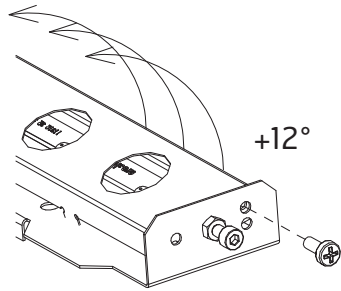
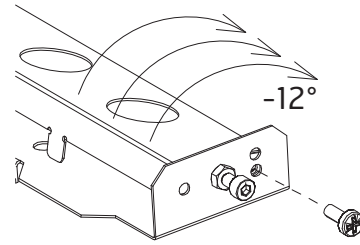
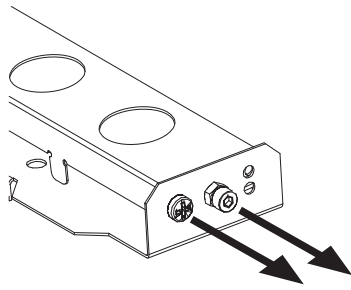

Symmetric Optic - Transparent Glass



Sandblasted Glass



Asymmetric Optic - Transparent Glass



Accessories: Cielo

71
BOX FOR INSTALLATION
825 ±2mm x 95 H 95mm

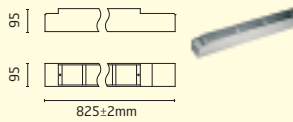

72
BOX FOR INSTALLATION
1425 ±2mm x 95 H 95mm

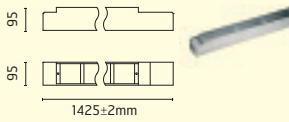

80
BOX FOR INSTALLATION
1725 ±2mm x 95 H 95mm

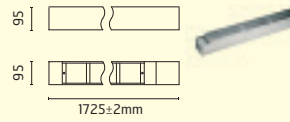

81
FRAME FOR RECESSED INSTALLATION
IN THE CEILING. 670 x 100 x H 8mm

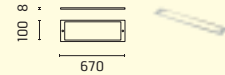

82
FRAME FOR RECESSED INSTALLATION
IN THE CEILING. 1270 x 100 x H 8mm

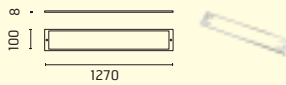

142
DMX CONTROLLER;
DIMMER SWITCH FOR RECESSED BOX
(60mm HOLE CENTRES)



143
DMX CONTROLLER;
STAND-ALONE/PC INTERFACE

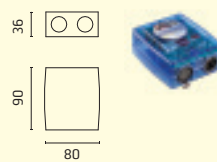

187
DMX SPLITTER 512 - ELECTRONIC DEVICE
TO REGENERATE THE MONODIRECTIONAL
DMX SIGNAL
1 INPUT AND 7 OUTPUT, 12-24V dc

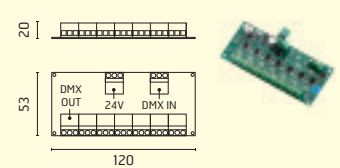

POWER SUPPLY TO BE ORDERED (87 OR 175 RECOMMENDED)

186
DMX CABLE - SHIELDED TWISTED PAIR
WITH 110 Ohm CONSTANT IMPEDANCE.



237
SPD: (SURGE PROTECTION DEVICE)
275Vac
MAXIMUM DISCHARGE CURRENT
10KA (8/20µs)
MAXIMUM OPERATING CURRENT 5A
SUITABLE FOR SERIES CONNECTION
- IP66

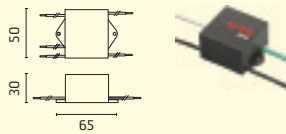

acc. code ▶	dimmm DALI	dimmm 1-10	71	72	80	81	82	142	143	187	186	237
944213	-300		•			•						
944214	-300		•			•						
944257	-300		•			•						
944813	-300			•			•					
944814	-300			•			•					
944857	-300			•			•					
945413	-300				•							
945414	-300				•							
945457	-300				•							
948012	-300	-310		•			•					•
948013	-300	-310		•			•					•
948312	-300	-310	•				•					•
948313	-300	-310	•				•					•
948512	-300	-310	•				•					•
948513	-300	-310	•				•					•
948612	-300	-310		•			•					•
948613	-300	-310		•			•					•
9418612	-300	-310	•				•					•
9418613	-300	-310	•				•					•
9418713.A			•				•	•	•	•	•	•
9418812	-300	-310		•			•					•
9418813	-300	-310		•			•					•
9418913.A				•			•	•	•	•	•	•
9480131	-300	-310		•			•					•
9483131	-300	-310	•				•					•
9485131	-300	-310	•				•					•
9486131	-300	-310		•			•					•
94186131	-300	-310	•				•					•
94188131	-300	-310		•			•					•











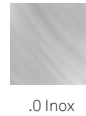



- Round luminaire for installation on wall, ceiling or ground – recessed.
- Configuration: turned aluminium body (EN AW-6060 alloy) with 15 micron anodizing for high resistance to corrosion. AISI 316L cap, open frame and cover. Diffuser: polycarbonate or methacrylate transparent or sandblasted (see the catalogue pages for reference).
- Double layer coating for high resistance to corrosion: the aluminium components are painted with a double coat using powders which are compliant with QUALICOAT standards: a first layer of epoxy powder (with excellent chemical and mechanical resistance) and a second finishing layer of polyester powder (resistant to UV rays and atmospheric agents). The entire painting process of the aluminium fitting starts from components which have been sandblasted in advance to make the surface more porous and increase the adherence of the paint. Ares effects alkaline and acid washing to clean the surfaces completely, then rinses with demineralised water to remove any residue particles, subsequently a chemical conversion treatment is done to protect against rusting.
- Protection rating: IP67
- In compliance with EN 60598-1 standards
- Class of insulation: III
- Installation: the luminaire is equipped with a piece of cable for an easy-to-make connection. In-ground version: the cable is integrated with an H2O STOP device. Rho is equipped with a dc/dc highly efficient resin-coated converter that removes electromagnetic interference and is protected against polarity reversal and sudden voltage peak. Outdoor use requires suitable flexible cables. Installation in solid surfaces requires a dedicated box for installation to be purchased separately, installation in panels is only possible with the version with springs. It is important to provide for the in-ground version a >200mm gravel layer or a drain system (for concrete surfaces) to ensure good drainage and to avoid water stagnation.
- Parallel wiring
- We recommend the use of a connection system with a protection degree greater than or equal to the protection degree of the luminaire.
- During the installation and the maintenance of the fixtures it is important to be careful and avoid damages on the paint coating. Damages on the coating exposed to outdoor conditions or water, could cause corrosion. Chemical substances affect the anticorrosion covering protection.

EU Regulation 874/2012 - Illumination equipment energy classes

A++
A+
A

LED VERSION:
Class A/A+/A++
Luminaire supplied with integrated LED modules that cannot be replaced



	Recessed ground fitting		Recessed wall fitting
	Do not install in hollow areas		Recessed ceiling fitting
	Installation requires a 20cm water drainage layer (gravel).		Pre-wired with approx 200mm of cable
	Protection against water ingress from the cable (only for in-ground recessed versions)		Remote device required.
	Static load: 500Kg walk over (version with frame) Static load: 2000Kg walk over (version with cover)		Glass surface temperature <70°C
	Protection against impact. IK 06 - 1,00 joule (version with frame) IK 08 - 5,00 joule (version with cover)		Glow wire test: 850°C

Rho - 316L Stainless Steel Frame - Version With Springs - 15°

Light Source: Power LED / 1,6W / Total power 2,3W / CRI>80 / 12÷24Vdc / Remote electronic power supply to be ordered



inox only

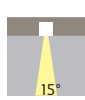

517115
White 2700K
lm LED 139 ≈ lm OUTPUT 94

517113
White 3000K
lm LED 149 ≈ lm OUTPUT 101

517112
White 4000K
lm LED 162 ≈ lm OUTPUT 110

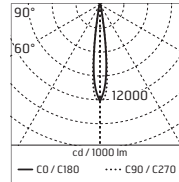

m	lux	
	Max	Med
1.00	1398	927
2.00	349	232
3.00	155	103
4.00	87	58
5.00	56	37

@ 4000K

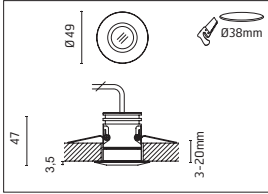

Dimmable on request

IP67

Rho - 316L Stainless Steel Frame - 15°

Light Source: Power LED / 1,6W / Total power 2,3W / CRI>80 / 12÷24Vdc / Remote electronic power supply to be ordered

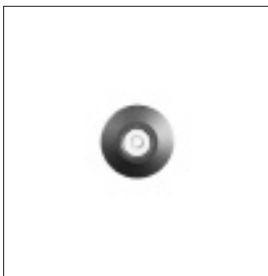

inox only



517005
White 2700K
lm LED 139 ≈ lm OUTPUT 94

517003
White 3000K
lm LED 149 ≈ lm OUTPUT 101

517002
White 4000K
lm LED 162 ≈ lm OUTPUT 110

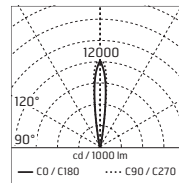

m	lux	
	Max	Med
5.00	56	37
4.00	87	58
3.00	155	103
2.00	349	232
1.00	1398	927

@ 4000K

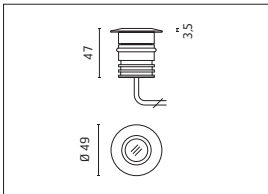

Dimmable on request

IP67

Rho - 316L Stainless Steel Frame - Version With Springs - 30°

Light Source: Power LED / 1,6W / Total power 2,3W / CRI>80 / 12÷24Vdc / Remote electronic power supply to be ordered



inox only



517125
White 2700K
lm LED 139 ≈ lm OUTPUT 94

517123
White 3000K
lm LED 149 ≈ lm OUTPUT 85

517122
White 4000K
lm LED 162 ≈ lm OUTPUT 93

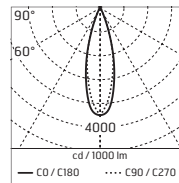

m	lux	
	Max	Med
1.00	349	208
2.00	87	52
3.00	39	23
4.00	22	13
5.00	14	8

@ 4000K

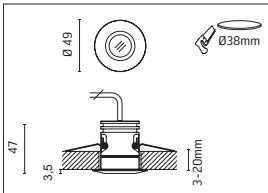

Dimmable on request

IP67

Rho - 316L Stainless Steel Frame - 30°

Light Source: Power LED / 1,6W / Total power 2,3W / CRI>80 / 12÷24Vdc / Remote electronic power supply to be ordered

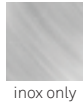
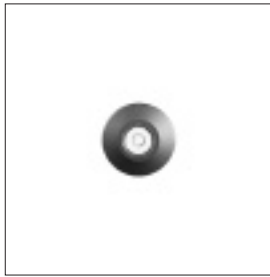

517016
White 2700K
lm LED 139 ≠ lm OUTPUT 79



517013
White 3000K
lm LED 149 ≠ lm OUTPUT 85



517012
White 4000K
lm LED 162 ≠ lm OUTPUT 93

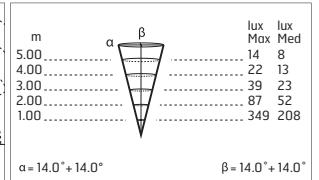
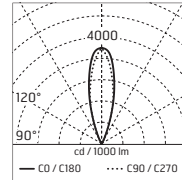
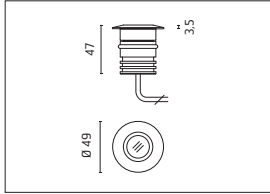

@ 4000K

Dimmable on request

IP67

Rho - 316L Stainless Steel Frame - Polycarbonate Opal Diffuser

Light Source: Power LED / 1,6W / Total power 2,3W / CRI>80 / 12÷24Vdc / Remote electronic power supply to be ordered

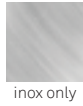
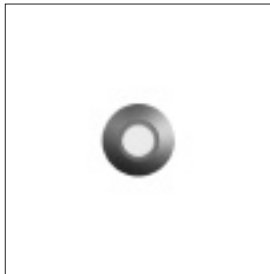

517017
White 2700K
lm LED 139 ≠ lm OUTPUT 16



517015
White 3000K
lm LED 149 ≠ lm OUTPUT 17



517014
White 4000K
lm LED 162 ≠ lm OUTPUT 18

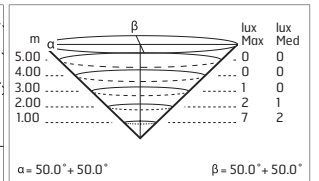
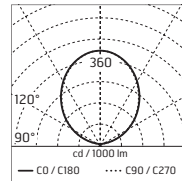
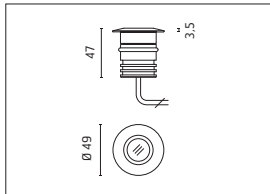

@ 4000K

Dimmable on request

IP67

Rho - 316L Stainless Steel Cover - One Emission

Light Source: Power LED / 1,6W / Total power 2,3W / CRI>80 / 12÷24Vdc / Remote electronic power supply to be ordered

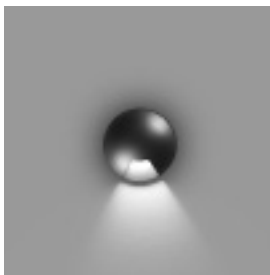

517025
White 2700K
lm LED 139 ≠ lm OUTPUT 10



517023
White 3000K
lm LED 149 ≠ lm OUTPUT 11



517022
White 4000K
lm LED 162 ≠ lm OUTPUT 12

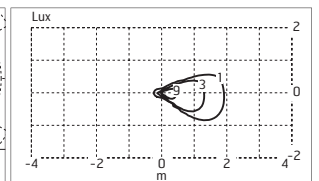
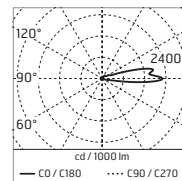
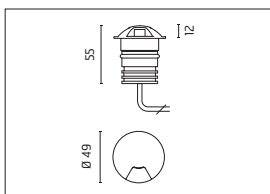

@ 4000K

Dimmable on request

IP67

Rho - 316L Stainless Steel Cover - Two Emissions

Light Source: Power LED / 1,6W / Total power 2,3W / CRI>80 / 12÷24Vdc / Remote electronic power supply to be ordered

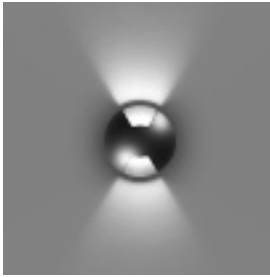

517035
White 2700K
lm LED 2x139 ≈ lm OUTPUT 2x10

517033
White 3000K
lm LED 149 ≈ lm OUTPUT 2x11

517032
White 4000K
lm LED 162 ≈ lm OUTPUT 2x12

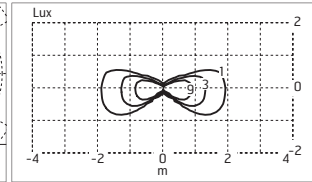
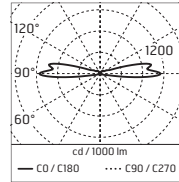

@ 4000K

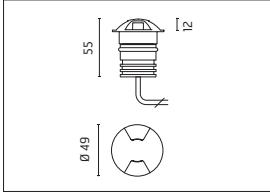

Dimmable on request

IP67

Rho - 316L Stainless Steel Cover - Three Emissions

Light Source: Power LED / 1,6W / Total power 2,3W / CRI>80 / 12÷24Vdc / Remote electronic power supply to be ordered

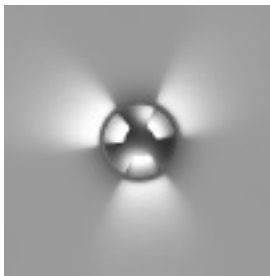

517045
White 2700K
lm LED 3x139 ≈ lm OUTPUT 3x10

517043
White 3000K
lm LED 149 ≈ lm OUTPUT 3x11

517042
White 4000K
lm LED 162 ≈ lm OUTPUT 3x12

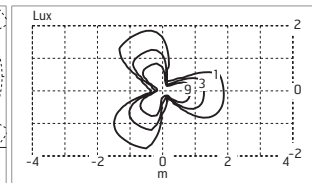
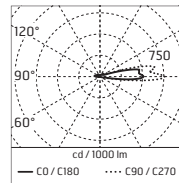

@ 4000K

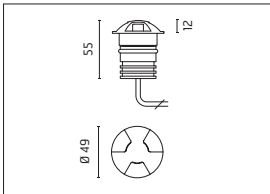

Dimmable on request

IP67

Rho - 316L Stainless Steel Cover - Omnidirectional

Light Source: Power LED / 1,6W / Total power 2,3W / CRI>80 / 12÷24Vdc / Remote electronic power supply to be ordered

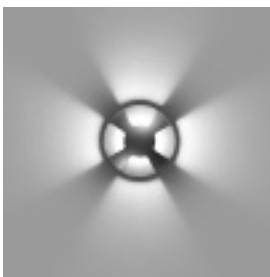

517055
White 2700K
lm LED 4x139 ≈ lm OUTPUT 4x10

517053
White 3000K
lm LED 149 ≈ lm OUTPUT 4x11

517052
White 4000K
lm LED 162 ≈ lm OUTPUT 4x12

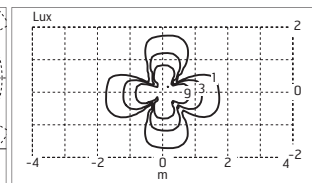
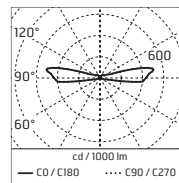

@ 4000K

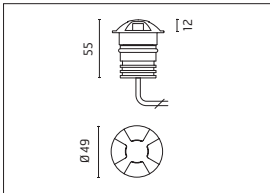

Dimmable on request

IP67

Rho - 316L Stainless Steel Cover - 180°

Light Source: Power LED / 1,6W / Total power 2,3W / CRI>80 / 12÷24Vdc / Remote electronic power supply to be ordered

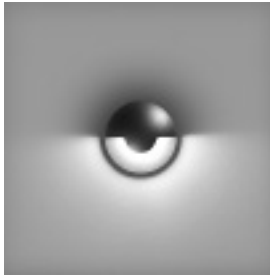

517065
White 2700K
lm LED 139 ≠ lm OUTPUT 36

517063
White 3000K
lm LED 149 ≠ lm OUTPUT 39

517062
White 4000K
lm LED 162 ≠ lm OUTPUT 42

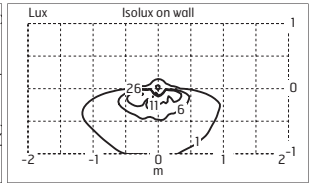
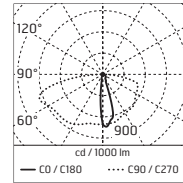
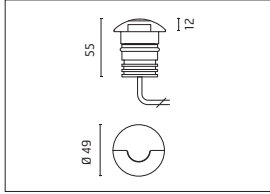

@ 4000K

Dimmable on request



Rho - Round Methacrylate Diffuser - Version With Springs

Light Source: Power LED / 1,6W / Total power 2,3W / CRI>80 / 12÷24Vdc / Remote electronic power supply to be ordered

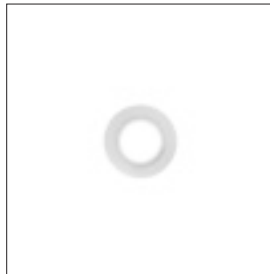

517135
White 2700K
lm LED 139 ≠ lm OUTPUT 11

517133
White 3000K
lm LED 149 ≠ lm OUTPUT 12

517132
White 4000K
lm LED 162 ≠ lm OUTPUT 13

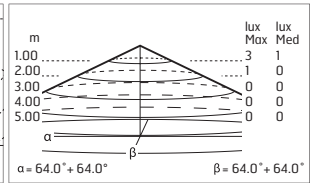
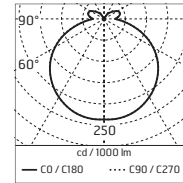
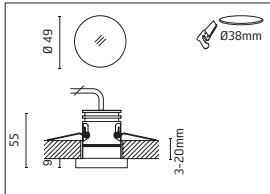

@ 4000K

Dimmable on request



Rho - Round Methacrylate Diffuser

Light Source: Power LED / 1,6W / Total power 2,3W / CRI>80 / 12÷24Vdc / Remote electronic power supply to be ordered

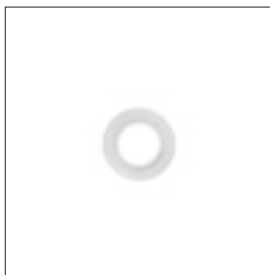

517075
White 2700K
lm LED 139 ≠ lm OUTPUT 11

517073
White 3000K
lm LED 149 ≠ lm OUTPUT 12

517072
White 4000K
lm LED 162 ≠ lm OUTPUT 13

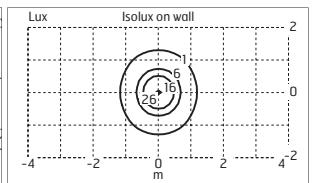
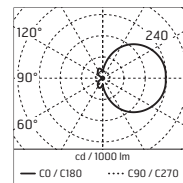
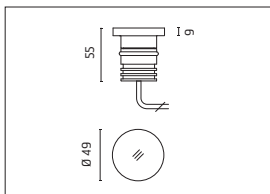

@ 4000K

Dimmable on request



Rho Square Methacrylate Diffuser - Version With Springs

Light Source: Power LED / 1,6W / Total power 2,3W / CRI>80/12÷24Vdc / Remote electronic power supply to be ordered



517145
White 2700K
lm LED 139 ≈ lm OUTPUT 11

517143
White 3000K
lm LED 149 ≈ lm OUTPUT 12

517142
White 4000K
lm LED 162 ≈ lm OUTPUT 13

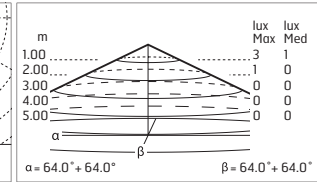
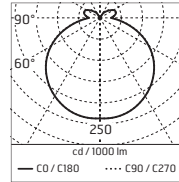

@ 4000K

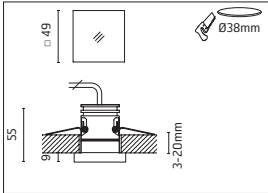

Dimmable on request

IP67

Rho Square Methacrylate Diffuser

Light Source: Power LED / 1,6W / Total power 2,3W / CRI>80/12÷24Vdc / Remote electronic power supply to be ordered



517085
White 2700K
lm LED 139 ≈ lm OUTPUT 11

517083
White 3000K
lm LED 149 ≈ lm OUTPUT 12

517082
White 4000K
lm LED 162 ≈ lm OUTPUT 13

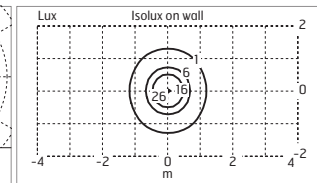
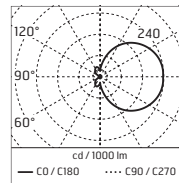

@ 4000K

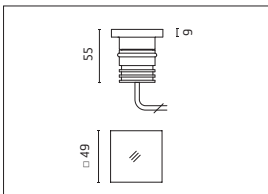

Dimmable on request

IP67

Accessories: Rho

169
BOX FOR INSTALLATION
Ø 105 H 78mm

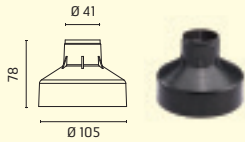

FOR IN-GROUND INSTALLATION
OR CONCRETE WALL

150
POWER SUPPLY DUAL FUNCTION
Vout 24Vdc: 8W/100÷240V
Iout 350mA: 6x1W/100÷240V
IP20 CLASS II SELV EQ.

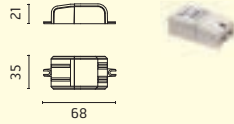

106
POWER SUPPLY DUAL FUNCTION
Vout 24Vdc: 8W/100÷240V
Iout 350mA: 6x1W/100÷240V
IP65 CLASS II SELV EQ.

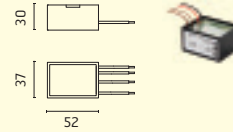

87
POWER SUPPLY 10W/110÷240V -
24Vdc IP20 CLASS II SELV.

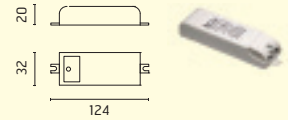

175
POWER SUPPLY 10W/110÷240V -
24Vdc IP67 CLASS II SELV.

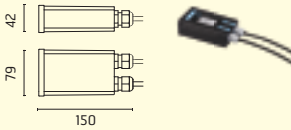

147
POWER SUPPLY 20W/220÷240V -
24Vdc IP67 CLASS II SELV.

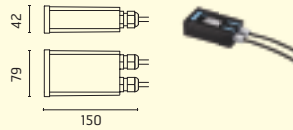

155
POWER SUPPLY 50W/120÷240V -
24Vdc IP67 CLASS II SELV.

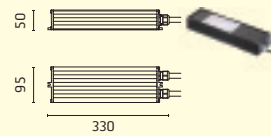

110
POWER SUPPLY 70W/220÷240V -
24Vdc IP67 CLASS II SELV EQ.

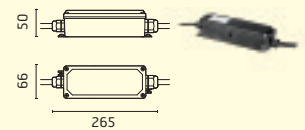

269
2 WAY TERMINAL BLOCK 2 POLES IP68
(Ø4÷6,9mm Cable)
*it can't be placed in the recessed box
for installation



acc. code ▶ prod. code ▼	169	150	106	87	175	147	155	110	269
517002	•	1	1	4	4	5	14	29	•
517003	•	1	1	4	4	5	14	29	•
517005	•	1	1	4	4	5	14	29	•
517012	•	1	1	4	4	5	14	29	•
517013	•	1	1	4	4	5	14	29	•
517014	•	1	1	4	4	5	14	29	•
517015	•	1	1	4	4	5	14	29	•
517016	•	1	1	4	4	5	14	29	•
517017	•	1	1	4	4	5	14	29	•
517022	•	1	1	4	4	5	14	29	•
517023	•	1	1	4	4	5	14	29	•
517025	•	1	1	4	4	5	14	29	•
517032	•	1	1	4	4	5	14	29	•
517033	•	1	1	4	4	5	14	29	•
517035	•	1	1	4	4	5	14	29	•
517042	•	1	1	4	4	5	14	29	•
517043	•	1	1	4	4	5	14	29	•
517045	•	1	1	4	4	5	14	29	•
517052	•	1	1	4	4	5	14	29	•
517053	•	1	1	4	4	5	14	29	•
517055	•	1	1	4	4	5	14	29	•
517062	•	1	1	4	4	5	14	29	•
517063	•	1	1	4	4	5	14	29	•

acc. code ▶ prod. code ▼	169	150	106	87	175	147	155	110	269
517065	•	1	1	4	4	5	14	29	•
517072	•	1	1	4	4	5	14	29	•
517073	•	1	1	4	4	5	14	29	•
517075	•	1	1	4	4	5	14	29	•
517082	•	1	1	4	4	5	14	29	•
517083	•	1	1	4	4	5	14	29	•
517085	•	1	1	4	4	5	14	29	•
517092	•	1	1	4	4	5	14	29	•
517093	•	1	1	4	4	5	14	29	•
517102	•	1	1	4	4	5	14	29	•
517103	•	1	1	4	4	5	14	29	•
517112		1	1	4	4	5	14	29	•
517113		1	1	4	4	5	14	29	•
517115		1	1	4	4	5	14	29	•
517122		1	1	4	4	5	14	29	•
517123		1	1	4	4	5	14	29	•
517125		1	1	4	4	5	14	29	•
517132		1	1	4	4	5	14	29	•
517133		1	1	4	4	5	14	29	•
517135		1	1	4	4	5	14	29	•
517142		1	1	4	4	5	14	29	•
517143		1	1	4	4	5	14	29	•
517145		1	1	4	4	5	14	29	•

Max fixtures for each power supply (Vin 220÷240). Data in the chart are provided as a guide only. Please verify according to your installation.

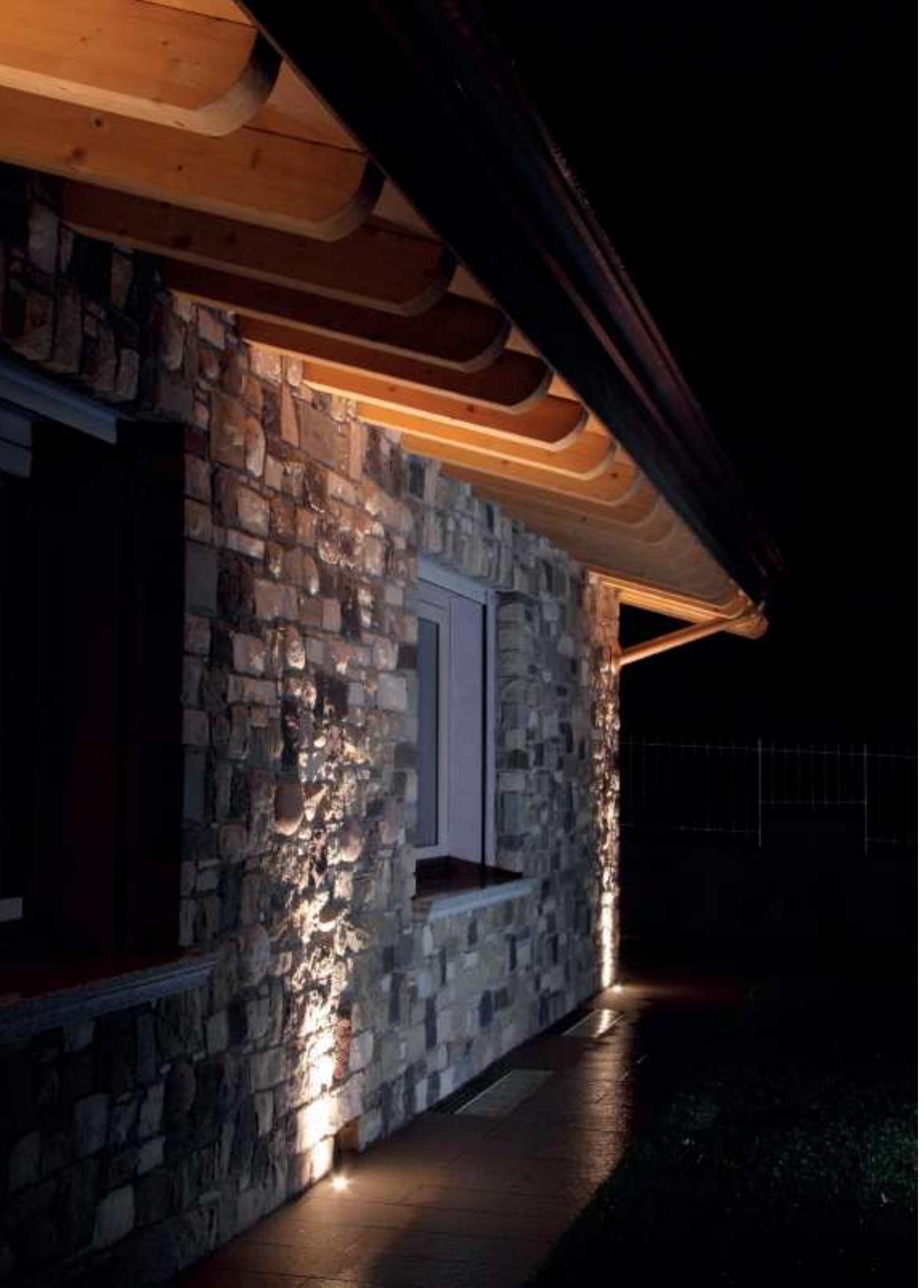

- Round luminaire for installation on wall, ceiling or ground – recessed.
- Configuration: turned aluminium body (EN AW-6060 alloy) with 15 micron anodizing for high resistance to corrosion. AISI 316L cap, open frame and cover. Diffuser: polycarbonate or methacrylate transparent or sandblasted (see the catalogue pages for reference).
- Double layer coating for high resistance to corrosion: the aluminium components are painted with a double coat using powders which are compliant with QUALICOAT standards: a first layer of epoxy powder (with excellent chemical and mechanical resistance) and a second finishing layer of polyester powder (resistant to UV rays and atmospheric agents). The entire painting process of the aluminium fitting starts from components which have been sandblasted in advance to make the surface more porous and increase the adherence of the paint. Ares effects alkaline and acid washing to clean the surfaces completely, then rinses with demineralised water to remove any residue particles, subsequently a chemical conversion treatment is done to protect against rusting.
- Protection rating: IP67
- In compliance with EN 60598-1 standards
- Class of insulation: III
- Installation: the luminaire is equipped with a piece of cable for an easy-to-make connection. In-ground version: the cable is integrated with an H2O STOP device. Sigma is equipped with a dc/dc highly efficient resin-coated converter that removes electromagnetic interference and is protected against polarity reversal and sudden voltage peak. Outdoor use requires suitable flexible cables. Installation in solid surfaces requires a dedicated box for installation to be purchased separately, installation in panels is only possible with the version with springs. It is important to provide for the in-ground version a >200mm gravel layer or a drain system (for concrete surfaces) to ensure good drainage and to avoid water stagnation.
- Parallel wiring
- We recommend the use of a connection system with a protection degree greater than or equal to the protection degree of the luminaire.
- During the installation and the maintenance of the fixtures it is important to be careful and avoid damages on the paint coating. Damages on the coating exposed to outdoor conditions or water, could cause corrosion. Chemical substances affect the anticorrosion covering protection.

EU Regulation 874/2012 - Illumination equipment energy classes



LED VERSION:
Class A/A+/A++
Luminaire supplied with integrated LED modules that cannot be replaced



.0 Inox



Recessed ground fitting



Recessed wall fitting



Do not install in hollow areas



Recessed ceiling fitting



Installation requires a 20cm water drainage layer (gravel).



Pre-wired with approx 200mm of cable



Protection against water ingress from the cable (only for in-ground recessed versions)



Remote device required.



Static load: 500Kg walk over (version with frame)
Static load: 2000Kg walk over (version with cover)



Glass surface temperature <70°C



Protection against impact.
IK 06 - 1,00 joule (version with frame)
IK 08 - 5,00 joule (version with cover)



Glow wire test: 850°C

Sigma - 316L Stainless Steel Frame - Version With Springs - 10°

Light Source: Power LED / 2,2W / Total power 3,4W / CRI>80 / 24Vdc / Remote electronic power supply to be ordered



518205
White 2700K
lm LED 169 ≠ lm OUTPUT 118

518006
White 3000K
lm LED 182 ≠ lm OUTPUT 127

518005
White 4000K
m LED 198 ≠ lm OUTPUT 138

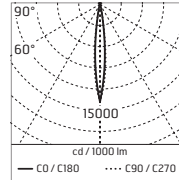

m	lux	
	Max	Med
1.00	1989	1220
2.00	497	305
3.00	221	136
4.00	124	76
5.00	80	49

@ 4000K

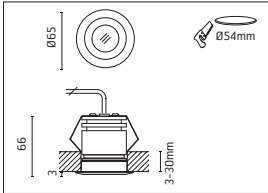

Dimmable on request



Sigma - 316L Stainless Steel Frame - 10°

Light Source: Power LED / 2,2W / Total power 3,4W / CRI>80 / 24Vdc / Remote electronic power supply to be ordered



518202
White 2700K
lm LED 169 ≠ lm OUTPUT 118

518003
White 3000K
lm LED 182 ≠ lm OUTPUT 127

518002
White 4000K
lm LED 198 ≠ lm OUTPUT 138

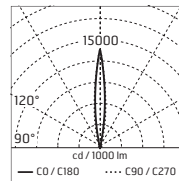

m	lux	
	Max	Med
5.00	80	49
4.00	124	76
3.00	221	136
2.00	497	305
1.00	1989	1220

@ 4000K

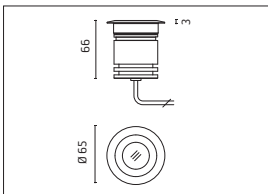

Dimmable on request



Sigma - 316L Stainless Steel Frame - Version With Springs - 30°

Light Source: Power LED / 2,2W / Total power 3,4W / CRI>80 / 24Vdc / Remote electronic power supply to be ordered



518208
White 2700K
lm LED 169 ≠ lm OUTPUT 106

518009
White 3000K
lm LED 182 ≠ lm OUTPUT 114

518008
White 4000K
lm LED 198 ≠ lm OUTPUT 125

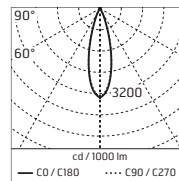

m	lux	
	Max	Med
1.00	437	265
2.00	109	66
3.00	49	29
4.00	27	17
5.00	17	11

@ 4000K

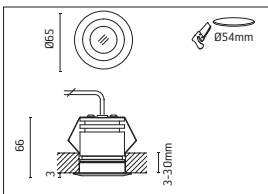

Dimmable on request



Sigma - 316L Stainless Steel Frame - 30°

Light Source: Power LED / 2,2W / Total power 3,4W / CRI>80 / 24Vdc / Remote electronic power supply to be ordered

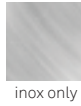

518212
White 2700K
lm LED 169 ≠ lm OUTPUT 106



518013
White 3000K
lm LED 182 ≠ lm OUTPUT 114



518012
White 4000K
lm LED 198 ≠ lm OUTPUT 125

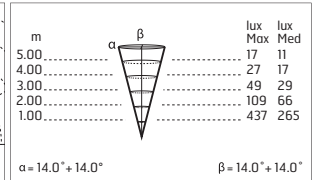
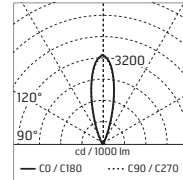
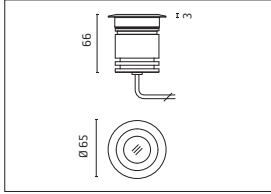

@ 4000K

Dimmable on request

IP67

Sigma - 316L Stainless Steel Frame - Polycarbonate Opal Diffuser

Light Source: Power LED / 2,2W / Total power 3,4W / CRI>80 / 24Vdc / Remote electronic power supply to be ordered

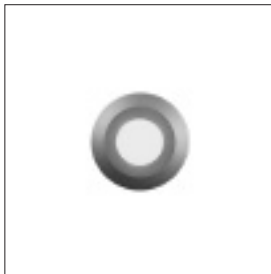

518234
White 2700K
lm LED 169 ≠ lm OUTPUT 20



518035
White 3000K
lm LED 182 ≠ lm OUTPUT 22



518034
White 4000K
lm LED 198 ≠ lm OUTPUT 24

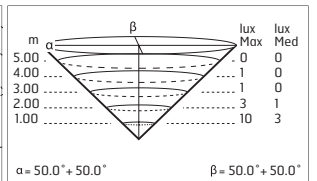
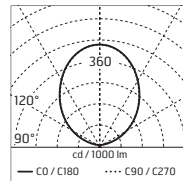
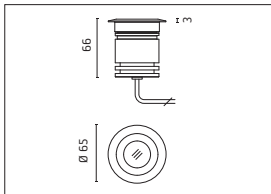

@ 4000K

Dimmable on request

IP67

Sigma - 316L Stainless Steel Frame - Version With Springs - 10°

Light Source: Power LED / 3,3W / Total power 4,5W / CRI>80 / 24Vdc / Remote electronic power supply to be ordered



518215
White 2700K
lm LED 307 ≠ lm OUTPUT 219



518016
White 3000K
lm LED 330 ≠ lm OUTPUT 236



518015
White 4000K
lm LED 360 ≠ lm OUTPUT 258

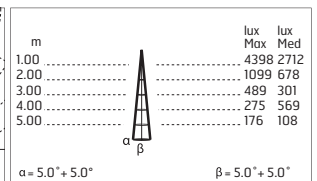
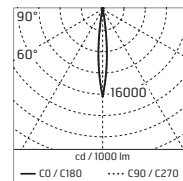
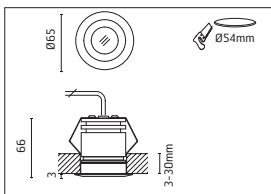

@ 4000K

Dimmable on request

IP67

Sigma - 316L Stainless Steel Frame - 10°

Light Source: Power LED / 3,3W / Total power 4,5W / CRI>80 / 24Vdc / Remote electronic power supply to be ordered

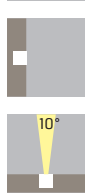

518222
White 2700K
lm LED 307 ≈ lm OUTPUT 219

518023
White 3000K
lm LED 330 ≈ lm OUTPUT 236

518022
White 4000K
lm LED 360 ≈ lm OUTPUT 258

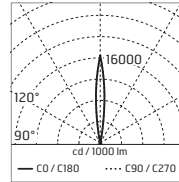

m	lux	
	Max	Med
5.00	176	108
4.00	275	169
3.00	489	301
2.00	1099	678
1.00	4398	2712

α = 5.0° + 5.0° β = 5.0° + 5.0°

@ 4000K

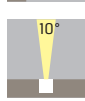
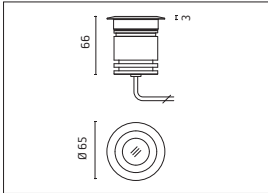

Dimmable on request

IP67

Sigma - 316L Stainless Steel Frame - Version With Springs - 30°

Light Source: Power LED / 3,3W / Total power 4,5W / CRI>80 / 24Vdc / Remote electronic power supply to be ordered

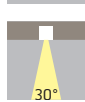
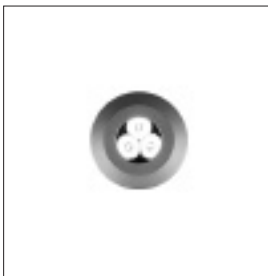

518225
White 2700K
lm LED 307 ≈ lm OUTPUT 176

518026
White 3000K
lm LED 330 ≈ lm OUTPUT 189

518025
White 4000K
lm LED 360 ≈ lm OUTPUT 207

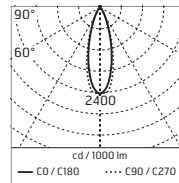

m	lux	
	Max	Med
1.00	527	319
2.00	132	80
3.00	59	35
4.00	33	20
5.00	21	13

α = 15.0° + 15.0° β = 15.0° + 15.0°

@ 4000K

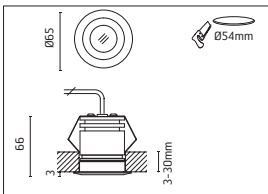

Dimmable on request

IP67

Sigma - 316L Stainless Steel Frame - 30°

Light Source: Power LED / 3,3W / Total power 4,5W / CRI>80 / 24Vdc / Remote electronic power supply to be ordered



518232
White 2700K
lm LED 307 ≈ lm OUTPUT 176

518033
White 3000K
lm LED 330 ≈ lm OUTPUT 189

518032
White 4000K
lm LED 360 ≈ lm OUTPUT 207

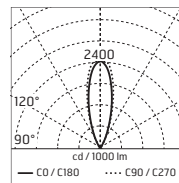

m	lux	
	Max	Med
5.00	21	13
4.00	33	20
3.00	59	35
2.00	132	80
1.00	527	319

α = 15.0° + 15.0° β = 15.0° + 15.0°

@ 4000K

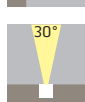
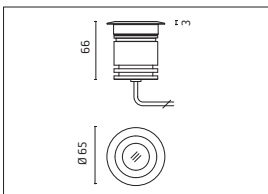

Dimmable on request

IP67

Sigma - 316L Stainless Steel Cover - One Emission

Light Source: Power LED / 2,2W / Total power 3,4W / CRI>80 / 24Vdc / Remote electronic power supply to be ordered

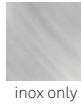
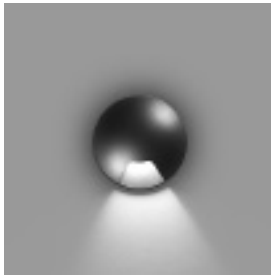

518242
White 2700K
lm LED 169 ≈ lm OUTPUT 15

518043
White 3000K
lm LED 182 ≈ lm OUTPUT 16

518042
White 4000K
lm LED 198 ≈ lm OUTPUT 18

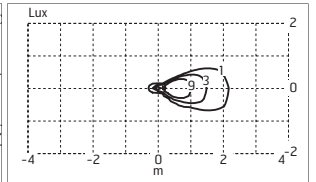
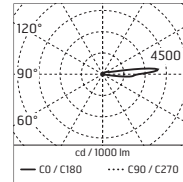
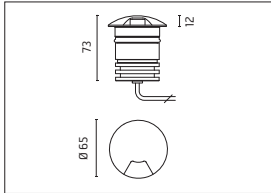

@ 4000K

Dimmable on request

IP67

Sigma - 316L Stainless Steel Cover - Two Emissions

Light Source: Power LED / 2,2W / Total power 3,4W / CRI>80 / 24Vdc / Remote electronic power supply to be ordered

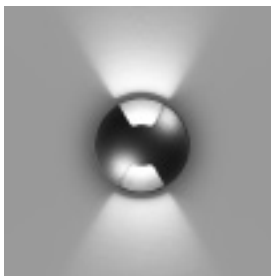

518252
White 2700K
lm LED 2x169 ≈ lm OUTPUT 2x15

518053
White 3000K
lm LED 182 ≈ lm OUTPUT 2x16

518052
White 4000K
lm LED 198 ≈ lm OUTPUT 2x18

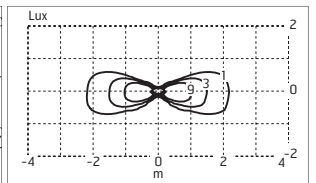
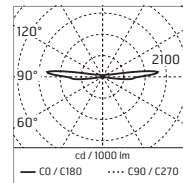
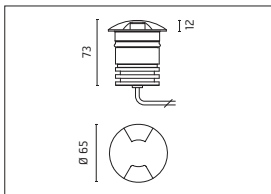

@ 4000K

Dimmable on request

IP67

Sigma - 316L Stainless Steel Cover - Three Emissions

Light Source: Power LED / 2,2W / Total power 3,4W / CRI>80 / 24Vdc / Remote electronic power supply to be ordered

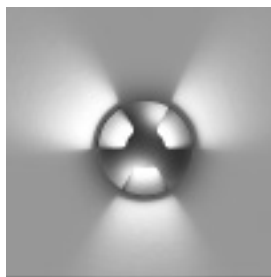

518262
White 2700K
lm LED 3x169 ≈ lm OUTPUT 3x15

518063
White 3000K
lm LED 182 ≈ lm OUTPUT 3x16

518062
White 4000K
lm LED 198 ≈ lm OUTPUT 3x18

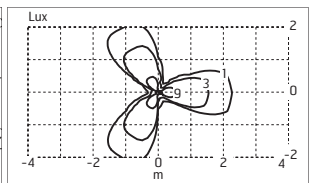
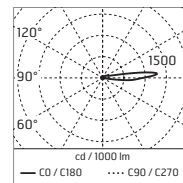
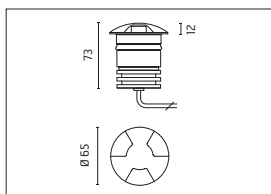

@ 4000K

Dimmable on request

IP67

Sigma - 316L Stainless Steel Cover - Omnidirectional

Light Source: Power LED / 2,2W / Total power 3,4W / CRI>80 / 24Vdc / Remote electronic power supply to be ordered

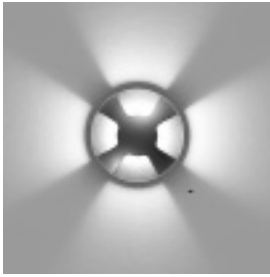

- 518272**
White 2700K
lm LED 4x169 = lm OUTPUT 4x15
- 518073**
White 3000K
lm LED 182 = lm OUTPUT 4x16
- 518072**
White 4000K
lm LED 198 = lm OUTPUT 4x18

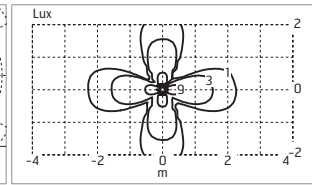
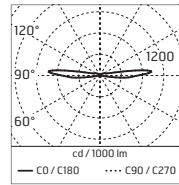

@ 4000K

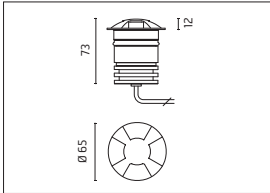

Dimmable on request



Sigma - 316L Stainless Steel Cover - 180°

Light Source: Power LED / 2,2W / Total power 3,4W / CRI>80 / 24Vdc / Remote electronic power supply to be ordered

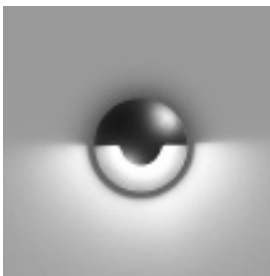

- 518282**
White 2700K
lm LED 169 = lm OUTPUT 47
- 518083**
White 3000K
lm LED 182 = lm OUTPUT 50
- 518082**
White 4000K
lm LED 198 = lm OUTPUT 54

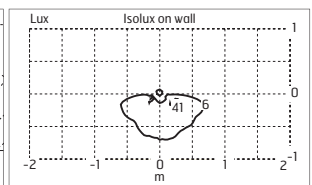
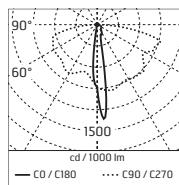

@ 4000K

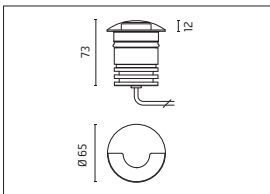

Dimmable on request



Sigma - Version With Springs - Round Methacrylate Diffuser

Light Source: Power LED / 3,3W / Total power 4,5W / CRI>80 / 24Vdc / Remote electronic power supply to be ordered



- 518285**
White 2700K
lm LED 307 = lm OUTPUT 51
- 518086**
White 3000K
lm LED 330 = lm OUTPUT 55
- 518085**
White 4000K
lm LED 360 = lm OUTPUT 60

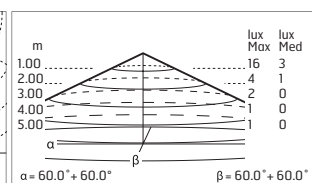
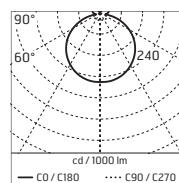

@ 4000K

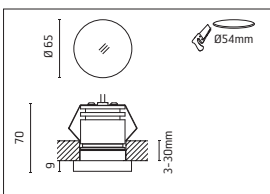

Dimmable on request



Sigma - Round Methacrylate Diffuser

Light Source: Power LED / 3,3W / Total power 4,5W / CRI>80 / 24Vdc / Remote electronic power supply to be ordered

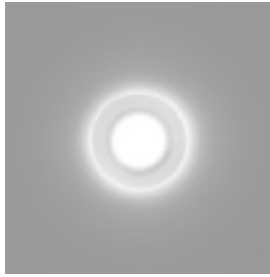

518292
White 2700K
lm LED 307 ≈ lm OUTPUT 51

518093
White 3000K
lm LED 330 ≈ lm OUTPUT 55

518092
White 4000K
lm LED 360 ≈ lm OUTPUT 60

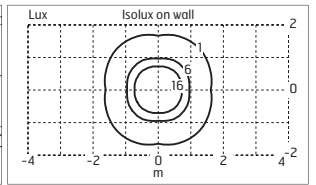
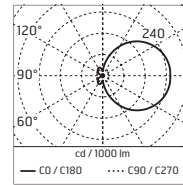

@ 4000K

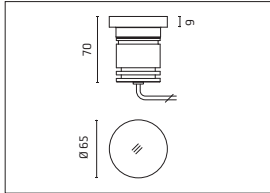

Dimmable on request

IP67

Sigma - Version With Springs - Round Methacrylate Diffuser

Light Source: Power LED / 3,3W / Total power 4,5W / CRI>80 / 24Vdc / Remote electronic power supply to be ordered

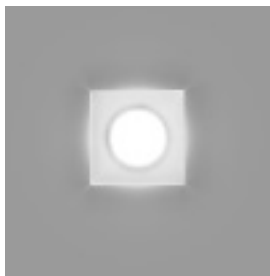

518295
White 2700K
lm LED 307 ≈ lm OUTPUT 51

518096
White 3000K
lm LED 330 ≈ lm OUTPUT 55

518095
White 4000K
lm LED 360 ≈ lm OUTPUT 60

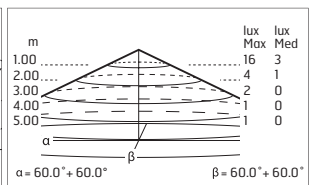
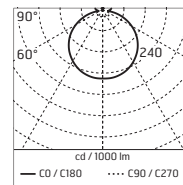

@ 4000K

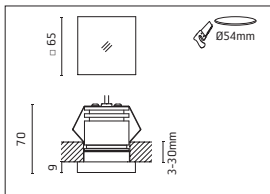

Dimmable on request

IP67

Sigma - Square Methacrylate Diffuser

Light Source: Power LED / 3,3W / Total power 4,5W / CRI>80 / 24Vdc / Remote electronic power supply to be ordered



518302
White 2700K
lm LED 307 ≈ lm OUTPUT 51

518103
White 3000K
lm LED 330 ≈ lm OUTPUT 55

518102
White 4000K
lm LED 360 ≈ lm OUTPUT 60

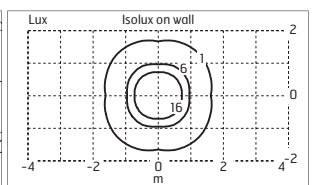
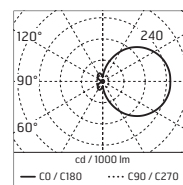

@ 4000K

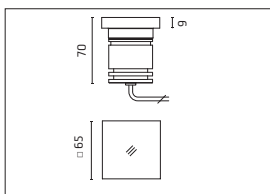

Dimmable on request

IP67



Accessories: Sigma

170
BOX FOR INSTALLATION
Ø 105 H 78mm

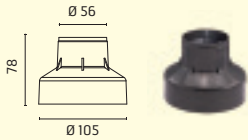

FOR IN-GROUND INSTALLATION
OR CONCRETE WALL

150
POWER SUPPLY DUAL FUNCTION
Vout 24Vdc: 8W/100÷240V
Iout 350mA: 6x1W/100÷240V
IP20 CLASS II SELV EQ.

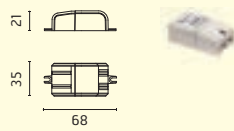

106
POWER SUPPLY DUAL FUNCTION
Vout 24Vdc: 8W/100÷240V
Iout 350mA: 6x1W/100÷240V
IP65 CLASS II SELV EQ.

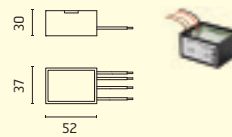

87
POWER SUPPLY 10W/110÷240V -
24Vdc IP20 CLASS II SELV.

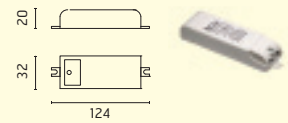

175
POWER SUPPLY 10W/110÷240V -
24Vdc IP67 CLASS II SELV.

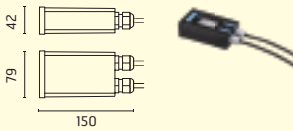

147
POWER SUPPLY 20W/220÷240V -
24Vdc IP67 CLASS II SELV.

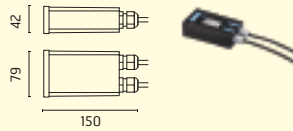

155
POWER SUPPLY 50W/120÷240V -
24Vdc IP67 CLASS II SELV.

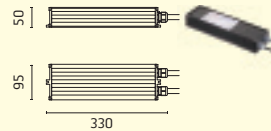

110
POWER SUPPLY 70W/220÷240V -
24Vdc IP67 CLASS II SELV EQ.

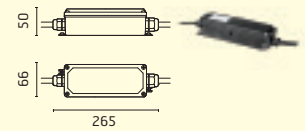

269
2 WAY TERMINAL BLOCK 2 POLES IP68
(Ø4÷6,9mm Cable)
*it can't be placed in the recessed box
for installation



acc. code ▶ prod. code ▼	170	150	106	87	175	147	155	110	269
518002	•	1	1	2	2	3	9	17	•
518003	•	1	1	2	2	3	9	17	•
518005		1	1	2	2	3	9	17	•
518006		1	1	2	2	3	9	17	•
518008		1	1	2	2	3	9	17	•
518009		1	1	2	2	3	9	17	•
518012	•	1	1	2	2	3	9	17	•
518013	•	1	1	2	2	3	9	17	•
518015		1	1	2	2		7	14	•
518016		1	1	2	2		7	14	•
518022	•	1	1	2	2		7	14	•
518023	•	1	1	2	2		7	14	•
518025		1	1	2	2		7	14	•
518026		1	1	2	2		7	14	•
518032	•	1	1	2	2		7	14	•
518033	•	1	1	2	2		7	14	•
518034	•	1	1	2	2	3	9	17	•
518035	•	1	1	2	2	3	9	17	•
518042	•	1	1	2	2	3	9	17	•
518043	•	1	1	2	2	3	9	17	•
518052	•	1	1	2	2	3	9	17	•
518053	•	1	1	2	2	3	9	17	•
518062	•	1	1	2	2	3	9	17	•
518063	•	1	1	2	2	3	9	17	•
518072	•	1	1	2	2	3	9	17	•
518073	•	1	1	2	2	3	9	17	•
518082	•	1	1	2	2	3	9	17	•
518083	•	1	1	2	2	3	9	17	•
518085		1	1	2	2		7	14	•

acc. code ▶ prod. code ▼	170	150	106	87	175	147	155	110	269
518086		1	1	2	2		7	14	•
518092	•	1	1	2	2		7	14	•
518093	•	1	1	2	2		7	14	•
518095		1	1	2	2		7	14	•
518096		1	1	2	2		7	14	•
518102	•	1	1	2	2		7	14	•
518103	•	1	1	2	2		7	14	•
518112	•	1	1	2	2	3	9	17	•
518113	•	1	1	2	2	3	9	17	•
518122	•	1	1	2	2	3	9	17	•
518123	•	1	1	2	2	3	9	17	•
518202	•	1	1	2	2	3	9	17	•
518205		1	1	2	2	3	9	17	•
518208		1	1	2	2	3	9	17	•
518212	•	1	1	2	2	3	9	17	•
518215		1	1	2	2		7	14	•
518222	•	1	1	2	2		7	14	•
518225		1	1	2	2		7	14	•
518232	•	1	1	2	2		7	14	•
518234	•	1	1	2	2	3	9	17	•
518242	•	1	1	2	2	3	9	17	•
518252	•	1	1	2	2	3	9	17	•
518262	•	1	1	2	2	3	9	17	•
518272	•	1	1	2	2	3	9	17	•
518282	•	1	1	2	2	3	9	17	•
518285		1	1	2	2		7	14	•
518292	•	1	1	2	2		7	14	•
518295		1	1	2	2		7	14	•
518302	•	1	1	2	2		7	14	•

Max fixtures for each power supply (Vin 220÷240). Data in the chart are provided as a guide only. Please verify according to your installation.













- Square luminaire for installation in-ground – recessed flush with the mounting surface.
- Configuration: die cast aluminium structure, EN AB-47100 alloy (low copper content) and AISI 316L stainless steel frame. Glass diffuser: transparent or sandblasted.
- Double layer coating for high resistance to corrosion: the aluminium components are painted with a double coat using powders which are compliant with QUALICOAT standards: a first layer of epoxy powder (with excellent chemical and mechanical resistance) and a second finishing layer of polyester powder (resistant to UV rays and atmospheric agents). The entire painting process of the aluminium fitting starts from components which have been sandblasted in advance to make the surface more porous and increase the adherence of the paint. Ares effects alkaline and acid washing to clean the surfaces completely, then rinses with demineralised water to remove any residue particles, subsequently a chemical conversion treatment is done to protect against rusting.
- Protection rating: IP67
- In compliance with EN 60598-1 standards
- Class of insulation: mains: I; low-voltage: III
- Installation: the luminaire is equipped with a piece of cable with a 2-way connector for 3-conductor cables (H₂O STOP) for an easy-to-make connection. Outdoor use requires suitable flexible cables. Installation requires a dedicated box to be ordered separately. It is important to provide a >300mm gravel layer or a drain system (for concrete surface) to ensure good drainage and to avoid water stagnation.
- We recommend the use of a connection system with a protection degree greater than or equal to the protection degree of the luminaire.
- During the installation and the maintenance of the fixtures it is important to be careful and avoid damages on the paint coating. Damages on the coating exposed to outdoor conditions or water, could cause corrosion. Chemical substances affect the anticorrosion covering protection.

EU Regulation 874/2012 - Illumination equipment energy classes

- A** **LED BULB VERSION:**
Class A
DRR/GU5,3
DR-PAR/GZ10
- B** **HALOGEN VERSION:**
Class B
QR-CBC51/GU5,3
- D** **HALOGEN VERSION:**
Class D
QRPARCBC51/GZ10



	Recessed ground fitting		Installation requires a 30cm water drainage layer (gravel)
	Do not install in hollow areas		Pre-wired with approx 250mm of cable
	Protection against water ingress from the cable H₂O STOP		Remote device required
	Static load: 2000Kg walk over		Drive over 50Nm 5kN
	Check that diffuser's temperature "T max °C" (tested at 25°C) complies with your local regulation		Protection against impact. IK 09 - 10,00 joule

Bea - Stainless Steel Frame - Transparent Glass - Adjustable Optic

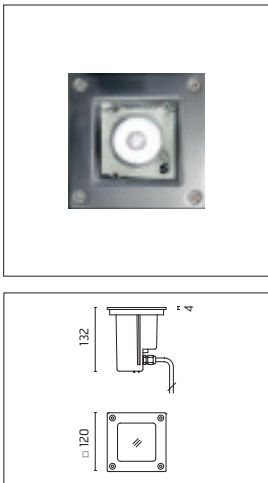

652815
QPAR CBC 51 50W/230V GZ10
T 180°C
Optional LED bulb
DR PAR 7,5W/230V GZ10
Lamp max size: Ø50 mm H.58 mm



653315
QR CBC 51 50W/12V GU5,3
T 180°C
Optional LED bulb
DRR 6,5W/12V a.c. GU5,3
Lamp max size: Ø50 mm H.48 mm

Remote transformer to be ordered

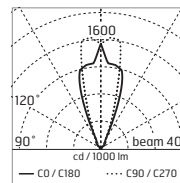

m	α	β	lux	lux
			Max	Med
5.00			49	29
4.00			77	45
3.00			136	80
2.00			307	180
1.00			1228	718

α = 16.0° + 16.0° β = 20.0° + 20.0°

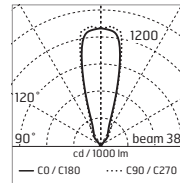

m	α	β	lux	lux
			Max	Med
5.00			40	27
4.00			62	42
3.00			110	74
2.00			248	166
1.00			993	665

α = 16.0° + 16.0° β = 16.0° + 16.0°

IP67

Bea - Stainless Steel Frame - Sandblasted Glass

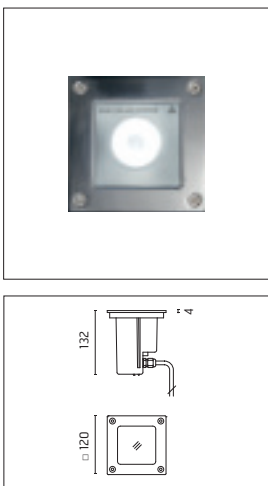

652828
QPAR CBC 51 50W/230V GZ10
T 180°C
Optional LED bulb
DR PAR 7,5W/230V GZ10
Lamp max size: Ø50 mm H.58 mm



653328
QR CBC 51 50W/12V GU5,3
T 180°C
Optional LED bulb
DRR 6,5W/12V a.c. GU5,3
Lamp max size: Ø50 mm H.48 mm

Remote transformer to be ordered

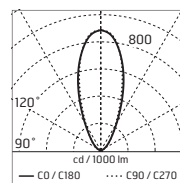

m	α	β	lux	lux
			Max	Med
5.00			23	16
4.00			42	24
3.00			75	43
2.00			168	97
1.00			672	389

α = 20.0° + 20.0° β = 20.0° + 20.0°

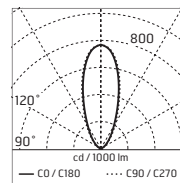

m	α	β	lux	lux
			Max	Med
5.00			23	14
4.00			36	21
3.00			65	38
2.00			146	85
1.00			583	339

α = 20.0° + 20.0° β = 20.0° + 20.0°

IP67

Bea - Aluminium Frame - Transparent Glass - Adjustable Optic

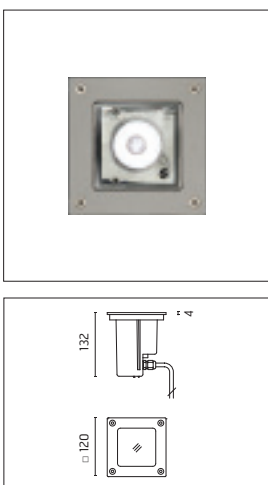

662815
QPAR CBC 51 50W/230V GZ10
T 180°C
Optional LED bulb
DR PAR 7,5W/230V GZ10
Lamp max size: Ø50 mm H.58 mm



663315
QR CBC 51 50W/12V GU5,3
T 180°C
Optional LED bulb
DRR 6,5W/12V a.c. GU5,3
Lamp max size: Ø50 mm H.48 mm

Remote transformer to be ordered

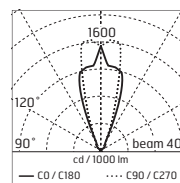

m	α	β	lux	lux
			Max	Med
5.00			49	29
4.00			77	45
3.00			136	80
2.00			307	180
1.00			1228	718

α = 16.0° + 16.0° β = 20.0° + 20.0°

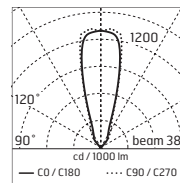

m	α	β	lux	lux
			Max	Med
5.00			40	27
4.00			62	42
3.00			110	74
2.00			248	166
1.00			993	665

α = 16.0° + 16.0° β = 16.0° + 16.0°

IP67

Bea - Aluminium Frame - Sandblasted Glass

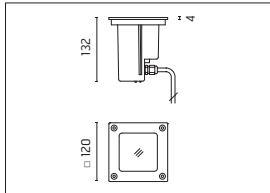
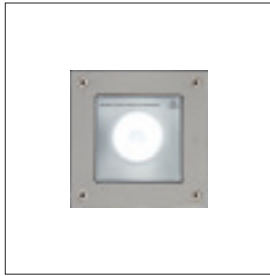

662823
 QPAR CBC 51 50W/230V GZ10
 T 180°C
 Optional LED bulb
 DR PAR 7,5W/230V GZ10
 Lamp max size: Ø50 mm H.58 mm

663323
 QR CBC 51 50W/12V GU5,3
 T 180°C
 Optional LED bulb
 DRR 6,5W/12V a.c. GU5,3
 Lamp max size: Ø50 mm H.48 mm

Remote transformer to be ordered

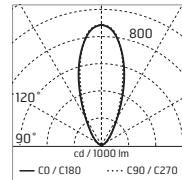

m	lux	
	Max	Med
5.00	22	16
4.00	42	24
3.00	75	43
2.00	168	97
1.00	672	389

$\alpha = 20.0^\circ + 20.0^\circ$ $\beta = 20.0^\circ + 20.0^\circ$

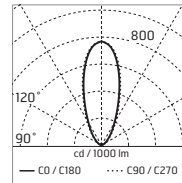

m	lux	
	Max	Med
5.00	23	14
4.00	36	21
3.00	65	38
2.00	146	85
1.00	583	339

$\alpha = 20.0^\circ + 20.0^\circ$ $\beta = 20.0^\circ + 20.0^\circ$

IP67

Accessories: Bea

42
 BOX FOR INSTALLATION
 165 x 165 H 170mm

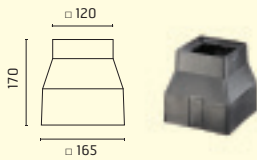

215
 3/4 WAY TERMINAL BLOCK 4 POLES
 IP68 H₂O STOP (Ø5,5÷12mm CABLE)

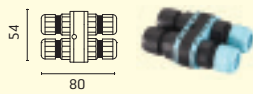

16
 TRANSFORMER 50W
 230V/12V 50Hz IP 66

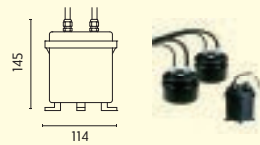

17
 TRANSFORMER 200W
 230V/12V 50Hz IP 66

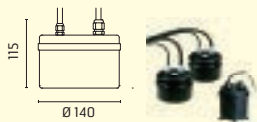

18
 TRANSFORMER 300W
 230V/12V 50Hz IP 66

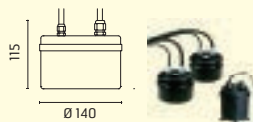

acc. code	▶	42	215	16	17	18
652815	▼	•	•			
653315		•	•	•	•	•
652828		•	•			
653328		•	•	•	•	•
662815		•	•			
663315		•	•	•	•	•
662823		•	•			
663323		•	•	•	•	•



- Round luminaire for installation on wall or ground – recessed.
- Configuration: die-cast aluminium structure, EN AB-47100 alloy (low copper content) and AISI 316L blasted stainless steel frame. Glass diffuser: Sandblasted with silkscreen border, fixed to the aluminium body through a robotic gluing system.
- Double layer coating for high resistance to corrosion: the aluminium components are painted with a double coat using powders which are compliant with QUALICOAT standards: a first layer of epoxy powder (with excellent chemical and mechanical resistance) and a second finishing layer of polyester powder (resistant to UV rays and atmospheric agents). The entire painting process of the aluminium fitting starts from components which have been sandblasted in advance to make the surface more porous and increase the adherence of the paint. Ares effects alkaline and acid washing to clean the surfaces completely, then rinses with demineralised water to remove any residue particles, subsequently a chemical conversion treatment is done to protect against rusting.
- Protection rating: IP67
- In compliance with EN 60598-1 standards
- Class of insulation: mains: I; low-voltage: III
- Installation: the luminaire is equipped with a piece of cable for an easy-to-make connection. 220-230V version: the cable is supplied with a 2-way connector for 3-conductor cables (H2O STOP) for an easy-to-make connection. 24V version: the cable is integrated with an H2O STOP device. Outdoor use requires suitable flexible cables. Installation requires a dedicated box to be ordered separately. It is important to provide a >200mm gravel layer or a drain system (for concrete surface) to ensure good drainage and to avoid water stagnation.
- We recommend the use of a connection system with a protection degree greater than or equal to the protection degree of the luminaire.
- During the installation and the maintenance of the fixtures it is important to be careful and avoid damages on the paint coating.
Damages on the coating exposed to outdoor conditions or water, could cause corrosion.
Chemical substances affect the anticorrosion covering protection.

EU Regulation 874/2012 - Illumination equipment energy classes



LED VERSION:
Class A/A+/A++
Luminaire supplied with integrated LED modules that cannot be replaced



.0 Inox



Recessed ground fitting



Recessed wall fitting



Do not install in hollow areas



Installation requires a 20cm water drainage layer (gravel)



Pre-wired with approx 250mm of cable.



Protection against water ingress from the cable



Remote device required for 24V version



Static load: 500Kg walk over



Glass surface temperature <70°C



Protection against impact.
IK 08 - 5,00 joule

Chiara - Stainless Steel Frame - Sandblasted Glass - Direct 230V

Light Source: Mid-Power LED / 3,5W / Total power 4W / CRI>80 / 220÷230V / LED module set up to work directly connected to the mains



530008
White 3000K
lm LED 380 ≠ lm OUTPUT 189

530007
White 4000K
lm LED 400 ≠ lm OUTPUT 199

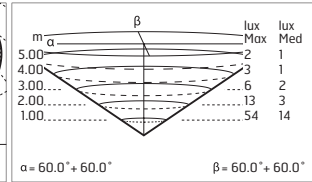
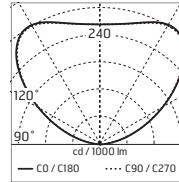

@ 4000K

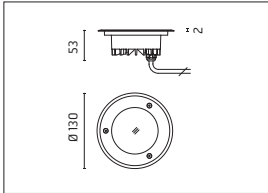

IP67

Chiara - Stainless Steel Frame - Sandblasted Glass - Direct 230V

Light Source: Mid-Power LED / 6,5W / Total power 7W / CRI>80 / 220÷230V / LED module set up to work directly connected to the mains



530003
White 3000K
lm LED 525 ≠ lm OUTPUT 453

530002
White 4000K
lm LED 555 ≠ lm OUTPUT 479

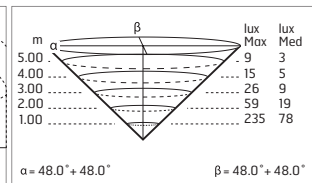
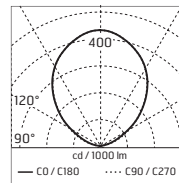

@ 4000K

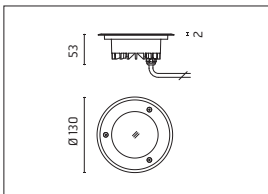

IP67

Chiara - Stainless Steel Frame - Sandblasted Glass - 24Vdc

Light Source: Mid-Power LED / 3,5W / Total power 4W / CRI>80 / 24Vdc / Remote electronic power supply to be ordered



530010
White 3000K
lm LED 360 ≠ lm OUTPUT 190
Acc. 144, 176 or 252

530009
White 4000K
lm LED 380 ≠ lm OUTPUT 200
Acc. 144, 176 or 252

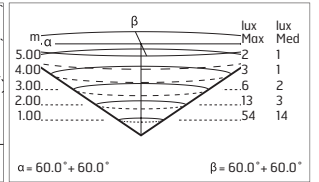
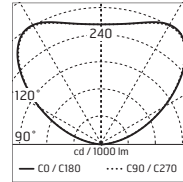

@ 4000K

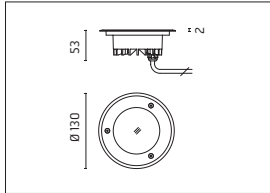

IP67

Chiara - Stainless Steel Frame - Sandblasted Glass - 24Vdc

Light Source: Mid-Power LED / 6,5W / Total power 7,3W / CRI>80 / 24Vdc / Remote electronic power supply to be ordered



530006
White 3000K
lm LED 707 ≠ lm OUTPUT 308
Acc. 144, 176 or 252

530005
White 4000K
lm LED 734 ≠ lm OUTPUT 394
Acc. 144, 176 or 252

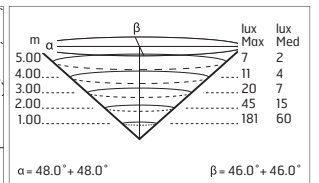
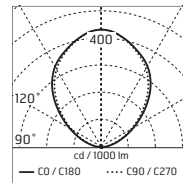

@ 4000K

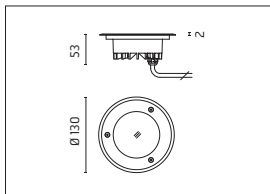

IP67



Accessories: Chiara

50
BOX FOR INSTALLATION
Ø 160 H 70mm

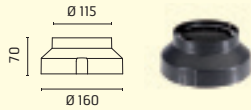

215
3/4 WAY TERMINAL BLOCK 4 POLES
IP68 H₂O STOP (Ø5,5÷12mm CABLE)

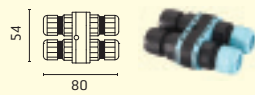

269
2 WAY TERMINAL BLOCK 2 POLES IP68
(Ø4÷6,9mm Cable)
*it can't be placed in the recessed box for installation



87
POWER SUPPLY 10W/110÷240V -
24Vdc IP20 CLASS II SELV.

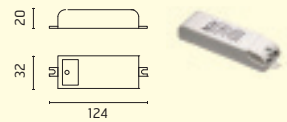

175
POWER SUPPLY 10W/110÷240V -
24Vdc IP67 CLASS II SELV.

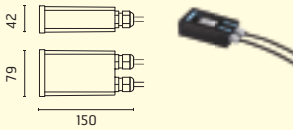

144
POWER SUPPLY 17W/110÷240V
- 24Vdc (15W@110V) IP20 CLASS
II SELV.

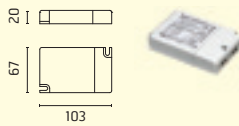

176
POWER SUPPLY 17W/110÷240V
- 24Vdc (15W@110V) IP67 CLASS
II SELV.

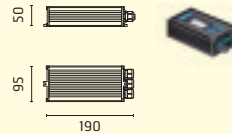

252
POWER SUPPLY 20W/110-240Vdc
(15W@110V) IP67 CLASS II SELV.

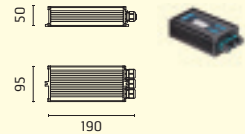

... DIMMABLE: PUSH-DIM OR 1...10V
See Page 558 Wiring Diagram n.4

... DIMMABLE: PUSH-DIM OR 1...10V
See Page 558 Wiring Diagram n.4

... DIMMABLE: DALI
See Page 558 Wiring Diagram n.4

147
POWER SUPPLY 20W/220÷240V -
24Vdc IP67 CLASS II SELV.

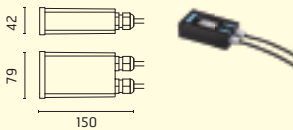

155
POWER SUPPLY 50W/120÷240V -
24Vdc IP67 CLASS II SELV.

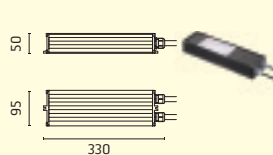

110
POWER SUPPLY 70W/220÷240V -
24Vdc IP67 CLASS II SELV EQ.

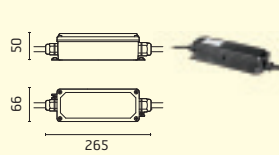

156
POWER SUPPLY 96W /120÷277V -
24Vdc IP67 CLASS II SELV.

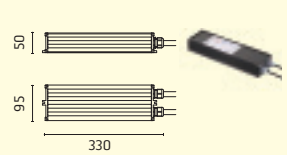

237
SPD: (SURGE PROTECTION DEVICE)
275Vac MAXIMUM DISCHARGE
CURRENT 10kA (8/20µs)
MAXIMUM OPERATING CURRENT 5A
SUITABLE FOR SERIES CONNECTION
- IP66

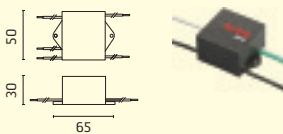

acc. code ▶	50	215	87	175	144	176	252	147	155	110	156	237	269
530002	•	•										•	
530003	•	•										•	
530005	•		1	1	2	2	2	2	7	9	12		•
530006	•		1	1	2	2	2	2	7	9	12		•
530007	•	•										•	
530008	•	•										•	
530009	•		2	2	4	4	4	4	12	16	21		•
530010	•		2	2	4	4	4	4	12	16	21		•

Max fixtures for each power supply (Vin 220÷240). Data in the chart are provided as a guide only. Please verify according to your installation.



- Round luminaire for installation on wall or ground - recessed.
- Configuration: die-cast aluminium structure, EN AB-47100 alloy (low copper content) and aluminium or AISI 316L stainless steel frame. Glass diffuser: transparent or sandblasted.
- Double layer coating for high resistance to corrosion: the aluminium components are painted with a double coat using powders which are compliant with QUALICOAT standards: a first layer of epoxy powder (with excellent chemical and mechanical resistance) and a second finishing layer of polyester powder (resistant to UV rays and atmospheric agents). The entire painting process of the aluminium fitting starts from components which have been sandblasted in advance to make the surface more porous and increase the adherence of the paint. Ares effects alkaline and acid washing to clean the surfaces completely, then rinses with demineralised water to remove any residue particles, subsequently a chemical conversion treatment is done to protect against rusting.
- Protection rating: IP67
- In compliance with EN 60598-1 standards
- Class of insulation: mains: I; low voltage: III
- Installation: the luminaire is equipped with a piece of cable with a 2-way connector for 3-conductor cables (H2O STOP) for an easy-to-make connection. Outdoor use requires suitable flexible cables. Installation requires a dedicated box to be ordered separately. It is important to provide a >300mm gravel layer or a drain system (for concrete surface) to ensure good drainage and to avoid water stagnation.
- We recommend the use of a connection system with a protection degree greater than or equal to the protection degree of the luminaire.
- During the installation and the maintenance of the fixtures it is important to be careful and avoid damages on the paint coating. Damages on the coating exposed to outdoor conditions or water, could cause corrosion. Chemical substances affect the anticorrosion covering protection.

EU Regulation 874/2012 - Illumination equipment energy classes

A	LED BULB VERSION: Class A DRR/GU5,3 DR-PAR/GZ10
B	HALOGEN VERSION: Class B QR-CBC51/GU5,3
D	HALOGEN VERSION: Class D QRPARCBC51/GZ10



	Recessed ground fitting		Installation requires a 30cm water drainage layer (gravel)
	Do not install in hollow areas		Protection against water ingress from the cable
	Pre-wired with approx 250mm of cable		Static load: 1000Kg walk over (Ø 120mm)
	Remote device required		Static load: 1500Kg walk over (Ø 130mm)
	Protection against impact. IK 09 - 10,00 joule		Check that diffuser's temperature "T max °C" (tested at 25°C) complies with your local regulation

Clio Ø 120mm - Aluminium Frame - Transparent Glass - Fixed Symmetric Optic



032856
 QPAR CBC 51 50W/230V GZ10
 T 180°C
 Optional LED bulb
 DR PAR 7,5W/230V GZ10
 Lamp max size: Ø50 mm H.58 mm



033356
 QR CBC 51 50W/12V GU5,3
 T 180°C
 Optional LED bulb
 DRR 6,5W/12V a.c. GU5,3
 Lamp max size: Ø50 mm H.48 mm

Remote transformer to be ordered

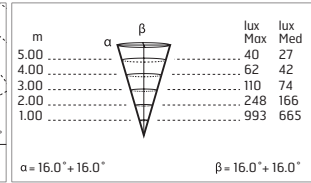
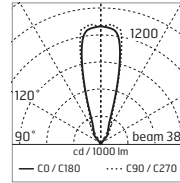
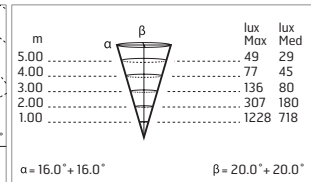
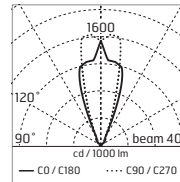
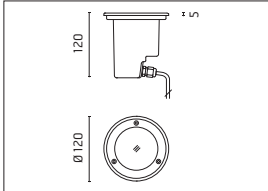

IP67

Clio Ø 120mm - Aluminium Frame - Transparent Glass - Adjustable Optic

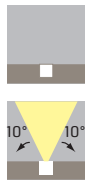

032815
 QPAR CBC 51 50W/230V GZ10
 T 180°C
 Optional LED bulb
 DR PAR 7,5W/230V GZ10
 Lamp max size: Ø50 mm H.58 mm



033315
 QR CBC 51 50W/12V GU5,3
 T 180°C
 Optional LED bulb
 DRR 6,5W/12V a.c. GU5,3
 Lamp max size: Ø50 mm H.48 mm

Remote transformer to be ordered

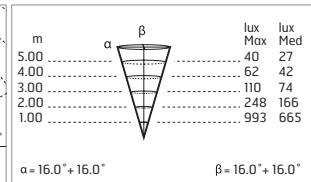
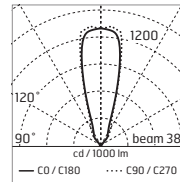
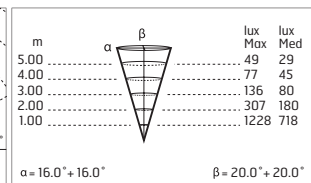
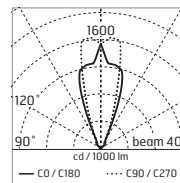
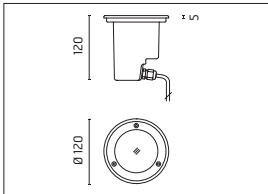

IP67

Clio Ø 120mm - Aluminium Frame - Sandblasted Glass - Fixed Symmetric Optic



032823
 QPAR CBC 51 50W/230V GZ10
 T 180°C
 Optional LED bulb
 DR PAR 7,5W/230V GZ10
 Lamp max size: Ø50 mm H.58 mm



033323
 QR CBC 51 50W/12V GU5,3
 T 180°C
 Optional LED bulb
 DRR 6,5W/12V a.c. GU5,3
 Lamp max size: Ø50 mm H.48 mm

Remote transformer to be ordered

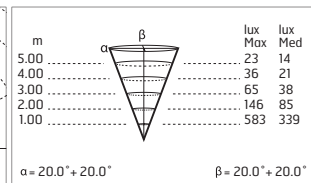
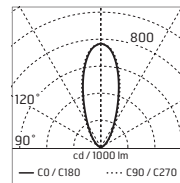
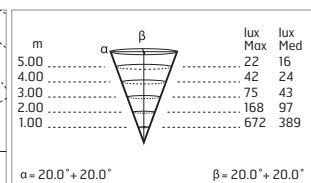
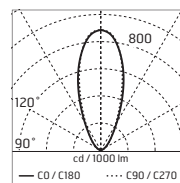
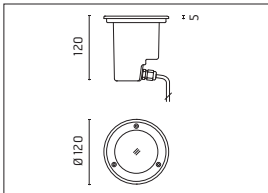

IP67

Clio Ø 130mm - Aluminium Frame - Transparent Glass - Fixed Symmetric Optic

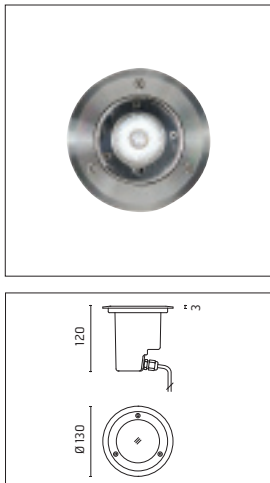

012856
 QPAR CBC 51 50W/230V GZ10
 T 180°C
 Optional LED bulb
 DR PAR 7,5W/230V GZ10
 Lamp max size: Ø50 mm H.58 mm



013356
 QR CBC 51 50W/12V GU5,3
 T 180°C
 Optional LED bulb
 DRR 6,5W/12V a.c. GU5,3
 Lamp max size: Ø50 mm H.48 mm

◆ Remote transformer to be ordered

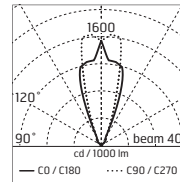

m	lux	
	Max	Med
5.00	49	29
4.00	77	45
3.00	136	80
2.00	307	180
1.00	1228	718

$\alpha = 16.0^\circ + 16.0^\circ$ $\beta = 20.0^\circ + 20.0^\circ$

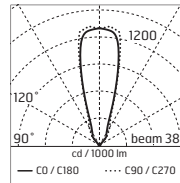

m	lux	
	Max	Med
5.00	40	27
4.00	62	42
3.00	110	74
2.00	248	166
1.00	993	665

$\alpha = 16.0^\circ + 16.0^\circ$ $\beta = 16.0^\circ + 16.0^\circ$

IP67 CE

Clio Ø 130mm - Stainless Steel Frame - Transparent Glass - Adjustable Optic

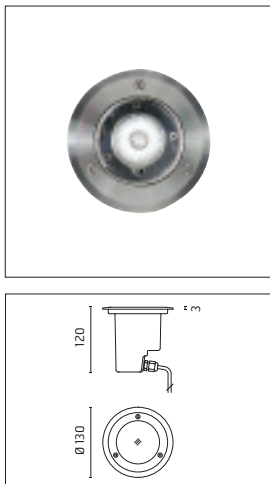

012815
 QPAR CBC 51 50W/230V GZ10
 T 180°C
 Optional LED bulb
 DR PAR 7,5W/230V GZ10
 Lamp max size: Ø50 mm H.58 mm



013315
 QR CBC 51 50W/12V GU5,3
 T 180°C
 Optional LED bulb
 DRR 6,5W/12V a.c. GU5,3
 Lamp max size: Ø50 mm H.48 mm

◆ Remote transformer to be ordered

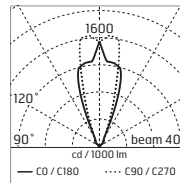

m	lux	
	Max	Med
5.00	49	29
4.00	77	45
3.00	136	80
2.00	307	180
1.00	1228	718

$\alpha = 16.0^\circ + 16.0^\circ$ $\beta = 20.0^\circ + 20.0^\circ$

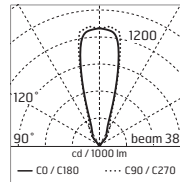

m	lux	
	Max	Med
5.00	40	27
4.00	62	42
3.00	110	74
2.00	248	166
1.00	993	665

$\alpha = 16.0^\circ + 16.0^\circ$ $\beta = 16.0^\circ + 16.0^\circ$

IP67 CE

Clio Ø 130mm - Stainless Steel Frame - Sandblasted Glass - Fixed Symmetric Optic

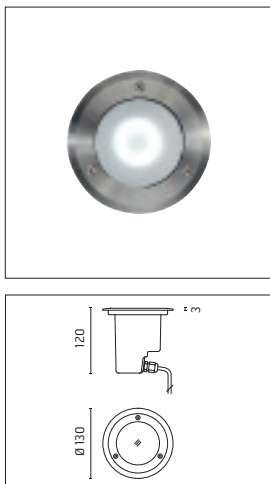

012828
 QPAR CBC 51 50W/230V GZ10
 T 180°C
 Optional LED bulb
 DR PAR 7,5W/230V GZ10
 Lamp max size: Ø50 mm H.58 mm



013328
 QR CBC 51 50W/12V GU5,3
 T 180°C
 Optional LED bulb
 DRR 6,5W/12V a.c. GU5,3
 Lamp max size: Ø50 mm H.48 mm

◆ Remote transformer to be ordered

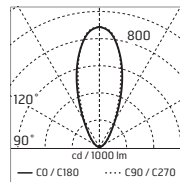

m	lux	
	Max	Med
5.00	22	16
4.00	42	24
3.00	75	43
2.00	168	97
1.00	672	389

$\alpha = 20.0^\circ + 20.0^\circ$ $\beta = 20.0^\circ + 20.0^\circ$

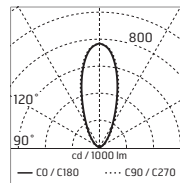

m	lux	
	Max	Med
5.00	23	14
4.00	36	21
3.00	65	38
2.00	146	85
1.00	583	339

$\alpha = 20.0^\circ + 20.0^\circ$ $\beta = 20.0^\circ + 20.0^\circ$

IP67 CE

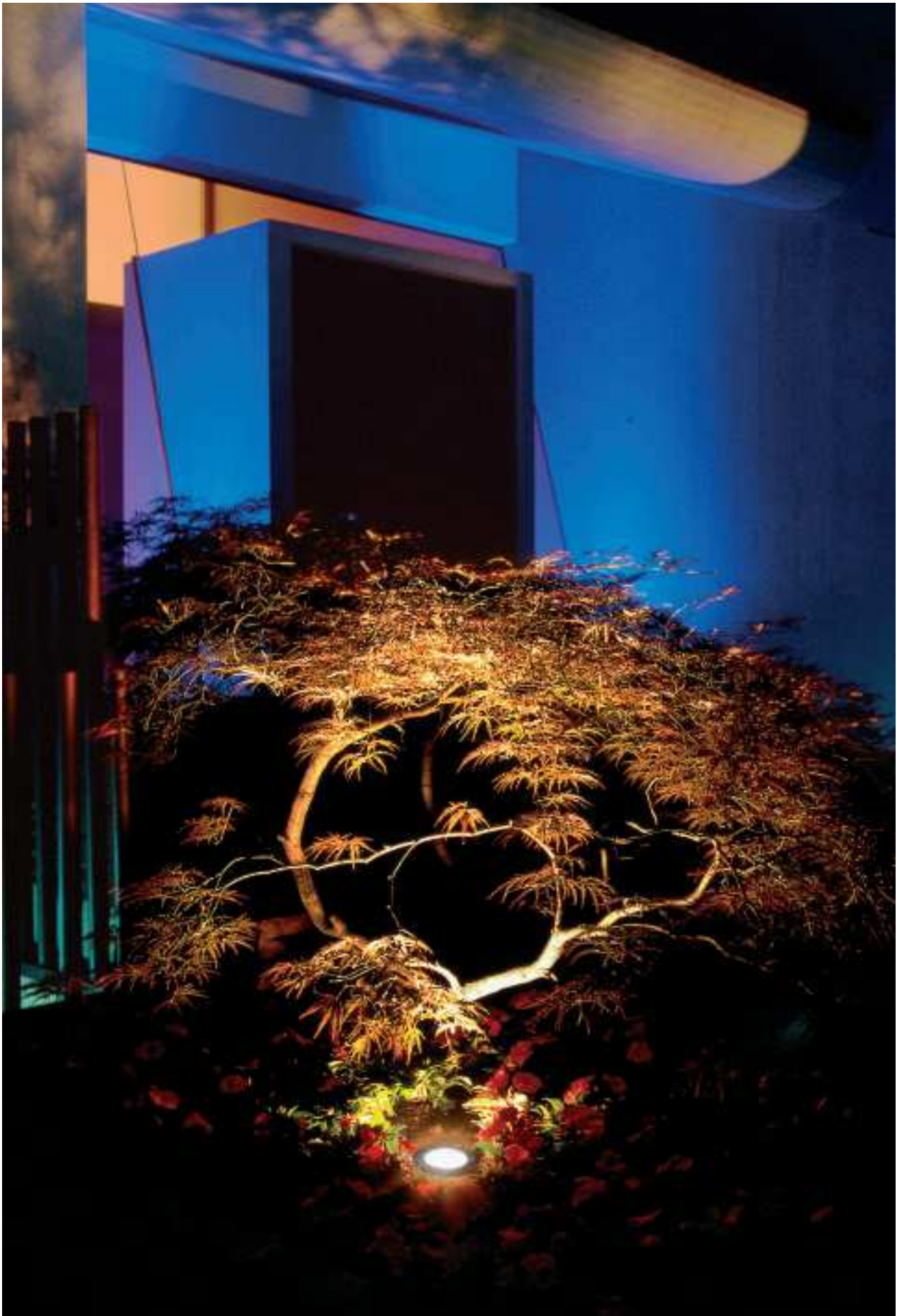

Accessories: Clio

20
BOX FOR INSTALLATION
Ø 175 H 152mm

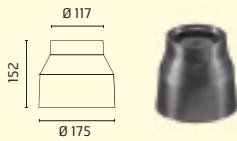

215
3/4 WAY TERMINAL BLOCK 4 POLES
IP68 H₂O STOP (Ø5,5÷12mm CABLE)

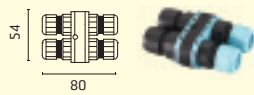

16
TRANSFORMER 50W
230V/12V 50Hz IP 66

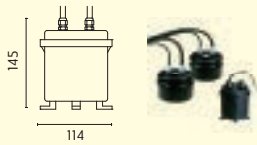

17
TRANSFORMER 200W
230V/12V 50Hz IP 66

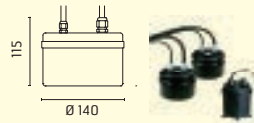

18
TRANSFORMER 300W
230V/12V 50Hz IP 66

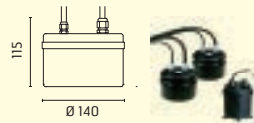

acc. code ▶	20	215	16	17	18
32856	•	•			
33356	•	•	•	•	•
32815	•	•			
33315	•	•	•	•	•
32823	•	•			
33323	•	•	•	•	•
12856	•	•			
13356	•	•	•	•	•
12815	•	•			
13315	•	•	•	•	•
12828	•	•			
13328	•	•	•	•	•



- Round luminaire for installation in-ground – recessed.
- Configuration: die-cast aluminium structure, EN AB-47100 alloy (low copper content) and AISI 316L stainless steel frame. Glass diffuser: Tempered transparent or sandblasted glass.
- Double layer coating for high resistance to corrosion: the aluminium components are painted with a double coat using powders which are compliant with QUALICOAT standards: a first layer of epoxy powder (with excellent chemical and mechanical resistance) and a second finishing layer of polyester powder (resistant to UV rays and atmospheric agents). The entire painting process of the aluminium fitting starts from components which have been sandblasted in advance to make the surface more porous and increase the adherence of the paint. Ares effects alkaline and acid washing to clean the surfaces completely, then rinses with demineralised water to remove any residue particles, subsequently a chemical conversion treatment is done to protect against rusting.
- Protection rating: IP67
- In compliance with EN 60598-1 standards
- Class of insulation: I
- Installation: the luminaire is equipped with a piece of cable with a 2-way connector for 3-conductor cables (H₂O STOP) for an easy-to-make connection. Outdoor use requires suitable flexible cables. Installation requires a dedicated box to be ordered separately. It is important to provide a >400mm gravel layer or a drain system (for concrete surfaces) to ensure good drainage and to avoid water stagnation.
- We recommend the use of a connection system with a protection degree greater than or equal to the protection degree of the luminaire.
- During the installation and the maintenance of the fixtures it is important to be careful and avoid damages on the paint coating. Damages on the coating exposed to outdoor conditions or water, could cause corrosion. Chemical substances affect the anticorrosion covering protection.

EU Regulation 874/2012 - Illumination equipment energy classes

A⁺ **LED BULB VERSION:**
Class A+
DRRA/E27

A⁺ **METAL HALIDE VERSION:**
Class A+
HIT-CE/G12

D **HALOGEN VERSION:**
Class D
QT32/E27



.0 Inox



Recessed ground fitting



Installation requires a 40cm water drainage layer (gravel)



Do not install in hollow areas



Pre-wired with approx 250mm of cable



Protection against water ingress from the cable



Static load: 2500Kg walk over (petra)



Drive over



Check that diffuser's temperature "T max °C" (tested at 25°C) complies with your local regulation



Protection against impact.
IK 09 - 10,00 joule

Petra - Symmetric Optic



070113
 QT 32 100W E27
 T 190°C
 Optional LED bulb
 DRRA/C 13,5W E27
 Bulb max size: Ø62 mm H.116 mm
 Photometric curve not available

073513
 HIT-CE 35W G12
 T 105°C

077113
 HIT-CE 70W G12
 T 105°C

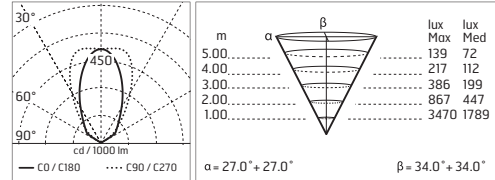
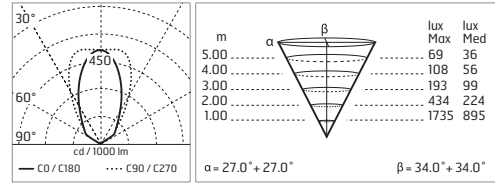
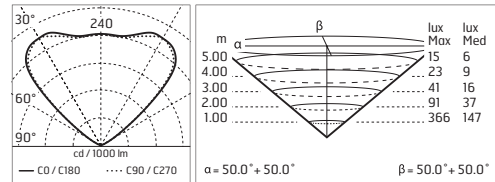
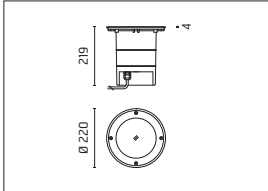

IP67

Petra - Asymmetric Optic

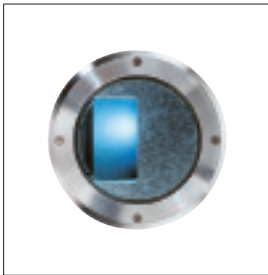

073514
 HIT-CE 35W G12
 T 105°C

077114
 HIT-CE 70W G12
 T 105°C

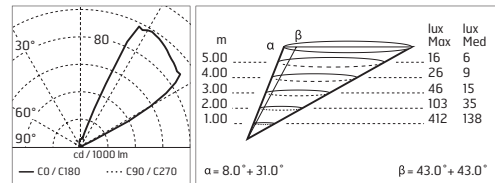
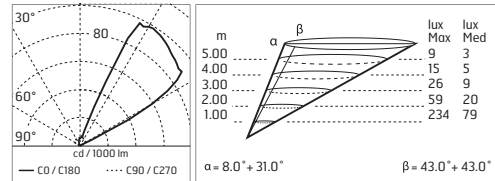
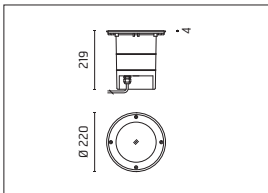

IP67

Petra - Adjustable Optic - 15°

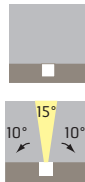

0735129
HIT-CE 35W G12
T 105°C

0771129
HIT-CE 70W G12
T 105°C

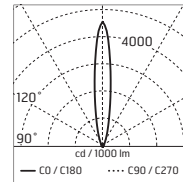
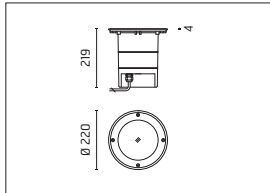

m	lux	
	Max	Med
5.00	617	385
4.00	963	601
3.00	1713	1068
2.00	3853	2404
1.00	15413	9616

$\alpha = 8.0^\circ + 8.0^\circ$ $\beta = 8.0^\circ + 8.0^\circ$

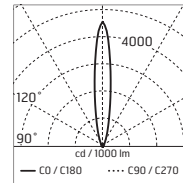

m	lux	
	Max	Med
5.00	1233	769
4.00	1927	1202
3.00	3425	2137
2.00	7706	4808
1.00	30825	19232

$\alpha = 8.0^\circ + 8.0^\circ$ $\beta = 8.0^\circ + 8.0^\circ$

IP67

Petra - Adjustable Optic - 40°

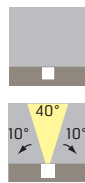

073515
HIT-CE 35W G12
T 105°C

077115
HIT-CE 70W G12
T 105°C

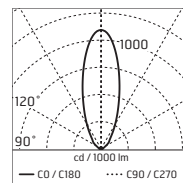
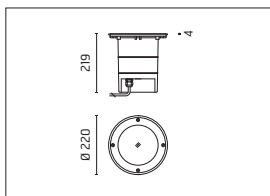

m	lux	
	Max	Med
5.00	148	87
4.00	232	136
3.00	412	241
2.00	928	543
1.00	3712	2173

$\alpha = 18.0^\circ + 18.0^\circ$ $\beta = 18.0^\circ + 18.0^\circ$

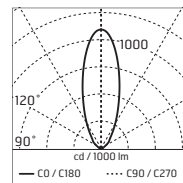

m	lux	
	Max	Med
5.00	297	174
4.00	464	272
3.00	825	483
2.00	1856	1086
1.00	7424	4346

$\alpha = 18.0^\circ + 18.0^\circ$ $\beta = 18.0^\circ + 18.0^\circ$

IP67

Accessories: Petra

26
BOX FOR INSTALLATION
Ø 210 H 270mm

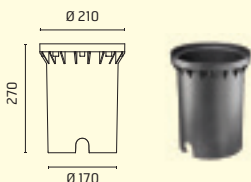

233
SANDBLASTED GLASS FOR PETRA
Ø 172mm



215
3/4 WAY TERMINAL BLOCK 4 POLES
IP68 H2O STOP (Ø5,5÷12mm CABLE)



acc. code	26	233	215
70113	•	•	•
735129	•	•	•
73513	•	•	•
73514	•	•	•
73515	•	•	•
771129	•		•
77113	•		•
77114	•		•
77115	•		•



- Round luminaire for installation in-ground – recessed.
- Configuration: AISI 316 deep-drawn stainless steel structure with milled AISI 316L stainless steel finish frame. Glass diffuser: transparent or sandblasted. The stainless steel structure allows installation in extreme conditions (sea or road salt).
- Protection rating: IP67
- In compliance with EN 60598-1 standards
- Class of insulation: mains: I; low voltage: III
- Installation: the luminaire is equipped with a piece of cable with a 2-way connector for 3-conductor cables (H₂O STOP) for an easy-to-make connection. LED 24V is equipped with a dc/dc highly efficient converter that removes electromagnetic interference and allows parallel wiring and is protected against polarity reversal and sudden voltage peak. Outdoor use requires suitable flexible cables. Installation requires a dedicated box for installation (to be ordered separately). It is important to provide a >400mm gravel layer or a drain system (for concrete surface) to ensure good drainage and to avoid water stagnation.
- We recommend the use of a connection system with a protection degree greater than or equal to the protection degree of the luminaire.
- During the installation and the maintenance of the fixtures it is important to be careful and avoid damages on the paint coating. Damages on the coating exposed to outdoor conditions or water, could cause corrosion. Chemical substances affect the anticorrosion covering protection.

EU Regulation 874/2012 - Illumination equipment energy classes

	LED VERSION: Class A/A+/A++ Luminaire supplied with integrated LED modules that cannot be replaced
	METAL HALIDE VERSION: Class A+ HIT-TC-CE/G8,5
	HALOGEN VERSION: Class B QR-CBC51/GU5,3
	HALOGEN VERSION: Class D QT32/E27 QPAR51/GU10



.0 Inox

	Recessed ground fitting		Installation requires a 40cm water drainage layer (gravel)
	Do not install in hollow areas		Pre-wired with approx 250mm of cable
	Protection against water ingress from the cable H₂O STOP		Remote device required
	Static load: 2000Kg walk over		Drive over
	Check that diffuser's temperature *T max °C*(tested at 25°C) complies with your local regulation Glass surface temperature <70°C for LED source		Protection against impact. IK 09 - 10,00 joule

Idra Ø 130mm - Transparent Glass - Adjustable Optic

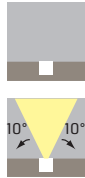

252815
 QPAR 51 35W/230V GU10
 T 132°C
 Lamp max size: Ø50 mm H.55 mm
 Optional LED bulb
 DR PAR 7,5W/230V GZ10
 Lamp max size: Ø50 mm H.55 mm



253315
 QR CBC 51 35W/12V GU5,3
 T 132°C
 Lamp max size: Ø50 mm H.45 mm
 Optional LED bulb
 DRR 6,5W/12V a.c. GU5,3
 Lamp max size: Ø50 mm H.45 mm

Remote transformer to be ordered

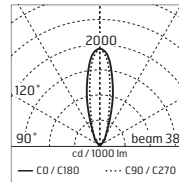

m	α	β	lux	lux
			Max	Med
5.00			16	9
4.00			25	14
3.00			44	25
2.00			99	57
1.00			395	228

α = 12.0° + 12.0° β = 15.0° + 15.0°

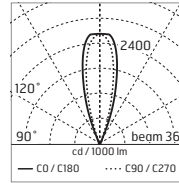

m	α	β	lux	lux
			Max	Med
5.00			73	48
4.00			114	74
3.00			203	132
2.00			458	297
1.00			1831	1189

α = 13.0° + 13.0° β = 16.0° + 16.0°

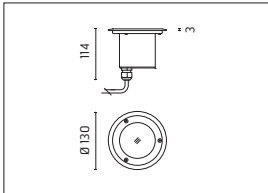

IP67

Idra Ø 130mm - Transparent Glass - Symmetric Optic - 10°

Light Source: Power LED / 3,3W / Total power 4,5W / CRI>80 / 24Vdc / Remote electronic power supply to be ordered

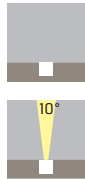

255622
 White 2700K
 lm LED 307 ≈ lm OUTPUT 234

255612
 White 3000K
 lm LED 330 ≈ lm OUTPUT 252

2517212
 White 4000K
 lm LED 366 ≈ lm OUTPUT 281

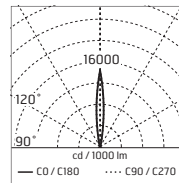

m	α	β	lux	lux
			Max	Med
5.00			177	108
4.00			276	169
3.00			491	300
2.00			1105	675
1.00			4418	2701

α = 5.0° + 5.0° β = 5.0° + 5.0°

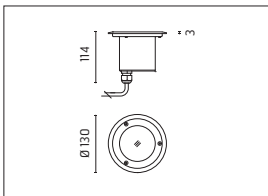

IP67

Idra Ø 130mm - Transparent Glass - Symmetric Optic - 50°

Light Source: Power LED / 3,3W / Total power 4,5W / CRI>80 / 24Vdc / Remote electronic power supply to be ordered

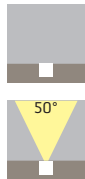

2556228
 White 2700K
 lm LED 307 ≈ lm OUTPUT 261

2556128
 White 3000K
 lm LED 330 ≈ lm OUTPUT 281

25172128
 White 4000K
 lm LED 366 ≈ lm OUTPUT 299

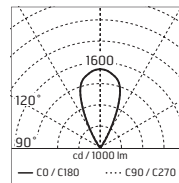

m	α	β	lux	lux
			Max	Med
5.00			18	10
4.00			28	16
3.00			49	29
2.00			110	65
1.00			440	260

α = 25.0° + 25.0° β = 25.0° + 25.0°

@ 4000K

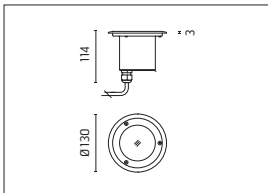

IP67

Idra Ø 130mm - Sandblasted Glass - Symmetric Optic

Light Source: Power LED / 3,3W / Total power 4,5W / CRI>80 / 24Vdc / Remote electronic power supply to be ordered



255638
White 2700K
lm LED 299 ≈ lm OUTPUT 121

255628
White 3000K
lm LED 321 ≈ lm OUTPUT 130

2517228
White 4000K
lm LED 342 ≈ lm OUTPUT 138

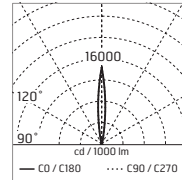
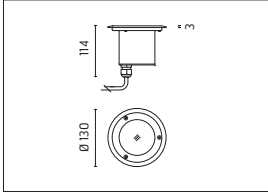

m	lux	
	Max	Med
5.00	177	108
4.00	276	169
3.00	491	300
2.00	1105	675
1.00	4418	2701

α = 5.0° + 5.0° β = 5.0° + 5.0°

@ 4000K

IP67

Idra Ø 220mm - Transparent Glass - Adjustable Optic



250113
QT 32 100W E27
T 170°C
Lamp max size: Ø40 mm H.115 mm

256713
HIT-TC-CE 35W G8,5
T 85°C

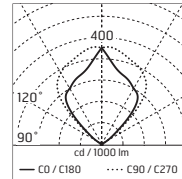
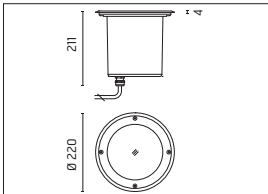

m	lux	
	Max	Med
5.00	22	7
4.00	34	12
3.00	61	21
2.00	136	47
1.00	545	187

α = 45.0° + 45.0° β = 42.0° + 42.0°

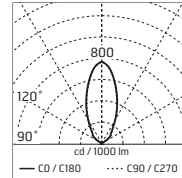

m	lux	
	Max	Med
5.00	101	57
4.00	158	89
3.00	281	158
2.00	633	355
1.00	2533	1421

α = 22.0° + 22.0° β = 22.0° + 22.0°

IP67

Idra Ø 220mm - Sandblasted Glass - Adjustable Optic



250157
QT 32 100W E27
T 170°C

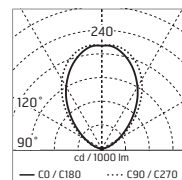
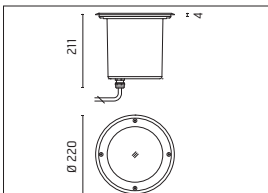

m	lux	
	Max	Med
5.00	16	6
4.00	25	10
3.00	44	17
2.00	98	38
1.00	392	152

α = 43.0° + 43.0° β = 40.0° + 40.0°

IP67

Idra Ø 220mm - Transparent Glass - Adjustable Optic - 24°

Light Source: Power LED / 15W / Total power 16W / CRI>90 / 220-240V / Integral electronic power supply

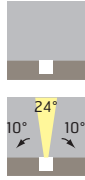

257722.A
White 2700K
lm LED 753 ≈ lm OUTPUT 747

257712.A
White 3000K
lm LED 810 ≈ lm OUTPUT 773

2518312.A
White 4000K
lm LED 830 ≈ lm OUTPUT 817

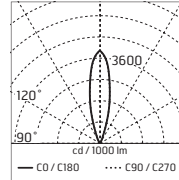

m	lux	
	Max	Med
5.00	129	79
4.00	201	124
3.00	358	220
2.00	805	496
1.00	3221	1982

α = 12.0° ± 12.0° β = 12.0° ± 12.0°

@ 4000K

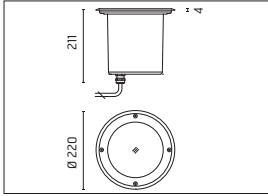

IP67

Idra Ø 220mm - Transparent Glass - Adjustable Optic - 44°

Light Source: Power LED / 15W / Total power 16W / CRI>90 / 220-240V / Integral electronic power supply

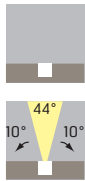

257738.A
White 2700K
lm LED 753 ≈ lm OUTPUT 719

257728.A
White 3000K
lm LED 810 ≈ lm OUTPUT 741

2518328.A
White 4000K
lm LED 830 ≈ lm OUTPUT 803

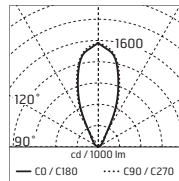

m	lux	
	Max	Med
5.00	48	28
4.00	75	43
3.00	134	77
2.00	301	173
1.00	1204	693

α = 22.0° ± 22.0° β = 22.0° ± 22.0°

@ 4000K

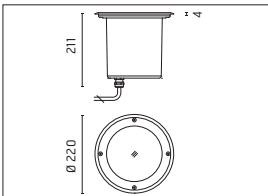

IP67



Accessories: Idra

26
BOX FOR INSTALLATION
Ø 210 H 270mm

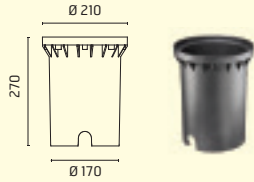

85
BOX FOR INSTALLATION
Ø 130 H 130mm



215
3/4 WAY TERMINAL BLOCK 4 POLES
IP68 H₂O STOP (Ø5,5±12mm CABLE)

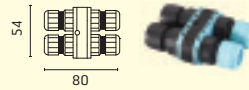

16
TRANSFORMER 50W
230V/12V 50Hz IP 66

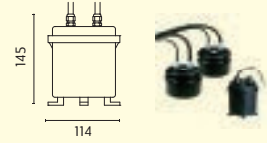

17
TRANSFORMER 200W
230V/12V 50Hz IP 66

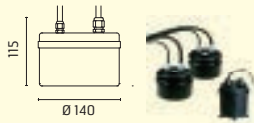

18
TRANSFORMER 300W
230V/12V 50Hz IP 66

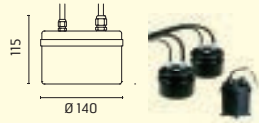

150
POWER SUPPLY DUAL FUNCTION
Vout 24Vdc: 8W/100÷240V
Iout 350mA: 6x1W/100÷240V
IP20 CLASS II SELV EQ.

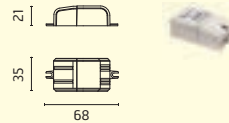

106
POWER SUPPLY DUAL FUNCTION
Vout 24Vdc: 8W/100÷240V
Iout 350mA: 6x1W/100÷240V
IP65 CLASS II SELV EQ.

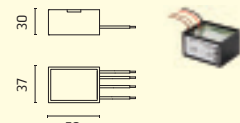

87
POWER SUPPLY 10W/110÷240V -
24Vdc IP20 CLASS II SELV.

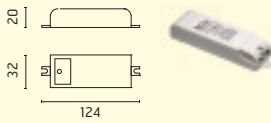

175
POWER SUPPLY 10W/110÷240V - 24Vdc
IP67 CLASS II SELV.

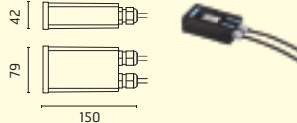

155
POWER SUPPLY 50W/120÷240V - 24Vdc
IP67 CLASS II SELV.

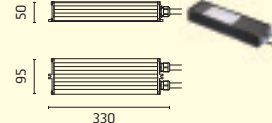

110
POWER SUPPLY 70W/220÷240V - 24Vdc
IP67 CLASS II SELV EQ.

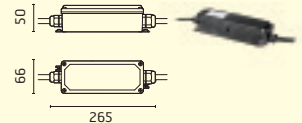

237
SPD: (SURGE PROTECTION DEVICE)
275Vac
MAXIMUM DISCHARGE CURRENT 10KA
(8/20µs)
MAXIMUM OPERATING CURRENT 5A
SUITABLE FOR SERIES CONNECTION
- IP66

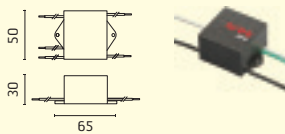

acc. code ▶	26	85	215	16	17	18	150	106	87	175	155	110	237
prod. code ▼													
250113	•		•										
250157	•		•										
252815		•	•										
253315		•	•	•	•	•							
255612		•	•				1	1	2	2	7	14	
255622		•	•				1	1	2	2	7	14	
255628		•	•				1	1	2	2	7	14	
255638		•	•				1	1	2	2	7	14	
256713	•		•										
257712.A	•		•										•
257722.A	•		•										•
257728.A	•		•										•
257738.A	•		•										•
2517212		•	•				1	1	2	2	7	14	
2517228		•	•				1	1	2	2	7	14	
2518312.A	•		•										•
2518328.A	•		•										•
2556128		•	•				1	1	2	2	7	14	
2566228		•	•				1	1	2	2	7	14	
25172128		•	•				1	1	2	2	7	14	

Max fixtures for each power supply (Vin 220÷240). Data in the chart are provided as a guide only. Please verify according to your installation.



- Slim rectangular or round luminaire for installation on wall – surface or recessed.
- Configuration: die-cast aluminium structure, EN AB-47100 alloy (low copper content). Moulded transparent polycarbonate emitting unit (rectangular) or transparent polyurethane resin filling (round) and polished aluminium reflector fixed by double-sided technical tape.
- Double layer coating for high resistance to corrosion: the aluminium components are painted with a double coat using powders which are compliant with QUALICOAT standards: a first layer of epoxy powder (with excellent chemical and mechanical resistance) and a second finishing layer of polyester powder (resistant to UV rays and atmospheric agents). The entire painting process of the aluminium fitting starts from components which have been sandblasted in advance to make the surface more porous and increase the adherence of the paint. Ares effects alkaline and acid washing to clean the surfaces completely, then rinses with demineralised water to remove any residue particles, subsequently a chemical conversion treatment is done to protect against rusting.
- Protection rating: IP65
- In compliance with EN 60598-1 standards
- Class of insulation: III
- Installation: the luminaire is equipped with a piece of cable for an easy-to-make connection. 24V feeding: power supply installed in a remote position; 230V feeding: power supply located behind the luminaire into the recessed box for installation (to be ordered separately). Outdoor use requires suitable flexible cables.
- We recommend the use of a connection system with a protection degree greater than or equal to the protection degree of the luminaire.
- During the installation and the maintenance of the fixtures it is important to be careful and avoid damages on the paint coating.
Damages on the coating exposed to outdoor conditions or water, could cause corrosion.
Chemical substances affect the anticorrosion covering protection.

EU Regulation 874/2012 - Illumination equipment energy classes



LED VERSION:
Class A/A+/A++
Luminaire supplied
with integrated LED modules
that cannot be replaced



.1 White



.6 Grey



.3 Anthracite



.4 Black



.18 Deep Brown



Recessed wall fitting.



Wall fitting



Pre-wired with approx 250mm of cable.



Remote device required.



Protection against impact.
IK 08 - 5,00 joule

Trixie Round - Transparent Diffuser

Light Source: Low-Power LED / 1,5W / Total power 1,9W / CRI>80 / 24Vdc / Remote electronic power supply to be ordered

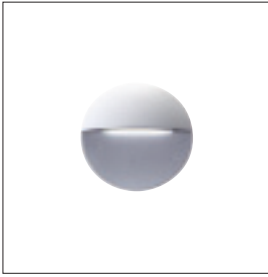

526005
White 2700K
lm LED 139 lm OUTPUT 66
...||| Acc. 144, 176 or 252

526003
White 3000K
lm LED 149 ≠ lm OUTPUT 71
...||| Acc. 144, 176 or 252

526002
White 4000K
lm LED 156 ≠ lm OUTPUT 74
...||| Acc. 144, 176 or 252

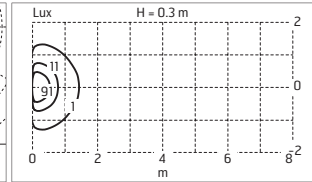
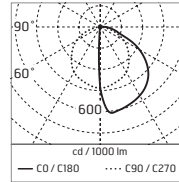

@ 4000K

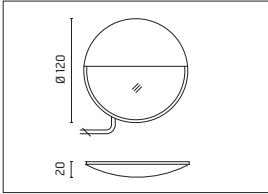

IP65

Trixie - Transparent Diffuser

Light Source: Low-Power LED/ 1,5W / Total power 1,9W / CRI>80 / 24Vdc / Remote electronic power supply to be ordered

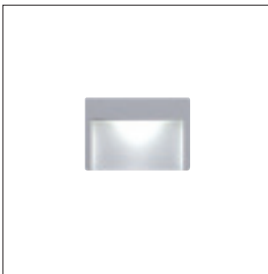

1029600
White 2700K
lm LED 139 lm OUTPUT 57
...||| Acc. 144, 176 or 252

1029500
White 3000K
lm LED 149 ≠ lm OUTPUT 61
...||| Acc. 144, 176 or 252

1022900
White 4000K
lm LED 156 ≠ lm OUTPUT 64
...||| Acc. 144, 176 or 252

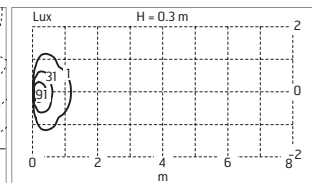
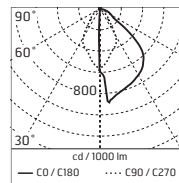

@ 4000K

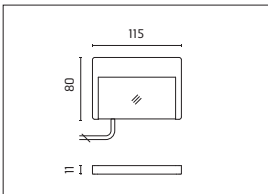

IP65





Accessories: Trixie

105
3 MODULES RECESSED BOX
106 x 75 H 55mm

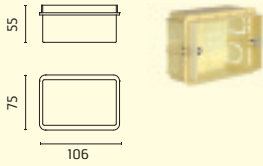

150
POWER SUPPLY DUAL FUNCTION
Vout 24Vdc: 8W/100÷240V
Iout 350mA: 6x1W/100÷240V
IP20 CLASS II SELV EQ.

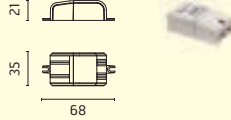

106
POWER SUPPLY DUAL FUNCTION
Vout 24Vdc: 8W/100÷240V
Iout 350mA: 6x1W/100÷240V
IP65 CLASS II SELV EQ.

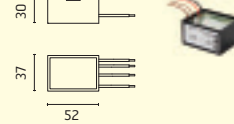

87
POWER SUPPLY 10W/110÷240V -
24Vdc IP20 CLASS II SELV.

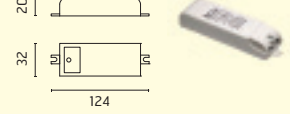

175
POWER SUPPLY 10W/110÷240V - 24Vdc
IP67 CLASS II SELV.

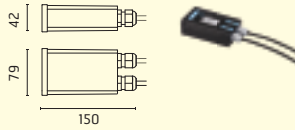

144
POWER SUPPLY 17W/110÷240V - 24Vdc
(15W@110V) IP20 CLASS II SELV.

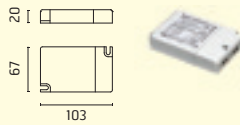

176
POWER SUPPLY 17W/110÷240V - 24Vdc
(15W@110V) IP67 CLASS II SELV.

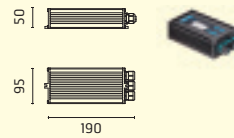

252
POWER SUPPLY 20W/110-240Vdc
(15W@110V) IP67 CLASS II SELV.

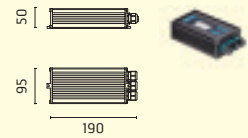

... DIMMABLE: PUSH-DIM OR 1...10V
See Page 558 Wiring Diagram n.4

... DIMMABLE: PUSH-DIM OR 1...10V
See Page 558 Wiring Diagram n.4

... DIMMABLE: DALI
See Page 558 Wiring Diagram n.4

147
POWER SUPPLY 20W/220÷240V -
24Vdc IP67 CLASS II SELV.

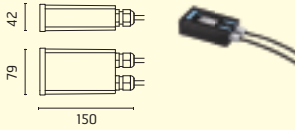

155
POWER SUPPLY 50W/120÷240V -
24Vdc IP67 CLASS II SELV.

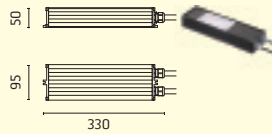

110
POWER SUPPLY 70W/220÷240V -
24Vdc IP67 CLASS II SELV EQ.

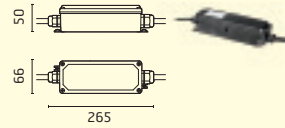

156
POWER SUPPLY 96W /120÷277V -
24Vdc IP67 CLASS II SELV EQ.

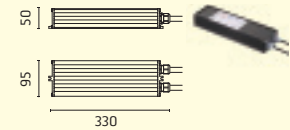

Trixie with box cod.105

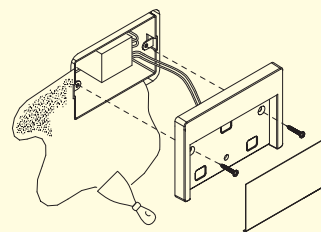

Trixie without box cod.105

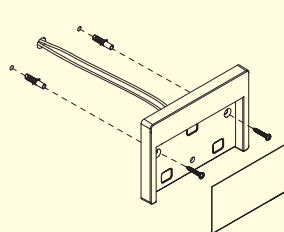

Optional: power supply code 106 in
recessed box.

acc. code ▶	105	150	106	87	175	144	176	252	147	155	110	156
526002	•	3	3	5	5	8	8	9	9	25	30	45
526003	•	3	3	5	5	8	8	9	9	25	30	45
1029500	•	3	3	5	5	8	8	9	9	25	30	45
10222900	•	3	3	5	5	8	8	9	9	25	30	45
526005	•	3	3	5	5	8	8	9	9	25	30	45
1029600	•	3	3	5	5	8	8	9	9	25	30	45

Max fixtures for each power supply (Vin 220÷240). Data in the chart are provided as a guide only. Please verify according to your installation.



Camilla L 230 mm - Adjustable Optic - Diffused Light

Light Source: Mid-Power LED / CRI>80

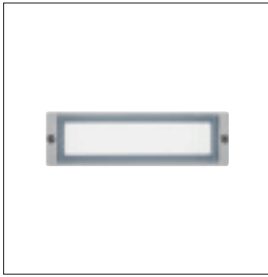

⊕ 4W / Potenza totale 7W / 100÷240V / Integral electronic power supply

115147212
White 2700K
lm LED 493 ≠ lm OUTPUT 99

115147112
White 3000K
lm LED 530 ≠ lm OUTPUT 106

115147113
White 4000K
lm LED 557 ≠ lm OUTPUT 112

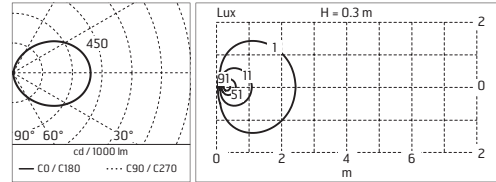

@ 4000K

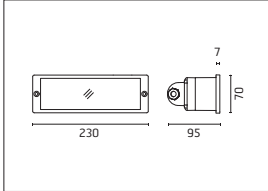

⊕ 4W / Total power 5W / 24Vdc / Remote electronic power supply to be ordered

115147214
White 2700K
lm LED 493 ≠ lm OUTPUT 99
Acc. 144, 176 or 252

115147114
White 3000K
lm LED 530 ≠ lm OUTPUT 106
Acc. 144, 176 or 252

115147115
White 4000K
lm LED 557 ≠ lm OUTPUT 112
Acc. 144, 176 or 252

Supplied with asymmetric emission

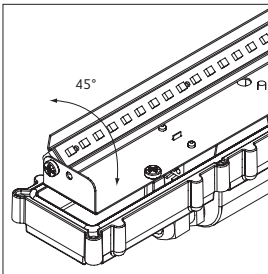

Move the LED module to get the symmetric emission

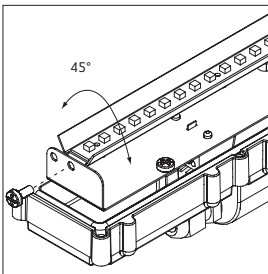

IP67

Camilla L 300 mm - Adjustable Optic - Diffused Light

Light Source: Mid-Power LED / CRI>80

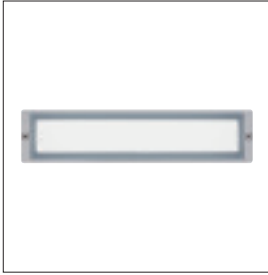

⊕ 6W / Potenza totale 10W / 100÷240V / Integral electronic power supply

115147216
White 2700K
lm LED 739 ≠ lm OUTPUT 149

115147116
White 3000K
lm LED 795 ≠ lm OUTPUT 160

115147117
White 4000K
lm LED 835 ≠ lm OUTPUT 168

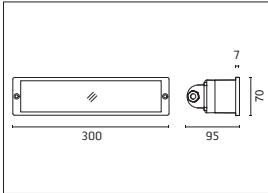
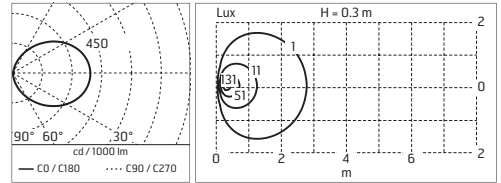

⊖ 6W / Total power 7,5W / 24Vdc / Remote electronic power supply to be ordered

115147218
White 2700K
lm LED 739 ≠ lm OUTPUT 149
...||| Acc. 144, 176 or 252

115147118
White 3000K
lm LED 795 ≠ lm OUTPUT 160
...||| Acc. 144, 176 or 252

115147119
White 4000K
lm LED 835 ≠ lm OUTPUT 168
...||| Acc. 144, 176 or 252

Supplied with asymmetric emission

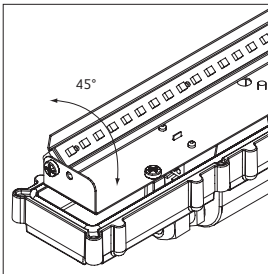

Move the LED module to get the symmetric emission

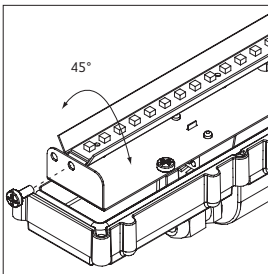

IP67



Accessories: Camilla

123
BOX FOR INSTALLATION
255 x 110 x H 95mm

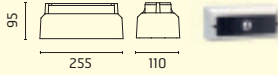

124
BOX FOR INSTALLATION
325 x 110 x H 95mm

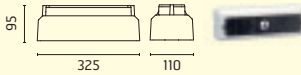

106
POWER SUPPLY DUAL FUNCTION
Vout 24Vdc: 8W/100÷240V
Iout 350mA: 6x1W/100÷240V
IP65 CLASS II SELV EQ.

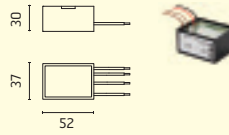

87
POWER SUPPLY 10W/110÷240V -
24Vdc IP20 CLASS II SELV.

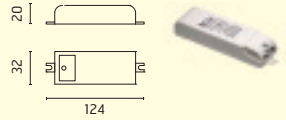

175
POWER SUPPLY 10W/110÷240V -
24Vdc IP67 CLASS II SELV.

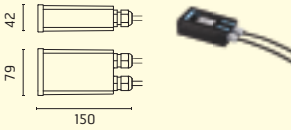

144
POWER SUPPLY 17W/110÷240V -
24Vdc (15W@110V) IP20 CLASS II
SELV.

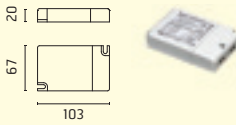

176
POWER SUPPLY 17W/110÷240V
- 24Vdc (15W@110V) IP67 CLASS
II SELV.

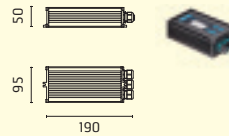

215
3/4 WAY TERMINAL BLOCK 4 POLES
IP68 H₂O STOP (Ø5,5÷12mm CABLE)

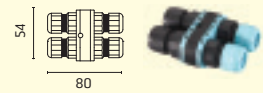

... DIMMABLE: PUSH-DIM OR 1...10V
See Page 558 Wiring Diagram n.4

... DIMMABLE: PUSH-DIM OR 1...10V
See Page 558 Wiring Diagram n.4

155
POWER SUPPLY 50W/120÷240V -
24Vdc IP67 CLASS II SELV.

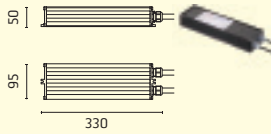

110
POWER SUPPLY 70W/220÷240V -
24Vdc IP67 CLASS II SELV EQ.

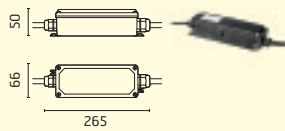

156
POWER SUPPLY 96W /120÷277V -
24Vdc IP67 CLASS II SELV.

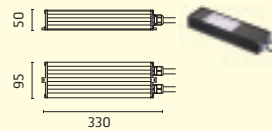

237
SPD: (SURGE PROTECTION DEVICE)
275Vac
MAXIMUM DISCHARGE CURRENT
10KA (8/20µs)
MAXIMUM OPERATING CURRENT 5A
SUITABLE FOR SERIES CONNETION
- IP66

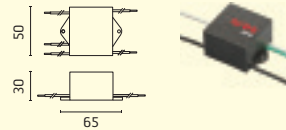

acc. code ▶	123	124	106	87	175	144	176	252	155	110	156	237
prod. code ▼												
115147112	•											•
115147113	•											•
115147114	•		1	2	2	3	3	3	10	13	18	
115147116		•										•
115147117		•										•
115147118		•	1	1	1	2	2	2	6	8	12	
115147119		•	1	1	1	2	2	2	6	8	12	
115147212	•											•
115147214	•		1	2	2	3	3	3	10	13	18	
115147216		•										•
115147218		•	1	1	1	2	2	2	6	8	12	









Max fixtures for each power supply (Vin 220÷240). Data in the chart are provided as a guide only. Please verify according to your installation.







ALICE

- Rectangular luminaire for installation in the wall – recessed.
- Configuration: die-cast aluminium structure, EN AB-47100 alloy (low copper content). Glass diffuser: sandblasted.
- Double layer coating for high resistance to corrosion: the aluminium components are painted with a double coat using powders which are compliant with QUALICOAT standards: a first layer of epoxy powder (with excellent chemical and mechanical resistance) and a second finishing layer of polyester powder (resistant to UV rays and atmospheric agents). The entire painting process of the aluminium fitting starts from components which have been sandblasted in advance to make the surface more porous and increase the adherence of the paint. Ares effects alkaline and acid washing to clean the surfaces completely, then rinses with demineralised water to remove any residue particles, subsequently a chemical conversion treatment is done to protect against rusting.
- Protection rating: IP65
- In compliance with EN 60598-1 standards
- Class of insulation: I, LED module: I, III
- Installation: wiring through two M16 plastic cable glands (4,5\times10mm) placed on the back side of the fitting. Outdoor use requires suitable flexible cables assuring the watertightness of the cable gland. Installation requires a dedicated box to be ordered separately.
- During the installation and the maintenance of the fixtures it is important to be careful and avoid damages on the paint coating. Damages on the coating exposed to outdoor conditions or water, could cause corrosion. Chemical substances affect the anticorrosion covering protection.

EU Regulation 874/2012 - Illumination equipment energy classes

	LED VERSION: Class A/A+/A++ Luminaire supplied with integrated LED modules that cannot be replaced
	
	
	FLUORESCENT VERSION: Class A TC-DEL/G24q-2
	
	FLUORESCENT VERSION: Class A/B TC-D/G24d-3
	
	HALOGEN VERSION: Class D QT32/E27



	Recessed wall fitting.		The fitting is equipped with 2 cable input.
	Remote device required.		Protection against impact. IK 08 - 5,00 joule

Alice - All Light



820123
 QT 32 60W E27
 Lamp max size: Ø40 mm H.125 mm

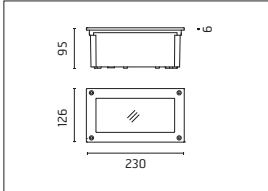
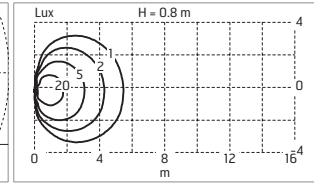
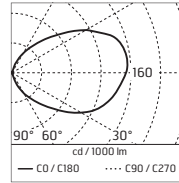

IP65

Alice - All Light

Light Source: Mid-Power LED / 8,8W / Potenza totale 11W / CRI>80 / 220±240V / Integral electronic power supply



8202005
 White 2700K
 lm LED 1114 ≠ lm OUTPUT 372

8202002
 White 3000K
 lm LED 1198 ≠ lm OUTPUT 400

8202001
 White 4000K
 lm LED 1258 ≠ lm OUTPUT 420

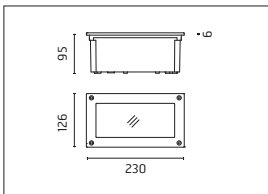

IP65

Alice - Horizontal Frame



820117
 QT 32 60W E27
 Lamp max size: Ø40 mm H.125 mm

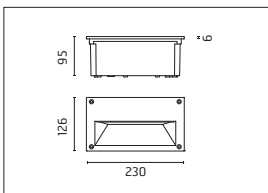
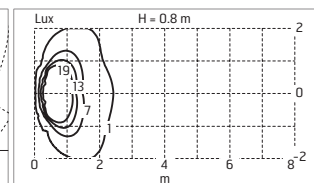
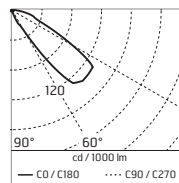

IP65

Alice - Horizontal Frame

Light Source: Power LED / CRI>80

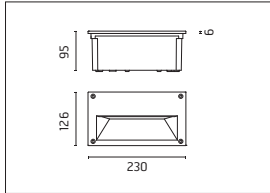

⊕ 5,5W / Potenza totale 8W / 100÷240V / Integral electronic power supply

8212527
White 2700K
lm LED 558 ≈ lm OUTPUT 131

8212517
White 3000K
lm LED 600 ≈ lm OUTPUT 141

8220917
White 4000K
lm LED 650 ≈ lm OUTPUT 153

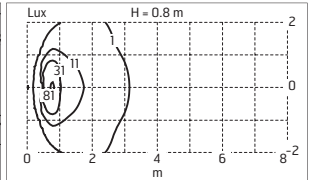
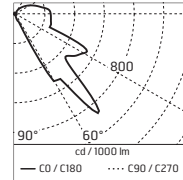

@ 4000K

◇ 5,5W / Total power 6,7W / 24Vdc / Remote electronic power supply to be ordered

8225927
White 2700K
lm LED 558 ≈ lm OUTPUT 131

8225917
White 3000K
lm LED 600 ≈ lm OUTPUT 141

8225817
White 4000K
lm LED 650 ≈ lm OUTPUT 153

IP65

Alice Vertical Frame

Light Source: Power LED / CRI>80

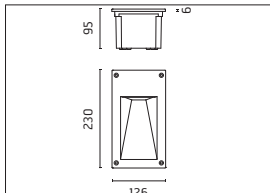

⊕ 3,3W / Potenza totale 6W / 100÷240V / Integral electronic power supply

8212228
White 2700K
lm LED 299 ≈ lm OUTPUT 68

8212218
White 3000K
lm LED 321 ≈ lm OUTPUT 73

8218218
White 4000K
lm LED 342 ≈ lm OUTPUT 81

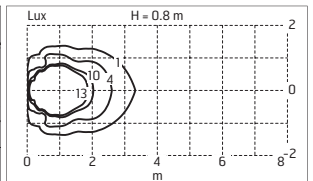
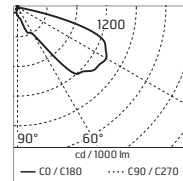

@ 4000K

◇ 3,3W / Total power 4,5W / 24Vdc / Remote electronic power supply to be ordered

8226228
White 2700K
lm LED 299 ≈ lm OUTPUT 68

8226218
White 3000K
lm LED 321 ≈ lm OUTPUT 73

8226118
White 4000K
lm LED 342 ≈ lm OUTPUT 81

IP65



Accessories: Alice

77
BOX FOR INSTALLATION
236 x 136 H 110mm

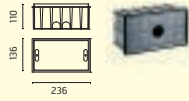

150
POWER SUPPLY DUAL FUNCTION
Vout 24Vdc: 8W/100±240V
Iout 350mA: 6x1W/100±240V
IP20 CLASS II SELV EQ.

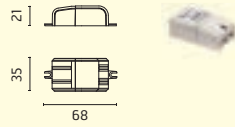

106
POWER SUPPLY DUAL FUNCTION
Vout 24Vdc: 8W/100±240V
Iout 350mA: 6x1W/100±240V
IP65 CLASS II SELV EQ.

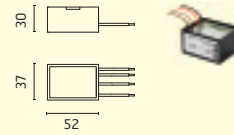

87
POWER SUPPLY 10W/110±240V -
24Vdc IP20 CLASS II SELV.

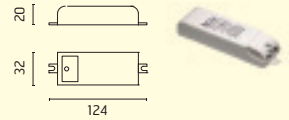

175
POWER SUPPLY 10W/110±240V -
24Vdc IP67 CLASS II SELV.

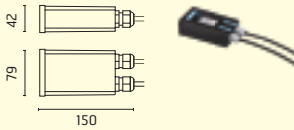

155
POWER SUPPLY 50W/120±240V -
24Vdc IP67 CLASS II SELV.

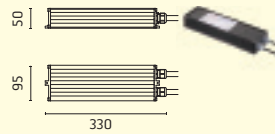

110
POWER SUPPLY 70W/220±240V -
24Vdc IP67 CLASS II SELV EQ.

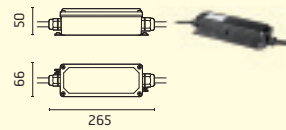

237
SPD: (SURGE PROTECTION DEVICE)
275Vac
MAXIMUM DISCHARGE CURRENT
10KA (8/20µs)
MAXIMUM OPERATING CURRENT 5A
SUITABLE FOR SERIES CONNECTION
- IP66

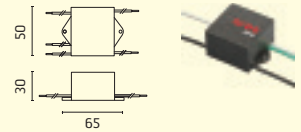







acc. code ▶	77	150	106	87	175	155	110	237
820117	•							
820123	•							
8202001	•							•
8202002	•							•
8202005	•							•
8212218	•							•
8212228	•							•
8212517	•							•
8212527	•							•
8218218	•							•
8220917	•							•
8225817	•			1	1	4	8	
8225917	•			1	1	4	8	
8225927	•			1	1	4	8	
8226118	•	1	1	2	2	7	14	
8226218	•	1	1	2	2	7	14	
8226228	•	1	1	2	2	7	14	

Max fixtures for each power supply (Vin 220±240).
Data in the chart are provided as a guide only.
Please verify according to your installation.



- Square luminaire for installation in the wall – recessed.
- Configuration: die-cast aluminium structure, EN AB-47100 alloy (low copper content). Glass diffuser: transparent or sandblasted, fixed to the frame through a robotic gluing system.
- Double layer coating for high resistance to corrosion: the aluminium components are painted with a double coat using powders which are compliant with QUALICOAT standards: a first layer of epoxy powder (with excellent chemical and mechanical resistance) and a second finishing layer of polyester powder (resistant to UV rays and atmospheric agents). The entire painting process of the aluminium fitting starts from components which have been sandblasted in advance to make the surface more porous and increase the adherence of the paint. Ares effects alkaline and acid washing to clean the surfaces completely, then rinses with demineralised water to remove any residue particles, subsequently a chemical conversion treatment is done to protect against rusting.
- Protection rating: IP54
- In compliance with EN 60598-1 standards
- Class of insulation: mains: I, LED module: II, III
- Installation: MiniAlfia is equipped with two cable holders for three single wires. Alfia is equipped with two cable holders for 5\times10mm cables. Outdoor use requires suitable flexible cables assuring the watertightness of the cable holders. Installation requires a dedicated box to be ordered separately.
- During the installation and the maintenance of the fixtures it is important to be careful and avoid damages on the paint coating. Damages on the coating exposed to outdoor conditions or water, could cause corrosion. Chemical substances affect the anticorrosion covering protection.

EU Regulation 874/2012 - Illumination equipment energy classes

	LED VERSION: Class A/A+/A++ Luminaire supplied with integrated LED modules that cannot be replaced
	
	
	METAL HALIDE VERSION: Class A+ HIT-CE/G12
	FLUORESCENT VERSION: Class A TC-DEL/G24d-3
	HALOGEN VERSION: Class D QT32/E27 QT14/G9

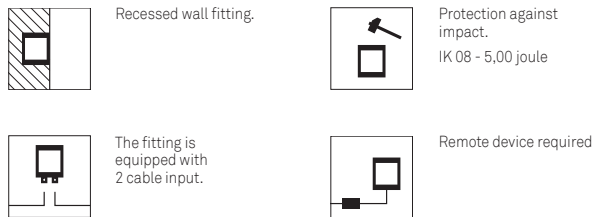

MiniAlfia - Transparent Glass

Light Source: Power LED / CRI>80



□ 2,2W / Total power 4W / 100÷240V / Integral electronic power supply

816420
White 2700K
lm LED 223 ≠ lm OUTPUT 151

816400
White 3000K
lm LED 240 ≠ lm OUTPUT 162

8121300
White 4000K
lm LED 260 ≠ lm OUTPUT 175

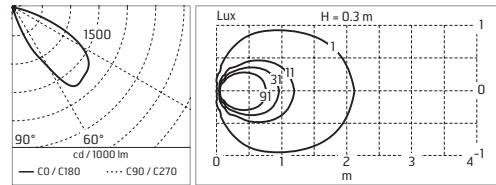

@ 4000K

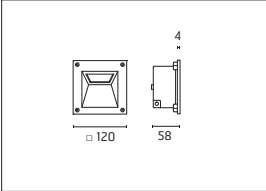

◇ 2,2W / Total power 3,1W / 24Vdc / Remote electronic power supply to be ordered

8121620
White 2700K
lm LED 223 ≠ lm OUTPUT 151

8121600
White 3000K
lm LED 240 ≠ lm OUTPUT 162

8121500
White 4000K
lm LED 260 ≠ lm OUTPUT 175

IP67

Alfia - Transparent Glass

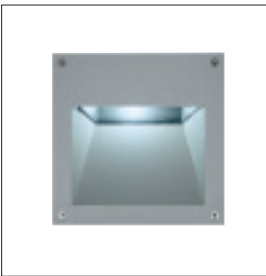

820100
QT 32 100W E27
Lamp max size: Ø40 mm H.150 mm

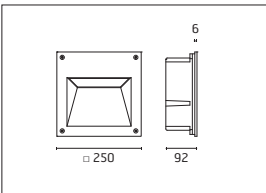
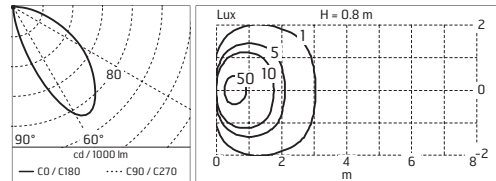

IP54

Alfia - Sandblasted Glass

Light Source: Mid-Power LED / 8,8W / Total power 11W / CRI>80 / 220÷240V / Integral electronic power supply



822805
White 2700K
lm LED 1144 ≈ lm OUTPUT 373

822801
White 3000K
lm LED 1230 ≈ lm OUTPUT 401

822800
White 4000K
lm LED 1291 ≈ lm OUTPUT 421

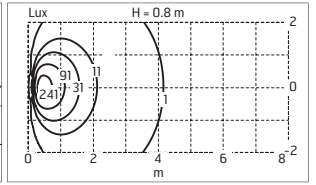
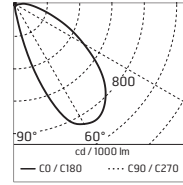

@ 4000K

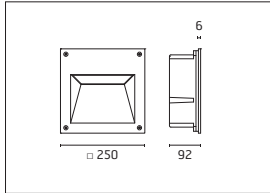

IP54   



Accessories: Alfa

59
BOX FOR INSTALLATION
122 x 122 H 61mm

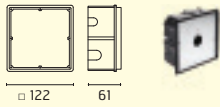

60
BOX FOR INSTALLATION
252 x 252 H 110mm

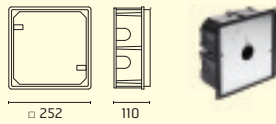

150
POWER SUPPLY DUAL FUNCTION
Vout 24Vdc: 8W/100÷240V
Iout 350mA: 6x1W/100÷240V
IP20 CLASS II SELV EQ.

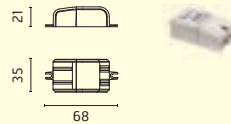

106
POWER SUPPLY DUAL FUNCTION
Vout 24Vdc: 8W/100÷240V
Iout 350mA: 6x1W/100÷240V
IP65 CLASS II SELV EQ.

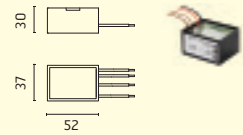

87
POWER SUPPLY 10W/110÷240V -
24Vdc IP20 CLASS II SELV.

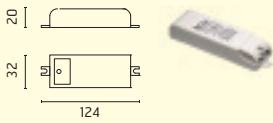

175
POWER SUPPLY 10W/110÷240V -
24Vdc IP67 CLASS II SELV.

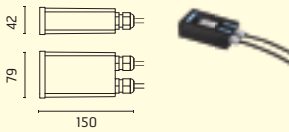

147
POWER SUPPLY 20W/220÷240V -
24Vdc IP67 CLASS II SELV.

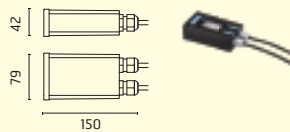

110
POWER SUPPLY 70W/220÷240V -
24Vdc IP67 CLASS II SELV EQ.

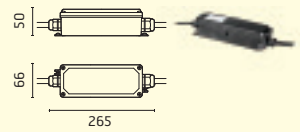

237
SPD: (SURGE PROTECTION DEVICE)
275Vac
MAXIMUM DISCHARGE CURRENT
10KA (8/20µs)
MAXIMUM OPERATING CURRENT 5A
SUITABLE FOR SERIES CONNEC-
TION - IP66

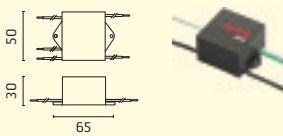

acc. code ▶	59	60	150	106	87	175	147	110	237
816400	•								•
820100		•							
822800		•							•
822801		•							•
8121300	•								•
8121500	•		1	1	2	2	7	15	
8121600	•		1	1	2	2	7	15	
8121620	•		1	1	2	2	7	15	
816420	•								•
822805		•							•

Max fixtures for each power supply (Vin 220÷240).Data in the chart are provided as a guide only.Please verify according to your installation.



- Round luminaire for installation in the ceiling – recessed.
- Configuration: die-cast aluminium structure, EN AB-47100 alloy (low copper content) and AISI 316L stainless steel outer frame (raw or painted in white). Glass diffuser: textured with silkscreen border, fixed to the aluminium structure through a robotic gluing system.
- Double layer coating for high resistance to corrosion: the aluminium components are painted with a double coat using powders which are compliant with QUALICOAT standards: a first layer of epoxy powder (with excellent chemical and mechanical resistance) and a second finishing layer of polyester powder (resistant to UV rays and atmospheric agents). The entire painting process of the aluminium fitting starts from components which have been sandblasted in advance to make the surface more porous and increase the adherence of the paint. Ares effects alkaline and acid washing to clean the surfaces completely, then rinses with demineralised water to remove any residue particles, subsequently a chemical conversion treatment is done to protect against rusting.
- Protection rating: IP66
- In compliance with EN60598-1 standards
- Class of insulation: II; version 230V: I
- Installation: the luminaire is equipped with a watertight M12 screw-connector providing optimal insulation against water ingress. 220-240V version: the luminaire is supplied with a remote IP67 electronic power supply kit equipped with a piece of cable with screw connector towards the luminaire and a piece of cable to be used for wiring. 230V direct feeding: the luminaire is equipped with a piece of cable with a 2-way connector for 3-conductor cables (H2O STOP) for an easy-to-make connection. Outdoor use requires suitable flexible cables assuring the watertightness of the cable gland / connector.
- We recommend the use of a connection system with a protection degree greater than or equal to the protection degree of the luminaire.
- During the installation and the maintenance of the fixtures it is important to be careful and avoid damages on the paint coating.
Damages on the coating exposed to outdoor conditions or water, could cause corrosion.
Chemical substances affect the anticorrosion covering protection.

EU Regulation 874/2012 - Illumination equipment energy classes



LED VERSION:
Class A/A+/A++
Luminaire supplied
with integrated LED modules
that cannot be replaced



Recessed ceiling
fitting



Protection against
water ingress
from the cable



Pre-wired with
approx 250mm of
cable



Protection against
impact
IK 06 - 1,00 joule (Leila105-135)
IK 07 - 2,00 joule (Leila165-225)

Leila105 - Stainless Steel Frame - 20°

Light Source: CoB LED / 9W / Total power 12W / CRI>80 / 220+240V / Kit with remote electronic power supply included



536103
White 2700K
lm LED 1143 ≈ lm OUTPUT 646

536003
White 3000K
lm LED 1229 ≈ lm OUTPUT 695

536002
White 4000K
lm LED 1278 ≈ lm OUTPUT 723

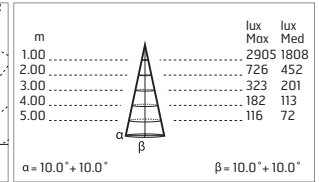
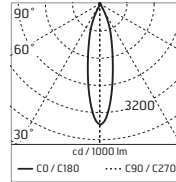

@ 4000K

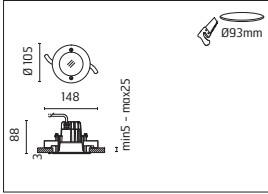

Dimmable on request

IP66

Leila105 - Stainless Steel Frame - 45°

Light Source: CoB LED / 9W / Total power 12W / CRI>80 / 220+240V / Kit with remote electronic power supply included



536106
White 2700K
lm LED 1143 ≈ lm OUTPUT 802

536006
White 3000K
lm LED 1229 ≈ lm OUTPUT 862

536005
White 4000K
lm LED 1278 ≈ lm OUTPUT 896

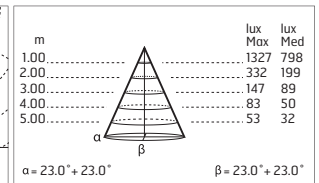
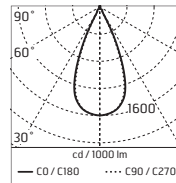

@ 4000K

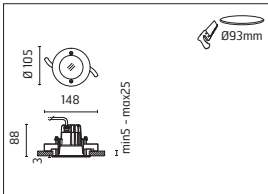

Dimmable on request

IP66

Leila105 - Painted Frame - 20°

Light Source: CoB LED / 9W / Total power 12W / CRI>80 / 220+240V / Kit with remote electronic power supply included



536109
White 2700K
lm LED 1143 ≈ lm OUTPUT 646

536009
White 3000K
lm LED 1229 ≈ lm OUTPUT 695

536008
White 4000K
lm LED 1278 ≈ lm OUTPUT 723

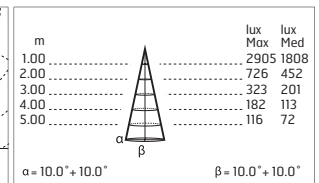
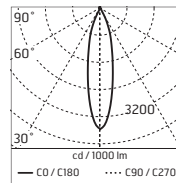

@ 4000K

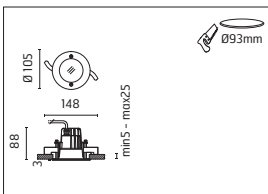

Dimmable on request

IP66

Leila105 - Painted Frame - 45°

Light Source: CoB LED / 9W / Total power 12W / CRI>80 / 220÷240V / Kit with remote electronic power supply included



536112
White 2700K
lm LED 1143 ≠ lm OUTPUT 802

536012
White 3000K
lm LED 1229 ≠ lm OUTPUT 862

536011
White 4000K
lm LED 1278 ≠ lm OUTPUT 896

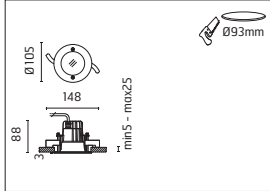

Dimmable on request

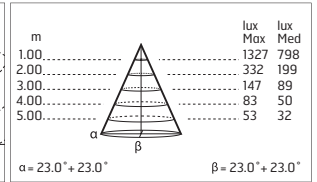
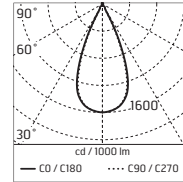

@ 4000K

IP66

Leila135 - Stainless Steel Frame - 20°

Light Source: CoB LED / 12W / Total power 16W / CRI>80 / 220÷240V / Kit with remote electronic power supply included



536114
536114-300 Dimmable Dali
536114-310 Dimmable 1-10
White 2700K
lm LED 1622 lm OUTPUT 1072

536014
536014-300 Dimmable Dali
536014-310 Dimmable 1-10
White 3000K
lm LED 1744 ≠ lm OUTPUT 1153

536013
536013-300 Dimmable Dali
536013-310 Dimmable 1-10
White 4000K
lm LED 1829 ≠ lm OUTPUT 1210

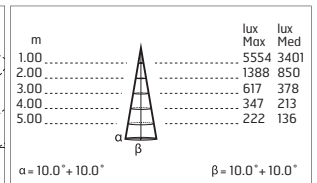
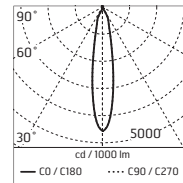
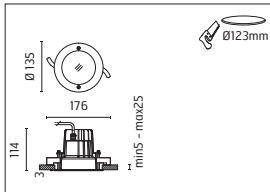

@ 4000K

IP66

Leila135 - Stainless Steel Frame - 40°

Light Source: CoB LED / 12W / Total power 16W / CRI>80 / 220÷240V / Kit with remote electronic power supply included



536116
536116-300 Dimmable Dali
536116-310 Dimmable 1-10
White 2700K
lm LED 1622 lm OUTPUT 1093

536016
536016-300 Dimmable Dali
536016-310 Dimmable 1-10
White 3000K
lm LED 1744 ≠ lm OUTPUT 1175

536015
536015-300 Dimmable Dali
536015-310 Dimmable 1-10
White 4000K
lm LED 1829 ≠ lm OUTPUT 1232

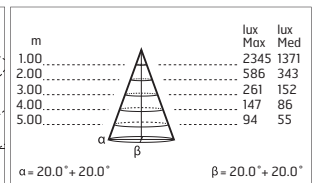
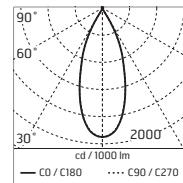
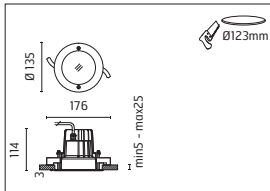

@ 4000K

IP66

Leila135 - Stainless Steel Frame - Asymmetric Optic 12° - 20°

Light Source: CoB LED / 12W / Total power 16W / CRI>80 / 220÷240V / Kit with remote electronic power supply included



536118
536118-300 Dimmable Dali
536118-310 Dimmable 1-10
 White 2700K
 lm LED 1535 lm OUTPUT 908

536018
536018-300 Dimmable Dali
536018-310 Dimmable 1-10
 White 3000K
 lm LED 1650 ≠ lm OUTPUT 976

536017
536017-300 Dimmable Dali
536017-310 Dimmable 1-10
 White 4000K
 lm LED 1716 ≠ lm OUTPUT 1015

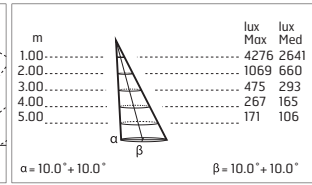
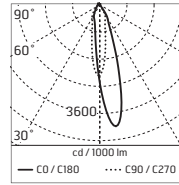

@ 4000K

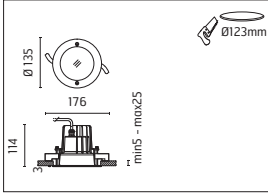

IP66

Leila135 - Stainless Steel Frame - Asymmetric Optic 12° - 45°

Light Source: CoB LED / 14W / Total power 16W / CRI>80 / 220÷240V / Kit with remote electronic power supply included



536120
536120-300 Dimmable Dali
536120-310 Dimmable 1-10
 White 2700K
 lm LED 1535 lm OUTPUT 1126

536020
536020-300 Dimmable Dali
536020-310 Dimmable 1-10
 White 3000K
 lm LED 1650 ≠ lm OUTPUT 1211

536019
536019-300 Dimmable Dali
536019-310 Dimmable 1-10
 White 4000K
 lm LED 1716 ≠ lm OUTPUT 1259

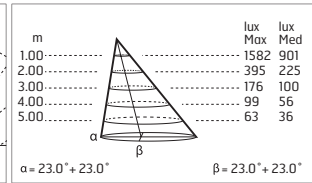
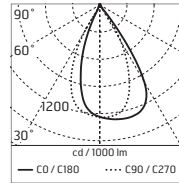

@ 4000K

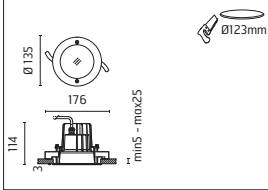

IP66

Leila135 - Painted Frame - 20°

Light Source: CoB LED / 12W / Total power 16W / CRI>80 / 220÷240V / Kit with remote electronic power supply included



536122
536122-300 Dimmable Dali
536122-310 Dimmable 1-10
 White 2700K
 lm LED 1622 ≠ lm OUTPUT 1072

536022
536022-300 Dimmable Dali
536022-310 Dimmable 1-10
 White 3000K
 lm LED 1744 ≠ lm OUTPUT 1153

536021
536021-300 Dimmable Dali
536021-310 Dimmable 1-10
 White 4000K
 lm LED 1829 ≠ lm OUTPUT 1210

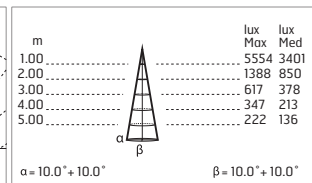
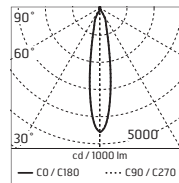

@ 4000K

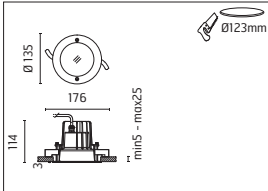

IP66

Leila135 - Painted Frame - 40°

Light Source: CoB LED / 12W / Total power 16W / CRI>80 / 220÷240V / Kit with remote electronic power supply included



536124
536124-300 Dimmable Dali
536124-310 Dimmable 1-10
 White 2700K
 lm LED 1622 ≠ lm OUTPUT 1093

536024
536024-300 Dimmable Dali
536024-310 Dimmable 1-10
 White 3000K
 lm LED 1744 ≠ lm OUTPUT 1175

536023
536023-300 Dimmable Dali
536023-310 Dimmable 1-10
 White 4000K
 lm LED 1829 ≠ lm OUTPUT 1232

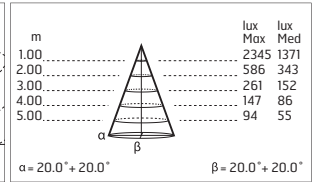
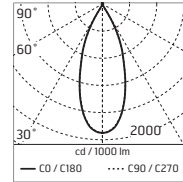
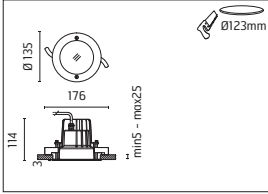

@ 4000K

IP66

Leila135 - Painted Frame - Asymmetric Optic 12° - 20°

Light Source: CoB LED / 14W / Total power 16W / CRI>80 / 220÷240V / Kit with remote electronic power supply included



536126
536126-300 Dimmable Dali
536126-310 Dimmable 1-10
 White 2700K
 lm LED 1535 ≠ lm OUTPUT 908

536026
536026-300 Dimmable Dali
536026-310 Dimmable 1-10
 White 3000K
 lm LED 1650 ≠ lm OUTPUT 976

536025
536025-300 Dimmable Dali
536025-310 Dimmable 1-10
 White 4000K
 lm LED 1716 ≠ lm OUTPUT 1015

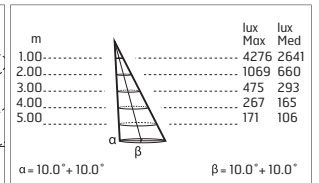
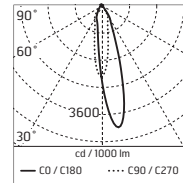
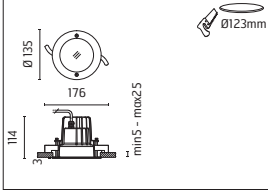

@ 4000K

IP66

Leila135 - Painted Frame - Asymmetric Optic 12° - 45°

Light Source: CoB LED / 12W / Total power 16W / CRI>80 / 220÷240V / Kit with remote electronic power supply included



536128
536128-300 Dimmable Dali
536128-310 Dimmable 1-10
 White 2700K
 lm LED 1535 ≠ lm OUTPUT 1126

536028
536028-300 Dimmable Dali
536028-310 Dimmable 1-10
 White 3000K
 lm LED 1650 ≠ lm OUTPUT 1211

536027
536027-300 Dimmable Dali
536027-310 Dimmable 1-10
 White 4000K
 lm LED 1716 ≠ lm OUTPUT 1259

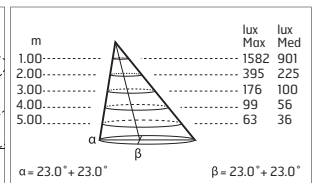
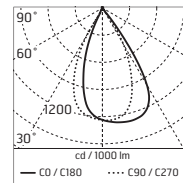
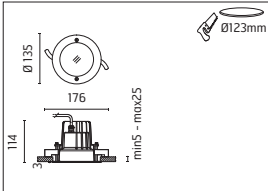

@ 4000K

IP66

Leila165 - Stainless Steel Frame - 20°

Light Source: CoB LED / 26W / Total power 30W / CRI>80 / 220÷240V / Kit with remote electronic power supply included



536130
536130-300 Dimmable Dali
536130-310 Dimmable 1-10
 White 2700K
 lm LED 3022 ≠ lm OUTPUT 2566

536030
536030-300 Dimmable Dali
536030-310 Dimmable 1-10
 White 3000K
 lm LED 3249 ≠ lm OUTPUT 2759

536029
536029-300 Dimmable Dali
536029-310 Dimmable 1-10
 White 4000K
 lm LED 3408 ≠ lm OUTPUT 2894

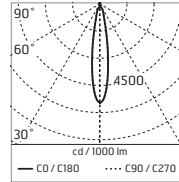

m	lux	
	Max	Med
1.00	15778	9824
2.00	3945	2456
3.00	1753	1092
4.00	986	614
5.00	631	393

$\alpha = 10.0^\circ + 10.0^\circ$ $\beta = 10.0^\circ + 10.0^\circ$

@ 4000K

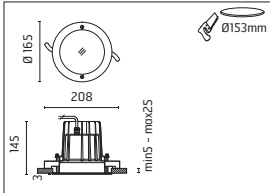

IP66

Leila165 - Stainless Steel Frame - 45°

Light Source: CoB LED / 26W / Total power 30W / CRI>80 / 220÷240V / Kit with remote electronic power supply included



536132
536132-300 Dimmable Dali
536132-310 Dimmable 1-10
 White 2700K
 lm LED 3022 ≠ lm OUTPUT 2509

536032
536032-300 Dimmable Dali
536032-310 Dimmable 1-10
 White 3000K
 lm LED 3249 ≠ lm OUTPUT 2698

536031
536031-300 Dimmable Dali
536031-310 Dimmable 1-10
 White 4000K
 lm LED 3408 ≠ lm OUTPUT 2830

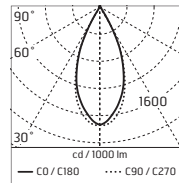

m	lux	
	Max	Med
1.00	4991	2812
2.00	1248	703
3.00	555	312
4.00	312	176
5.00	200	112

$\alpha = 22.0^\circ + 22.0^\circ$ $\beta = 22.0^\circ + 22.0^\circ$

@ 4000K

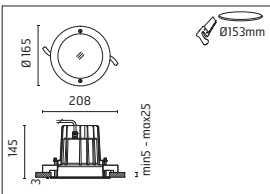

IP66

Leila165 - Stainless Steel Frame - Asymmetric Optic 12° - 30°

Light Source: CoB LED / 26W / Total power 30W / CRI>80 / 220÷240V / Kit with remote electronic power supply included



536134
536134-300 Dimmable Dali
536134-310 Dimmable 1-10
 White 2700K
 lm LED 3022 ≠ lm OUTPUT 2096

536034
536034-300 Dimmable Dali
536034-310 Dimmable 1-10
 White 3000K
 lm LED 3249 ≠ lm OUTPUT 2254

536033
536033-300 Dimmable Dali
536033-310 Dimmable 1-10
 White 4000K
 lm LED 3408 ≠ lm OUTPUT 2364

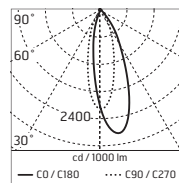

m	lux	
	Max	Med
1.00	6531	3984
2.00	1633	996
3.00	726	443
4.00	408	249
5.00	261	159

$\alpha = 15.0^\circ + 15.0^\circ$ $\beta = 15.0^\circ + 15.0^\circ$

@ 4000K

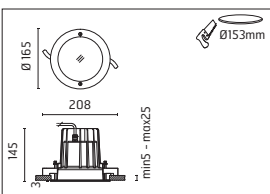

IP66

Leila165 - Stainless Steel Frame - Asymmetric Optic 12° - 40°

Light Source: CoB LED / 26W / Total power 30W / CRI>80 / 220÷240V / Kit with remote electronic power supply included



536136
536136-300 Dimmable Dali
536136-310 Dimmable 1-10
 White 2700K
 lm LED 3022 ≠ lm OUTPUT 2007

536036
536036-300 Dimmable Dali
536036-310 Dimmable 1-10
 White 3000K
 lm LED 3249 ≠ lm OUTPUT 2158

536035
536035-300 Dimmable Dali
536035-310 Dimmable 1-10
 White 4000K
 lm LED 3408 ≠ lm OUTPUT 2263

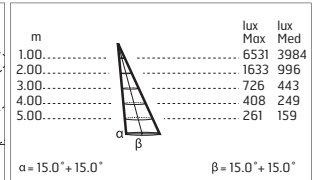
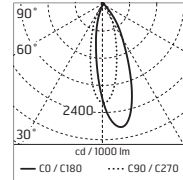
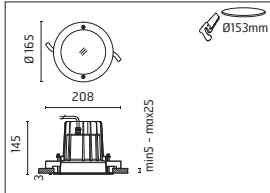

@ 4000K

IP66

Leila165 - Painted Frame - 20°

Light Source: CoB LED / 26W / Total power 30W / CRI>80 / 220÷240V / Kit with remote electronic power supply included



536138
536138-300 Dimmable Dali
536138-310 Dimmable 1-10
 White 2700K
 lm LED 3022 ≠ lm OUTPUT 2566

536038
536038-300 Dimmable Dali
536038-310 Dimmable 1-10
 White 3000K
 lm LED 3249 ≠ lm OUTPUT 2759

536037
536037-300 Dimmable Dali
536037-310 Dimmable 1-10
 White 4000K
 lm LED 3408 ≠ lm OUTPUT 2894

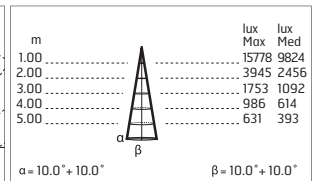
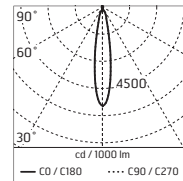
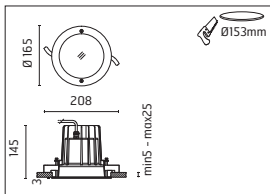

@ 4000K

IP66

Leila165 - Painted Frame - 45°

Light Source: CoB LED / 26W / Total power 30W / CRI>80 / 220÷240V / Kit with remote electronic power supply included



536140
536140-300 Dimmable Dali
536140-310 Dimmable 1-10
 White 2700K
 lm LED 3022 ≠ lm OUTPUT 2509

536040
536040-300 Dimmable Dali
536040-310 Dimmable 1-10
 White 3000K
 lm LED 3249 ≠ lm OUTPUT 2698

536039
536039-300 Dimmable Dali
536039-310 Dimmable 1-10
 White 4000K
 lm LED 3408 ≠ lm OUTPUT 2830

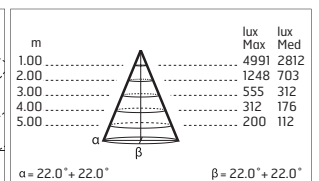
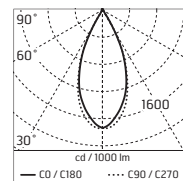
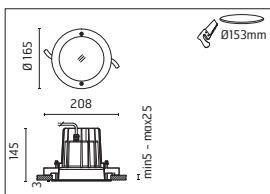

@ 4000K

IP66

Leila165 - Painted Frame - Asymmetric Optic 12° - 30°

Light Source: CoB LED / 26W / Total power 30W / CRI>80 / 220÷240V / Kit with remote electronic power supply included



536142
536142-300 Dimmable Dali
536142-310 Dimmable 1-10
 White 2700K
 lm LED 3022 ≠ lm OUTPUT 2096

536042
536042-300 Dimmable Dali
536042-310 Dimmable 1-10
 White 3000K
 lm LED 3249 ≠ lm OUTPUT 2254

536041
536041-300 Dimmable Dali
536041-310 Dimmable 1-10
 White 4000K
 lm LED 3408 ≠ lm OUTPUT 2364

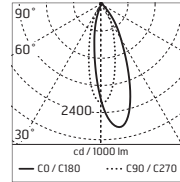
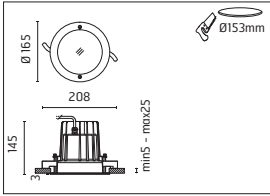

m	lux	
	Max	Med
1.00	6531	3984
2.00	1633	996
3.00	726	443
4.00	408	249
5.00	261	159

$\alpha = 15.0^\circ + 15.0^\circ$ $\beta = 15.0^\circ + 15.0^\circ$

@ 4000K

IP66

Leila165 - Painted Frame - Asymmetric Optic 12° - 40°

Light Source: CoB LED / 26W / Total power 30W / CRI>80 / 220÷240V / Kit with remote electronic power supply included



536144
536144-300 Dimmable Dali
536144-310 Dimmable 1-10
 White 2700K
 lm LED 3022 ≠ lm OUTPUT 2007

536044
536044-300 Dimmable Dali
536044-310 Dimmable 1-10
 White 3000K
 lm LED 3249 ≠ lm OUTPUT 2158

536043
536043-300 Dimmable Dali
536043-310 Dimmable 1-10
 White 4000K
 lm LED 3408 ≠ lm OUTPUT 2263

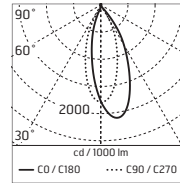
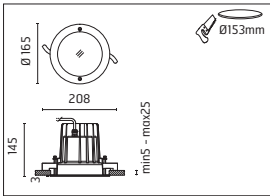

m	lux	
	Max	Med
1.00	4624	2705
2.00	1156	676
3.00	514	301
4.00	289	169
5.00	185	108

$\alpha = 20.0^\circ + 20.0^\circ$ $\beta = 20.0^\circ + 20.0^\circ$

@ 4000K

IP66

Leila225 - Stainless Steel Frame - 45°

Light Source: CoB LED / 38W / Total power 43W / CRI>80 / 220÷240V / Kit with remote electronic power supply included



536148
536148-300 Dimmable Dali
536148-310 Dimmable 1-10
 White 2700K
 lm LED 4665 ≠ lm OUTPUT 3076

536048
536048-300 Dimmable Dali
536048-310 Dimmable 1-10
 White 3000K
 lm LED 5016 ≠ lm OUTPUT 3308

536047
536047-300 Dimmable Dali
536047-310 Dimmable 1-10
 White 4000K
 lm LED 5143 ≠ lm OUTPUT 3392

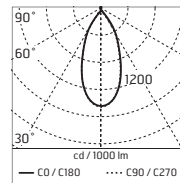
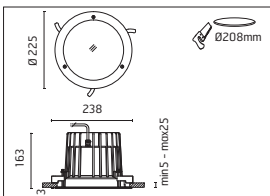

m	lux	
	Max	Med
1.00	4851	2776
2.00	1213	694
3.00	539	308
4.00	303	174
5.00	194	111

$\alpha = 22.0^\circ + 22.0^\circ$ $\beta = 22.0^\circ + 22.0^\circ$

@ 4000K

IP66

Leila225 - Stainless Steel Frame - Asymmetric Optic 12° - 20°

Light Source: CoB LED / 38W / Total power 43W / CRI>80 / 220±240V / Kit with remote electronic power supply included



536150
536150-300 Dimmable Dali
536150-310 Dimmable 1-10
 White 2700K
 lm LED 4665 ≠ lm OUTPUT 3028

536050
536050-300 Dimmable Dali
536050-310 Dimmable 1-10
 White 3000K
 lm LED 5016 ≠ lm OUTPUT 3256

536049
536049-300 Dimmable Dali
536049-310 Dimmable 1-10
 White 4000K
 lm LED 5143 ≠ lm OUTPUT 3338

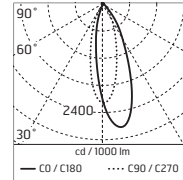
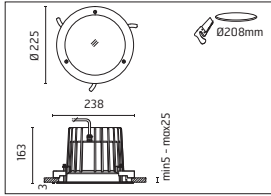

m	lux	
	Max	Med
1.00	6531	3984
2.00	1633	996
3.00	726	443
4.00	408	249
5.00	261	159

$\alpha = 15.0^\circ + 15.0^\circ$ $\beta = 15.0^\circ + 15.0^\circ$

@ 4000K

IP66

Leila225 - Stainless Steel Frame - Asymmetric Optic 12° - 40°

Light Source: CoB LED / 38W / Total power 43W / CRI>80 / 220±240V / Kit with remote electronic power supply included



536152
536152-300 Dimmable Dali
536152-310 Dimmable 1-10
 White 2700K
 lm LED 4665 ≠ lm OUTPUT 2990

536052
536052-300 Dimmable Dali
536052-310 Dimmable 1-10
 White 3000K
 lm LED 5016 ≠ lm OUTPUT 3215

536051
536051-300 Dimmable Dali
536051-310 Dimmable 1-10
 White 4000K
 lm LED 5143 ≠ lm OUTPUT 3297

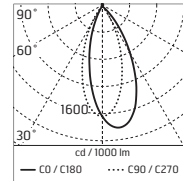
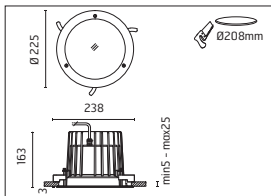

m	lux	
	Max	Med
1.00	5899	3353
2.00	1475	838
3.00	655	373
4.00	369	210
5.00	236	134

$\alpha = 20.0^\circ + 20.0^\circ$ $\beta = 20.0^\circ + 20.0^\circ$

@ 4000K

IP66

Leila225 - Painted Frame - 45°

Light Source: CoB LED / 38W / Total power 43W / CRI>80 / 220±240V / Kit with remote electronic power supply included



536156
536156-300 Dimmable Dali
536156-310 Dimmable 1-10
 White 2700K
 lm LED 4665 ≠ lm OUTPUT 3076

536056
536056-300 Dimmable Dali
536056-310 Dimmable 1-10
 White 3000K
 lm LED 5016 ≠ lm OUTPUT 3308

536055
536055-300 Dimmable Dali
536055-310 Dimmable 1-10
 White 4000K
 lm LED 5143 ≠ lm OUTPUT 3392

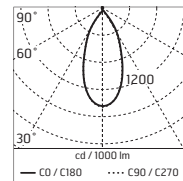
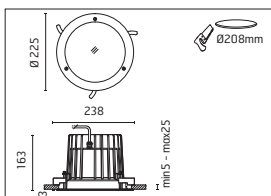

m	lux	
	Max	Med
1.00	4851	2776
2.00	1213	694
3.00	539	308
4.00	303	174
5.00	194	111

$\alpha = 22.0^\circ + 22.0^\circ$ $\beta = 22.0^\circ + 22.0^\circ$

@ 4000K

IP66

Leila225 - Painted Frame - Asymmetric Optic 12° - 20°

Light Source: CoB LED / 38W / Total power 43W / CRI>80 / 220÷240V / Kit with remote electronic power supply included



536158
536158-300 Dimmable Dali
536158-310 Dimmable 1-10
 White 2700K
 lm LED 4665 ≠ lm OUTPUT 3028

536058
536058-300 Dimmable Dali
536058-310 Dimmable 1-10
 White 3000K
 lm LED 5016 ≠ lm OUTPUT 3256

536057
536057-300 Dimmable Dali
536057-310 Dimmable 1-10
 White 4000K
 lm LED 5143 ≠ lm OUTPUT 3338

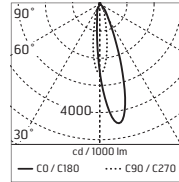
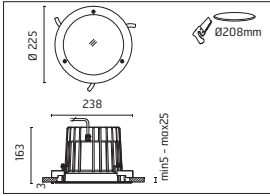

m	lux	
	Max	Med
1.00	14536	8961
2.00	3634	2240
3.00	1615	996
4.00	908	560
5.00	581	358

@ 4000K

IP66

Leila225 - Painted Frame - Asymmetric Optic 12° - 40°

Light Source: CoB LED / 38W / Total power 43W / CRI>80 / 220÷240V / Kit with remote electronic power supply included



536160
536160-300 Dimmable Dali
536160-310 Dimmable 1-10
 White 2700K
 lm LED 4665 ≠ lm OUTPUT 2990

536060
536060-300 Dimmable Dali
536060-310 Dimmable 1-10
 White 3000K
 lm LED 5143 ≠ lm OUTPUT 3292

536059
536059-300 Dimmable Dali
536059-310 Dimmable 1-10
 White 4000K
 lm LED 5143 ≠ lm OUTPUT 3292

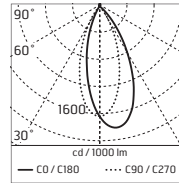
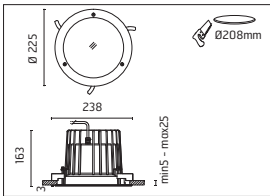

m	lux	
	Max	Med
1.00	5899	3353
2.00	1475	838
3.00	655	373
4.00	369	210
5.00	236	134

@ 4000K

IP66

Leila135 - Stainless Steel Frame - 30° - Direct 230V

Light Source: CoB LED / 10W / Total power 12W / CRI>80 / 220÷230V / LED module set up to work directly connected to the mains

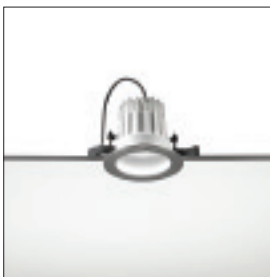

536061
 White 3000K
 lm LED 951 ≠ lm OUTPUT 687

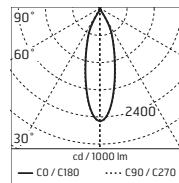
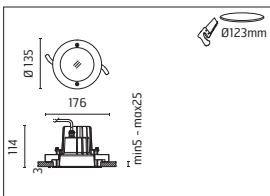

m	lux	
	Max	Med
1.00	1720	1030
2.00	430	258
3.00	191	114
4.00	108	64
5.00	69	41

IP66

Leila135 - Painted Frame - 30° - Direct 230V

Light Source: CoB LED / 10W / Total power 12W / CRI>80 / 220÷230V / LED module set up to work directly connected to the mains



536062
White 3000K
lm LED 951 \approx lm OUTPUT 687

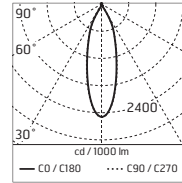

m	lux	
	Max	Med
1.00	1720	1030
2.00	430	258
3.00	191	114
4.00	108	64
5.00	69	41

$\alpha = 15.0^\circ + 15.0^\circ$ $\beta = 15.0^\circ + 15.0^\circ$

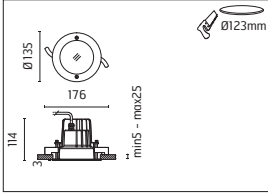

IP66

Leila165 - Stainless Steel Frame - 50° - Direct 230V

Light Source: CoB LED / 22W / Total power 24W / CRI>80 / 220÷230V / LED module set up to work directly connected to the mains



536063
White 3000K
lm LED 2303 \approx lm OUTPUT 1646

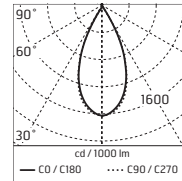

m	lux	
	Max	Med
1.00	2680	1527
2.00	670	382
3.00	298	170
4.00	167	95
5.00	107	61

$\alpha = 24.0^\circ + 24.0^\circ$ $\beta = 24.0^\circ + 24.0^\circ$

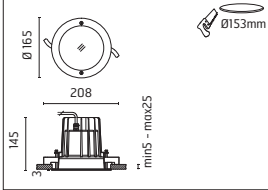

IP66

Leila165 - Painted Frame - 50° - Direct 230V

Light Source: CoB LED / 22W / Total power 24W / CRI>80 / 220÷230V / LED module set up to work directly connected to the mains



536064
White 3000K
lm LED 2303 \approx lm OUTPUT 1646

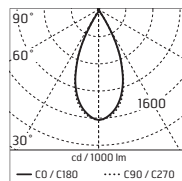

m	lux	
	Max	Med
1.00	2680	1527
2.00	670	382
3.00	298	170
4.00	167	95
5.00	107	61

$\alpha = 24.0^\circ + 24.0^\circ$ $\beta = 24.0^\circ + 24.0^\circ$

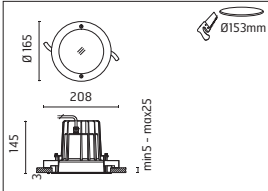

IP66

Accessories: Leila

196
METAL INSTALLATION BOX FOR
CONCRETE CEILING 246 x 201 H
105mm

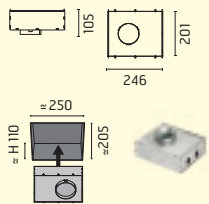

197
METAL INSTALLATION BOX FOR
CONCRETE CEILING 296 x 201 H
125mm

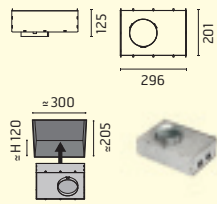

198
METAL INSTALLATION BOX FOR
CONCRETE CEILING 326 x 201 H
155mm

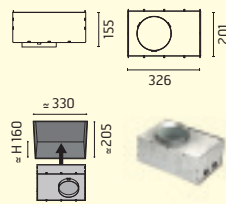

199
METAL INSTALLATION BOX FOR
CONCRETE CEILING 406 x 281 H
175mm

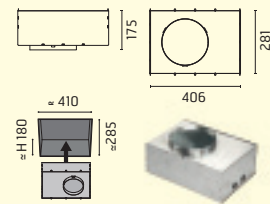

215
3/4 WAY TERMINAL BLOCK 4 POLES
IP68 H₂O STOP (Ø5,5÷12mm CABLE)

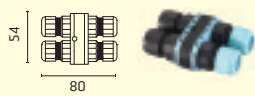

236
2 WAY TERMINAL BLOCK 4 POLES
IP68 H₂O STOP (Ø5,5÷12mm CABLE)

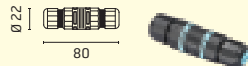

237
SPD: (SURGE PROTECTION DEVICE)
275Vac
MAXIMUM DISCHARGE CURRENT
10KA (8/20µs)
MAXIMUM OPERATING CURRENT 5A
SUITABLE FOR SERIES CONNEC-
TION - IP66

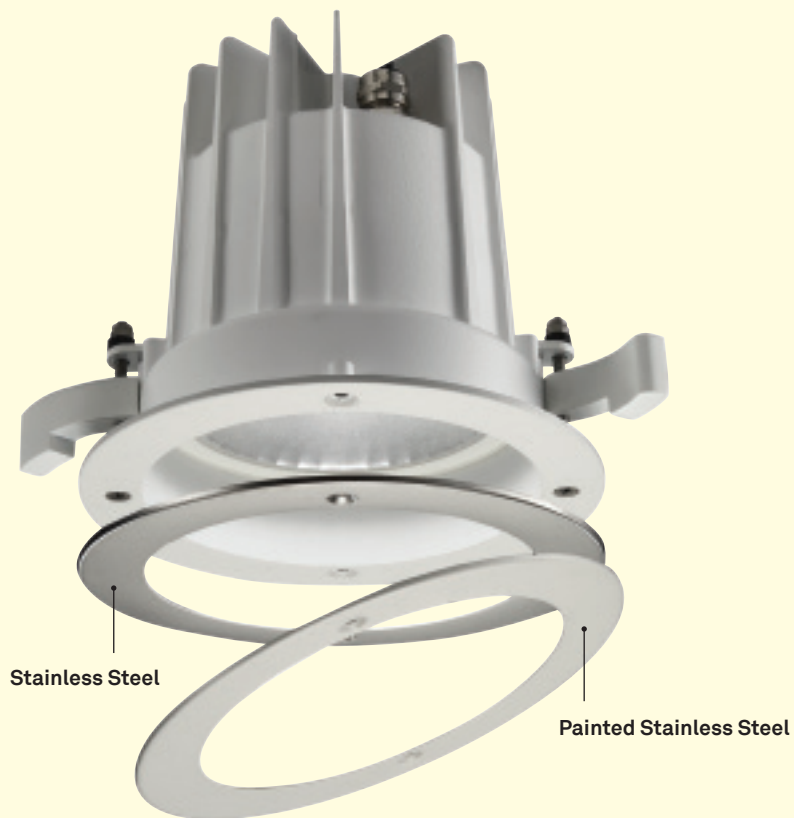
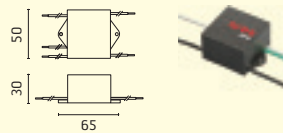

Accessories: Leila

acc. code ▶ prod. code ▼	dimmi DALI	dimmi 1-10	196	197	198	199	215	236	237
536002			•				•	•	•
536003			•				•	•	•
536005			•				•	•	•
536006			•				•	•	•
536008			•				•	•	•
536009			•				•	•	•
536011			•				•	•	•
536012			•				•	•	•
536013	-300	-310		•			•	•	•
536014	-300	-310		•			•	•	•
536015	-300	-310		•			•	•	•
536016	-300	-310		•			•	•	•
536017	-300	-310		•			•	•	•
536018	-300	-310		•			•	•	•
536019	-300	-310		•			•	•	•
536020	-300	-310		•			•	•	•
536021	-300	-310		•			•	•	•
536022	-300	-310		•			•	•	•
536023	-300	-310		•			•	•	•
536024	-300	-310		•			•	•	•
536025	-300	-310		•			•	•	•
536026	-300	-310		•			•	•	•
536027	-300	-310		•			•	•	•
536028	-300	-310		•			•	•	•
536029	-300	-310			•		•	•	•
536030	-300	-310			•		•	•	•
536031	-300	-310			•		•	•	•
536032	-300	-310			•		•	•	•
536033	-300	-310			•		•	•	•
536034	-300	-310			•		•	•	•
536035	-300	-310			•		•	•	•
536036	-300	-310			•		•	•	•
536037	-300	-310			•		•	•	•
536038	-300	-310			•		•	•	•
536039	-300	-310			•		•	•	•
536040	-300	-310			•		•	•	•
536041	-300	-310			•		•	•	•
536042	-300	-310			•		•	•	•
536043	-300	-310			•		•	•	•
536044	-300	-310			•		•	•	•
536047	-300	-310				•	•	•	•

acc. code ▶ prod. code ▼	dimmi DALI	dimmi 1-10	196	197	198	199	215	236	237
536048	-300	-310					•	•	•
536049	-300	-310					•	•	•
536050	-300	-310					•	•	•
536051	-300	-310					•	•	•
536052	-300	-310					•	•	•
536055	-300	-310					•	•	•
536056	-300	-310					•	•	•
536057	-300	-310					•	•	•
536058	-300	-310					•	•	•
536059	-300	-310					•	•	•
536060	-300	-310					•	•	•
536061				•			•	•	•
536062				•			•	•	•
536063					•		•	•	•
536064					•		•	•	•
536103			•				•	•	•
536106			•				•	•	•
536109			•				•	•	•
536112			•				•	•	•
536114	-300	-310		•			•	•	•
536116	-300	-310		•			•	•	•
536118	-300	-310		•			•	•	•
536120	-300	-310		•			•	•	•
536122	-300	-310		•			•	•	•
536124	-300	-310		•			•	•	•
536126	-300	-310		•			•	•	•
536128	-300	-310		•			•	•	•
536130	-300	-310			•		•	•	•
536132	-300	-310			•		•	•	•
536134	-300	-310			•		•	•	•
536136	-300	-310			•		•	•	•
536138	-300	-310			•		•	•	•
536140	-300	-310			•		•	•	•
536142	-300	-310			•		•	•	•
536144	-300	-310			•		•	•	•
536148	-300	-310				•	•	•	•
536150	-300	-310				•	•	•	•
536152	-300	-310				•	•	•	•
536156	-300	-310				•	•	•	•
536158	-300	-310				•	•	•	•
536160	-300	-310				•	•	•	•



- Square luminaire for installation in the ceiling – recessed.
- Configuration: die-cast aluminium structure, EN AB-47100 alloy (low copper content). Glass diffuser: transparent or sandblasted fixed to the frame through a robotic gluing system.
- Double layer coating for high resistance to corrosion: the aluminium components are painted with a double coat using powders which are compliant with QUALICOAT standards: a first layer of epoxy powder (with excellent chemical and mechanical resistance) and a second finishing layer of polyester powder (resistant to UV rays and atmospheric agents). The entire painting process of the aluminium fitting starts from components which have been sandblasted in advance to make the surface more porous and increase the adherence of the paint. Ares effects alkaline and acid washing to clean the surfaces completely, then rinses with demineralised water to remove any residue particles, subsequently a chemical conversion treatment is done to protect against rusting.
- Protection rating: IP65
- In compliance with EN 60598-1 standards
- Class of insulation: mains: I, low voltage: III, LED module: I,II
- Installation: Ara GZ10/GU5,3 125x125: pre-wired with approx. 250mm cable. Ara LED 125x125: prewired with approx. 1000mm cable. Ara LED 250x250: equipped with two M16 plastic cable glands. The luminaire is ready for installation on false-ceiling (up to 30mm thick surfaces). Installation on solid ceiling requires a dedicated metal box to be ordered separately. Outdoor use requires suitable flexible cables assuring the watertightness of the cable gland / connector.
- We recommend the use of a connection system with a protection degree greater than or equal to the protection degree of the luminaire.
- During the installation and the maintenance of the fixtures it is important to be careful and avoid damages on the paint coating.
Damages on the coating exposed to outdoor conditions or water, could cause corrosion.
Chemical substances affect the anticorrosion covering protection.

EU Regulation 874/2012 - Illumination equipment energy classes

A++
A+
A

LED VERSION:
Class A/A+/A++
Luminaire supplied with integrated LED modules that cannot be replaced



Recessed ceiling fitting.



Ara LED 250x250mm
The fitting is equipped with 2 cable input.



Remote device required



Ara GZ10/GU5,3 125x125mm
Pre-wired with approx 250mm of cable



Protection against impact.
IK 06 - 1,00 joule



Ara LED 125x125mm

Pre-wired with approx 1000mm of cable

Ara 125x125 mm - Transparent Glass - Adjustable Optic



1032823
QPAR CBC 51 50W/230V GZ10
Lamp max size: Ø50 mm H.55 mm



1033323
QR CBC 51 50W/12V GU5,3
Lamp max size: Ø50 mm H.45 mm

Remote transformer to be ordered

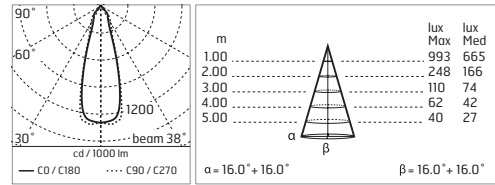
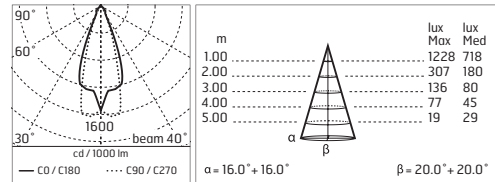
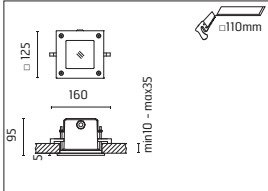

IP65

Ara 125x125 mm - Sandblasted Glass - Adjustable Optic



10328134
QPAR CBC 51 50W/230V GZ10
Lamp max size: Ø50 mm H.55 mm



10333134
QR CBC 51 50W/12V GU5,3
Lamp max size: Ø50 mm H.45 mm

Remote transformer to be ordered

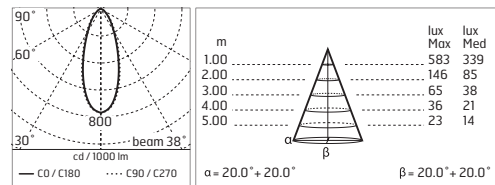
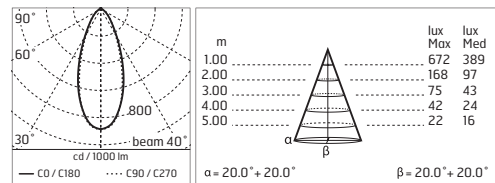
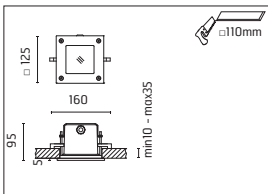

IP65

Ara 125x125 mm - Transparent Glass - 15°

Light Source: Power LED / 4,4W / Total power 6W / CRI>80 / 100÷240V / Integral electronic power supply

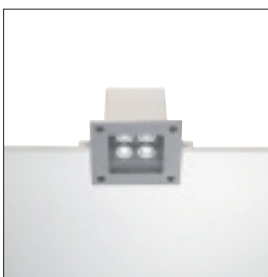

1039242.A
White 2700K
lm LED 521 ≈ lm OUTPUT 455

1039212.A
White 3000K
lm LED 560 ≈ lm OUTPUT 489

10321712.A
White 4000K
lm LED 580 ≈ lm OUTPUT 523

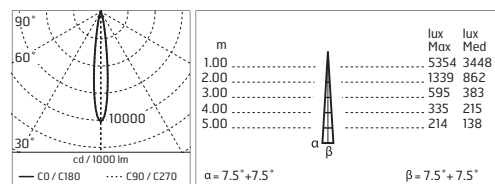
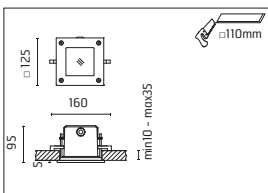

@ 4000K

IP65

Ara 125x125mm - Transparent Glass - 50°

Light Source: Power LED / 4,4W / Total power 6W / CRI>80 / 100÷240V / Integral electronic power supply



1039243.A
White 2700K
lm LED 521 ≈ lm OUTPUT 410

1039223.A
White 3000K
lm LED 560 ≈ lm OUTPUT 441

10321723.A
White 4000K
lm LED 580 ≈ lm OUTPUT 472

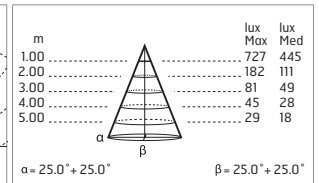
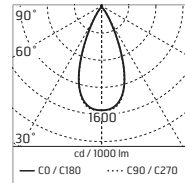

@ 4000K

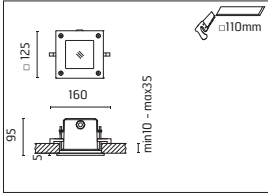

IP65

Ara 125x125mm - Sandblasted Glass

Light Source: Power LED / 4,4W / Total power 6W / CRI>80 / 100÷240V / Integral electronic power supply



10392144.A
White 2700K
lm LED 521 ≈ lm OUTPUT 288

10392134.A
White 3000K
lm LED 560 ≈ lm OUTPUT 310

103217134.A
White 4000K
lm LED 580 ≈ lm OUTPUT 332

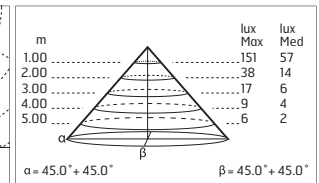
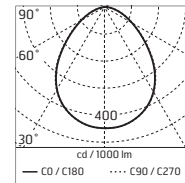

@ 4000K

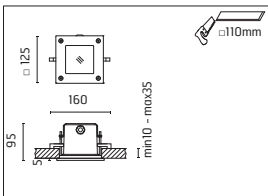

IP65

Ara 250x250 mm - All Light - Transparent Glass - 15°

Light Source: Power LED / 17W / Total power 20W / CRI>80 / 220÷240V / Integral electronic power supply



10310142.A
White 2700K
lm LED 2082 ≈ lm OUTPUT 1731

10310112.A
White 3000K
lm LED 2239 ≈ lm OUTPUT 1861

10322412.A
White 4000K
lm LED 2319 ≈ lm OUTPUT 1927

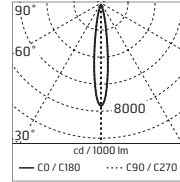

m	lux	
	Max	Med
1.00	14621	9258
2.00	3655	2315
3.00	1625	1029
4.00	914	579
5.00	585	370

$\alpha = 7.5^\circ + 7.5^\circ$ $\beta = 7.5^\circ + 7.5^\circ$

@ 4000K

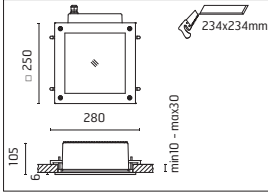

Dimmable on request

IP65

Ara 250x250 mm - All Light - Transparent Glass - 45°

Light Source: Power LED / 17W / Total power 20W / CRI>80 / 220÷240V / Integral electronic power supply



10310143.A
White 2700K
lm LED 2082 ≈ lm OUTPUT 1649

10310123.A
White 3000K
lm LED 2239 ≈ lm OUTPUT 1773

10322423.A
White 4000K
lm LED 2319 ≈ lm OUTPUT 1836

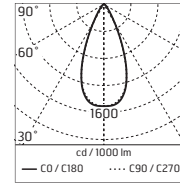

m	lux	
	Max	Med
1.00	2828	1733
2.00	707	433
3.00	314	193
4.00	177	108
5.00	113	69

$\alpha = 22.5^\circ + 22.5^\circ$ $\beta = 22.5^\circ + 22.5^\circ$

@ 4000K

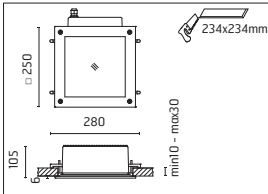

Dimmable on request

IP65

Ara 250x250 mm - All Light - Sandblasted Glass

Light Source: Power LED / 17W / Total power 20W / CRI>80 / 220÷240V / Integral electronic power supply



103101145.A
White 2700K
lm LED 2082 ≈ lm OUTPUT 1415

103101135.A
White 3000K
lm LED 2239 ≈ lm OUTPUT 1522

103224135.A
White 4000K
lm LED 2319 ≈ lm OUTPUT 1577

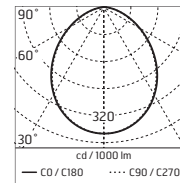

m	lux	
	Max	Med
1.00	600	168
2.00	150	42
3.00	67	19
4.00	37	11
5.00	24	7

$\alpha = 53.0^\circ + 53.0^\circ$ $\beta = 53.0^\circ + 53.0^\circ$

@ 4000K

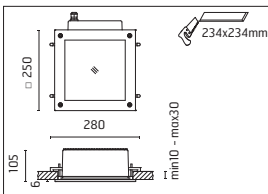

Dimmable on request

IP65

Accessories: Ara

107
METAL BOX FOR INSTALLATION
IN CONCRETE CEILING 256x200xH130mm

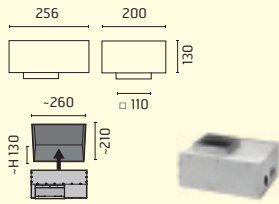

108
METAL BOX FOR INSTALLATION
IN CONCRETE CEILING 450x300xH150mm

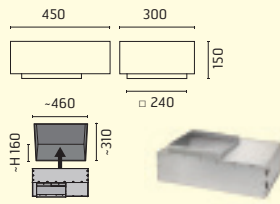

16
TRANSFORMER 50W
230V/12V 50Hz IP 66

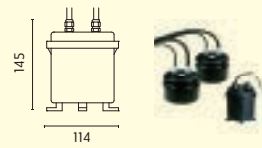

17
TRANSFORMER 200W
230V/12V 50Hz IP 66

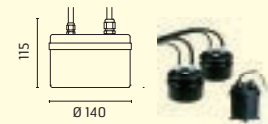

18
TRANSFORMER 300W
230V/12V 50Hz IP 66

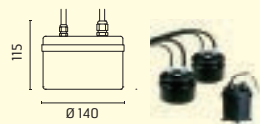

215
3/4 WAY TERMINAL BLOCK 4 POLES
IP68 H₂O STOP (Ø5,5÷12mm CABLE)

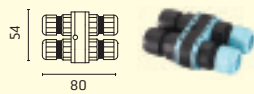

236
2 WAY TERMINAL BLOCK 4 POLES
IP68 H₂O STOP (Ø5,5÷12mm CABLE)

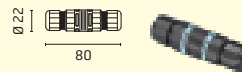

237
SPD: (SURGE PROTECTION DEVICE)
275Vac
MAXIMUM DISCHARGE CURRENT 10kA
(8/20µs)
MAXIMUM OPERATING CURRENT 5A
SUITABLE FOR SERIES CONNECTION
- IP66

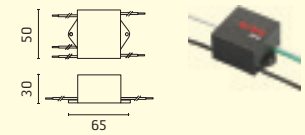

acc. code ▶	107	108	16	17	18	215	236	237
1032823	•					•	•	
1033323	•		•	•	•	•	•	
1039242.A	•					•	•	•
1039243.A	•					•	•	•
10310142.A		•				•	•	•
10310143.A		•				•	•	•
10328134	•					•	•	
10333134	•		•	•	•	•	•	
10392144.A	•					•	•	•
103101145.A		•				•	•	•
10310112.A		•				•	•	•
103101135.A		•				•	•	•
10310123.A		•				•	•	•
10321712.A	•					•	•	•
103217134.A	•					•	•	•
10321723.A	•					•	•	•
10322412.A		•				•	•	•
103224135.A		•				•	•	•
10322423.A		•				•	•	•
1039212.A	•					•	•	•
10392134.A	•					•	•	•
1039223.A	•					•	•	•



- Bollard light.
- Configuration: die-cast aluminium structure, EN AB-47100 alloy (low copper content). Extruded aluminium stem. Plastic diffuser: sandblasted
- Double layer coating for high resistance to corrosion: the aluminium components are painted with a double coat using powders which are compliant with QUALICOAT standards: a first layer of epoxy powder (with excellent chemical and mechanical resistance) and a second finishing layer of polyester powder (resistant to UV rays and atmospheric agents). The entire painting process of the aluminium fitting starts from components which have been sandblasted in advance to make the surface more porous and increase the adherence of the paint. Ares effects alkaline and acid washing to clean the surfaces completely, then rinses with demineralised water to remove any residue particles, subsequently a chemical conversion treatment is done to protect against rusting.
- Protection rating: IP65 (with base) or IP67 (in-ground)
- In compliance with EN 60598-1 standards
- Class of insulation: mains: I; low voltage: III
- Installation: version with base: wiring through one M16 cable gland. Direct fixation with bolts to a concrete surface or through a dedicated fixing plate (to be ordered separately) in a concrete basement; version in-ground: wiring through two M16 cable glands. For a better stability, we recommend to concrete the root of the pole. Outdoor use requires suitable flexible cables assuring the watertightness of the cable gland.
- During the installation and the maintenance of the fixtures it is important to be careful and avoid damages on the paint coating. Damages on the coating exposed to outdoor conditions or water, could cause corrosion. Chemical substances affect the anticorrosion covering protection.

EU Regulation 874/2012 - Illumination equipment energy classes

A++
A+
A

LED VERSION:
Class A/A+/A++
Luminaire supplied with integrated LED modules that cannot be replaced

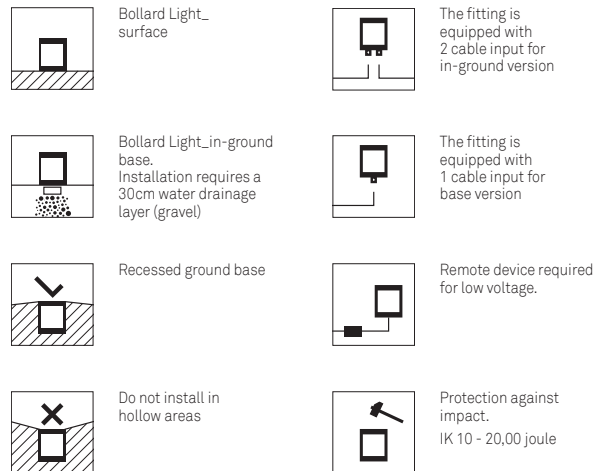

Vincenza H. 450 mm - With Base - 360° Symmetric Emission

Light Source: Power LED / 6,4W / Total power 8,5W / CRI>80 / 220÷240V / Integral electronic power supply



10814092
White 2700K
lm LED 670 ≠ lm OUTPUT 326

10813092
White 3000K
lm LED 720 ≠ lm OUTPUT 351

10819592
White 4000K
lm LED 780 ≠ lm OUTPUT 380

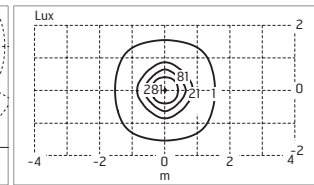
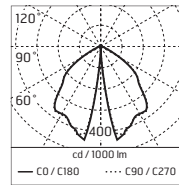

@ 4000K

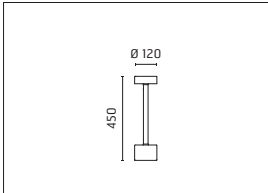

IP65

Vincenza H. 450 mm - With Base - 180° Asymmetric Emission

Light Source: Power LED / 6,4W / Total power 8,5W / CRI>80 / 220÷240V / Integral electronic power supply



10814093
White 2700K
lm LED 670 ≠ lm OUTPUT 326

10813093
White 3000K
lm LED 720 ≠ lm OUTPUT 351

10819593
White 4000K
lm LED 780 ≠ lm OUTPUT 380

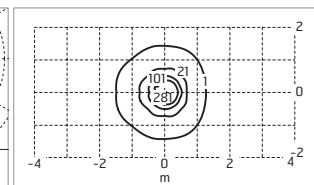
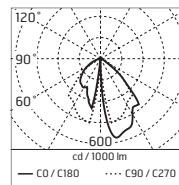

@ 4000K

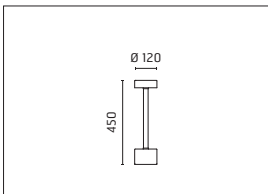

IP65

Vincenza H. 800 mm - With Base - 360° Symmetric Emission

Light Source: Power LED / 6,4W / Total power 8,5W / CRI>80 / 220÷240V / Integral electronic power supply



10814094
White 2700K
lm LED 670 ≈ lm OUTPUT 326

10813094
White 3000K
lm LED 720 ≈ lm OUTPUT 351

10819594
White 4000K
lm LED 780 ≈ lm OUTPUT 380

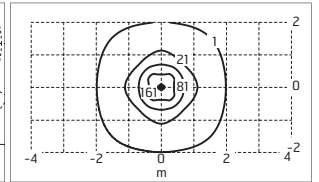
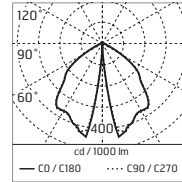

@ 4000K

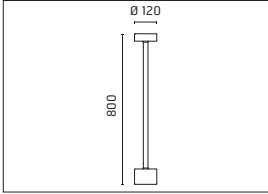

IP65

Vincenza H. 800 mm - With Base - 180° Asymmetric Emission

Light Source: Power LED / 6,4W / Total power 8,5W / CRI>80 / 220÷240V / Integral electronic power supply



10814095
White 2700K
lm LED 670 ≈ lm OUTPUT 326

10813095
White 3000K
lm LED 720 ≈ lm OUTPUT 351

10819595
White 4000K
lm LED 780 ≈ lm OUTPUT 380

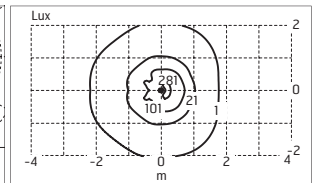
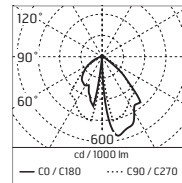

@ 4000K

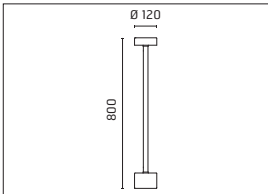

IP65

Vincenza H. 200 mm - In-Ground Base - 360° Symmetric Emission

Light Source: Power LED / 6,4W / Total power 7,9W / CRI>80 / 24Vdc / Remote electronic power supply to be ordered



10814396
White 2700K
lm LED 670 ≠ lm OUTPUT 326

10813396
White 3000K
lm LED 720 ≠ lm OUTPUT 351

10819696
White 4000K
lm LED 780 ≠ lm OUTPUT 380

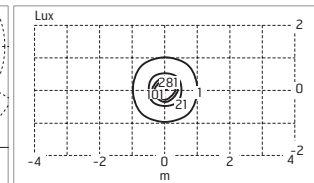
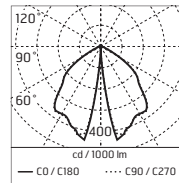

@ 4000K

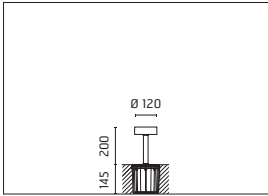

IP67

Vincenza H. 370 mm - In-Ground Base - 360° Symmetric Emission

Light Source: Power LED / 6,4W / Total power 7,9W / CRI>80 / 24Vdc / Remote electronic power supply to be ordered



10814397
White 2700K
lm LED 670 ≠ lm OUTPUT 326

10813397
White 3000K
lm LED 720 ≠ lm OUTPUT 351

10819697
White 4000K
lm LED 780 ≠ lm OUTPUT 380

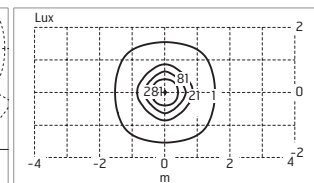
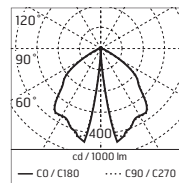

@ 4000K

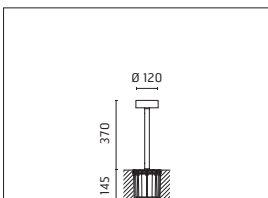

IP67

Vincenza H. 370 mm - In-Ground Base - 180° Asymmetric Emission

Light Source: Power LED / 6,4W / Total power 7,9W / CRI>80 / 24Vdc / Remote electronic power supply to be ordered



10814398
White 2700K
lm LED 670 ≠ lm OUTPUT 326

10813398
White 3000K
lm LED 720 ≠ lm OUTPUT 351

10819698
White 4000K
lm LED 780 ≠ lm OUTPUT 380

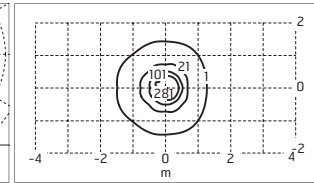
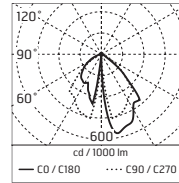

@ 4000K

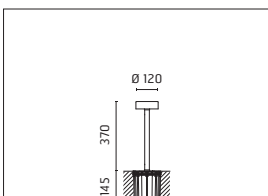

IP67

Vincenza H. 720 mm - In-Ground Base - 360° Symmetric Emission

Light Source: Power LED / 6,4W / Total power 7,9W / CRI>80 / 24Vdc / Remote electronic power supply to be ordered



10814399
White 2700K
lm LED 670 ≈ lm OUTPUT 326

10813399
White 3000K
lm LED 720 ≈ lm OUTPUT 351

10819699
White 4000K
lm LED 780 ≈ lm OUTPUT 380

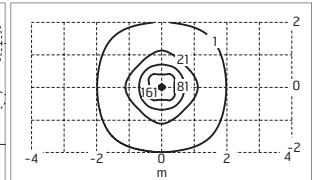
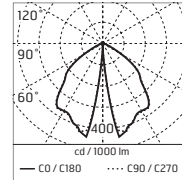

@ 4000K

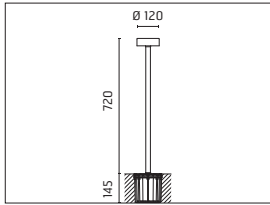

IP67

Vincenza H. 720 mm - In-Ground Base - 180° Asymmetric Emission

Light Source: Power LED / 6,4W / Total power 7,9W / CRI>80 / 24Vdc / Remote electronic power supply to be ordered



10814334
White 2700K
lm LED 670 ≈ lm OUTPUT 326

10813334
White 3000K
lm LED 720 ≈ lm OUTPUT 351

10819634
White 4000K
lm LED 780 ≈ lm OUTPUT 380

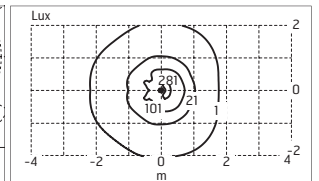
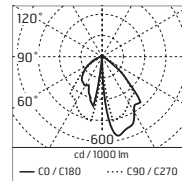

@ 4000K

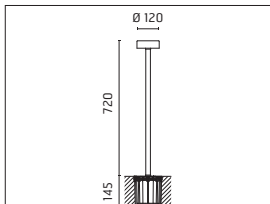

IP67

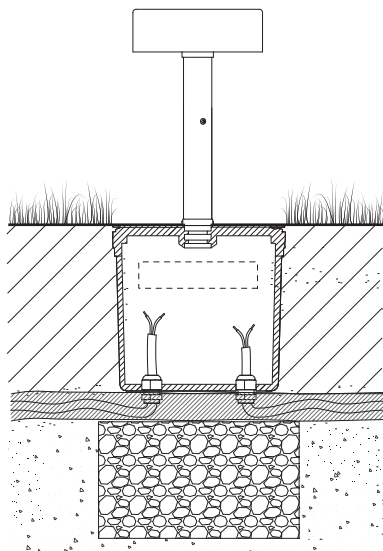

Cable gland mounted from the inside

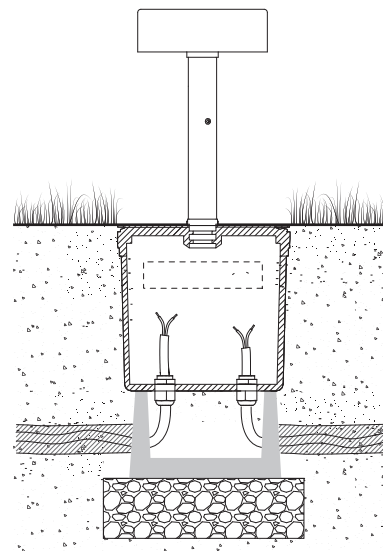

Cable gland mounted from the outside



Accessories: Vincenzo

175
POWER SUPPLY 10W/110÷240V -
24Vdc
IP67 CLASS II SELV.

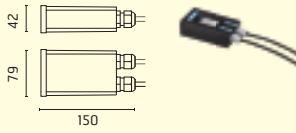

155
POWER SUPPLY 50W/120÷240V -
24Vdc
IP67 CLASS II SELV.

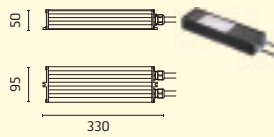

110
POWER SUPPLY 70W/220÷240V -
24Vdc
IP67 CLASS II SELV EQ.

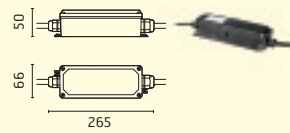

237
SPD: (SURGE PROTECTION DEVICE)
275Vac
MAXIMUM DISCHARGE CURRENT 10KA
(8/20µs)
MAXIMUM OPERATING CURRENT 5A
SUITABLE FOR SERIES CONNECTION
- IP66

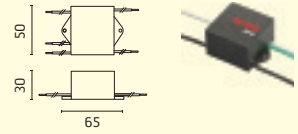

acc. code ▶	175	155	110	237
prod. code ▼				
10813092				•
10813093				•
10813094				•
10813095				•
10813334	1	4	7	
10813396	1	4	7	
10813397	1	4	7	
10813398	1	4	7	
10813399	1	4	7	
10814092				•
10814093				•
10814094				•
10814095				•
10814334	1	4	7	
10814396	1	4	7	
10814397	1	4	7	
10814398	1	4	7	
10814399	1	4	7	
10819592				•
10819593				•
10819594				•
10819595				•
10819634	1	4	7	
10819696	1	4	7	
10819697	1	4	7	
10819698	1	4	7	
10819699	1	4	7	

Correct Fixing Method
Bollard fixed on plint +
suitable installation screws

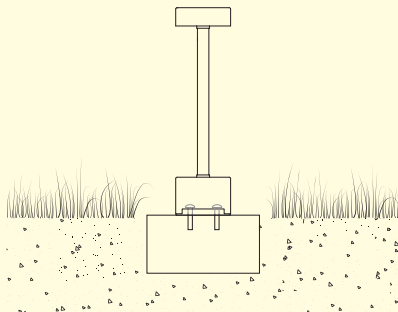

Incorrect Fixing Method
Do not fix the bollard directly on the ground

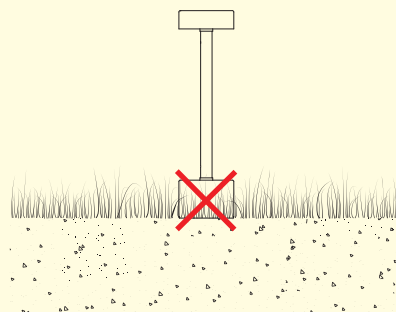

Max fixtures for each power supply
(Vin 220÷240). Data in the chart
are provided as a guide only.
Please verify according to your
installation.



- Cylindrical bollard light.
- Configuration: die-cast aluminium cap, EN AB-47100 alloy (low copper content) and extruded aluminium pole. Polycarbonate diffuser: Transparent and UV-stabilised.
- Double layer coating for high resistance to corrosion: the aluminium components are painted with a double coat using powders which are compliant with QUALICOAT standards: a first layer of epoxy powder (with excellent chemical and mechanical resistance) and a second finishing layer of polyester powder (resistant to UV rays and atmospheric agents). The entire painting process of the aluminium fitting starts from components which have been sandblasted in advance to make the surface more porous and increase the adherence of the paint. Ares effects alkaline and acid washing to clean the surfaces completely, then rinses with demineralised water to remove any residue particles, subsequently a chemical conversion treatment is done to protect against rusting.
- Protection rating: IP65
- In compliance with EN 60598-1 standards
- Class of insulation: II
- Installation: the luminaire is equipped with a piece of cable with a 2-way connector for 3-conductor cables for an easy to make connection. We recommend installation on a concrete basement or surface, directly with bolts or through a dedicated fixing plate (to be ordered separately). Outdoor use requires suitable flexible cables.
- We recommend the use of a connection system with a protection degree greater than or equal to the protection degree of the luminaire.
- During the installation and the maintenance of the fixtures it is important to be careful and avoid damages on the paint coating.
Damages on the coating exposed to outdoor conditions or water, could cause corrosion.
Chemical substances affect the anticorrosion covering protection.

EU Regulation 874/2012 - Illumination equipment energy classes



LED VERSION:
Class A/A+/A++
Luminaire supplied
with integrated LED modules
that cannot be replaced



.1 White



.6 Grey



.3 Anthracite



.4 Black



.18 Deep Brown



Bollard Light



Wall fitting

Pre-wired with approx
100mm of cableProtection against
impact.
IK 10 - 20,00 joule

Zefiro - H.200mm - 360° Emission

Light Source: Mid-Power LED / 14W / Total power 17W / CRI>80 / 220÷240V / Integral electronic power supply

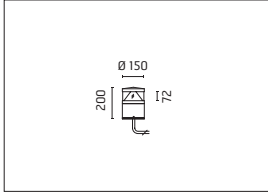

532014
532014-300 Dimmable Dali
532014-310 Dimmable 1-10
 White 2700K
 lm LED 1716 ≠ lm OUTPUT 1357

532003
532003-300 Dimmable Dali
532003-310 Dimmable 1-10
 White 3000K
 lm LED 1845 ≠ lm OUTPUT 1423

532002
532002-300 Dimmable Dali
532002-310 Dimmable 1-10
 White 4000K
 lm LED 1937 ≠ lm OUTPUT 1494

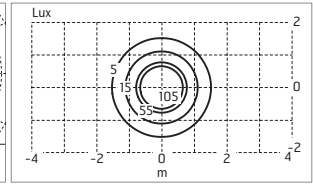
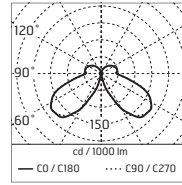

@4000K

IP65

Zefiro - H.600mm - 360° Emission

Light Source: Mid-Power LED / 14W / Total power 17W / CRI>80 / 220÷240V / Integral electronic power supply

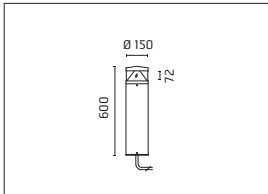

532017
532017-300 Dimmable Dali
532017-310 Dimmable 1-10
 White 2700K
 lm LED 1716 ≠ lm OUTPUT 1357

532006
532006-300 Dimmable Dali
532006-310 Dimmable 1-10
 White 3000K
 lm LED 1845 ≠ lm OUTPUT 1423

532005
532005-300 Dimmable Dali
532005-310 Dimmable 1-10
 White 4000K
 lm LED 1937 ≠ lm OUTPUT 1494

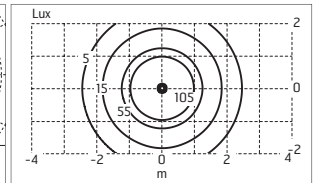
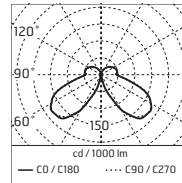

@4000K

Mid-Night version on request

IP65

Zefiro - H.1000mm - 360° Emission

Light Source: Mid-Power LED / 14W / Total power 17W / CRI>80 / 220÷240V / Integral electronic power supply

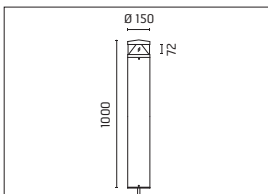

532020
532020-300 Dimmable Dali
532020-310 Dimmable 1-10
 White 2700K
 lm LED 1716 ≠ lm OUTPUT 1357

532009
532009-300 Dimmable Dali
532009-310 Dimmable 1-10
 White 3000K
 lm LED 1845 ≠ lm OUTPUT 1423

532008
532008-300 Dimmable Dali
532008-310 Dimmable 1-10
 White 4000K
 lm LED 1937 ≠ lm OUTPUT 1494

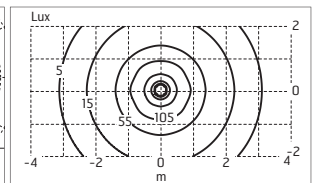
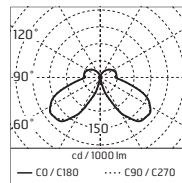

@4000K

Mid-Night version on request

IP65

Zefiro - H.200mm - 180° Emission

Light Source: Mid-Power LED / 14W / Total power 17W / CRI>80 / 220÷240V / Integral electronic power supply



532024
532024-300 Dimmable Dali
532024-310 Dimmable 1-10
 White 2700K
 lm LED 1716 ≠ lm OUTPUT 725

532023
532023-300 Dimmable Dali
532023-310 Dimmable 1-10
 White 3000K
 lm LED 1845 ≠ lm OUTPUT 774

532022
532022-300 Dimmable Dali
532022-310 Dimmable 1-10
 White 4000K
 lm LED 1937 ≠ lm OUTPUT 813

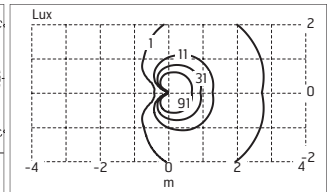
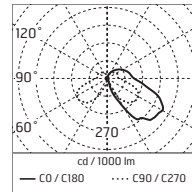
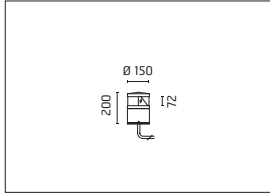

@4000K

IP65

Zefiro - H.600mm - 180° Emission

Light Source: Mid-Power LED / 14W / Total power 17W / CRI>80 / 220÷240V / Integral electronic power supply



532027
532027-300 Dimmable Dali
532027-310 Dimmable 1-10
 White 2700K
 lm LED 1716 ≠ lm OUTPUT 725

532026
532026-300 Dimmable Dali
532026-310 Dimmable 1-10
 White 3000K
 lm LED 1845 ≠ lm OUTPUT 774

532025
532025-300 Dimmable Dali
532025-310 Dimmable 1-10
 White 4000K
 lm LED 1937 ≠ lm OUTPUT 813

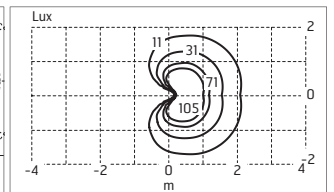
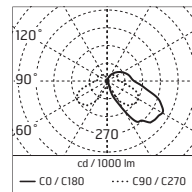
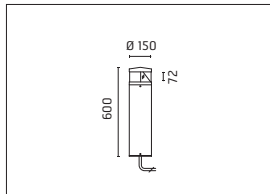

@4000K

Mid-Night version on request

IP65

Zefiro - H1000mm - 180° Emission

Light Source: Mid-Power LED / 14W / Total power 17W / CRI>80 / 220÷240V / Integral electronic power supply



532030
532030-300 Dimmable Dali
532030-310 Dimmable 1-10
 White 2700K
 lm LED 1716 ≠ lm OUTPUT 725

532029
532029-300 Dimmable Dali
532029-310 Dimmable 1-10
 White 3000K
 lm LED 1845 ≠ lm OUTPUT 774

532028
532028-300 Dimmable Dali
532028-310 Dimmable 1-10
 White 4000K
 lm LED 1937 ≠ lm OUTPUT 813

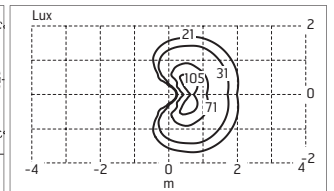
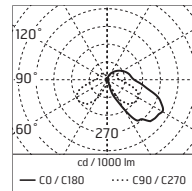
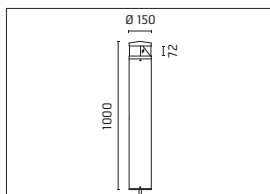

@4000K

Mid-Night version on request

IP65



Accessories: Zefiro

21
BASE PLATE AND FIXING BOLTS
174 x H 200mm

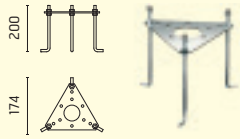

185.A
HIGH RESISTANCE IN-GROUND
FIXING BASE

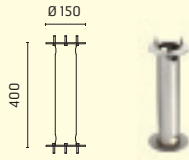

237
SPD: (SURGE PROTECTION DEVICE)
275Vac
MAXIMUM DISCHARGE CURRENT 10kA
(8/20µs)
MAXIMUM OPERATING CURRENT 5A
SUITABLE FOR SERIES CONNECTION
- IP66

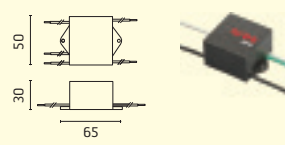

215
3/4 WAY TERMINAL BLOCK 4 POLES
IP68 H₂O STOP (Ø5,5÷12mm CABLE)

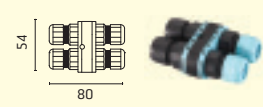

acc. code ▶	dimmi DALI	dimmi 1-10	21	185.A	237	215
532002	-300	-310	•	•	•	•
532003	-300	-310	•	•	•	•
532005	-300	-310	•	•	•	•
532006	-300	-310	•	•	•	•
532008	-300	-310	•	•	•	•
532009	-300	-310	•	•	•	•
532014	-300	-310	•	•	•	•
532017	-300	-310	•	•	•	•
532020	-300	-310	•	•	•	•
532022	-300	-310	•	•	•	•
532023	-300	-310	•	•	•	•
532024	-300	-310	•	•	•	•
532025	-300	-310	•	•	•	•
532026	-300	-310	•	•	•	•
532027	-300	-310	•	•	•	•
532028	-300	-310	•	•	•	•
532029	-300	-310	•	•	•	•
532030	-300	-310	•	•	•	•

Correct Fixing Method
Bollard fixed on plinth +
suitable installation screws

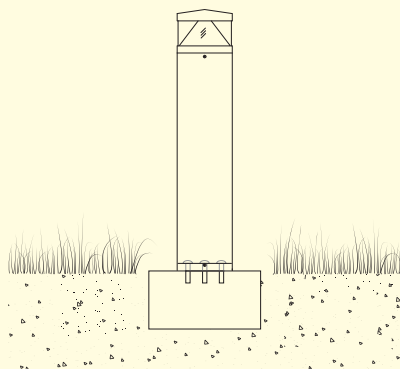

Correct Fixing Method
Bollard fixed on plinth + fixing bolts

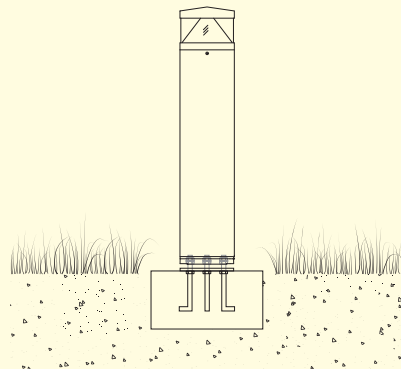

Incorrect Fixing Method
Do not fix the bollard directly on the ground

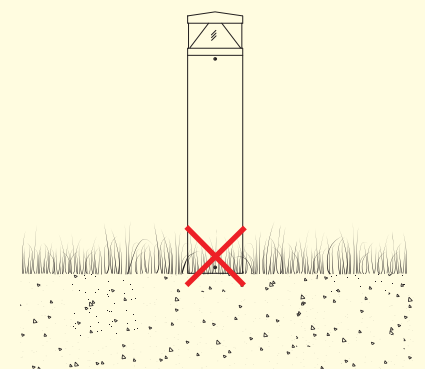



- Bollard light.
- Configuration: extruded aluminium structure. Polycarbonate diffuser: opal UV-stabilised.
- Double layer coating for high resistance to corrosion: the aluminium components are painted with a double coat using powders which are compliant with QUALICOAT standards: a first layer of epoxy powder (with excellent chemical and mechanical resistance) and a second finishing layer of polyester powder (resistant to UV rays and atmospheric agents). The entire painting process of the aluminium fitting starts from components which have been sandblasted in advance to make the surface more porous and increase the adherence of the paint. Ares effects alkaline and acid washing to clean the surfaces completely, then rinses with demineralised water to remove any residue particles, subsequently a chemical conversion treatment is done to protect against rusting.
- Protection rating: IP65
- In compliance with EN 60598-1 standards
- Class of insulation: II
- Installation: The LED module is housed in a sealed transparent polycarbonate cylinder with compensation valve. The luminaire is equipped with a piece of cable and a wiring kit with crimp connectors and an adhesive heat-shrink tubing for a watertight electrical connection. We recommend installation on a concrete basement or surface, directly with bolts or through the dedicated fixing plate (to be ordered separately). Outdoor use requires suitable flexible cables.
- We recommend the use of a connection system with a protection degree greater than or equal to the protection degree of the luminaire.
- During the installation and the maintenance of the fixtures it is important to be careful and avoid damages on the paint coating.
Damages on the coating exposed to outdoor conditions or water, could cause corrosion.
Chemical substances affect the anticorrosion covering protection.

EU Regulation 874/2012 - Illumination equipment energy classes



LED VERSION:
Class A/A+/A++
Luminaire supplied
with integrated LED modules
that cannot be replaced



.1 White



.6 Grey



.3 Anthracite



.4 Black



.18 Deep Brown



Bollard light



Pre-wired with approx
200mm of cable



Protection against
impact.
IK 08 - 5,00 joule

Talia - H. 360 mm - Single Emission

Light Source: Low-Power LED / 3W / Total power 4W / CRI>80 / 220÷240V / Integral electronic power supply/



503006
White 3000K
Lm LED 216 ≠ Lm OUTPUT 73

503011
White 4000K
Lm LED 216 ≠ Lm OUTPUT 73

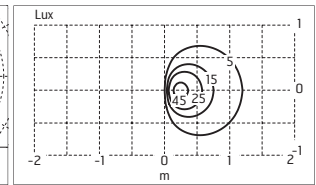
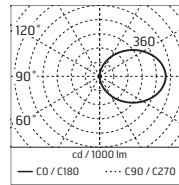

@4000K

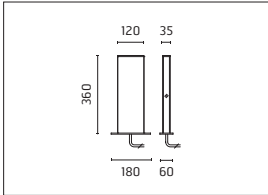

IP65

Talia - H. 360 mm - Double Emission

Light Source: Low-Power LED / 2x(3W) / Total power 7W / CRI>80 / 220÷240V / Integral electronic power supply



503008
White 3000K
Lm LED 2x216 ≠ Lm OUTPUT 2x73

503012
White 4000K
Lm LED 2x216 ≠ Lm OUTPUT 2x73

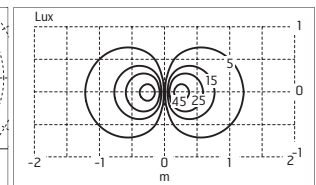
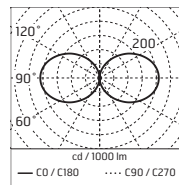

@4000K

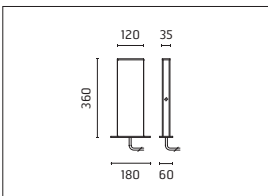

IP65

Talia - H. 560 mm - Single Emission

Light Source: Low-Power LED / 5W / Total power 6W / CRI>80 / 220÷240V / Integral electronic power supply



503002
White 3000K
Lm LED 360 ≈ lm OUTPUT 123

503009
White 4000K
Lm LED 360 ≈ lm OUTPUT 123

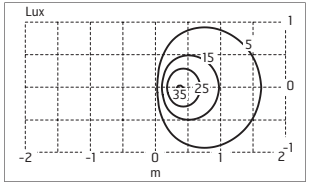
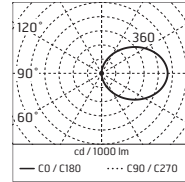

@4000K

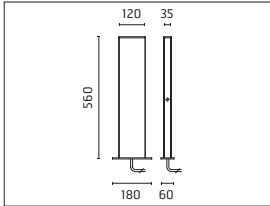

IP65

Talia - H. 560 mm - Double Emission

Light Source: Low-Power LED / 2x(5W) / Total power 11W / CRI>80 / 220÷240V / Integral electronic power supply



503004
White 3000K
Lm LED 2x360 ≈ lm OUTPUT 2x123

503010
White 4000K
Lm LED 2x360 ≈ lm OUTPUT 2x123

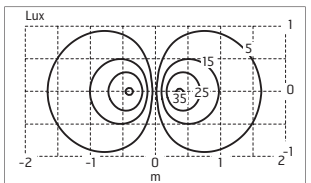
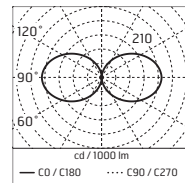

@4000K

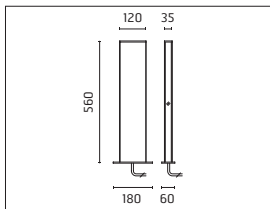

IP65



Accessories: Talia

139

BASE PLATE AND FIXING BOLTS
180 x 60 x H 170mm

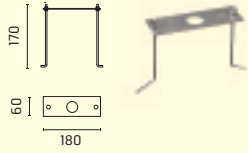

237

SPD: (SURGE PROTECTION DEVICE)
275Vac
MAXIMUM DISCHARGE CURRENT
10KA (8/20µs)
MAXIMUM OPERATING CURRENT 5A
SUITABLE FOR SERIES CONNec-
TION - IP66

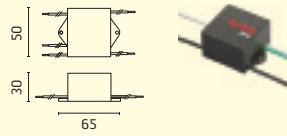

acc. code ▶	139	237
prod. code ▼		
503002	•	•
503004	•	•
503006	•	•
503008	•	•
503009	•	•
503010	•	•
503011	•	•
503012	•	•

Correct Fixing Method

Bollard fixed on plinth +
suitable installation screws

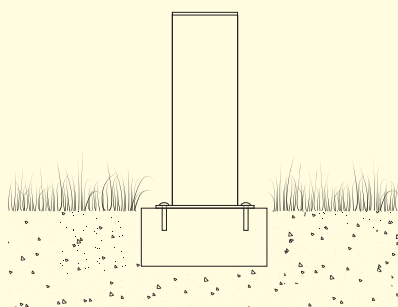

Correct Fixing Method

Bollard fixed on plinth + fixing bolts

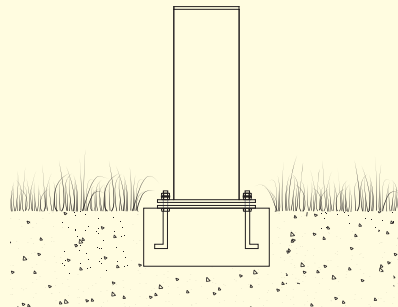

Incorrect Fixing Method

Do not fix the bollard directly on the ground

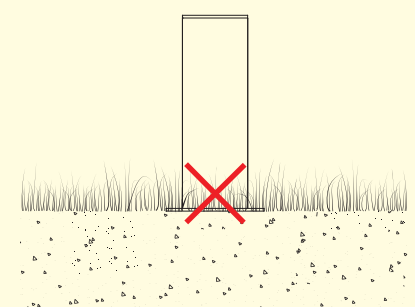

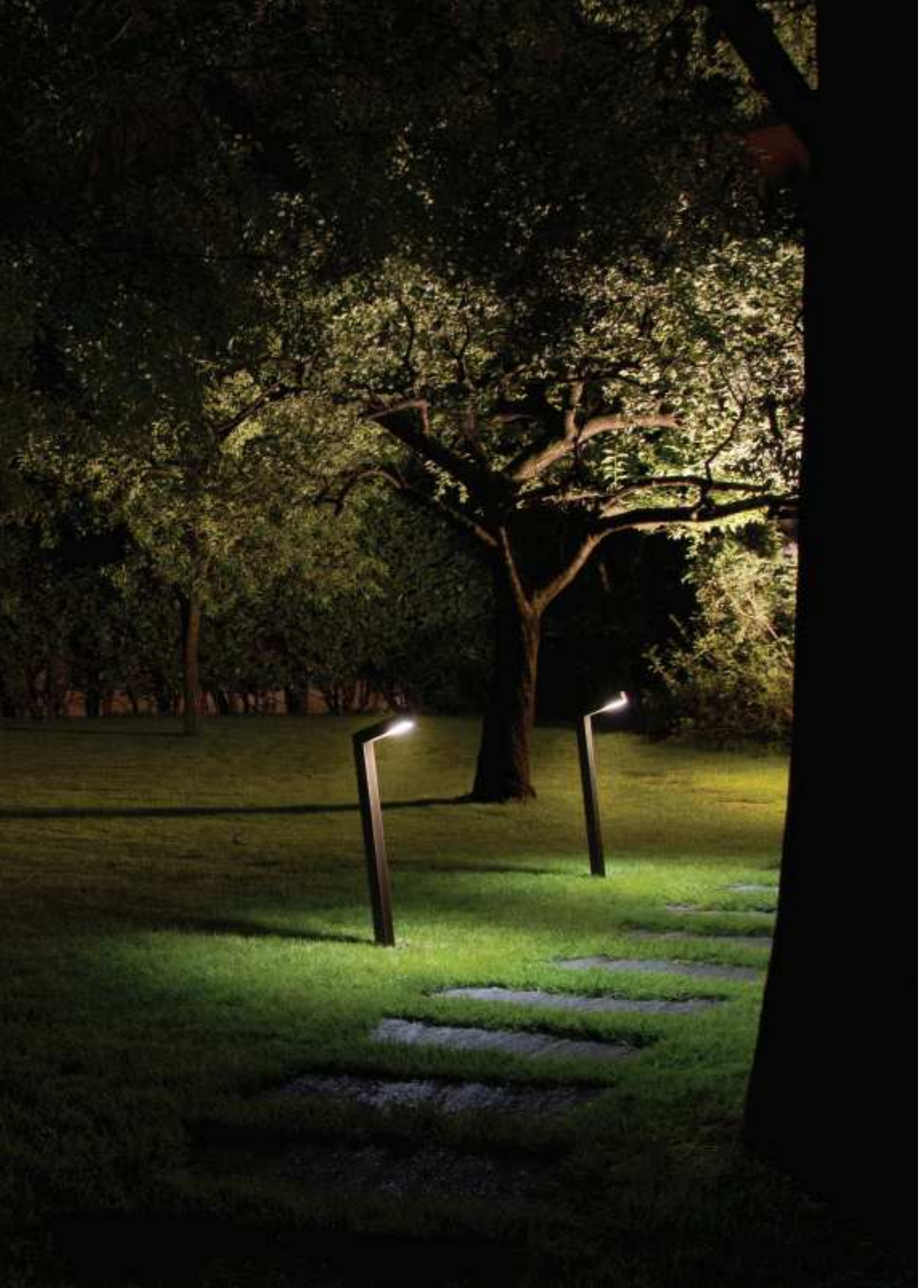

- Bollard light
- Configuration: extruded aluminium structure. Polycarbonate diffuser: satin UV-stabilised.
- Double layer coating for high resistance to corrosion: the aluminium components are painted with a double coat using powders which are compliant with QUALICOAT standards: a first layer of epoxy powder (with excellent chemical and mechanical resistance) and a second finishing layer of polyester powder (resistant to UV rays and atmospheric agents). The entire painting process of the aluminium fitting starts from components which have been sandblasted in advance to make the surface more porous and increase the adherence of the paint. Ares effects alkaline and acid washing to clean the surfaces completely, then rinses with demineralised water to remove any residue particles, subsequently a chemical conversion treatment is done to protect against rusting.
- Protection rating: IP65
- In compliance with EN 60598-1 standards
- Class of insulation: II
- Installation: the luminaire is equipped with a piece of cable and a wiring kit with crimp connectors and an adhesive heat-shrink tubing for a watertight electrical connection. The use of a corrugated tube (Ø 30-50mm) allows an easier connection to the line. We recommend installation on a concrete basement or surface, directly with bolts or through the dedicated fixing plate (to be ordered separately). Outdoor use requires suitable flexible cables.
- We recommend the use of a connection system with a protection degree greater than or equal to the protection degree of the luminaire.
- During the installation and the maintenance of the fixtures it is important to be careful and avoid damages on the paint coating. Damages on the coating exposed to outdoor conditions or water, could cause corrosion. Chemical substances affect the anticorrosion covering protection.

EU Regulation 874/2012 - Illumination equipment energy classes



LED VERSION:
Class A/A+/A++
Luminaire supplied
with integrated LED modules
that cannot be replaced



.1 White



.6 Grey



.3 Anthracite



.4 Black



.18 Deep Brown



Bollard light



Pre-wired with approx
200mm of cable



Protection against
impact.
IK 10 - 20,00 joule

Sandro - H.500mm

Light Source: Power LED / 5,5W / Total power 8W / CRI>80 / 100÷240V / Integral electronic power supply



502009
White 2700K
Lm LED 558 ≠ Lm OUTPUT 299

502006
White 3000K
Lm LED 600 ≠ Lm OUTPUT 321

502005
White 4000K
Lm LED 650 ≠ Lm OUTPUT 347

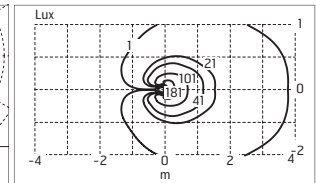
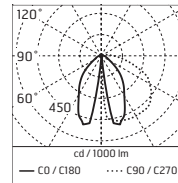

@4000K

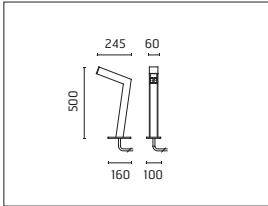

IP65

Sandro - H.900mm

Light Source: Power LED / 5,5W / Total power 8W / CRI 80 / 100÷240V / Integral electronic power supply

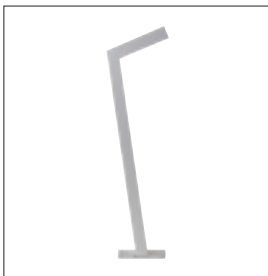

502007
White 2700K
Lm LED 558 ≠ Lm OUTPUT 299

502003
White 3000K
Lm LED 600 ≠ Lm OUTPUT 321

502002
White 4000K
Lm LED 650 ≠ Lm OUTPUT 347

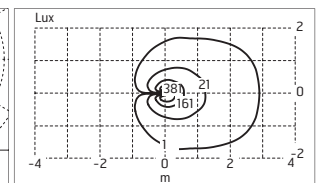
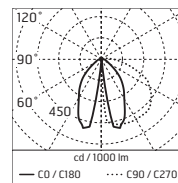

@4000K

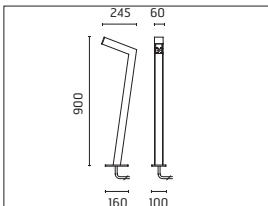

IP65

Accessories: Sandro

138

BASE PLATE AND FIXING BOLTS
160 x 100 x H 170mm

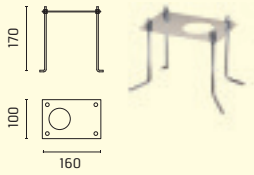

237

SPD: (SURGE PROTECTION DEVICE)
275Vac
MAXIMUM DISCHARGE CURRENT 10KA
(8/20µs)
MAXIMUM OPERATING CURRENT 5A
SUITABLE FOR SERIES CONNECTION
- IP66

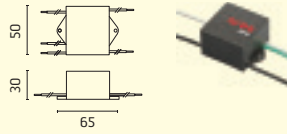

acc. code ▶	138	237
prod. code ▼		
502002	•	•
502003	•	•
502004	•	•
502005	•	•
502007	•	•
502009	•	•

Correct Fixing Method

Bollard fixed on plint +
suitable installation screws

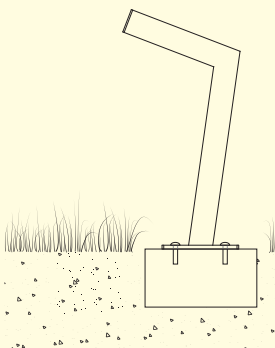

Correct Fixing Method

Bollard fixed on plint + fixing bolts

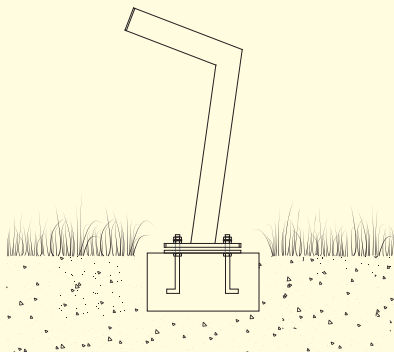

Incorrect Fixing Method

Do not fix the bollard directly on the ground

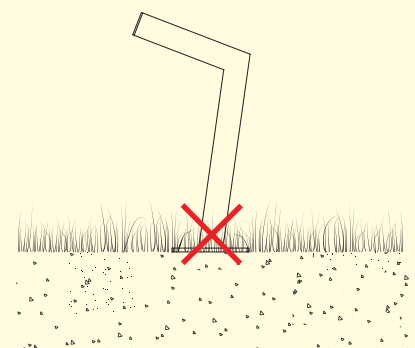



- Bollard light.
- Configuration: hot-dip zinc-coated IPE steel bar (H-frame with base) for high resistance to corrosion. The emission unit, fixed to the upper part of the bar, is composed of a plastic container with zinc-coated cover. Feeding cables are hosted in a hot-dip zinc-coated cover placed on the back side of the bar.
- Protection Rating: IP65
- In compliance with EN 60598-1 standards
- Class of insulation: I
- Installation: wiring through two rubber cable glands ($8 < \varnothing < 13$ mm cables). We recommend installation on a concrete basement or surface, directly with bolts or through the dedicated fixing plate (to be ordered separately).

EU Regulation 874/2012 - Illumination equipment energy classes



LED VERSION:
Class A/A+/A++
Luminaire supplied
with integrated LED modules
that cannot be replaced



.7 Zinc



Bollard Light



The fitting is equipped
with 2 cable input.



Protection against
impact.
IK 10 - 20,00 joule

Viviana

Light Source: Power LED / 8W / Total power 11W / CRI>80 / 220±240V / Integral electronic power supply



10410600
White 2700K
lm LED 1011 ≠ lm OUTPUT 391

10410400
White 3000K
lm LED 1087 ≠ lm OUTPUT 420

10419700
White 4000K
lm LED 1162 ≠ lm OUTPUT 448

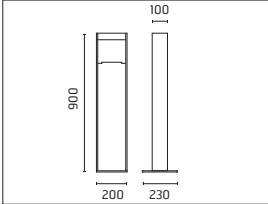
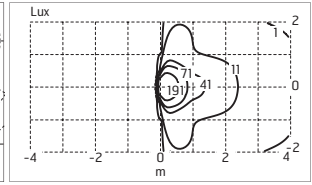
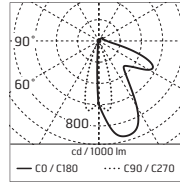

IP65   





Accessories: Viviana

109

BASE PLATE AND FIXING BOLTS
200 x 230 x H 210mm

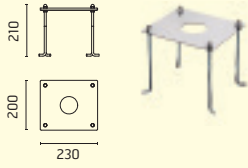

237

SPD: (SURGE PROTECTION DEVICE)
275Vac
MAXIMUM DISCHARGE CURRENT
10KA (8/20µs)
MAXIMUM OPERATING CURRENT 5A
SUITABLE FOR SERIES CONNEC-
TION - IP66

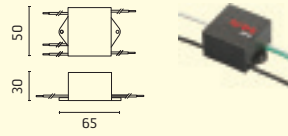

acc. code ▶	109	237
prod. code ▼		
10410400	•	•
10410600	•	•
10419700	•	•

Correct Fixing Method

Bollard fixed on plinth +
suitable installation screws

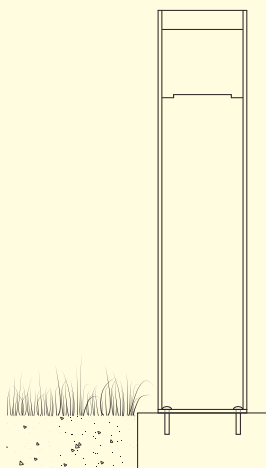

Correct Fixing Method

Bollard fixed on plinth + fixing bolts

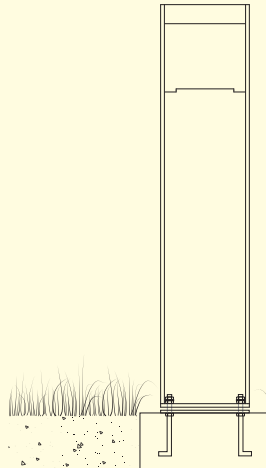

Incorrect Fixing Method

Do not fix the bollard directly on the ground

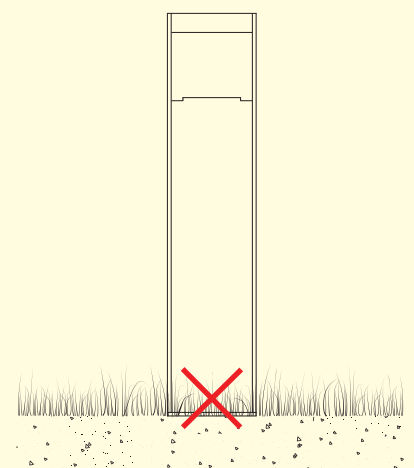



- Cylindrical light for installation on wall or as a bollard light.
- Configuration: stainless steel top disc, turned aluminium junction, extruded aluminium pole and die-cast aluminium base, EN AB-47100 alloy (low copper content). Polycarbonate diffuser: LED: opal; fluorescent: transparent with metal antiglare louvre.
- Double layer coating for high resistance to corrosion: the aluminium components are painted with a double coat using powders which are compliant with QUALICOAT standards: a first layer of epoxy powder (with excellent chemical and mechanical resistance) and a second finishing layer of polyester powder (resistant to UV rays and atmospheric agents). The entire painting process of the aluminium fitting starts from components which have been sandblasted in advance to make the surface more porous and increase the adherence of the paint. Ares effects alkaline and acid washing to clean the surfaces completely, then rinses with demineralised water to remove any residue particles, subsequently a chemical conversion treatment is done to protect against rusting.
- Protection rating: IP65
- In compliance with EN 60598-1 standards
- Class of insulation: I
- Installation: the luminaire is equipped with a piece of cable with a 2-way connector for 3-conductor cables for an easy-to-make connection. New Torcia LED: direct connection to the mains. Outdoor use requires suitable flexible cables. Pole with base: direct fixation with bolts to a concrete surface or through a dedicated fixing plate (to be ordered separately) in a concrete basement; Pole in-ground: for a better stability, we recommend to concrete the root of the pole.
- We recommend the use of a connection system with a protection degree greater than or equal to the protection degree of the luminaire.
- During the installation and the maintenance of the fixtures it is important to be careful and avoid damages on the paint coating. Damages on the coating exposed to outdoor conditions or water, could cause corrosion. Chemical substances affect the anticorrosion covering protection.

EU Regulation 874/2012 - Illumination equipment energy classes



LED VERSION:
Class A/A+/A++
Luminaire supplied
with integrated LED modules
that cannot be replaced

FLUORESCENT VERSION:
Class A
TC-DEL/G24q-2
TC-DEL/G24q-3



.1 White



.6 Grey



.3 Anthracite



.4 Black



.18 Deep Brown



Bollard Light



Wall fitting



Pre-wired with approx
150mm of cable from
the head.
Connection to be done
inside the pole



Protection against
impact.
IK 09 - 10,00 joule

New Torcia - Wall Version

Light Source: Mid-Power LED / 8W / Total power 9W / CRI>80 / 220÷230V



528005
White 3000K
Lm LED 700 ≈ lm OUTPUT 630

528004
White 4000K
Lm LED 740 ≈ lm OUTPUT 665

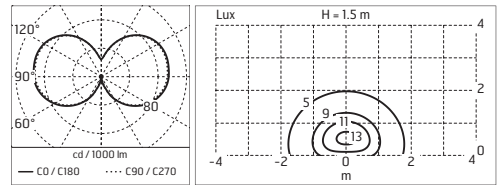

@4000K

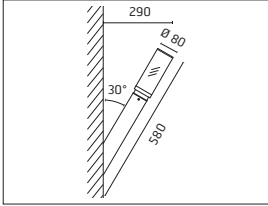

LED module set up to work directly connected to the mains

IP65

New Torcia - Pole Version - Direct 230V

Light Source: Mid-Power LED / 8W / CRI>80 / 220÷230V



528010
White 3000K
Total power 8,7W
Lm LED 700 ≈ lm OUTPUT 630

528009
White 4000K
Total power 9W
Lm LED 740 ≈ lm OUTPUT 665

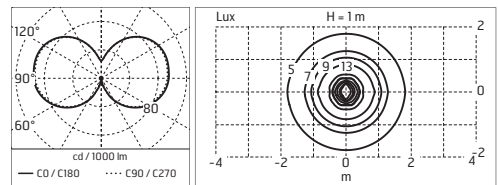

@4000K

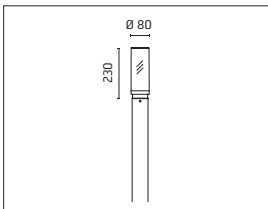

LED module set up to work directly connected to the mains

IP65

New Torcia / Poles



1505
H. 500 mm

1509
H. 900 mm

1512
H. 1200 mm

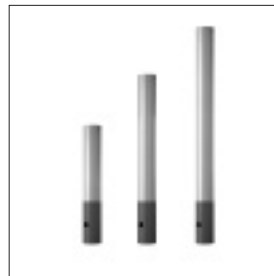

1605
H. 500 (+300) mm

1609
H. 900 (+300) mm

1612
H. 1200 (+300) mm

with Base

In-Ground (+300 mm Root)





Accessories: New Torcia

21
BASE PLATE AND FIXING BOLTS
174 x h 200mm

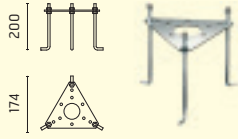

185.A
HIGH RESISTANCE IN-GROUND
FIXING BASE

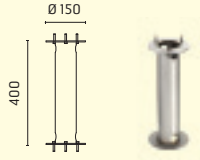

237
SPD: (SURGE PROTECTION DEVICE)
275Vac
MAXIMUM DISCHARGE CURRENT
10KA (8/20µs)
MAXIMUM OPERATING CURRENT 5A
SUITABLE FOR SERIES CONNEC-
TION - IP66

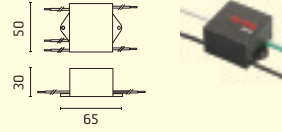

acc. code ▶	21	185.A	237
prod. code ▼			
528004			•
528005			•
528009			•
528010			•
1505	•	•	
1509	•	•	
1512	•	•	
1605			
1609			
1610			

Correct Fixing Method
Bollard fixed on plinth +
suitable installation screws

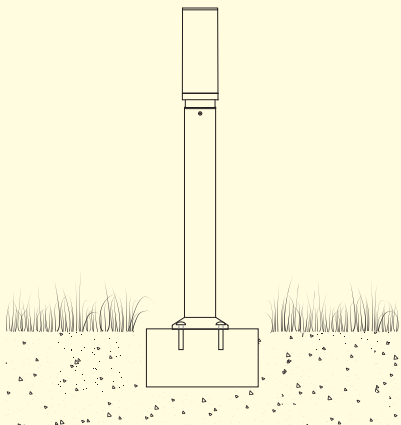

Correct Fixing Method
Bollard fixed on plinth + fixing bolts

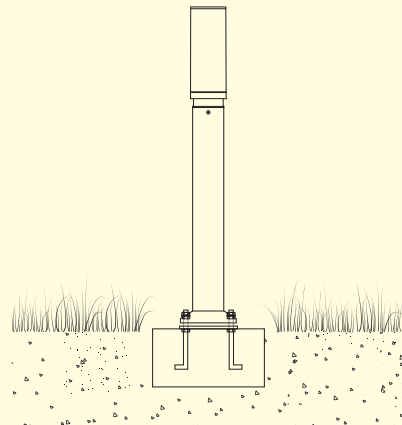

Incorrect Fixing Method
Do not fix the bollard directly on the ground

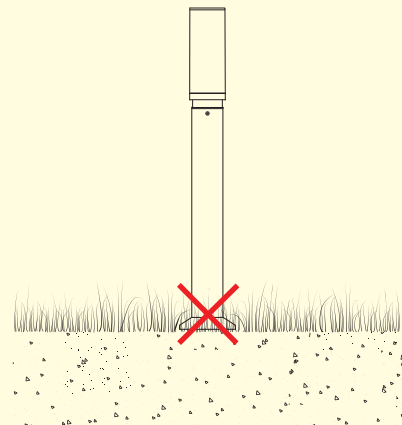

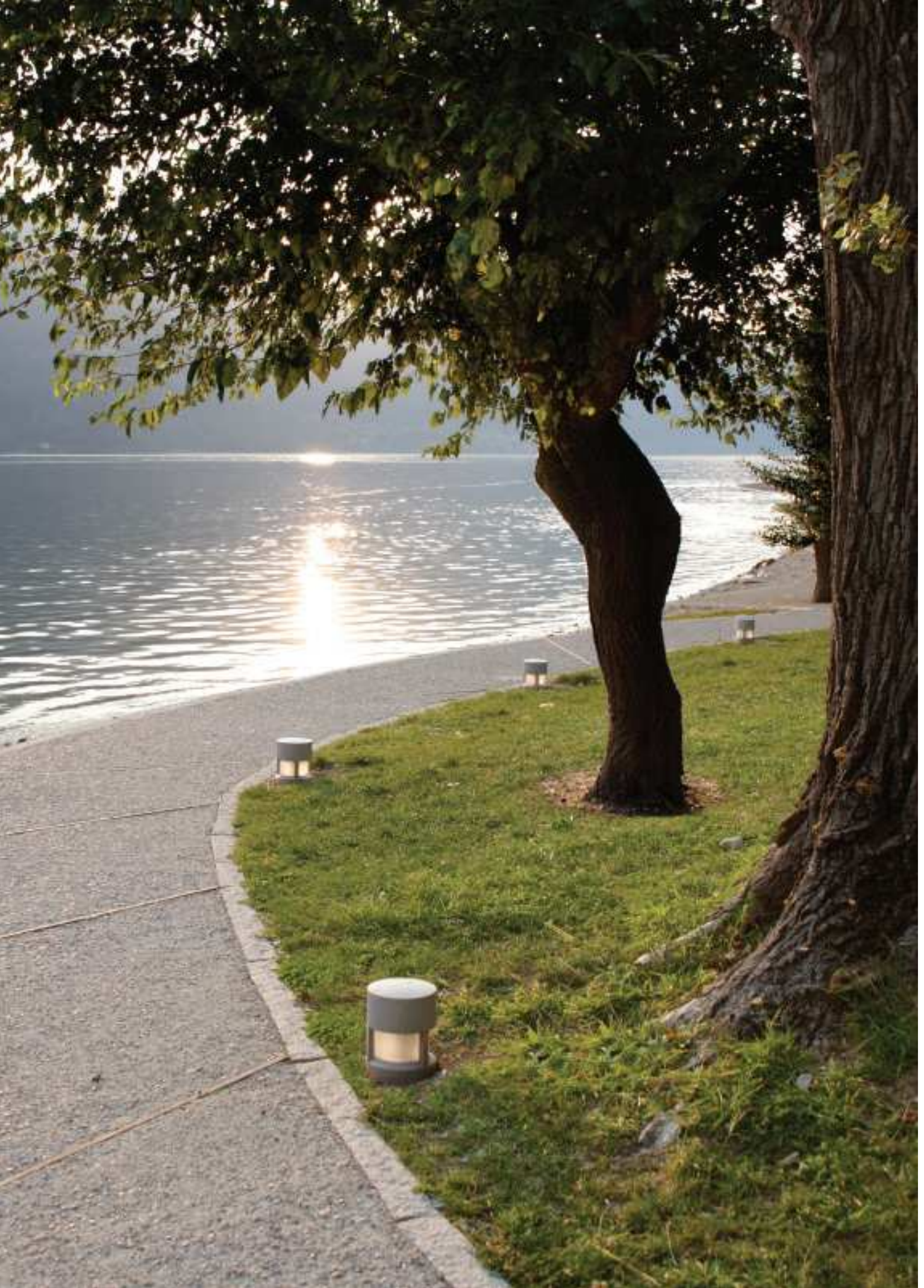

- Cylindrical light for installation on wall, ceiling and floor or as a bollard light – surface.
- Configuration: die-cast aluminium structure, EN AB-47100 alloy (low copper content), extruded aluminium pole (version “on post”). Borosilicate diffuser: transparent or sandblasted.
- Double layer coating for high resistance to corrosion: the aluminium components are painted with a double coat using powders which are compliant with QUALICOAT standards: a first layer of epoxy powder (with excellent chemical and mechanical resistance) and a second finishing layer of polyester powder (resistant to UV rays and atmospheric agents). The entire painting process of the aluminium fitting starts from components which have been sandblasted in advance to make the surface more porous and increase the adherence of the paint. Ares effects alkaline and acid washing to clean the surfaces completely, then rinses with demineralised water to remove any residue particles, subsequently a chemical conversion treatment is done to protect against rusting.
- Protection rating: IP65
- In compliance with EN 60598-1 standards
- Class of insulation: I
- Installation: Mini Silvia: the luminaire is equipped with one M16 cable gland (4,5\times10mm cables) placed under the head of the luminaire. Mini Silvia on post: the luminaire is equipped with a piece of cable and a watertight 3-ways connector (for cables 5\times13mm) for direct or end-to-end connection. Outdoor use requires suitable flexible cables. We recommend installation on a concrete basement or surface, directly with bolts or through the dedicated fixing plate (to be ordered separately).
- We recommend the use of a connection system with a protection degree greater than or equal to the protection degree of the luminaire.
- During the installation and the maintenance of the fixtures it is important to be careful and avoid damages on the paint coating. Damages on the coating exposed to outdoor conditions or water, could cause corrosion. Chemical substances affect the anticorrosion covering protection.

EU Regulation 874/2012 - Illumination equipment energy classes

A+  **METAL HALIDE VERSION:**
Class A+
HIT-TC-CE/G8,5

D  **HALOGEN VERSION:**
Class D
QT32/E27

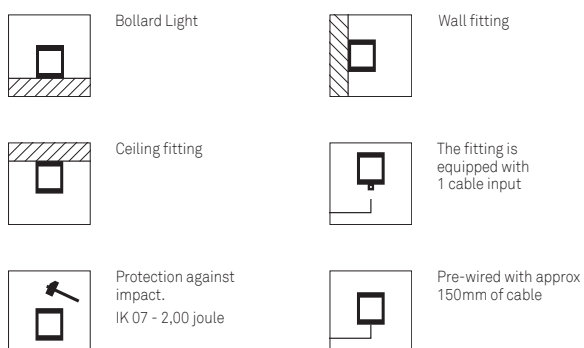

MiniSilvia - Sandblasted Glass - 120° Emission



930121
 QT 32 60W E27
 Lamp max size: Ø40 mm H.115 mm

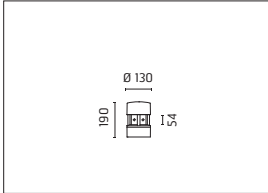
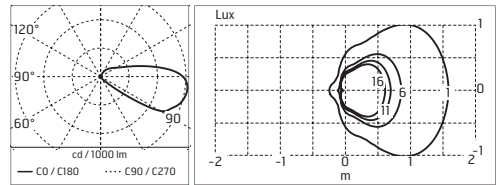

IP65

MiniSilvia - Sandblasted Glass - 360° Emission



930100
 QT 32 60W E27
 Lamp max size: Ø40 mm H.115 mm

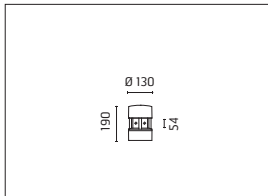
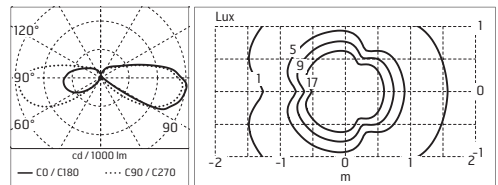

IP65

MiniSilvia on post - H. 550 mm - Sandblasted Glass - 120° Emission



930181
 QT 32 60W E27
 Lamp max size: Ø40 mm H.115 mm

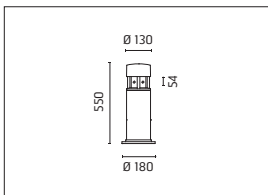
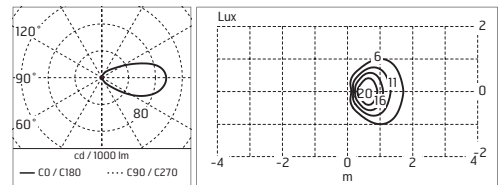

IP65

MiniSilvia on post - H. 550 mm - Sandblasted Glass - 360° Emission



930178
 QT 32 60W E27
 Lamp max size: Ø40 mm H.115 mm

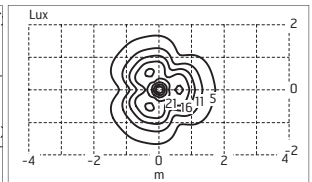
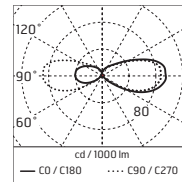
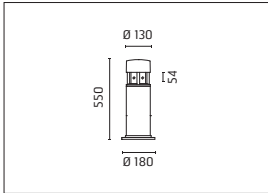

IP65

MiniSilvia on post - H. 950 mm - Sandblasted Glass - 120° Emission



930182
 QT 32 60W E27
 Lamp max size: Ø40 mm H.115 mm

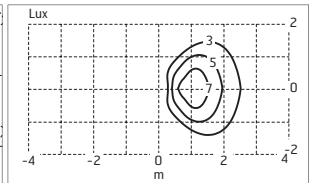
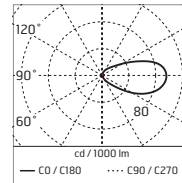
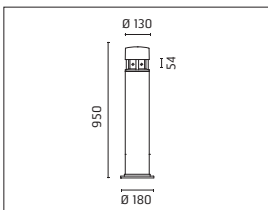

IP65

MiniSilvia on post - H. 950 mm - Sandblasted Glass - 360° Emission



930179
 QT 32 60W E27
 Lamp max size: Ø40 mm H.115 mm

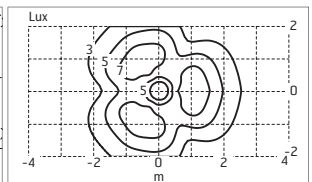
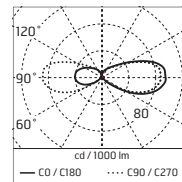
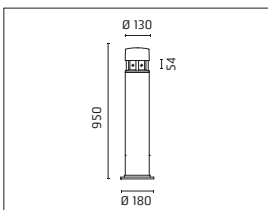

IP65

MiniSilvia on post - H. 550 mm - Transparent Glass - 120° Emission



936787
HIT-TC-CE 35W G8,5

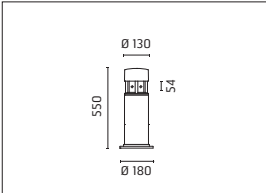
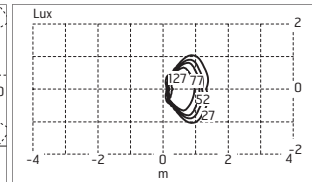
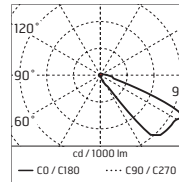

Electronic ballast

IP65

MiniSilvia on post - H. 550 mm - Transparent Glass - 360° Emission



936784
HIT-TC-CE 35W G8,5

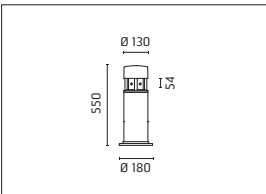
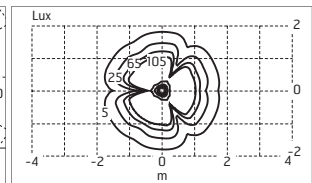
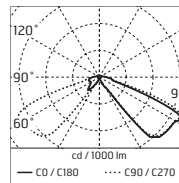

Electronic ballast

IP65

MiniSilvia on post - H. 950 mm - Transparent Glass - 120° Emission



936788
HIT-TC-CE 35W G8,5

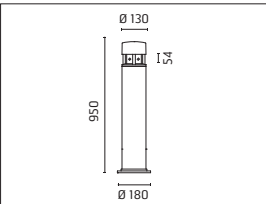
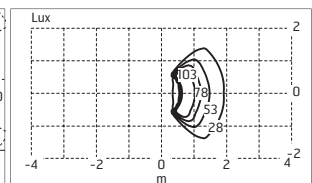
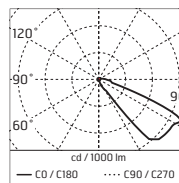

Electronic ballast

IP65

MiniSilvia on post - H. 950 mm - Transparent Glass - 360° Emission



936785
HIT-TC-CE 35W G8,5

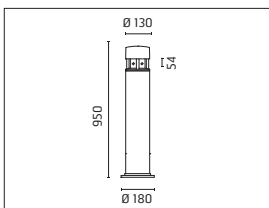
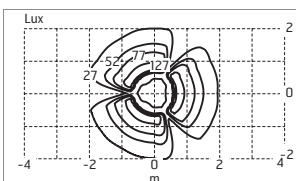
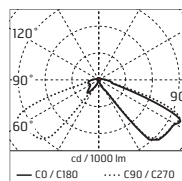

Electronic ballast

IP65

Accessories: MiniSilvia - MiniSilvia on post

21
BASE PLATE AND FIXING BOLTS
174 x h 200mm

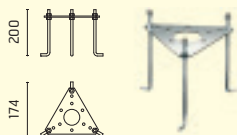

260
HIGH RESISTANCE IN-GROUND
FIXING BASE

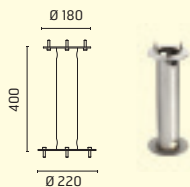

acc. code	21	260
930100		
930121		
930178	•	•
930179	•	•
930181	•	•
930182	•	•
936784	•	•
936785	•	•
936787	•	•
936788	•	•

Correct Fixing Method
Bollard fixed on plint + suitable installation screws

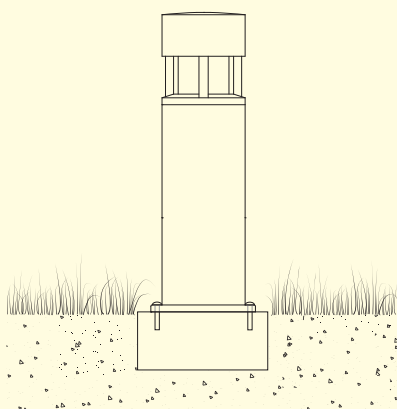

Correct Fixing Method
Bollard fixed on plinth + fixing bolts

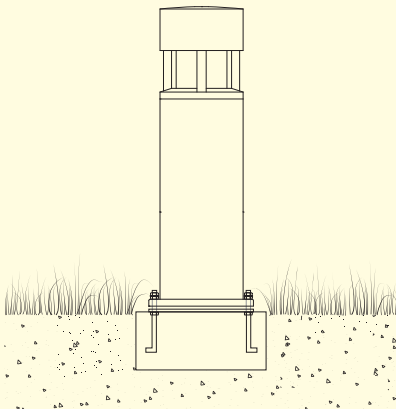

Incorrect Fixing Method
Do not fix the bollard directly on the ground

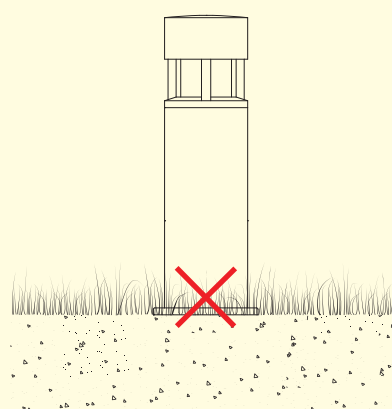



- Cylindrical light for installation on wall, ceiling and floor or as a bollard light – surface.
- Configuration: die-cast aluminium structure, EN AB-47100 alloy (low copper content), extruded aluminium pole (version “on post”). Borosilicate diffuser: transparent or sandblasted.
- Double layer coating for high resistance to corrosion: the aluminium components are painted with a double coat using powders which are compliant with QUALICOAT standards: a first layer of epoxy powder (with excellent chemical and mechanical resistance) and a second finishing layer of polyester powder (resistant to UV rays and atmospheric agents). The entire painting process of the aluminium fitting starts from components which have been sandblasted in advance to make the surface more porous and increase the adherence of the paint. Ares effects alkaline and acid washing to clean the surfaces completely, then rinses with demineralised water to remove any residue particles, subsequently a chemical conversion treatment is done to protect against rusting.
- Protection rating: IP65
- In compliance with EN 60598-1 standards
- Class of insulation: I
- Installation: Silvia: the luminaire is equipped with one M20 cable gland (6\times12mm cables) placed under the head of the luminaire. Silvia on post: the luminaire is equipped with a piece of cable and a watertight 3-ways connector (for cables 5\times13mm) for direct or end-to-end connection.
- Outdoor use requires suitable flexible cables. We recommend installation on a concrete basement or surface, directly with bolts or through the dedicated fixing plate (to be ordered separately).
- We recommend the use of a connection system with a protection degree greater than or equal to the protection degree of the luminaire.
- During the installation and the maintenance of the fixtures it is important to be careful and avoid damages on the paint coating. Damages on the coating exposed to outdoor conditions or water, could cause corrosion. Chemical substances affect the anticorrosion covering protection.

EU Regulation 874/2012 - Illumination equipment energy classes

A⁺ **METAL HALIDE VERSION:**
Class A+
HIT-CE/G12

D **HALOGEN VERSION:**
Class D
QT32/E27

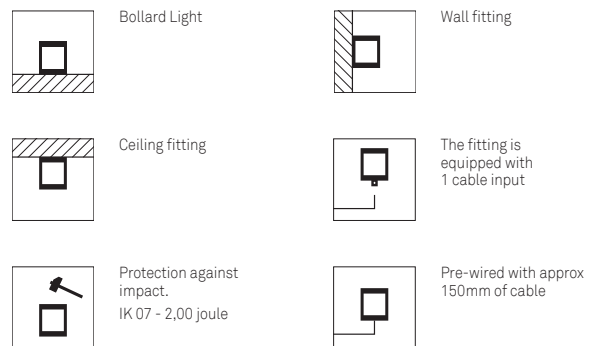

Silvia - Sandblasted Glass - 120° Emission



850121
 QT 32 100W E27
 Lamp max size: Ø40 mm H.125 mm

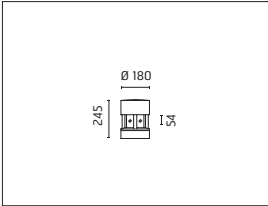
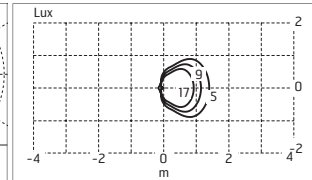
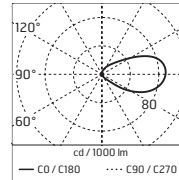

853521
 HIT-CE 35W G12

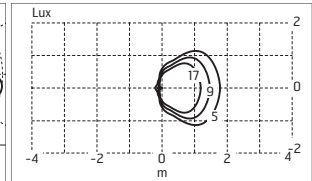
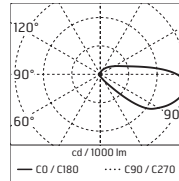

IP65

Silvia - Sandblasted Glass - 360° Emission



850100
 QT 32 100W E27
 Lamp max size: Ø40 mm H.125 mm

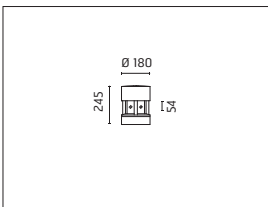
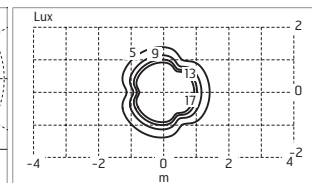
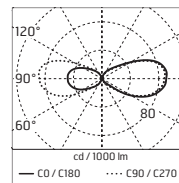

853500
 HIT-CE 35W G12

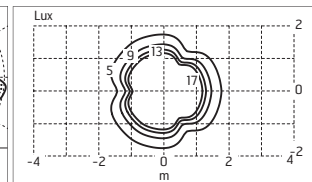
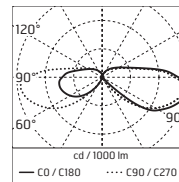

IP65

Silvia - Sandblasted Glass - 120° Emission



850175
 QT 32 100W E27
 Lamp max size: Ø40 mm H.125 mm

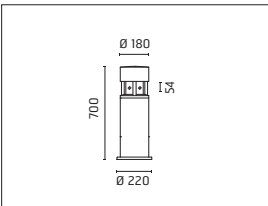
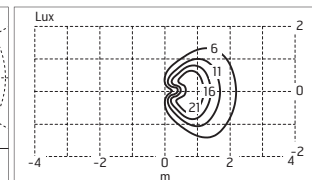
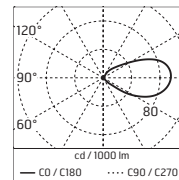

853575
 HIT-CE 35W G12

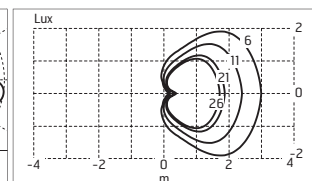
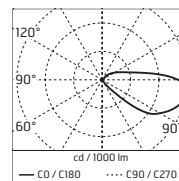

IP65

Silvia on post - H. 700 mm - Sandblasted Glass - 360° Emission



850173
 QT 32 100W E27
 Lamp max size: Ø40 mm H.125 mm

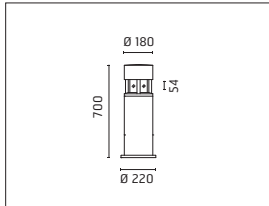

853573
 HIT-CE 35W G12

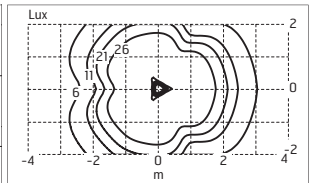
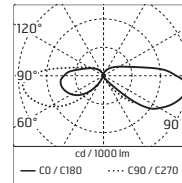
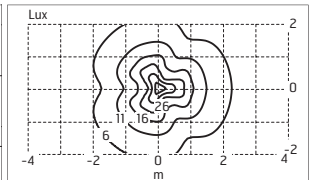
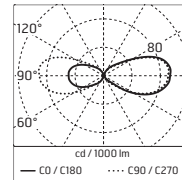

IP65

Silvia on post - H. 1200 mm - Sandblasted Glass - 120° Emission



850176
 QT 32 100W E27
 Lamp max size: Ø40 mm H.125 mm

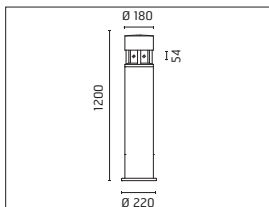

853576
 HIT-CE 35W G12

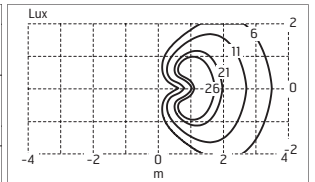
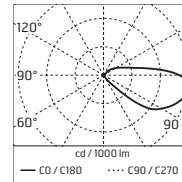
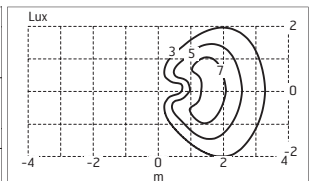
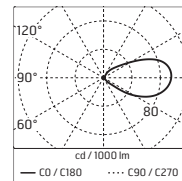

IP65

Silvia on post - H. 1200 mm - Sandblasted Glass - 360° Emission



850174
 QT 32 100W E27
 Lamp max size: Ø40 mm H.125 mm

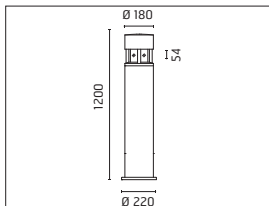

853574
 HIT-CE 35W G12

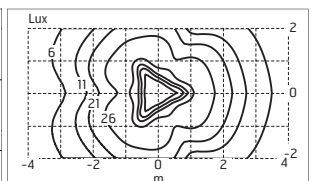
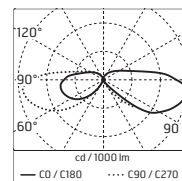
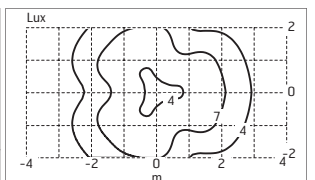
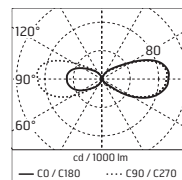

IP65

Silvia on post - H. 700 mm - Transparent Glass - 120° Emission



850169
 QT 32 100W E27
 Lamp max size: Ø40 mm H.125 mm

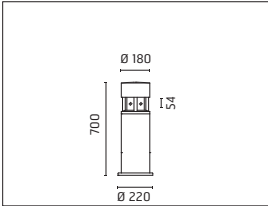
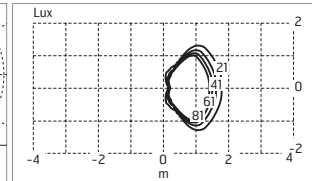
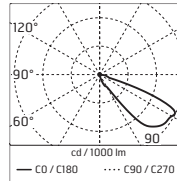
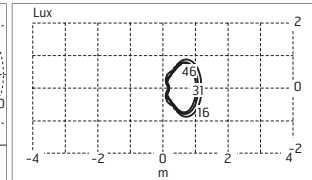
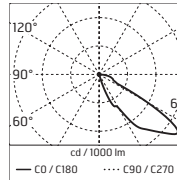

IP65

Silvia on post - H. 700 mm - Transparent Glass - 360° Emission



850167
 QT 32 100W E27
 Lamp max size: Ø40 mm H.125 mm

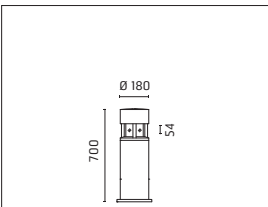
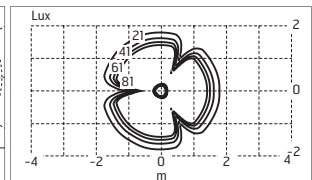
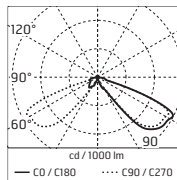
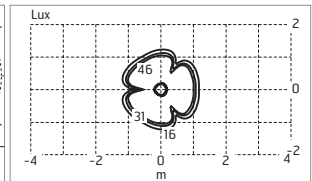
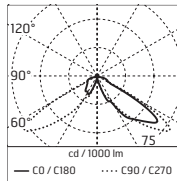

IP65

Silvia on post - H. 1200 mm - Transparent Glass - 120° Emission



850170
 QT 32 100W E27
 Lamp max size: Ø40 mm H.125 mm

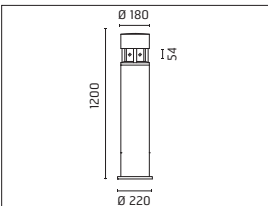
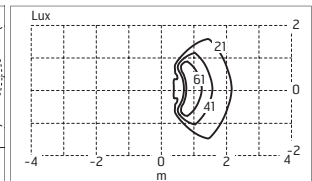
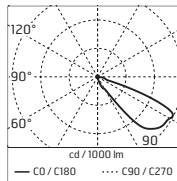
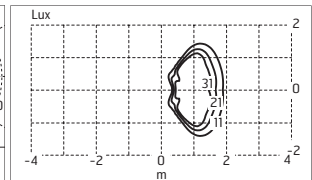
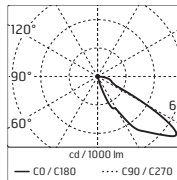

853570
 HIT-CE 35W G12

857170
 HIT-CE 70W G12

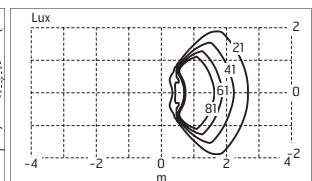
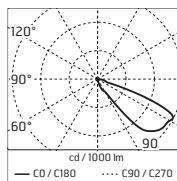

IP65

Silvia on post - H. 1200 mm - Transparent Glass - 360° Emission



850168
 QT 32 100W E27
 Lamp max size: Ø40 mm H.125 mm

853568
 HIT-CE 35W G12

857168
 HIT-CE 70W G12

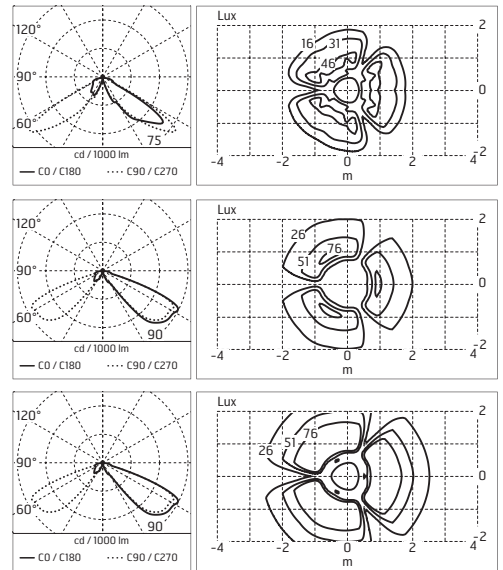
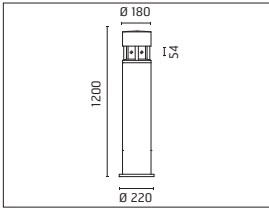

IP65

Accessories: Silvia - Silvia on post

21
 BASE PLATE AND FIXING BOLTS
 174 x h 200mm

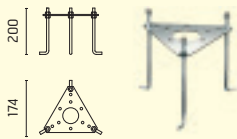

260
 HIGH RESISTANCE IN-GROUND
 FIXING BASE

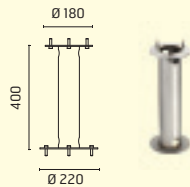

acc. code ▶	21	260	acc. code ▶	21	260
850100			853567	•	•
850121			853568	•	•
850167	•	•	853569	•	•
850168	•	•	853570	•	•
850169	•	•	853573	•	•
850170	•	•	853574	•	•
850173	•	•	853575	•	•
850174	•	•	853576	•	•
850175	•	•	857167	•	•
850176	•	•	857168	•	•
853500			857169	•	•
853521			857170	•	•

Correct Fixing Method
 Bollard fixed on plint +
 suitable installation screws

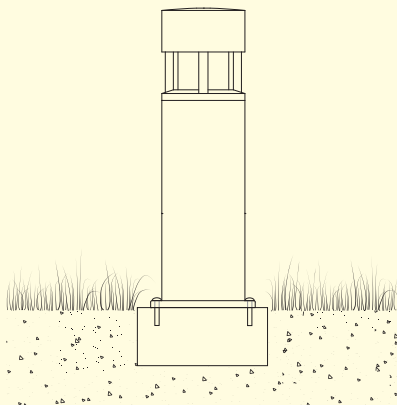

Correct Fixing Method
 Bollard fixed on plinth + fixing bolts

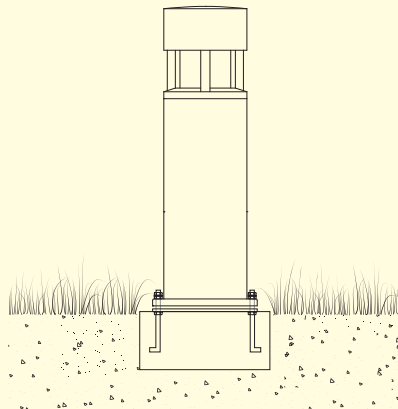

Incorrect Fixing Method
 Do not fix the bollard directly on the ground

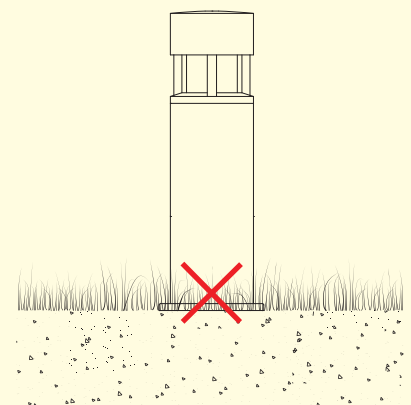

Silvia - Silvia on post



- Projector for installation on wall or on pole (Ø76mm or Ø102mm).
- Configuration: extruded aluminium structure with die-cast closing ends, EN AB-47100 alloy (low copper content). Glass diffuser: extra-clear with silk-screen border, fixed to the aluminium through a robotic gluing system.
- Double layer coating for high resistance to corrosion: the aluminium components are painted with a double coat using powders which are compliant with QUALICOAT standards: a first layer of epoxy powder (with excellent chemical and mechanical resistance) and a second finishing layer of polyester powder (resistant to UV rays and atmospheric agents). The entire painting process of the aluminium fitting starts from components which have been sand-blasted in advance to make the surface more porous and increase the adherence of the paint. Ares effects alkaline and acid washing to clean the surfaces completely, then rinses with demineralised water to remove any residue particles, subsequently a chemical conversion treatment is done to protect against rusting.
- Protection rating: IP65
- In compliance with EN60598-1 standards
- Class of insulation: I
- Installation: the luminaire is equipped with 400mm cable and a 2-way terminal block for 3-conductor cables - IP68.
- During the installation and the maintenance of the fixtures it is important to be careful and avoid damages on the paint coating.
Damages on the coating exposed to outdoor conditions or water, could cause corrosion.
Chemical substances affect the anticorrosion covering protection.

EU Regulation 874/2012 - Illumination equipment energy classes



LED VERSION:
Class A/A+/A++
Luminaire supplied
with integrated LED modules
that cannot be replaced



.6 Grey



.3 Anthracite



Wall fitting



Installation on pole



Pre-wired with approx
400mm of cable



Protection against
impact
IK 09 - 10,00 joule

Dooku400 - Wall Version - Adjustable - 120° (Wide Spaces - Public Areas - Parking Areas)

Light Source: Power LED / 33,6W / Total power 39W / CRI>80 / 220÷240V / Integral electronic power supply



539076
539076-300 Dimmable Dali
539076-310 Dimmable 1-10
 White 2700K
 lm LED 3723 ≠ lm OUTPUT 2946

539075
539075-300 Dimmable Dali
539075-310 Dimmable 1-10
 White 3000K
 lm LED 4003 ≠ lm OUTPUT 3168

539074
539074-300 Dimmable Dali
539074-310 Dimmable 1-10
 White 4000K
 lm LED 4262 ≠ lm OUTPUT 3374

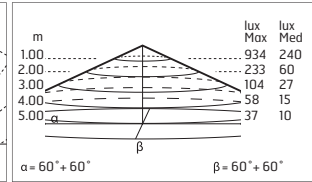
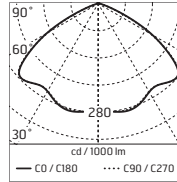

@4000K

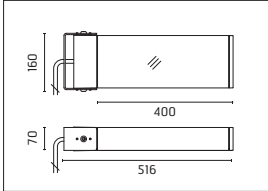

Smart city version on request

IP65

Dooku400 - Wall Version - Adjustable - Asymmetric optic

Light Source: Power LED / 33,6W / Total power 39W / CRI>80 / 220÷240V / Integral electronic power supply



539130
539130-300 Dimmable Dali
539130-310 Dimmable 1-10
 White 2700K
 lm LED 3723 ≠ lm OUTPUT 2853

539148
539148-300 Dimmable Dali
539148-310 Dimmable 1-10
 White 3000K
 lm LED 4003 ≠ lm OUTPUT 2941

539166
539166-300 Dimmable Dali
539166-310 Dimmable 1-10
 White 4000K
 lm LED 4262 ≠ lm OUTPUT 3131

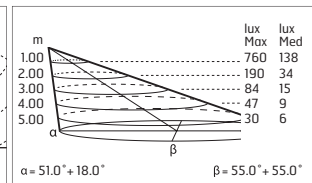
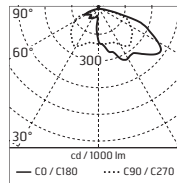

@4000K

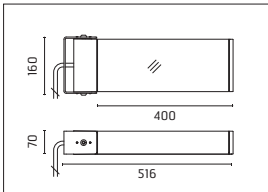

Smart city version on request

IP65



Dooku400 - Pole Ø 76mm - Single Top Pole - 120° (Wide Spaces - Public Areas - Parking Areas)

Light Source: Power LED / 33,6W / Total power 39W / CRI>80 / 220÷240V / Integral electronic power supply



539078
539078-300 Dimmable Dali
539078-310 Dimmable 1-10
 White 2700K
 lm LED 3723 ≠ lm OUTPUT 2946

539039
539039-300 Dimmable Dali
539039-310 Dimmable 1-10
 White 3000K
 lm LED 4003 ≠ lm OUTPUT 3168

539038
539038-300 Dimmable Dali
539038-310 Dimmable 1-10
 White 4000K
 lm LED 4262 ≠ lm OUTPUT 3374

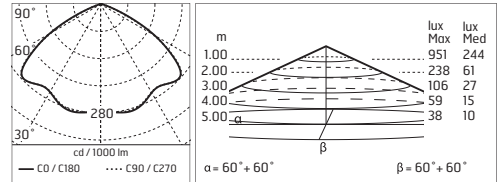

@4000K

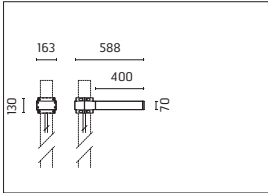

Smart city version on request

IP65

Dooku400 - Pole Ø 76mm - Single Top Pole - Asymmetric optic

Light Source: Power LED / 33,6W / Total power 39W / CRI>80 / 220÷240V / Integral electronic power supply



539132
539132-300 Dimmable Dali
539132-310 Dimmable 1-10
 White 2700K
 lm LED 3723 ≠ lm OUTPUT 2853

539150
539150-300 Dimmable Dali
539150-310 Dimmable 1-10
 White 3000K
 lm LED 4003 ≠ lm OUTPUT 2941

539168
539168-300 Dimmable Dali
539168-310 Dimmable 1-10
 White 4000K
 lm LED 4262 ≠ lm OUTPUT 3131

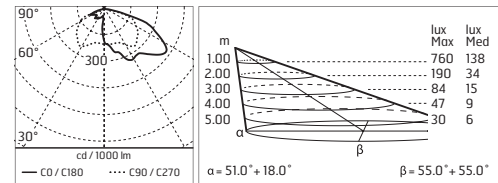

@4000K

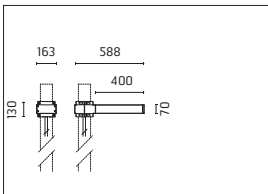

Smart city version on request

IP65

Dooku400 - Pole Ø 76mm - Single Top Pole - Street Light Optic

Light Source: Power LED / 33,6W / Total power 39W / CRI >80 / 220÷240V / Integral electronic power supply



539080
539080-300 Dimmable Dali
539080-310 Dimmable 1-10
 White 2700K
 lm LED 3723 ≠ lm OUTPUT 2727

539042
539042-300 Dimmable Dali
539042-310 Dimmable 1-10
 White 3000K
 lm LED 4003 ≠ lm OUTPUT 2932

539041
539041-300 Dimmable Dali
539041-310 Dimmable 1-10
 White 4000K
 lm LED 4262 ≠ lm OUTPUT 3121

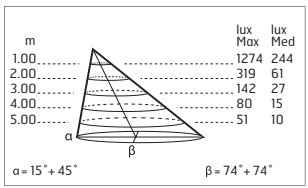
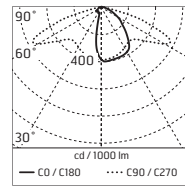
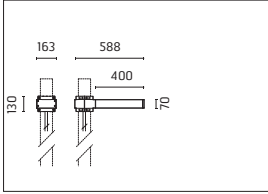

@4000K

Smart city version on request



Dooku400 - Pole Ø 76mm - Single Top Pole - Street Light Optic (Foot and Cycle Paths)

Light Source: Power LED / 33,6W / Total power 39W / CRI >80 / 220÷240V / Integral electronic power supply



539082
539082-300 Dimmable Dali
539082-310 Dimmable 1-10
 White 2700K
 lm LED 3723 ≠ lm OUTPUT 2744

539045
539045-300 Dimmable Dali
539045-310 Dimmable 1-10
 White 3000K
 lm LED 4003 ≠ lm OUTPUT 2950

539044
539044-300 Dimmable Dali
539044-310 Dimmable 1-10
 White 4000K
 lm LED 4262 ≠ lm OUTPUT 3141

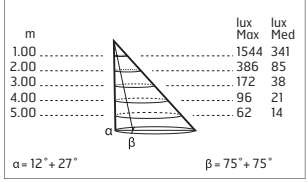
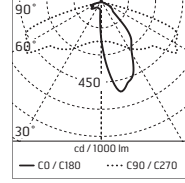
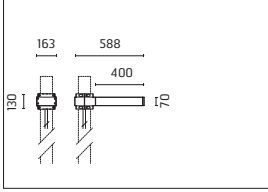

@4000K

Smart city version on request



Dooku400 - Pole Ø 76mm - Double Top Pole - 120° (Wide Spaces - Public Areas - Parking Areas)

Light Source: Power LED / 2x33,6W / Total power 2x39W / CRI>80 / 220÷240V / Integral electronic power supply



539084
539084-300 Dimmable Dali
539084-310 Dimmable 1-10
 White 2700K
 lm LED 2x3723 ≠ lm OUTPUT 2x2946

539048
539048-300 Dimmable Dali
539048-310 Dimmable 1-10
 White 3000K
 lm LED 2x4003 ≠ lm OUTPUT 2x3168

539047
539047-300 Dimmable Dali
539047-310 Dimmable 1-10
 White 4000K
 lm LED 2x4262 ≠ lm OUTPUT 2x3374

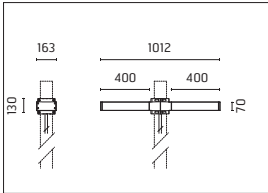
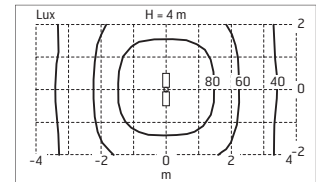

Smart city version on request

IP65

Dooku400 - Pole Ø 76mm - Double Top Pole - Asymmetric optic

Light Source: Power LED / 2x33,6W / Total power 2x39W / CRI>80 / 220÷240V / Integral electronic power supply



539134
539134-300 Dimmable Dali
539134-310 Dimmable 1-10
 White 2700K
 lm LED 2x3723 ≠ lm OUTPUT 2x2853

539152
539152-300 Dimmable Dali
539152-310 Dimmable 1-10
 White 3000K
 lm LED 2x4003 ≠ lm OUTPUT 2x2941

539170
539170-300 Dimmable Dali
539170-310 Dimmable 1-10
 White 4000K
 lm LED 2x4262 ≠ lm OUTPUT 2x3131

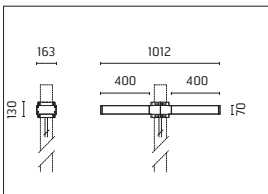
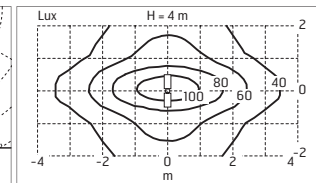
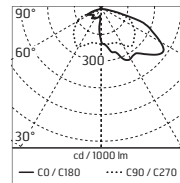

Smart city version on request

IP65

Dooku400 - Pole Ø 76mm - Double Top Pole - Street Light Optic

Light Source: Power LED / 2x33,6W / Total power 2x39W / CRI>80 / 220÷240V / Integral electronic power supply



539086
539086-300 Dimmable Dali
539086-310 Dimmable 1-10
 White 2700K
 lm LED 2x3723 ≈ lm OUTPUT 2x2727

539051
539051-300 Dimmable Dali
539051-310 Dimmable 1-10
 White 3000K
 lm LED 2x4003 ≈ lm OUTPUT 2x2932

539050
539050-300 Dimmable Dali
539050-310 Dimmable 1-10
 White 4000K
 lm LED 2x4262 ≈ lm OUTPUT 2x3121

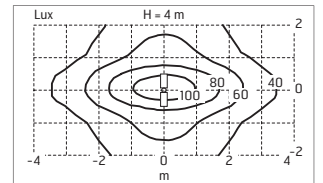

@4000K

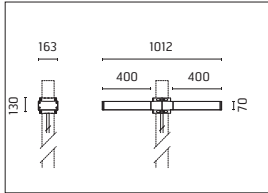

Smart city version on request

IP65

Dooku400 - Pole Ø 76mm - Double Top Pole - Street Light Optic (Foot and Cycle Paths)

Light Source: Power LED / 2x33,6W / Total power 2x39W / CRI>80 / 220÷240V/Integral electronic power supply



539088
539088-300 Dimmable Dali
539088-310 Dimmable 1-10
 White 2700K
 lm LED 2x3723 ≈ lm OUTPUT 2x2744

539054
539054-300 Dimmable Dali
539054-310 Dimmable 1-10
 White 3000K
 lm LED 2x4003 ≈ lm OUTPUT 2x2950

539053
539053-300 Dimmable Dali
539053-310 Dimmable 1-10
 White 4000K
 lm LED 2x4262 ≈ lm OUTPUT 2x3141

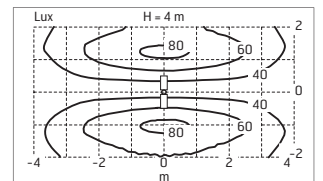

@4000K

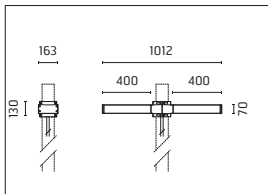

Smart city version on request

IP65

Dooku400 - Pole Ø 102mm - Single Top Pole - 120° (Wide Spaces - Public Areas - Parking Areas)

Light Source: Power LED / 33,6W / Total power 39W / CRI>80 / 220÷240V / Integral electronic power supply



539090
539090-300 Dimmable Dali
539090-310 Dimmable 1-10
 White 2700K
 lm LED 3723 ≠ lm OUTPUT 2946

539057
539057-300 Dimmable Dali
539057-310 Dimmable 1-10
 White 3000K
 lm LED 4003 ≠ lm OUTPUT 3168

539056
539056-300 Dimmable Dali
539056-310 Dimmable 1-10
 White 4000K
 lm LED 4262 ≠ lm OUTPUT 3374

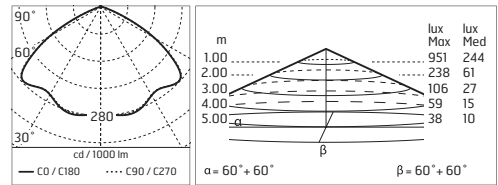

@4000K

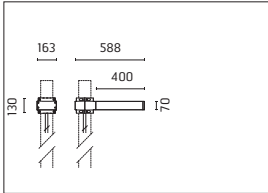

Smart city version on request

IP65

Dooku400 - Pole Ø 102mm - Single Top Pole - Asymmetric optic

Light Source: Power LED / 33,6W / Total power 39W / CRI>80 / 220÷240V / Integral electronic power supply



539136
539136-300 Dimmable Dali
539136-310 Dimmable 1-10
 White 2700K
 lm LED 3723 ≠ lm OUTPUT 2853

539154
539154-300 Dimmable Dali
539154-310 Dimmable 1-10
 White 3000K
 lm LED 4003 ≠ lm OUTPUT 2941

539172
539172-300 Dimmable Dali
539172-310 Dimmable 1-10
 White 4000K
 lm LED 4262 ≠ lm OUTPUT 3131

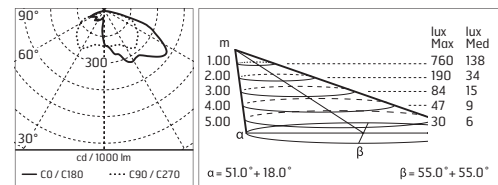

@4000K

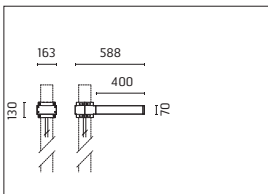

Smart city version on request

IP65

Dooku400 - Pole Ø 102mm - Single Top Pole - Street Light Optic

Light Source: Power LED / 33,6W / Total power 39W / CRI>80 / 220÷240V / Integral electronic power supply



539092
539092-300 Dimmable Dali
539092-310 Dimmable 1-10
 White 2700K
 lm LED 3723 ≠ lm OUTPUT 2727

539060
539060-300 Dimmable Dali
539060-310 Dimmable 1-10
 White 3000K
 lm LED 4003 ≠ lm OUTPUT 2932

539059
539059-300 Dimmable Dali
539059-310 Dimmable 1-10
 White 4000K
 lm LED 4262 ≠ lm OUTPUT 3121

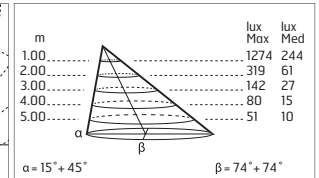
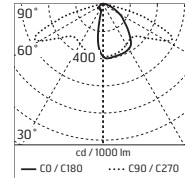

@4000K

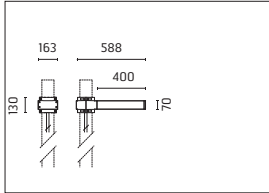

Smart city version on request

IP65

Dooku400 - Pole Ø 102mm - Single Top Pole - Street Light Optic (Foot and Cycle Paths)

Light Source: Power LED / 33,6W / Total power 39W / CRI>80 / 220÷240V / Integral electronic power supply



539094
539094-300 Dimmable Dali
539094-310 Dimmable 1-10
 White 2700K
 lm LED 3723 ≠ lm OUTPUT 2744

539063
539063-300 Dimmable Dali
539063-310 Dimmable 1-10
 White 3000K
 lm LED 4003 ≠ lm OUTPUT 2950

539062
539062-300 Dimmable Dali
539062-310 Dimmable 1-10
 White 4000K
 lm LED 4262 ≠ lm OUTPUT 3141

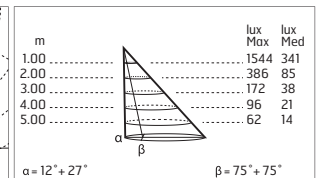
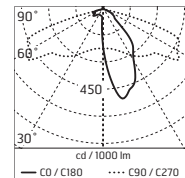

@4000K

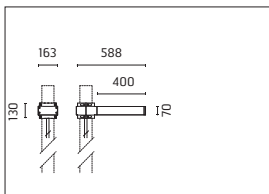

Smart city version on request

IP65

Dooku400 - Pole Ø 102mm - Double Top Pole - 120° (Wide Spaces - Public Areas - Parking Areas)

Light Source: Power LED / 2x33,6W / Total power 2x39W / CRI>80 / 220÷240V / Integral electronic power supply



539096
539096-300 Dimmable Dali
539096-310 Dimmable 1-10
 White 2700K
 lm LED 2x3723 ≠ lm OUTPUT 2x2946

539066
539066-300 Dimmable Dali
539066-310 Dimmable 1-10
 White 3000K
 lm LED 2x4003 ≠ lm OUTPUT 2x3168

539065
539065-300 Dimmable Dali
539065-310 Dimmable 1-10
 White 4000K
 lm LED 2x4262 ≠ lm OUTPUT 2x3374

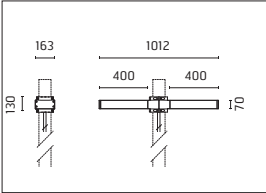
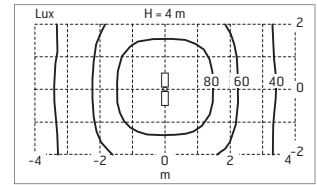

Smart city version on request

IP65

Dooku400 - Pole Ø 102mm - Double Top Pole - Asymmetric optic

Light Source: Power LED / 33,6W / Total power 39W / CRI>80 / 220÷240V / Integral electronic power supply



539138
539138-300 Dimmable Dali
539138-310 Dimmable 1-10
 White 2700K
 lm LED 2x3723 ≠ lm OUTPUT 2x2853

539156
539156-300 Dimmable Dali
539156-310 Dimmable 1-10
 White 3000K
 lm LED 2x4003 ≠ lm OUTPUT 2x2941

539174
539174-300 Dimmable Dali
539174-310 Dimmable 1-10
 White 4000K
 lm LED 2x4262 ≠ lm OUTPUT 2x3131

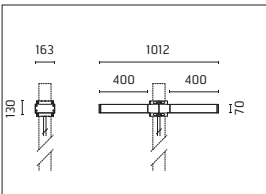
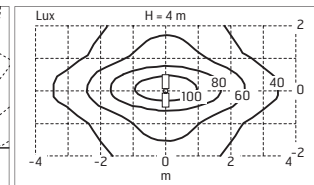
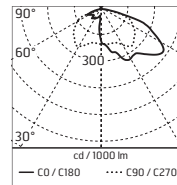

Smart city version on request

IP65

Dooku400 - Pole Ø 102mm - Double Top Pole - Street Light Optic

Light Source: Power LED / 2x33,6W / Total power 2x39W / CRI>80 / 220÷240V / Integral electronic power supply



539098
539098-300 Dimmable Dali
539098-310 Dimmable 1-10
 White 2700K
 lm LED 2x3723 ≠ lm OUTPUT 2x2727

539069
539069-300 Dimmable Dali
539069-310 Dimmable 1-10
 White 3000K
 lm LED 2x4003 ≠ lm OUTPUT 2x2932

539068
539068-300 Dimmable Dali
539068-310 Dimmable 1-10
 White 4000K
 lm LED 2x4262 ≠ lm OUTPUT 2x3121

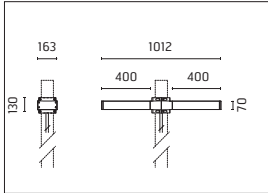
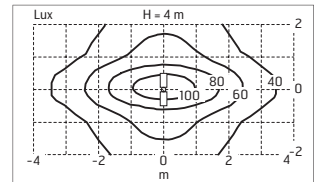

Smart city version on request

IP65

Dooku400 - Pole Ø 102mm - Double Top Pole - Street Light Optic (Foot and Cycle Paths)

Light Source: Power LED / 2x33,6W / Total power 2x39W / CRI>80 / 220÷240V / Integral electronic power supply



539100
539100-300 Dimmable Dali
539100-310 Dimmable 1-10
 White 2700K
 lm LED 2x3723 ≠ lm OUTPUT 2x2744

539072
539072-300 Dimmable Dali
539072-310 Dimmable 1-10
 White 3000K
 lm LED 2x4003 ≠ lm OUTPUT 2x2950

539071
539071-300 Dimmable Dali
539071-310 Dimmable 1-10
 White 4000K
 lm LED 2x4262 ≠ lm OUTPUT 2x3141

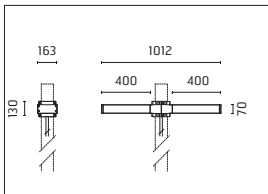
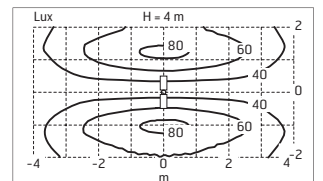

Smart city version on request

IP65

Dooku600 - Pole Ø 76mm - Single Top Pole - 120° (Wide Spaces - Public Areas - Parking Areas)

Light Source: Power LED / 67,2W / Total power 78W / CRI>80 / 220÷240V / Integral electronic power supply



539102
539102-300 Dimmable Dali
539102-310 Dimmable 1-10
 White 2700K
 lm LED 7446 ≠ lm OUTPUT 5893

539003
539003-300 Dimmable Dali
539003-310 Dimmable 1-10
 White 3000K
 lm LED 8006 ≠ lm OUTPUT 6337

539002
539002-300 Dimmable Dali
539002-310 Dimmable 1-10
 White 4000K
 lm LED 8524 ≠ lm OUTPUT 6748

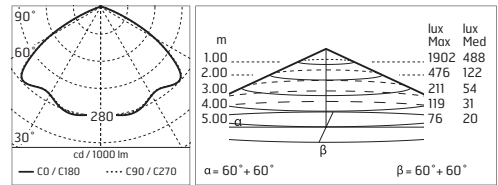

@4000K

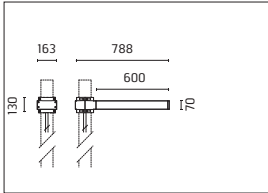

Smart city version on request

IP65

Dooku600 - Pole Ø 76mm - Single Top Pole - Asymmetric optic

Light Source: Power LED / 33,6W / Total power 39W / CRI>80 / 220÷240V / Integral electronic power supply



539140
539140-300 Dimmable Dali
539140-310 Dimmable 1-10
 White 2700K
 lm LED 7446 ≠ lm OUTPUT 5705

539158
539158-300 Dimmable Dali
539158-310 Dimmable 1-10
 White 3000K
 lm LED 8006 ≠ lm OUTPUT 5881

539176
539176-300 Dimmable Dali
539176-310 Dimmable 1-10
 White 4000K
 lm LED 8524 ≠ lm OUTPUT 6263

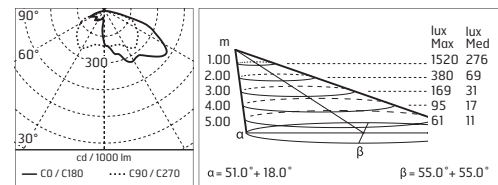

@4000K

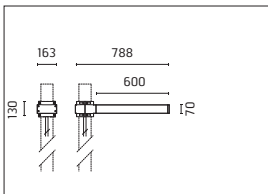

Smart city version on request

IP65

Dooku600 - Pole Ø 76mm - Single Top Pole - Street Light Optic

Light Source: Power LED / 67,2W / Total power 78W / CRI>80 / 220÷240V / Integral electronic power supply

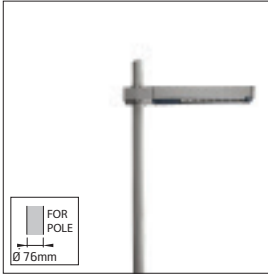

539104
539104-300 Dimmable Dali
539104-310 Dimmable 1-10
 White 2700K
 lm LED 7446 ≠ lm OUTPUT 5454

539006
539006-300 Dimmable Dali
539006-310 Dimmable 1-10
 White 3000K
 lm LED 8006 ≠ lm OUTPUT 5864

539005
539005-300 Dimmable Dali
539005-310 Dimmable 1-10
 White 4000K
 lm LED 8524 ≠ lm OUTPUT 6243

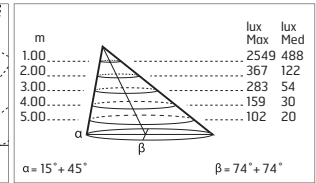
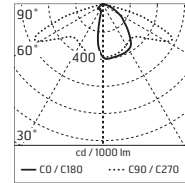
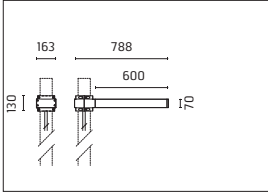

@4000K

Smart city version on request

IP65

Dooku600 - Pole Ø 76mm - Single Top Pole - Street Light Optic (Foot and Cycle Paths)

Light Source: Power LED / 67,2W / Total power 78W / CRI>80 / 220÷240V / Integral electronic power supply



539106
539106-300 Dimmable Dali
539106-310 Dimmable 1-10
 White 2700K
 lm LED 7446 ≠ lm OUTPUT 5487

539009
539009-300 Dimmable Dali
539009-310 Dimmable 1-10
 White 3000K
 lm LED 8006 ≠ lm OUTPUT 5900

539008
539008-300 Dimmable Dali
539008-310 Dimmable 1-10
 White 4000K
 lm LED 8524 ≠ lm OUTPUT 6282

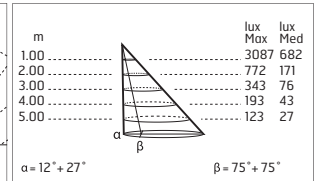
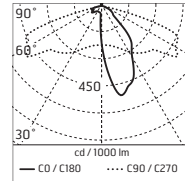
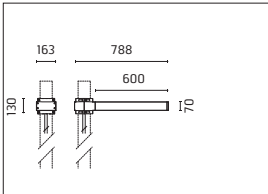

@4000K

Smart city version on request

IP65

Dooku600 - Pole Ø 76mm - Double Top Pole - 120° (Wide Spaces - Public Areas - Parking Areas)

Light Source: Power LED / 2x67,2W / Total power 2x78W / CRI>80 / 220±240V / Integral electronic power supply



539108
539108-300 Dimmable Dali
539108-310 Dimmable 1-10
 White 2700K
 lm LED 2x7446 ≠ lm OUTPUT 2x5893

539012
539012-300 Dimmable Dali
539012-310 Dimmable 1-10
 White 3000K
 lm LED 2x8006 ≠ lm OUTPUT 2x6337

539011
539011-300 Dimmable Dali
539011-310 Dimmable 1-10
 White 4000K
 lm LED 2x8524 ≠ lm OUTPUT 2x6748

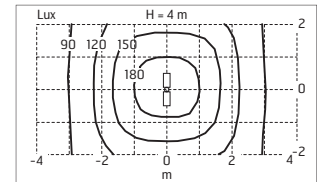
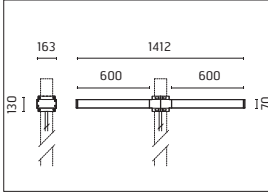

@4000K

Smart city version on request

IP65

Dooku600 - Pole Ø 76mm - Double Top Pole - Asymmetric optic

Light Source: Power LED / 33,6W / Total power 39W / CRI>80 / 220±240V / Integral electronic power supply



539142
539142-300 Dimmable Dali
539142-310 Dimmable 1-10
 White 2700K
 lm LED 2x7446 ≠ lm OUTPUT 2x5705

539160
539160-300 Dimmable Dali
539160-310 Dimmable 1-10
 White 3000K
 lm LED 2x8006 ≠ lm OUTPUT 2x5881

539178
539178-300 Dimmable Dali
539178-310 Dimmable 1-10
 White 4000K
 lm LED 2x8524 ≠ lm OUTPUT 2x2263

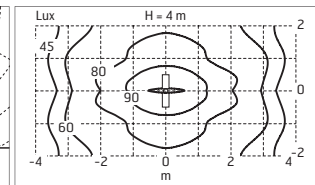
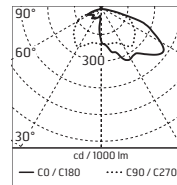
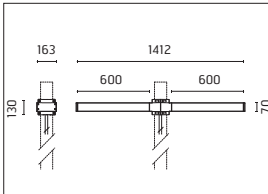

@4000K

Smart city version on request

IP65

Dooku600 - Pole Ø 76mm - Double Top Pole - Street Light Optic

Light Source: Power LED / 2x67,2W / Total power 2x78W / CRI>80 / 220÷240V / Integral electronic power supply



539110
539110-300 Dimmable Dali
539110-310 Dimmable 1-10
 White 2700K
 lm LED 2x7446 ≈ lm OUTPUT 2x5454

539015
539015-300 Dimmable Dali
539015-310 Dimmable 1-10
 White 3000K
 lm LED 2x8006 ≈ lm OUTPUT 2x5864

539014
539014-300 Dimmable Dali
539014-310 Dimmable 1-10
 White 4000K
 lm LED 2x8524 ≈ lm OUTPUT 2x6243

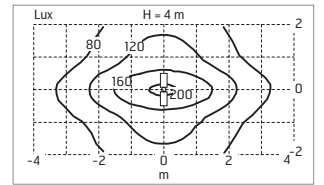
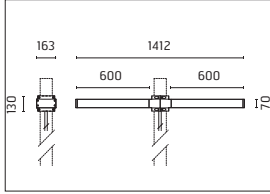

@4000K

Smart city version on request

IP65

Dooku600 - Pole Ø 76mm - Double Top Pole - Street Light Optic (Foot and Cycle Paths)

Light Source: Power LED / 2x67,2W / Total power 2x78W / CRI>80 / 220÷240V / Integral electronic power supply



539112
539112-300 Dimmable Dali
539112-310 Dimmable 1-10
 White 2700K
 lm LED 2x7446 ≈ lm OUTPUT 2x5487

539018
539018-300 Dimmable Dali
539018-310 Dimmable 1-10
 White 3000K
 lm LED 2x8006 ≈ lm OUTPUT 2x5900

539017
539017-300 Dimmable Dali
539017-310 Dimmable 1-10
 White 4000K
 lm LED 2x8524 ≈ lm OUTPUT 2x6282

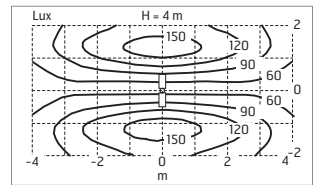
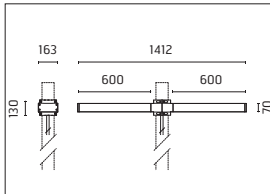

@4000K

Smart city version on request

IP65

Dooku600 - Pole Ø 102mm - Single Top Pole - 120° (Wide Spaces - Public Areas - Parking Areas)

Light Source: Power LED / 67,2W / Total power 78W / CRI>80 / 220÷240V / Integral electronic power supply



539114
539114-300 Dimmable Dali
539114-310 Dimmable 1-10
 White 2700K
 lm LED 7446 ≠ lm OUTPUT 5893

539021
539021-300 Dimmable Dali
539021-310 Dimmable 1-10
 White 3000K
 lm LED 8006 ≠ lm OUTPUT 6337

539020
539020-300 Dimmable Dali
539020-310 Dimmable 1-10
 White 4000K
 lm LED 8524 ≠ lm OUTPUT 6748

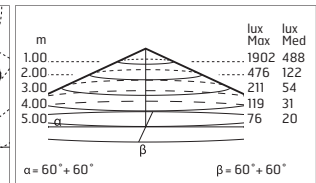
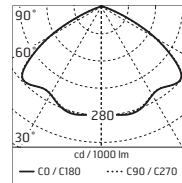

@4000K

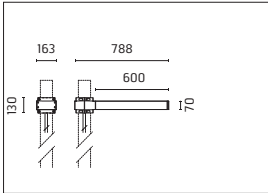

Smart city version on request

IP65

Dooku600 - Pole Ø 102mm - Single Top Pole - Asymmetric optic

Light Source: Power LED / 33,6W / Total power 39W / CRI>80 / 220÷240V / Integral electronic power supply



539144
539144-300 Dimmable Dali
539144-310 Dimmable 1-10
 White 2700K
 lm LED 7446 ≠ lm OUTPUT 5705

539162
539162-300 Dimmable Dali
539162-310 Dimmable 1-10
 White 3000K
 lm LED 8006 ≠ lm OUTPUT 5881

539180
539180-300 Dimmable Dali
539180-310 Dimmable 1-10
 White 4000K
 lm LED 8524 ≠ lm OUTPUT 6263

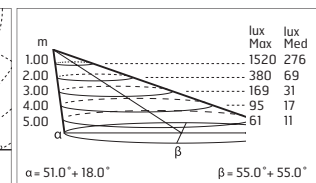
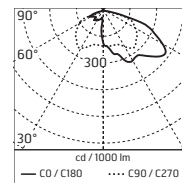

@4000K

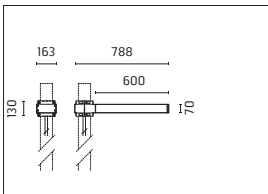

Smart city version on request

IP65

Dooku600 - Pole Ø 102mm - Single Top Pole - Street Light Optic

Light Source: Power LED / 67,2W / Total power 78W / CRI >80 / 220÷240V / Integral electronic power supply



539116
539116-300 Dimmable Dali
539116-310 Dimmable 1-10
 White 2700K
 lm LED 7446 ≠ lm OUTPUT 5454

539024
539024-300 Dimmable Dali
539024-310 Dimmable 1-10
 White 3000K
 lm LED 8006 ≠ lm OUTPUT 5864

539023
539023-300 Dimmable Dali
539023-310 Dimmable 1-10
 White 4000K
 lm LED 8524 ≠ lm OUTPUT 6243

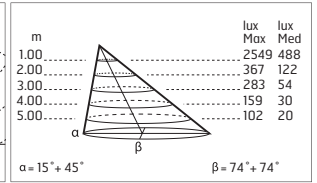
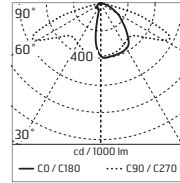

@4000K

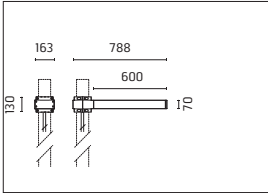

Smart city version on request

IP65

Dooku600 - Pole Ø 102mm - Single Top Pole - Street Light Optic (Foot and Cycle Paths)

Light Source: Power LED / 67,2W / Total power 78W / CRI >80 / 220÷240V / Integral electronic power supply



539118
539118-300 Dimmable Dali
539118-310 Dimmable 1-10
 White 2700K
 lm LED 7446 ≠ lm OUTPUT 5487

539027
539027-300 Dimmable Dali
539027-310 Dimmable 1-10
 White 3000K
 lm LED 8006 ≠ lm OUTPUT 5900

539026
539026-300 Dimmable Dali
539026-310 Dimmable 1-10
 White 4000K
 lm LED 8524 ≠ lm OUTPUT 6282

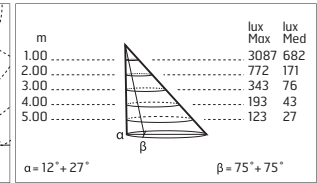
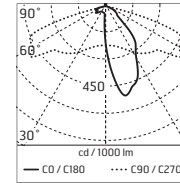

@4000K

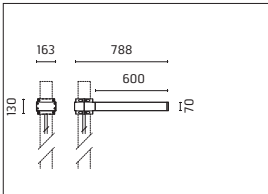

Smart city version on request

IP65

Dooku600 - Pole Ø 102mm - Double Top Pole - 120° (Wide Spaces - Public Areas - Parking Areas)

Light Source: Power LED / 2x67,2W / Total power 2x78W / CRI>80 / 220±240V / Integral electronic power supply



539120
539120-300 Dimmable Dali
539120-310 Dimmable 1-10
 White 2700K
 lm LED 2x7446 ≠ lm OUTPUT 2x5893

539030
539030-300 Dimmable Dali
539030-310 Dimmable 1-10
 White 3000K
 lm LED 2x8006 ≠ lm OUTPUT 2x6337

539029
539029-300 Dimmable Dali
539029-310 Dimmable 1-10
 White 4000K
 lm LED 2x8524 ≠ lm OUTPUT 2x6748

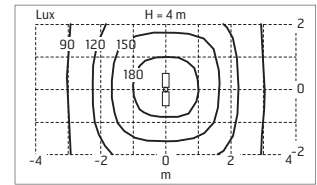

@4000K

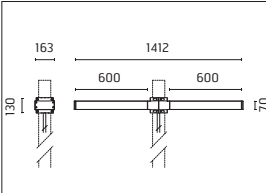

Smart city version on request

IP65

Dooku600 - Pole Ø 102mm - Double Top Pole - Asymmetric optic

Light Source: Power LED / 33,6W / Total power 39W / CRI>80 / 220±240V / Integral electronic power supply



539146
539146-300 Dimmable Dali
539146-310 Dimmable 1-10
 White 2700K
 lm LED 2x7446 ≠ lm OUTPUT 2x5705

539164
539164-300 Dimmable Dali
539164-310 Dimmable 1-10
 White 3000K
 lm LED 2x8006 ≠ lm OUTPUT 2x5881

539182
539182-300 Dimmable Dali
539182-310 Dimmable 1-10
 White 4000K
 lm LED 2x8524 ≠ lm OUTPUT 2x2263

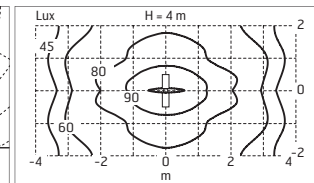
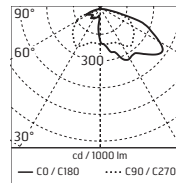

@4000K

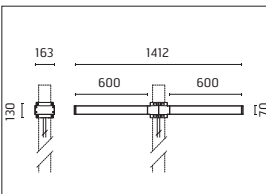

Smart city version on request

IP65

Dooku600 - Pole Ø 102mm - Double Top Pole - Street Light Optic

Light Source: Power LED / 2x67,2W / Total power 2x78W / CRI>80 / 220÷240V / Integral electronic power supply



539122
539122-300 Dimmable Dali
539122-310 Dimmable 1-10
 White 2700K
 lm LED 2x7446 ≈ lm OUTPUT 2x5454

539033
539033-300 Dimmable Dali
539033-310 Dimmable 1-10
 White 3000K
 lm LED 2x8006 ≈ lm OUTPUT 2x5864

539032
539032-300 Dimmable Dali
539032-310 Dimmable 1-10
 White 4000K
 lm LED 2x8524 ≈ lm OUTPUT 2x6243

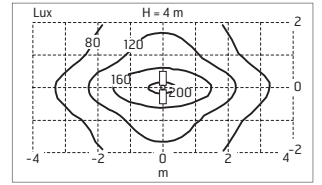

@4000K

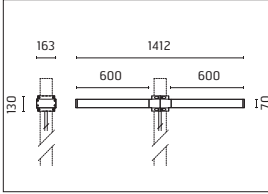

Smart city version on request

IP65

Dooku600 - Pole Ø 102mm - Double Top Pole - Street Light Optic (Foot and Cycle Paths)

Light Source: Power LED / 2x67,2W / Total power 2x78W / CRI>80 / 220÷240V / Integral electronic power supply



539124
539124-300 Dimmable Dali
539124-310 Dimmable 1-10
 White 2700K
 lm LED 2x7446 ≈ lm OUTPUT 2x5487

539036
539036-300 Dimmable Dali
539036-310 Dimmable 1-10
 White 3000K
 lm LED 2x8006 ≈ lm OUTPUT 2x5900

539035
539035-300 Dimmable Dali
539035-310 Dimmable 1-10
 White 4000K
 lm LED 2x8524 ≈ lm OUTPUT 2x6282

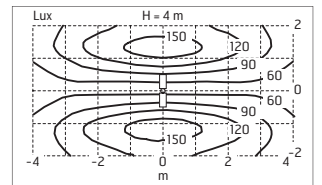

@4000K

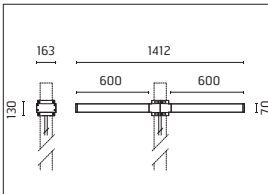

Smart city version on request

IP65

Dooku / Ø 76mm - Poles

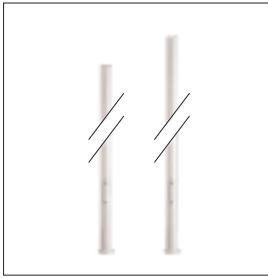

248
H 3500 mm

249
H 4500 mm

**With Base and Access Door
With Terminal Block 4x1,5-16mmq**



.6 Grey

.3 Anthracite

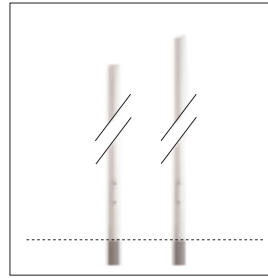

250
H 3500 mm (+500mm)

251
H 4500 mm (+500mm)

**In-Ground (+500 mm Root) With Access Door
With Terminal Block 4x1,5-16mmq**



.6 Grey

.3 Anthracite

Dooku / Ø 102mm - Poles

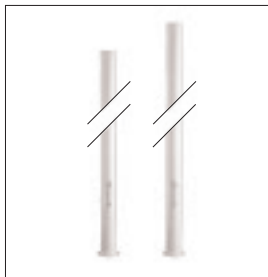

4140
H 4000 mm

4150
H 5000 mm

**With Base and Access Door
With Terminal Block 4x1,5-16mmq**



.6 Grey

.3 Anthracite

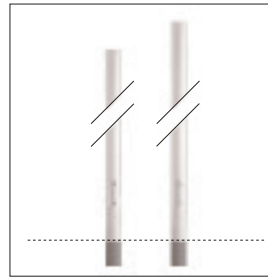

4145
H 4000 mm (+500mm)

4155
H 5000 mm (+500mm)

**In-Ground (+500 mm Root) With Access Door
With Terminal Block 4x1,5-16mmq**



.6 Grey

.3 Anthracite

Accessories: Dooku

116
BASE PLATE AND FIXING BOLTS
230 x 230 x H 200mm

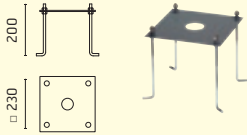

237
SPD: (SURGE PROTECTION DEVICE)
275Vac
MAXIMUM DISCHARGE CURRENT
10KA (8/20µs)
MAXIMUM OPERATING CURRENT 5A
SUITABLE FOR SERIES CONNEX-
TION - IP66

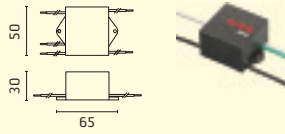

acc. code ▶	116
prod. code ▼	
248	●
249	●
250	
251	
4140	●
4145	
4150	●
4155	

acc. code ▶ prod. code ▼	dimmi DALI	dimmi 1-10	237
539002	-300	-310	●
539003	-300	-310	●
539005	-300	-310	●
539006	-300	-310	●
539008	-300	-310	●
539009	-300	-310	●
539011	-300	-310	●
539012	-300	-310	●
539014	-300	-310	●
539015	-300	-310	●
539017	-300	-310	●
539018	-300	-310	●
539020	-300	-310	●
539021	-300	-310	●
539023	-300	-310	●
539024	-300	-310	●
539026	-300	-310	●
539027	-300	-310	●
539029	-300	-310	●
539030	-300	-310	●
539032	-300	-310	●
539033	-300	-310	●
539035	-300	-310	●
539036	-300	-310	●
539038	-300	-310	●
539039	-300	-310	●
539041	-300	-310	●
539042	-300	-310	●
539044	-300	-310	●
539045	-300	-310	●
539047	-300	-310	●
539048	-300	-310	●
539050	-300	-310	●
539051	-300	-310	●
539053	-300	-310	●
539054	-300	-310	●

acc. code ▶ prod. code ▼	dimmi DALI	dimmi 1-10	237
539056	-300	-310	●
539057	-300	-310	●
539059	-300	-310	●
539060	-300	-310	●
539062	-300	-310	●
539063	-300	-310	●
539065	-300	-310	●
539066	-300	-310	●
539068	-300	-310	●
539069	-300	-310	●
539071	-300	-310	●
539072	-300	-310	●
539074	-300	-310	●
539075	-300	-310	●
539076	-300	-310	●
539078	-300	-310	●
539080	-300	-310	●
539082	-300	-310	●
539084	-300	-310	●
539086	-300	-310	●
539088	-300	-310	●
539090	-300	-310	●
539092	-300	-310	●
539094	-300	-310	●
539096	-300	-310	●
539098	-300	-310	●
539100	-300	-310	●
539102	-300	-310	●
539104	-300	-310	●
539106	-300	-310	●
539108	-300	-310	●
539110	-300	-310	●
539112	-300	-310	●
539114	-300	-310	●
539116	-300	-310	●
539118	-300	-310	●

acc. code ▶ prod. code ▼	dimmi DALI	dimmi 1-10	237
539120	-300	-310	●
539122	-300	-310	●
539124	-300	-310	●
539130	-300	-310	●
539132	-300	-310	●
539134	-300	-310	●
539136	-300	-310	●
539138	-300	-310	●
539140	-300	-310	●
539142	-300	-310	●
539144	-300	-310	●
539146	-300	-310	●
539148	-300	-310	●
539150	-300	-310	●
539152	-300	-310	●
539154	-300	-310	●
539156	-300	-310	●
539158	-300	-310	●
539160	-300	-310	●
539162	-300	-310	●
539164	-300	-310	●
539166	-300	-310	●
539168	-300	-310	●
539170	-300	-310	●
539172	-300	-310	●
539174	-300	-310	●
539176	-300	-310	●
539178	-300	-310	●
539180	-300	-310	●
539182	-300	-310	●

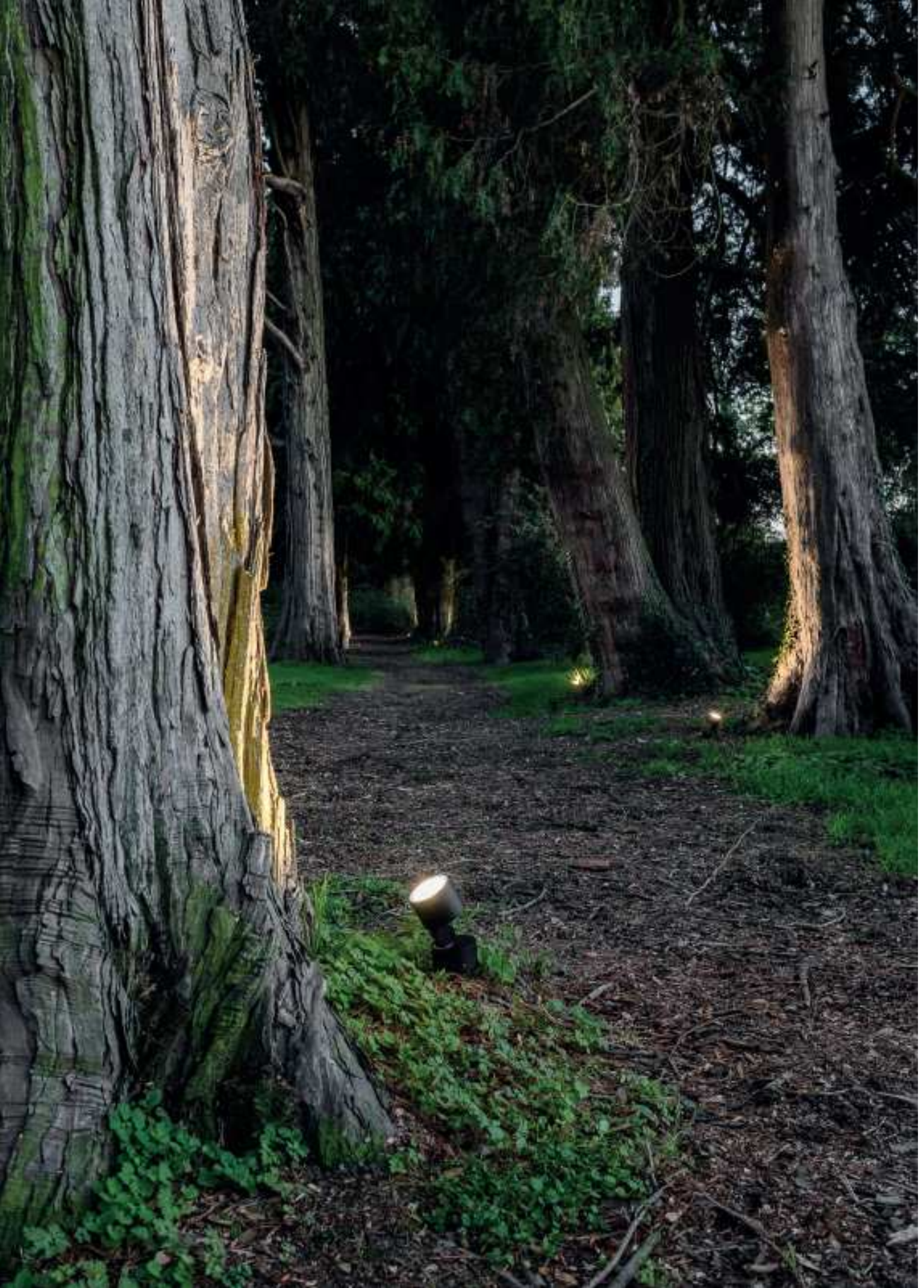

- Adjustable projector for installation on ceiling, wall or floor.
- Configuration: die-cast aluminium structure, EN AB-47100 alloy (low copper content) and AISI 316L fixing plate. Glass diffuser: extra clear with silkscreen border, fixed to the aluminium through a robotic gluing system. The wiring unit and the emitting unit are connected by an adjustable junction.
- Double layer coating for high resistance to corrosion: the aluminium components are painted with a double coat using powders which are compliant with QUALICOAT standards: a first layer of epoxy powder (with excellent chemical and mechanical resistance) and a second finishing layer of polyester powder (resistant to UV rays and atmospheric agents). The entire painting process of the aluminium fitting starts from components which have been sand-blasted in advance to make the surface more porous and increase the adherence of the paint. Ares effects alkaline and acid washing to clean the surfaces completely, then rinses with demineralised water to remove any residue particles, subsequently a chemical conversion treatment is done to protect against rusting.
- Protection rating: IP65
- In compliance with EN60598-1 standards
- Class of insulation: I
- Installation: the luminaire is for direct connection to 220-230V with a LED module set to work directly connected to the mains. The luminaire is equipped with an AISI316L stainless steel fixing plate for installation on surface and IP68 connector (6\times8mm cable). Ground spike available on request.
- During the installation and the maintenance of the fixtures it is important to be careful and avoid damages on the paint coating.
Damages on the coating exposed to outdoor conditions or water, could cause corrosion.
Chemical substances affect the anticorrosion covering protection.

EU Regulation 874/2012 - Illumination equipment energy classes



LED VERSION:
Class A/A+/A++
Luminaire supplied
with integrated LED modules
that cannot be replaced



.1 White



.6 Grey



.3 Anthracite



.4 Black



.18 Deep Brown



Floor installation



Wall fitting



Ceiling fitting

Protection against
impact
IK 06 - 1,00 joule

Kirk70 - Adjustable - 50° - Direct 230V

Light Source: CoB LED / 4,5W / Total power 6W / CRI>80 / 220÷240V



540001.A
 White 3000K
 Lm LED 350 ≈ lm OUTPUT 244
 LED module set up to work
 directly connected to the mains

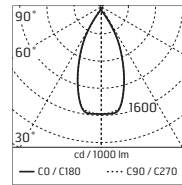

m	lux	
	Max	Med
1.00	339	196
2.00	85	49
3.00	38	22
4.00	21	12
5.00	14	8

$\alpha = 25.0^\circ + 25.0^\circ$ $\beta = 25.0^\circ + 25.0^\circ$

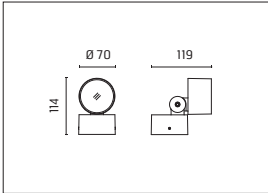

IP65

Kirk90 - Adjustable - 30° - Direct 230V

Light Source: CoB LED / 10W / Total power 12W / CRI >80 / 220÷240V



540002
 White 3000K
 Lm LED 951 ≈ lm OUTPUT 713
 LED module set up to work
 directly connected to the mains

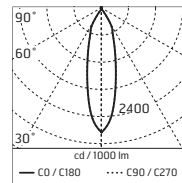

m	lux	
	Max	Med
1.00	1977	1195
2.00	494	299
3.00	220	133
4.00	124	75
5.00	79	48

$\alpha = 15.0^\circ + 15.0^\circ$ $\beta = 15.0^\circ + 15.0^\circ$

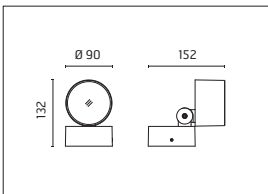

IP65

Kirk120 - Adjustable - 40° - Direct 230V

Light Source: CoB LED / 22W / Total power 24W / CRI >80 / 220÷240V



540003
 White 3000K
 Lm LED 2303 ≈ lm OUTPUT 1610
 LED module set up to work
 directly connected to the mains

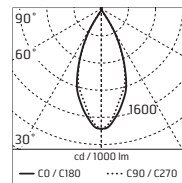

m	lux	
	Max	Med
1.00	2849	1592
2.00	712	398
3.00	317	177
4.00	178	100
5.00	114	64

$\alpha = 20.0^\circ + 20.0^\circ$ $\beta = 20.0^\circ + 20.0^\circ$

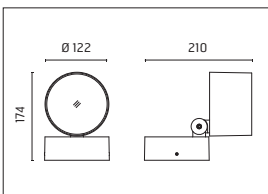

IP65

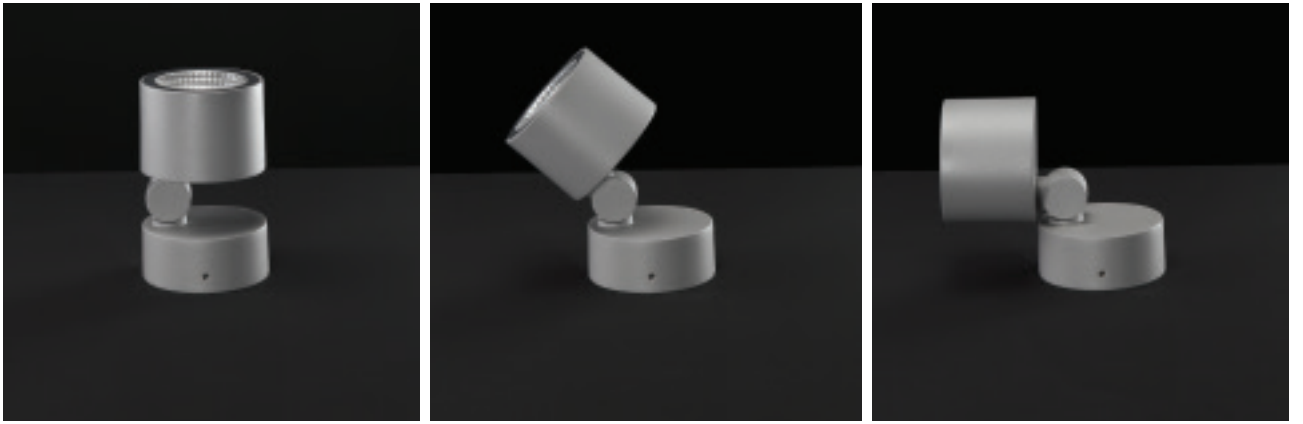



Accessories: Kirk

264
GROUND SPIKE - Ø 70mm

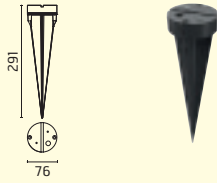

266
GROUND SPIKE - Ø 90mm

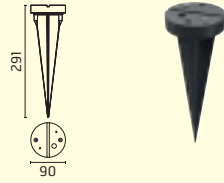

268
GROUND SPIKE - Ø 130mm

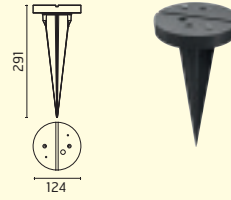

237
SPD: (SURGE PROTECTION DEVICE)
275Vac
MAXIMUM DISCHARGE CURRENT 10KA
(8/20µs)
MAXIMUM OPERATING CURRENT 5A
SUITABLE FOR SERIES CONNECTION
- IP66

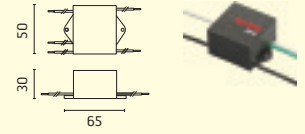

acc. code ▶	264	266	268	237
prod. code ▼				
540001.A	•			•
540002		•		•
540003			•	•



SPOCK

- Adjustable projector for installation on ceiling, wall or floor.
- Configuration: die-cast aluminium structure, EN AB-47100 alloy (low copper content) and AISI 316L stainless steel fixing bracket. Glass diffuser: extra clear with silkscreen border, fixed through a robotic gluing system. The luminaire has three connected parts: wiring unit (silicone gasket), heat sink and emitting unit (silicone glue). A graduated fixing plate allows a precise adjustment of the emitting unit.
- Double layer coating for high resistance to corrosion: the aluminium components are painted with a double coat using powders which are compliant with QUALICOAT standards: a first layer of epoxy powder (with excellent chemical and mechanical resistance) and a second finishing layer of polyester powder (resistant to UV rays and atmospheric agents). The entire painting process of the aluminium fitting starts from components which have been sand-blasted in advance to make the surface more porous and increase the adherence of the paint. Ares effects alkaline and acid washing to clean the surfaces completely, then rinses with demineralised water to remove any residue particles, subsequently a chemical conversion treatment is done to protect against rusting.
- Protection rating: IP66
- In compliance with EN60598-1 standards
- Class of insulation: I
- Installation: the luminaire is equipped with 1000mm of cable for an easy-to-make connection.
- We recommend the use of a connection system with a protection degree greater than or equal to the protection degree of the luminaire.
- During the installation and the maintenance of the fixtures it is important to be careful and avoid damages on the paint coating. Damages on the coating exposed to outdoor conditions or water, could cause corrosion. Chemical substances affect the anticorrosion covering protection.

EU Regulation 874/2012 - Illumination equipment energy classes

A++
A+
A

LED VERSION:
Class A/A+/A++
Luminaire supplied with integrated LED modules that cannot be replaced

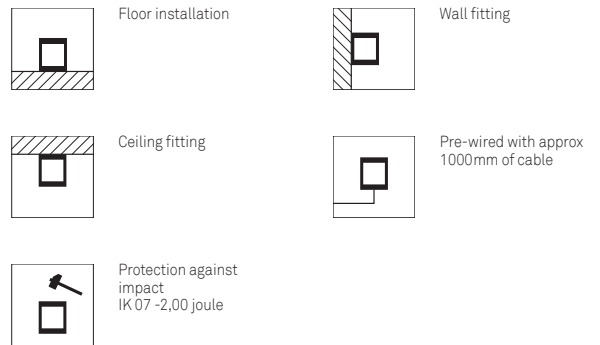

Spock75 - Adjustable - 20°

Light Source: CoB LED / 9W / Total power 12W / CRI>80 / 220÷240V / Integral electronic power supply



- 541023**
White 2700K
Lm LED 1005 ≈ Lm OUTPUT 725
- 541003**
White 3000K
Lm LED 1081 ≈ Lm OUTPUT 780
- 541002**
White 4000K
Lm LED 1124 ≈ Lm OUTPUT 811

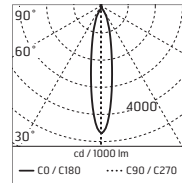

m	lux	
	Max	Med
1.00	3816	2357
2.00	954	589
3.00	424	262
4.00	239	147
5.00	153	94

$\alpha = 10.0^\circ + 10.0^\circ$ $\beta = 10.0^\circ + 10.0^\circ$

@4000K

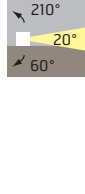
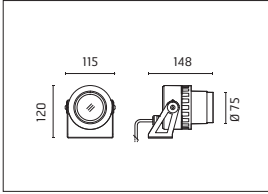

Dimmable on request



Spock75 - Adjustable - 50°

Light Source: CoB LED / 9W / Total power 12W / CRI>80 / 220÷240V / Integral electronic power supply



- 541026**
White 2700K
Lm LED 1005 ≈ Lm OUTPUT 697
- 541006**
White 3000K
Lm LED 1081 ≈ Lm OUTPUT 749
- 541005**
White 4000K
Lm LED 1124 ≈ Lm OUTPUT 778

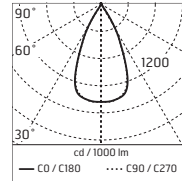

m	lux	
	Max	Med
1.00	1132	687
2.00	283	172
3.00	126	76
4.00	71	43
5.00	45	27

$\alpha = 25.0^\circ + 25.0^\circ$ $\beta = 25.0^\circ + 25.0^\circ$

@4000K

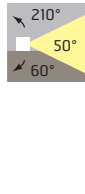
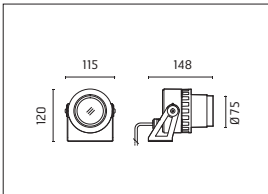

Dimmable on request



Spock95 - Adjustable - 20°

Light Source: CoB LED / 24W / Total power 29W / CRI>80 / 220÷240V / Integral electronic power supply



- 541028**
White 2700K
Lm LED 3022 ≈ Lm OUTPUT 2141
- 541008**
White 3000K
Lm LED 3249 ≈ Lm OUTPUT 3202
- 541007**
White 4000K
Lm LED 3408 ≈ Lm OUTPUT 2415

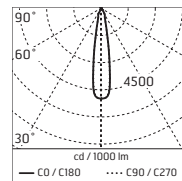

m	lux	
	Max	Med
1.00	10409	6559
2.00	2602	1640
3.00	1157	729
4.00	651	410
5.00	416	262

$\alpha = 10.0^\circ + 10.0^\circ$ $\beta = 10.0^\circ + 10.0^\circ$

@4000K

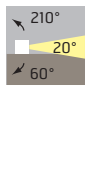
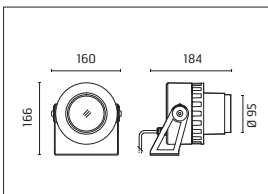

Dimmable on request



Spock95 CoB LED - Adjustable - 40°

Light Source: CoB LED / 24W / Total power 29W / CRI>80 / 220÷240V / Integral electronic power supply



541030
White 2700K
Lm LED 3022 ≠ Lm OUTPUT 2153

541010
White 3000K
Lm LED 3249 ≠ Lm OUTPUT 2315

541009
White 4000K
Lm LED 3408 ≠ Lm OUTPUT 2428

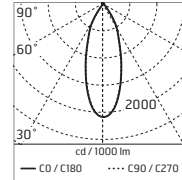
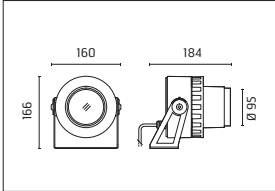

m	lux	
	Max	Med
1.00	5156	3044
2.00	1289	761
3.00	573	338
4.00	322	190
5.00	206	122

$\alpha = 20.0^\circ + 20.0^\circ$ $\beta = 20.0^\circ + 20.0^\circ$

@4000K

Dimmable on request

IP66

Spock130 CoB LED - Adjustable - 20°

Light Source: CoB LED / 45W / Total power 52W / CRI>80 / 220÷240V / Integral electronic power supply



541032
White 2700K
Lm LED 5408 ≠ Lm OUTPUT 4059

541012
White 3000K
Lm LED 5815 ≠ Lm OUTPUT 4365

541011
White 4000K
Lm LED 5963 ≠ Lm OUTPUT 4477

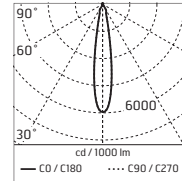
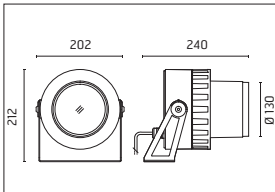

m	lux	
	Max	Med
1.00	26888	17059
2.00	6722	4265
3.00	2988	1895
4.00	1680	1066
5.00	1076	682

$\alpha = 10.0^\circ + 10.0^\circ$ $\beta = 10.0^\circ + 10.0^\circ$

@4000K

Dimmable on request

IP66

Spock130 CoB LED - Adjustable - 45°

Light Source: CoB LED / 45W / Total power 52W / CRI>80 / 220÷240V / Integral electronic power supply



541034
White 2700K
Lm LED 5408 ≠ Lm OUTPUT 3981

541014
White 3000K
Lm LED 5815 ≠ Lm OUTPUT 4281

541013
White 4000K
Lm LED 5963 ≠ Lm OUTPUT 4390

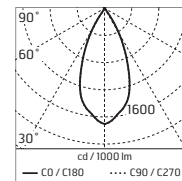
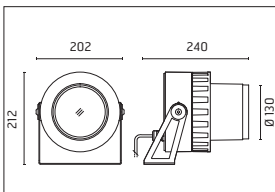

m	lux	
	Max	Med
1.00	7564	4354
2.00	1891	1089
3.00	840	484
4.00	473	272
5.00	303	174

$\alpha = 23.0^\circ + 23.0^\circ$ $\beta = 23.0^\circ + 23.0^\circ$

@4000K

Dimmable on request

IP66

Spock130 CoB LED TUNABLE WHITE DALI - Adjustable - 20° - Micro-texturized glass

Light Source: CoB LED / 31W / Total power 38W / CRI>80 / 120-240V / Integral electronic DALI power supply



541100
Tunable White 2700K ÷ 5700K
Lm LED 2840 ≠ Lm OUTPUT 2200

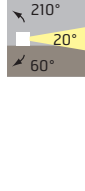
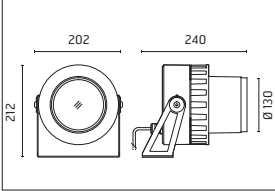

IP66   

Spock130 CoB LED TUNABLE WHITE DALI - Adjustable - 40° - Micro-texturized glass

Light Source: CoB LED / 31W / Total power 38W / CRI>80 / 120-240V / Integral electronic DALI power supply



541102
Tunable White 2700K ÷ 5700K
Lm LED 2840 ≠ Lm OUTPUT 2250

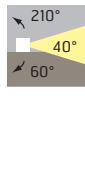
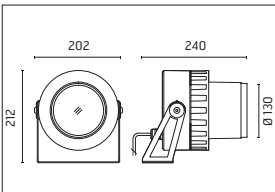

IP66   

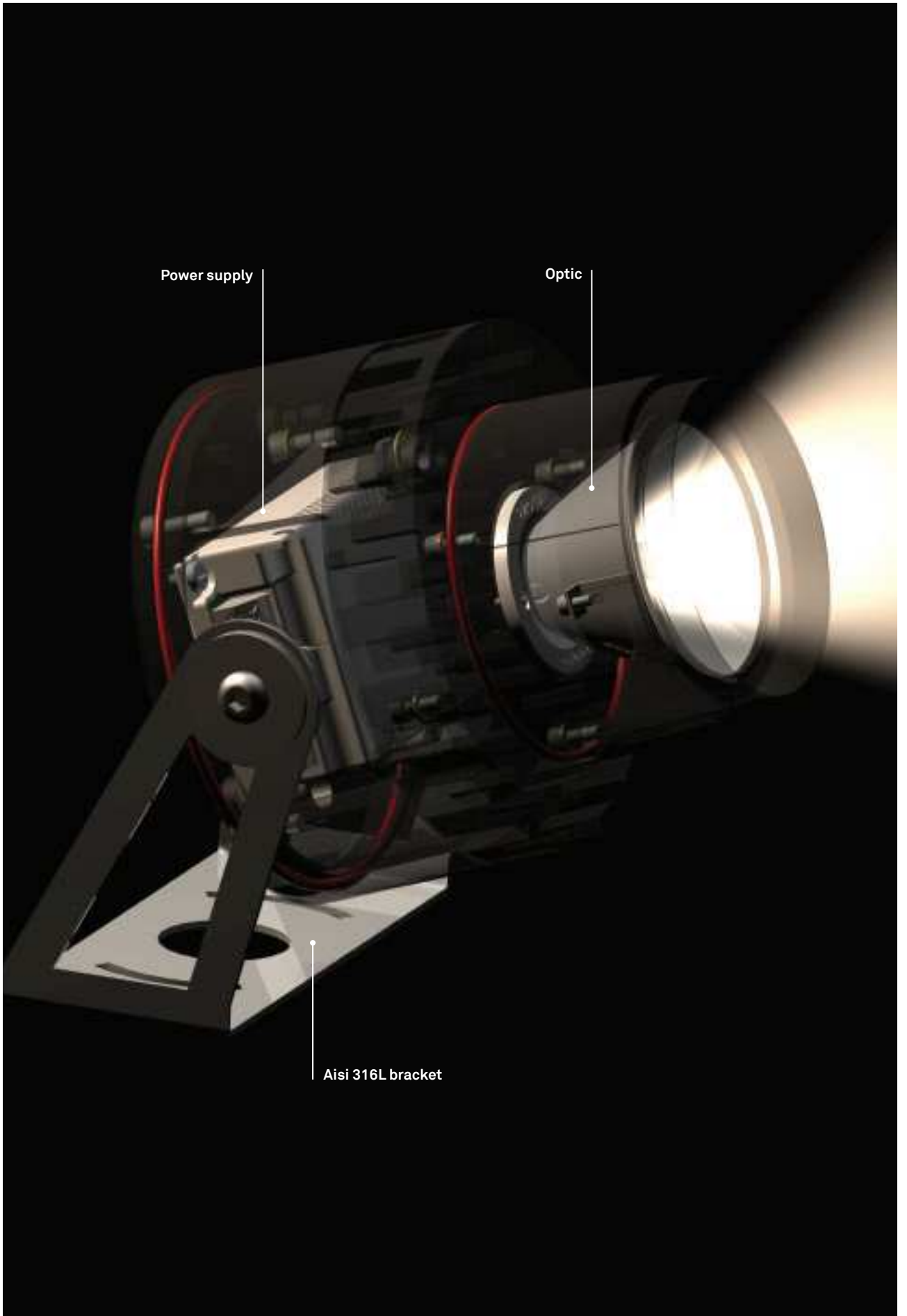

Power supply

Optic

Aisi 316L bracket



SPOCK + "FLOOD DIFFUSER"



SPOCK + "ELLIPTICAL LENS"

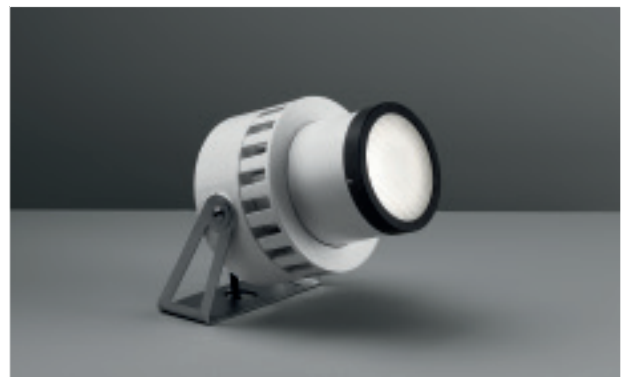
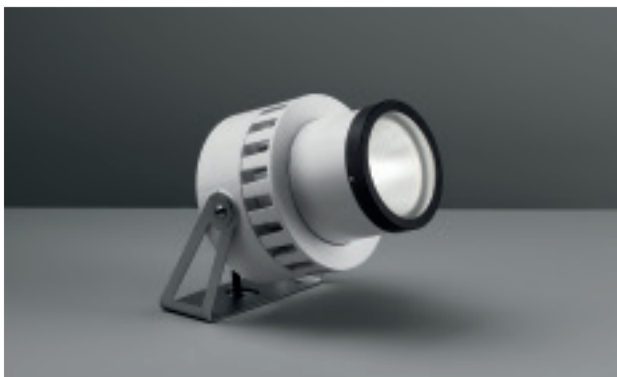

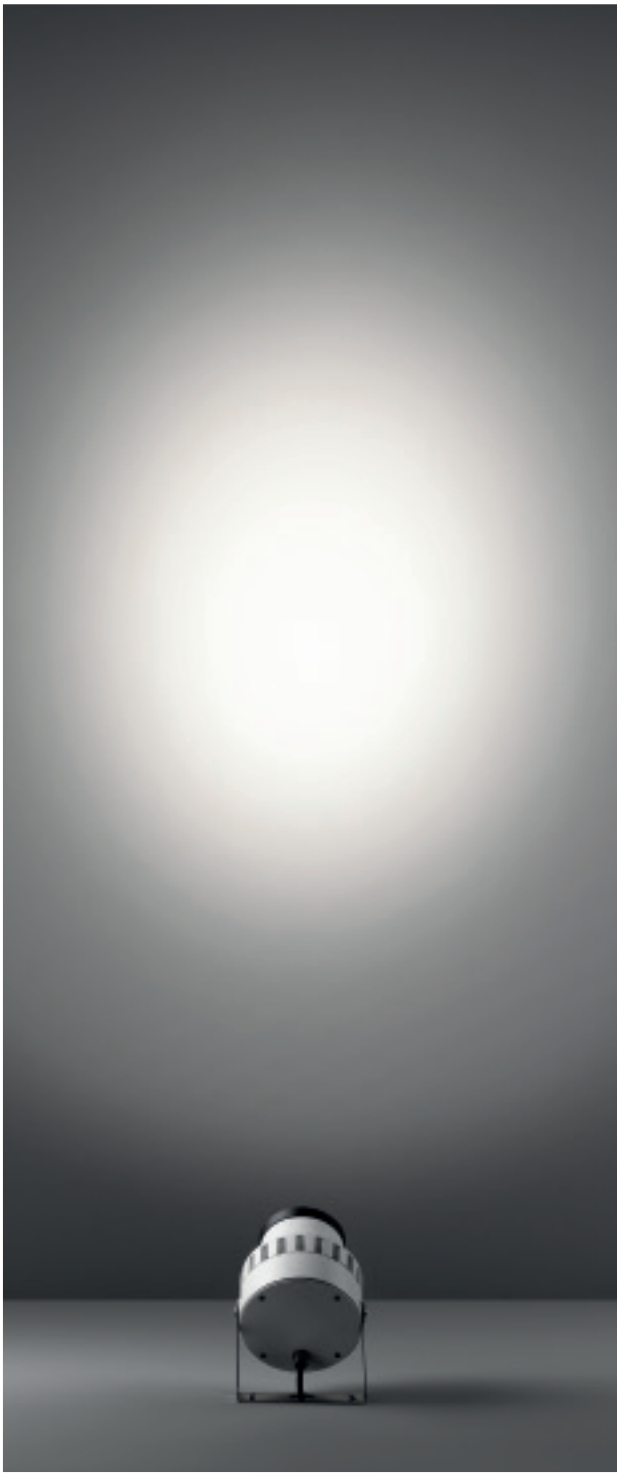

SPOCK + "ANTI-GLARE LOUVRE"



SPOCK + "VISOR"

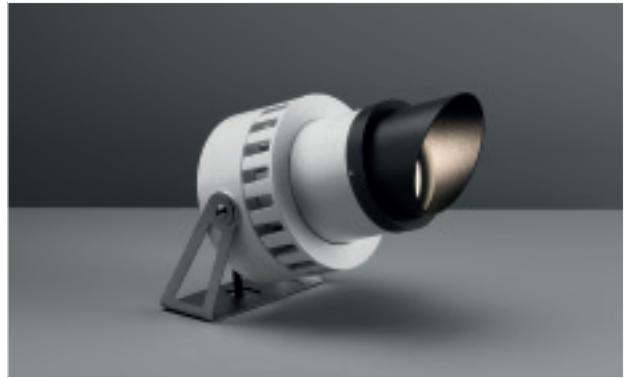
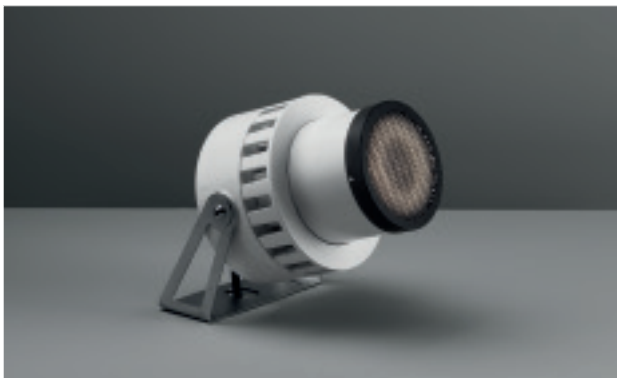





Accessories: Spock



205
VISOR Ø 75



206
VISOR Ø 95

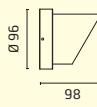

207
VISOR Ø 130

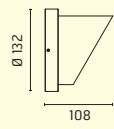

208
FLOOD DIFFUSER Ø 75



209
FLOOD DIFFUSER Ø 95



210
FLOOD DIFFUSER Ø 130

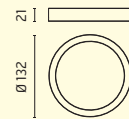

211
ANTI-GLARE LOUVRE Ø 75



212
ANTI-GLARE LOUVRE Ø 95



213
ANTI-GLARE LOUVRE Ø 130

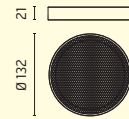

261
ELLIPTICAL LENS Ø 75



262
ELLIPTICAL LENS Ø 95



263
ELLIPTICAL LENS Ø 130

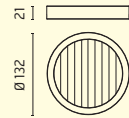

Accessories: Spock

203
KIT OF 2 GROUND SPIKES - H 220mm

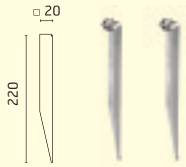

215
3/4 WAY TERMINAL BLOCK 4 POLES
IP68 H₂O STOP (Ø5,5÷12mm CABLE)

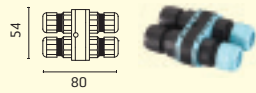

236
2 WAY TERMINAL BLOCK 4 POLES
IP68 H₂O STOP (Ø5,5÷12mm CABLE)



237
SPD: (SURGE PROTECTION DEVICE)
275Vac
MAXIMUM DISCHARGE CURRENT
10KA (8/20µs)
MAXIMUM OPERATING CURRENT 5A
SUITABLE FOR SERIES CONNEC-
TION - IP66

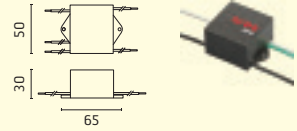

acc. code ▶ prod. code ▼	205	206	207	208	209	210	211	212	213	203	215	236	237	261	262	263
541002	•			•			•			•	•	•	•	•		
541003	•			•			•			•	•	•	•	•		
541005	•			•			•			•	•	•	•	•		
541006	•			•			•			•	•	•	•	•		
541007		•			•			•		•	•	•	•		•	
541008		•			•			•		•	•	•	•		•	
541009		•			•			•		•	•	•	•		•	
541010		•			•			•		•	•	•	•		•	
541011			•			•			•	•	•	•	•			•
541012			•			•			•	•	•	•	•			•
541013			•			•			•	•	•	•	•			•
541014			•			•			•	•	•	•	•			•
541023	•			•			•			•	•	•	•	•		
541026	•			•			•			•	•	•	•	•		
541028		•			•			•		•	•	•	•		•	
541030		•			•			•		•	•	•	•		•	
541032			•			•			•	•	•	•	•			•
541034			•			•			•	•	•	•	•			•
541100			•			•			•	•	•	•	•			•
541102			•			•			•	•	•	•	•			•



- Adjustable projector for installation on wall, ceiling or floor.
- Configuration: turned aluminium body (EN AW 6060) and AISI 316L stainless steel fixing bracket. Glass diffuser: extra clear with silkscreen border, fixed to the body through a robotic gluing system.
- Double layer coating for high resistance to corrosion: the aluminium components are painted with a double coat using powders which are compliant with QUALICOAT standards: a first layer of epoxy powder (with excellent chemical and mechanical resistance) and a second finishing layer of polyester powder (resistant to UV rays and atmospheric agents). The entire painting process of the aluminium fitting starts from components which have been sand-blasted in advance to make the surface more porous and increase the adherence of the paint. Ares effects alkaline and acid washing to clean the surfaces completely, then rinses with demineralised water to remove any residue particles, subsequently a chemical conversion treatment is done to protect against rusting.
- Protection rating: IP65
- In compliance with EN60598-1 standards
- Class of insulation: III
- Installation: the luminaire is supplied with 2000 mm neoprene cable for an easy-to-make connection. It is equipped with a dc / dc highly efficient resin-coated converter that removes electromagnetic interference and allows parallel wiring and is protected against polarity reversal and sudden voltage peak. The version on pole is equipped with a 2-way terminal block for 3-conductor cables – H2O STOP.
- We recommend the use of a connection system with a protection degree greater than or equal to the protection degree of the luminaire.
- During the installation and the maintenance of the fixtures it is important to be careful and avoid damages on the paint coating. Damages on the coating exposed to outdoor conditions or water, could cause corrosion. Chemical substances affect the anticorrosion covering protection.

EU Regulation 874 / 2012 - Illumination equipment energy classes



LED VERSION:
Class A/A+/A++
Luminaire supplied with integrated LED modules that cannot be replaced



.1 White



.6 Grey



.3 Anthracite



.4 Black



.18 Deep Brown



Floor installation



Ceiling fitting



Wall fitting



Pre-wired with approx 2000mm of cable.



Protection against water ingress from the cable
Only for IOTA on Pole



Protection against impact.
IK 05 - 0,70 joule



Remote device required.

Iota - Adjustable - 10°

Light Source: Power LED / 2,2W / Total power 3,4W / CRI>80 / 24Vdc / Remote electronic power supply to be ordered



513080
White 2700K
Lm LED 169 ≠ Lm OUTPUT 118

513033
White 3000K
Lm LED 182 ≠ Lm OUTPUT 127

513002
White 4000K
Lm LED 198 ≠ Lm OUTPUT 138

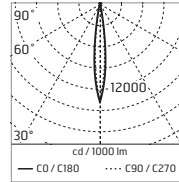

m	lux	
	Max	Med
1.00	1997	1222
2.00	499	306
3.00	222	136
4.00	125	76
5.00	80	49

$\alpha = 5.0^\circ + 5.0^\circ$ $\beta = 5.0^\circ + 5.0^\circ$

@4000K

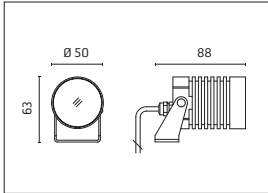

Dimmable on request



Iota - Adjustable - 30°

Light Source: Power LED / 2,2W / Total power 3,4W / CRI>80 / 24Vdc / Remote electronic power supply to be ordered



513082
White 2700K
Lm LED 169 ≠ Lm OUTPUT 106

513013
White 3000K
Lm LED 182 ≠ Lm OUTPUT 114

513012
White 4000K
Lm LED 198 ≠ Lm OUTPUT 125

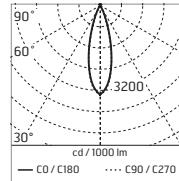

m	lux	
	Max	Med
1.00	437	265
2.00	109	66
3.00	49	29
4.00	27	17
5.00	17	11

$\alpha = 15.0^\circ + 15.0^\circ$ $\beta = 15.0^\circ + 15.0^\circ$

@4000K

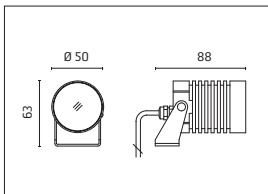

Dimmable on request



Iota - Adjustable - 10°

Light Source: Power LED / 3,3W / Total power 4,5W / CRI>80 / 24Vdc / Remote electronic power supply to be ordered



513084
White 2700K
Lm LED 307 ≠ Lm OUTPUT 219

513023
White 3000K
Lm LED 330 ≠ Lm OUTPUT 236

513022
White 4000K
Lm LED 360 ≠ Lm OUTPUT 258

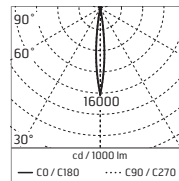

m	lux	
	Max	Med
1.00	4368	2691
2.00	1092	673
3.00	485	299
4.00	273	168
5.00	175	108

$\alpha = 5.0^\circ + 5.0^\circ$ $\beta = 5.0^\circ + 5.0^\circ$

@4000K

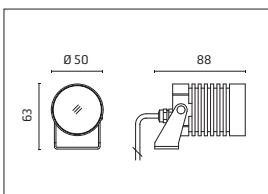

Dimmable on request



Iota - Adjustable - 30°

Light Source: Power LED / 3,3W / Total power 4,5W / CRI>80 / 24Vdc / Remote electronic power supply to be ordered

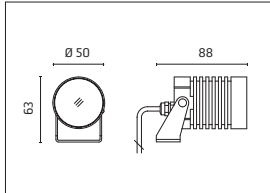

513086
White 2700K
Lm LED 307 ≈ Lm OUTPUT 176

513033
White 3000K
Lm LED 182 ≈ Lm OUTPUT 114

513032
White 4000K
Lm LED 198 ≈ Lm OUTPUT 125

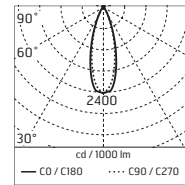

m	lux	
	Max	Med
1.00	524	318
2.00	131	79
3.00	58	35
4.00	33	20
5.00	21	13

α = 15.0° + 15.0° β = 15.0° + 15.0°

@4000K

Dimmable on request

IP65

Iota - Pole H.500 mm - Adjustable - 10°

Light Source: Power LED / 2,2W / Total power 3,4W / CRI>80 / 24Vdc / Remote electronic power supply to be ordered



513088
White 2700K
Lm LED 169 ≠ Lm OUTPUT 118

513036
White 3000K
Lm LED 182 ≠ Lm OUTPUT 127

513035
White 4000K
Lm LED 198 ≠ Lm OUTPUT 138

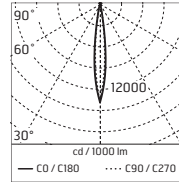

m	lux	
	Max	Med
1.00	1997	1222
2.00	499	306
3.00	222	136
4.00	125	76
5.00	80	49

α = 5.0° + 5.0° β = 5.0° + 5.0°

@4000K

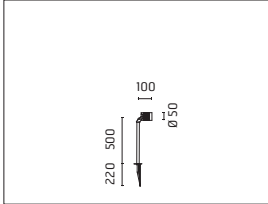

Dimmable on request

IP65

Iota - Pole H.500 mm - Adjustable - 30°

Light Source: Power LED / 2,2W / Total power 3,4W / CRI>80 / 24Vdc / Remote electronic power supply to be ordered



513090
White 2700K
Lm LED 169 ≠ Lm OUTPUT 106

513039
White 3000K
Lm LED 182 ≠ Lm OUTPUT 114

513038
White 4000K
Lm LED 198 ≠ Lm OUTPUT 125

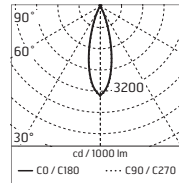

m	lux	
	Max	Med
1.00	437	265
2.00	109	66
3.00	49	29
4.00	27	17
5.00	17	11

α = 15.0° + 15.0° β = 15.0° + 15.0°

@4000K

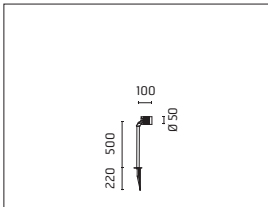

Dimmable on request

IP65

Iota - Pole H.900 mm - Adjustable - 10°

Light Source: Power LED / 2,2W / Total power 3,4W / CRI>80 / 24Vdc / Remote electronic power supply to be ordered



513092
White 2700K
Lm LED 169 ≠ Lm OUTPUT 118

513048
White 3000K
Lm LED 182 ≠ Lm OUTPUT 127

513047
White 4000K
Lm LED 198 ≠ Lm OUTPUT 138

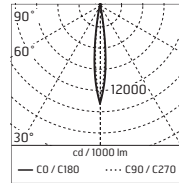

m	lux	
	Max	Med
1.00	1997	1222
2.00	499	306
3.00	222	136
4.00	125	76
5.00	80	49

α = 5.0° + 5.0° β = 5.0° + 5.0°

@4000K

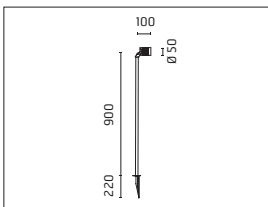

Dimmable on request

IP65

Iota - Pole H.900 mm - Adjustable - 30°

Light Source: Power LED / 2,2W / Total power 3,4W / CRI>80 / 24Vdc / Remote electronic power supply to be ordered



513094
White 2700K
Lm LED 169 ≈ Lm OUTPUT 106

513051
White 3000K
Lm LED 182 ≈ Lm OUTPUT 114

513050
White 4000K
Lm LED 198 ≈ Lm OUTPUT 125

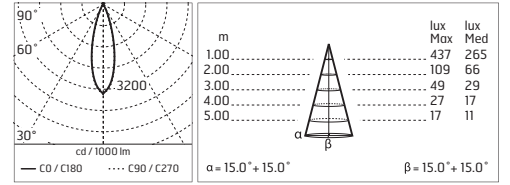
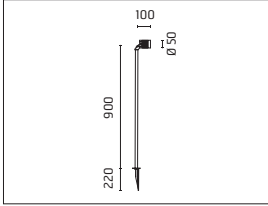

Dimmable on request

IP65

Iota - Wall Bracket L.500 mm - Adjustable - 10°

Light Source: Power LED / 2,2W / Total power 3,4W / CRI>80 / 24Vdc / Remote electronic power supply to be ordered



513096
White 2700K
Lm LED 169 ≠ Lm OUTPUT 118

513060
White 3000K
Lm LED 182 ≠ Lm OUTPUT 127

513059
White 4000K
Lm LED 198 ≠ Lm OUTPUT 138

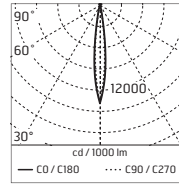

m	lux	
	Max	Med
1.00	1997	1222
2.00	499	306
3.00	222	136
4.00	125	76
5.00	80	49

$\alpha = 5.0^\circ + 5.0^\circ$ $\beta = 5.0^\circ + 5.0^\circ$

@4000K

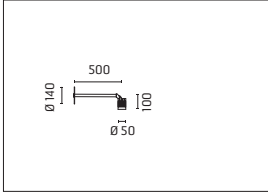

Dimmable on request

IP65

Iota - Wall Bracket L.500 mm - Adjustable - 30°

Light Source: Power LED / 2,2W / Total power 3,4W / CRI>80 / 24Vdc / Remote electronic power supply to be ordered



513098
White 2700K
Lm LED 169 ≠ Lm OUTPUT 106

513063
White 3000K
Lm LED 182 ≠ Lm OUTPUT 114

513062
White 4000K
Lm LED 198 ≠ Lm OUTPUT 125

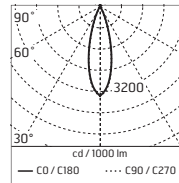

m	lux	
	Max	Med
1.00	437	265
2.00	109	66
3.00	49	29
4.00	27	17
5.00	17	11

$\alpha = 15.0^\circ + 15.0^\circ$ $\beta = 15.0^\circ + 15.0^\circ$

@4000K

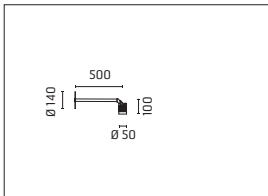

Dimmable on request

IP65

Iota - Wall Bracket L.900 mm - Adjustable - 10°

Light Source: Power LED / 2,2W / Total power 3,4W / CRI>80 / 24Vdc / Remote electronic power supply to be ordered

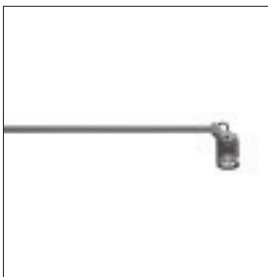

513100
White 2700K
Lm LED 169 ≠ Lm OUTPUT 118

513066
White 3000K
Lm LED 182 ≠ Lm OUTPUT 127

513065
White 4000K
Lm LED 198 ≠ Lm OUTPUT 138

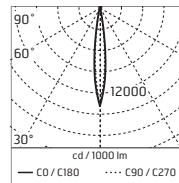

m	lux	
	Max	Med
1.00	1997	1222
2.00	499	306
3.00	222	136
4.00	125	76
5.00	80	49

$\alpha = 5.0^\circ + 5.0^\circ$ $\beta = 5.0^\circ + 5.0^\circ$

@4000K

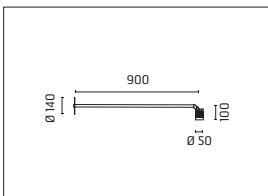

Dimmable on request

IP65

Iota - Wall Bracket L.900 mm - Adjustable - 30°

Light Source: Power LED / 2,2W / Total power 3,4W / CRI>80 / 24Vdc / Remote electronic power supply to be ordered

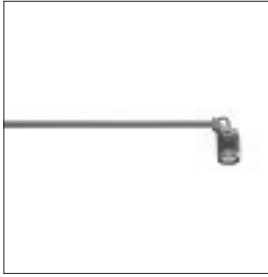

513102
White 2700K
Lm LED 169 ± Lm OUTPUT 106



513069
White 3000K
Lm LED 182 ± Lm OUTPUT 114



513068
White 4000K
Lm LED 198 ± Lm OUTPUT 125

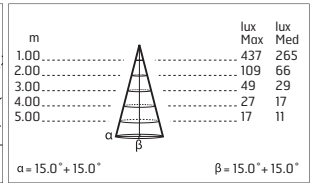
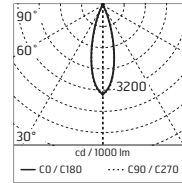
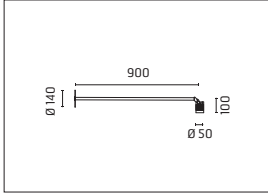

@4000K

Dimmable on request

IP65





Accessories: Iota

105
3 MODULES RECESSED BOX
106 x 75 H 55mm

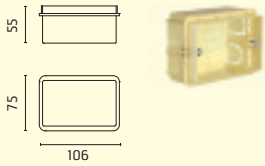

136
GROUND SPIKE - H 200mm

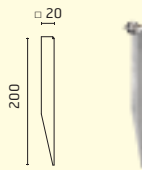

150
POWER SUPPLY DUAL FUNCTION
Vout 24Vdc: 8W / 100±240V
Iout 350mA: 6x1W / 100±240V
IP20 CLASS II SELV EQ.

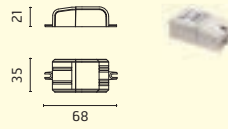

106
POWER SUPPLY DUAL FUNCTION
Vout 24Vdc: 8W / 100±240V
Iout 350mA: 6x1W / 100±240V
IP65 CLASS II SELV EQ.

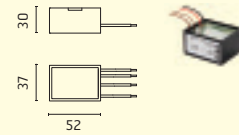

235
POWER SUPPLY 8W / 110±240V -
24Vdc
IP67 CLASS II SELV EQ.

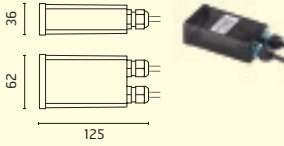

87
POWER SUPPLY 10W / 110±240V -
24Vdc IP20 CLASS II SELV.

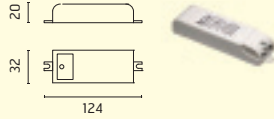

175
POWER SUPPLY 10W / 110±240V -
24Vdc
IP67 CLASS II SELV.

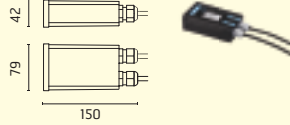

147
POWER SUPPLY 20W / 220±240V -
24Vdc IP67 CLASS II SELV.

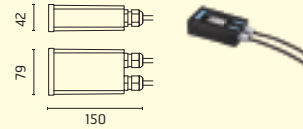

155
POWER SUPPLY 50W / 120±240V -
24Vdc
IP67 CLASS II SELV.

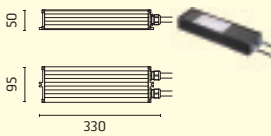

110
POWER SUPPLY 70W / 220±240V
- 24Vdc
IP67 CLASS II SELV EQ.

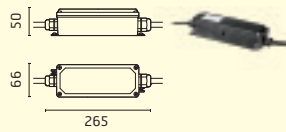

215
3 / 4 WAY TERMINAL BLOCK 4 POLES
IP68 H2O STOP (Ø5,5±12mm CABLE)

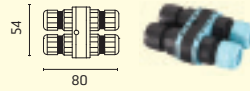

Iota wall bracket with box cod.105

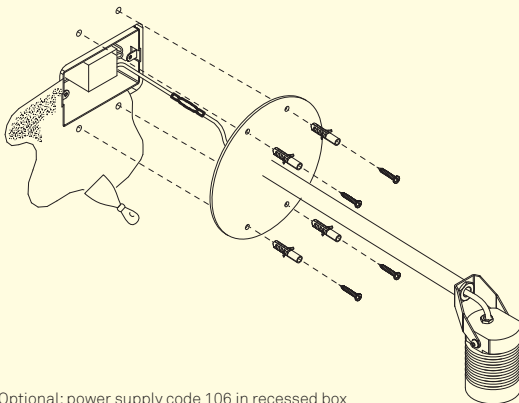

Optional: power supply code 106 in recessed box

Accessories: Iota

acc. code ▶ prod. code ▼	105	136	150	106	235	87	175	147	155	110	215
513002		•	1	1		2	2	3	9	17	
513003		•	1	1		2	2	3	9	17	
513012		•	1	1		2	2	3	9	17	
513013		•	1	1		2	2	3	9	17	
513022		•	1	1		2	2		7	14	
513023		•	1	1		2	2		7	14	
513032		•	1	1		2	2		7	14	
513033		•	1	1		2	2		7	14	
513035					1			3	9	17	•
513036					1			3	9	17	•
513038					1			3	9	17	•
513039					1			3	9	17	•
513047					1			3	9	17	•
513048					1			3	9	17	•
513050					1			3	9	17	•
513051					1			3	9	17	•
513059	•		1	1				3	9	17	
513060	•		1	1				3	9	17	
513062	•		1	1				3	9	17	
513063	•		1	1				3	9	17	
513065	•		1	1				3	9	17	
513066	•		1	1				3	9	17	
513068	•		1	1				3	9	17	
513069	•		1	1				3	9	17	
513080		•	1	1		2	2	3	9	17	
513082		•	1	1		2	2	3	9	17	
513084		•	1	1		2	2		7	14	
513086		•	1	1		2	2		7	14	
513088		•	1	1		2	2	3	9	17	•
513090		•	1	1		2	2	3	9	17	•
513092		•	1	1		2	2	3	9	17	•
513094		•	1	1		2	2	3	9	17	•
513096	•		1	1				3	9	17	
513098	•		1	1				3	9	17	
513100	•		1	1				3	9	17	
513102	•		1	1				3	9	17	

Max fixtures for each power supply (Vin 220±240). Data in the chart are provided as a guide only. Please verify according to your installation.



- Adjustable projector for installation on wall, on pole/ bracket or on floor.
- Configuration: die-cast aluminium structure, EN AB-47100 alloy (low copper content). Glass diffuser: extra-clear or sandblasted.
- Double layer coating for high resistance to corrosion: the aluminium components are painted with a double coat using powders which are compliant with QUALICOAT standards: a first layer of epoxy powder (with excellent chemical and mechanical resistance) and a second finishing layer of polyester powder (resistant to UV rays and atmospheric agents). The entire painting process of the aluminium fitting starts from components which have been sand-blasted in advance to make the surface more porous and increase the adherence of the paint. Ares effects alkaline and acid washing to clean the surfaces completely, then rinses with demineralised water to remove any residue particles, subsequently a chemical conversion treatment is done to protect against rusting.
- Protection rating: IP65
- In compliance with EN60598-1 standards
- Class of insulation: II
- Installation: the luminaire is equipped with 700mm cable for an easy-to-make connection. The bracket / pole is supplied with a 2-way terminal block for 3-conductor cables – IP68.
- We recommend the use of a connection system with a protection degree greater than or equal to the protection degree of the luminaire.
- During the installation and the maintenance of the fixtures it is important to be careful and avoid damages on the paint coating. Damages on the coating exposed to outdoor conditions or water, could cause corrosion. Chemical substances affect the anticorrosion covering protection.

EU Regulation 874/2012 - Illumination equipment energy classes

A++
A+
A

LED VERSION:
Class A / A+ / A++
Luminaire supplied
with integrated LED modules
that cannot be replaced



Floor installation



Wall fitting



Installation on pole

Pre-wired with approx
700mm of cable.Protection against
impact.
IK 05 - 0,70 joule

Perseo4 - Transparent Glass - Adjustable - 8°

Light Source: Power LED / 4,4W / Total power 7W / CRI>80 / 100±240V / Integral electronic power supply



525140
White 2700K
Lm LED 398 ± Lm OUTPUT 373

525013
White 3000K
Lm LED 428 ± Lm OUTPUT 401

525012
White 4000K
Lm LED 456 ± Lm OUTPUT 427

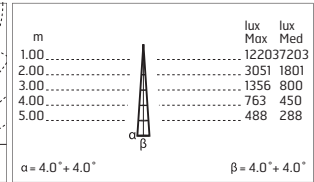
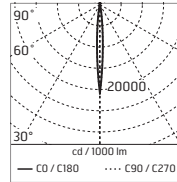

@4000K

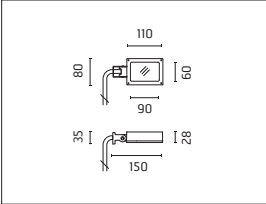

IP65

Perseo4 - Transparent Glass - Adjustable - 40°

Light Source: Power LED / 4,4W / Total power 7W / CRI>80 / 100±240V / Integral electronic power supply



525142
White 2700K
Lm LED 398 ± Lm OUTPUT 332

525023
White 3000K
Lm LED 428 ± Lm OUTPUT 357

525022
White 4000K
Lm LED 456 ± Lm OUTPUT 381

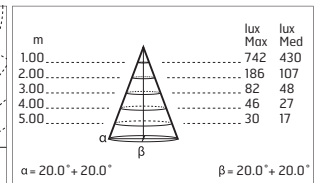
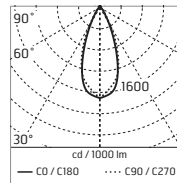

@4000K

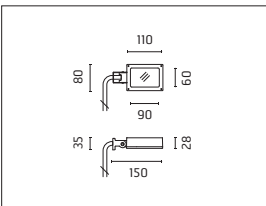

IP65

Perseo4 - Adjustable - Sandblasted Glass - Diffused Light

Light Source: Mid-Power LED / 6,6W / Total power 9W / CRI>80 / 100±240V / Integral electronic power supply



525144
White 2700K
Lm LED 836 ± Lm OUTPUT 435

525003
White 3000K
Lm LED 899 ± Lm OUTPUT 468

525002
White 4000K
Lm LED 943 ± Lm OUTPUT 491

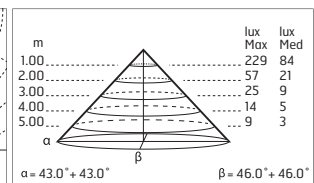
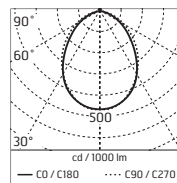

@4000K

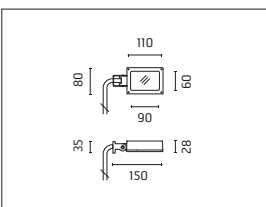

IP65

Installation scheme: Perseo4

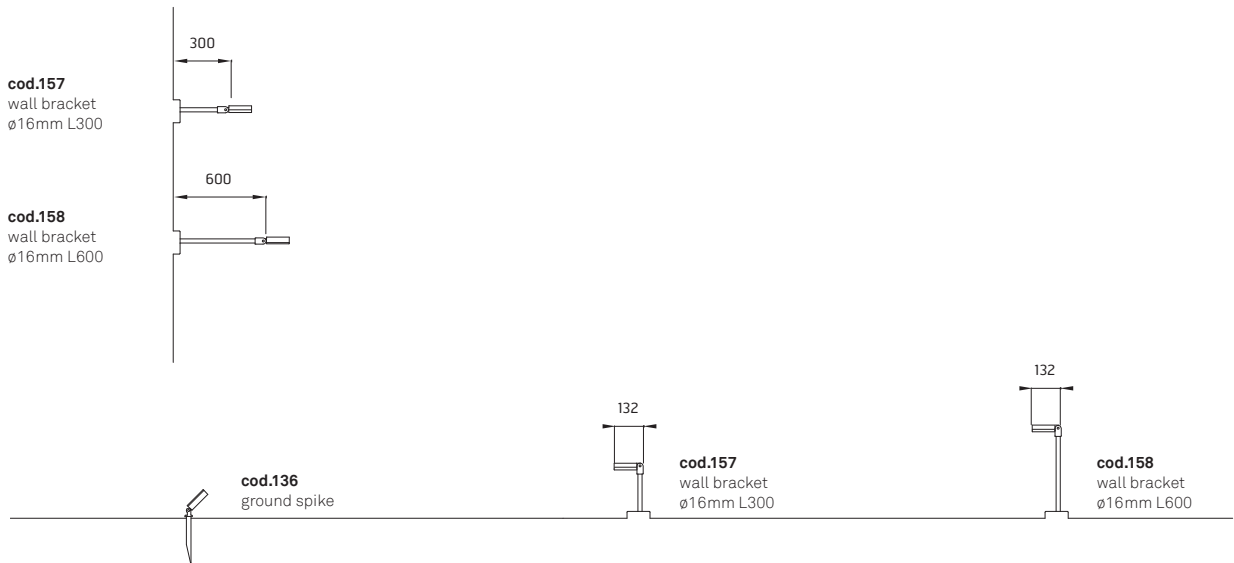

Accessories: Perseo4

136
GROUND SPIKE - H 200mm

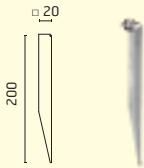

157
WALL BRACKET / POLE 300mm

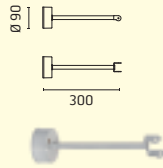

158
WALL BRACKET / POLE 600mm

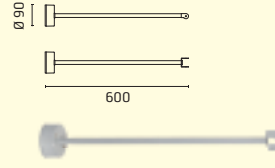

237
SPD: (SURGE PROTECTION DEVICE)
275Vac
MAXIMUM DISCHARGE CURRENT
10KA (8 / 20µs)
MAXIMUM OPERATING CURRENT 5A
SUITABLE FOR SERIES CONNEC-
TION - IP66

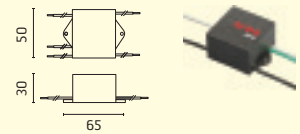

acc. code ▶	136	157	158	237
prod. code ▼				
525002	•	•	•	•
525003	•	•	•	•
525012	•	•	•	•
525013	•	•	•	•
525022	•	•	•	•
525023	•	•	•	•
525140	•	•	•	•
525142	•	•	•	•
525144	•	•	•	•



- Adjustable projector for installation on wall, on pole / bracket or on floor.
- Configuration: die-cast aluminium structure, EN AB-47100 alloy (low copper content). Glass diffuser: extra-clear or sandblasted, fixed to the aluminium frame through a robotic gluing system.
- Double layer coating for high resistance to corrosion: the aluminium components are painted with a double coat using powders which are compliant with QUALICOAT standards: a first layer of epoxy powder (with excellent chemical and mechanical resistance) and a second finishing layer of polyester powder (resistant to UV rays and atmospheric agents). The entire painting process of the aluminium fitting starts from components which have been sand-blasted in advance to make the surface more porous and increase the adherence of the paint. Ares effects alkaline and acid washing to clean the surfaces completely, then rinses with demineralised water to remove any residue particles, subsequently a chemical conversion treatment is done to protect against rusting.
- Protection rating: IP65
- In compliance with EN60598-1 standards
- Class of insulation: I
- Installation: the luminaire is equipped with 2000mm cable for an easy-to-make connection. The bracket / pole is supplied with a 2-way terminal block for 3-conductor cables – IP68.
- We recommend the use of a connection system with a protection degree greater than or equal to the protection degree of the luminaire.
- During the installation and the maintenance of the fixtures it is important to be careful and avoid damages on the paint coating.
Damages on the coating exposed to outdoor conditions or water, could cause corrosion.
Chemical substances affect the anticorrosion covering protection.

EU Regulation 874/2012 - Illumination equipment energy classes



LED VERSION:
Class A / A+ / A++
Luminaire supplied
with integrated LED modules
that cannot be replaced



Floor installation



Wall fitting



Installation on pole

Pre-wired with approx
2000mm of cable.Protection against
impact.
IK 06 - 1,00 joule

Perseo9 - Transparent Glass - Adjustable - 13°

Light Source: Power LED / 9,9W / Total power 12W / CRI>80 / 220÷240V / Integral electronic power supply



525146.A
White 2700K
Lm LED 1256 ≠ Lm OUTPUT 866



525043.A
White 3000K
Lm LED 1395 ≠ Lm OUTPUT 963



525042.A
White 4000K
Lm LED 1247 ≠ Lm OUTPUT 984

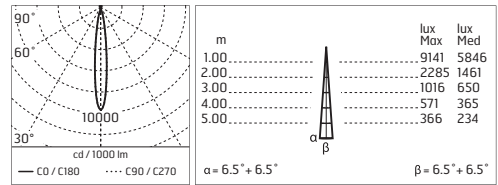

@4000K

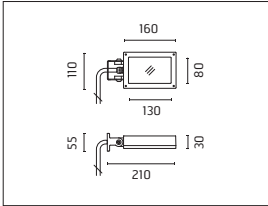

IP65

Perseo9 - Transparent Glass - Adjustable - 42°

Light Source: Power LED / 9,9W / Total power 12W / CRI>80 / 220÷240V / Integral electronic power supply



525148.A
White 2700K
Lm LED 1256 ≠ Lm OUTPUT 745



525053.A
White 3000K
Lm LED 1395 ≠ Lm OUTPUT 828



525052.A
White 4000K
Lm LED 1247 ≠ Lm OUTPUT 846

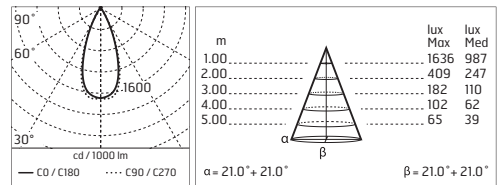

@4000K

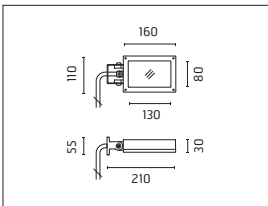

IP65

Perseo9 - Adjustable - Sandblasted Glass - Diffused Light

Light Source: Mid-Power LED / 8,8W / Total power 11W / CRI>80 / 220÷240V / Integral electronic power supply



525150
White 2700K
Lm LED 1114 ≠ Lm OUTPUT 580



525033
White 3000K
Lm LED 1198 ≠ Lm OUTPUT 624



525032
White 4000K
Lm LED 1258 ≠ Lm OUTPUT 655

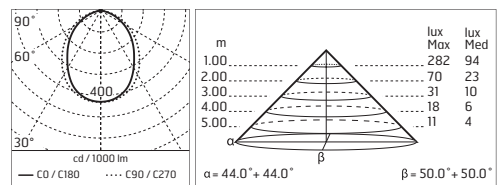

@4000K

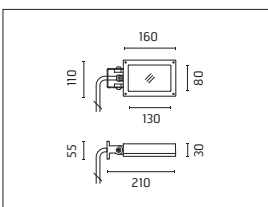

IP65

Perseo9 LED / Ø 48mm - Poles With Base



177
H 500 mm

178
H 800 mm

Installation scheme: Perseo9

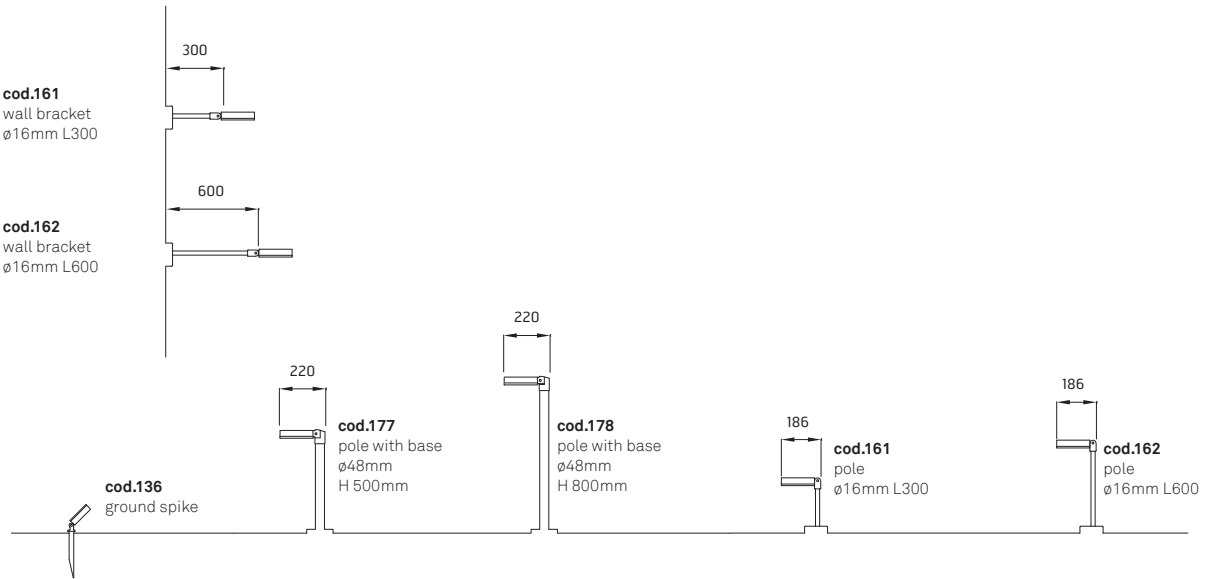

Accessories: Perseo9

136
GROUND SPIKE - H 200mm

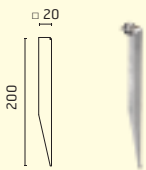

161
WALL BRACKET / POLE 300mm

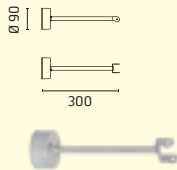

162
WALL BRACKET / POLE 600mm

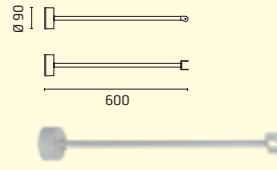

182
BASE PLATE AND FIXING BOLTS
Ø 105 x H 160mm

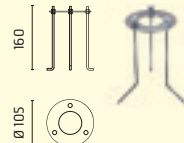

237
SPD: (SURGE PROTECTION DEVICE)
275Vac
MAXIMUM DISCHARGE CURRENT
10KA (8 / 20µs)
MAXIMUM OPERATING CURRENT 5A
SUITABLE FOR SERIES CONNEC-
TION - IP66

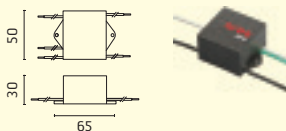

acc. code ▶	136	161	162	182	237
prod. code ▼					
177				•	
178				•	
525032	•	•	•		•
525033	•	•	•		•
525042.A	•	•	•		•
525043.A	•	•	•		•
525052.A	•	•	•		•
525053.A	•	•	•		•
525146.A	•	•	•		•
525148.A	•	•	•		•
525150	•	•	•		•

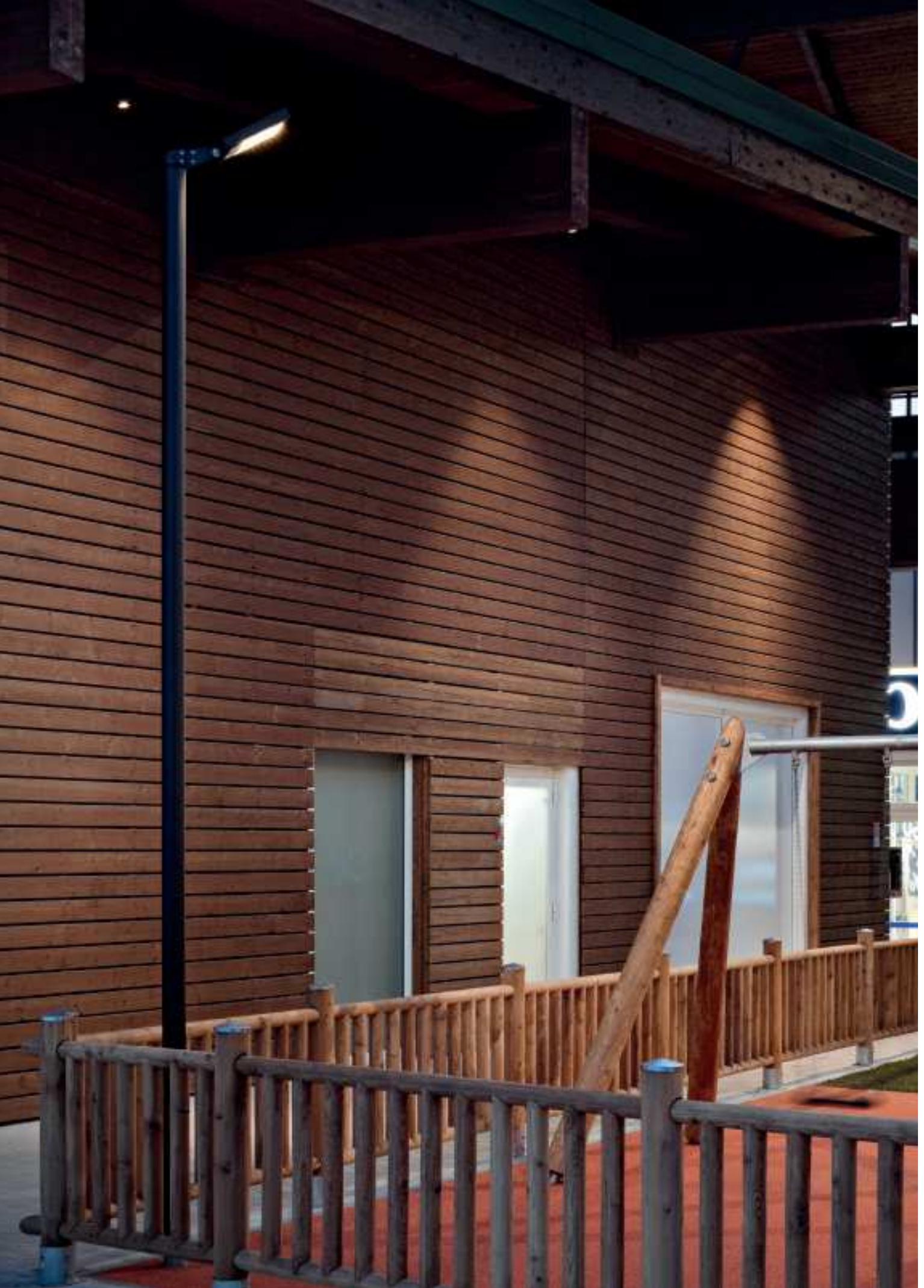

PERSEO 16

- Adjustable projector for installation on wall or on pole.
- Configuration: die-cast aluminium structure. EN AB-47100 alloy (low copper content). Glass diffuser: extra-clear, fixed to the frame through a robotic gluing system.
- Double layer coating for high resistance to corrosion: the aluminium components are painted with a double coat using powders which are compliant with QUALICOAT standards: a first layer of epoxy powder (with excellent chemical and mechanical resistance) and a second finishing layer of polyester powder (resistant to UV rays and atmospheric agents). The entire painting process of the aluminium fitting starts from components which have been sand-blasted in advance to make the surface more porous and increase the adherence of the paint. Ares effects alkaline and acid washing to clean the surfaces completely, then rinses with demineralised water to remove any residue particles, subsequently a chemical conversion treatment is done to protect against rusting.
- Protection rating: IP65
- In compliance with EN60598-1 standards
- Class of insulation: I
- Installation: wiring through an M16x1.5 metal cable gland (4,5mmϕ<math><10\text{mm}</math> cables). Outdoor use requires suitable flexible cables assuring the watertightness of the cable gland.
- During the installation and the maintenance of the fixtures it is important to be careful and avoid damages on the paint coating.
Damages on the coating exposed to outdoor conditions or water, could cause corrosion.
Chemical substances affect the anticorrosion covering protection.

EU Regulation 874/2012 - Illumination equipment energy classes



LED VERSION:
Class A / A+ / A++
Luminaire supplied
with integrated LED modules
that cannot be replaced



.1 White



.6 Grey



.3 Anthracite



.4 Black



.18 Deep Brown



Floor installation



Wall fitting



Installation on pole



The fitting is
equipped with
1 cable input



Protection against
impact.
IK 07 - 2,00 joule

Perseo16 - Adjustable - 11°

Light Source: Power LED / 17,6W / Total power 20W / CRI>80 / 220÷240V / Integral electronic power supply



525152.A
525152.A-300 Dimmable Dali
525152.A-310 Dimmable 1-10
 White 2700K
 Lm LED 2232 ≠ Lm OUTPUT 1559

525093.A
525093.A-300 Dimmable Dali
525093.A-310 Dimmable 1-10
 White 3000K
 Lm LED 2424 ≠ Lm OUTPUT 1732

525092.A
525092.A-300 Dimmable Dali
525092.A-310 Dimmable 1-10
 White 4000K
 Lm LED 2536 ≠ Lm OUTPUT 1771

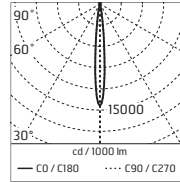

m	lux	
	Max	Med
1.00	24796	16031
2.00	6199	4008
3.00	2755	1781
4.00	1550	1002
5.00	992	641

$\alpha = 5.5^\circ + 5.5^\circ$ $\beta = 5.5^\circ + 5.5^\circ$

@4000K

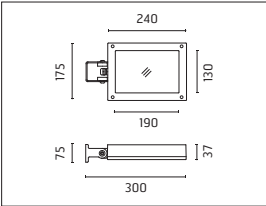

IP65

Perseo16 - Adjustable - 34°

Light Source: Power LED / 17,6W / Total power 20W / CRI>80 / 220÷240V / Integral electronic power supply



525154.A
525154.A-300 Dimmable Dali
525154.A-310 Dimmable 1-10
 White 2700K
 Lm LED 2232 ≠ Lm OUTPUT 1582

525083.A
525083.A-300 Dimmable Dali
525083.A-310 Dimmable 1-10
 White 3000K
 Lm LED 2524 ≠ Lm OUTPUT 1757

525082.A
525082.A-300 Dimmable Dali
525082.A-310 Dimmable 1-10
 White 4000K
 Lm LED 2536 ≠ Lm OUTPUT 1797

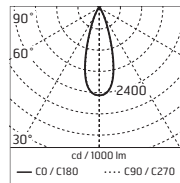

m	lux	
	Max	Med
1.00	4365	2751
2.00	1091	688
3.00	485	306
4.00	273	172
5.00	175	110

$\alpha = 17.0^\circ + 17.0^\circ$ $\beta = 17.0^\circ + 17.0^\circ$

@4000K

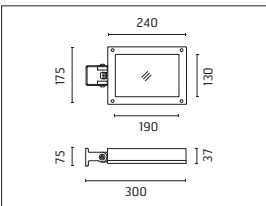

IP65

Perseo16 - Adjustable - Asymmetric optic

Light Source: Power LED / 17,6W / Total power 20W / CRI>80 / 220÷240V / Integral electronic power supply



525156.A
525156.A-300 Dimmable Dali
525156.A-310 Dimmable 1-10
 White 2700K
 Lm LED 2232 ≠ Lm OUTPUT 1168

525063.A
525063.A-300 Dimmable Dali
525063.A-310 Dimmable 1-10
 White 3000K
 Lm LED 2424 ≠ Lm OUTPUT 1298

525062.A
525062.A-300 Dimmable Dali
525062.A-310 Dimmable 1-10
 White 4000K
 Lm LED 2536 ≠ Lm OUTPUT 1327

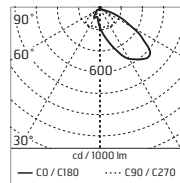

m	lux	
	Max	Med
1.00	496	169
2.00	124	42
3.00	55	19
4.00	31	11
5.00	20	7

$\alpha = 30.0^\circ + 17.0^\circ$ $\beta = 46.0^\circ + 46.0^\circ$

@4000K

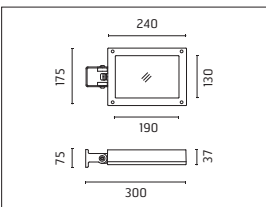

IP65

Perseo16 - Adjustable - Street light optic 120°

Light Source: Power LED / 17,6W / Total power 20W / CRI>80 / 220÷240V / Integral electronic power supply

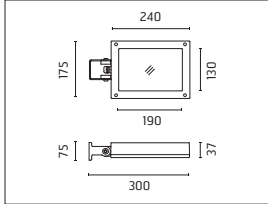

525158.A
525158.A-300 Dimmable Dali
525158.A-310 Dimmable 1-10
 White 2700K
 Lm LED 2232 ≠ Lm OUTPUT 972

525073.A
525073.A-300 Dimmable Dali
525073.A-310 Dimmable 1-10
 White 3000K
 Lm LED 2424 ≠ Lm OUTPUT 1080

525072.A
525072.A-300 Dimmable Dali
525072.A-310 Dimmable 1-10
 White 4000K
 Lm LED 2536 ≠ Lm OUTPUT 1105

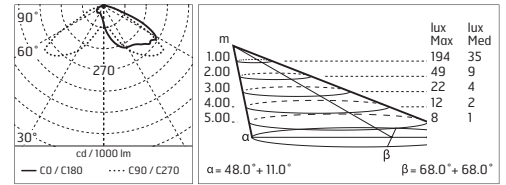

@4000K

IP65

Installation scheme: Perseo16

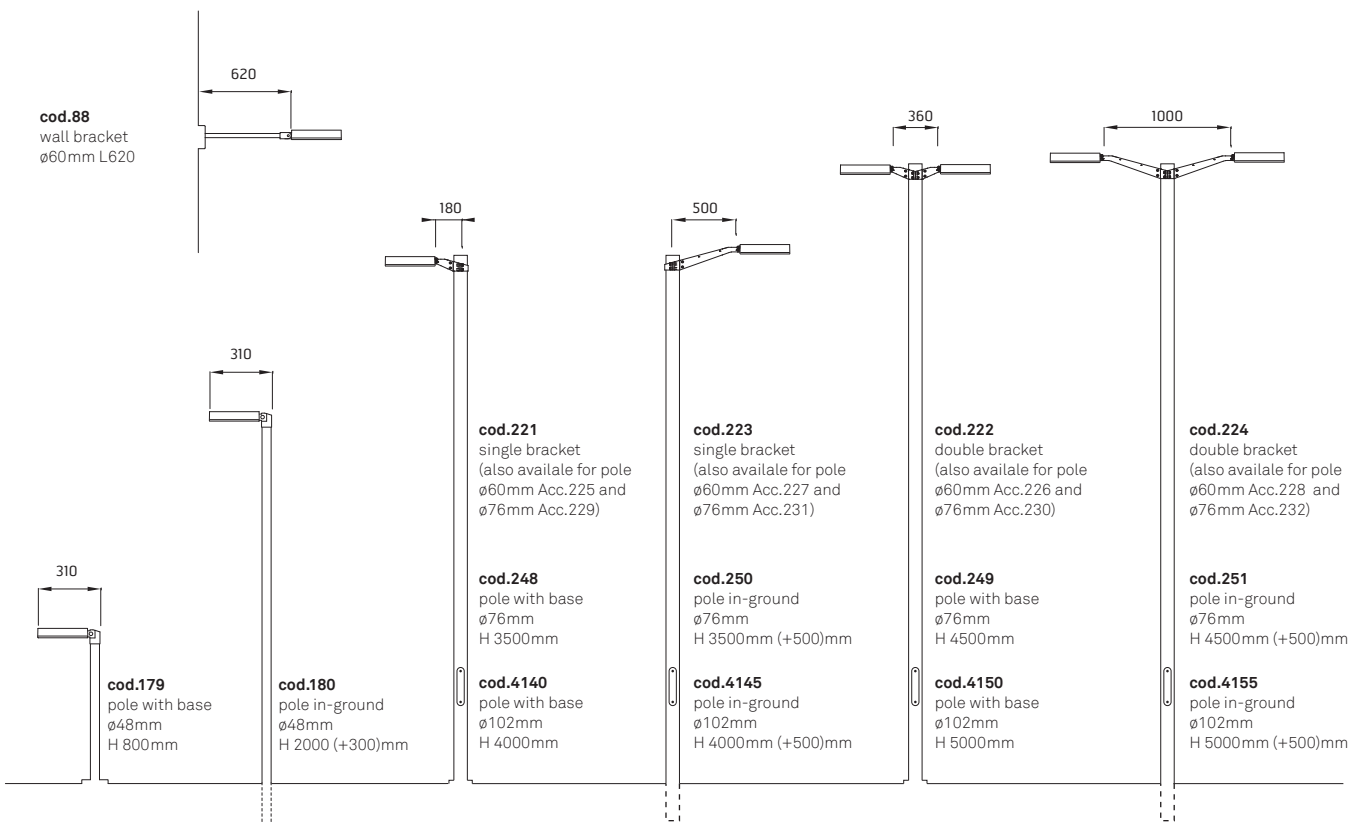

Perseo16 LED / Ø 48mm - Poles



179
H 800 mm

With Base

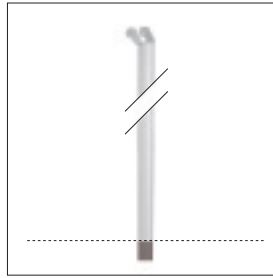

180
H 2000 mm (+300mm)

In-Ground (+300 mm Root)

Perseo16 LED / Ø 76mm - Poles

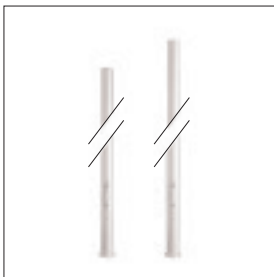

248
H 3500 mm

249
H 4500 mm

**With Base and Access Door
With Terminal Block 4x1,5-16mmq**

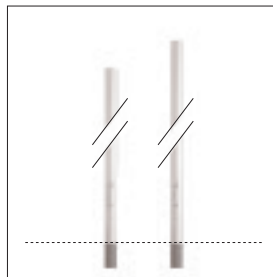

250
H 3500 mm (+500mm)

251
H 4500 mm (+500mm)

**In-Ground (+500 mm Root) With Access Door
With Terminal Block 4x1,5-16mmq**



.6 Grey .3 Anthracite



.6 Grey .3 Anthracite

Perseo16 LED / Ø 102mm - Poles

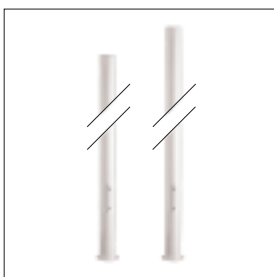

4140
H 4000 mm

4150
H 5000 mm

**With Base and Access Door
With Terminal Block 4x1,5-16mmq**

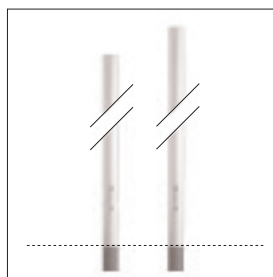

4145
H 4000 mm (+500mm)

4155
H 5000 mm (+500mm)

**In-Ground (+500 mm Root) With Access Door
With Terminal Block 4x1,5-16mmq**



.6 Grey .3 Anthracite



.6 Grey .3 Anthracite



Accessories: Perseo16



165
WALL WASHER VISOR

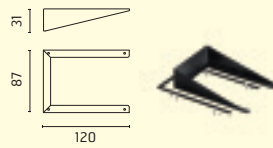

88
WALL BRACKET 620mm

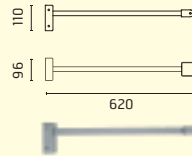

166
ANTI VANDAL LOUVRE

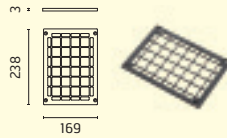

116
BASE PLATE AND FIXING BOLTS
230 x 230 x H 200mm

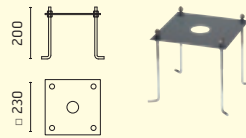

182
BASE PLATE AND FIXING BOLTS
Ø 105 x H 160mm

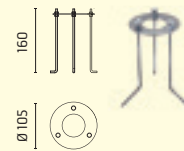

237
SPD: (SURGE PROTECTION DEVICE)
275Vac
MAXIMUM DISCHARGE CURRENT
10KA (8 / 20µs)
MAXIMUM OPERATING CURRENT 5A
SUITABLE FOR SERIES CONNEC-
TION - IP66

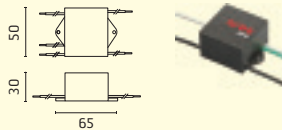

Accessories: Perseo16

221
SINGLE BRACKET 180mm
FOR POLE Ø 102mm



222
DOUBLE BRACKET 180mm
FOR POLE Ø 102mm

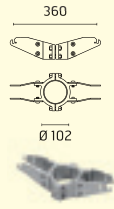

223
SINGLE BRACKET 500mm
FOR POLE Ø 102mm

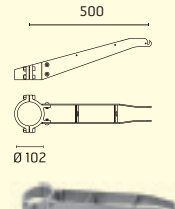

224
DOUBLE BRACKET 500mm
FOR POLE Ø 102mm

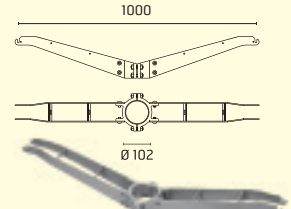

225
SINGLE BRACKET 180mm
FOR POLE Ø 60mm



226
DOUBLE BRACKET 180mm
FOR POLE Ø 60mm



227
SINGLE BRACKET 500mm
FOR POLE Ø 60mm

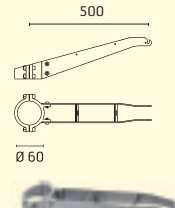

228
DOUBLE BRACKET 500mm
FOR POLE Ø 60mm

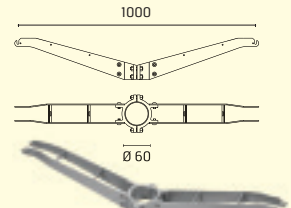

229
SINGLE BRACKET 180mm
FOR POLE Ø 76mm

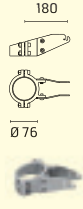

230
DOUBLE BRACKET 180mm
FOR POLE Ø 76mm

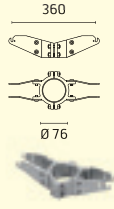

231
SINGLE BRACKET 500mm
FOR POLE Ø 76mm

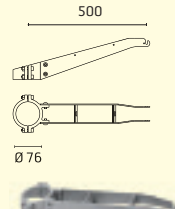

232
DOUBLE BRACKET 500mm
FOR POLE Ø 76mm

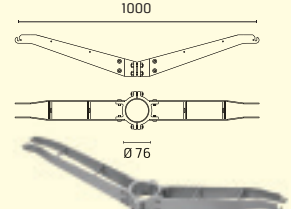

acc. code ▶	dimmi DALI	dimmi 1-10	165	166	88	116	182	237	221	222	223	224	225	226	227	228	229	230	231	232
179	-300	-310					•													
180	-300	-310																		
248	-300	-310				•														
249	-300	-310				•														
250	-300	-310																		
251	-300	-310																		
4140	-300	-310				•			•	•	•	•								
4145	-300	-310							•	•	•	•								
4150	-300	-310				•			•	•	•	•								
4155	-300	-310							•	•	•	•								
525062.A	-300	-310	•	•	•			•	•	•	•	•	•	•	•	•	•	•	•	•
525063.A	-300	-310	•	•	•			•	•	•	•	•	•	•	•	•	•	•	•	•
525072.A	-300	-310	•	•	•			•	•	•	•	•	•	•	•	•	•	•	•	•
525073.A	-300	-310	•	•	•			•	•	•	•	•	•	•	•	•	•	•	•	•
525082.A	-300	-310	•	•	•			•	•	•	•	•	•	•	•	•	•	•	•	•
525083.A	-300	-310	•	•	•			•	•	•	•	•	•	•	•	•	•	•	•	•
525092.A	-300	-310	•	•	•			•	•	•	•	•	•	•	•	•	•	•	•	•
525093.A	-300	-310	•	•	•			•	•	•	•	•	•	•	•	•	•	•	•	•
525152.A	-300	-310	•	•	•			•	•	•	•	•	•	•	•	•	•	•	•	•
525154.A	-300	-310	•	•	•			•	•	•	•	•	•	•	•	•	•	•	•	•
525156.A	-300	-310	•	•	•			•	•	•	•	•	•	•	•	•	•	•	•	•
525158.A	-300	-310	•	•	•			•	•	•	•	•	•	•	•	•	•	•	•	•



PERSEO 30

- Adjustable projector for installation on wall or on pole.
- Configuration: die-cast aluminium structure. EN AB-47100 alloy (low copper content). Glass diffuser: extra-clear, fixed to the frame through a robotic gluing system. Graduated stainless steel fixing plate for a precise adjustment.
- Double layer coating for high resistance to corrosion: the aluminium components are painted with a double coat using powders which are compliant with QUALICOAT standards: a first layer of epoxy powder (with excellent chemical and mechanical resistance) and a second finishing layer of polyester powder (resistant to UV rays and atmospheric agents). The entire painting process of the aluminium fitting starts from components which have been sand-blasted in advance to make the surface more porous and increase the adherence of the paint. Ares effects alkaline and acid washing to clean the surfaces completely, then rinses with demineralised water to remove any residue particles, subsequently a chemical conversion treatment is done to protect against rusting.
- Protection rating: IP65
- In compliance with EN60598-1 standards
- Class of insulation: I
- Installation: wiring through an M20x1.5 metal cable gland (7mm$\lt\mathit{13mm}$ cables). Outdoor use requires suitable flexible cables assuring the watertightness of the cable gland.
- During the installation and the maintenance of the fixtures it is important to be careful and avoid damages on the paint coating.
Damages on the coating exposed to outdoor conditions or water, could cause corrosion.
Chemical substances affect the anticorrosion covering protection.

EU Regulation 874/2012 - Illumination equipment energy classes

A++
A+
A

LED VERSION:
Class A / A+ / A++
Luminaire supplied with integrated LED modules that cannot be replaced



Floor installation



Wall fitting



Installation on pole



The fitting is equipped with 1 cable input



Protection against impact.
IK 07 - 2,00 joule

Perseo30 - Adjustable - 11°

Light Source: Power LED / 48W / Total power 53W / CRI>80 / 220÷240V / Integral electronic power supply



525160.A
525160.A-300 Dimmable Dali
525160-310 Dimmable 1-10
 White 2700K
 Lm LED 5859 ≠ Lm OUTPUT 3989

525133.A
525133.A-300 Dimmable Dali
525133.A-310 Dimmable 1-10
 White 3000K
 Lm LED 6363 ≠ Lm OUTPUT 4332

525132.A
525132.A-300 Dimmable Dali
525132.A-310 Dimmable 1-10
 White 4000K
 Lm LED 6657 ≠ Lm OUTPUT 4533

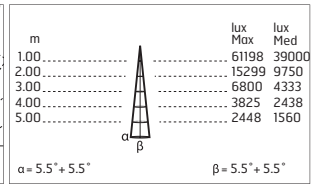
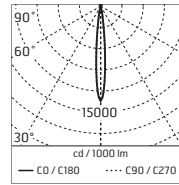

@4000K

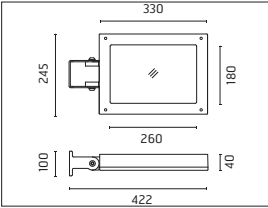

IP65

Perseo30 - Adjustable - 34°

Light Source: Power LED / 48W / Total power 53W / CRI>80 / 220÷240V / Integral electronic power supply



525162.A
525162-300 Dimmable Dali
525162.A-310 Dimmable 1-10
 White 2700K
 Lm LED 5859 ≠ Lm OUTPUT 4056

525123.A
525123.A-300 Dimmable Dali
525123.A-310 Dimmable 1-10
 White 3000K
 Lm LED 6363 ≠ Lm OUTPUT 4405

525122.A
525122.A-300 Dimmable Dali
525122.A-310 Dimmable 1-10
 White 4000K
 Lm LED 6657 ≠ Lm OUTPUT 4609

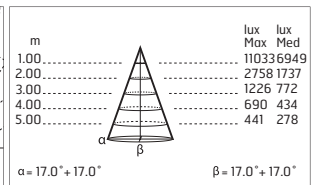
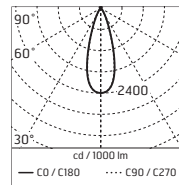

@4000K

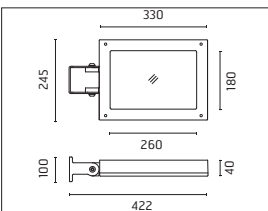

IP65

Perseo30 - Adjustable - Asymmetric optic

Light Source: Power LED / 48W / Total power 53W / CRI>80 / 220÷240V / Integral electronic power supply



525164.A
525164.A-300 Dimmable Dali
525164.A-310 Dimmable 1-10
 White 2700K
 Lm LED 5859 ≠ Lm OUTPUT 3085

525103.A
525103.A-300 Dimmable Dali
525103.A-310 Dimmable 1-10
 White 3000K
 Lm LED 6363 ≠ Lm OUTPUT 3350

525102.A
525102.A-300 Dimmable Dali
525102.A-310 Dimmable 1-10
 White 4000K
 Lm LED 6657 ≠ Lm OUTPUT 3505

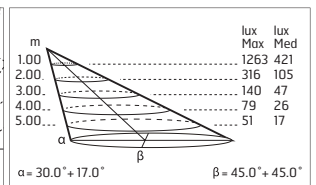
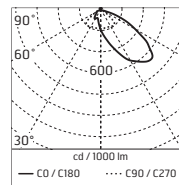

@4000K

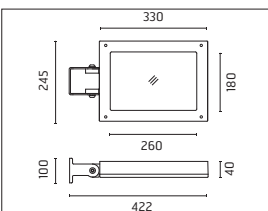

IP65

Perseo30 - Adjustable - Street light optic 120°

Light Source: Power LED / 48W / Total power 53W / CRI>80 / 220÷240V / Integral electronic power supply



525166.A
525166.A-300 Dimmable Dali
525166.A-310 Dimmable 1-10
 White 2700K
 Lm LED 5859 ≠ Lm OUTPUT 2609

525113.A
525113.A-300 Dimmable Dali
525113.A-310 Dimmable 1-10
 White 3000K
 Lm LED 6363 ≠ Lm OUTPUT 2834

525112.A
525112.A-300 Dimmable Dali
525112.A-310 Dimmable 1-10
 White 4000K
 Lm LED 6657 ≠ Lm OUTPUT 2965

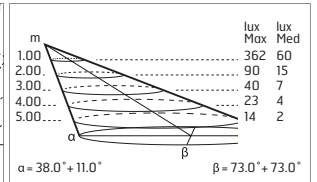
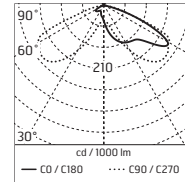

@4000K

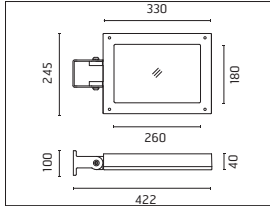

IP65

Perseo30 RGB - Adjustable - 40°

Light Source: Power LED / 34W / Total power 40W / 220÷240V with DMX interface / Integral electronic power supply



525124

Wiring diagram and installation scheme RGB

>> See Page 561
 Wiring Diagram n.8

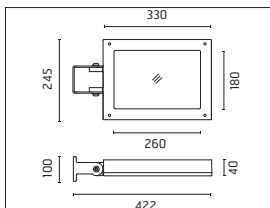

IP65

Perseo30 LED / Ø 76mm - Poles

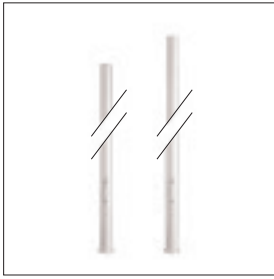

248
H 3500 mm

249
H 4500 mm

**With Base and Access Door
With Terminal Block 4x1,5-16mmq**



.6 Grey .3 Anthracite

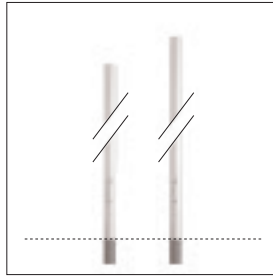

250
H 3500 mm (+500mm)

251
H 4500 mm (+500mm)

**In-Ground (+500 mm Root) With Access Door
With Terminal Block 4x1,5-16mmq**



.6 Grey .3 Anthracite

Perseo30 LED / Ø 102mm - Poles

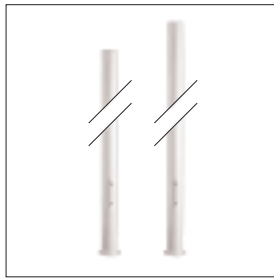

4140
H 4000 mm

4150
H 5000 mm

**With Base and Access Door
With Terminal Block 4x1,5-16mmq**



.6 Grey .3 Anthracite

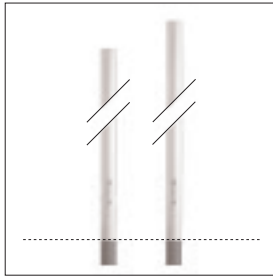

4145
H 4000 mm (+500mm)

4155
H 5000 mm (+500mm)

**In-Ground (+500 mm Root) With Access Door
With Terminal Block 4x1,5-16mmq**



.6 Grey .3 Anthracite

Installation scheme: Perseo30

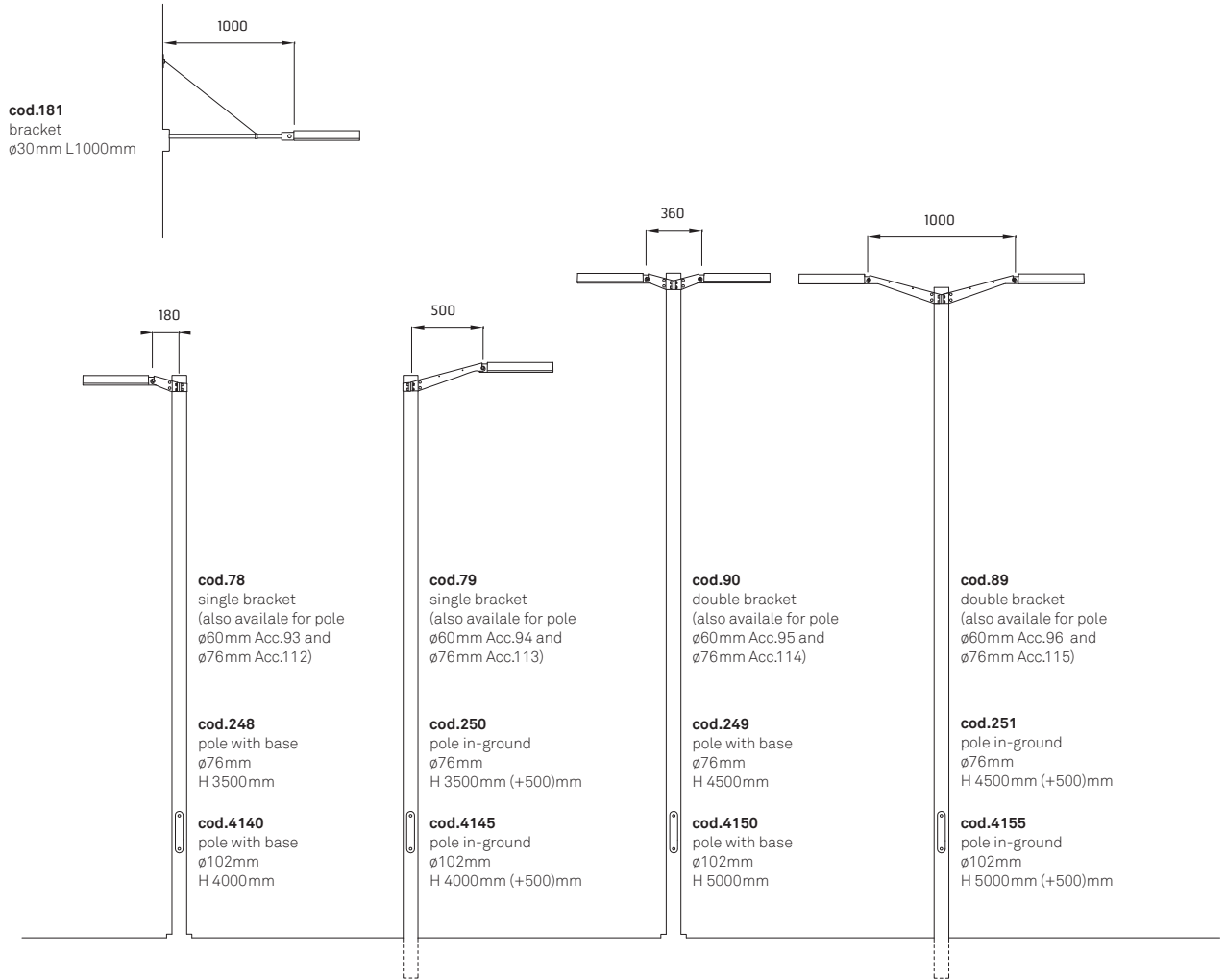

Accessories: Perseo30

78
SINGLE BRACKET 180mm
FOR POLE Ø 102mm

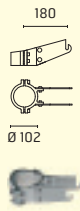

90
DOUBLE BRACKET 180mm
FOR POLE Ø 102mm



79
SINGLE BRACKET 500mm
FOR POLE Ø 102mm

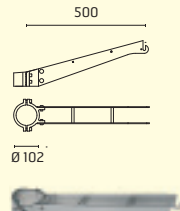

89
DOUBLE BRACKET 500mm
FOR POLE Ø 102mm

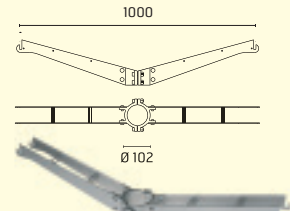

93
SINGLE BRACKET 180mm
FOR POLE Ø 60mm

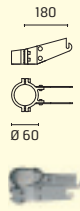

95
DOUBLE BRACKET 180mm
FOR POLE Ø 60mm

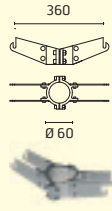

94
SINGLE BRACKET 500mm
FOR POLE Ø 60mm

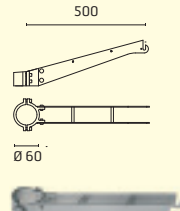

96
DOUBLE BRACKET 500mm
FOR POLE Ø 60mm

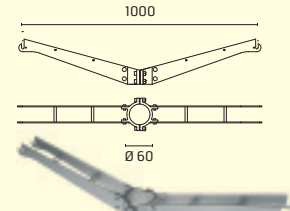

112
SINGLE BRACKET 180mm
FOR POLE Ø 76mm

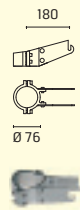

114
DOUBLE BRACKET 180mm
FOR POLE Ø 76mm



113
SINGLE BRACKET 500mm
FOR POLE Ø 76mm

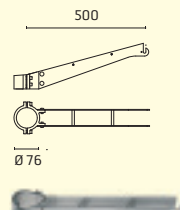

115
DOUBLE BRACKET 500mm
FOR POLE Ø 76mm

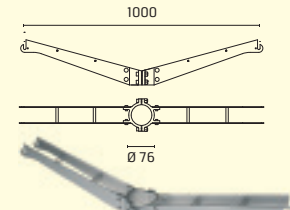

Accessories: Perseo30

116
BASE PLATE AND FIXING BOLTS
230 x 230 x H 200mm

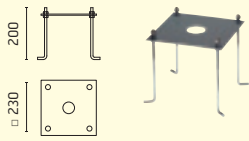

167
WALL WASHER VISOR
323

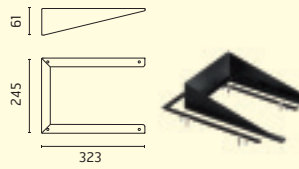

168
ANTI VANDAL LOUVRE
242

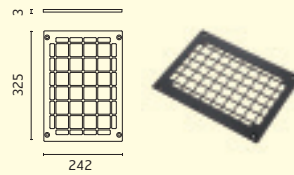

186
DMX CABLE - SHIELDED TWISTED PAIR
WITH 110 Ohm CONSTANT IMPEDANCE.



181
WALL BRACKET 1000mm

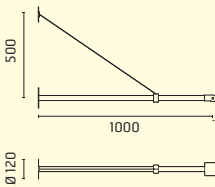

142
DMX CONTROLLER;
DIMMER SWITCH FOR RECESSED
BOX (60mm HOLE CENTRES)



143
DMX CONTROLLER;
STAND-ALONE / PC INTERFACE

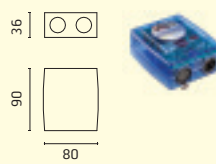

187
DMX SPLITTER 512 - ELECTRONIC
DEVICE TO REGENERATE THE MONODI-
RECTIONAL DMX SIGNAL
1 INPUT AND 7 OUTPUT, 12-24V dc

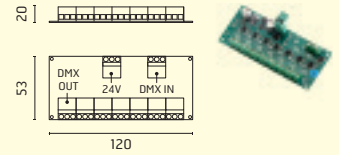

POWER SUPPLY TO BE ORDERED (87 OR 175 RECOMMENDED)

237
SPD: (SURGE PROTECTION DEVICE)
275Vac
MAXIMUM DISCHARGE CURRENT
10KA (8 / 20µs)
MAXIMUM OPERATING CURRENT 5A
SUITABLE FOR SERIES CONNECTION
- IP66

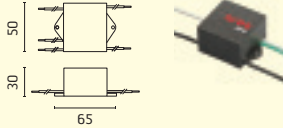

acc. code ▶ prod. code ▼	dimmi DALI	dimmi 1-10	78	90	79	89	93	95	94	96	112	114	113	115	116	167	168	181	142	143	186	187	237	
248	-300	-310													•									
249	-300	-310													•									
250	-300	-310																						
251	-300	-310																						
4140	-300	-310	•	•	•	•									•									
4145	-300	-310	•	•	•	•																		
4150	-300	-310	•	•	•	•									•									
4155	-300	-310	•	•	•	•																		
525102.A	-300	-310	•	•	•	•	•	•	•	•	•	•	•	•	•	•	•	•	•	•			•	
525103.A	-300	-310	•	•	•	•	•	•	•	•	•	•	•	•	•	•	•	•	•	•			•	
525112.A	-300	-310	•	•	•	•	•	•	•	•	•	•	•	•	•	•	•	•	•	•			•	
525113.A	-300	-310	•	•	•	•	•	•	•	•	•	•	•	•	•	•	•	•	•	•			•	
525122.A	-300	-310	•	•	•	•	•	•	•	•	•	•	•	•	•	•	•	•	•	•			•	
525123.A	-300	-310	•	•	•	•	•	•	•	•	•	•	•	•	•	•	•	•	•	•			•	
525124			•	•	•	•	•	•	•	•	•	•	•	•	•	•	•	•	•	•	•	•	•	•
525132.A	-300	-310	•	•	•	•	•	•	•	•	•	•	•	•	•	•	•	•	•	•			•	
525133.A	-300	-310	•	•	•	•	•	•	•	•	•	•	•	•	•	•	•	•	•	•			•	
525160.A	-300	-310	•	•	•	•	•	•	•	•	•	•	•	•	•	•	•	•	•	•			•	
525162.A	-300	-310	•	•	•	•	•	•	•	•	•	•	•	•	•	•	•	•	•	•			•	
525164.A	-300	-310	•	•	•	•	•	•	•	•	•	•	•	•	•	•	•	•	•	•			•	
525166.A	-300	-310	•	•	•	•	•	•	•	•	•	•	•	•	•	•	•	•	•	•			•	



- Luminaire for installation on wall or on pole.
- Configuration: die-cast aluminium structure, EN AB-47100 alloy (low copper content) and pure aluminium reflector. Glass diffuser: extra-clear.
- Double layer coating for high resistance to corrosion: the aluminium components are painted with a double coat using powders which are compliant with QUALICOAT standards: a first layer of epoxy powder (with excellent chemical and mechanical resistance) and a second finishing layer of polyester powder (resistant to UV rays and atmospheric agents). The entire painting process of the aluminium fitting starts from components which have been sand-blasted in advance to make the surface more porous and increase the adherence of the paint. Ares effects alkaline and acid washing to clean the surfaces completely, then rinses with demineralised water to remove any residue particles, subsequently a chemical conversion treatment is done to protect against rusting.
- Protection rating: IP65
- In compliance with EN60598-1 standards
- Class of insulation: I
- Installation: wiring through a M16x1,5 metal cable gland (4,5mm$\lt\mathit{0}$10mm cables). Outdoor use requires suitable flexible cables assuring the watertightness of the cable gland. CoB LED version is supplied with a 2-way terminal block for 3-conductor cables – IP68.
- During the installation and the maintenance of the fixtures it is important to be careful and avoid damages on the paint coating.
Damages on the coating exposed to outdoor conditions or water, could cause corrosion.
Chemical substances affect the anticorrosion covering protection.

EU Regulation 874/2012 - Illumination equipment energy classes



LED VERSION::
Class A/A+/A++
Luminaire supplied
with integrated LED modules
that cannot be replaced



.1 White



.6 Grey



.3 Anthracite



.4 Black



.18 Deep Brown



Wall fitting



Floor installation



Installation on pole



The fitting is
equipped with
1 cable input



Protection against
impact.
IK 07 - 2,00 joule

MiniFranco - Adjustable - Symmetric Optic

Light Source: CoB LED / 22W / Total power 24W / CRI >80 / 220÷240V / Integral electronic power supply



1628123
White 2700K
lm LED 2856 ≠ lm OUTPUT 1920

1628113
White 3000K
lm LED 3071 ≠ lm OUTPUT 2065

1628013
White 4000K
lm LED 3221 ≠ lm OUTPUT 2166

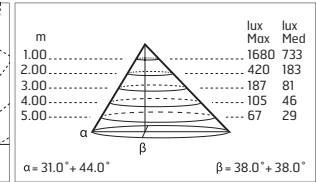
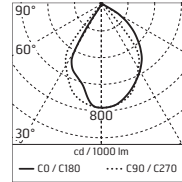

@4000K

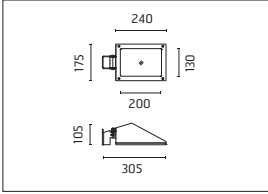

IP65

MiniFranco - Adjustable - Asymmetric Optic

Light Source: CoB LED / 22W / Total power 24W / CRI >80 / 220÷240V / Integral electronic power supply



1628124
White 2700K
lm LED 2856 ≠ lm OUTPUT 1506

1628114
White 3000K
lm LED 3071 ≠ lm OUTPUT 2065

1628014
White 4000K
lm LED 3221 ≠ lm OUTPUT 2166

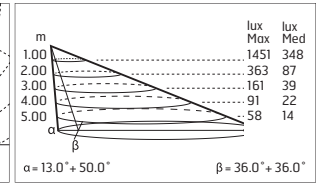
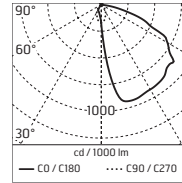

@4000K

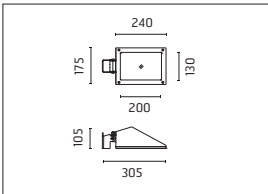

IP65

MiniFranco - Adjustable - 10°

Light Source: Power LED / 17,6W / Total power 20W / CRI >80 / 220÷240V / Integral electronic power supply



1610122
White 2700K
lm LED 1540 ≈ lm OUTPUT 1335

1610112
White 3000K
lm LED 1656 ≈ lm OUTPUT 1435

1622412
White 4000K
lm LED 1832 ≈ lm OUTPUT 1588

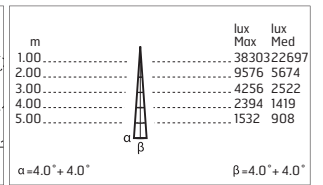
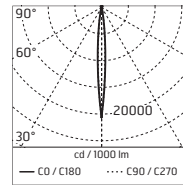
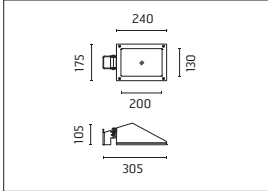

@4000K

IP65

MiniFranco - Adjustable - 40°

Light Source: Power LED / 17,6W / Total power 20W / CRI >80 / 220÷240V / Integral electronic power supply



1610123
White 2700K
lm LED 1540 ≈ lm OUTPUT 1150

1610113
White 3000K
lm LED 1656 ≈ lm OUTPUT 1237

1622413
White 4000K
lm LED 1832 ≈ lm OUTPUT 1368

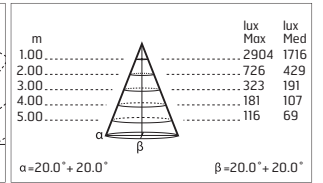
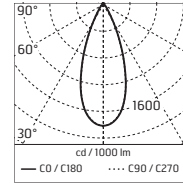
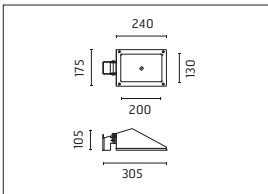

@4000K

IP65

MiniFranco / Ø 60mm - Poles

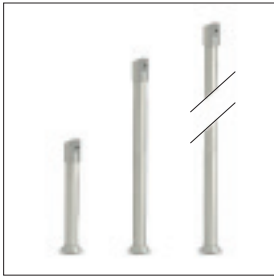

1005
H 500 mm

1009
H 900 mm

117
H 2000 mm

With Base
With fixed pole head hooking.
Non-adjustable projector



1105
H 500 mm (+300mm)

1109
H 900 mm (+300mm)

In-Ground (+300 mm Root)

MiniFranco / Ø 76mm - Poles

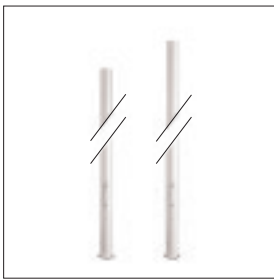

248
H 3500 mm

249
H 4500 mm

With Base and Access Door
With Terminal Block 4x1,5-16mmq

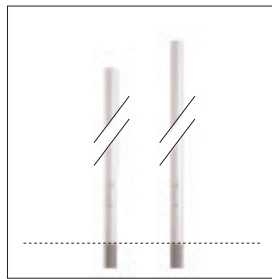
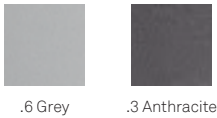

250
H 3500 mm (+500mm)

251
H 4500 mm (+500mm)

In-Ground (+500 mm Root) With Access Door
With Terminal Block 4x1,5-16mmq

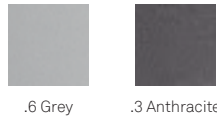

MiniFranco / Ø 102mm - Poles

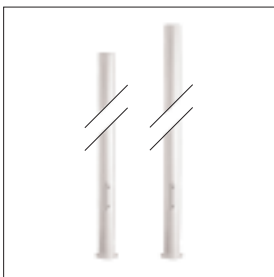

4140
H 4000 mm

4150
H 5000 mm

With Base and Access Door
With Terminal Block 4x1,5-16mmq

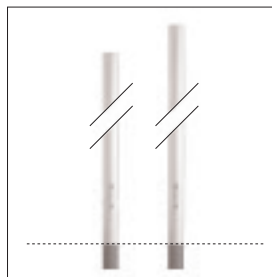
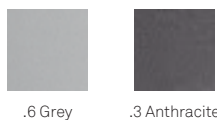

4145
H 4000 mm (+500mm)

4155
H 5000 mm (+500mm)

In-Ground (+500 mm Root) With Access Door
With Terminal Block 4x1,5-16mmq



Installation scheme: MiniFranco

Adjustable Projector on Wall

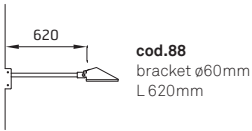

Non-Adjustable Projector on Pole

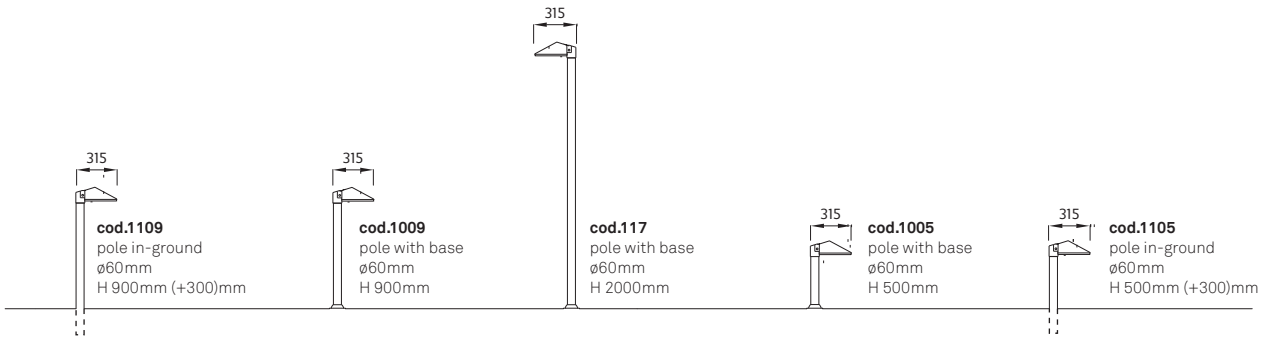

Adjustable Projector on Pole

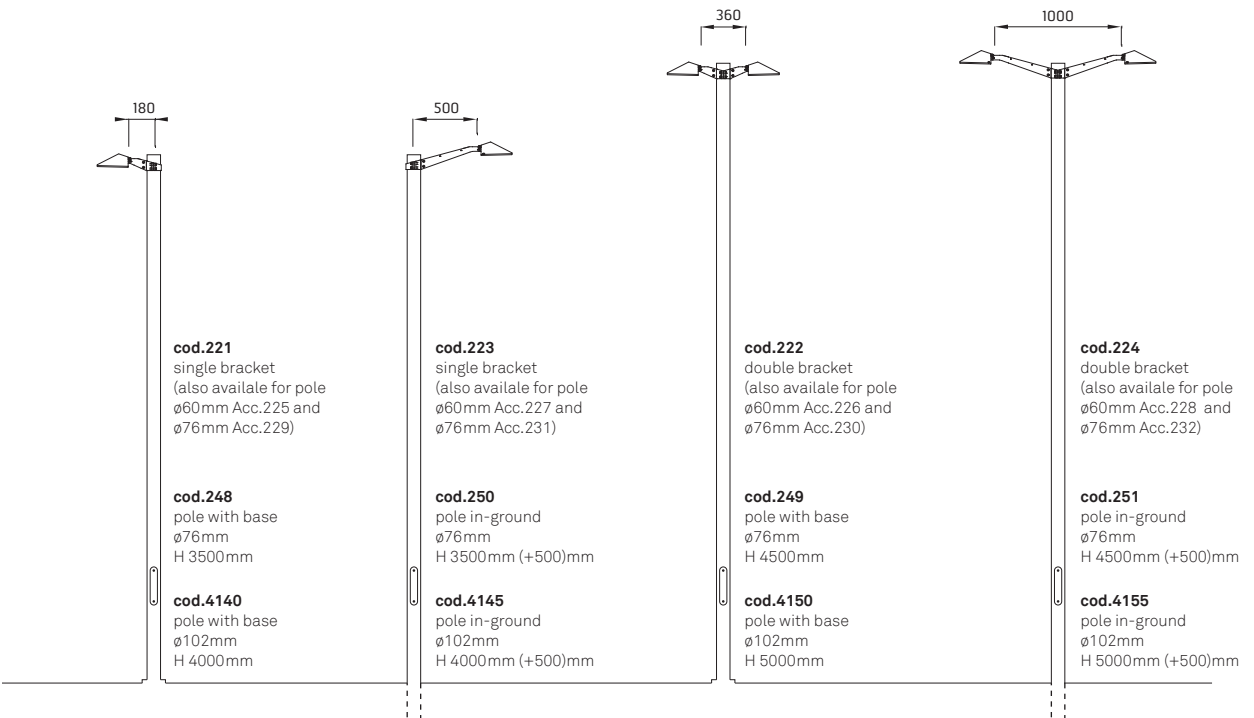

Accessories: MiniFranco

221
SINGLE BRACKET 180mm
FOR POLE Ø 102mm

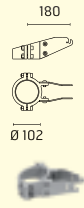

222
DOUBLE BRACKET 180mm
FOR POLE Ø 102mm

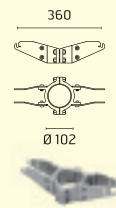

223
SINGLE BRACKET 500mm
FOR POLE Ø 102mm

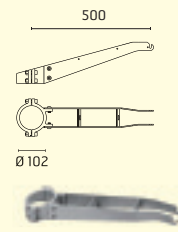

224
DOUBLE BRACKET 500mm
FOR POLE Ø 102mm

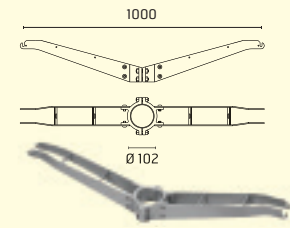

225
SINGLE BRACKET 180mm
FOR POLE Ø 60mm

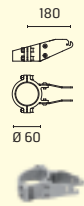

226
DOUBLE BRACKET 180mm
FOR POLE Ø 60mm

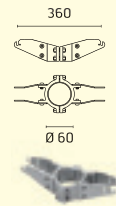

227
SINGLE BRACKET 500mm
FOR POLE Ø 60mm

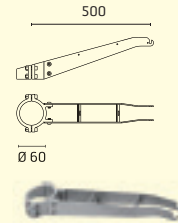

228
DOUBLE BRACKET 500mm
FOR POLE Ø 60mm

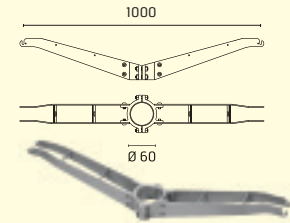

229
SINGLE BRACKET 180mm
FOR POLE Ø 76mm

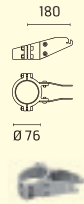

230
DOUBLE BRACKET 180mm
FOR POLE Ø 76mm

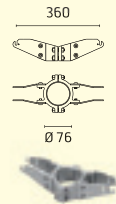

231
SINGLE BRACKET 500mm
FOR POLE Ø 76mm

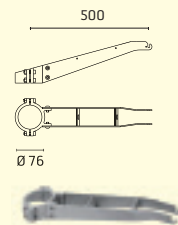

232
DOUBLE BRACKET 500mm
FOR POLE Ø 76mm

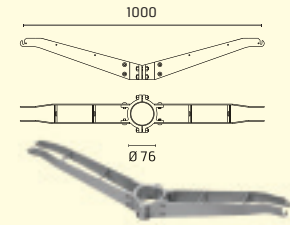

243
BASE PLATE AND FIXING BOLTS
Ø 119 x H 160mm

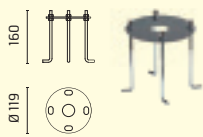

116
BASE PLATE AND FIXING BOLTS
230 x 230 x H 200mm

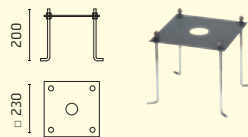

88
WALL BRACKET 620mm

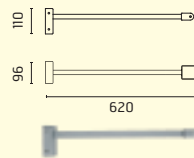

237
SPD: (SURGE PROTECTION DEVICE)
275Vac
MAXIMUM DISCHARGE CURRENT
10kA (8/20µs)
MAXIMUM OPERATING CURRENT 5A
SUITABLE FOR SERIES CONNECTION
- IP66

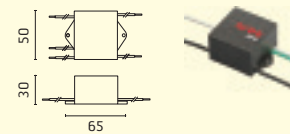

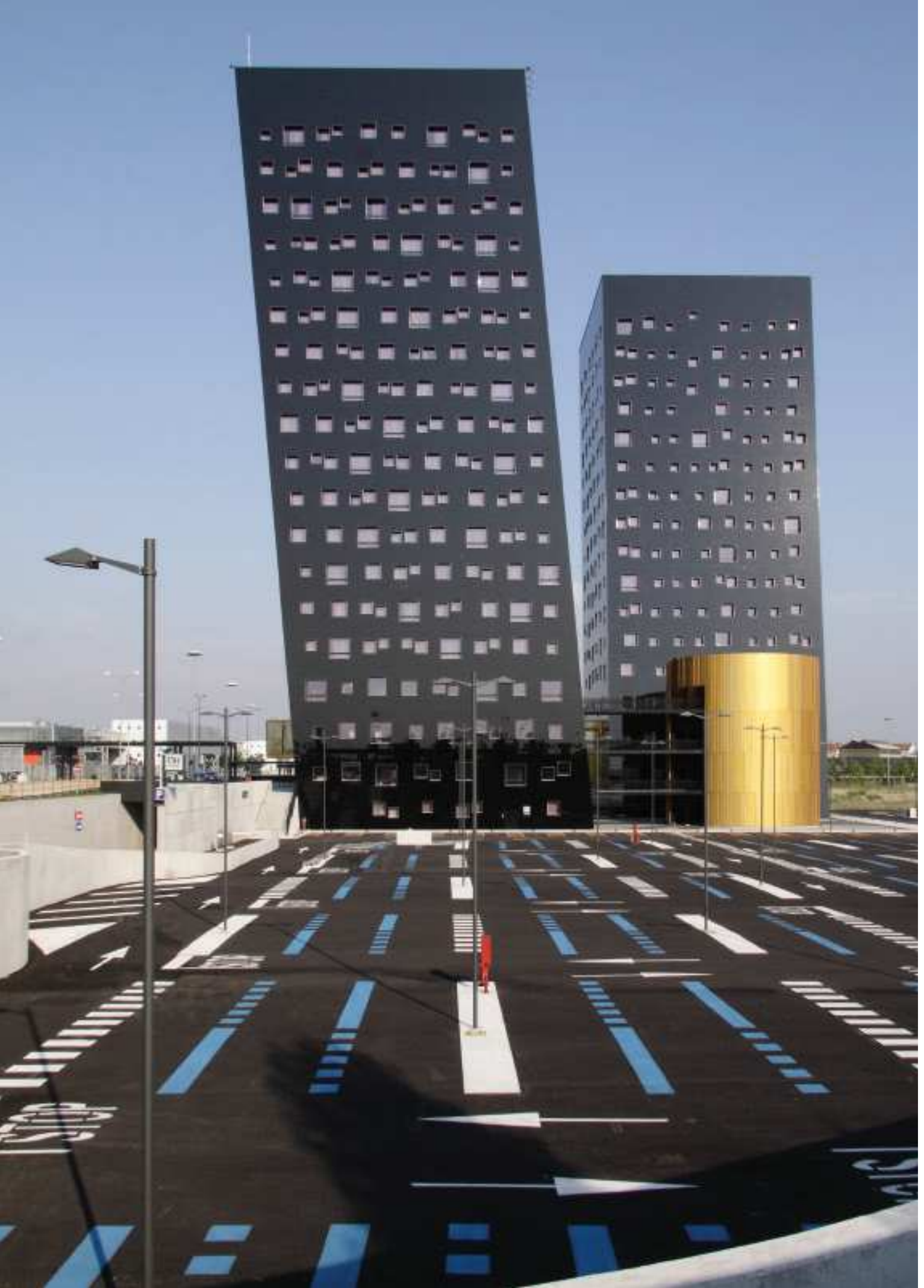

Accessories: MiniFranco

acc. code ▶	221	222	223	224	225	226	227	228	229	230	231	232	237	243	116	88
prod. code ▼																
117														•		
248															•	
249															•	
250																
251																
1005														•		
1009														•		
1105																
1109																
4140	•	•	•	•											•	
4145	•	•	•	•												
4150	•	•	•	•											•	
4155	•	•	•	•												
1610112	•	•	•	•	•	•	•	•	•	•	•	•	•			•
1610113	•	•	•	•	•	•	•	•	•	•	•	•	•			•
1610122	•	•	•	•	•	•	•	•	•	•	•	•	•			•
1610123	•	•	•	•	•	•	•	•	•	•	•	•	•			•
1622412	•	•	•	•	•	•	•	•	•	•	•	•	•			•
1622413	•	•	•	•	•	•	•	•	•	•	•	•	•			•
1628013	•	•	•	•	•	•	•	•	•	•	•	•	•			•
1628014	•	•	•	•	•	•	•	•	•	•	•	•	•			•
1628113	•	•	•	•	•	•	•	•	•	•	•	•	•			•
1628114	•	•	•	•	•	•	•	•	•	•	•	•	•			•
1628123	•	•	•	•	•	•	•	•	•	•	•	•	•			•
1628124	•	•	•	•	•	•	•	•	•	•	•	•	•			•



- Luminaire for installation on wall or on pole.
- Configuration: die-cast aluminium structure, EN AB-47100 alloy (low copper content) and pure aluminium reflector. Glass diffuser: extra-clear. Graduated stainless steel fixing plate for a precise adjustment.
- Double layer coating for high resistance to corrosion: the aluminium components are painted with a double coat using powders which are compliant with QUALICOAT standards: a first layer of epoxy powder (with excellent chemical and mechanical resistance) and a second finishing layer of polyester powder (resistant to UV rays and atmospheric agents). The entire painting process of the aluminium fitting starts from components which have been sand-blasted in advance to make the surface more porous and increase the adherence of the paint. Ares effects alkaline and acid washing to clean the surfaces completely, then rinses with demineralised water to remove any residue particles, subsequently a chemical conversion treatment is done to protect against rusting.
- Protection rating: IP65
- In compliance with EN60598-1 standards
- Class of insulation: I
- Installation: wiring through a M20x1,5 metal cable gland (7mmϕ13mm cables). Outdoor use requires suitable flexible cables assuring the watertightness of the cable gland.
- During the installation and the maintenance of the fixtures it is important to be careful and avoid damages on the paint coating. Damages on the coating exposed to outdoor conditions or water, could cause corrosion. Chemical substances affect the anticorrosion covering protection.

EU Regulation 874/2012 - Illumination equipment energy classes

-  **LED VERSION::**
Class A+/A++
Luminaire supplied with integrated LED modules that cannot be replaced
-  **METAL HALIDE VERSION:**
Class A+
HIT-DE/Rx7s
-  **SODIUM VAPOR VERSION:**
Class A+
HST-DE/Rx7s

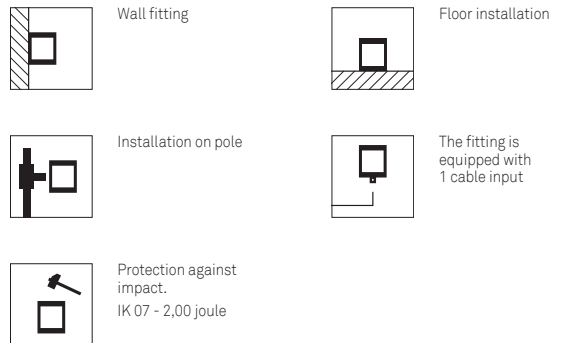

Franco - Adjustable - Symmetric Optic



962913
HIT-DE 70W RX7S

Optional bulb
HST-DE 70W Rx7s
Yellow light (2000K)

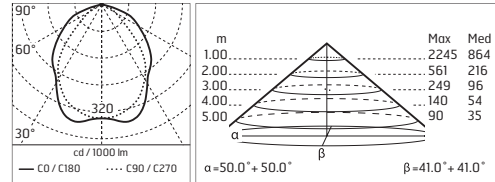
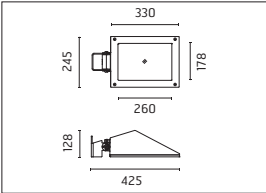

IP65

Franco - Adjustable - Asymmetric Optic



962914
HIT-DE 70W RX7S

Optional bulb
HST-DE 70W Rx7s
Yellow light (2000K)

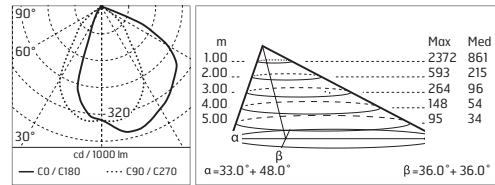
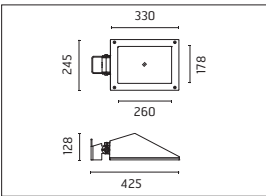

IP65

Franco - Adjustable - Symmetric Optic

Light Source: CoB LED / 39W / Total power 43W / CRI >80 / 220÷240V / Integral electronic power supply



9628323
White 2700K
lm LED 5043 \approx lm OUTPUT 3143

9628313
White 3000K
lm LED 5423 \approx lm OUTPUT 3380

9628213
White 4000K
lm LED 5560 \approx lm OUTPUT 3465

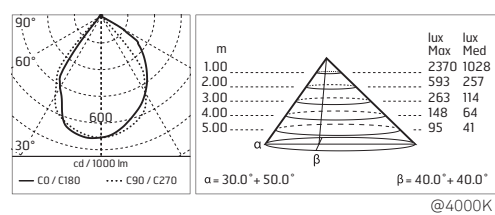
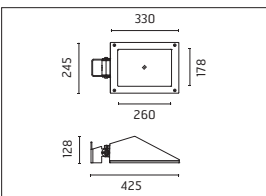

IP65

Franco - Adjustable - Asymmetric Optic

Light Source: CoB LED / 39W / Total power 43W / CRI >80 / 220÷240V / Integral electronic power supply



9628324
White 2700K
lm LED 5043 ≈ lm OUTPUT 2648



9628314
White 3000K
lm LED 5423 ≈ lm OUTPUT 2847



9628214
White 4000K
lm LED 5560 ≈ lm OUTPUT 2919

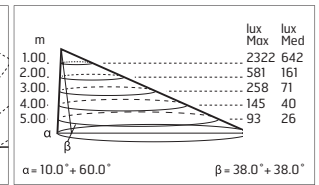
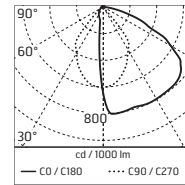
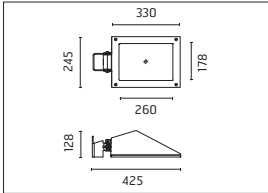

@4000K

IP65

Franco / Ø 76mm - Poles

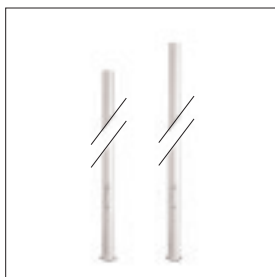

248
H 3500 mm

249
H 4500 mm

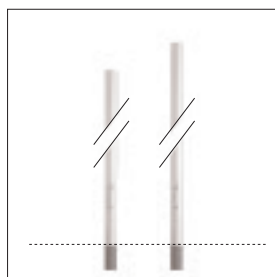

250
H 3500 mm (+500mm)

251
H 4500 mm (+500mm)

With Base and Access Door With Terminal Block 4x1,5-16mmq



.6 Grey .3 Anthracite

In-Ground (+500 mm Root) With Access Door With Terminal Block 4x1,5-16mmq



.6 Grey .3 Anthracite

Franco / Ø 102mm - Poles

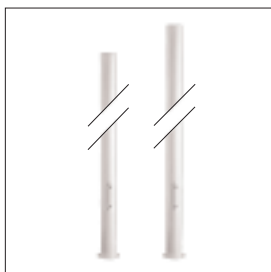

4140
H 4000 mm

4150
H 5000 mm

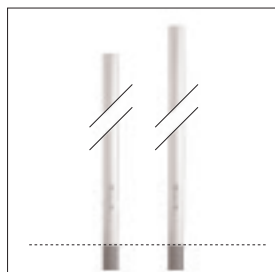

4145
H 4000 mm (+500mm)

4155
H 5000 mm (+500mm)

With Base and Access Door With Terminal Block 4x1,5-16mmq



.6 Grey .3 Anthracite

In-Ground (+500 mm Root) With Access Door With Terminal Block 4x1,5-16mmq



.6 Grey .3 Anthracite

Installation scheme: Franco

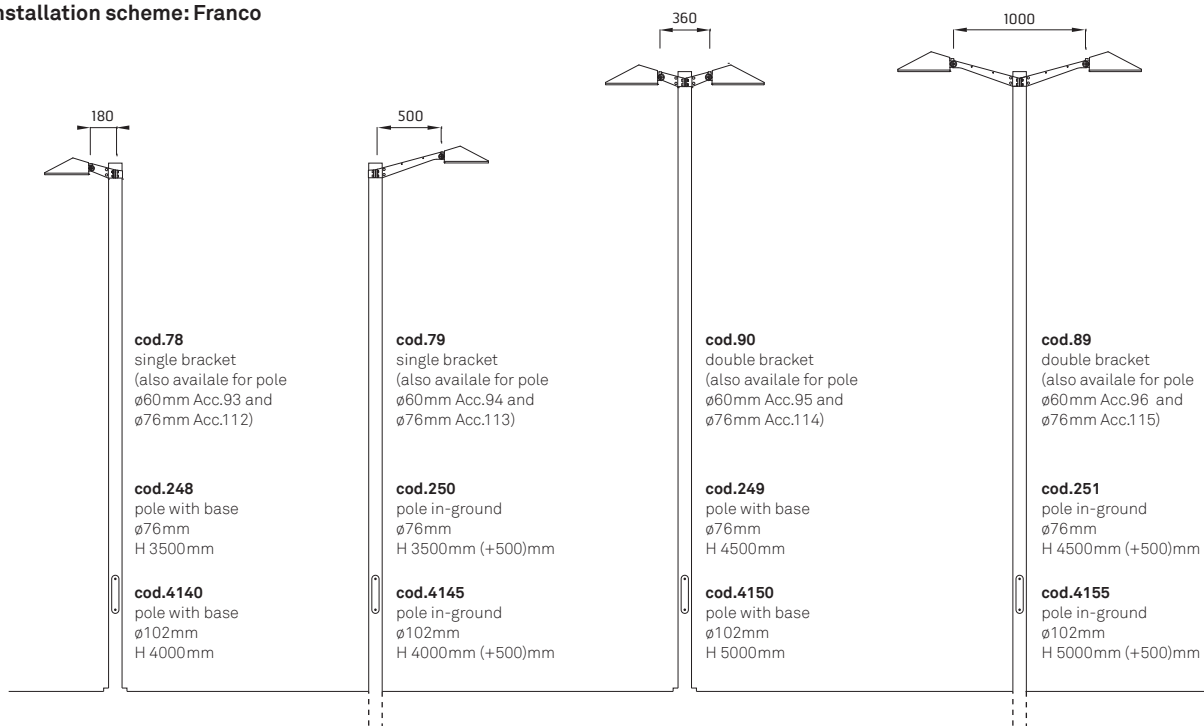

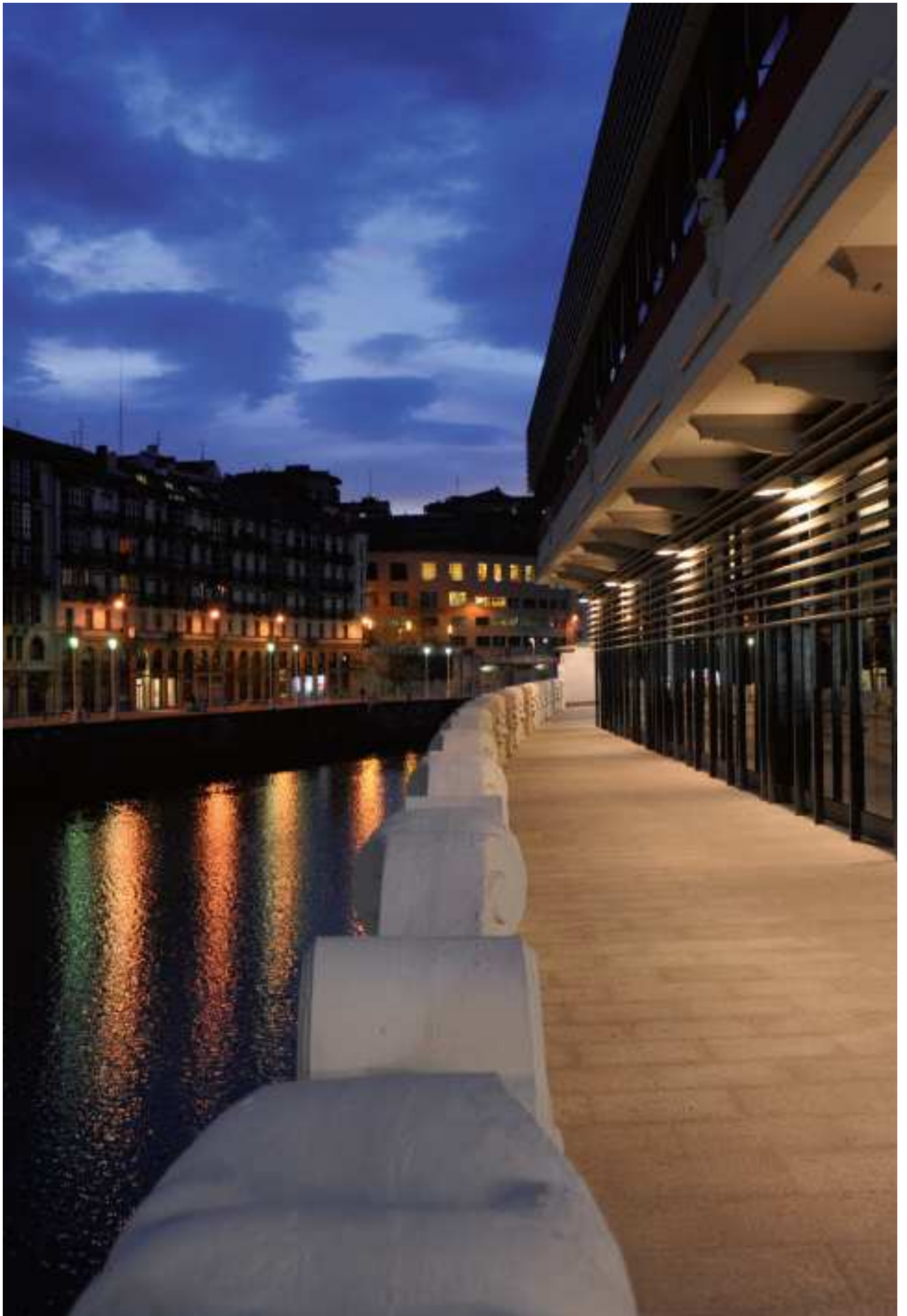

Accessories: Franco

78
SINGLE BRACKET 180mm
FOR POLE Ø 102mm

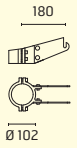

90
DOUBLE BRACKET 180mm
FOR POLE Ø 102mm

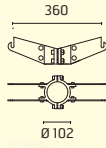

79
SINGLE BRACKET 500mm
FOR POLE Ø 102mm

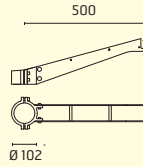

89
DOUBLE BRACKET 500mm
FOR POLE Ø 102mm

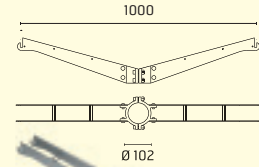

93
SINGLE BRACKET 180mm
FOR POLE Ø 60mm

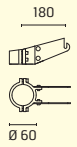

95
DOUBLE BRACKET 180mm
FOR POLE Ø 60mm

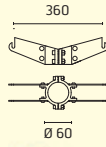

94
SINGLE BRACKET 500mm
FOR POLE Ø 60mm

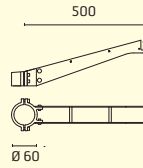

96
DOUBLE BRACKET 500mm
FOR POLE Ø 60mm

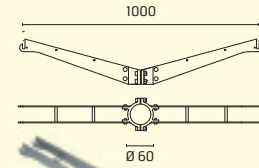

112
SINGLE BRACKET 180mm
FOR POLE Ø 76mm

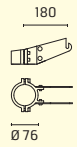

114
DOUBLE BRACKET 180mm
FOR POLE Ø 76mm

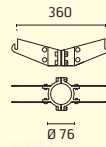

113
SINGLE BRACKET 500mm
FOR POLE Ø 76mm

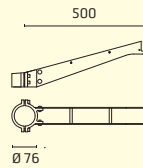

115
DOUBLE BRACKET 500mm
FOR POLE Ø 76mm

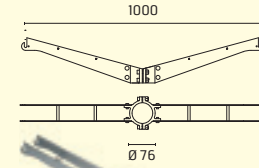

116
BASE PLATE AND FIXING BOLTS
230 x 230 x H 200mm

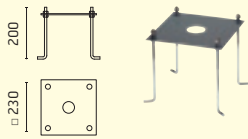

237
SPD: (SURGE PROTECTION DEVICE)
275Vac
MAXIMUM DISCHARGE CURRENT
10KA (8/20µs)
MAXIMUM OPERATING CURRENT
5A SUITABLE FOR SERIES CONNEC-
TION - IP66

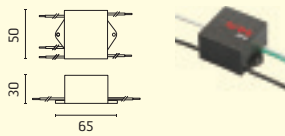



Accessories: Franco

acc. code ►	78	90	79	89	93	95	94	96	112	114	113	115	116	237
prod. code ▼														
248													•	
249													•	
250														
251														
4140	•	•	•	•									•	
4145	•	•	•	•										
4150	•	•	•	•									•	
4155	•	•	•	•										
962913	•	•	•	•	•	•	•	•	•	•	•	•		
962914	•	•	•	•	•	•	•	•	•	•	•	•		
9628213	•	•	•	•	•	•	•	•	•	•	•	•		•
9628214	•	•	•	•	•	•	•	•	•	•	•	•		•
9628313	•	•	•	•	•	•	•	•	•	•	•	•		•
9628314	•	•	•	•	•	•	•	•	•	•	•	•		•
9628323	•	•	•	•	•	•	•	•	•	•	•	•		•
9628324	•	•	•	•	•	•	•	•	•	•	•	•		•



- Luminaire for installation on wall or on pole.
- Configuration: die-cast aluminium structure, EN AB-47100 alloy (low copper content) and pure aluminium reflector. Glass diffuser: extra-clear. Graduated stainless steel fixing plate for a precise adjustment.
- Double layer coating for high resistance to corrosion: the aluminium components are painted with a double coat using powders which are compliant with QUALICOAT standards: a first layer of epoxy powder (with excellent chemical and mechanical resistance) and a second finishing layer of polyester powder (resistant to UV rays and atmospheric agents). The entire painting process of the aluminium fitting starts from components which have been sand-blasted in advance to make the surface more porous and increase the adherence of the paint. Ares effects alkaline and acid washing to clean the surfaces completely, then rinses with demineralised water to remove any residue particles, subsequently a chemical conversion treatment is done to protect against rusting.
- Protection rating: IP65
- In compliance with EN60598-1 standards
- Class of insulation: I
- Installation: wiring through a M20x1,5 metal cable gland (7mmϕ13mm cables). Outdoor use requires suitable flexible cables assuring the watertightness of the cable gland.
- During the installation and the maintenance of the fixtures it is important to be careful and avoid damages on the paint coating. Damages on the coating exposed to outdoor conditions or water, could cause corrosion. Chemical substances affect the anticorrosion covering protection.

EU Regulation 874/2012 - Illumination equipment energy classes

-  **LED VERSION::**
Class A/A+/A++
Luminaire supplied with integrated LED modules that cannot be replaced
-  **METAL HALIDE VERSION:**
Class A+
HIT-DE/Rx7s
HIT-CE/G12
-  **SODIUM VAPOR VERSION:**
Class A+
HST-DE/Rx7s

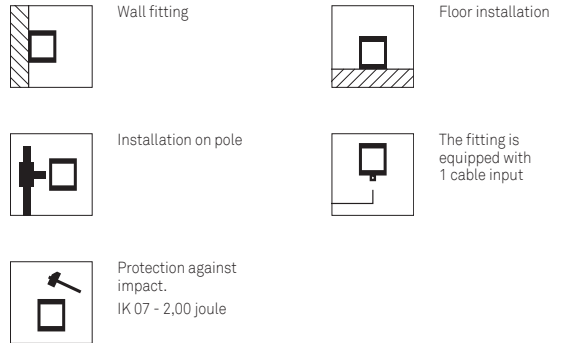

MaxiFranco - Adjustable - Symmetric Optic



971913
HIT-DE 150W RX7S

Optional bulb
HST-DE 150W Rx7s
Yellow light (2000K)

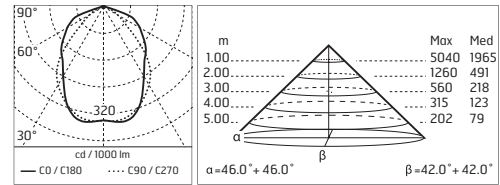
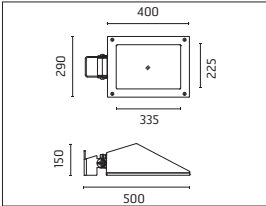

IP65

MaxiFranco - Adjustable - Asymmetric Optic



971914
HIT-DE 150W RX7S

Optional bulb
HST-DE 150W Rx7s
Yellow light (2000K)

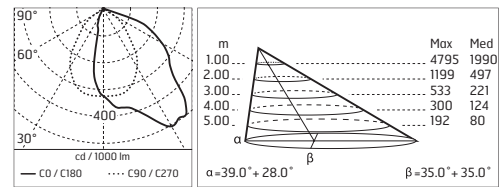
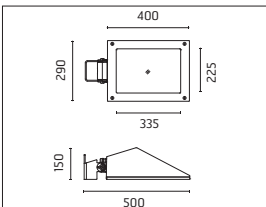

IP65

MaxiFranco - Adjustable - Symmetric Optic

Light Source: CoB LED / 45W / Total power 52W / CRI >80 / 220÷240V / Integral electronic power supply



9728423
White 2700K
lm LED 5847 ≠ lm OUTPUT 3757

9728513
White 3000K
lm LED 6287 ≠ lm OUTPUT 4040

9728413
White 4000K
lm LED 6446 ≠ lm OUTPUT 4142

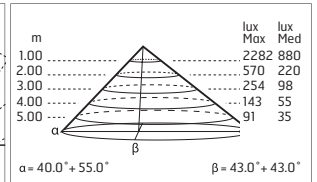
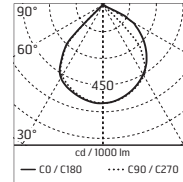
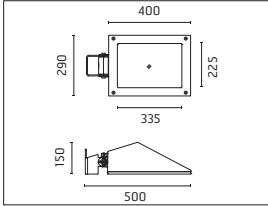

@4000K

IP65

MaxiFranco - Adjustable - Asymmetric Optic

Light Source: CoB LED / 45W / Total power 52W / CRI >80 / 220÷240V / Integral electronic power supply



9428424
White 2700K
lm LED 5847 ≠ lm OUTPUT 3072

9428514
White 3000K
lm LED 6287 ≠ lm OUTPUT 3303

9728414
White 4000K
lm LED 6446 ≠ lm OUTPUT 3386

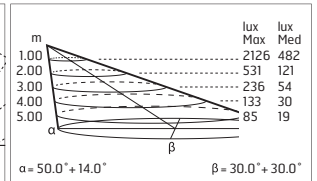
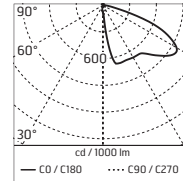
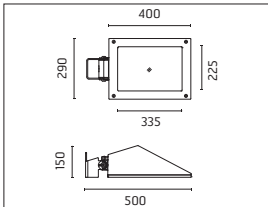

@4000K

IP65

MaxiFranco - Adjustable - Asymmetric Optic

Light Source: Power LED / 42W / Total power 47W / CRI >80 / 110÷240V / Integral electronic power supply



9724723
9724723-300 Dimmable Dali
9724723-310 Dimmable 1-10
White 2700K
lm LED 3582 ≠ lm OUTPUT 2057

9724813
9724813-300 Dimmable Dali
9724813-310 Dimmable 1-10
White 3000K
lm LED 3852 ≠ lm OUTPUT 2212

9724713
9724713-300 Dimmable Dali
9724713-310 Dimmable 1-10
White 4000K
lm LED 4104 ≠ lm OUTPUT 2448

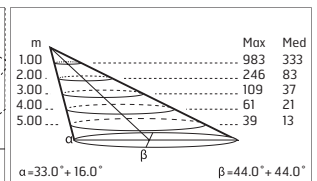
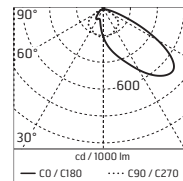
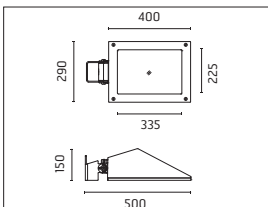

@4000K

IP65

MaxiFranco - Adjustable - Street light Optic



9771109
HIT-CE 70W G12

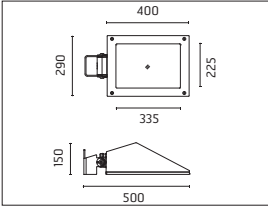

9715109
HIT-CE 150W G12

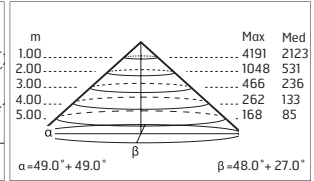
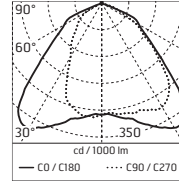
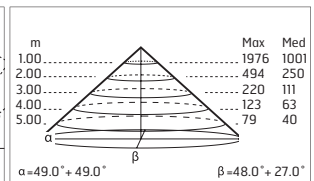
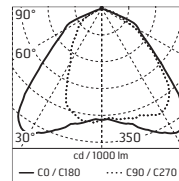

IP65

MaxiFranco - Adjustable - Street light Optic

Light Source: Power LED / 42W / Total power 47W/CRI >80 / 110÷240V / Integral electronic power supply



9724724
9724724-300 Dimmable Dali
9724724-310 Dimmable 1-10
White 2700K
lm LED 3582 ≠ lm OUTPUT 1712

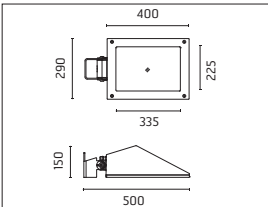

9724814
9724814-300 Dimmable Dali
9724814-310 Dimmable 1-10
White 3000K
lm LED 3852 ≠ lm OUTPUT 1841

9724714
9724714-300 Dimmable Dali
9724714-310 Dimmable 1-10
White 4000K
lm LED 4104 ≠ lm OUTPUT 2037

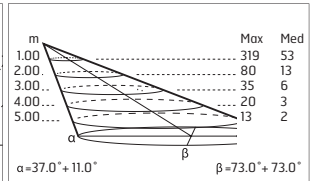
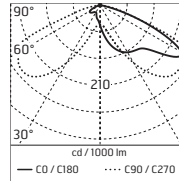

@4000K

IP65

MaxiFranco / Ø 76mm - Poles

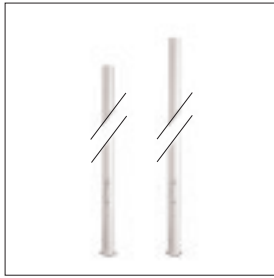

248
H 3500 mm

249
H 4500 mm

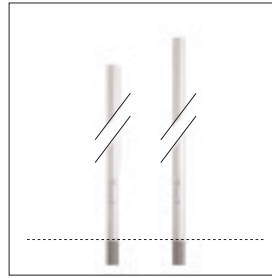

250
H 3500 mm (+500mm)

251
H 4500 mm (+500mm)

With Base and Access Door With Terminal Block 4x1,5-16mmq



.6 Grey .3 Anthracite

In-Ground (+500 mm Root) With Access Door With Terminal Block 4x1,5-16mmq



.6 Grey .3 Anthracite

MaxiFranco / Ø 102mm - Poles

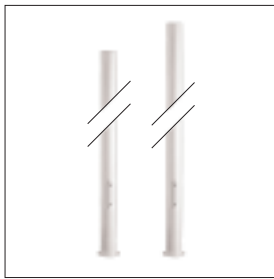

4140
H 4000 mm

4150
H 5000 mm

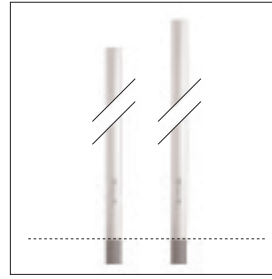

4145
H 4000 mm (+500mm)

4155
H 5000 mm (+500mm)

With Base and Access Door With Terminal Block 4x1,5-16mmq



.6 Grey .3 Anthracite

In-Ground (+500 mm Root) With Access Door With Terminal Block 4x1,5-16mmq



.6 Grey .3 Anthracite

Installation scheme: MaxiFranco

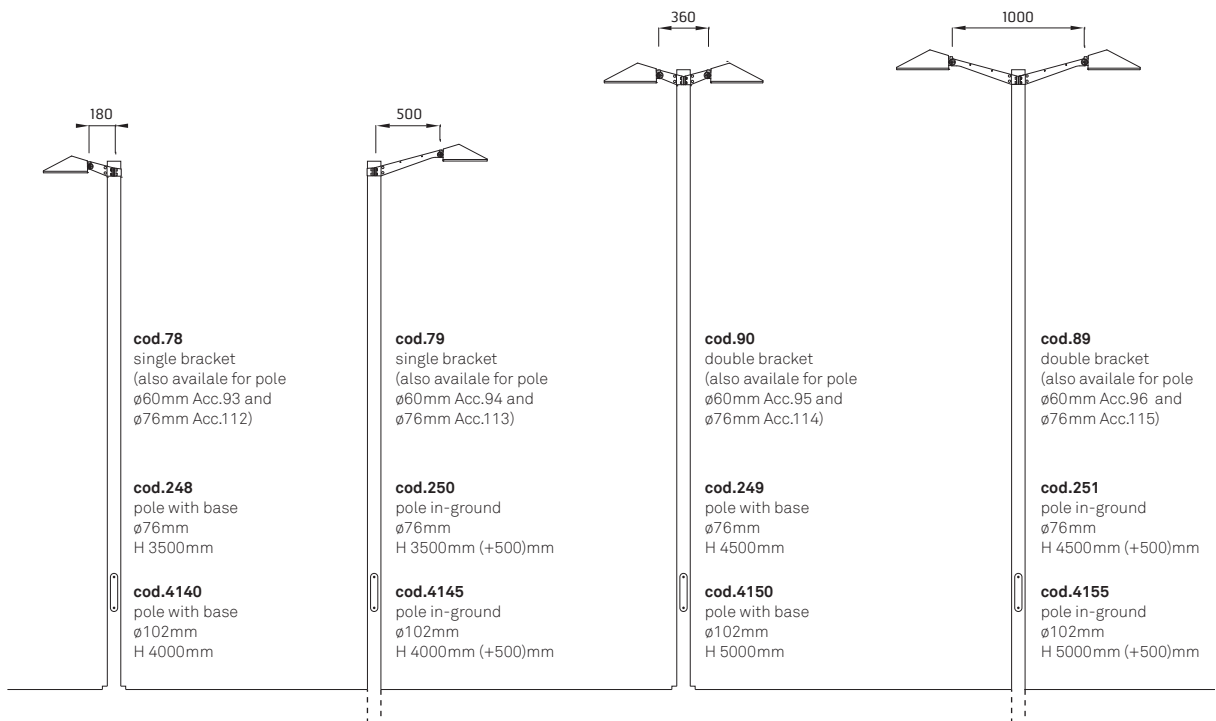

Accessories: MaxiFranco

78
SINGLE BRACKET 180mm
FOR POLE Ø 102mm

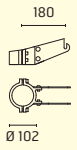

90
DOUBLE BRACKET 180mm
FOR POLE Ø 102mm

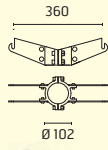

79
SINGLE BRACKET 500mm
FOR POLE Ø 102mm

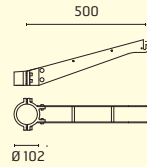

89
DOUBLE BRACKET 500mm
FOR POLE Ø 102mm

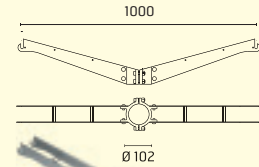

93
SINGLE BRACKET 180mm
FOR POLE Ø 60mm

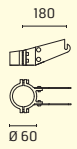

95
DOUBLE BRACKET 180mm
FOR POLE Ø 60mm

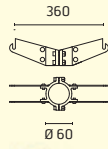

94
SINGLE BRACKET 500mm
FOR POLE Ø 60mm

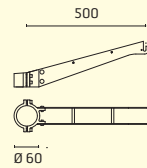

96
DOUBLE BRACKET 500mm
FOR POLE Ø 60mm

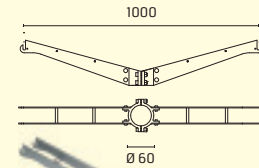

112
SINGLE BRACKET 180mm
FOR POLE Ø 76mm

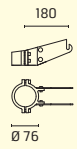

114
DOUBLE BRACKET 180mm
FOR POLE Ø 76mm

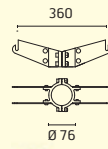

113
SINGLE BRACKET 500mm
FOR POLE Ø 76mm

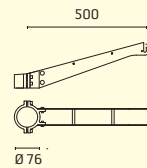

115
DOUBLE BRACKET 500mm
FOR POLE Ø 76mm

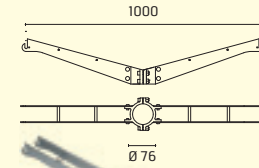

116
BASE PLATE AND FIXING BOLTS
230 x 230 x H 200mm

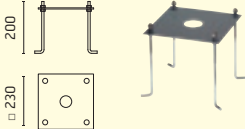

237
SPD: (SURGE PROTECTION DEVICE)
275Vac
MAXIMUM DISCHARGE CURRENT
10KA (8/20µs)
MAXIMUM OPERATING CURRENT 5A
SUITABLE FOR SERIES CONNECTION
- IP66

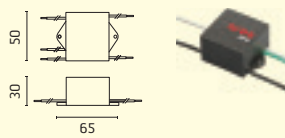

acc. code ▶	dimmi DALI	dimmi 1-10	78	90	79	89	93	95	94	96	112	114	113	115	116	237
248															•	
249															•	
250																
251																
4140			•	•	•	•									•	
4145			•	•	•	•										
4150			•	•	•	•									•	
4155			•	•	•	•										
971913			•	•	•	•	•	•	•	•	•	•	•	•		
971914			•	•	•	•	•	•	•	•	•	•	•	•		
9715109			•	•	•	•	•	•	•	•	•	•	•	•		
9724713	-300	-310	•	•	•	•	•	•	•	•	•	•	•	•		•
9724714	-300	-310	•	•	•	•	•	•	•	•	•	•	•	•		•
9724723	-300	-310	•	•	•	•	•	•	•	•	•	•	•	•		•
9724724	-300	-310	•	•	•	•	•	•	•	•	•	•	•	•		•
9724813	-300	-310	•	•	•	•	•	•	•	•	•	•	•	•		•
9724814	-300	-310	•	•	•	•	•	•	•	•	•	•	•	•		•
9728413			•	•	•	•	•	•	•	•	•	•	•	•		•
9728414			•	•	•	•	•	•	•	•	•	•	•	•		•
9728423			•	•	•	•	•	•	•	•	•	•	•	•		•
9728424			•	•	•	•	•	•	•	•	•	•	•	•		•
9728513			•	•	•	•	•	•	•	•	•	•	•	•		•
9728514			•	•	•	•	•	•	•	•	•	•	•	•		•
9771109			•	•	•	•	•	•	•	•	•	•	•	•		



- Pole top luminaire for installation on pole or wall (dedicated wall mounting bracket).
- Configuration: die-cast aluminium structure, EN AB-47100 alloy (low copper content), top cover in pre-galvanised sheet (lower side painted in white) secured to the housing by four extruded aluminium brackets. Acrylic diffuser: clear or opal, 3mm thick.
- Double layer coating for high resistance to corrosion: the aluminium components are painted with a double coat using powders which are compliant with QUALICOAT standards: a first layer of epoxy powder (with excellent chemical and mechanical resistance) and a second finishing layer of polyester powder (resistant to UV rays and atmospheric agents). The entire painting process of the aluminium fitting starts from components which have been sand-blasted in advance to make the surface more porous and increase the adherence of the paint. Ares effects alkaline and acid washing to clean the surfaces completely, then rinses with demineralised water to remove any residue particles, subsequently a chemical conversion treatment is done to protect against rusting.
- Protection rating: IP65
- In compliance with EN60598-1 standards
- Class of insulation: I; LED module: II
- Installation: the fixture is equipped with 1000mm cable. Re-lamping through the removal of a disc fitted on the top cover.
- We recommend the use of a connection system with a protection degree greater than or equal to the protection degree of the luminaire.
- During the installation and the maintenance of the fixtures it is important to be careful and avoid damages on the paint coating. Damages on the coating exposed to outdoor conditions or water, could cause corrosion. Chemical substances affect the anticorrosion covering protection.

EU Regulation 874/2012 - Illumination equipment energy classes



LED VERSION::
Class A / A+ / A++
Luminaire supplied with integrated LED modules that cannot be replaced



.6 Grey



.3 Anthracite



Pole top luminaire



Pre-wired with approx 1000mm of cable



Protection against impact.
IK 07 - 2,00 joule

Andrea - Pole Ø 60mm - Opal (inside) Acrylic Diffuser

Light Source: Power LED / 44W / Total power 49W / CRI>80 / 220÷240V / Integral electronic power supply



121265112
White 3000K
lm LED 4013 ≠ lm OUTPUT 3375

121264112
White 4000K
lm LED 4275 ≠ lm OUTPUT 3596

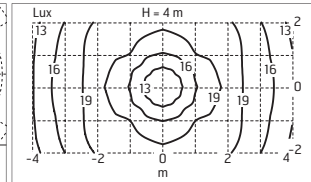
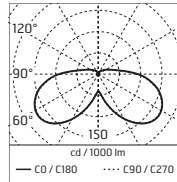

@4000K

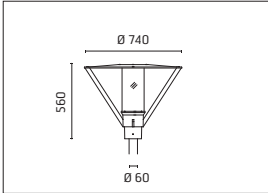

Dimmable on request

2700K on request

IP65

Andrea - Pole Ø 102mm - Opal (inside) Acrylic Diffuser

Light Source: Power LED / 44W / Total power 49W / CRI>80 / 220÷240V / Integral electronic power supply



121265114
White 3000K
lm LED 4013 ≠ lm OUTPUT 3375

121264114
White 4000K
lm LED 4275 ≠ lm OUTPUT 3596

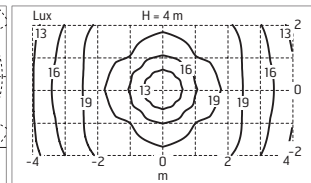
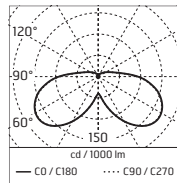

@4000K

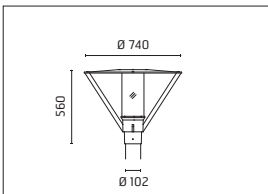

Dimmable on request

2700K on request

IP65

Andrea / Ø 102mm - Poles

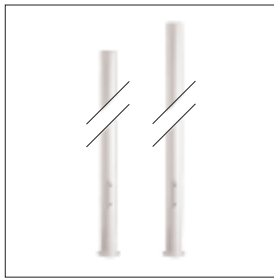

4140
H 4000 mm

4150
H 5000 mm

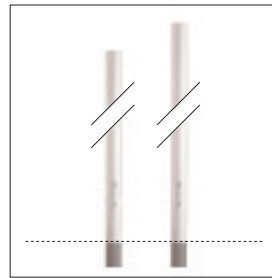

4145
H 4000 mm (+500mm)

4155
H 5000 mm (+500mm)

**With Base and Access Door
With Terminal Block 4x1,5-16mmq**



.6 Grey

.3 Anthracite

**In-Ground (+500 mm Root) With Access Door
With Terminal Block 4x1,5-16mmq**



.6 Grey

.3 Anthracite

Andrea Wall Version



CODE 125
Wall Bracket



.6 Grey

.3 Anthracite





Accessories: Andrea

116
BASE PLATE AND FIXING BOLTS
230 x 230 x H 200mm

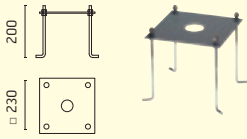

236
2 WAY TERMINAL BLOCK 4 POLES
IP68 H₂O STOP (Ø5,5±12mm CABLE)

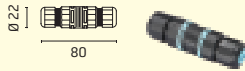

acc. code ▶	116	236	125	237
prod. code ▼				
4140	•			
4145				
4150	•			
4155				
121264112		•	•	•
121264114		•	•	•
121265112		•	•	•
121265114		•	•	•

237
SPD: (SURGE PROTECTION DEVICE)
275Vac
MAXIMUM DISCHARGE CURRENT
10KA (8 / 20µs)
MAXIMUM OPERATING CURRENT
5A SUITABLE FOR SERIES CONNEC-
TION - IP66

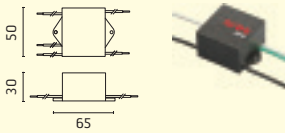

125
WALL BRACKET FOR Ø 60mm HEAD

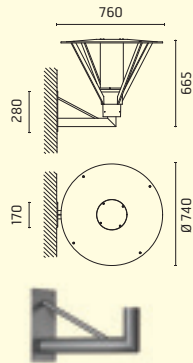

Correct Fixing Method
Bollard fixed on plinth +
suitable installation screws

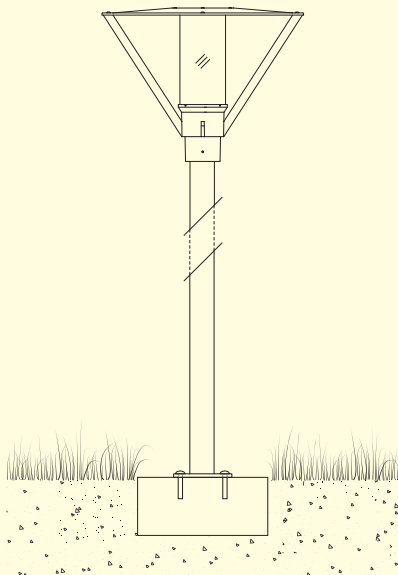

Correct Fixing Method
Bollard fixed on plinth + fixing bolts

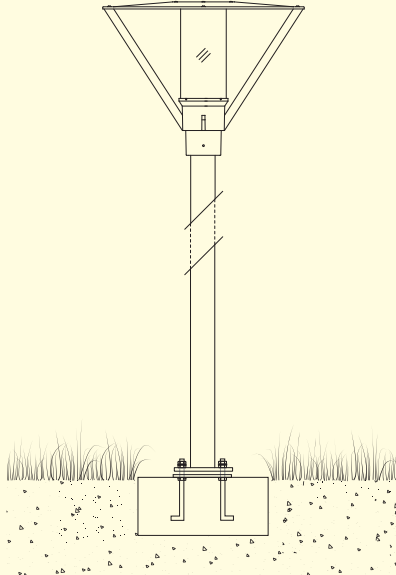

Incorrect Fixing Method
Do not fix the bollard directly on the ground

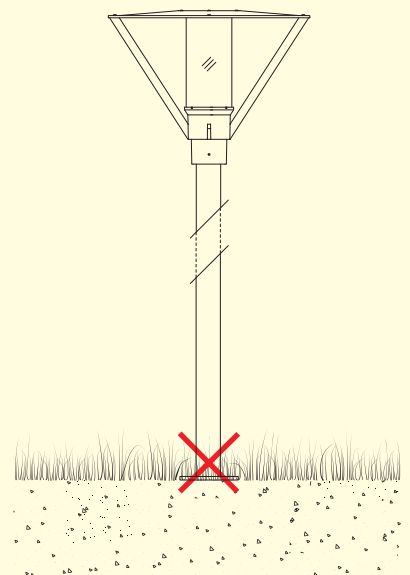



MARTINA

- Adjustable spotlight.
- Configuration: turned and anodized (raw or painted) aluminium structure with stainless steel adjustable bracket. Glass diffuser: transparent or sandblasted with silkscreen border, fixed through a robotic gluing system.
- Double layer coating for high resistance to corrosion: the aluminium components are painted with a double coat using powders which are compliant with QUALICOAT standards: a first layer of epoxy powder (with excellent chemical and mechanical resistance) and a second finishing layer of polyester powder (resistant to UV rays and atmospheric agents). The entire painting process of the aluminium fitting starts from components which have been sand-blasted in advance to make the surface more porous and increase the adherence of the paint. Ares effects alkaline and acid washing to clean the surfaces completely, then rinses with demineralised water to remove any residue particles, subsequently a chemical conversion treatment is done to protect against rusting.
- Protection rating: IP67
- In compliance with EN60598-1 standards
- Class of insulation: III
- Installation: the luminaire is equipped with 2000mm cable. Martina 24V and Maxi Martina 24V are equipped with a dc/dc highly efficient resin-coated converter that removes electromagnetic interference and protects against polarity reversal and sudden voltage peak. Parallel wiring required. Mini Martina, Martina RGB and Maxi Martina RGB requires connection in series.
- We recommend the use of a connection system with a protection degree greater than or equal to the protection degree of the luminaire.
- During the installation and the maintenance of the fixtures it is important to be careful and avoid damages on the paint coating. Damages on the coating exposed to outdoor conditions or water, could cause corrosion. Chemical substances affect the anticorrosion covering protection.

EU Regulation 874/2012 - Illumination equipment energy classes

A++
A+
A

LED VERSION:
Class A/A+/A++
Luminaire supplied with integrated LED modules that cannot be replaced

 MiniMartina, Martina and MaxiMartina

.8 Anodized Aluminium

 .1 White







 .6 Grey

 .3 Anthracite

 .4 Black

 .18 Deep Brown

Martina and MaxiMartina ONLY

	Ceiling lamp		Wall lamp
	Floor installation		Pre-wired with approx 2000mm of cable
	Remote device required		Protection against impact. IK 05 - 0,70 joule MiniMartina IK 07 - 2,00 joule Martina/MaxiMartina

MiniMartina - Transparent Glass - Adjustable - 10°

Light Source: Power LED / 1,1÷1,6W / Total power 1,1W@350mA - 1,6W@500mA / CRI>80 / 350÷500mA



10514422
White 2700K
lm LED 112@350mA = lm OUTPUT 100@350mA
lm LED 167@500mA = lm OUTPUT 118@500mA

Acc. 129, 135, 184, 218, 238 or 239

10514412
White 3000K
lm LED 120@350mA = lm OUTPUT 108@350mA
lm LED 180@500mA = lm OUTPUT 127@500mA

Acc. 129, 135, 184, 218, 238 or 239

10517112
White 4000K
lm LED 130@350mA = lm OUTPUT 117@350mA
lm LED 195@500mA = lm OUTPUT 137@500mA

Acc. 129, 135, 184, 218, 238 or 239

Remote electronic power supply to be ordered

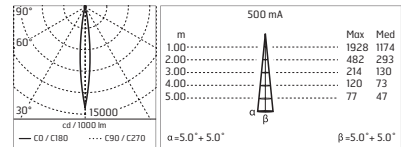

@3000K

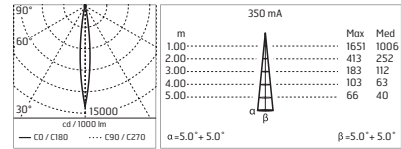

@4000K

IP67 CE

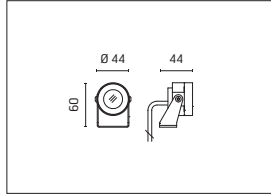

MiniMartina - Transparent Glass - Adjustable - 30°

Light Source: Power LED / 1,1÷1,6W / Total power 1,1W@350mA - 1,6W@500mA / CRI>80 / 350÷500mA



10514420
White 2700K
lm LED 112@350mA = lm OUTPUT 94@350mA
lm LED 167@500mA = lm OUTPUT 111@500mA

Acc. 129, 135, 184, 218, 238 or 239

10514400
White 3000K
lm LED 120@350mA = lm OUTPUT 101@350mA
lm LED 180@500mA = lm OUTPUT 119@500mA

Acc. 129, 135, 184, 218, 238 or 239

10517100
White 4000K
lm LED 130@350mA = lm OUTPUT 110@350mA
lm LED 195@500mA = lm OUTPUT 129@500mA

Acc. 129, 135, 184, 218, 238 or 239

Remote electronic power supply to be ordered

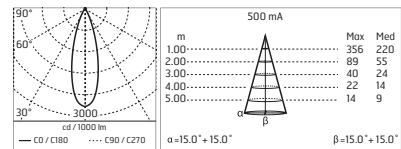

@3000K

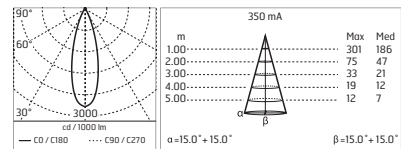

@4000K

IP67 CE

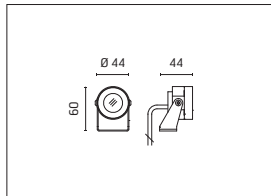

MiniMartina - Sandblasted Glass - Adjustable

Light Source: RGB Power LED / 3,4W / Total power 3,4W / 3CHx350mA / Remote electronic power supply to be ordered



10517300

Wiring diagram and installation scheme RGB

Max 10 luminaires MINIMARTINA RGB for each code 141

>> See Page 560
Wiring Diagram n.5

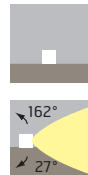
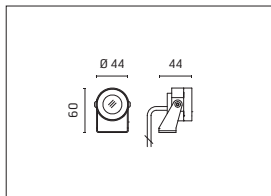

IP67 CE

Martina - Transparent Glass - Adjustable - 10°

Light Source: Power LED / Remote electronic power supply to be ordered / CRI>80



3,3W/24Vdc / Total power 4,5W

1055622

White 2700K
lm LED 299 ≈ lm OUTPUT 268

1055612

White 3000K
lm LED 321 ≈ lm OUTPUT 288

10517212

White 4000K
lm LED 342 ≈ lm OUTPUT 306

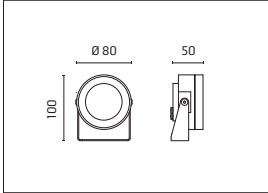

3,3÷4,8W / Total power 3,3W@350mA - 5,1W@500mA / 350÷500mA

10510722

White 2700K
lm LED 299@350mA ≈ lm OUTPUT 268@350mA
lm LED 388@500mA ≈ lm OUTPUT 299@500mA

Acc. 129, 135, 184, 218, 238 or 239

10510712

White 3000K
lm LED 321@350mA ≈ lm OUTPUT 288@350mA
lm LED 417@500mA ≈ lm OUTPUT 322@500mA

Acc. 129, 135, 184, 218, 238 or 239

10519012

White 4000K
lm LED 342@350mA ≈ lm OUTPUT 307@350mA
lm LED 444@500mA ≈ lm OUTPUT 353@500mA

Acc. 129, 135, 184, 218, 238 or 239

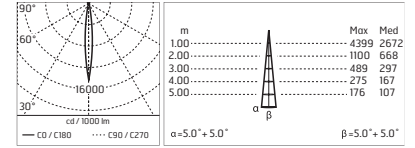

@4000K

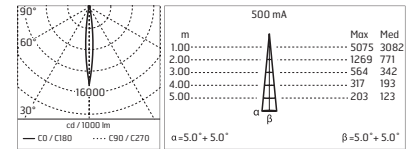

@4000K

IP67

Martina - Transparent Glass - Adjustable - 10°

Light Source: RGB Power LED / 3,4W / Total power 3,4W / 3CHx350mA / Remote electronic power supply to be ordered



10517412

Wiring diagram and installation scheme RGB

Max 10 luminaires MARTINA RGB
for each code 141

>> See Page 560
Wiring Diagram n.5

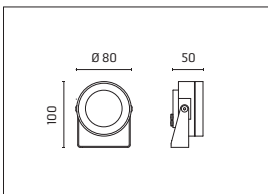

IP67

Martina - Transparent Glass - Adjustable - 35°

Light Source: RGB Power LED / 3,4W / Total power 3,4W / 3CHx350mA / Remote electronic power supply to be ordered



10517400

Wiring diagram and installation scheme RGB

Max 10 luminaires MARTINA RGB
for each code 141

>> See Page 560
Wiring Diagram n.5

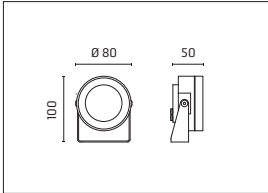

IP67

Martina - Transparent Glass - Adjustable - 50°

Light Source: Power LED / CRI>80 / Remote electronic power supply to be ordered



3,3W / Total power 4,5W / 24Vdc

1055620

White 2700K
lm LED 299 ≠ lm OUTPUT 212

1055600

White 3000K
lm LED 321 ≠ lm OUTPUT 228

10517200

White 4000K
lm LED 342 ≠ lm OUTPUT 243

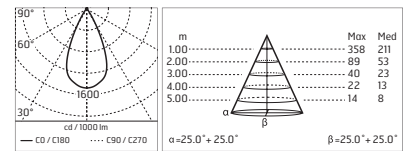

@4000K

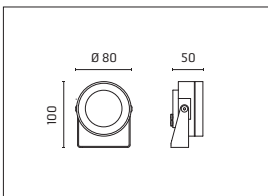

3,3÷4,8W / Total power 3,3W@350mA - 5,1W@500mA / 350÷500mA

10510720

White 2700K
lm LED 299@350mA ≠ lm OUTPUT 212@350mA
lm LED 388@500mA ≠ lm OUTPUT 276@500mA

Acc. 129, 135, 184, 218, 238 or 239

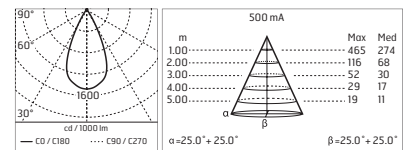

@4000K

10510700

White 3000K
lm LED 321@350mA ≠ lm OUTPUT 228@350mA
lm LED 417@500mA ≠ lm OUTPUT 297@500mA

Acc. 129, 135, 184, 218, 238 or 239

10519000

White 4000K
lm LED 342@350mA ≠ lm OUTPUT 243@350mA
lm LED 444@500mA ≠ lm OUTPUT 316@500mA

Acc. 129, 135, 184, 218, 238 or 239

IP67

MaxiMartina - Transparent Glass - Adjustable - 10°

Light Source: Power LED / 9,6W / Total power 11,8W / CRI>80 / 24Vdc / Remote electronic power supply to be ordered



10525522
White 2700K
lm LED 776 ≠ lm OUTPUT 498

10525512
White 3000K
lm LED 834 ≠ lm OUTPUT 535

10525412
White 4000K
lm LED 889 ≠ lm OUTPUT 570

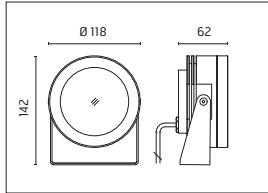
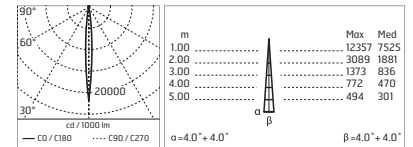

Dimmable on request

IP67

@4000K

MaxiMartina - Transparent Glass - Adjustable - 10°

Light Source: Power LED / 14,4W / Total power 17W / CRI>80 / 24Vdc



10525222
White 2700K
lm LED 1164 ≠ lm OUTPUT 747

10525212
White 3000K
lm LED 1252 ≠ lm OUTPUT 803

10525112
White 4000K
lm LED 1333 ≠ lm OUTPUT 855

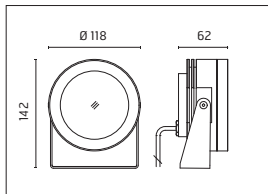
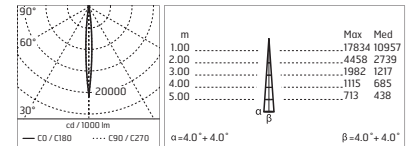

Dimmable on request

IP67

@4000K

MaxiMartina - Transparent Glass - Adjustable - 10°

Light Source: RGB Power LED / 13,6W / Total power 13,6W / 3CHx350mA / Remote electronic power supply to be ordered



10525612

Wiring diagram and installation scheme RGB
Max 2 luminaires MAXIMARTINA RGB
for each code 141

>> See Page 560
Wiring Diagram n.5

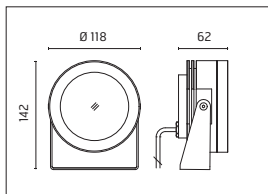

IP67

MaxiMartina - Transparent Glass - Adjustable - 30°

Light Source: Power LED / 9,6W / Total power 11,8W / CRI>80 / 24Vdc / Remote electronic power supply to be ordered



10525520
White 2700K
lm LED 776 ≈ lm OUTPUT 486

10525500
White 3000K
lm LED 834 ≈ lm OUTPUT 523

10525400
White 4000K
lm LED 889 ≈ lm OUTPUT 558

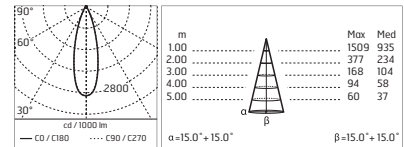

@4000K

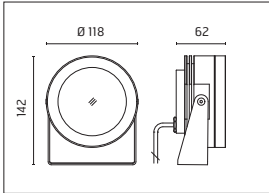

Dimmable on request

IP67

MaxiMartina - Transparent Glass - Adjustable - 30°

Light Source: Power LED / 14,4W / Total power 17W / CRI>80/ 24Vdc / Remote electronic power supply to be ordered



10525220
White 2700K
lm LED 1164 ≈ lm OUTPUT 730

10525200
White 3000K
lm LED 1252 ≈ lm OUTPUT 785

10525100
White 4000K
lm LED 1333 ≈ lm OUTPUT 836

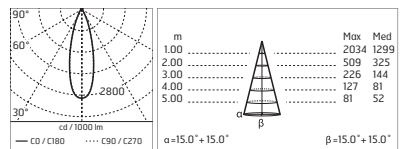

@4000K

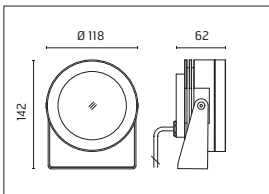

Dimmable on request

IP67

MaxiMartina - Transparent Glass - Adjustable - 35°

Light Source: RGB Power LED / 13,6W / Total power 13,6W / 3CHx350mA / Remote electronic power supply to be ordered



10525600

Wiring diagram and installation scheme RGB

Max 2 luminaires MAXIMARTINA RGB for each code 141

>> See Page 560
Wiring Diagram n.5

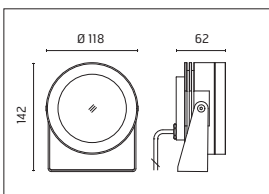

IP67



Accessories: Martina

52
VISOR MINIMARTINA

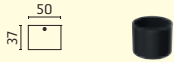

51
VISOR MARTINA

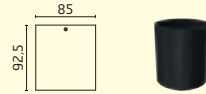

136
GROUND SPIKE - H 200mm

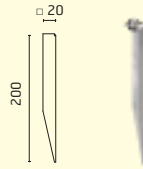

215
3/4 WAY TERMINAL BLOCK 4 POLES
IP68 H₂O STOP (Ø5,5÷12mm CABLE)

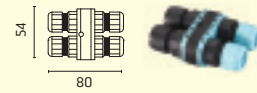

236
2 WAY TERMINAL BLOCK 4 POLES
IP68 H₂O STOP (Ø5,5÷12mm CABLE)



150
POWER SUPPLY DUAL FUNCTION
Vout 24Vdc: 8W/100÷240V
Iout 350mA: 6x1W/100÷240V
IP20 CLASS II SELV EQ.

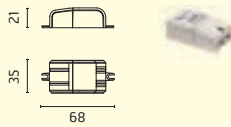

106
POWER SUPPLY DUAL FUNCTION
Vout 24Vdc: 8W/100÷240V
Iout 350mA: 6x1W/100÷240V
IP65 CLASS II SELV EQ.

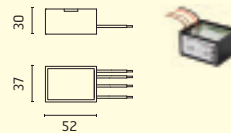

68
POWER SUPPLY 10x1W/100÷265V -
Iout 350mA (7x1W@110V) IP40
CLASS II SELV EQ.

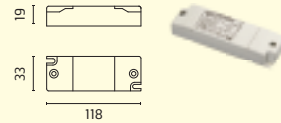

129
POWER SUPPLY 16x1W/110÷240V -
Iout 350mA (12x1W@110V)
IP20 CLASS II SELV EQ.

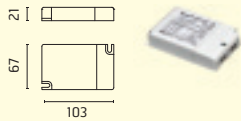

184
POWER SUPPLY 16x1W/110÷240V -
Iout 350mA (12x1W@110V)
IP67 CLASS II SELV.

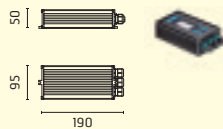

135
POWER SUPPLY 13x2W/110÷240V -
Iout 500mA (7x2W@110V)
IP20 CLASS II SELV EQ.

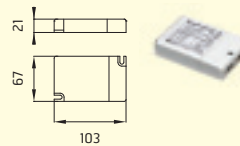

218
POWER SUPPLY 13x2W/110÷240V -
Iout 500mA (7x2W@110V)
IP67 CLASS II SELV.

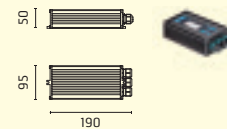

...||| DIMMABLE: PUSH-DIM OR 1...10V
See Page 558 Wiring Diagram n.3

...||| DIMMABLE: PUSH-DIM OR 1...10V
See Page 558 Wiring Diagram n.3

...||| DIMMABLE: PUSH-DIM OR 1...10V
See Page 558 Wiring Diagram n.3

DIMMABLE: PUSH-DIM OR 1...10V
See Page 558 Wiring Diagram n.3

238
POWER SUPPLY 18W/110-240V -
Iout 350mA (15W@110V)
IP67 CLASS II SELV.

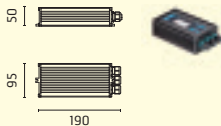

239
POWER SUPPLY 25W/110-240V -
Iout 500mA (15W@110V)
IP67 CLASS II SELV.

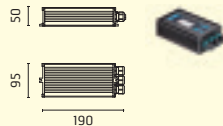

87
POWER SUPPLY 10W/110÷240V -
24Vdc IP20 CLASS II SELV.

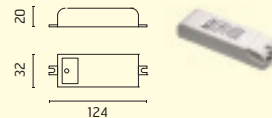

110
POWER SUPPLY 70W/220÷240V -
24Vdc IP67 CLASS II SELV EQ.

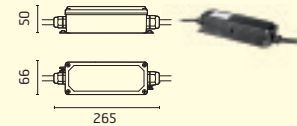

...||| DIMMABLE: PUSH-DIM OR 1...10V
See Page 558 Wiring Diagram n.3

...||| DIMMABLE: DALI
See Page 558 Wiring Diagram n.3

175
POWER SUPPLY 10W/110÷240V -
24Vdc IP67 CLASS II SELV.

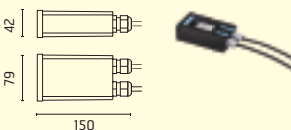

147
POWER SUPPLY 20W/220÷240V -
24Vdc IP67 CLASS II SELV.

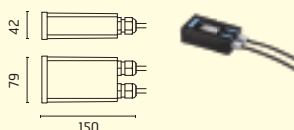

155
POWER SUPPLY 50W/120÷240V -
24Vdc IP67 CLASS II SELV.

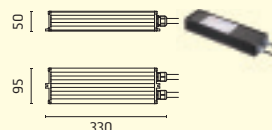

Accessories: Martina

141
POWER SUPPLY WITH DMX
INTERFACE FOR RGB FIXTURES
36W/220÷240V-3CHx350mA
(3CHx10x1W) DMX CONTROL ALLOWED
IP67 CLASS I SELV EQ.

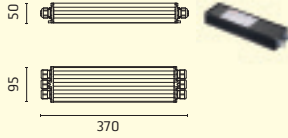

142
DMX CONTROLLER;
DIMMER SWITCH FOR RECESSED BOX
(60mm HOLE CENTRES)



143
DMX CONTROLLER;
STAND-ALONE/PC INTERFACE

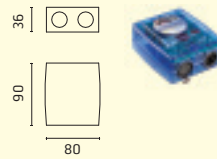

187
DMX SPLITTER 512 - ELECTRONIC
DEVICE TO REGENERATE THE MONODI-
RECTIONAL DMX SIGNAL
1 INPUT AND 7 OUTPUT, 12-24Vdc

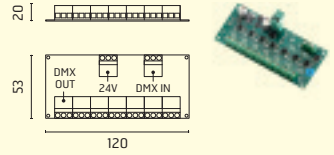

186
DMX CABLE - SHIELDED TWISTED PAIR
WITH 110 Ohm CONSTANT IMPEDANCE.



POWER SUPPLY TO BE ORDERED (87 OR 175 RECOMMENDED)

acc. code ▶	51	52	136	215	236	150	106	68	129	184	135	218	238	239	87	175	147	155	110	141	142	143	187	186
prod. code ▼	51	52	136	215	236	150	106	68	129	184	135	218	238	239	87	175	147	155	110	141	142	143	187	186
1055600	•		•	•	•	1	1								2	2	3	7	14					
1055612	•		•	•	•	1	1								2	2	3	7	14					
1055620	•		•	•	•	1	1								2	2	3	7	14					
1055622	•		•	•	•	1	1								2	2	3	7	14					
10510700	•		•		•	2	2	3	5*	5*	2*	2*	3*	3*										
10510712	•		•		•	2	2	3	5*	5*	2*	2*	3*	3*										
10510720	•		•		•	2	2	3	5*	5*	2*	2*	3*	3*										
10510722	•		•		•	2	2	3	5*	5*	2*	2*	3*	3*										
10514400		•	•			6	6	10	16*	16*	12*	12*	9*	9*										
10514412		•	•			6	6	10	16*	16*	12*	12*	9*	9*										
10514420		•	•			6	6	10	16*	16*	12*	12*	9*	9*										
10514422		•	•			6	6	10	16*	16*	12*	12*	9*	9*										
10517100		•	•			6	6	10	16*	16*	12*	12*	9*	9*										
10517112		•	•			6	6	10	16*	16*	12*	12*	9*	9*										
10517200	•		•	•	•	1	1								2	2	3	7	14					
10517212	•		•	•	•	1	1								2	2	3	7	14					
10517300		•	•																	10*	•	•	•	•
10517400	•		•																	10*	•	•	•	•
10517412	•		•																	10*	•	•	•	•
10519000	•		•		•	2	2	3	5*	5*	2*	2*	3*	3*										
10519012	•		•		•	2	2	3	5*	5*	2*	2*	3*	3*										
10525100			•	•	•													1	3					
10525112			•	•	•													1	3					
10525200			•	•	•													1	3					
10525212			•	•	•													1	3					
10525220			•	•	•													1	3					
10525222			•	•	•													1	3					
10525400			•	•	•												1	2	5					
10525412			•	•	•												1	2	5					
10525500			•	•	•												1	2	5					
10525512			•	•	•												1	2	5					
10525520			•	•	•												1	2	5					
10525522			•	•	•												1	2	5					
10525600			•																	2*	•	•	•	•
10525612			•																	2*	•	•	•	•

Max fixtures for each power supply (Vin 220÷240). Data in the chart are provided as a guide only. Please verify according to your installation.
* The voltage at the end of the system depends on the number of fixtures connected in series, please comply with CEI 64-8 standards.



MARTINA AQUA

- Adjustable spotlight.
- Configuration: AISI 316L stainless steel structure and adjustable bracket. Glass diffuser: transparent or sandblasted with silkscreen border, fixed through a robotic gluing system.
- Protection rating: IP68
- In compliance with EN60598-1 standards
- Class of insulation: III
- Installation: the luminaire is equipped with 5000mm cable. Martina Aqua 24V and Maxi Martina Aqua 24V are equipped with a dc/dc highly efficient resin-coated converter that removes electromagnetic interference and protects against polarity reversal and sudden voltage peak. Parallel wiring required. Mini Martina Aqua, Martina Aqua RGB and Maxi Martina Aqua RGB requires connection in series. SELV equivalent remote power supply required.
- We recommend the use of a connection system with a protection degree greater than or equal to the protection degree of the luminaire.
- During the installation and the maintenance of the fixtures it is important to be careful and avoid damages on the paint coating. Damages on the coating exposed to outdoor conditions or water, could cause corrosion. Chemical substances affect the anticorrosion covering protection.

EU Regulation 874/2012 - Illumination equipment energy classes



LED VERSION:
Class A/A+/A++
Luminaire supplied with integrated LED modules that cannot be replaced



.0 Inox



Ceiling lamp



Wall lamp



Floor installation



Pre-wired with approx 5000mm of cable



Remote electronic power supply



Protection against impact.
IK 05 - 0,70 joule
MiniMartina 316L
IK 07 - 2,00 joule
Martina 316L/MaxiMartina 316L

MiniMartina Aqua - Inox 316L Underwater - Transparent Glass - Adjustable - 30°

Light Source: Power LED / 1,1W / Total power 1,1W / CRI>80 / 350mA / Remote electronic power supply to be ordered



105171143
 White 4000K
 lm LED 130 ≈ lm OUTPUT 110
 Acc. 184 or 238

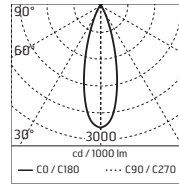

m	Max	Med
1.00	301	186
2.00	75	47
3.00	33	21
4.00	19	12
5.00	12	7

$\alpha = 15.0^\circ + 15.0^\circ$ $\beta = 15.0^\circ + 15.0^\circ$

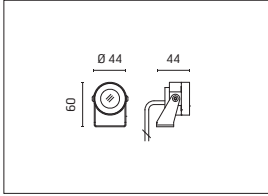

2700K and 3000K on request

IP68 (1MT)

MiniMartina Aqua - Inox 316L Underwater - Sandblasted Glass - Adjustable

Light Source: RGB Power LED / 3,4W / Total power 3,4W / 3CHx350mA / Remote electronic power supply to be ordered

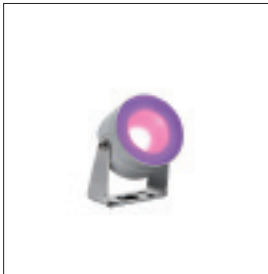

105173143

Wiring diagram and installation scheme RGB

Max 10 luminaires MINIMARTINA AQUA RGB
 for each code 141

>> See Page 560
 Wiring Diagram n.5

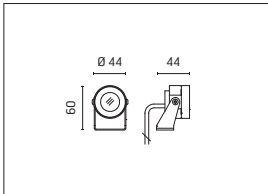

IP68 (1MT)

Martina Aqua - Inox 316L Underwater - Transparent Glass - Adjustable - 50°

Light Source: Power LED / 3,3W / Total power 4,5W / CRI>80 / 24Vdc / Remote electronic power supply to be ordered



105172144
White 4000K
lm LED 342 ≈ lm OUTPUT 243

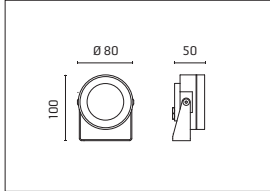
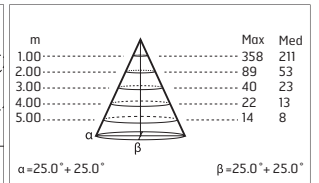
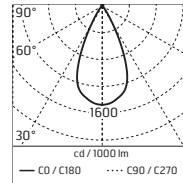

2700K and 3000K on request

IP68 (1MT)

Martina Aqua - Inox 316L Underwater - Transparent Glass - Adjustable - 35°

Light Source: RGB Power LED / 3,4W / Total power 3,4W / 3CHx350mA / Remote electronic power supply to be ordered



105174144

Wiring diagram and installation scheme RGB

Max 10 luminaires MARTINA AQUA RGB
for each code 141

>> See Page 560
Wiring Diagram n.5

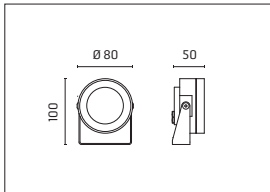

IP68 (1MT)

MaxiMartina Aqua / Inox 316L Underwater - Transparent Glass - Adjustable - 30°

Light Source: Power LED / 6,6W / Total power 9W / CRI>80 / 4Vdc / Remote electronic power supply to be ordered



105266145
White 4000K
lm LED 687 ≈ lm OUTPUT 435

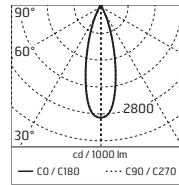

m	Max	Med
1.00	1176	729
2.00	294	182
3.00	131	81
4.00	74	46
5.00	47	29

$\alpha = 15.0^\circ + 15.0^\circ$ $\beta = 15.0^\circ + 15.0^\circ$

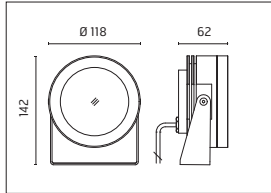

2700K and 3000K on request

IP68 (1MT)

MaxiMartina Aqua / Inox 316L Underwater - Transparent Glass - Adjustable - 30°

Light Source: Power LED / 9,9W / Total power 14,7W / CRI>80 / 24Vdc / Remote electronic power supply to be ordered



105211145
White 4000K
lm LED 1031 ≈ lm OUTPUT 723

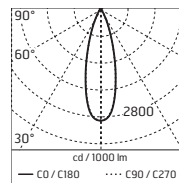

m	Max	Med
1.00	1763	1123
2.00	441	281
3.00	196	125
4.00	110	70
5.00	71	45

$\alpha = 15.0^\circ + 15.0^\circ$ $\beta = 15.0^\circ + 15.0^\circ$

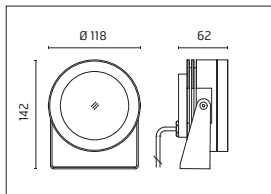

2700K and 3000K on request

IP68 (1MT)

MaxiMartina Aqua RGB / Inox 316L Underwater - Transparent Glass - Adjustable - 35°

Light Source: RGB Power LED / 13,6W / Total power 13,6W / 3CHx350mA / Remote electronic power supply to be ordered



105256145

Wiring diagram and installation scheme RGB

Max 2 luminaires MAXIMARTINA AQUA RGB for each code 141

>> See Page 560
Wiring Diagram n.5

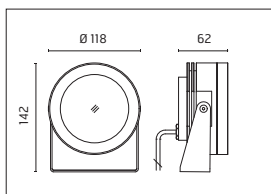

2700K and 3000K on request

IP68 (1MT)

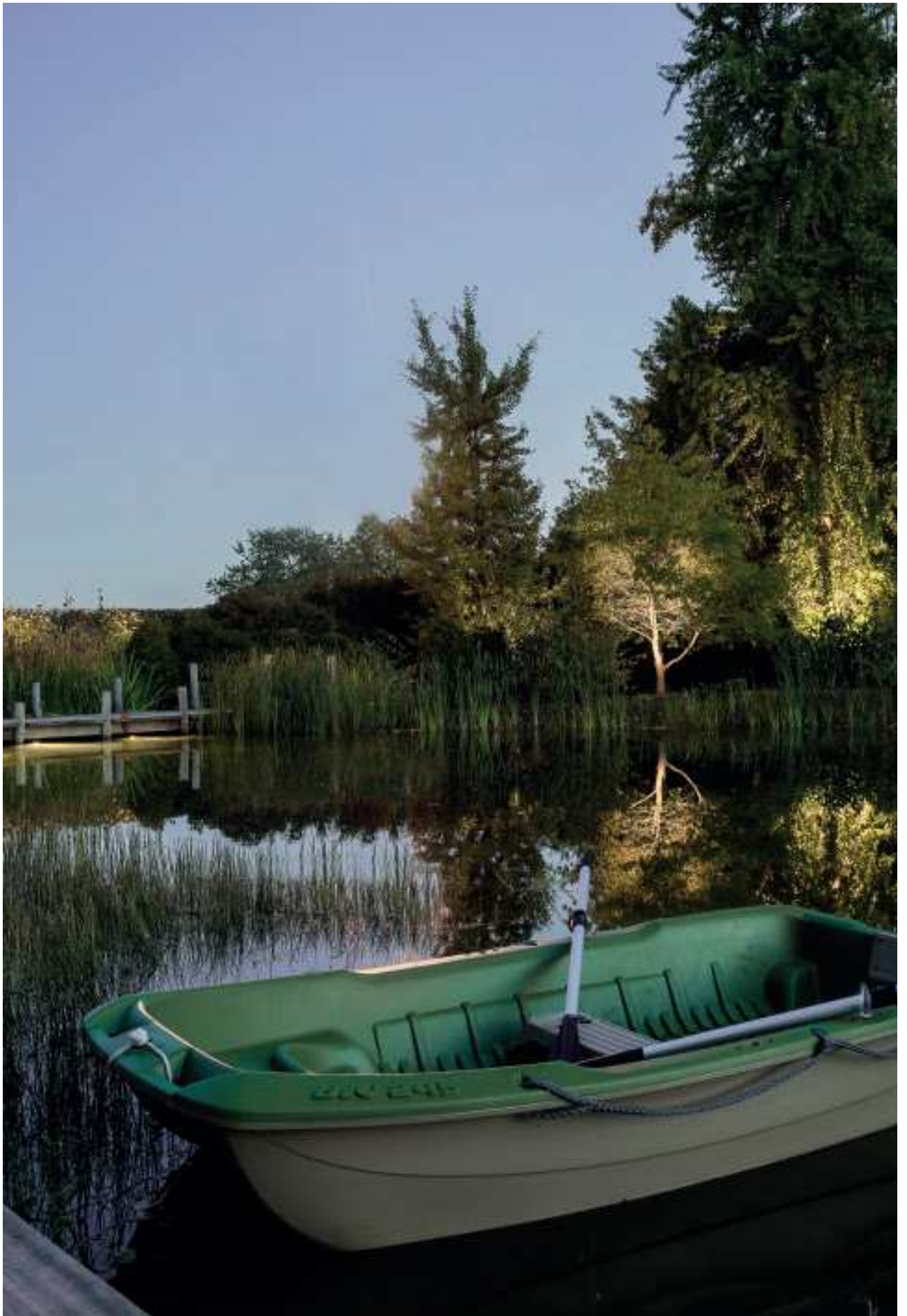

Accessories: Martina Aqua

136
GROUND SPIKE - H 200mm

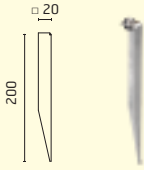

215
3/4 WAY TERMINAL BLOCK 4 POLES
IP68 H₂O STOP (Ø5,5÷12mm CABLE)

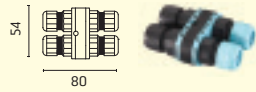

236
2 WAY TERMINAL BLOCK 4 POLES
IP68 H₂O STOP (Ø5,5÷12mm CABLE)

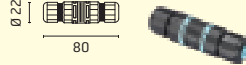

106
POWER SUPPLY DUAL FUNCTION
V_{out} 24Vdc: 8W/100÷240V
I_{out} 350mA: 6x1W/100÷240V
IP65 CLASS II SELV EQ.

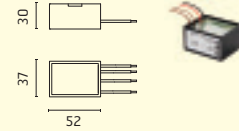

175
POWER SUPPLY 10W/110÷240V -
24Vdc IP67 CLASS II SELV.

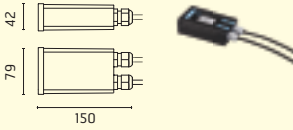

184
POWER SUPPLY 16x1W/110÷240V -
I_{out} 350mA (12x1W@110V)
IP67 CLASS II SELV.

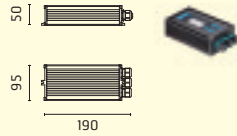

...DIMMABLE: PUSH-DIM OR 1...10V
See Page 558 Wiring Diagram n.3

238
POWER SUPPLY 18W/110-240V -
I_{out} 350mA (15W@110V)
IP67 CLASS II SELV.C

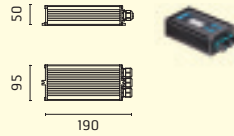

...DIMMABLE: DALI
See Page 558 Wiring Diagram n.3

147
POWER SUPPLY 20W/220÷240V -
24Vdc IP67 CLASS II SELV.

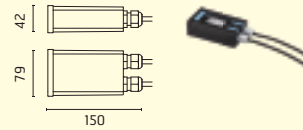

Accessories: Martina Aqua

155
POWER SUPPLY 50W/120÷240V - 24Vdc IP67 CLASS II SELV.

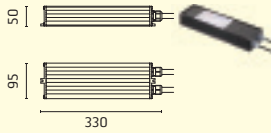

110
POWER SUPPLY 70W/220÷240V - 24Vdc IP67 CLASS II SELV EQ.

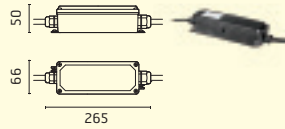

141
POWER SUPPLY WITH DMX INTERFACE FOR RGB FIXTURES 36W/220÷240V-3CHx350mA (3CHx10x1W) DMX CONTROL ALLOWED IP67 CLASS I SELV EQ.

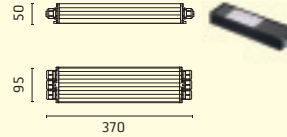

142
DMX CONTROLLER; DIMMER SWITCH FOR RECESSED BOX (60mm HOLE CENTRES)



187
DMX SPLITTER 512 - ELECTRONIC DEVICE TO REGENERATE THE MONODIRECTIONAL DMX SIGNAL
1 INPUT AND 7 OUTPUT, 12-24V dc

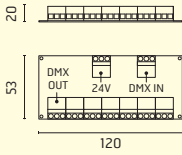

143
DMX CONTROLLER; STAND-ALONE/PC INTERFACE

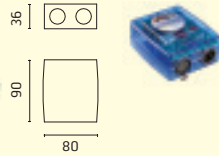

186
DMX CABLE - SHIELDED TWISTED PAIR WITH 110 Ohm CONSTANT IMPEDANCE.



POWER SUPPLY TO BE ORDERED (87 OR 175 RECOMMENDED)

acc. code ▶	136	215	236	106	175	184	238	147	155	110	141	142	143	187	186
prod. code ▼	105171143	105173143	105172144	105174144	105211145	105256145	105266145								
	•			6		16*	9*								
	•										10*	•	•	•	•
	•	•	•	1	2			3	7	14					
	•										10*	•	•	•	•
	•	•	•						3	6					
	•										2*	•	•	•	•
	•	•	•			1			3	7					

Max fixtures for each power supply (Vin 220÷240). Data in the chart are provided as a guide only. Please verify according to your installation.

* The voltage at the end of the system depends on the number of fixtures connected in series, please comply with CEI 64-8 standards.









- Spotlight for installation on wall, ceiling or floor.
- Configuration: turned aluminium body (EN AW 6060) and AISI 316L stainless steel fixing bracket. Glass diffuser: extra clear with silk-screen border, fixed to the body through a robotic gluing system.
- Double layer coating for high resistance to corrosion: the aluminium components are painted with a double coat using powders which are compliant with QUALICOAT standards: a first layer of epoxy powder (with excellent chemical and mechanical resistance) and a second finishing layer of polyester powder (resistant to UV rays and atmospheric agents). The entire painting process of the aluminium fitting starts from components which have been sand-blasted in advance to make the surface more porous and increase the adherence of the paint. Ares effects alkaline and acid washing to clean the surfaces completely, then rinses with demineralised water to remove any residue particles, subsequently a chemical conversion treatment is done to protect against rusting.
- Protection rating: IP65
- In compliance with EN60598-1 standards
- Class of insulation: III
- Installation: the luminaire is equipped with 2000mm cable for an easy-to-make connection. It is equipped with a dc/dc highly efficient resin-coated converter that removes electromagnetic interference and protects against polarity reversal and sudden voltage peak. Parallel wiring required.
- We recommend the use of a connection system with a protection degree greater than or equal to the protection degree of the luminaire.
- During the installation and the maintenance of the fixtures it is important to be careful and avoid damages on the paint coating.
Damages on the coating exposed to outdoor conditions or water, could cause corrosion.
Chemical substances affect the anticorrosion covering protection.

EU Regulation 874/2012 - Illumination equipment energy classes

A++
A+
A

LED VERSION:
Class A/A+/A++
Luminaire supplied with integrated LED modules that cannot be replaced



	Floor installation		Ceiling fitting
	Wall fitting		Pre-wired with approx 2000mm of cable.
	Remote device required.		Protection against impact. IK 05 - 0,70 joule for Pi 50x50 IK 07 - 2,00 joule for Pi 70x70

Pi - 50x50mm - Adjustable - 10°

Light Source: Power LED / 2,2W / Total power 3,4W / CRI>80 / 24Vdc / Remote electronic power supply to be ordered



509005
White 2700K
lm LED 169 ≠ lm OUTPUT 118

509003
White 3000K
lm LED 182 ≠ lm OUTPUT 127

509002
White 4000K
lm LED 198 ≠ lm OUTPUT 138

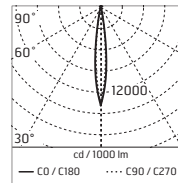

m	lux	
	Max	Med
1.00	1997	1222
2.00	499	306
3.00	222	136
4.00	125	76
5.00	80	49

$\alpha = 5.0^\circ + 5.0^\circ$ $\beta = 5.0^\circ + 5.0^\circ$

@4000K

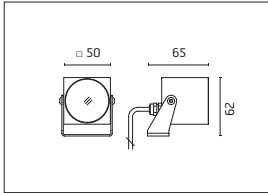

Dimmable on request

IP65

Pi - 50x50mm - Adjustable - 30°

Light Source: Power LED / 2,2W / Total power 3,4W / CRI>80 / 24Vdc / Remote electronic power supply to be ordered



509015
White 2700K
lm LED 169 ≠ lm OUTPUT 106

509013
White 3000K
lm LED 182 ≠ lm OUTPUT 114

509012
White 4000K
lm LED 198 ≠ lm OUTPUT 125

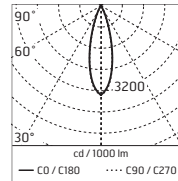

m	lux	
	Max	Med
1.00	437	265
2.00	109	66
3.00	49	29
4.00	27	17
5.00	17	11

$\alpha = 15.0^\circ + 15.0^\circ$ $\beta = 15.0^\circ + 15.0^\circ$

@4000K

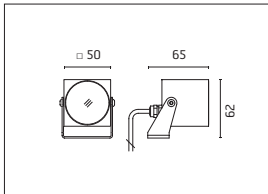

Dimmable on request

IP65

Pi - 50x50mm - Adjustable - 10°

Light Source: Power LED / 3,3W / Total power 4,5W / CRI>80 / 24Vdc / Remote electronic power supply to be ordered



509025
White 2700K
lm LED 307 ≠ lm OUTPUT 219

509023
White 3000K
lm LED 330 ≠ lm OUTPUT 236

509022
White 4000K
lm LED 360 ≠ lm OUTPUT 258

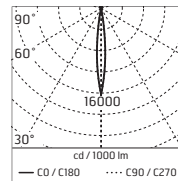

m	lux	
	Max	Med
1.00	4368	2691
2.00	1092	673
3.00	485	299
4.00	277	168
5.00	175	108

$\alpha = 5.0^\circ + 5.0^\circ$ $\beta = 5.0^\circ + 5.0^\circ$

@4000K

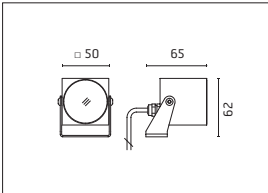

Dimmable on request

IP65

Pi - 50x50mm - Adjustable - 30°

Light Source: Power LED / 3,3W / Total power 4,5W / CRI>80 / 24Vdc / Remote electronic power supply to be ordered



509035
White 2700K
lm LED 307 ≈ lm OUTPUT 176

509033
White 3000K
lm LED 330 ≈ lm OUTPUT 189

509032
White 4000K
lm LED 360 ≈ lm OUTPUT 207

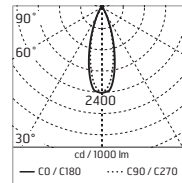
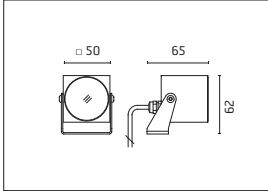

m	lux	
	Max	Med
1.00	524	318
2.00	131	79
3.00	58	35
4.00	33	20
5.00	21	13

$\alpha = 15.0^\circ + 15.0^\circ$ $\beta = 15.0^\circ + 15.0^\circ$

@4000K

Dimmable on request



Pi - 70x70mm - Adjustable - 10°

Light Source: Power LED / 4,8W / Total power 5,9W / CRI>80 / 24Vdc / Remote electronic power supply to be ordered



509045
White 2700K
lm LED 388 ≈ lm OUTPUT 309

509043
White 3000K
lm LED 417 ≈ lm OUTPUT 332

509042
White 4000K
lm LED 444 ≈ lm OUTPUT 353

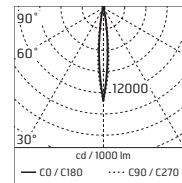
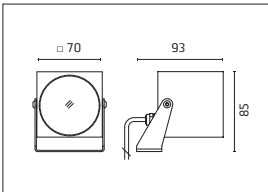

m	lux	
	Max	Med
1.00	5338	3170
2.00	1334	793
3.00	593	352
4.00	334	198
5.00	214	127

$\alpha = 5.0^\circ + 5.0^\circ$ $\beta = 5.0^\circ + 5.0^\circ$

@4000K

Dimmable on request



Pi - 70x70mm - Adjustable - 50°

Light Source: Power LED / 4,8W / Total power 5,9W / CRI>80 / 24Vdc / Remote electronic power supply to be ordered



509055
White 2700K
lm LED 388 ≈ lm OUTPUT 273

509053
White 3000K
lm LED 417 ≈ lm OUTPUT 294

509052
White 4000K
lm LED 444 ≈ lm OUTPUT 326

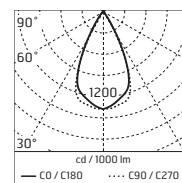
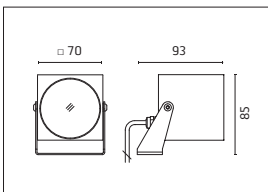

m	lux	
	Max	Med
1.00	524	308
2.00	131	77
3.00	58	34
4.00	33	19
5.00	21	12

$\alpha = 25.0^\circ + 25.0^\circ$ $\beta = 25.0^\circ + 25.0^\circ$

@4000K

Dimmable on request





Accessories: Pi

136
GROUND SPIKE - H 200mm

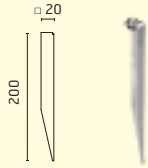

150
POWER SUPPLY DUAL FUNCTION
Vout 24Vdc: 8W/100÷240V
Iout 350mA: 6x1W/100÷240V
IP20 CLASS II SELV EQ.

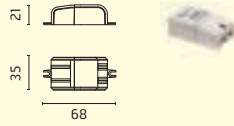

106
POWER SUPPLY DUAL FUNCTION
Vout 24Vdc: 8W/100÷240V
Iout 350mA: 6x1W/100÷240V
IP65 CLASS II SELV EQ.

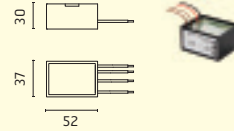

87
POWER SUPPLY 10W/110÷240V -
24Vdc IP20 CLASS II SELV.

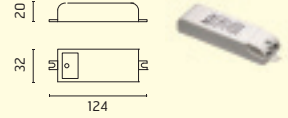

175
POWER SUPPLY 10W/110÷240V -
24Vdc IP67 CLASS II SELV.

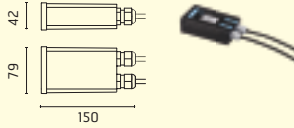

147
POWER SUPPLY 20W/220÷240V -
24Vdc IP67 CLASS II SELV.

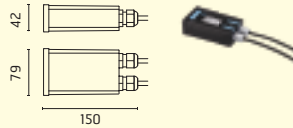

155
POWER SUPPLY 50W/120÷240V -
24Vdc IP67 CLASS II SELV.

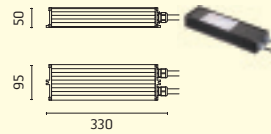

110
POWER SUPPLY 70W/220÷240V -
24Vdc IP67 CLASS II SELV EQ.

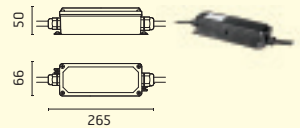

acc. code ▶	136	150	106	87	175	147	155	110
509002	●	1	1	2	2	3	9	17
509003	●	1	1	2	2	3	9	17
509005	●	1	1	2	2	3	9	17
509012	●	1	1	2	2	3	9	17
509013	●	1	1	2	2	3	9	17
509015	●	1	1	2	2	3	9	17
509022	●	1	1	2	2		7	14
509023	●	1	1	2	2		7	14
509025	●	1	1	2	2		7	14
509032	●	1	1	2	2		7	14
509033	●	1	1	2	2		7	14
509035	●	1	1	2	2		7	14
509042	●			1	1	2	6	12
509043	●			1	1	2	6	12
509045	●			1	1	2	6	12
509052	●			1	1	2	6	12
509053	●			1	1	2	6	12
509055	●			1	1	2	6	12

Max fixtures for each power supply (Vin 220÷240).
Data in the chart are provided as a guide only.
Please verify according to your installation.



Pan - Adjustable - 20°

Light Source: CoB LED / 12W / Total power 15W / CRI>80 / 220÷240V / Integral electronic power supply



504050
504050-300 Dimmable Dali
504050-310 Dimmable 1-10
 White 2700K
 lm LED 1650 ≈ lm OUTPUT 1455

504012
504012-300 Dimmable Dali
504012-310 Dimmable 1-10
 White 3000K
 lm LED 1774 ≈ lm OUTPUT 1564

504011
504011-300 Dimmable Dali
504011-310 Dimmable 1-10
 White 4000K
 lm LED 1829 ≈ lm OUTPUT 1641

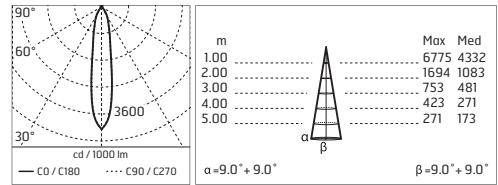

@4000K

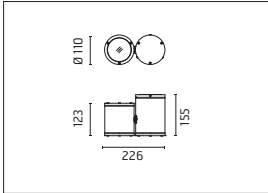

IP65

Pan - Adjustable - 40°

Light Source: CoB LED / 12W / Total power 15W / CRI>80 / 220÷240V / Integral electronic power supply



504052
504052-300 Dimmable Dali
504052-310 Dimmable 1-10
 White 2700K
 lm LED 1650 ≈ lm OUTPUT 1443

504009
504009-300 Dimmable Dali
504009-310 Dimmable 1-10
 White 3000K
 lm LED 1774 ≈ lm OUTPUT 1552

504008
504008-300 Dimmable Dali
504008-310 Dimmable 1-10
 White 4000K
 lm LED 1829 ≈ lm OUTPUT 1628

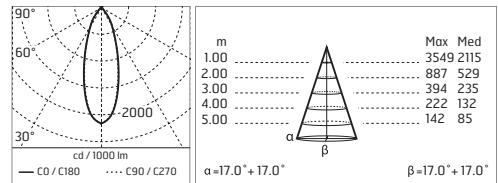

@4000K

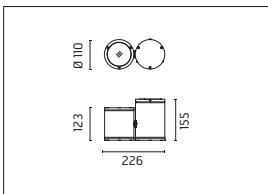

IP65

Pan on Post - Adjustable - 20°

Light Source: CoB LED / 12W / Total power 15W / CRI>80 / 220÷240V / Integral electronic power supply

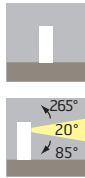

504054
504054-300 Dimmable Dali
504054-310 Dimmable 1-10
 White 2700K
 lm LED 1650 ≠ lm OUTPUT 1455

504027
504027-300 Dimmable Dali
504027-310 Dimmable 1-10
 White 3000K
 lm LED 1774 ≠ lm OUTPUT 1564

504026
504026-300 Dimmable Dali
504026-310 Dimmable 1-10
 White 4000K
 lm LED 1829 ≠ lm OUTPUT 1641

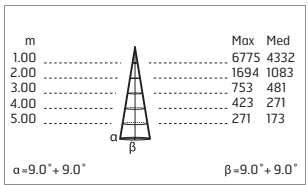
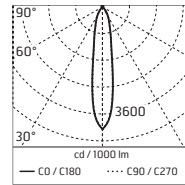
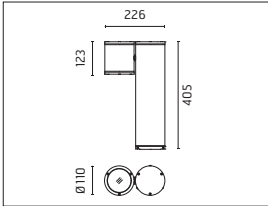

@4000K

IP65

Pan on Post - Adjustable - 40°

Light Source: CoB LED / 12W / Total power 15W / CRI>80 / 220÷240V / Integral electronic power supply

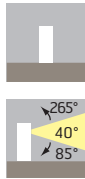

504056
504056-300 Dimmable Dali
504056-310 Dimmable 1-10
 White 2700K
 lm LED 1650 ≠ lm OUTPUT 1443

504024
504024-300 Dimmable Dali
504024-310 Dimmable 1-10
 White 3000K
 lm LED 1774 ≠ lm OUTPUT 1552

504023
504023-300 Dimmable Dali
504023-310 Dimmable 1-10
 White 4000K
 lm LED 1829 ≠ lm OUTPUT 1628

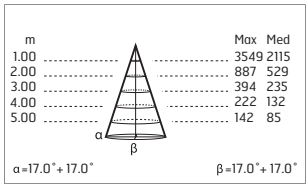
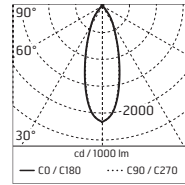
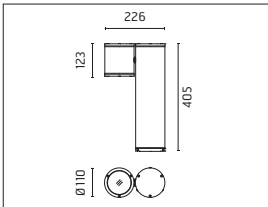

@4000K

IP65



Accessories: Pan

140

BASE PLATE AND FIXING BOLTS
 Ø 90 x H 170mm

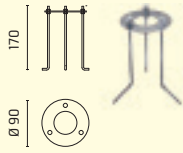

237

SPD: (SURGE PROTECTION DEVICE)
 275Vac
 MAXIMUM DISCHARGE CURRENT
 10KA (8/20µs)
 MAXIMUM OPERATING CURRENT 5A
 SUITABLE FOR SERIES CONNEC-
 TION - IP66

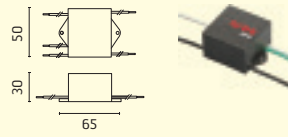

acc. code ▶	dimmi DALI	dimmi 1-10	140	237
504008	-300	-310	•	•
504009	-300	-310	•	•
504011	-300	-310	•	•
504012	-300	-310	•	•
504023	-300	-310	•	•
504024	-300	-310	•	•
504026	-300	-310	•	•
504027	-300	-310	•	•
504050	-300	-310	•	•
504052	-300	-310	•	•
504054	-300	-310	•	•
504056	-300	-310	•	•



ECLIPSE

- Slim round luminaire for installation on wall – surface mounted.
- Configuration: die-cast aluminium structure, EN AB-47100 alloy (low copper content), stainless steel bracket and transparent polycarbonate emitting unit.
- Double layer coating for high resistance to corrosion: the aluminium components are painted with a double coat using powders that are compliant with QUALICOAT standards: a first layer of epoxy powder (with excellent chemical and mechanical resistance) and a second finishing layer of polyester powder (resistant to UV rays and atmospheric agents). The entire painting process of the aluminium fitting starts from components that have been sandblasted in advance to make the surface more porous and increase the adherence of the paint. Ares effects alkaline and acid washing to clean the surfaces completely, then rinses with demineralised water to remove any residue particles, subsequently a chemical conversion treatment is done to protect against rusting.
- Protection rating: IP65
- In compliance with EN60598-1 standards
- Class of insulation: II; 24V version: III
- Installation: the luminaire is equipped with a piece of neoprene cable (approx. 200mm) for an easy-to-make connection. Direct screwing on surface through the stainless steel bracket.
- We recommend the use of a connection system with a protection degree greater than or equal to the protection degree of the luminaire.
- During the installation and the maintenance of the fixtures it is important to be careful and avoid damages on the paint coating. Damages on the coating exposed to outdoor conditions or water, could cause corrosion. Chemical substances affect the anticorrosion covering protection.

EU Regulation 874/2012 - Illumination equipment energy classes

A++
A+
A

LED VERSION:
Class A/A+/A++
Luminaire supplied with integrated LED modules that cannot be replaced



Wall fitting



Pre-wired with approx 200mm of cable



Remote device required for low voltage version



Protection against impact IK 09 - 10,00 joule



Glow wire test: 650°C

Eclipse

Light Source: Mid-Power LED / CRI>80

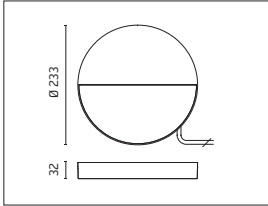
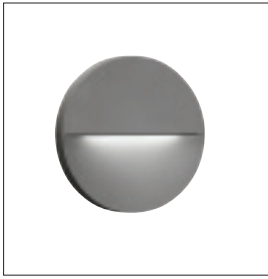

6W / Total power 10W / 220÷240V / Integral electronic power supply

542007
White 2700K
lm LED 739 ≈ lm OUTPUT 387

542003
White 3000K
lm LED 795 ≈ lm OUTPUT 416

542002
White 4000K
lm LED 835 ≈ lm OUTPUT 437

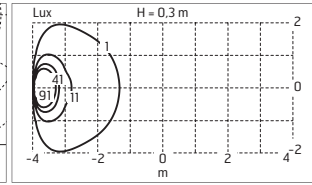
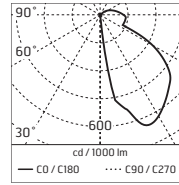

@4000K

6W / Total power 7,5W / 24Vdc / Remote electronic power supply to be ordered

542009
White 2700K
lm LED 739 ≈ lm OUTPUT 387
Acc. 144, 176 or 252

542006
White 3000K
lm LED 795 ≈ lm OUTPUT 416
Acc. 144, 176 or 252

542005
White 4000K
lm LED 835 ≈ lm OUTPUT 437
Acc. 144, 176 or 252

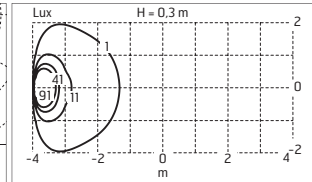
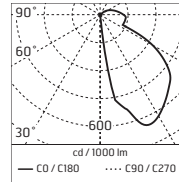

@4000K

IP65

Accessories: Eclipse

87
POWER SUPPLY 10W/110÷240V -
24Vdc IP20 CLASS II SELV.

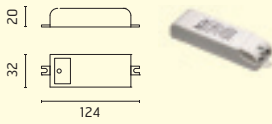

175
POWER SUPPLY 10W/110÷240V -
24Vdc
IP67 CLASS II SELV.

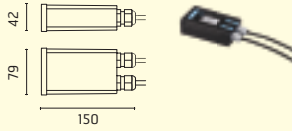

144
POWER SUPPLY 17W/110÷240V
- 24Vdc (15W@110V) IP20 CLASS
II SELV.

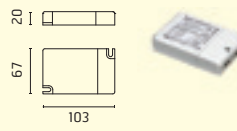

176
POWER SUPPLY 17W/110÷240V
- 24Vdc (15W@110V) IP67 CLASS
II SELV.

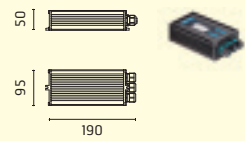

... DIMMABLE: PUSH-DIM OR 1...10V
See Page 558 Wiring Diagram n.4

... DIMMABLE: PUSH-DIM OR 1...10V
See Page 558 Wiring Diagram n.4

252
POWER SUPPLY 20W/110-240Vdc
(15W@110V) IP67 CLASS II SELV.

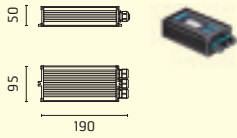

147
POWER SUPPLY 20W/220÷240V -
24Vdc IP67 CLASS II SELV.

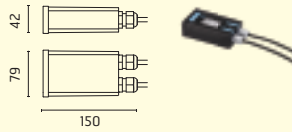

155
POWER SUPPLY 50W/120÷240V -
24Vdc IP67 CLASS II SELV.

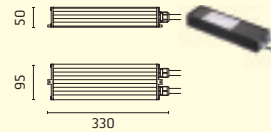

110
POWER SUPPLY 70W/220÷240V -
24Vdc IP67 CLASS II SELV EQ.

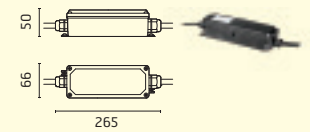

... DIMMABLE: DALI
See Page 558 Wiring Diagram n.4

156
POWER SUPPLY 96W /120÷277V -
24Vdc IP67 CLASS II SELV.

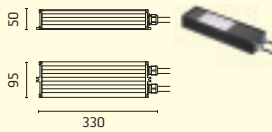

237
SPD: (SURGE PROTECTION DEVICE)
275Vac MAXIMUM DISCHARGE CUR-
RENT 10KA (8/20µs)
MAXIMUM OPERATING CURRENT 5A
SUITABLE FOR SERIES CONNECTION
- IP66

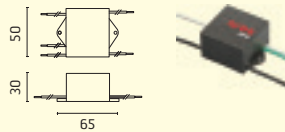

acc. code ▶	87	175	144	176	252	147	155	110	156	237
542002										•
542003										•
542005	1	1	2	2	2	2	6	9	12	
542006	1	1	2	2	2	2	6	9	12	
542007										•
542009	1	1	2	2	2	2	6	9	12	

Max fixtures for each power supply (Vin 220÷240).
Data in the chart are provided as a guide only.
Please verify according to your installation.



- Rectangular luminaire for installation on wall – surface mounted.
- Configuration: die-cast aluminium structure, EN AB-47100 alloy (low copper content), stainless steel bracket and transparent polycarbonate emitting unit. Optional accessory: aluminium reflector (fixed by a double-sided technical tape)
- Double layer coating for high resistance to corrosion: the aluminium components are painted with a double coat using powders that are compliant with QUALICOAT standards: a first layer of epoxy powder (with excellent chemical and mechanical resistance) and a second finishing layer of polyester powder (resistant to UV rays and atmospheric agents). The entire painting process of the aluminium fitting starts from components that have been sandblasted in advance to make the surface more porous and increase the adherence of the paint. Ares effects alkaline and acid washing to clean the surfaces completely, then rinses with demineralised water to remove any residue particles, subsequently a chemical conversion treatment is done to protect against rusting.
- Protection rating: IP65
- In compliance with EN60598-1 standards
- Class of insulation: II; 24V version: III
- Installation: the luminaire is equipped with a piece of neoprene cable (approx. 200mm) for an easy-to-make connection. Direct screwing on surface through the stainless steel bracket.
- We recommend the use of a connection system with a protection degree greater than or equal to the protection degree of the luminaire.
- During the installation and the maintenance of the fixtures it is important to be careful and avoid damages on the paint coating. Damages on the coating exposed to outdoor conditions or water, could cause corrosion. Chemical substances affect the anticorrosion covering protection.

EU Regulation 874/2012 - Illumination equipment energy classes



LED VERSION:
Class A/A+/A++
Luminaire supplied with integrated LED modules that cannot be replaced



.1 White



.6 Grey



.3 Anthracite



.4 Black



.18 Deep Brown



Wall fitting



Pre-wired with approx 200mm of cable.



Bollard light



Remote device required for low voltage version



Protection against impact.
IK 09 - 10,00 joule

Hyperion

Light Source: Mid-Power LED / CRI>80



□ 6W / Total power 10W / 220÷240V / Integral electronic power supply

527005

White 2700K
lm LED 739 ≠ lm OUTPUT 370

527003

White 3000K
lm LED 795 ≠ lm OUTPUT 398

527002

White 4000K
lm LED 835 ≠ lm OUTPUT 418

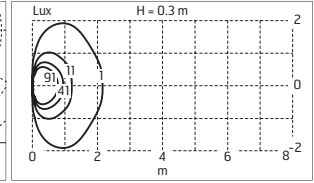
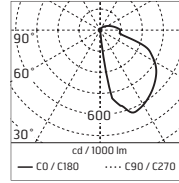

@4000K

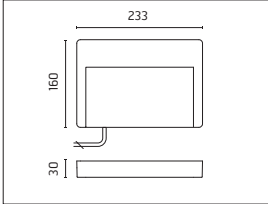

◇ 6W / Total power 7,5W / 24Vdc / Remote electronic power supply to be ordered

527015

White 2700K
lm LED 739 ≠ lm OUTPUT 370
... Acc. 144, 176 or 252

527013

White 3000K
lm LED 795 ≠ lm OUTPUT 398
... Acc. 144, 176 or 252

527012

White 4000K
lm LED 835 ≠ lm OUTPUT 418
... Acc. 144, 176 or 252

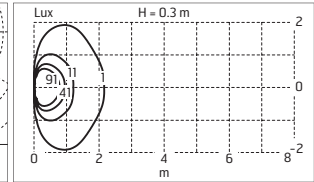
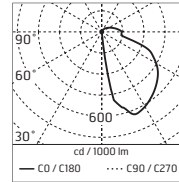

@4000K

IP65

Hyperion Mid-Power LED / Pole

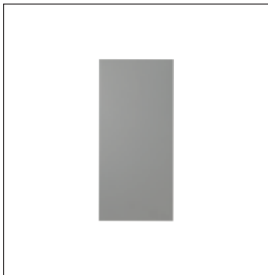

245
H 500 mm

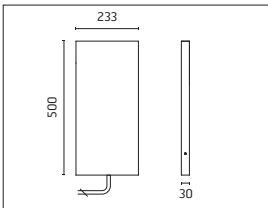





Accessories: Hyperion

247
BASE PLATE AND FIXING BOLTS
230 x 25 H 160mm

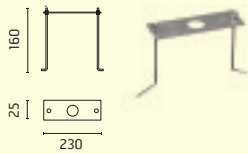

87
POWER SUPPLY 10W/110÷240V -
24Vdc IP20 CLASS II SELV.

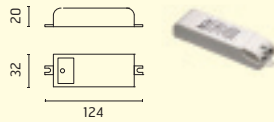

175
POWER SUPPLY 10W/110÷240V -
24Vdc IP67 CLASS II SELV.

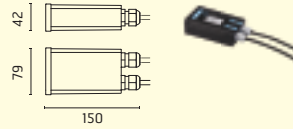

144
POWER SUPPLY 17W/110÷240V -
24Vdc (15W@110V) IP20 CLASS II
SELV.

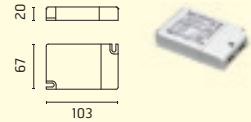

... DIMMABLE: PUSH-DIM OR 1...10V
See Page 558 Wiring Diagram n.4

176
POWER SUPPLY 17W/110÷240V - 24Vdc
(15W@110V) IP67 CLASS II SELV.

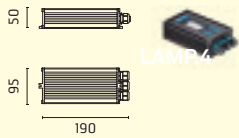

... DIMMABLE: PUSH-DIM OR 1...10V
See Page 558 Wiring Diagram n.4

252
POWER SUPPLY 20W/110-240Vdc
(15W@110V) IP67 CLASS II SELV.



... DIMMABLE: DALI
See Page 558 Wiring Diagram n.4

147
POWER SUPPLY 20W/220÷240V -
24Vdc IP67 CLASS II SELV.

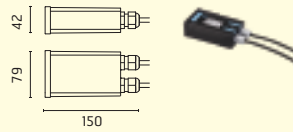

155
POWER SUPPLY 50W/120÷240V -
24Vdc IP67 CLASS II SELV.

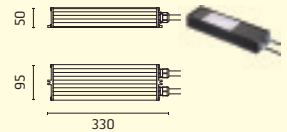

110
POWER SUPPLY 70W/220÷240V - 24Vdc
IP67 CLASS II SELV EQ.

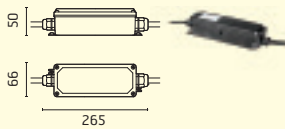

156
POWER SUPPLY 96W /120÷277V - 24Vdc
IP67 CLASS II SELV.

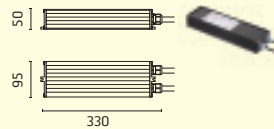

237
SPD: (SURGE PROTECTION DEVICE)
275Vac
MAXIMUM DISCHARGE CURRENT 10KA
(8/20µs)
MAXIMUM OPERATING CURRENT 5A
SUITABLE FOR SERIES CONNECTION
- IP66

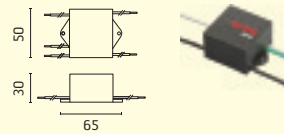

160
SATIN ALUMINIUM CARTER
THICKNESS 0.5mm

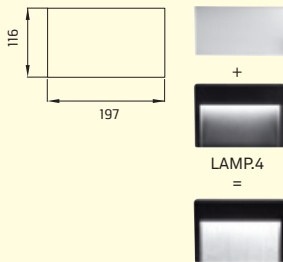

LAMP.4+cod.160 =+20% lm

acc. code ▶	160	87	175	144	176	252	147	155	110	156	237	247
prod. code ▼												
245												•
527002	•										•	
527003	•										•	
527005	•										•	
527012	•	1	1	2	2	2	2	6	9	12		
527013	•	1	1	2	2	2	2	6	9	12		
527015	•	1	1	2	2	2	2	6	9	12		

Max fixtures for each power supply (Vin 220÷240). Data in the chart are provided as a guide only. Please verify according to your installation.



Giulia200

Light Source: Mid-Power LED / 8,8W / Total power 11W / CRI>80 / 220÷240V / Integral electronic power supply



544007
White 2700K
lm LED 1202 \approx lm OUTPUT 732

544002
White 3000K
lm LED 1292 \approx lm OUTPUT 787

544001
White 4000K
lm LED 1334 \approx lm OUTPUT 812

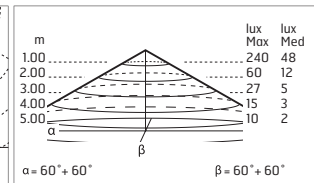
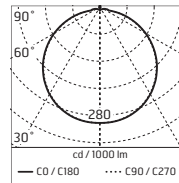

@4000K

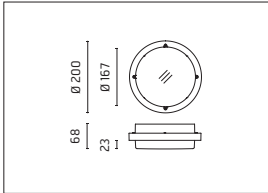

IP66

Giulia300

Light Source: Mid-Power LED / 14,3W / Total power 15,5W / CRI>80 / 220÷240V / Integral electronic power supply



544008
544008-300 Dimmable Dali
544008-310 Dimmable 1-10
White 2700K
lm LED 1874 \approx lm OUTPUT 1150

544004
544004-300 Dimmable Dali
544004-310 Dimmable 1-10
White 3000K
lm LED 2015 \approx lm OUTPUT 1237

544003
544003-300 Dimmable Dali
544003-310 Dimmable 1-10
White 4000K
lm LED 2168 \approx lm OUTPUT 1330

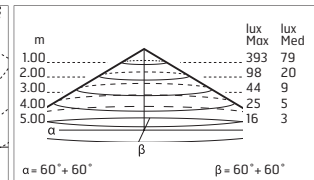
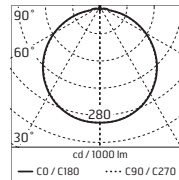

@4000K

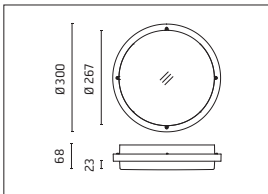

IP66

Giulia400

Light Source: Mid-Power LED / 19,8W / Total power 31,5W / CRI>80 / 110÷240V / Integral electronic power supply



544009
544009-300 Dimmable Dali
544009-310 Dimmable 1-10
White 2700K
lm LED 3590 \approx lm OUTPUT 2345

544006
544006-300 Dimmable Dali
544006-310 Dimmable 1-10
White 3000K
lm LED 3860 \approx lm OUTPUT 2521

544005
544005-300 Dimmable Dali
544005-310 Dimmable 1-10
White 4000K
lm LED 4152 \approx lm OUTPUT 2712

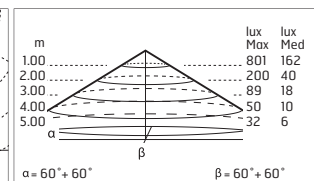
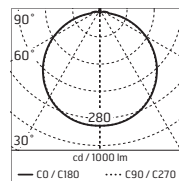

@4000K

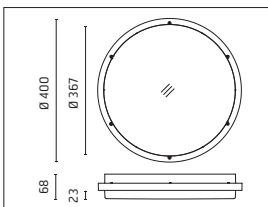

IP66

Accessories: Giulia

237

SPD: (SURGE PROTECTION DEVICE)
 275Vac
 MAXIMUM DISCHARGE CURRENT
 10KA (8/20µs)
 MAXIMUM OPERATING CURRENT 5A
 SUITABLE FOR SERIES CONNECTION
 - IP66

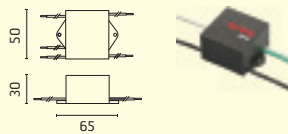





acc. code ▶	dimmi DALI	dimmi 1-10	237
544001			•
544002			•
544003	-300	-310	•
544004	-300	-310	•
544005	-300	-310	•
544006	-300	-310	•
544007			•
544008	-300	-310	•
544009	-300	-310	•



- Linear luminaire for installation on wall or ceiling – surface mounted.
- Configuration: die-cast aluminium closing ends, EN AB-47100 alloy (low copper content), extruded aluminium structure and zinc-coated steel fixing brackets. Glass diffuser: transparent or sandblasted with silkscreen border, fixed to the aluminium through a robotic gluing system.
- Double layer coating for high resistance to corrosion: the aluminium components are painted with a double coat using powders that are compliant with QUALICOAT standards: a first layer of epoxy powder (with excellent chemical and mechanical resistance) and a second finishing layer of polyester powder (resistant to UV rays and atmospheric agents). The entire painting process of the aluminium fitting starts from components that have been sandblasted in advance to make the surface more porous and increase the adherence of the paint. Ares effects alkaline and acid washing to clean the surfaces completely, then rinses with demineralised water to remove any residue particles, subsequently a chemical conversion treatment is done to protect against rusting.
- Protection rating: IP65
- In compliance with EN60598-1 standards
- Class of insulation: I; RGB: I
- Installation: the luminaire is equipped with a piece of cable (approx. 500mm) and an M16 cable-gland (4,5mm <math>\lt \varnothing < \varnothing < 10\text{mm}</math> cables) closed with a removable cap. The electrical components are installed on a removable frame accessible by unscrewing the closing ends. Outdoor use requires suitable flexible cables assuring the watertightness of the cable holder.
- We recommend the use of a connection system with a protection degree greater than or equal to the protection degree of the luminaire.
- During the installation and the maintenance of the fixtures it is important to be careful and avoid damages on the paint coating. Damages on the coating exposed to outdoor conditions or water, could cause corrosion. Chemical substances affect the anticorrosion covering protection.

EU Regulation 874/2012 - Illumination equipment energy classes

	LED VERSION: Class A/A+/A++ Luminaire supplied with integrated LED modules that cannot be replaced
	
	
	FLUORESCENT VERSION: Class A+ T16/G5

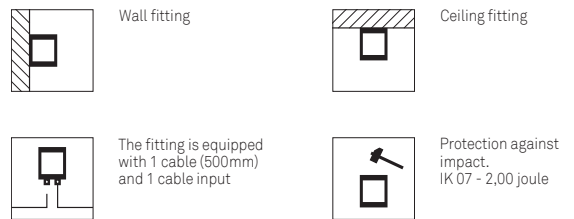

Arcadia640 - With Brackets L 80mm - Transparent Glass - Adjustable - 10°

Light Source: Power LED / 13,2W / Total power 16W / CRI>80 / 220÷240V / Integral electronic power supply



545070
545070-300 Dimmable Dali
545070-310 Dimmable 1-10
 White 2700K
 lm LED 1339 ≠ lm OUTPUT 1222

545003
545003-300 Dimmable Dali
545003-310 Dimmable 1-10
 White 3000K
 lm LED 1440 ≠ lm OUTPUT 1314

545002
545002-300 Dimmable Dali
545002-310 Dimmable 1-10
 White 4000K
 lm LED 1560 ≠ lm OUTPUT 1423

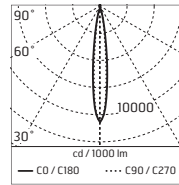

m	lux	
	Max	Med
1.00	15213	9757
2.00	3803	2439
3.00	1690	1084
4.00	951	610
5.00	609	390

$\alpha = 6.0^\circ + 6.0^\circ$ $\beta = 6.0^\circ + 6.0^\circ$

@4000K

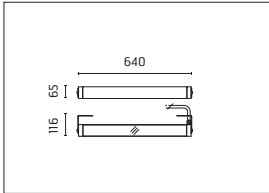
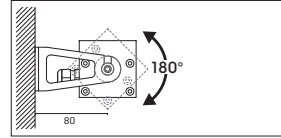

IP65

Arcadia640 - With Brackets L 80mm - Transparent Glass - Adjustable - 40°

Light Source: Power LED / 13,2W / Total power 16W / CRI>80 / 220÷240V / Integral electronic power supply



545072
545072-300 Dimmable Dali
545072-310 Dimmable 1-10
 White 2700K
 lm LED 1339 ≠ lm OUTPUT 1070

545006
545006-300 Dimmable Dali
545006-310 Dimmable 1-10
 White 3000K
 lm LED 1440 ≠ lm OUTPUT 1151

545005
545005-300 Dimmable Dali
545005-310 Dimmable 1-10
 White 4000K
 lm LED 1560 ≠ lm OUTPUT 1247

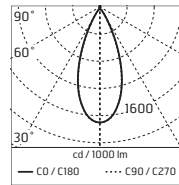

m	lux	
	Max	Med
1.00	2121	1266
2.00	530	317
3.00	236	141
4.00	133	79
5.00	85	51

$\alpha = 21.0^\circ + 21.0^\circ$ $\beta = 21.0^\circ + 21.0^\circ$

@4000K

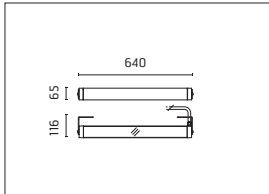
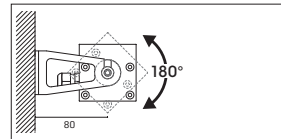

IP65

Arcadia640 - With Brackets L 80mm - Sandblasted Glass - Adjustable

Light Source: RGB Power LED / 20,4W / Total power 28W / 230V / with DMX-RDM interface

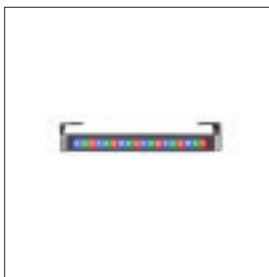

545100

Wiring diagram and installation scheme RGB

>> See Page 561
 Wiring Diagram n.8

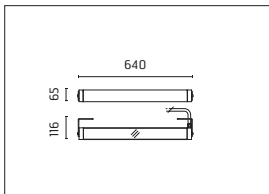
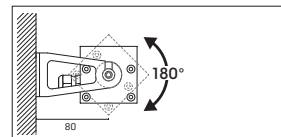

IP65

Arcadia640 - With Brackets L 80mm - Sandblasted Glass - Adjustable



545008
545008-300 Dimmable Dali
 T16 14W G5
 Electronic ballast

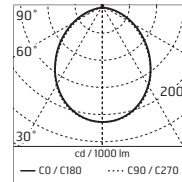
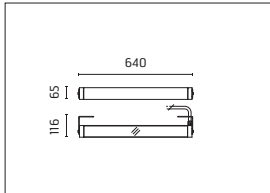

m	lux	
	Max	Med
1.00	289	93
2.00	72	23
3.00	32	10
4.00	18	6
5.00	12	4

$\alpha = 50.0^\circ + 50.0^\circ$ $\beta = 50.0^\circ + 50.0^\circ$

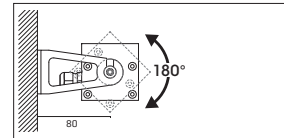

IP65

Arcadia640 - With Brackets L 80mm - Transparent Glass - Adjustable



545007
545007-300 Dimmable Dali
 T16 14W G5
 Electronic ballast

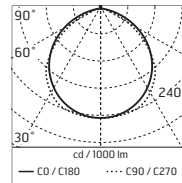
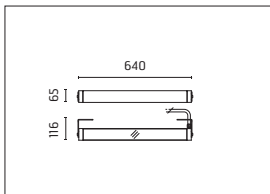

m	lux	
	Max	Med
1.00	333	93
2.00	83	23
3.00	37	10
4.00	21	6
5.00	13	4

$\alpha = 55.0^\circ + 55.0^\circ$ $\beta = 55.0^\circ + 55.0^\circ$

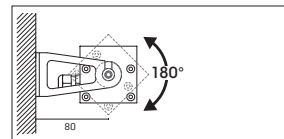

IP65

Arcadia640 - With Brackets L 200mm - Transparent Glass - Adjustable - 10°

Light Source: Power LED / 13,2W / Total power 16W / CRI>80 / 220÷240V / Integral electronic power supply



545074
545074-300 Dimmable Dali
545074-310 Dimmable 1-10
 White 2700K
 lm LED 1339 ≈ lm OUTPUT 1222

545012
545012-300 Dimmable Dali
545012-310 Dimmable 1-10
 White 3000K
 lm LED 1440 ≈ lm OUTPUT 1314

545011
545011-300 Dimmable Dali
545011-310 Dimmable 1-10
 White 4000K
 lm LED 1560 ≈ lm OUTPUT 1423

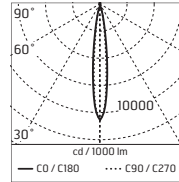

m	lux	
	Max	Med
1.00	15213	9757
2.00	3803	2439
3.00	1690	1084
4.00	951	610
5.00	609	390

$\alpha = 6.0^\circ + 6.0^\circ$ $\beta = 6.0^\circ + 6.0^\circ$

@4000K

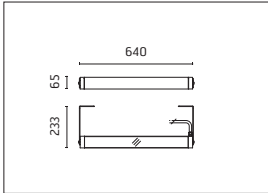
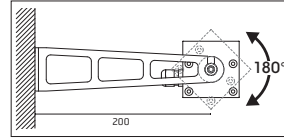

IP65

Arcadia640 - With Brackets L 200mm - Transparent Glass - Adjustable - 40°

Light Source: Power LED / 13,2W / Total power 16W / CRI>80 / 220÷240V / Integral electronic power supply



545076
545076-300 Dimmable Dali
545076-310 Dimmable 1-10
 White 2700K
 lm LED 1339 ≈ lm OUTPUT 1070

545015
545015-300 Dimmable Dali
545015-310 Dimmable 1-10
 White 3000K
 lm LED 1440 ≈ lm OUTPUT 1151

545014
545014-300 Dimmable Dali
545014-310 Dimmable 1-10
 White 4000K
 lm LED 1560 ≈ lm OUTPUT 1247

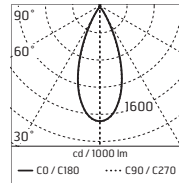

m	lux	
	Max	Med
1.00	2121	1266
2.00	530	317
3.00	236	141
4.00	133	79
5.00	85	51

$\alpha = 21.0^\circ + 21.0^\circ$ $\beta = 21.0^\circ + 21.0^\circ$

@4000K

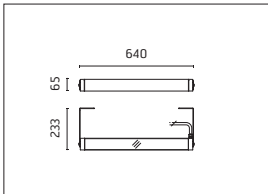
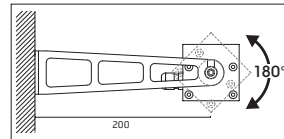

IP65

Arcadia640 With Brackets L 200mm - Sandblasted Glass - Adjustable

Light Source: RGB Power LED / 20,4W / Total power 28W / 230V / with DMX-RDM interface



545102

Wiring diagram and installation scheme RGB

>> See Page 561
 Wiring Diagram n.8

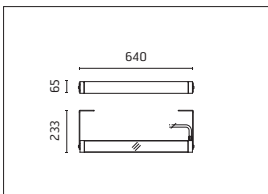
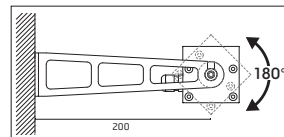

IP65

Arcadia640 / With Brackets L 200mm - Sandblasted Glass - Adjustable

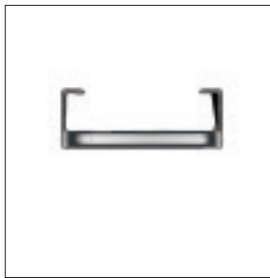

545017
545017-300 Dimmable Dali
 T16 14W G5
 Electronic ballast

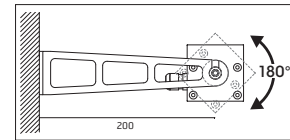
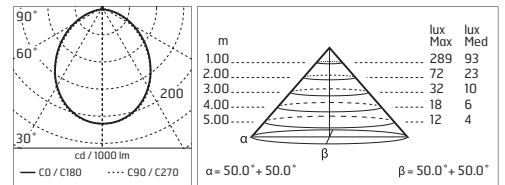
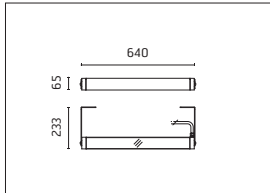

IP65

Arcadia640 - With Brackets L 200mm - Transparent Glass - Adjustable



545016
545016-300 Dimmable Dali
 T16 14W G5
 Electronic ballast

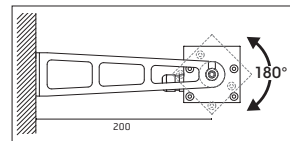
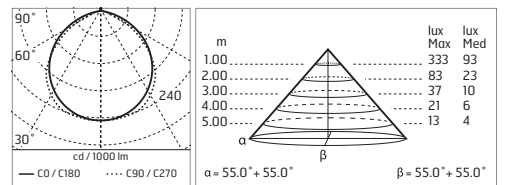
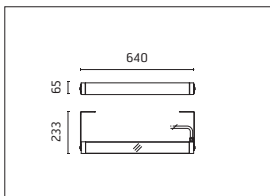

IP65

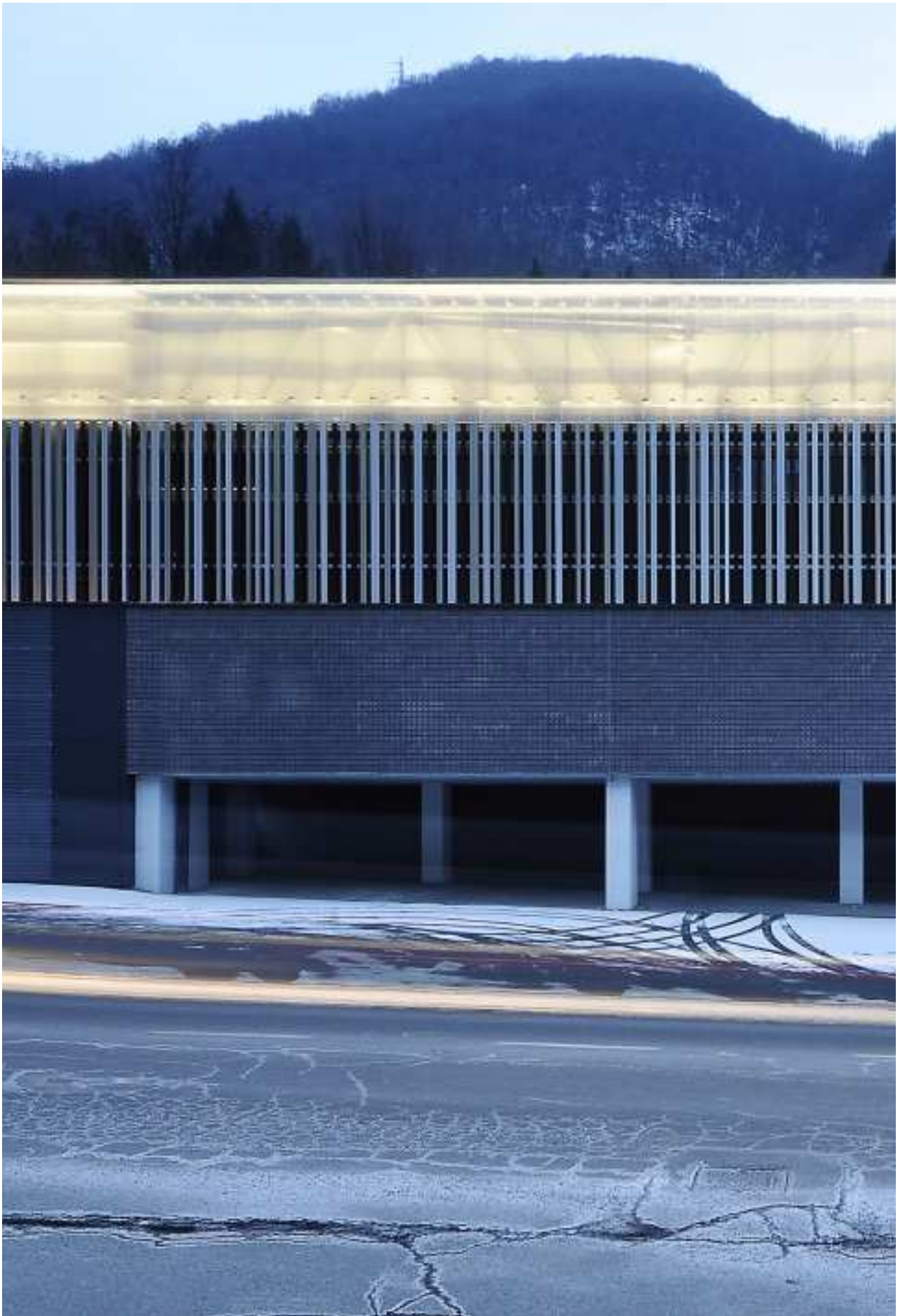



Arcadia940 - With Brackets L 80mm - Transparent Glass - Adjustable - 10°

Light Source: Power LED / 19,8W / Total power 24W / CRI>80 / 220÷240V / Integral electronic power supply



545078
545078-300 Dimmable Dali
545078-310 Dimmable 1-10
 White 2700K
 lm LED 2009 ≈ lm OUTPUT 1833

545021
545021-300 Dimmable Dali
545021-310 Dimmable 1-10
 White 3000K
 lm LED 2160 ≈ lm OUTPUT 1971

545020
545020-300 Dimmable Dali
545020-310 Dimmable 1-10
 White 4000K
 lm LED 2340 ≈ lm OUTPUT 2135

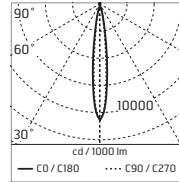
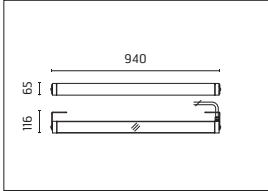

m	lux	
	Max	Med
1.00	2282514639	
2.00	5706 3660	
3.00	2536 1627	
4.00	1427 915	
5.00	913 586	

$\alpha = 6.0^\circ + 6.0^\circ$ $\beta = 6.0^\circ + 6.0^\circ$

@4000K

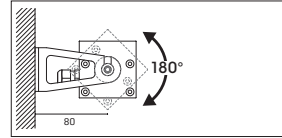

IP65

Arcadia940 - With Brackets L 80mm - Transparent Glass - Adjustable - 40°

Light Source: Power LED / 19,8W / Total power 24W / CRI>80 / 220÷240V / Integral electronic power supply



545080
545080-300 Dimmable Dali
545080-310 Dimmable 1-10
 White 2700K
 lm LED 2009 ≈ lm OUTPUT 1605

545024
545024-300 Dimmable Dali
545024-310 Dimmable 1-10
 White 3000K
 lm LED 1440 ≈ lm OUTPUT 1151

545023
545023-300 Dimmable Dali
545023-310 Dimmable 1-10
 White 4000K
 lm LED 1560 ≈ lm OUTPUT 1247

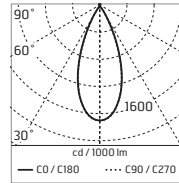
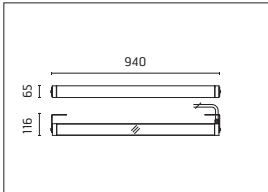

m	lux	
	Max	Med
1.00	3183 1900	
2.00	796 475	
3.00	354 211	
4.00	199 119	
5.00	127 76	

$\alpha = 21.0^\circ + 21.0^\circ$ $\beta = 21.0^\circ + 21.0^\circ$

@4000K

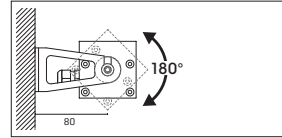

IP65

Arcadia940 - With Brackets L 80mm - Sandblasted Glass - Adjustable

Light Source: RGB Power LED / 30,6W / Total power 38W / 230V / with DMX-RDM interface

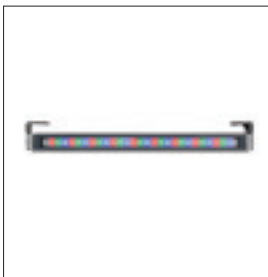

545104

Wiring diagram and installation scheme RGB

>> See Page 561
 Wiring Diagram n.8

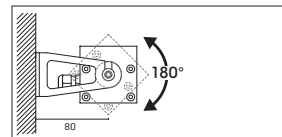
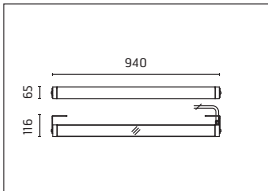

IP65

Arcadia940 - With Brackets L 80mm - Sandblasted Glass - Adjustable



545026
545026-300 Dimmable Dali
 T16 21W G5
 Electronic ballast

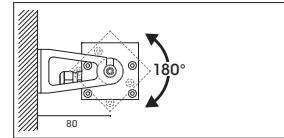
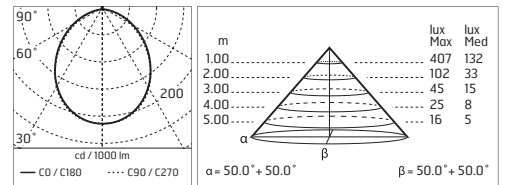
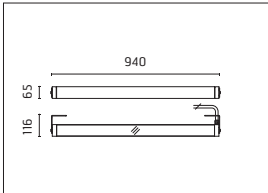

IP65

Arcadia940 / With Brackets L 80mm - Transparent Glass - Adjustable

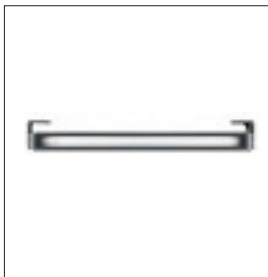

545025
545025-300 Dimmable Dali
 T16 21W G5
 Electronic ballast

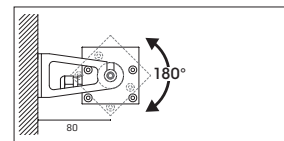
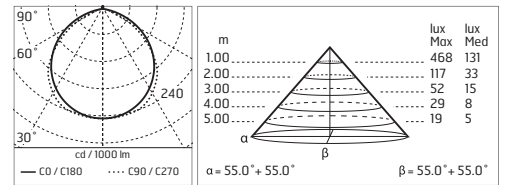
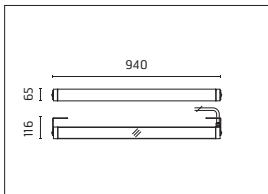

IP65

Arcadia940 - With Brackets L 200mm - Transparent Glass - Adjustable - 10°

Light Source: Power LED / 19,8W / Total power 24W / CRI>80 / 220÷240V / Integral electronic power supply



545082
545082-300 Dimmable Dali
545082-310 Dimmable 1-10
 White 2700K
 lm LED 2009 ≈ lm OUTPUT 1833

545030
545030-300 Dimmable Dali
545030-310 Dimmable 1-10
 White 3000K
 lm LED 2160 ≈ lm OUTPUT 1971

545029
545029-300 Dimmable Dali
545029-310 Dimmable 1-10
 White 4000K
 lm LED 2340 ≈ lm OUTPUT 2135

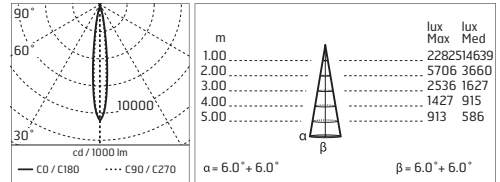

@4000K

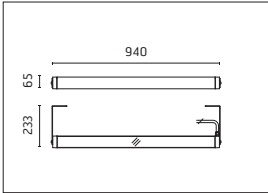
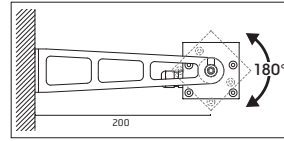

IP65

Arcadia940 - With Brackets L 200mm - Transparent Glass - Adjustable - 40°

Light Source: Power LED / 19,8W / Total power 24W / CRI>80 / 220÷240V / Integral electronic power supply



545084
545084-300 Dimmable Dali
545084-310 Dimmable 1-10
 White 2700K
 lm LED 2009 ≈ lm OUTPUT 1605

545033
545033-300 Dimmable Dali
545033-310 Dimmable 1-10
 White 3000K
 lm LED 2160 ≈ lm OUTPUT 1726

545032
545032-300 Dimmable Dali
545032-310 Dimmable 1-10
 White 4000K
 lm LED 2340 ≈ lm OUTPUT 1871

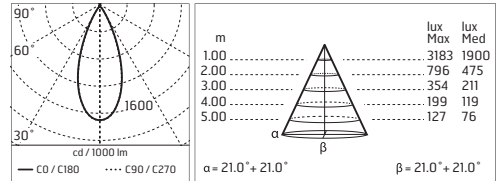

@4000K

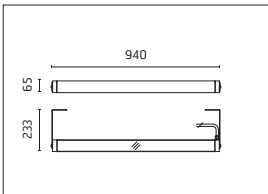
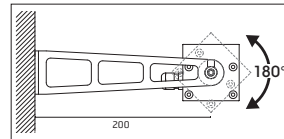

IP65

Arcadia940 - With Brackets L 200mm - Sandblasted Glass - Adjustable

Light Source: RGB Power LED / 30,6W / Total power 38W / 230V / with DMX-RDM interface

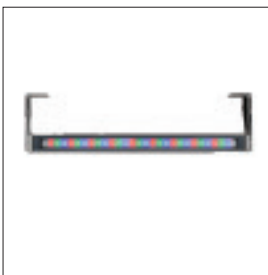

545106

Wiring diagram and installation scheme RGB

>> See Page 561
 Wiring Diagram n.8

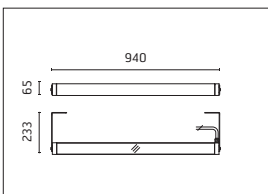
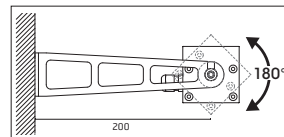

IP65

Arcadia940 - With Brackets L 200mm - Sandblasted Glass - Adjustable



545035
545035-300 Dimmable Dali
 T16 21W G5
 Electronic ballast

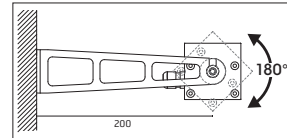
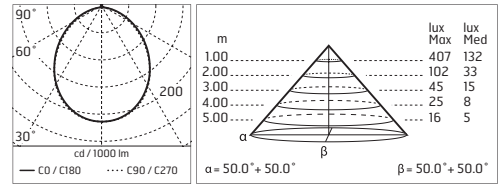
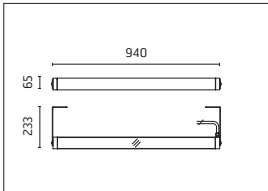

IP65

Arcadia940 - With Brackets L 200mm - Transparent Glass - Adjustable



545034
545034-300 Dimmable Dali
 T16 21W G5
 Electronic ballast

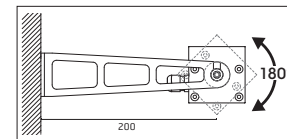
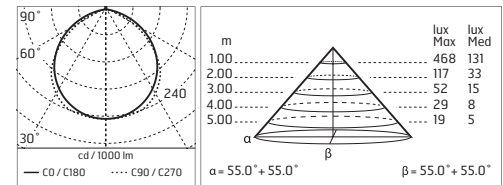
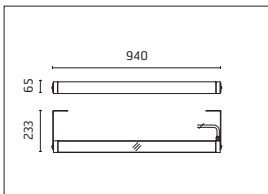

IP65



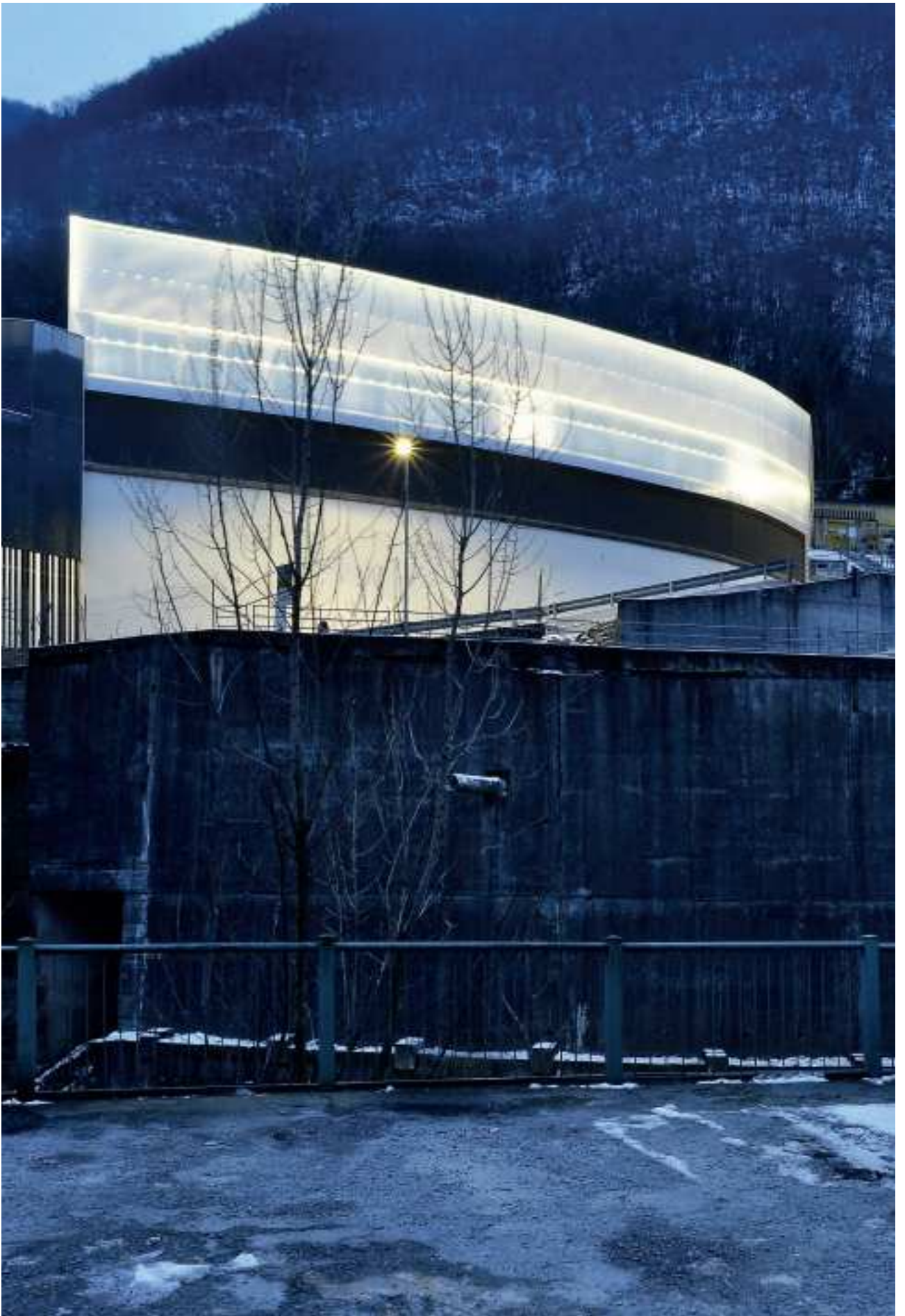

Arcadia1240 - With Brackets L 80mm - Transparent Glass - Adjustable - 10°

Light Source: Power LED / 26,4W / Total power 32W / CRI>80 / 220÷240V / Integral electronic power supply



545086
545086-300 Dimmable Dali
545086-310 Dimmable 1-10
 White 2700K
 lm LED 2678 ≈ lm OUTPUT 2444

545039
545039-300 Dimmable Dali
545039-310 Dimmable 1-10
 White 3000K
 lm LED 2880 ≈ lm OUTPUT 2628

545038
545038-300 Dimmable Dali
545038-310 Dimmable 1-10
 White 4000K
 lm LED 3120 ≈ lm OUTPUT 2847

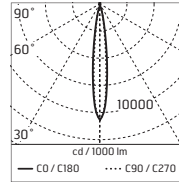

m	lux	
	Max	Med
1.00	30437	19521
2.00	7609	4880
3.00	3382	2169
4.00	1902	1220
5.00	1217	781

$\alpha = 6.0^\circ + 6.0^\circ$ $\beta = 6.0^\circ + 6.0^\circ$

@4000K

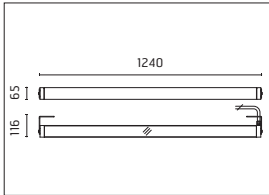
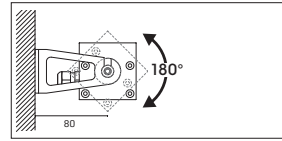

IP65

Arcadia1240 - With Brackets L 80mm - Transparent Glass - Adjustable - 40°

Light Source: Power LED / 26,4W / Total power 32W / CRI>80 / 220÷240V / Integral electronic power supply



545088
545088-300 Dimmable Dali
545088-310 Dimmable 1-10
 White 2700K
 lm LED 2678 ≈ lm OUTPUT 2142

545042
545042-300 Dimmable Dali
545042-310 Dimmable 1-10
 White 3000K
 lm LED 2880 ≈ lm OUTPUT 2303

545041
545041-300 Dimmable Dali
545041-310 Dimmable 1-10
 White 4000K
 lm LED 3120 ≈ lm OUTPUT 2495

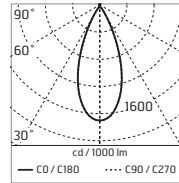

m	lux	
	Max	Med
1.00	4244	2533
2.00	1061	633
3.00	472	281
4.00	265	158
5.00	170	101

$\alpha = 21.0^\circ + 21.0^\circ$ $\beta = 21.0^\circ + 21.0^\circ$

@4000K

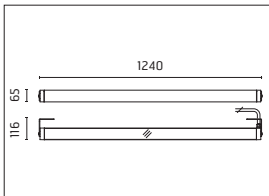
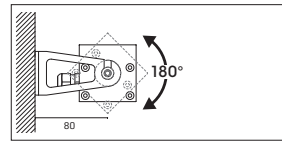

IP65

Arcadia1240 - With Brackets L 80mm - Sandblasted Glass - Adjustable

Light Source: RGB Power LED / 40,8W / Total power 48W / 230V / with DMX-RDM interface

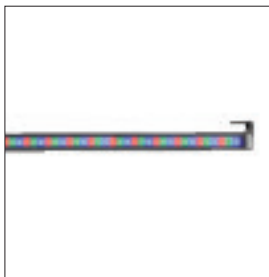

545108

Wiring diagram and installation scheme RGB

>> See Page 561
 Wiring Diagram n.8

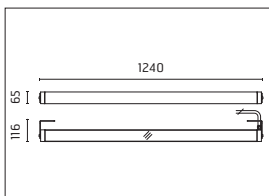
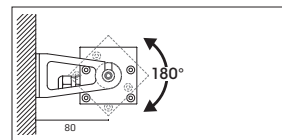

IP65

Arcadia1240 - With Brackets L 80mm - Sandblasted Glass - Adjustable

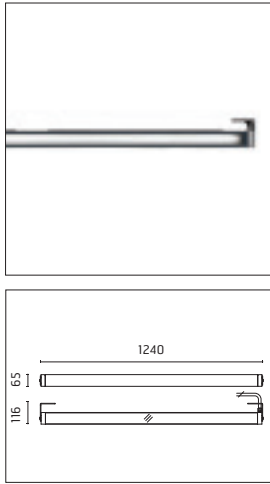

545044
545044-300 Dimmable Dali
 T16 28W G5
 Electronic ballast

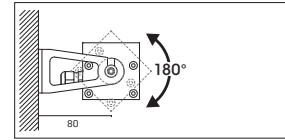
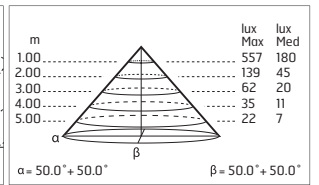
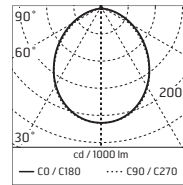

IP65

Arcadia1240 - With Brackets L 80mm - Transparent Glass - Adjustable

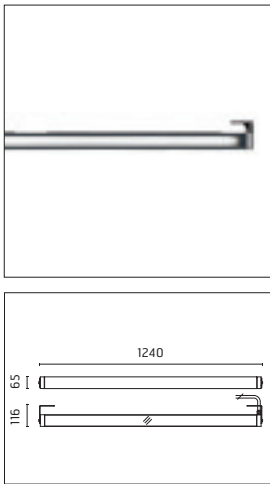

545043
545043-300 Dimmable Dali
 T16 28W G5
 Electronic ballast

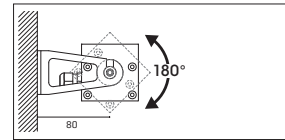
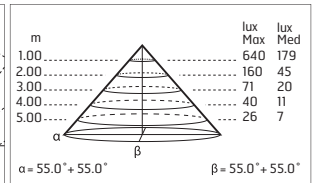
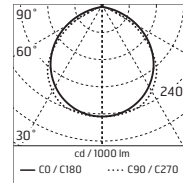

IP65

Arcadia1240 - With Brackets L 200mm - Transparent Glass - Adjustable - 10°

Light Source: Power LED / 26,4W / Total power 32W / CRI>80 / 220÷240V / Integral electronic power supply



545090
545090-300 Dimmable Dali
545090-310 Dimmable 1-10
 White 2700K
 lm LED 2678 ≈ lm OUTPUT 2444

545048
545048-300 Dimmable Dali
545048-310 Dimmable 1-10
 White 3000K
 lm LED 2880 ≈ lm OUTPUT 2628

545047
545047-300 Dimmable Dali
545047-310 Dimmable 1-10
 White 4000K
 lm LED 3120 ≈ lm OUTPUT 2847

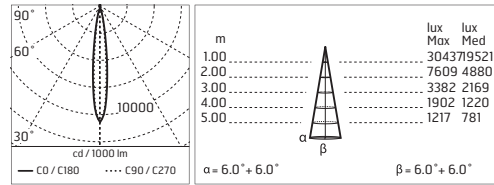

@4000K

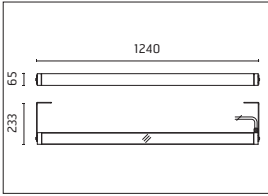
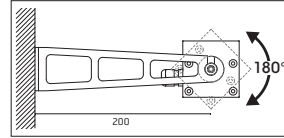

IP65

Arcadia1240 - With Brackets L 200mm - Transparent Glass - Adjustable - 40°

Light Source: Power LED / 26,4W / Total power 32W / CRI>80 / 220÷240V / Integral electronic power supply



545092
545092-300 Dimmable Dali
545092-310 Dimmable 1-10
 White 2700K
 lm LED 2678 ≈ lm OUTPUT 2142

545051
545051-300 Dimmable Dali
545051-310 Dimmable 1-10
 White 3000K
 lm LED 2880 ≈ lm OUTPUT 2303

545050
545050-300 Dimmable Dali
545050-310 Dimmable 1-10
 White 4000K
 lm LED 3120 ≈ lm OUTPUT 2495

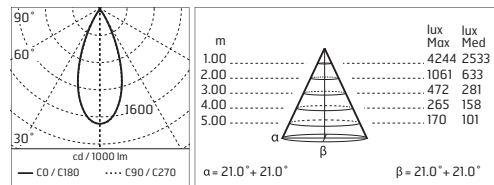

@4000K

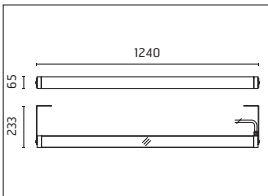
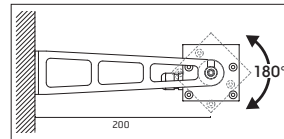

IP65

Arcadia1240 - With Brackets L 200mm - Sandblasted Glass - Adjustable

Light Source: RGB Power LED / 40,8W / Total power 48W / 230V / with DMX-RDM interface

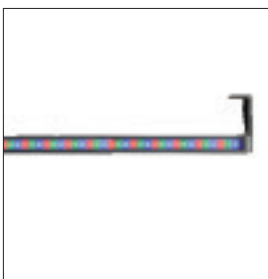

545110

Wiring diagram and installation scheme RGB

>> See Page 561
 Wiring Diagram n.8

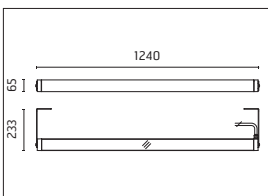
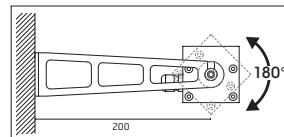

IP65

Arcadia1240 - With Brackets L 200mm - Sandblasted Glass - Adjustable



545053
545053-300 Dimmable Dali
 T16 28W G5
 Electronic ballast

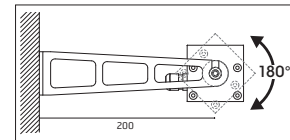
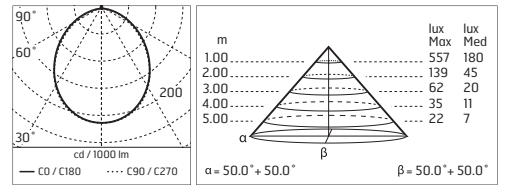
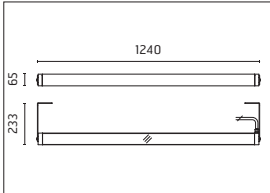

IP65

Arcadia1240 - With Brackets L 200mm - Transparent Glass - Adjustable



545052
545052-300 Dimmable Dali
 T16 28W G5
 Electronic ballast

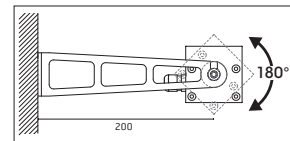
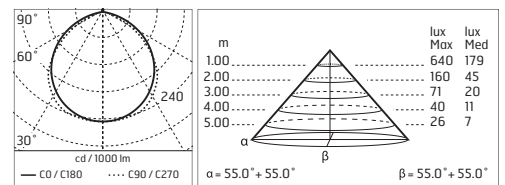
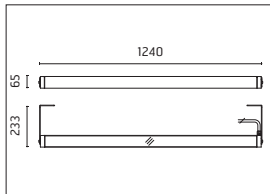

IP65





Accessories: Arcadia

215
3/4 WAY TERMINAL BLOCK 4 POLES
IP68 H₂O STOP (Ø5,5±12mm CABLE)

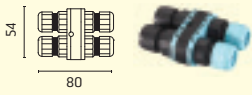

236
2 WAY TERMINAL BLOCK 4 POLES
IP68 H₂O STOP (Ø5,5±12mm CABLE)



142
DMX CONTROLLER;
DIMMER SWITCH FOR RECESSED BOX
(60mm HOLE CENTRES)



143
DMX CONTROLLER;
STAND-ALONE/PC INTERFACE

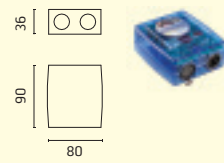

186
DMX CABLE - SHIELDED TWISTED PAIR
WITH 110 Ohm CONSTANT IMPEDANCE.



187
DMX SPLITTER 512 - ELECTRONIC DEVICE
TO REGENERATE THE MONODIRECTIONAL
DMX SIGNAL
1 INPUT AND 7 OUTPUT, 12-24V dc

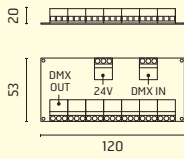

237
SPD: (SURGE PROTECTION DEVICE)
275Vac
MAXIMUM DISCHARGE CURRENT
10KA (8/20µs)
MAXIMUM OPERATING CURRENT 5A
SUITABLE FOR SERIES CONNEC-
TION - IP66

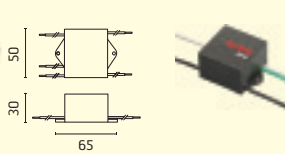

**POWER SUPPLY TO BE ORDERED (87 OR
175 RECOMMENDED)**

Accessories: Arcadia

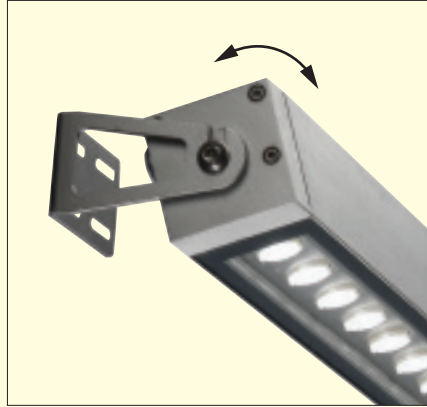
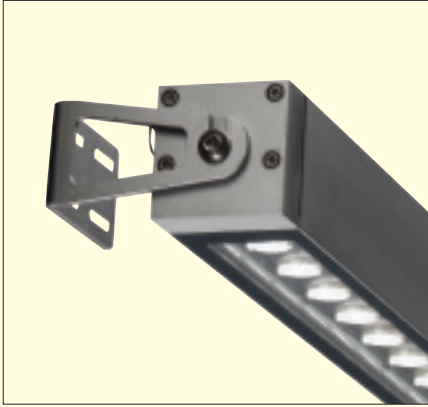

acc. code ▶ prod. code ▼	dimmi DALI	dimmi 1-10	215	236	142	143	186	187	237
545002	-300	-310	•	•					•
545003	-300	-310	•	•					•
545005	-300	-310	•	•					•
545006	-300	-310	•	•					•
545007	-300		•	•					
545008	-300		•	•					
545100					•	•	•	•	
545011	-300	-310	•	•					•
545012	-300	-310	•	•					•
545014	-300	-310	•	•					•
545015	-300	-310	•	•					•
545016	-300		•	•					
545017	-300		•	•					
545102					•	•	•	•	
545020	-300	-310	•	•					•
545021	-300	-310	•	•					•
545023	-300	-310	•	•					•
545024	-300	-310	•	•					•
545025	-300		•	•					
545026	-300		•	•					
545104					•	•	•	•	
545029	-300	-310	•	•					•
545030	-300	-310	•	•					•
545032	-300	-310	•	•					•
545033	-300	-310	•	•					•
545034	-300		•	•					
545035	-300		•	•					

acc. code ▶ prod. code ▼	dimmi DALI	dimmi 1-10	215	236	142	143	186	187	237
545106					•	•	•	•	
545038	-300	-310	•	•					•
545039	-300	-310	•	•					•
545041	-300	-310	•	•					•
545042	-300	-310	•	•					•
545043	-300		•	•					
545044	-300		•	•					
545108					•	•	•	•	
545047	-300	-310	•	•					•
545048	-300	-310	•	•					•
545050	-300	-310	•	•					•
545051	-300	-310	•	•					•
545052	-300		•	•					
545053	-300		•	•					
545110					•	•	•	•	
545070	-300	-310	•	•					•
545072	-300	-310	•	•					•
545074	-300	-310	•	•					•
545076	-300	-310	•	•					•
545078	-300	-310	•	•					•
545080	-300	-310	•	•					•
545082	-300	-310	•	•					•
545084	-300	-310	•	•					•
545086	-300	-310	•	•					•
545088	-300	-310	•	•					•
545090	-300	-310	•	•					•
545092	-300	-310	•	•					•

Max fixtures for each power supply (Vin 220+240). Data in the chart are provided as a guide only. Please verify according to your installation.



- Light for installation on wall or ceiling – surface mounted.
- Configuration: polycarbonate tube, opal or transparent, with anti-UV filter. Polycarbonate fixing brackets and anodized aluminium closing caps.
- Protection Rating: IP65
- In compliance with EN 60598-1 standards
- Class of insulation: III
- Installation: the luminaire is supplied with a screw connector and requires the use of a feeding cable (direct to power supply or for end-to-end connection) to be ordered separately. Parallel wiring required. Maximum end-to-end sequence: 5000mm.
- During the installation and the maintenance of the fixtures it is important to be careful and avoid damages on the paint coating.

Damages on the coating exposed to outdoor conditions or water, could cause corrosion.

Chemical substances affect the anticorrosion covering protection.

EU Regulation 874/2012 - Illumination equipment energy classes



LED VERSION:
Class A/A+/A++
Luminaire supplied with integrated LED modules that cannot be replaced



Ceiling fitting



Wall fitting



Protection against water ingress from the cable



Installation requires a feeding cable (acc. code 172 or 173, 174)



Remote device required.



Protection against impact. IK 06 - 1,00 joule

Tau - L. 354 - Transparent Diffuser

Light Source: Low-Power LED / 3W / Total power 3W / CRI>80 / 24Vdc / Remote electronic power supply and supply cable to be ordered



523003
White 3000K
lm LED 255 \approx lm OUTPUT 231
Acc. 144, 176 or 252

523002
White 4000K
lm LED 255 \approx lm OUTPUT 231
Acc. 144, 176 or 252

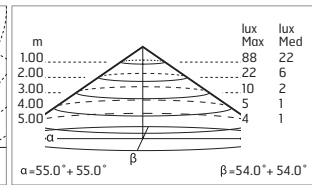
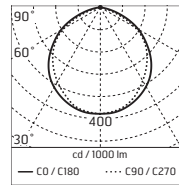

@4000K

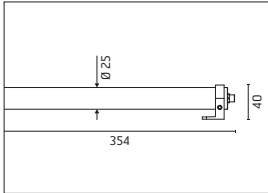

IP65

Tau - L. 354 - Opal Diffuser

Light Source: Low-Power LED / 3W / Total power 3W / CRI>80 / 24Vdc / Remote electronic power supply and supply cable to be ordered



523013
White 3000K
lm LED 255 \approx lm OUTPUT 118
Acc. 144, 176 or 252

523012
White 4000K
lm LED 255 \approx lm OUTPUT 118
Acc. 144, 176 or 252

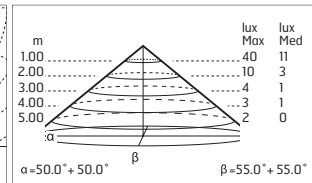
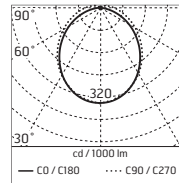

@4000K

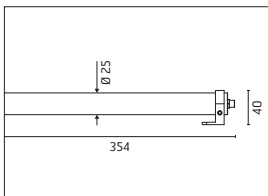

IP65

Tau - L. 554 - Transparent Diffuser

Light Source: Low-Power LED / 5W / Total power 5W / CRI>80 / 24Vdc / Remote electronic power supply and supply cable to be ordered



523023
White 3000K
lm LED 420 \approx lm OUTPUT 384
Acc. 144, 176 or 252

523022
White 4000K
lm LED 420 \approx lm OUTPUT 384
Acc. 144, 176 or 252

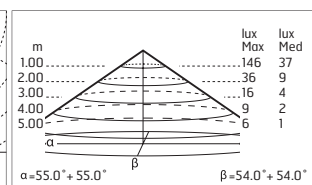
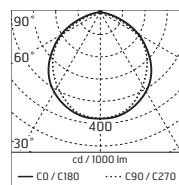

@4000K

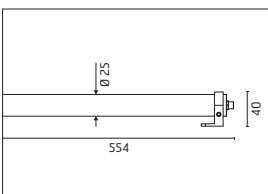

IP65

Tau - L. 554 - Opal Diffuser

Light Source: Low-Power LED / 5W / Total power 5W / CRI>80 / 24Vdc / Remote electronic power supply and supply cable to be ordered



523033
White 3000K
lm LED 420 \approx lm OUTPUT 196
Acc. 144, 176 or 252

523032
White 4000K
lm LED 420 \approx lm OUTPUT 196
Acc. 144, 176 or 252

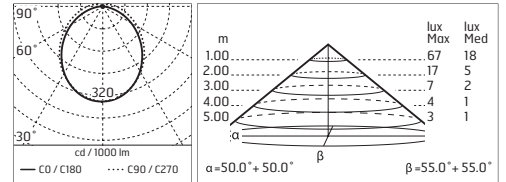
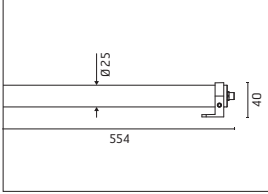

@4000K

IP65

Tau - L. 1054 - Transparent Diffuser

Light Source: Low-Power LED / 10W / Total power 10W / CRI>80 / 24Vdc / Remote electronic power supply and supply cable to be ordered



523043
White 3000K
lm LED 840 \approx lm OUTPUT 768
Acc. 144, 176 or 252

523042
White 4000K
lm LED 840 \approx lm OUTPUT 768
Acc. 144, 176 or 252

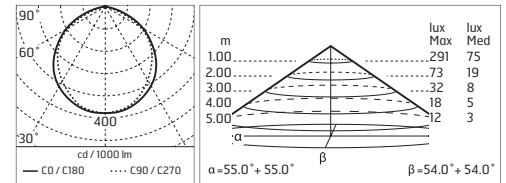
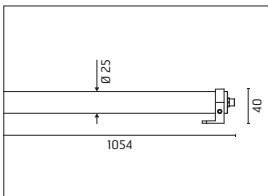

@4000K

IP65

Tau - L. 1054 - Opal Diffuser

Light Source: Low-Power LED / 10W / Total power 10W / CRI>80 / 24Vdc / Remote electronic power supply and supply cable to be ordered



523053
White 3000K
lm LED 840 \approx lm OUTPUT 392
Acc. 144, 176 or 252

523052
White 4000K
lm LED 840 \approx lm OUTPUT 392
Acc. 144, 176 or 252

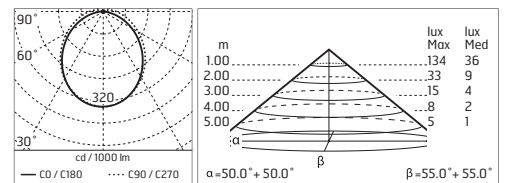
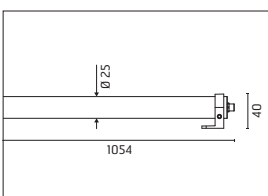

@4000K

IP65

Tau - L. 1554 - Transparent Diffuser

Light Source: Low-Power LED / 15W / Total power 15W / CRI>80 / 24Vdc / Remote electronic power supply and supply cable to be ordered



523063
White 3000K
lm LED 1260 \approx lm OUTPUT 1152
Acc. 144, 176 or 252

523062
White 4000K
lm LED 1260 \approx lm OUTPUT 1152
Acc. 144, 176 or 252

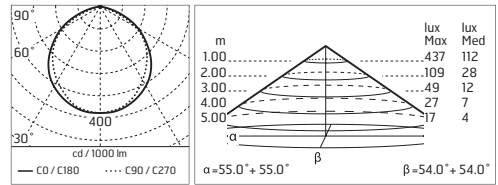

@4000K

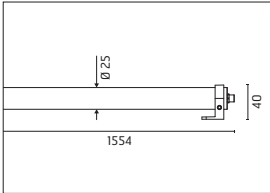

IP65

Tau - L. 1554 - Opal Diffuser

Light Source: Low-Power LED / 15W / Total power 15W / CRI>80 / 24Vdc / Remote electronic power supply and supply cable to be ordered



523073
White 3000K
lm LED 1260 \approx lm OUTPUT 589
Acc. 144, 176 or 252

523072
White 4000K
lm LED 1260 \approx lm OUTPUT 589
Acc. 144, 176 or 252

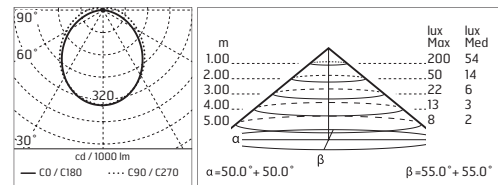

@4000K

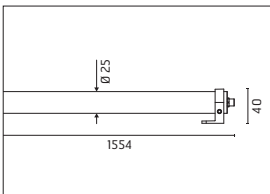

IP65



Accessories: Tau

172
SUPPLY CABLE L.2000mm
SINGLE CONNECTOR

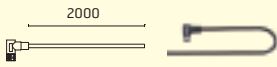

173
SUPPLY CABLE L.80mm
DOUBLE CONNECTOR

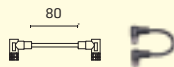

174
SUPPLY CABLE L.200mm
DOUBLE CONNECTOR

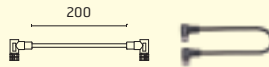

150
POWER SUPPLY DUAL FUNCTION
Vout 24Vdc: 8W/100÷240V
Iout 350mA: 6x1W/100÷240V
IP20 CLASS II SELV EQ.

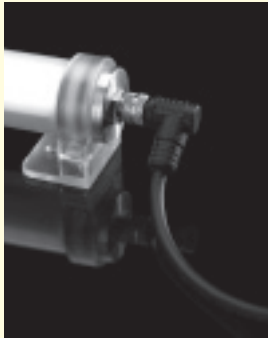
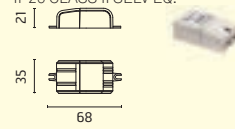

106
POWER SUPPLY DUAL FUNCTION
Vout 24Vdc: 8W/100÷240V
Iout 350mA: 6x1W/100÷240V
IP65 CLASS II SELV EQ.

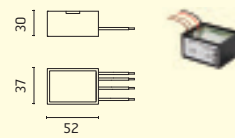

87
POWER SUPPLY 10W/110÷240V -
24Vdc IP20 CLASS II SELV.

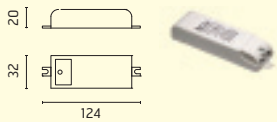

175
POWER SUPPLY 10W/110÷240V -
24Vdc IP67 CLASS II SELV.

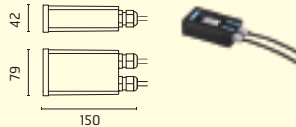

144
POWER SUPPLY 17W/110÷240V -
24Vdc (15W@110V) IP20 CLASS II
SELV.

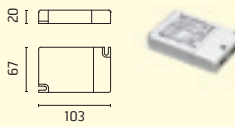

176
POWER SUPPLY 17W/110÷240V -
24Vdc (15W@110V) IP67 CLASS II
SELV.

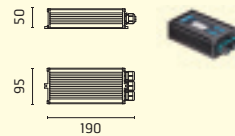

... DIMMABLE: PUSH-DIM OR 1...10V
See Page 558 Wiring Diagram n.4

... DIMMABLE: PUSH-DIM OR 1...10V
See Page 558 Wiring Diagram n.4

252
POWER SUPPLY 20W/110-240Vdc
(15W@110V) IP67 CLASS II SELV.

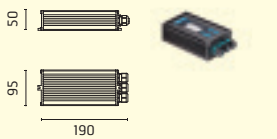

147
POWER SUPPLY 20W/220÷240V -
24Vdc IP67 CLASS II SELV.

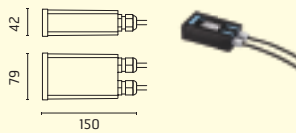

155
POWER SUPPLY 50W/120÷240V -
24Vdc IP67 CLASS II SELV.

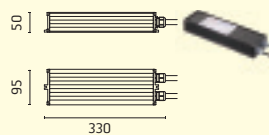

110
POWER SUPPLY 70W/220÷240V -
24Vdc IP67 CLASS II SELV EQ.

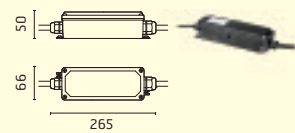

... DIMMABLE: DALI
See Page 558 Wiring Diagram n.4

156
POWER SUPPLY 96W /120÷277V -
24Vdc IP67 CLASS II SELV.

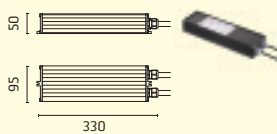

Example of configuration

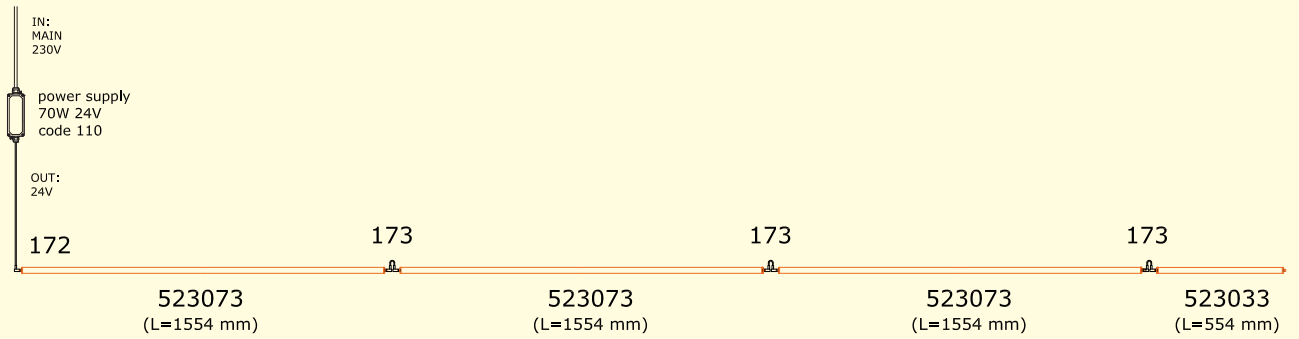

MAX LENGTH IN CONTINUOUS 5mt

acc. code ▶	172	173	174	150	106	87	175	144	176	252	147	155	110	156
prod. code ▼														
523002	•	•	•	2	2	3	3	5	5	5	6	16	22	30
523003	•	•	•	2	2	3	3	5	5	5	6	16	22	30
523012	•	•	•	2	2	3	3	5	5	5	6	16	22	30
523013	•	•	•	2	2	3	3	5	5	5	6	16	22	30
523022	•	•	•	1	1	2	2	3	3	3	4	10	14	18
523023	•	•	•	1	1	2	2	3	3	3	4	10	14	18
523032	•	•	•	1	1	2	2	3	3	3	4	10	14	18
523033	•	•	•	1	1	2	2	3	3	3	4	10	14	18
523042	•	•	•					1	1	1	2	5	7	9
523043	•	•	•					1	1	1	2	5	7	9
523052	•	•	•					1	1	1	2	5	7	9
523053	•	•	•					1	1	1	2	5	7	9
523062	•	•	•					1	1	1	1	3	4	6
523063	•	•	•					1	1	1	1	3	4	6
523072	•	•	•					1	1	1	1	3	4	6
523073	•	•	•					1	1	1	1	3	4	6

Max fixtures for each power supply (Vin 220÷240). Data in the chart are provided as a guide only. Please verify according to your installation.



LEO 80

- Luminaire for installation on wall – surface mounted.
- Configuration: die-cast aluminium structure, EN AB-47100 alloy (low copper content). Diffuser: transparent glass or lens with silkscreen border.
- Double layer coating for high resistance to corrosion: the aluminium components are painted with a double coat using powders that are compliant with QUALICOAT standards: a first layer of epoxy powder (with excellent chemical and mechanical resistance) and a second finishing layer of polyester powder (resistant to UV rays and atmospheric agents). The entire painting process of the aluminium fitting starts from components that have been sandblasted in advance to make the surface more porous and increase the adherence of the paint. Ares effects alkaline and acid washing to clean the surfaces completely, then rinses with demineralised water to remove any residue particles, subsequently a chemical conversion treatment is done to protect against rusting.
- Protection rating: IP65
- In compliance with EN 60598-1 standards
- Class of insulation: I
- Installation: wiring through a cable holder (5mm\times9mm cable). Outdoor use requires suitable flexible cables assuring the watertightness of the cable holder. For watertightness to be assured the use of a multicore cable is mandatory, the use of single unipolar cables is not allowed.
- During the installation and the maintenance of the fixtures it is important to be careful and avoid damages on the paint coating.
Damages on the coating exposed to outdoor conditions or water, could cause corrosion.
Chemical substances affect the anticorrosion covering protection.

EU Regulation 874/2012 - Illumination equipment energy classes

A++
A+
A
D

LED VERSION::
Class A/A+/A++
Luminaire supplied with integrated LED modules that cannot be replaced

HALOGEN VERSION:
Class D
QT14/G9



Wall fitting



The fitting is equipped with 1 cable input



Protection against impact.
IK 07 - 2,00 joule

Leo80 - Unidirectional - 3° - Convex Lens

Light Source: Power LED / 1,1W / Total power 2,5W / CRI>80 / 100±240V / Integral electronic power supply

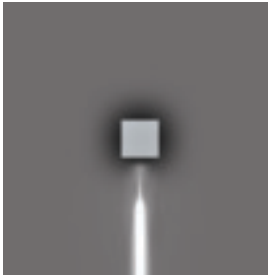

12313643
White 2700K
lm LED 129 ≠ lm OUTPUT 22



12311643
White 3000K
lm LED 4003 ≠ lm OUTPUT 3168

12316343
White 4000K
lm LED 4262 ≠ lm OUTPUT 3374

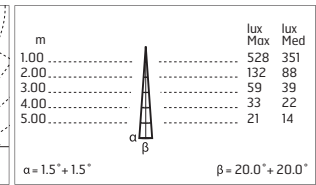
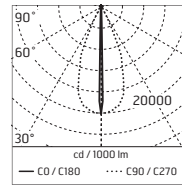

@4000K

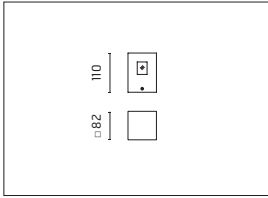

IP65

Leo80 - Unidirectional - 40°

Light Source: Power LED / 1,1W / Total power 2,5W / CRI>80 / 100±240V / Integral electronic power supply



12313650
White 2700K
lm LED 129 ≠ lm OUTPUT 24



12311650
White 3000K
lm LED 139 ≠ lm OUTPUT 26

12316450
White 4000K
lm LED 148 ≠ lm OUTPUT 28

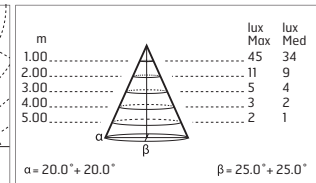
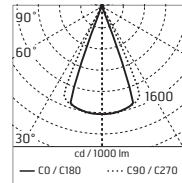

@4000K

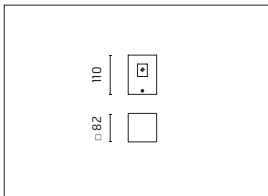

IP65

Leo80 - Bidirectional - 40°

Light Source: Power LED / 2,2W / Total power 4W / CRI>80 / 100±240V / Integral electronic power supply

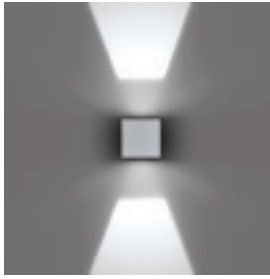

12313951
White 2700K
lm LED 2x129 ≠ lm OUTPUT 2x24

12311951
White 3000K
lm LED 2x139 ≠ lm OUTPUT 2x26

12316451
White 4000K
lm LED 2x148 ≠ lm OUTPUT 2x28

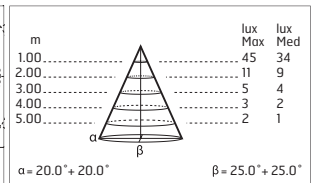
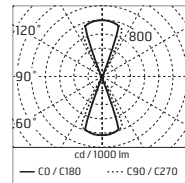

@4000K

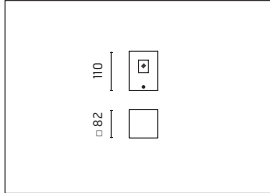

IP65

Leo80 - Bidirectional - Combined: 3° (Convex Lens) + 40°

Light Source: Power LED / 2,2W / Total power 4W / CRI>80 / 100±240V / Integral electronic power supply

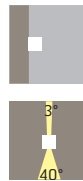

12313253
White 2700K
lm LED 2x129 ≠ lm OUTPUT 2x22+24

12312253
White 3000K
lm LED 2x139 ≠ lm OUTPUT 24+26

12316453
White 4000K
lm LED 2x148 ≠ lm OUTPUT 26+28

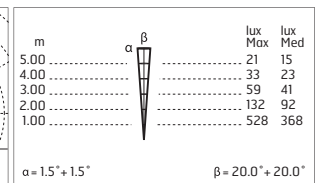
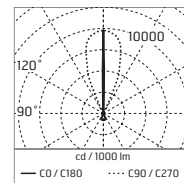

@4000K

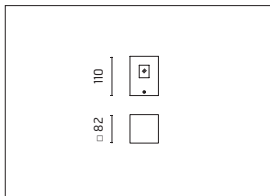

IP65



Accessories: Leo80

237

SPD: (SURGE PROTECTION DEVICE)
 275Vac
 MAXIMUM DISCHARGE CURRENT
 10KA (8/20µs)
 MAXIMUM OPERATING CURRENT 5A
 SUITABLE FOR SERIES CONNEC-
 TION - IP66

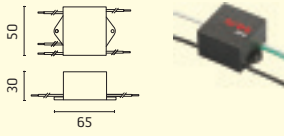

acc. code ▶	237
prod. code ▼	
1232743	
1232744	
1232745	
1232750	
1232751	
1232752	
1232753	
12311643	•
12311650	•
12311951	•
12312253	•
12313253	•
12313643	•
12313650	•
12313951	•
12316343	•
12316450	•
12316451	•
12316453	•



- Luminaire for installation on wall – surface mounted.
- Configuration: die-cast aluminium structure, EN AB-47100 alloy (low copper content). Diffuser: lens or transparent or sandblasted glass fixed to the structure through a robotic gluing system.
- Double layer coating for high resistance to corrosion: the aluminium components are painted with a double coat using powders that are compliant with QUALICOAT standards: a first layer of epoxy powder (with excellent chemical and mechanical resistance) and a second finishing layer of polyester powder (resistant to UV rays and atmospheric agents). The entire painting process of the aluminium fitting starts from components that have been sandblasted in advance to make the surface more porous and increase the adherence of the paint. Ares effects alkaline and acid washing to clean the surfaces completely, then rinses with demineralised water to remove any residue particles, subsequently a chemical conversion treatment is done to protect against rusting.
- Protection rating: IP65
- In compliance with EN 60598-1 standards
- Class of insulation: I
- Installation: wiring through two cable holders (8mm<math><\varnothing</math><math><13\text{mm}</math> cables). Outdoor use requires suitable flexible cables assuring the watertightness of the cable holder. For watertightness to be assured the use of a multicore cable is mandatory, the use of single unipolar cables is not allowed.
- During the installation and the maintenance of the fixtures it is important to be careful and avoid damages on the paint coating.
Damages on the coating exposed to outdoor conditions or water, could cause corrosion.
Chemical substances affect the anticorrosion covering protection.

EU Regulation 874/2012 - Illumination equipment energy classes



LED VERSION::
Class A/A+/A++
Luminaire supplied with integrated LED modules that cannot be replaced



METAL HALIDE VERSION:
Class A/A+
HIT-TC-CE/G8,5



.1 White



.6 Grey



.3 Anthracite



.4 Black



.18 Deep Brown



Wall fitting



The fitting is equipped with 2 cable input

Protection against impact.
IK 05 - 7,00 joule

Leo120 - Unidirectional - 3° - Convex Lens

Light Source: Power LED / 4,4W / Total power 6W / CRI>80 / 220÷240V / Integral electronic power supply

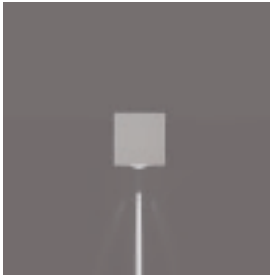

12314644
White 2700K
lm LED 442 ± lm OUTPUT 76



12316644
White 3000K
lm LED 475 ± lm OUTPUT 82

12316744
White 4000K
lm LED 510 ± lm OUTPUT 88

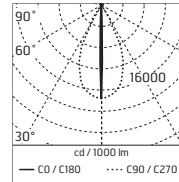

m	lux Max	lux Med
1.00	1514	956
2.00	379	239
3.00	168	106
4.00	95	60
5.00	61	38

$\alpha = 1.5^\circ + 1.5^\circ$ $\beta = 25.0^\circ + 25.0^\circ$

@4000K

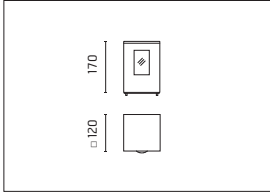

IP65

Leo120 - Unidirectional - 4° - Convex Lens

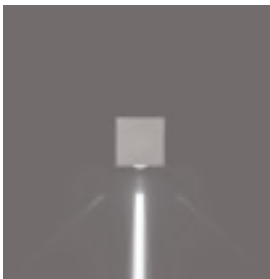

12316243
HIT-TC-CE 20W GU6,5
Electronic ballast

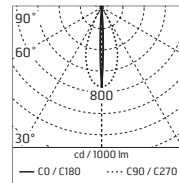

m	lux Max	lux Med
1.00	1353	681
2.00	338	170
3.00	150	76
4.00	85	43
5.00	54	27

$\alpha = 2.0^\circ + 2.0^\circ$ $\beta = 21.0^\circ + 21.0^\circ$

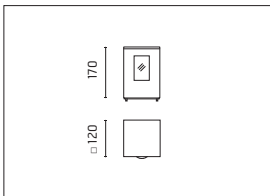

IP65

Leo120 - Unidirectional - 35°



12316250
HIT-TC-CE 20W GU6,5
Electronic ballast

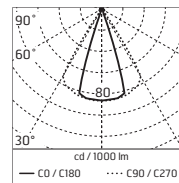

m	lux Max	lux Med
1.00	157	108
2.00	39	27
3.00	17	12
4.00	10	7
5.00	6	4

$\alpha = 17.0^\circ + 17.0^\circ$ $\beta = 32.0^\circ + 32.0^\circ$

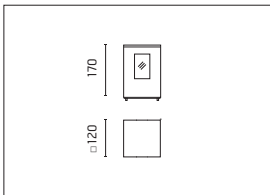

IP65

Leo120 0- Unidirectional - 65°

Light Source: Power LED / 4,4W / Total power 6W / CRI>80 / 220÷240V / Integral electronic power supply



12314652
White 2700K
lm LED 442 ≈ lm OUTPUT 208

12316652
White 3000K
lm LED 475 ≈ lm OUTPUT 224

12316752
White 4000K
lm LED 510 ≈ lm OUTPUT 241

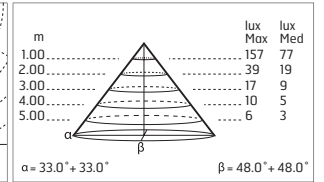
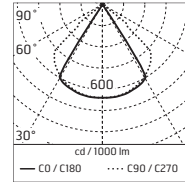
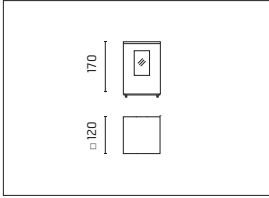

@4000K

IP65

Leo120 - Unidirectional - Sandblasted Glass



12316246
HIT-TC-CE 20W GU6,5
Electronic ballast

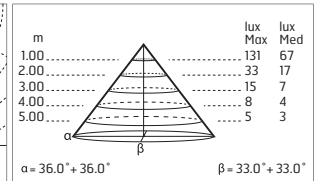
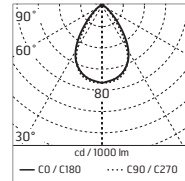
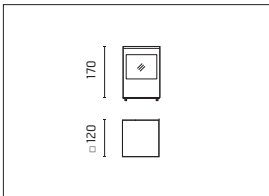

IP65

Leo120 - Bidirectional - Sandblasted Glass

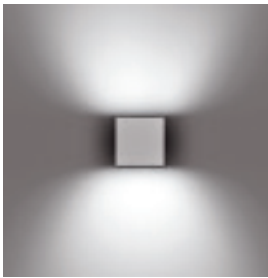

12316247
HIT-TC-CE 20W GU6,5
Electronic ballast

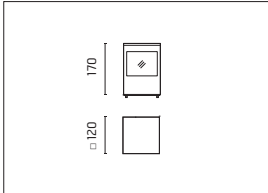
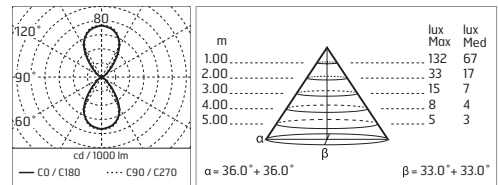

IP65

Leo120 - Bidirectional - Combined: 4° (Convex Lens) + 75°



12316254
HIT-TC-CE 20W GU6,5
Electronic ballast

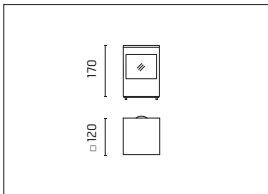
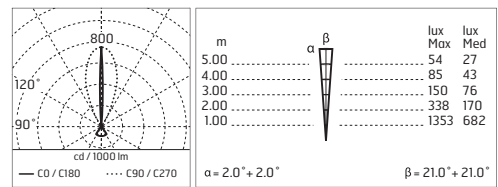

IP65



Leo120 - Omnidirectional - 4° - Convex Lens

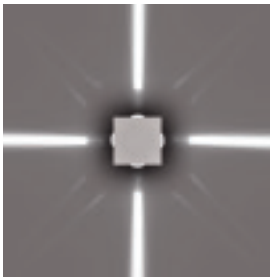

12316245
HIT-TC-CE 20W GU6,5
Electronic ballast

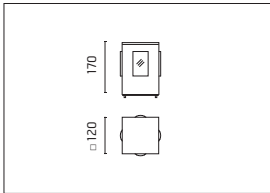
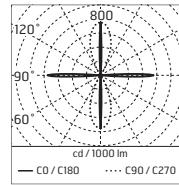

IP65

Leo120 - Omnidirectional - 35°

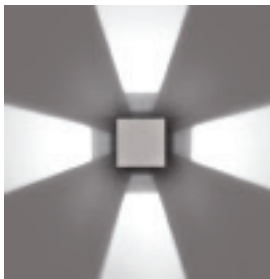

12316253
HIT-TC-CE 20W GU6,5
Electronic ballast

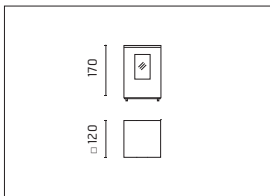
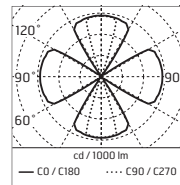

IP65

Leo120 - Omnidirectional - 65°

Light Source: Power LED / 17,6W / Total power 18,6W / CRI>80 / 220÷240V / Integral electronic power supply

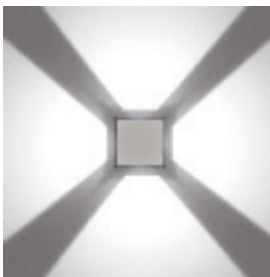

12314854
White 2700K
lm LED 4x442 ± lm OUTPUT 4x208

12316854
White 3000K
lm LED 4x475 ± lm OUTPUT 4x224

12317054
White 4000K
lm LED 4x510 ± lm OUTPUT 4x241

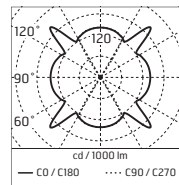

@4000K

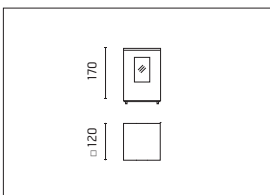

IP65

Leo120 - Omnidirectional - Sandblasted Glass

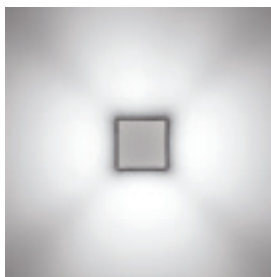

12316248
HIT-TC-CE 20W GU6,5
Electronic ballast

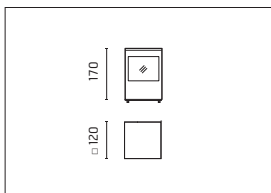
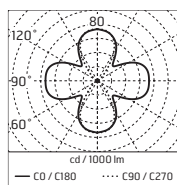

IP65   CE



LEO 120 ON POST

- Luminaire for installation on post – surface mounted.
- Configuration: die-cast aluminium structure, EN AB-47100 alloy (low copper content), extruded aluminium post. Glass diffuser: transparent or sandblasted fixed to the structure through a robotic gluing system.
- Double layer coating for high resistance to corrosion: the aluminium components are painted with a double coat using powders that are compliant with QUALICOAT standards: a first layer of epoxy powder (with excellent chemical and mechanical resistance) and a second finishing layer of polyester powder (resistant to UV rays and atmospheric agents). The entire painting process of the aluminium fitting starts from components that have been sandblasted in advance to make the surface more porous and increase the adherence of the paint. Ares effects alkaline and acid washing to clean the surfaces completely, then rinses with demineralised water to remove any residue particles, subsequently a chemical conversion treatment is done to protect against rusting.
- Protection rating: IP65
- In compliance with EN 60598-1 standards
- Class of insulation: I
- Installation: wiring through two cable holders (8mm\times13mm cables). Outdoor use requires suitable flexible cables assuring the watertightness of the cable holder. For watertightness to be assured the use of a multicore cable is mandatory, the use of single unipolar cables is not allowed.
- During the installation and the maintenance of the fixtures it is important to be careful and avoid damages on the paint coating. Damages on the coating exposed to outdoor conditions or water, could cause corrosion. Chemical substances affect the anticorrosion covering protection.

EU Regulation 874/2012 - Illumination equipment energy classes



LED VERSION:
Class A/A+/A++
Luminaire supplied with integrated LED modules that cannot be replaced



METAL HALIDE VERSION:
Class A/A+
HIT-TC-CE/G8,5



.1 White



.6 Grey



.3 Anthracite



.4 Black



.18 Deep Brown



Bollard light



The fitting is equipped with 2 cable input



Protection against impact.
IK 05 - 7,00 joule

Leo120 on post - Unidirectional - Transparent Glass



123162116
HIT-TC-CE 20W GU6,5
Electronic ballast

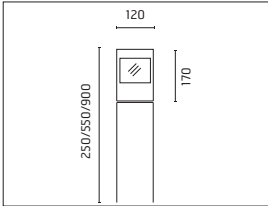
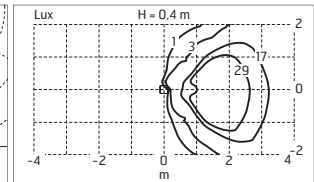
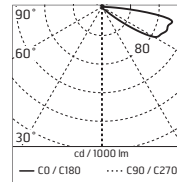

IP65

Leo120 on post - Unidirectional - Transparent Glass

Light Source: Power LED / 4,4W / Total power 6W / CRI>80 / 220÷240V / Integral electronic power supply



123214117
White 2700K
lm LED 442 ≈ lm OUTPUT 160

123235117
White 3000K
lm LED 475 ≈ lm OUTPUT 172

123234117
White 4000K
lm LED 510 ≈ lm OUTPUT 185

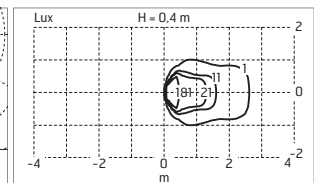
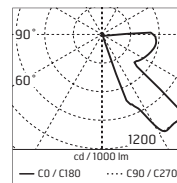

@4000K

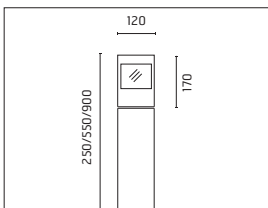

IP65

Leo120 on post - Unidirectional - Sandblasted Glass



12316246
HIT-TC-CE 20W GU6,5
Electronic ballast

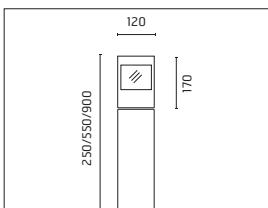
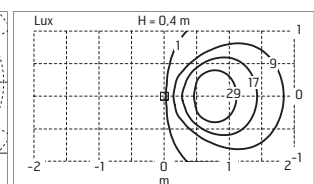
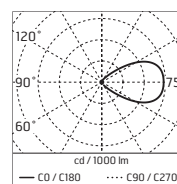

IP65

Leo120 on post - Bidirectional - Transparent Glass



123162136
HIT-TC-CE 20W GU6,5
Electronic ballast

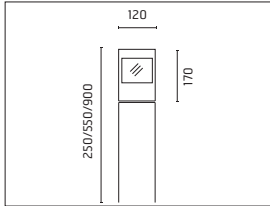
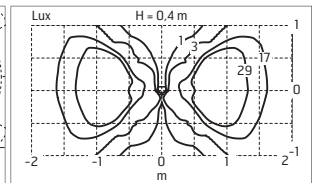
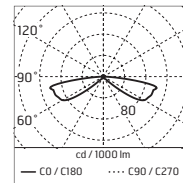

IP65

Leo120 on post - Bidirectional - Transparent Glass

Light Source: Power LED / 8,8W / Total power 10,4W / CRI>80 / 220÷240V / Integral electronic power supply



123114137
White 2700K
lm LED 2x442 ≠ lm OUTPUT 2x160

123166137
White 3000K
lm LED 2x475 ≠ lm OUTPUT 2x172

123167137
White 4000K
lm LED 2x510 ≠ lm OUTPUT 2x185

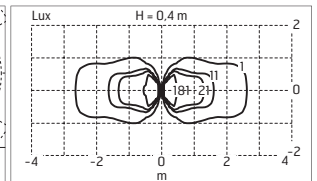
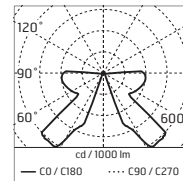

@4000K

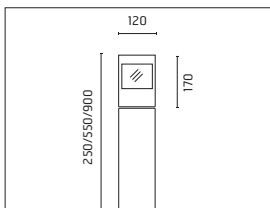

IP65

Leo120 on post - Bidirectional - Sandblasted Glass



12316247
HIT-TC-CE 20W GU6,5
Electronic ballast

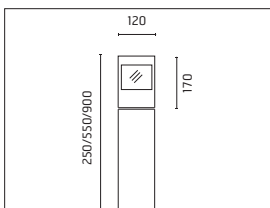
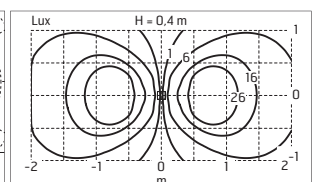
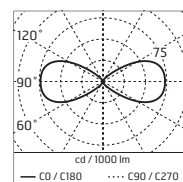

IP65

Leo120 on post - Omnidirectional - Transparent Glass



123162117
HIT-TC-CE 20W GU6,5
Electronic ballast

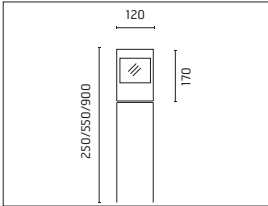
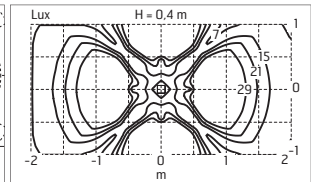
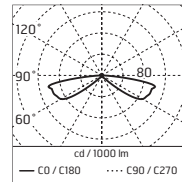

IP65

Leo120 on post - Omnidirectional - Transparent Glass

Light Source: Power LED / 17,6W / Total power 18,6W / CRI>80 / 220÷240V / Integral electronic power supply



123114118
White 2700K
lm LED 4x442 = lm OUTPUT 4x160

123168118
White 3000K
lm LED 4x475 = lm OUTPUT 4x172

123170118
White 4000K
lm LED 4x510 = lm OUTPUT 4x185

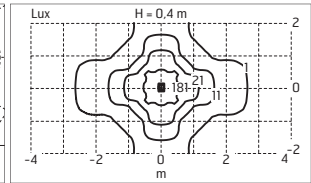
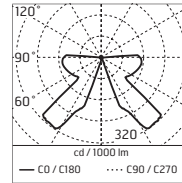

@4000K

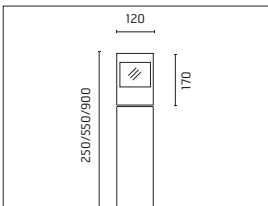

IP65

Leo120 on post - Omnidirectional - Sandblasted Glass



12316248
HIT-TC-CE 20W GU6,5
Electronic ballast

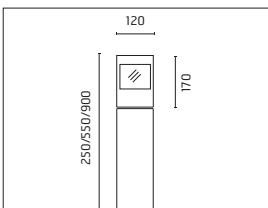
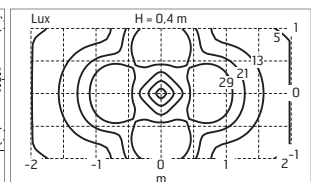
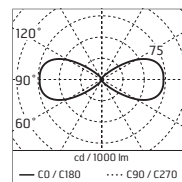

IP65

Leo120 on post / Poles

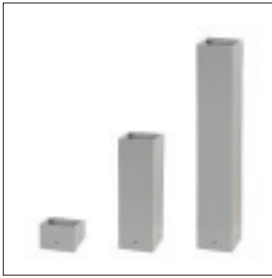

12325
H. 80 mm

12355
H. 380 mm

12390
H. 730 mm

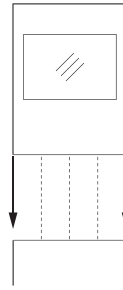

Top installation on pole







Accessories: Leo120 - Leo120 on post

130
BASE PLATE AND FIXING BOLTS
112 x 112 x H 160mm

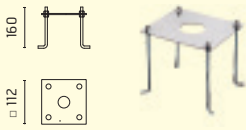

237
SPD: (SURGE PROTECTION DEVICE)
275Vac
MAXIMUM DISCHARGE CURRENT
10KA (8/20µs)
MAXIMUM OPERATING CURRENT 5A
SUITABLE FOR SERIES CONNECTION
- IP66

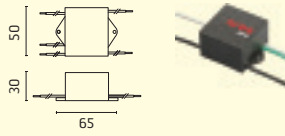

acc. code ▶	130	237
12325	•	
12355	•	
12390	•	
12314644		•
12314652		•
12316243		
12316245		
12316247		
12316248		
12316250		
12316253		
12316254		
12316644		•
12316652		•
12316744		•
12316752		•

acc. code ▶	130	237
12316853		•
12316854		•
12317054		•
123114118		•
123114137		•
123162116		
123162117		
123162136		
123166137		•
123167137		•
123168118		•
123170118		•
123214117		•
123234117		•
123235117		•
12314854		•

Correct Fixing Method
Bollard fixed on plinth +
suitable installation screws

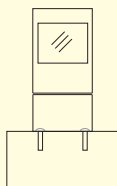

Correct Fixing Method
Bollard fixed on plinth + fixing bolts

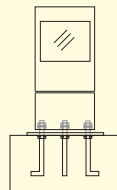

Incorrect Fixing Method
Do not fix the bollard directly on the ground
without plinth





LEO 160

- Luminaire for installation on wall – surface mounted.
- Configuration: die-cast aluminium structure, EN AB-47100 alloy (low copper content). Diffuser: lens or transparent or sandblasted glass fixed to the structure through a robotic gluing system.
- Double layer coating for high resistance to corrosion: the aluminium components are painted with a double coat using powders that are compliant with QUALICOAT standards: a first layer of epoxy powder (with excellent chemical and mechanical resistance) and a second finishing layer of polyester powder (resistant to UV rays and atmospheric agents). The entire painting process of the aluminium fitting starts from components that have been sandblasted in advance to make the surface more porous and increase the adherence of the paint. Ares effects alkaline and acid washing to clean the surfaces completely, then rinses with demineralised water to remove any residue particles, subsequently a chemical conversion treatment is done to protect against rusting.
- Protection rating: IP65
- In compliance with EN 60598-1 standards
- Class of insulation: I
- Installation: wiring through two cable holders (8mm\varnothing<math><13\text{mm}</math> cables). Outdoor use requires suitable flexible cables assuring the watertightness of the cable holder. For watertightness to be assured the use of a multicore cable is mandatory, the use of single unipolar cables is not allowed.
- During the installation and the maintenance of the fixtures it is important to be careful and avoid damages on the paint coating. Damages on the coating exposed to outdoor conditions or water, could cause corrosion. Chemical substances affect the anticorrosion covering protection.

EU Regulation 874/2012 - Illumination equipment energy classes

A⁺⁺
A⁺
A
A⁺

LED VERSION::
 Class A/A+/A++
 Luminaire supplied with integrated LED modules that cannot be replaced

METAL HALIDE VERSION:
 Class A+
 HIT-CE/G12



Wall fitting



The fitting is equipped with 2 cable input



Protection against impact.
 IK 05 - 7,00 joule

Leo160 - Unidirectional - 2° - Convex Lens

Light Source: Power LED / 6,2W / Total power 9,8W / CRI>80 / 110÷240V / Integral electronic power supply



12315144
White 2700K
lm LED 574 ± lm OUTPUT 112



12324144
White 3000K
lm LED 617 ± lm OUTPUT 120

12324044
White 4000K
lm LED 663 ± lm OUTPUT 129

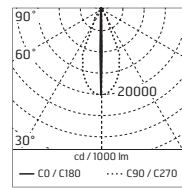
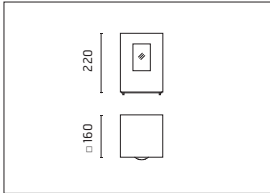

m	lux	
	Max	Med
1.00	2542	1639
2.00	635	410
3.00	282	182
4.00	159	102
5.00	102	66

$\alpha = 1.0^\circ + 1.0^\circ$ $\beta = 23.0^\circ + 23.0^\circ$

@4000K

IP65

Leo160 - Unidirectional - 4° - Convex Lens

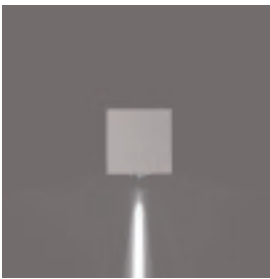

1233543
HIT-CE 35W G12
Electronic ballast

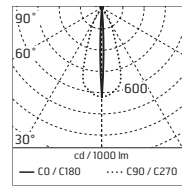
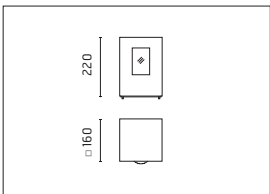

m	lux	
	Max	Med
1.00	2333	1530
2.00	583	382
3.00	259	170
4.00	146	96
5.00	93	61

$\alpha = 2.0^\circ + 2.0^\circ$ $\beta = 20.0^\circ + 20.0^\circ$

IP65

Leo160 - Unidirectional - 40°



1233550
HIT-CE 35W G12
Electronic ballast

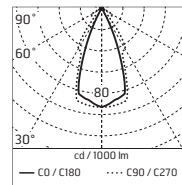
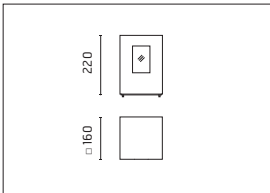

m	lux	
	Max	Med
1.00	316	209
2.00	79	52
3.00	35	23
4.00	20	13
5.00	13	8

$\alpha = 21.0^\circ + 21.0^\circ$ $\beta = 25.0^\circ + 25.0^\circ$

IP65

Leo160 - Unidirectional - 65°

Light Source: Power LED / 6,2W / Total power 9,8W / CRI>80 / 110±240V / Integral electronic power supply



12315152
White 2700K
lm LED 574 ≈ lm OUTPUT 257

12324152
White 3000K
lm LED 617 ≈ lm OUTPUT 276

12324052
White 4000K
lm LED 663 ≈ lm OUTPUT 297

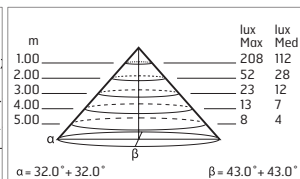
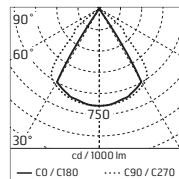
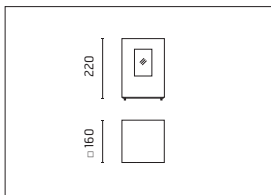

@4000K

IP65

Leo160 - Bidirectional - Sandblasted Glass



1233547
HIT-CE 35W G12
Electronic ballast

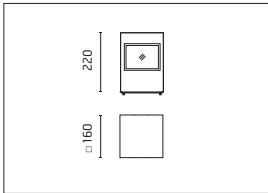
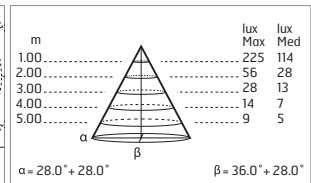
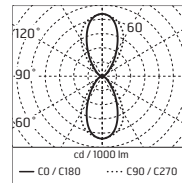

IP65

Leo160 - Bidirectional - Combined: 4° (Convex Lens) + 75°



1233554
HIT-CE 35W G12
Electronic ballast

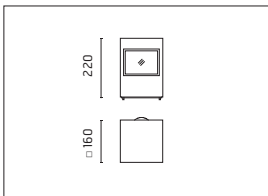
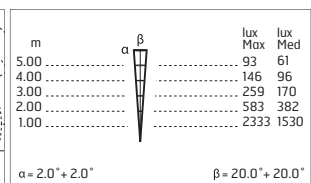
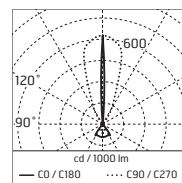

IP65

Leo160 - Omnidirectional - 4° - Convex Lens

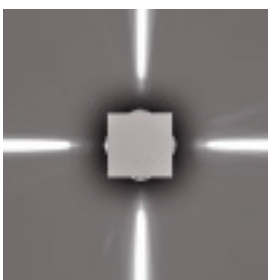

1233545
HIT-CE 35W G12
Electronic ballast

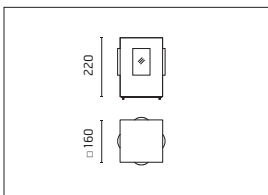
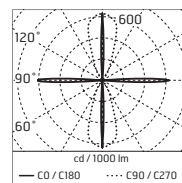

IP65

Leo160 - Omnidirectional - 40°



1233553
HIT-CE 35W G12
Electronic ballast

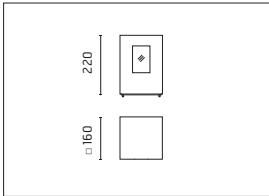
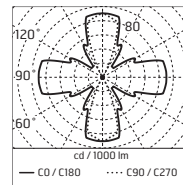

IP65

Leo160 - Omnidirectional - 65°

Light Source: Power LED / 24,8W / Total power 28,6W / CRI>80 / 110÷240V / Integral electronic power supply



12315454
White 2700K
lm LED 4x574 ≠ lm OUTPUT 4x257

12324454
White 3000K
lm LED 4x617 ≠ lm OUTPUT 4x276

12324354
White 4000K
lm LED 4x663 ≠ lm OUTPUT 4x297

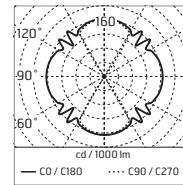

@4000K

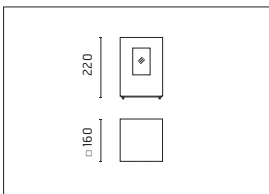

IP65

Leo160 - Omnidirectional - Sandblasted Glass

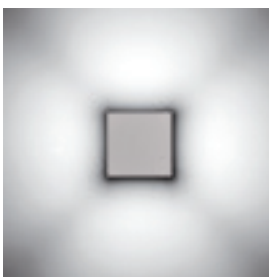

1233548
HIT-CE 35W G12
Electronic ballast

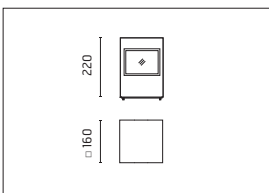
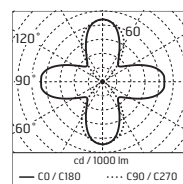

IP65



LEO 160 ON POST

- Luminaire for installation on post – surface mounted.
- Configuration: die-cast aluminium structure, EN AB-47100 alloy (low copper content), extruded aluminium post. Glass diffuser: transparent or sandblasted fixed to the structure through a robotic gluing system.
- Double layer coating for high resistance to corrosion: the aluminium components are painted with a double coat using powders that are compliant with QUALICOAT standards: a first layer of epoxy powder (with excellent chemical and mechanical resistance) and a second finishing layer of polyester powder (resistant to UV rays and atmospheric agents). The entire painting process of the aluminium fitting starts from components that have been sandblasted in advance to make the surface more porous and increase the adherence of the paint. Ares effects alkaline and acid washing to clean the surfaces completely, then rinses with demineralised water to remove any residue particles, subsequently a chemical conversion treatment is done to protect against rusting.
- Protection rating: IP65
- In compliance with EN 60598-1 standards
- Class of insulation: I
- Installation: wiring through two cable holders (8mm\times13mm cables). Outdoor use requires suitable flexible cables assuring the watertightness of the cable holder. For watertightness to be assured the use of a multicore cable is mandatory, the use of single unipolar cables is not allowed.
- During the installation and the maintenance of the fixtures it is important to be careful and avoid damages on the paint coating. Damages on the coating exposed to outdoor conditions or water, could cause corrosion. Chemical substances affect the anticorrosion covering protection.

EU Regulation 874/2012 - Illumination equipment energy classes



LED VERSION:
Class A/A+/A++
Luminaire supplied with integrated LED modules that cannot be replaced

METAL HALIDE VERSION:
Class A+
HIT-CE/G12



.1 White



.6 Grey



.3 Anthracite



.4 Black



.18 Deep Brown



Bollard light



The fitting is equipped with 2 cable input



Protection against impact.
IK 05 - 7,00 joule

Leo160 on post - Bidirectional - Transparent Glass



12335136
HIT-CE 35W G12

Electronic ballast

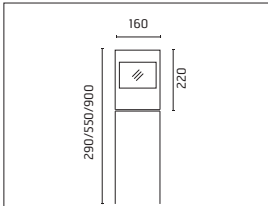
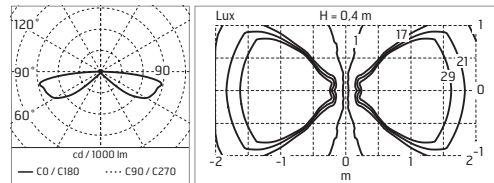

IP65

Leo160 on post - Bidirectional - Transparent Glass

Light Source: Power LED / 12,4W / Total power 16W / CRI>80 / 110÷240V / Integral electronic power supply



123151137
White 2700K
lm LED 2x574 = lm OUTPUT 2x207

123241137
White 3000K
lm LED 2x617 = lm OUTPUT 2x223

123240137
White 4000K
lm LED 2x663 = lm OUTPUT 2x240

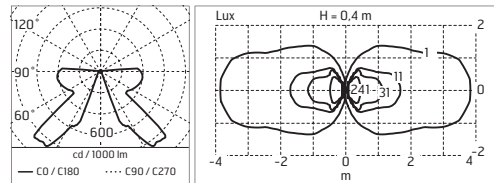

@4000K

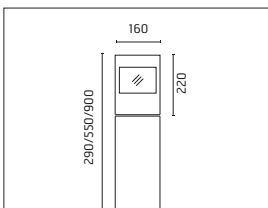

IP65

Leo160 on post - Bidirectional - Sandblasted Glass



1233547
HIT-CE 35W G12

Electronic ballast

1237147
HIT-CE 70W G12

Electronic ballast

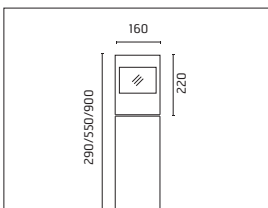
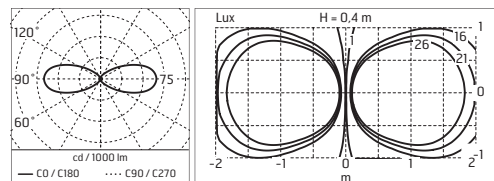
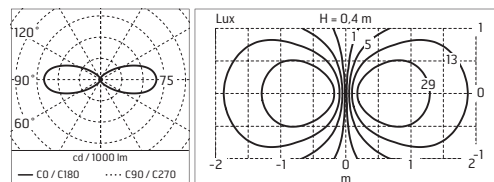

IP65

Leo160 on post - Omnidirectional - Transparent Glass



12335117
HIT-CE 35W G12
Electronic ballast

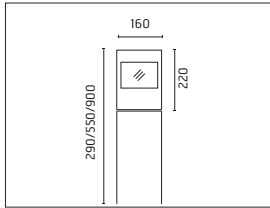
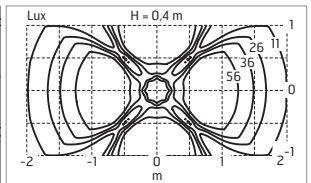
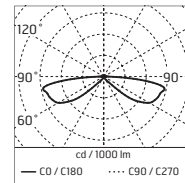

IP65

Leo160 on post - Omnidirectional - Transparent Glass

Light Source: Power LED / 24,8W / Total power 28,6W / CRI>80 / 110÷240V / Integral electronic power supply



123154118
White 2700K
lm LED 4x574 ≠ lm OUTPUT 4x207

123244118
White 3000K
lm LED 4x617 ≠ lm OUTPUT 4x223

123243118
White 4000K
lm LED 4x663 ≠ lm OUTPUT 4x240

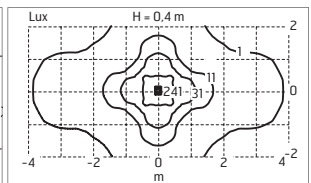
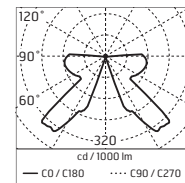

@4000K

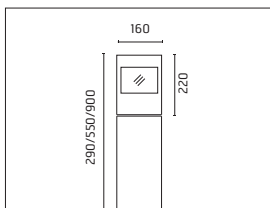

IP65

Leo160 on post - Omnidirectional - Sandblasted Glass



1233548
HIT-CE 35W G12
Electronic ballast

1237148
HIT-CE 70W G12

Electronic ballast

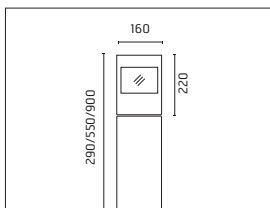
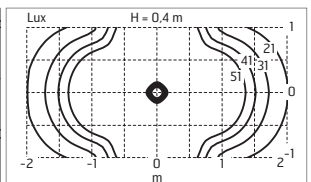
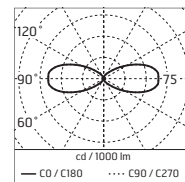
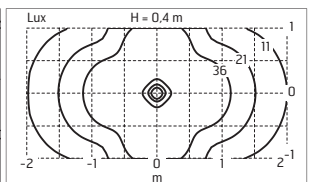
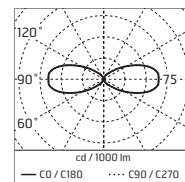

IP65

Leo160 on post / Poles

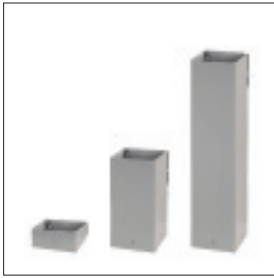

12425
H. 70 mm

12455
H. 330 mm

12490
H. 680 mm

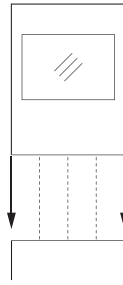

Top installation on pole

Accessories: Leo160 - Leo160 on post

131

BASE PLATE AND FIXING BOLTS
152 x 152 x H 160mm

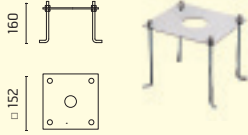

237

SPD: (SURGE PROTECTION DEVICE)
275Vac
MAXIMUM DISCHARGE CURRENT
10KA (8/20µs)
MAXIMUM OPERATING CURRENT 5A
SUITABLE FOR SERIES CONNEC-
TION - IP66

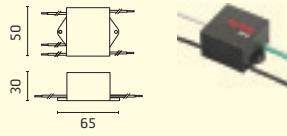

acc. code ▶	131	237
prod. code ▼		
12425	•	
12455	•	
12490	•	
1233543		
1233545		
1233547		
1233548		
1233550		
1233553		
1233554		
1237147		
1237148		
12315144		•
12315152		•
12315454		•
12324044		•
12324052		•
12324144		•
12324152		•
12324354		•
12324454		•
12335117		
12335136		
123151137		•
123154118		•
123240137		•
123241137		•
123243118		•
123244118		•

Correct Fixing Method

Bollard fixed on plint +
suitable installation screws

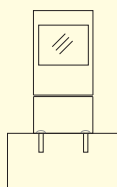

Correct Fixing Method

Bollard fixed on plinth + fixing bolts

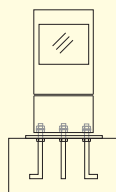

Incorrect Fixing Method





Do not fix the bollard directly on the ground
without plinth





- Luminaire for installation on wall – surface mounted.
- Configuration: polycarbonate structure and die-cast aluminium cover and base, EN AB-47100 alloy (low copper content)
- Double layer coating for high resistance to corrosion: the aluminium components are painted with a double coat using powders that are compliant with QUALICOAT standards: a first layer of epoxy powder (with excellent chemical and mechanical resistance) and a second finishing layer of polyester powder (resistant to UV rays and atmospheric agents). The entire painting process of the aluminium fitting starts from components that have been sandblasted in advance to make the surface more porous and increase the adherence of the paint. Ares effects alkaline and acid washing to clean the surfaces completely, then rinses with demineralised water to remove any residue particles, subsequently a chemical conversion treatment is done to protect against rusting.
- Protection rating: IP66
- In compliance with EN 60598-1 standards
- Class of insulation: I
- Installation: wiring through two cable holders (8mm\varnothing<math><13\text{mm}</math> cables). Outdoor use requires suitable flexible cables assuring the watertightness of the cable holder.
- During the installation and the maintenance of the fixtures it is important to be careful and avoid damages on the paint coating. Damages on the coating exposed to outdoor conditions or water, could cause corrosion. Chemical substances affect the anticorrosion covering protection.

EU Regulation 874/2012 - Illumination equipment energy classes

	LED VERSION: Class A/A+/A++ Luminaire supplied with integrated LED modules that cannot be replaced
	
	
	FLUORESCENT VERSION: Class A TC-DEL/G24q-2



Wall fitting



The fitting is equipped with 2 cable input.



Protection against impact.
IK 10 - 20,00 joule

Midna - Unidirectional



529001
TC-DEL 18W G24q-2
Electronic ballast

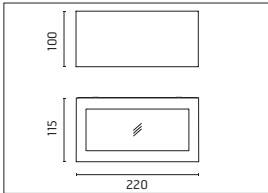
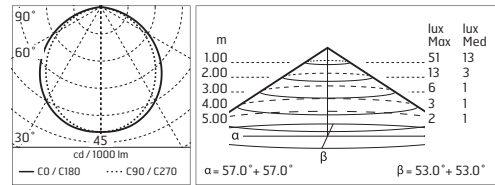

IP66

Midna - Unidirectional

Light Source: Mid-Power LED / 8,8W / Total power 11W / CRI>80 / 220-240V / Integral electronic power supply



529024
529024-300 Dimmable Dali
529024-310 Dimmable 1-10
White 2700K
lm LED 1114 ≠ lm OUTPUT 533

529004
529004-300 Dimmable Dali
529004-310 Dimmable 1-10
White 3000K
lm LED 1615 ≠ lm OUTPUT 763

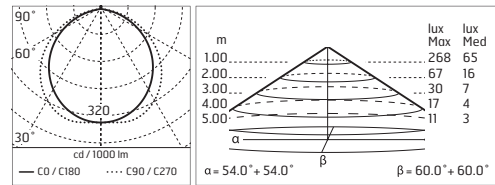

@4000K

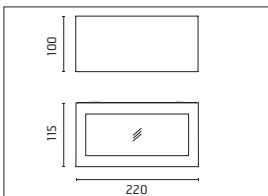

529003
529003-300 Dimmable Dali
529003-310 Dimmable 1-10
White 4000K
lm LED 1668 ≠ lm OUTPUT 788

IP66

Midna - Bidirectional



529005
TC-DEL 18W G24q-2
Electronic ballast

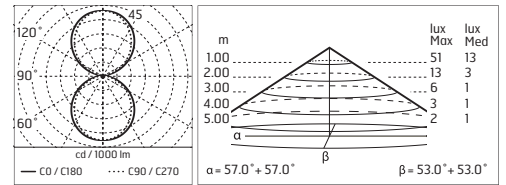
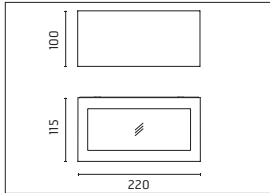

IP66

Midna - Bidirectional

Light Source: Mid-Power LED / 17,6W / Total power 19W / CRI>80 / 220-240V / Integral electronic power supply



529028
529028-300 Dimmable Dali
529028-310 Dimmable 1-10
White 2700K
lm LED 2x1114 ≠ lm OUTPUT 2x533

529008
529008-300 Dimmable Dali
529008-310 Dimmable 1-10
White 3000K
lm LED 2x1615 ≠ lm OUTPUT 2x763

529007
529007-300 Dimmable Dali
529007-310 Dimmable 1-10
White 4000K
lm LED 2x1668 ≠ lm OUTPUT 2x788

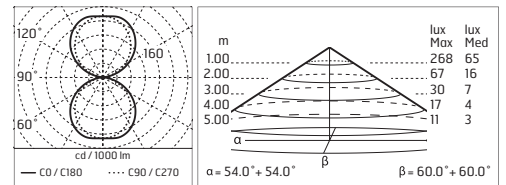
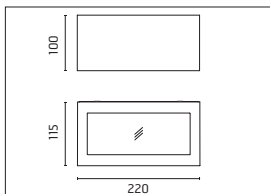

IP66



EU Regulation 874/2012 - Illumination equipment energy classes

LED VERSION:
Class A/A+/A++
Luminaire supplied
with integrated LED modules
that cannot be replaced

.1 White .6 Grey .3 Anthracite .4 Black .18 Deep Brown



Midna High Efficiency - Unidirectional

Light Source: Mid-Power LED / 8,8W / Total power 11W / CRI>80 / 220-240V / Integral electronic power supply



529053
529053-300 Dimmable Dali
529053-310 Dimmable 1-10
 White 2700K
 lm LED 1502 ≠ lm OUTPUT 815

529052
529052-300 Dimmable Dali
529052-310 Dimmable 1-10
 White 3000K
 lm LED 1615 ≠ lm OUTPUT 876

529051
529051-300 Dimmable Dali
529051-310 Dimmable 1-10
 White 4000K
 lm LED 1668 ≠ lm OUTPUT 905

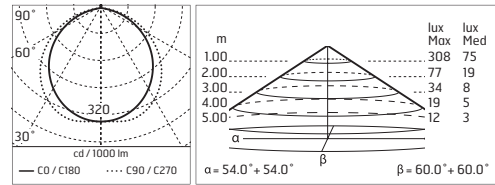
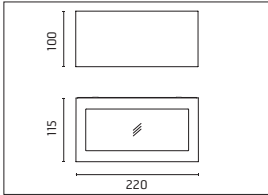

@4000K

IP66

Midna High Efficiency - Bidirectional

Light Source: Mid-Power LED / 17,6W / Total power 19W / CRI>80 / 220-240V / Integral electronic power supply



529056
529056-300 Dimmable Dali
529056-310 Dimmable 1-10
 White 2700K
 lm LED 2x1502 ≠ lm OUTPUT 2x815

529055
529055-300 Dimmable Dali
529055-310 Dimmable 1-10
 White 3000K
 lm LED 2x1615 ≠ lm OUTPUT 2x876

529054
529054-300 Dimmable Dali
529054-310 Dimmable 1-10
 White 4000K
 lm LED 2x1668 ≠ lm OUTPUT 2x905

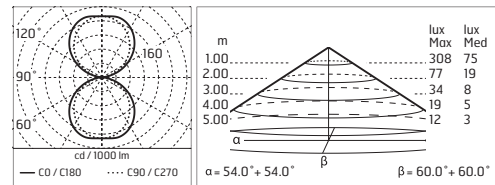
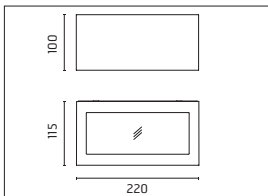

@4000K

IP66

Accessories: Midna

237

SPD: (SURGE PROTECTION DEVICE)
 275Vac
 MAXIMUM DISCHARGE CURRENT
 10KA (8/20µs)
 MAXIMUM OPERATING CURRENT 5A
 SUITABLE FOR SERIES CONNec-
 TION - IP66

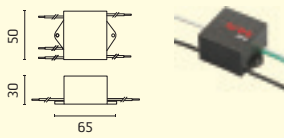





acc. code ▶	dimmi DALI	dimmi 1-10	237
529001			
529003	-300	-310	•
529004	-300	-310	•
529005			
529007	-300	-310	•
529008	-300	-310	•
529024	-300	-310	•
529028	-300	-310	•
529051	-300	-310	•
529052	-300	-310	•
529053	-300	-310	•
529054	-300	-310	•
529055	-300	-310	•
529056	-300	-310	•



- Luminaire for installation on wall – surface mounted.
- Configuration: polycarbonate structure and die-cast aluminium cover and base (MaxiMelrie only), EN AB-47100 alloy (low copper content)
- Double layer coating for high resistance to corrosion: the aluminium components are painted with a double coat using powders that are compliant with QUALICOAT standards: a first layer of epoxy powder (with excellent chemical and mechanical resistance) and a second finishing layer of polyester powder (resistant to UV rays and atmospheric agents). The entire painting process of the aluminium fitting starts from components that have been sandblasted in advance to make the surface more porous and increase the adherence of the paint. Ares effects alkaline and acid washing to clean the surfaces completely, then rinses with demineralised water to remove any residue particles, subsequently a chemical conversion treatment is done to protect against rusting.
- Protection rating: IP65
- In compliance with EN 60598-1 standards
- Class of insulation: Melrie: II; MaxiMelrie: I
- Installation: Melrie: wiring through two rubber cable holders (5mm\varnothing<math><10\text{mm}</math> cables); MaxiMelrie: wiring through two rubber cable holders (8mm\varnothing<math><13\text{mm}</math> cables). Outdoor use requires suitable flexible cables assuring the watertightness of the cable holder.
- During the installation and the maintenance of the fixtures it is important to be careful and avoid damages on the paint coating.
Damages on the coating exposed to outdoor conditions or water, could cause corrosion.
Chemical substances affect the anticorrosion covering protection.

EU Regulation 874/2012 - Illumination equipment energy classes

    	<p>LED VERSION: Class A/A+/A++ Luminaire supplied with integrated LED modules that cannot be replaced</p> <p>FLUORESCENT VERSION: Class A TC-DEL/G24q-1 TC-DEL/G24q-3</p> <p>HALOGEN VERSION: Class D QT26/E14</p>
---	---



	<p>Wall fitting</p>		<p>The fitting is equipped with 2 cable input</p>
	<p>Protection against impact. IK 09 - 10,00 joule</p>		

Melrie - Unidirectional

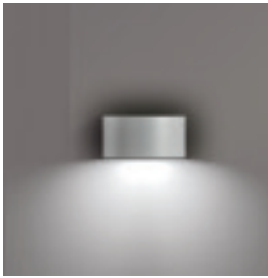

481121
 QT 26 40W E14
 Lamp max size: Ø40 mm H.95 mm

485721
 TC-DEL 13W G24q-1
 Electronic ballast

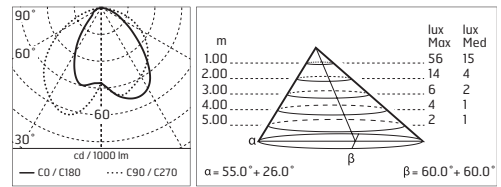
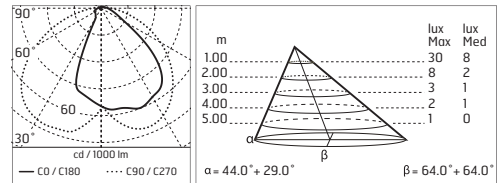
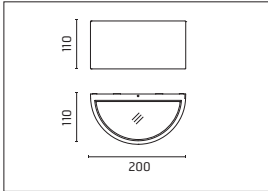

IP65

Melrie - Unidirectional

Light Source: Mid-Power LED / 5,5W / Total power 8W / CRI>80 / 220÷240V / Integral electronic power supply



483005
 White 2700K
 lm LED 714 \approx lm OUTPUT 452

483002
 White 3000K
 lm LED 768 \approx lm OUTPUT 486

483001
 White 4000K
 lm LED 806 \approx lm OUTPUT 510

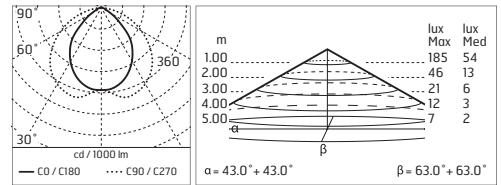

@4000K

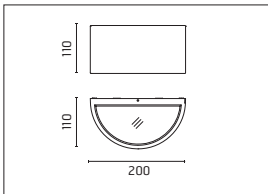

IP65

Melrie - Bidirectional



481122
 QT 26 40W E14
 Lamp max size: Ø40 mm H.95 mm

485722
 TC-DEL 13W G24q-1
 Electronic ballast

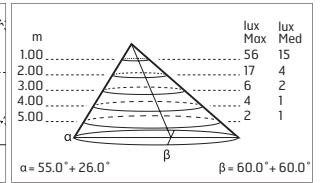
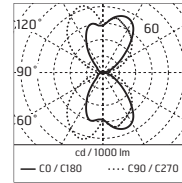
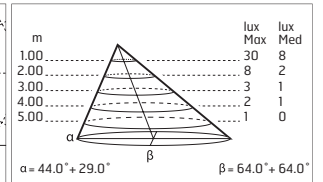
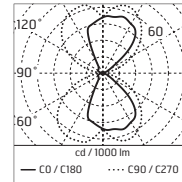
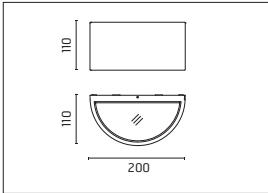

IP65

Melrie - Bidirectional

Light Source: Mid-Power LED / 11W / Total power 14W / CRI>80 / 220÷240V / Integral electronic power supply



483006
 White 2700K
 lm LED 2x714 ≠ lm OUTPUT 2x452

483004
 White 3000K
 lm LED 2x768 ≠ lm OUTPUT 2x486

483003
 White 4000K
 lm LED 2x806 ≠ lm OUTPUT 2x510

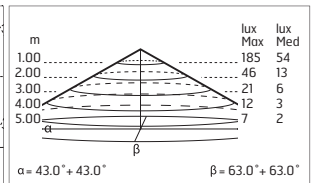
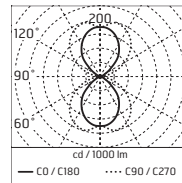
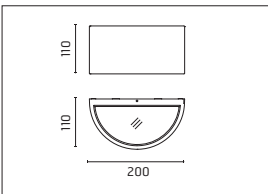

@4000K

IP65

MaxiMelrie - Unidirectional



486121
TC-DEL 26W G24q-3
Electronic ballast

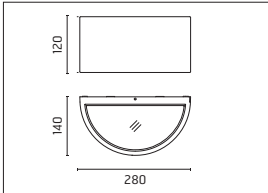
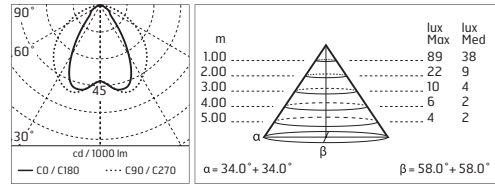

IP65

MaxiMelrie - Unidirectional

Light Source: Mid-Power LED / 8,8W / Total power 12W / CRI>80 / 220÷240V / Integral electronic power supply



4827524
White 2700K
lm LED 1144 \approx lm OUTPUT 724

4827521
White 3000K
lm LED 1230 \approx lm OUTPUT 778

4827421
White 4000K
lm LED 1291 \approx lm OUTPUT 817

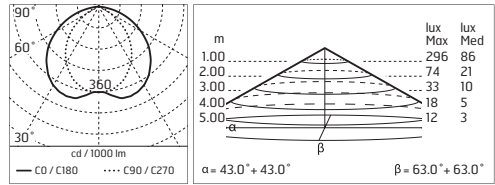

@4000K

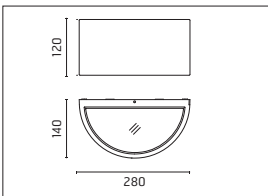

Dimmable on request

IP65

MaxiMelrie - Bidirectional



486122
TC-DEL 26W G24q-3

Electronic ballast

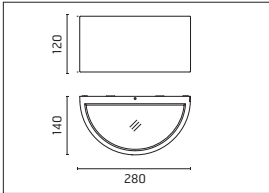
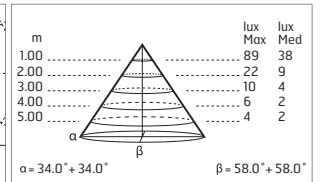
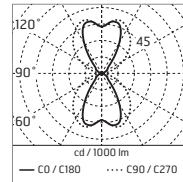

IP65

MaxiMelrie - Bidirectional

Light Source: Mid-Power LED / 17,6W / Total power 18W / CRI>80 / 220÷240V / Integral electronic power supply



4827525
White 2700K
lm LED 2x1144 \approx lm OUTPUT 2x724

4827522
White 3000K
lm LED 2x1230 \approx lm OUTPUT 2x778

4827422
White 4000K
lm LED 2x1291 \approx lm OUTPUT 2x817

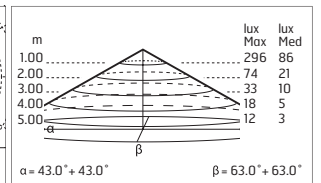
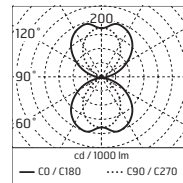

@4000K

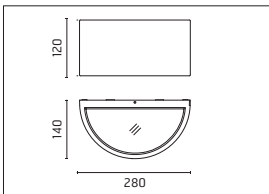

Dimmable on request

IP65



Accessories: Melrie

237

SPD: (SURGE PROTECTION DEVICE)
 275Vac
 MAXIMUM DISCHARGE CURRENT
 10KA (8/20µs)
 MAXIMUM OPERATING CURRENT 5A
 SUITABLE FOR SERIES CONNEC-
 TION - IP66

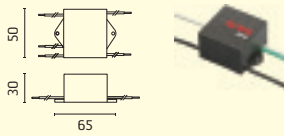





acc. code ▶	237
prod. code ▼	
481121	
481122	
483001	•
483002	•
483003	•
483004	•
483005	•
483006	•
485721	
485722	
486121	
486122	
4827421	•
4827422	•
4827521	•
4827522	•
4827524	•
4827525	•



EMMA 70

- Luminaire for installation on wall – surface mounted.
- Configuration: die-cast aluminium structure, EN AB-47100 alloy (low copper content). Glass diffuser: transparent.
- Double layer coating for high resistance to corrosion: the aluminium components are painted with a double coat using powders that are compliant with QUALICOAT standards: a first layer of epoxy powder (with excellent chemical and mechanical resistance) and a second finishing layer of polyester powder (resistant to UV rays and atmospheric agents). The entire painting process of the aluminium fitting starts from components that have been sandblasted in advance to make the surface more porous and increase the adherence of the paint. Ares effects alkaline and acid washing to clean the surfaces completely, then rinses with demineralised water to remove any residue particles, subsequently a chemical conversion treatment is done to protect against rusting.
- Protection rating: IP66
- In compliance with EN 60598-1 standards
- Class of insulation: I
- Installation: wiring through one cable holder (5mm\times10mm cables). Outdoor use requires suitable flexible cables assuring the watertightness of the cable holder.
- During the installation and the maintenance of the fixtures it is important to be careful and avoid damages on the paint coating. Damages on the coating exposed to outdoor conditions or water, could cause corrosion. Chemical substances affect the anticorrosion covering protection.

EU Regulation 874/2012 - Illumination equipment energy classes

  	<p>LED VERSION: Class A/A+/A++ Luminaire supplied with integrated LED modules that cannot be replaced</p>
	<p>HALOGEN VERSION: Class B QR.CBC51/GU5,3</p>
	<p>HALOGEN VERSION: Class D QPARCBC51/GZ10</p>



Wall fitting



The fitting is equipped with 1 cable input



Protection against impact.
IK 08 - 5,00 joule

Emma70 - Unidirectional



1162821.A
 PAR 16 50W/230V GZ10
 Lamp max size: Ø50 mm H.55 mm
 Optional LED bulb
 DR PAR 7,5W/230V GZ10
 Lamp max size: Ø50 mm H.55 mm

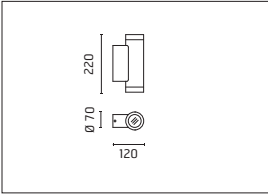

IP66

Emma70 - Unidirectional - 14°

Light Source: Power LED / 4,6W / Total power 6,5W / CRI>80 / 110÷240V / Integral electronic power supply



1162712.A
 White 2700K
 lm LED 574 ≈ lm OUTPUT 439

1165612.A
 White 3000K
 lm LED 617 ≈ lm OUTPUT 472

11617212.A
 White 4000K
 lm LED 649 ≈ lm OUTPUT 488

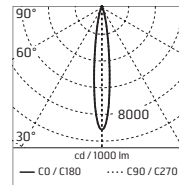

m	lux	
	Max	Med
1.00	4511	2893
2.00	1128	723
3.00	501	321
4.00	282	181
5.00	180	116

α = 7.0° + 7.0° β = 7.0° + 7.0°
 @ 4000K

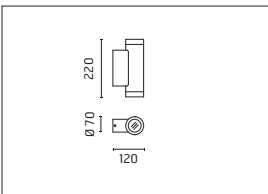

IP66

Emma70 - Unidirectional - 54°

Light Source: Power LED / 4,6W / Total power 6,5W / CRI>80 / 110÷240V / Integral electronic power supply



1162721.A
 White 2700K
 lm LED 574 ≈ lm OUTPUT 392

1165621.A
 White 3000K
 lm LED 617 ≈ lm OUTPUT 422

11617221.A
 White 4000K
 lm LED 649 ≈ lm OUTPUT 436

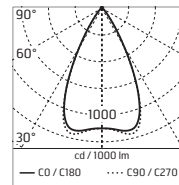

m	lux	
	Max	Med
1.00	494	309
2.00	124	77
3.00	55	34
4.00	31	19
5.00	20	12

α = 27.0° + 27.0° β = 27.0° + 27.0°
 @ 4000K

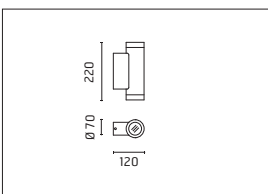

IP66

Emma70 - Bidirectional



1162842.A
 PAR 16 2x50W/230V GZ10
 Lamp max size: Ø50 mm H.55 mm
 Optional LED bulb
 DR PAR 7,5W/230V GZ10
 Lamp max size: Ø50 mm H.55 mm

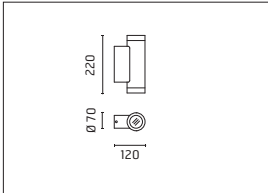
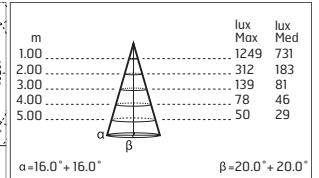
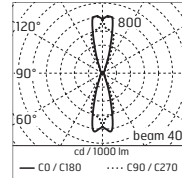

IP66

Emma70 - Bidirectional - 14°

Light Source: Power LED / 9,3W / Total power 12W / CRI>80 / 110±240V / Integral electronic power supply



11627113.A
 White 2700K
 lm LED 2x574 ≠ lm OUTPUT 2x439

11656113.A
 White 3000K
 lm LED 2x617 ≠ lm OUTPUT 2x472

116172113.A
 White 4000K
 lm LED 2x649 ≠ lm OUTPUT 2x488

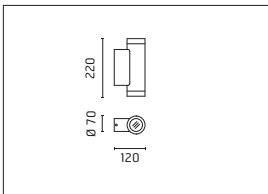
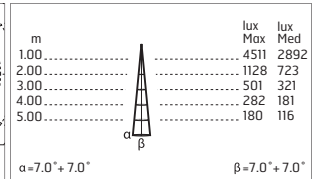
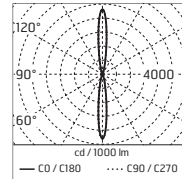

@ 4000K

IP66

Emma70 - Bidirectional - 54°

Light Source: Power LED / 9,3W / Total power 12W / CRI>80 / 110±240V / Integral electronic power supply



1162742.A
 White 2700K
 lm LED 2x574 ≠ lm OUTPUT 2x392

1165642.A
 White 3000K
 lm LED 2x617 ≠ lm OUTPUT 2x422

11617242.A
 White 4000K
 lm LED 2x649 ≠ lm OUTPUT lm LED
 2x649 ≠ lm OUTPUT 2x436

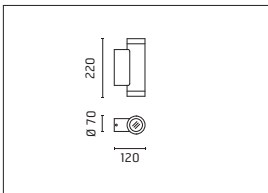
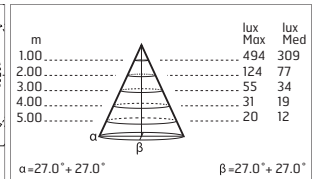
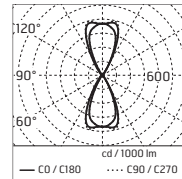

@ 4000K

IP66



Accessories: Emma70

237

SPD: (SURGE PROTECTION DEVICE)
 275Vac
 MAXIMUM DISCHARGE CURRENT
 10kA (8/20µs)
 MAXIMUM OPERATING CURRENT 5A
 SUITABLE FOR SERIES CONNEC-
 TION - IP66

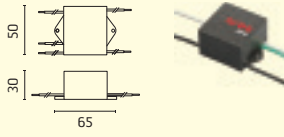







acc. code ▶	237
prod. code ▼	
1162712.A	•
1162721.A	•
1162742.A	•
1162821.A	
1162842.A	
1165612.A	•
1165621.A	•
1165642.A	•
11617212.A	•
11617221.A	•
11617242.A	•
11627113.A	•
11656113.A	•
116172113.A	•



EMMA 110

- Luminaire for installation on wall – surface mounted.
- Configuration: die-cast aluminium fixing base and frames, EN AB-47100 alloy (low copper content), extruded aluminium body. Glass diffuser: transparent.
- Double layer coating for high resistance to corrosion: the aluminium components are painted with a double coat using powders that are compliant with QUALICOAT standards: a first layer of epoxy powder (with excellent chemical and mechanical resistance) and a second finishing layer of polyester powder (resistant to UV rays and atmospheric agents). The entire painting process of the aluminium fitting starts from components that have been sandblasted in advance to make the surface more porous and increase the adherence of the paint. Ares effects alkaline and acid washing to clean the surfaces completely, then rinses with demineralised water to remove any residue particles, subsequently a chemical conversion treatment is done to protect against rusting.
- Protection rating: IP66
- In compliance with EN 60598-1 standards
- Class of insulation: I
- Installation: wiring through two cable holders (8mm\varnothing<math><12\text{mm}</math> cables). Outdoor use requires suitable flexible cables assuring the watertightness of the cable holder. A quick clamp placed in the wiring unit allows an easy connection and disconnection for installation or maintenance.
- During the installation and the maintenance of the fixtures it is important to be careful and avoid damages on the paint coating. Damages on the coating exposed to outdoor conditions or water, could cause corrosion. Chemical substances affect the anticorrosion covering protection.

EU Regulation 874/2012 - Illumination equipment energy classes

	LED VERSION: Class A/A+/A++ Luminaire supplied with integrated LED modules that cannot be replaced
	
	
	HALOGEN VERSION: Class A/A+
	HIT-TC-CE/G8,5
	HALOGEN VERSION: Class D QPAR/E27

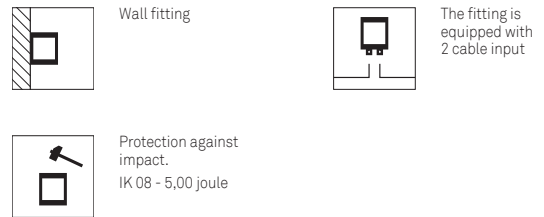

Emma110 - Unidirectional



1170121.A
QPAR 50W E27
Lamp max size: Ø95 mm H.60 mm

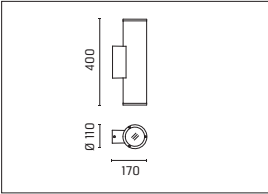
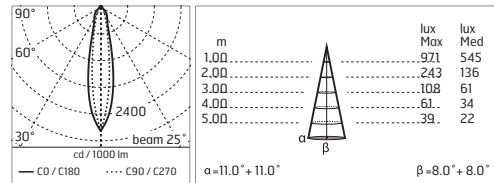

IP66

Emma110 - Unidirectional - 10°



1176612.A
HIT-TC-CE 20W G8.5
Electronic ballast

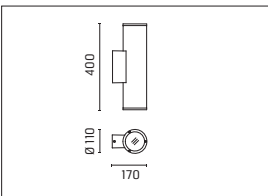
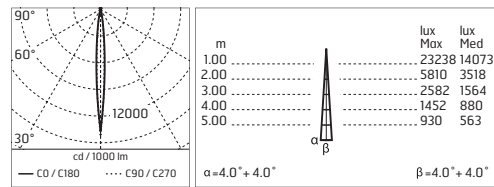

IP66

Emma110 - Unidirectional - 30°



1176621.A
HIT-TC-CE 20W G8.5
Electronic ballast

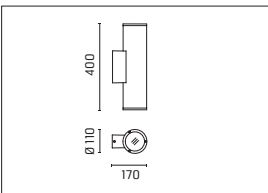
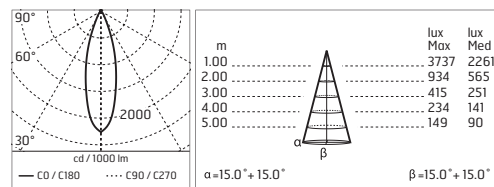

IP66

Emma110 - Unidirectional - 20°

Light Source: CoB LED / 12W / Total power 14,5W / CRI>80 / 220÷240V / Integral electronic power supply



117279146.A
White 2700K
lm LED 1895 ≠ lm OUTPUT 1569

117269146.A
White 3000K
lm LED 2038 ≠ lm OUTPUT 1687

117268146.A
White 4000K
lm LED 2123 ≠ lm OUTPUT 1757

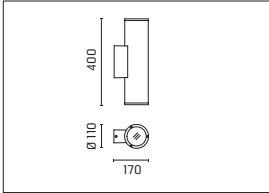
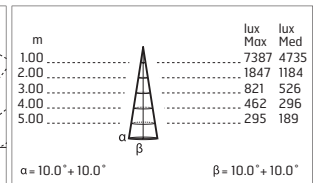
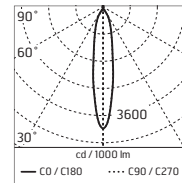

IP66

Emma110 - Unidirectional - 38°

Light Source: CoB LED / 12W / Total power 14,5W / CRI>80 / 220÷240V / Integral electronic power supply



117279147.A
White 2700K
lm LED 1895 ≠ lm OUTPUT 1526

117269147.A
White 3000K
lm LED 2038 ≠ lm OUTPUT 1641

117268147.A
White 4000K
lm LED 2123 ≠ lm OUTPUT 1709

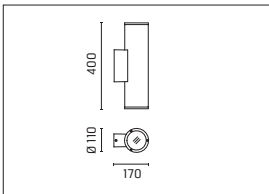
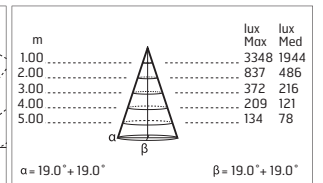
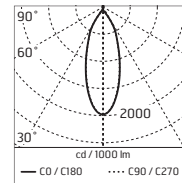

IP66

Emma110 - Bidirectional



1170242.A
QPAR20 2x50W E27
Lamp max size: Ø95 mm H.60 mm

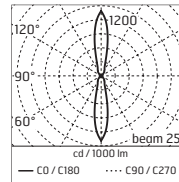

m	lux	
	Max	Med
1.00	972	546
2.00	243	136
3.00	108	61
4.00	61	34
5.00	39	22

$\alpha = 11.0^\circ + 11.0^\circ$ $\beta = 8.0^\circ + 8.0^\circ$

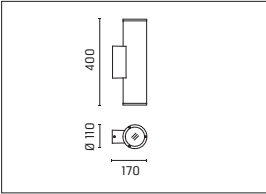

IP66

Emma110 - Bidirectional - 10°



11715012.A
HIT-TC-CE 2x20W G8.5
Electronic ballast

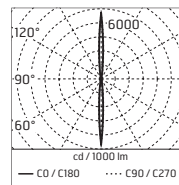

m	lux	
	Max	Med
1.00	23240	14074
2.00	5810	3519
3.00	2582	1567
4.00	1453	880
5.00	930	563

$\alpha = 4.0^\circ + 4.0^\circ$ $\beta = 4.0^\circ + 4.0^\circ$

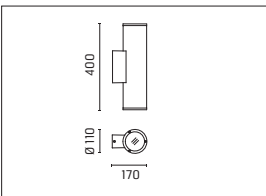

IP66

Emma110 - Bidirectional - 30°



11715042.A
HIT-TC-CE 2x20W G8.5
Electronic ballast

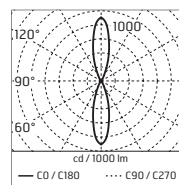

m	lux	
	Max	Med
1.00	3740	2263
2.00	935	566
3.00	416	251
4.00	234	151
5.00	150	91

$\alpha = 15.0^\circ + 14.0^\circ$

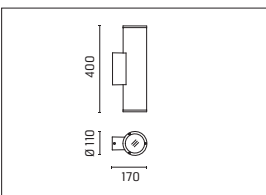

IP66

Emma110 - Bidirectional - 20°

Light Source: CoB LED / 24W / Total power 27W / CRI>80 / 220÷240V / Integral electronic power supply



117279148.A
White 2700K
lm LED 2x1895 = lm OUTPUT 2x1569

117269148.A
White 3000K
lm LED 2x2038 = lm OUTPUT 2x1687

117268148.A
White 4000K
lm LED 2x2123 = lm OUTPUT 2x1757

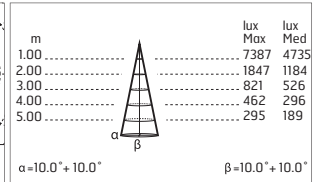
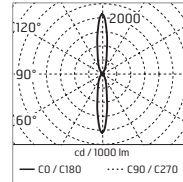
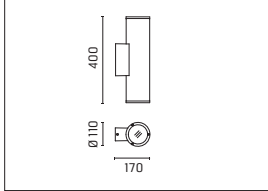

@ 4000K

IP66

Emma110 - Bidirectional - 38°

Light Source: CoB LED / 24W / Total power 27W / CRI>80 / 220÷240V / Integral electronic power supply



117279149.A
White 2700K
lm LED 2x1895 = lm OUTPUT 2x1526

117269149.A
White 3000K
lm LED 2x2038 = lm OUTPUT 2x1641

117268149.A
White 4000K
lm LED 2x2123 = lm OUTPUT 2x1709

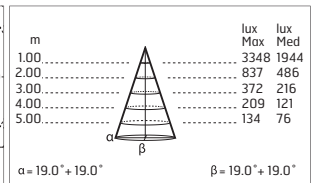
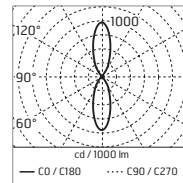
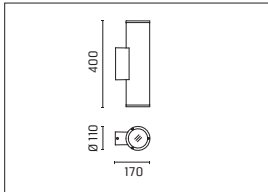

@ 4000K

IP66



Accessories: Emma110

237

SPD: (SURGE PROTECTION DEVICE)
 275Vac
 MAXIMUM DISCHARGE CURRENT
 10KA (8/20µs)
 MAXIMUM OPERATING CURRENT 5A
 SUITABLE FOR SERIES CONNEC-
 TION - IP66

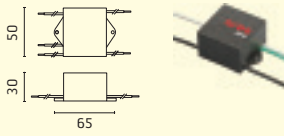







acc. code ▶	237
prod. code ▼	
1170121.A	
1170242.A	
1176612.A	
1176621.A	
11715012.A	
11715042.A	
117268146.A	•
117268147.A	•
117268148.A	•
117268149.A	•
117269146.A	•
117269147.A	•
117269148.A	•
117269149.A	•
117279146.A	•
117279147.A	•
117279148.A	•
117279149.A	•



KÜLTÜR VE SANAT ÜNİVERSİTESİ

- Luminaire for installation on wall – surface mounted.
- Configuration: die-cast aluminium fixing base and frames, EN AB-47100 alloy (low copper content), extruded aluminium body. Glass diffuser: transparent.
- Double layer coating for high resistance to corrosion: the aluminium components are painted with a double coat using powders that are compliant with QUALICOAT standards: a first layer of epoxy powder (with excellent chemical and mechanical resistance) and a second finishing layer of polyester powder (resistant to UV rays and atmospheric agents). The entire painting process of the aluminium fitting starts from components that have been sandblasted in advance to make the surface more porous and increase the adherence of the paint. Ares effects alkaline and acid washing to clean the surfaces completely, then rinses with demineralised water to remove any residue particles, subsequently a chemical conversion treatment is done to protect against rusting.
- Protection rating: IP66
- In compliance with EN 60598-1 standards
- Class of insulation: I
- Installation: wiring through two cable holders (8mm\varnothing<math><12\text{mm}</math> cables). Outdoor use requires suitable flexible cables assuring the watertightness of the cable holder. A quick clamp placed in the wiring unit allows an easy connection and disconnection for installation or maintenance.
- During the installation and the maintenance of the fixtures it is important to be careful and avoid damages on the paint coating. Damages on the coating exposed to outdoor conditions or water, could cause corrosion. Chemical substances affect the anticorrosion covering protection.

EU Regulation 874/2012 - Illumination equipment energy classes

	LED VERSION: Class A/A+/A++ Luminaire supplied with integrated LED modules that cannot be replaced
	
	
	METAL HALIDE VERSION: Class A+ HIT-TC-CE/G8,5
	FLUORESCENT VERSION: Class A TC-TEL/GX24q-3
	HALOGEN VERSION: Class D QPAR30S/E27



Wall fitting



The fitting is equipped with 2 cable input

Protection against impact.
IK 08 - 5,00 joule

Emma110 - Bidirectional



1180121.A
QPAR30S 75W E27
Lamp max size: Ø120 mm H.80 mm

1189821.A
TC-TEL 26W GX24 q-3
Electronic ballast

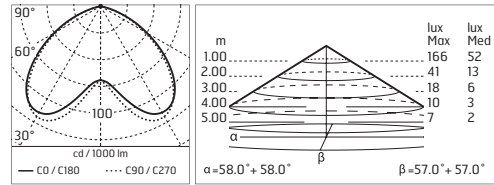
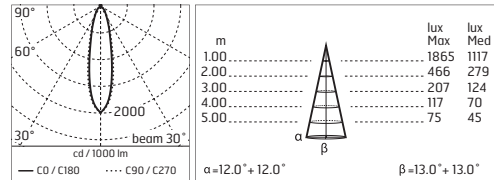
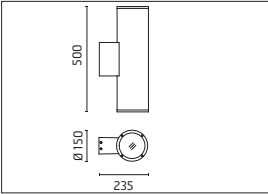

IP66

Emma150 - Unidirectional - 16°



1186712.A
HIT-TC-CE 35W G8.5
Electronic ballast

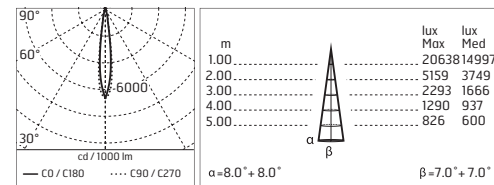
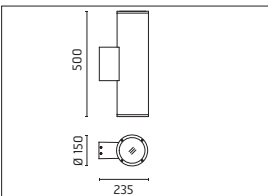

IP66

Emma150 - Unidirectional - 40°



1186721.A
HIT-TC-CE 35W G8.5
Electronic ballast

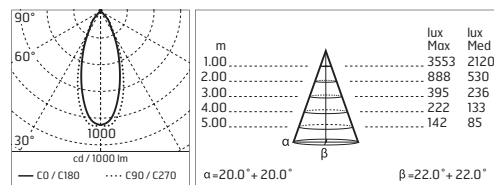
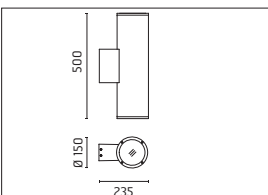

IP66

Emma150 - Unidirectional - 18°

Light Source: CoB LED / 17W / Total power 20W / CRI>80 / 220÷240V / Integral electronic power supply



118282150.A
White 2700K
lm LED 2744 = lm OUTPUT 2121

118272150.A
White 3000K
lm LED 2950 = lm OUTPUT 2281

118271150.A
White 4000K
lm LED 3080 = lm OUTPUT 2382

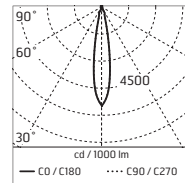
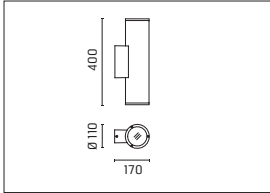

m	lux	
	Max	Med
1.00	13047	8310
2.00	3262	2078
3.00	1450	923
4.00	815	519
5.00	522	332

$\alpha = 9.0^\circ + 9.0^\circ$ $\beta = 9.0^\circ + 9.0^\circ$

@ 4000K

IP66

Emma150 - Unidirectional - 42°

Light Source: CoB LED / 17W / Total power 20W / CRI>80 / 220÷240V / Integral electronic power supply

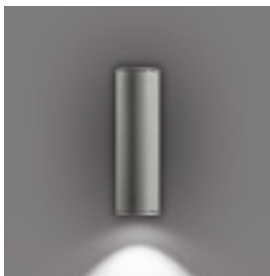

118282151.A
White 2700K
lm LED 2744 = lm OUTPUT 2030

118272151.A
White 3000K
lm LED 2950 = lm OUTPUT 2183

118271151.A
White 4000K
lm LED 3080 = lm OUTPUT 2279

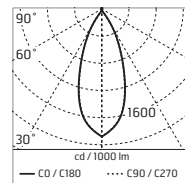
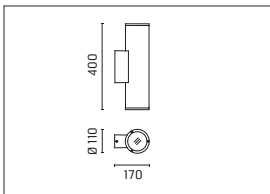

m	lux	
	Max	Med
1.00	4294	2517
2.00	1074	629
3.00	477	280
4.00	268	157
5.00	172	101

$\alpha = 21.0^\circ + 21.0^\circ$ $\beta = 21.0^\circ + 21.0^\circ$

@ 4000K

IP66

Emma110 - Bidirectional



1180242.A
QPAR30S 2x75W E27
Lamp max size: Ø120 mm H.80 mm

11815142.A
TC-TEL 2x26W GX24 q-3
Electronic ballast

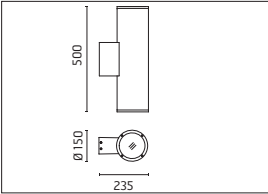
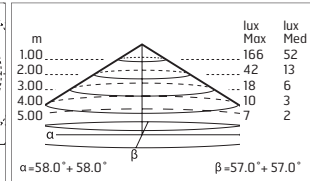
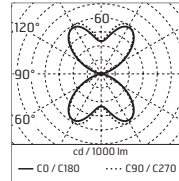
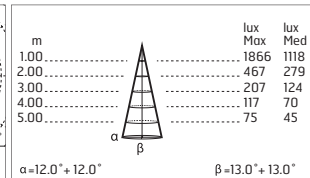
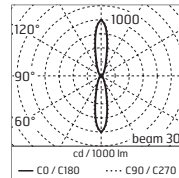

IP66

Emma150 - Bidirectional - 16°



11815212.A
HIT-TC-CE 2x35W G8.5
Electronic ballast

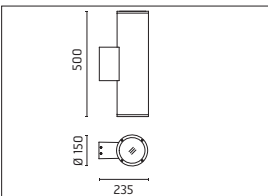
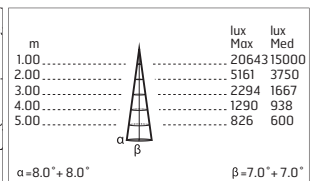
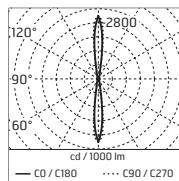

IP66

Emma150 - Bidirectional - 40°



11815242.A
HIT-TC-CE 2x35W G8.5
Electronic ballast

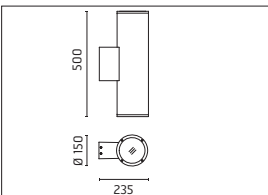
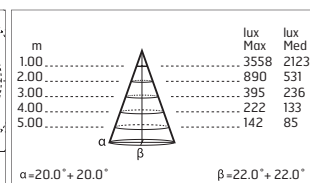
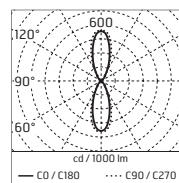

IP66

Emma150 - Bidirectional - 18°

Light Source: CoB LED / 34W / Total power 39W / CRI>80 / 220÷240V / Integral electronic power supply



118282152.A
White 2700K
lm LED 2x2744 ≠ lm OUTPUT 2x2121

118272152.A
White 3000K
lm LED 2x2950 ≠ lm OUTPUT 2x2281

118271152.A
White 4000K
lm LED 2x3080 ≠ lm OUTPUT 2x2382

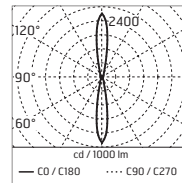
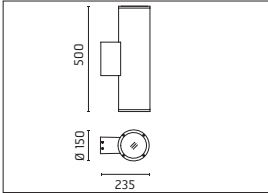

m	lux	
	Max	Med
1.00	13046	8310
2.00	3262	2077
3.00	1450	923
4.00	815	519
5.00	522	332

$\alpha = 9.0^\circ + 9.0^\circ$ $\beta = 9.0^\circ + 9.0^\circ$
@ 4000K

IP66

Emma150 - Bidirectional - 42°

Light Source: CoB LED / 34W / Total power 39W / CRI>80 / 220÷240V / Integral electronic power supply



118282153.A
White 2700K
lm LED 2x2744 ≠ lm OUTPUT 2x2030

118272153.A
White 3000K
lm LED 2x2950 ≠ lm OUTPUT 2x2183

118271153.A
White 4000K
lm LED 2x3080 ≠ lm OUTPUT 2x2279

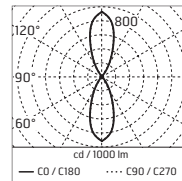
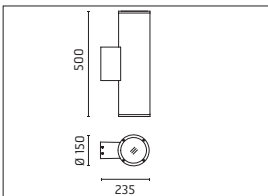

m	lux	
	Max	Med
1.00	4294	2517
2.00	1074	629
3.00	477	280
4.00	268	157
5.00	172	101

$\alpha = 21.0^\circ + 21.0^\circ$ $\beta = 21.0^\circ + 21.0^\circ$
@ 4000K

IP66



Accessories: Emma150

237

SPD: (SURGE PROTECTION DEVICE)
 275Vac
 MAXIMUM DISCHARGE CURRENT
 10KA (8/20µs)
 MAXIMUM OPERATING CURRENT 5A
 SUITABLE FOR SERIES CONNEC-
 TION - IP66

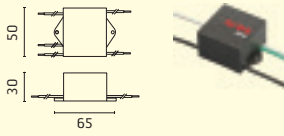

acc. code ▶	237
prod. code ▼	
1180121.A	
1180242.A	
1186712.A	
1186721.A	
1189821.A	
11815142.A	
11815212.A	
11815242.A	
118271150.A	•
118271151.A	•
118271152.A	•
118271153.A	•
118272150.A	•
118272151.A	•
118272152.A	•
118272153.A	•
118282150.A	•
118282151.A	•
118282152.A	•
118282153.A	•



- Luminaire for installation on wall – surface mounted.
- Configuration: turned aluminium body (EN AW6060 alloy) and AISI 316L stainless steel fixing bracket. Glass diffuser: extra clear with silkscreen border, fixed to the body by a double-sided tape.
- Double layer coating for high resistance to corrosion: the aluminium components are painted with a double coat using powders that are compliant with QUALICOAT standards: a first layer of epoxy powder (with excellent chemical and mechanical resistance) and a second finishing layer of polyester powder (resistant to UV rays and atmospheric agents). The entire painting process of the aluminium fitting starts from components that have been sandblasted in advance to make the surface more porous and increase the adherence of the paint. Ares effects alkaline and acid washing to clean the surfaces completely, then rinses with demineralised water to remove any residue particles, subsequently a chemical conversion treatment is done to protect against rusting.
- Protection rating: IP65
- In compliance with EN 60598-1 standards
- Class of insulation: III
- Installation: the luminaire is supplied with a piece of cable (approx. 250mm) for an easy-to-make connection and it is equipped with a dc/dc resin-coated converter that removes electromagnetic interference. The luminaire is protected against polarity reversal and sudden voltage peak. Parallel wiring required.
- We recommend the use of a connection system with a protection degree greater than or equal to the protection degree of the luminaire.
- During the installation and the maintenance of the fixtures it is important to be careful and avoid damages on the paint coating. Damages on the coating exposed to outdoor conditions or water, could cause corrosion. Chemical substances affect the anticorrosion covering protection.

EU Regulation 874/2012 - Illumination equipment energy classes

A++
A+
A

LED VERSION:
Class A/A+/A++
Luminaire supplied with integrated LED modules that cannot be replaced



Wall fitting



Pre-wired with approx 250mm of cable



Remote device required.



Protection against impact.
IK 05 - 0,70 joule

Epsilon - 10°

Light Source: Power LED / 2,2W / Total power 3,4W / CRI>80 / 24Vdc / Remote electronic power supply to be ordered



508005
White 2700K
lm LED 169 ≠ lm OUTPUT 118



508003
White 3000K
lm LED 182 ≠ lm OUTPUT 127

508002
White 4000K
lm LED 198 ≠ lm OUTPUT 138

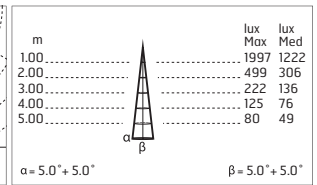
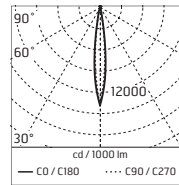

@ 4000K

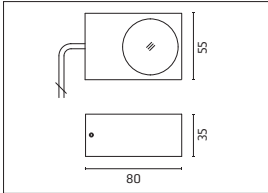

IP65

Epsilon - 30°

Light Source: Power LED / 2,2W / Total power 3,4W / CRI>80 / 24Vdc / Remote electronic power supply to be ordered

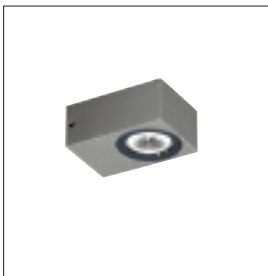

508015
White 2700K
lm LED 169 ≠ lm OUTPUT 106



508013
White 3000K
lm LED 182 ≠ lm OUTPUT 114

508012
White 4000K
lm LED 198 ≠ lm OUTPUT 125

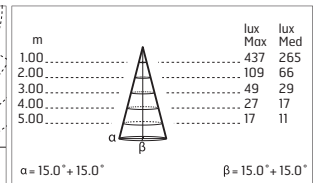
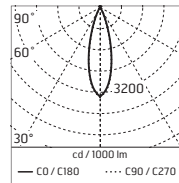

@ 4000K

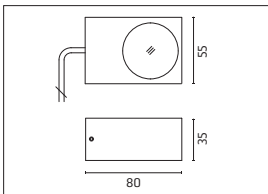

IP65

Epsilon - 10°

Light Source: Power LED / 3,3W / Total power 4,5W / CRI>80 / 24Vdc / Remote electronic power supply to be ordered



508025
White 2700K
lm LED 307 ≈ lm OUTPUT 219

508023
White 3000K
lm LED 330 ≈ lm OUTPUT 236

508022
White 4000K
lm LED 360 ≈ lm OUTPUT 258

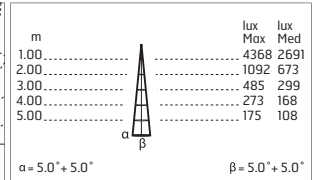
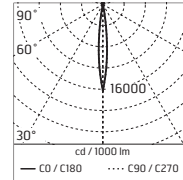

@ 4000K

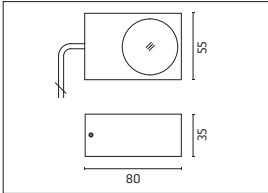

IP65

Epsilon - 30°

Light Source: Power LED / 3,3W / Total power 4,5W / CRI>80 / 24Vdc / Remote electronic power supply to be ordered



508035
White 2700K
lm LED 307 ≈ lm OUTPUT 176

508033
White 3000K
lm LED 330 ≈ lm OUTPUT 189

508032
White 4000K
lm LED 360 ≈ lm OUTPUT 207

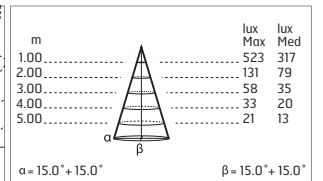
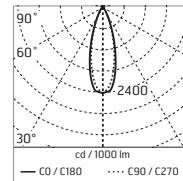

@ 4000K

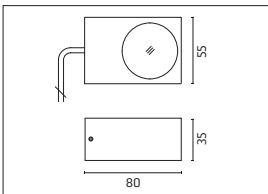

IP65



Accessories: Epsilon

150

POWER SUPPLY DUAL FUNCTION
Vout 24Vdc: 8W/100÷240V
Iout 350mA: 6x1W/100÷240V
IP20 CLASS II SELV EQ.

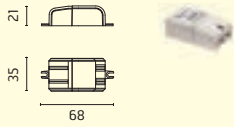

106

POWER SUPPLY DUAL FUNCTION
Vout 24Vdc: 8W/100÷240V
Iout 350mA: 6x1W/100÷240V
IP65 CLASS II SELV EQ.

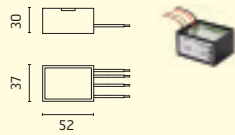

87

POWER SUPPLY 10W/110÷240V -
24Vdc IP20 CLASS II SELV.

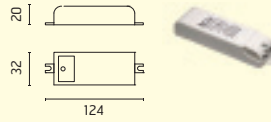

175

POWER SUPPLY 10W/110÷240V -
24Vdc IP67 CLASS II SELV.

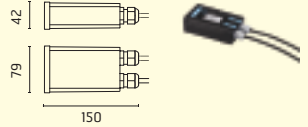

147

POWER SUPPLY 20W/220÷240V -
24Vdc IP67 CLASS II SELV.

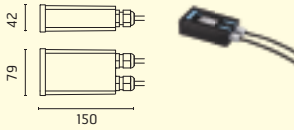

155

POWER SUPPLY 50W/120÷240V -
24Vdc IP67 CLASS II SELV.

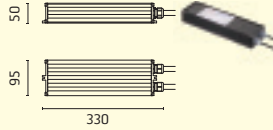

110

POWER SUPPLY 70W/220÷240V -
24Vdc IP67 CLASS II SELV EQ.

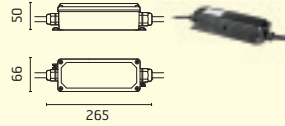

acc. code ▶	150	106	87	175	147	155	110
prod. code ▼							
508002	1	1	2	2	3	9	17
508003	1	1	2	2	3	9	17
508005	1	1	2	2	3	9	17
508012	1	1	2	2	3	9	17
508013	1	1	2	2	3	9	17
508015	1	1	2	2	3	9	17
508022	1	1	2	2		7	14
508023	1	1	2	2		7	14
508025	1	1	2	2		7	14
508032	1	1	2	2		7	14
508033	1	1	2	2		7	14
508035	1	1	2	2		7	14

Max fixtures for each power supply (Vin 220÷240). Data in the chart are provided as a guide only. Please verify according to your installation.



- Luminaire for installation on wall – surface mounted.
- Configuration: turned aluminium body (EN AW6060 alloy) and AISI 316L stainless steel fixing bracket. Glass diffuser: extra clear with silkscreen border, fixed to the body by a double-sided tape.
- Double layer coating for high resistance to corrosion: the aluminium components are painted with a double coat using powders that are compliant with QUALICOAT standards: a first layer of epoxy powder (with excellent chemical and mechanical resistance) and a second finishing layer of polyester powder (resistant to UV rays and atmospheric agents). The entire painting process of the aluminium fitting starts from components that have been sandblasted in advance to make the surface more porous and increase the adherence of the paint. Ares effects alkaline and acid washing to clean the surfaces completely, then rinses with demineralised water to remove any residue particles, subsequently a chemical conversion treatment is done to protect against rusting.
- Protection rating: IP65
- In compliance with EN 60598-1 standards
- Class of insulation: III
- Installation: the luminaire is supplied with a piece of cable (approx. 250mm) for an easy-to-make connection and it is equipped with a dc/dc resin-coated converter that removes electromagnetic interference. The luminaire is protected against polarity reversal and sudden voltage peak. Parallel wiring required.
- We recommend the use of a connection system with a protection degree greater than or equal to the protection degree of the luminaire.
- During the installation and the maintenance of the fixtures it is important to be careful and avoid damages on the paint coating. Damages on the coating exposed to outdoor conditions or water, could cause corrosion. Chemical substances affect the anticorrosion covering protection.

EU Regulation 874/2012 - Illumination equipment energy classes



LED VERSION:
Class A/A+/A++
Luminaire supplied
with integrated LED modules
that cannot be replaced



.1 White



.6 Grey



.3 Anthracite



.4 Black



.18 Deep Brown



Wall fitting

Pre-wired with approx
250mm of cable.

Remote device required.

Protection against
impact.
IK 05 - 0,70 joule

Delta - Unidirectional - 10°

Light Source: Power LED / 2,2W / Total power 3,4W / CRI>80 / 24Vdc / Remote electronic power supply to be ordered



507005
White 2700K
lm LED 169 ≠ lm OUTPUT 118



507003
White 3000K
lm LED 182 ≠ lm OUTPUT 127

507002
White 4000K
lm LED 198 ≠ lm OUTPUT 138

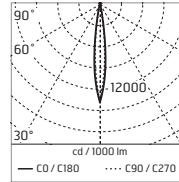

m	lux	
	Max	Med
1.00	1997	1222
2.00	499	306
3.00	222	136
4.00	125	76
5.00	80	49

$\alpha = 5.0^\circ + 5.0^\circ$ $\beta = 5.0^\circ + 5.0^\circ$

@ 4000K

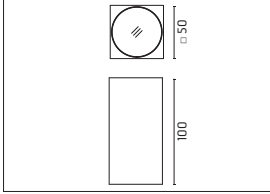

IP65

Delta - Unidirectional - 30°

Light Source: Power LED / 2,2W / Total power 3,4W / CRI>80 / 24Vdc / Remote electronic power supply to be ordered



507015
White 2700K
lm LED 169 ≠ lm OUTPUT 106



507013
White 3000K
lm LED 182 ≠ lm OUTPUT 114

507012
White 4000K
lm LED 198 ≠ lm OUTPUT 125

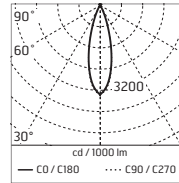

m	lux	
	Max	Med
1.00	437	265
2.00	109	66
3.00	49	29
4.00	27	17
5.00	17	11

$\alpha = 15.0^\circ + 15.0^\circ$ $\beta = 15.0^\circ + 15.0^\circ$

@ 4000K

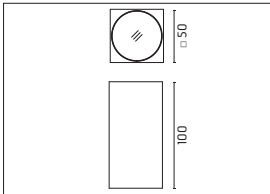

IP65

Delta - Unidirectional - 10°

Light Source: Power LED / 3,3W / Total power 4,5W / CRI>80 / 24Vdc / Remote electronic power supply to be ordered



507025
White 2700K
lm LED 307 ≠ lm OUTPUT 219



507023
White 3000K
lm LED 330 ≠ lm OUTPUT 236

507022
White 4000K
lm LED 360 ≠ lm OUTPUT 258

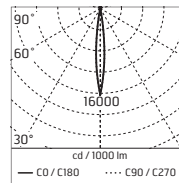

m	lux	
	Max	Med
1.00	4368	2691
2.00	1092	673
3.00	485	299
4.00	273	168
5.00	175	108

$\alpha = 5.0^\circ + 5.0^\circ$ $\beta = 5.0^\circ + 5.0^\circ$

@ 4000K

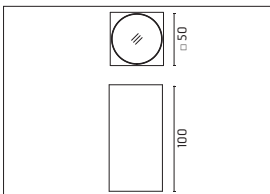

IP65

Delta - Unidirectional - 30°

Light Source: Power LED / 3,3W / Total power 4,5W / CRI>80 / 24Vdc / Remote electronic power supply to be ordered



507035
White 2700K
lm LED 307 ≈ lm OUTPUT 176

507033
White 3000K
lm LED 330 ≈ lm OUTPUT 189

507032
White 4000K
lm LED 360 ≈ lm OUTPUT 207

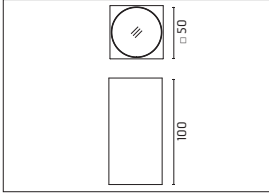
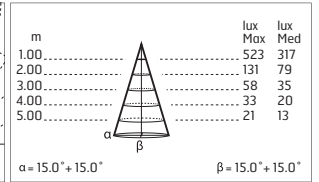
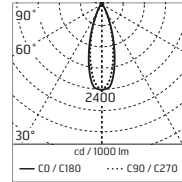

@ 4000K

IP65

Delta - Bidirectional - 10°

Light Source: Power LED / 4,4W / Total power 6,8W / CRI>80 / 24Vdc / Remote electronic power supply to be ordered



507105
White 2700K
lm LED 2x169 ≈ lm OUTPUT 2x118

507103
White 3000K
lm LED 2x182 ≈ lm OUTPUT 2x127

507102
White 4000K
lm LED 2x198 ≈ lm OUTPUT 2x138

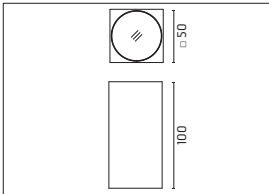
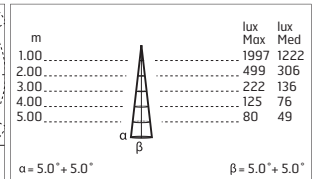
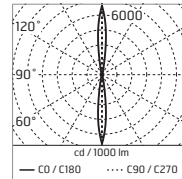

@ 4000K

IP65

Delta - Bidirectional - 30°

Light Source: Power LED / 4,4W / Total power 6,8W / CRI>80 / 24Vdc / Remote electronic power supply to be ordered



507115
White 2700K
lm LED 2x169 ≈ lm OUTPUT 2x106

507113
White 3000K
lm LED 2x182 ≈ lm OUTPUT 2x114

507112
White 4000K
lm LED 2x198 ≈ lm OUTPUT 2x125

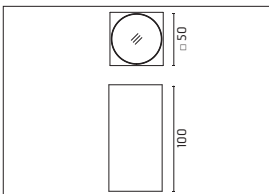
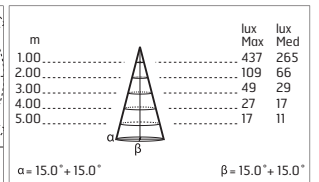
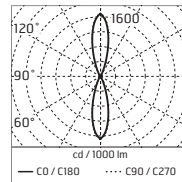

@ 4000K

IP65

Delta - Bidirectional - 10°

Light Source: Power LED / 6,6W / Total power 9W / CRI>80 / 24Vdc / Remote electronic power supply to be ordered



507125
White 2700K
lm LED 2x307 = lm OUTPUT 2x219

507123
White 3000K
lm LED 2x330 = lm OUTPUT 2x236

507122
White 4000K
lm LED 2x360 = lm OUTPUT 2x258

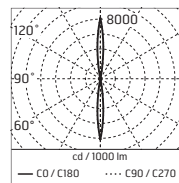

m	lux	
	Max	Med
1.00	4368	2691
2.00	1092	673
3.00	485	299
4.00	273	168
5.00	175	108

$\alpha = 5.0^\circ + 5.0^\circ$ $\beta = 5.0^\circ + 5.0^\circ$
@ 4000K

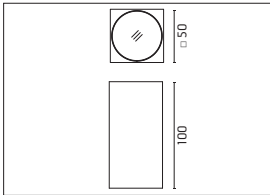

IP65

Delta - Bidirectional - 30°

Light Source: Power LED / 6,6W / Total power 9W / CRI>80 / 24Vdc / Remote electronic power supply to be ordered



507135
White 2700K
lm LED 2x307 = lm OUTPUT 2x176

507133
White 3000K
lm LED 2x330 = lm OUTPUT 2x189

507132
White 4000K
lm LED 2x360 = lm OUTPUT 2x207

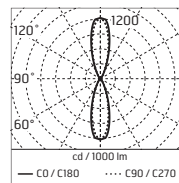

m	lux	
	Max	Med
1.00	523	317
2.00	131	79
3.00	58	35
4.00	33	20
5.00	21	13

$\alpha = 15.0^\circ + 15.0^\circ$ $\beta = 15.0^\circ + 15.0^\circ$
@ 4000K

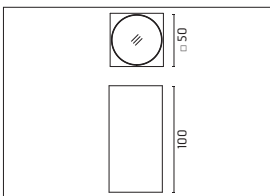

IP65

Accessories: Delta

150
POWER SUPPLY DUAL FUNCTION
Vout 24Vdc: 8W/100÷240V
Iout 350mA: 6x1W/100÷240V
IP20 CLASS II SELV EQ.

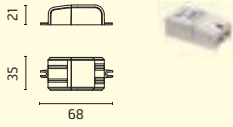

106
POWER SUPPLY DUAL FUNCTION
Vout 24Vdc: 8W/100÷240V
Iout 350mA: 6x1W/100÷240V
IP65 CLASS II SELV EQ.

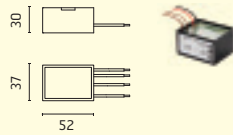

87
POWER SUPPLY 10W/110÷240V -
24Vdc IP20 CLASS II SELV.

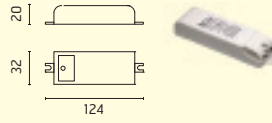

175
POWER SUPPLY 10W/110÷240V - 24Vdc
IP67 CLASS II SELV.

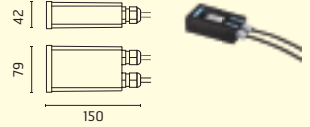

147
POWER SUPPLY 20W/220÷240V -
24Vdc IP67 CLASS II SELV.

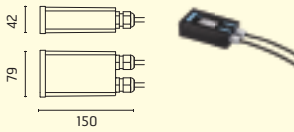

155
POWER SUPPLY 50W/120÷240V -
24Vdc IP67 CLASS II SELV.

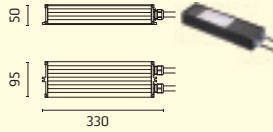

110
POWER SUPPLY 70W/220÷240V -
24Vdc IP67 CLASS II SELV EQ.

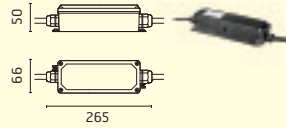

acc. code ▶	150	106	87	175	147	155	110
507002	1	1	2	2	3	9	17
507003	1	1	2	2	3	9	17
507005	1	1	2	2	3	9	17
507012	1	1	2	2	3	9	17
507013	1	1	2	2	3	9	17
507015	1	1	2	2	3	9	17
507022	1	1	2	2		7	14
507023	1	1	2	2		7	14
507025	1	1	2	2		7	14
507032	1	1	2	2		7	14
507033	1	1	2	2		7	14
507035	1	1	2	2		7	14
507102			1	1	2	5	8
507103			1	1	2	5	8
507105			1	1	2	5	8
507112			1	1	2	5	8
507113			1	1	2	5	8
507115			1	1	2	5	8
507122			1	1		3	7
507123			1	1		3	7
507125			1	1		3	7
507132			1	1		3	7
507133			1	1		3	7
507135			1	1		3	7

Max fixtures for each power supply (Vin 220÷240). Data in the chart are provided as a guide only. Please verify according to your installation.



- Round luminaire for installation on wall or ceiling – surface mounted.
- Configuration: turned aluminium body (EN AW6060 alloy) and AISI 316L stainless steel fixing bracket. Methacrylate diffuser fixed to the body a robotic gluing system.
- Double layer coating for high resistance to corrosion: the aluminium components are painted with a double coat using powders that are compliant with QUALICOAT standards: a first layer of epoxy powder (with excellent chemical and mechanical resistance) and a second finishing layer of polyester powder (resistant to UV rays and atmospheric agents). The entire painting process of the aluminium fitting starts from components that have been sandblasted in advance to make the surface more porous and increase the adherence of the paint. Ares effects alkaline and acid washing to clean the surfaces completely, then rinses with demineralised water to remove any residue particles, subsequently a chemical conversion treatment is done to protect against rusting.
- Protection rating: IP65
- In compliance with EN 60598-1 standards
- Class of insulation: III
- Installation: the luminaire is supplied with a piece of cable (approx. 250mm) for an easy-to-make connection and it is protected against polarity reversal and sudden voltage peak. Parallel wiring required.
- We recommend the use of a connection system with a protection degree greater than or equal to the protection degree of the luminaire.
- During the installation and the maintenance of the fixtures it is important to be careful and avoid damages on the paint coating. Damages on the coating exposed to outdoor conditions or water, could cause corrosion. Chemical substances affect the anticorrosion covering protection.

EU Regulation 874/2012 - Illumination equipment energy classes

A++
A+
A

LED VERSION:
Class A/A+/A++
Luminaire supplied with integrated LED modules that cannot be replaced

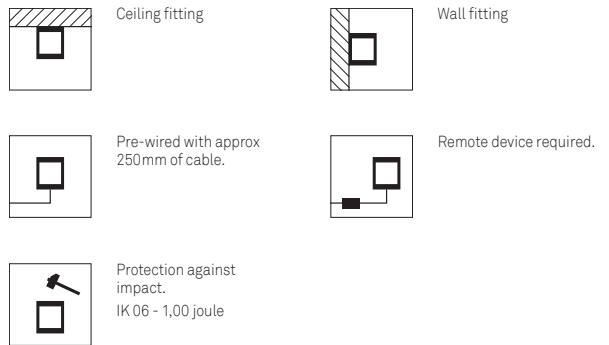

Alfa - Methacrylate Diffuser

Light Source: Low Power LED / 2W / Total power 2,5W / CRI>80 / 24Vdc / Remote electronic power supply to be ordered

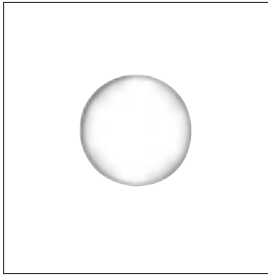

505005

White 2700K
lm LED 123 ≠ lm OUTPUT 44
Acc. 144, 176 or 252

505003

White 3000K
lm LED 132 ≠ lm OUTPUT 47
Acc. 144, 176 or 252

505002

White 4000K
lm LED 188 ≠ lm OUTPUT 65
Acc. 144, 176 or 252

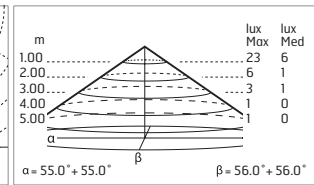
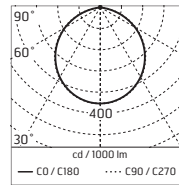

@ 4000K

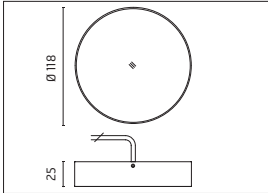

IP65   

Accessories: Alfa

105
3 MODULES RECESSED BOX
106 x 75 H 55mm

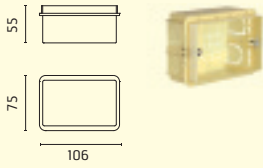

150
POWER SUPPLY DUAL FUNCTION
Vout 24Vdc: 8W/100÷240V
Iout 350mA: 6x1W/100÷240V
IP20 CLASS II SELV EQ.

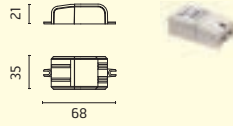

106
POWER SUPPLY DUAL FUNCTION
Vout 24Vdc: 8W/100÷240V
Iout 350mA: 6x1W/100÷240V
IP65 CLASS II SELV EQ.

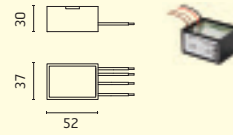

87
POWER SUPPLY 10W/110÷240V -
24Vdc IP20 CLASS II SELV.

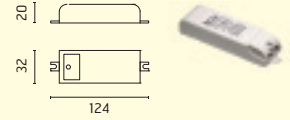

175
POWER SUPPLY 10W/110÷240V -
24Vdc IP67 CLASS II SELV.

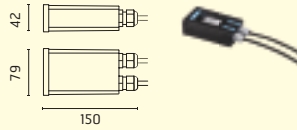

144
POWER SUPPLY 17W/110÷240V
- 24Vdc (15W@110V) IP20 CLASS
II SELV.

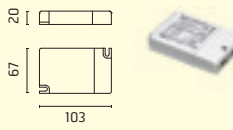

176
POWER SUPPLY 17W/110÷240V
- 24Vdc (15W@110V) IP67 CLASS
II SELV.

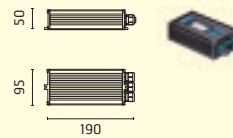

252
POWER SUPPLY 20W/110-240Vdc
(15W@110V) IP67 CLASS II SELV.

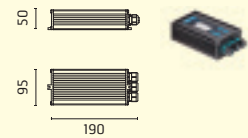

... DIMMABLE: PUSH-DIM OR 1...10V
See Page 558 Wiring Diagram n.4

... DIMMABLE: PUSH-DIM OR 1...10V
See Page 558 Wiring Diagram n.4

... DIMMABLE: DALI
See Page 558 Wiring Diagram n.4

147
POWER SUPPLY 20W/220÷240V -
24Vdc IP67 CLASS II SELV.

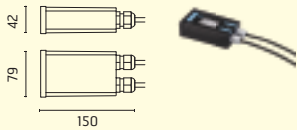

155
POWER SUPPLY 50W/120÷240V -
24Vdc IP67 CLASS II SELV.

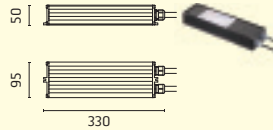

110
POWER SUPPLY 70W/220÷240V -
24Vdc IP67 CLASS II SELV EQ.

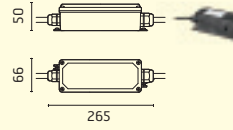

156
POWER SUPPLY 96W /120÷277V -
24Vdc IP67 CLASS II SELV.

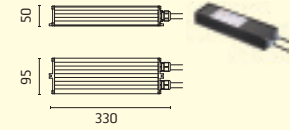

Alfa with box cod.105

Alfa without box cod.105

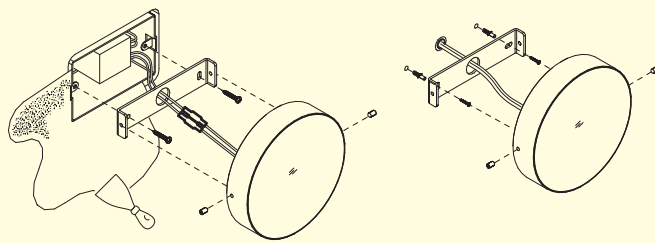

Optional: power supply code 106 in
recessed box

acc. code ▶	105	150	106	87	175	144	176	252	147	155	110	156
prod. code ▼												
505002	•	2	2	3	3	6	6	6	7	20	25	36
505003	•	2	2	3	3	6	6	6	7	20	25	36
505005	•	2	2	3	3	6	6	6	7	20	25	36

Max fixtures for each power supply (Vin 220÷240). Data in the chart are
provided as a guide only. Please verify according to your installation.



- Square luminaire for installation on wall or ceiling – surface mounted.
- Configuration: turned aluminium body (EN AW6060 alloy) and AISI 316L stainless steel fixing bracket. Methacrylate diffuser fixed to the body a robotic gluing system.
- Double layer coating for high resistance to corrosion: the aluminium components are painted with a double coat using powders that are compliant with QUALICOAT standards: a first layer of epoxy powder (with excellent chemical and mechanical resistance) and a second finishing layer of polyester powder (resistant to UV rays and atmospheric agents). The entire painting process of the aluminium fitting starts from components that have been sandblasted in advance to make the surface more porous and increase the adherence of the paint. Ares effects alkaline and acid washing to clean the surfaces completely, then rinses with demineralised water to remove any residue particles, subsequently a chemical conversion treatment is done to protect against rusting.
- Protection rating: IP65
- In compliance with EN 60598-1 standards
- Class of insulation: III
- Installation: the luminaire is supplied with a piece of cable (approx. 250mm) for an easy-to-make connection and it is protected against polarity reversal and sudden voltage peak. Parallel wiring required.
- We recommend the use of a connection system with a protection degree greater than or equal to the protection degree of the luminaire.
- During the installation and the maintenance of the fixtures it is important to be careful and avoid damages on the paint coating. Damages on the coating exposed to outdoor conditions or water, could cause corrosion. Chemical substances affect the anticorrosion covering protection.

EU Regulation 874/2012 - Illumination equipment energy classes



LED VERSION:
Class A/A+/A++
Luminaire supplied
with integrated LED modules
that cannot be replaced



Ceiling fitting



Wall fitting

Pre-wired with approx
250mm of cable.Remote device
required.Protection against
impact.
IK 06 - 1,00 joule

Beta - Methacrylate Diffuser

Light Source: Low Power LED / 2,5W / Total power 3W / CRI>80 / 24Vdc / Remote electronic power supply to be ordered

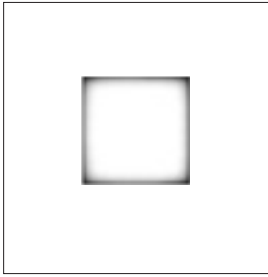

506005

White 2700K
lm LED 147 \approx lm OUTPUT 50

Acc. 144, 176 or 252

506003

White 3000K
lm LED 158 \approx lm OUTPUT 54

Acc. 144, 176 or 252

506002

White 4000K
lm LED 225 \approx lm OUTPUT 74

Acc. 144, 176 or 252

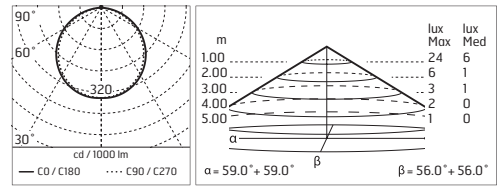
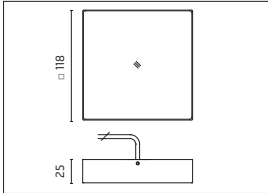

@ 4000K

IP65

Accessories: Beta

105
3 MODULES RECESSED BOX
106 x 75 H 55mm

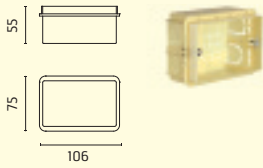

150
POWER SUPPLY DUAL FUNCTION
Vout 24Vdc: 8W/100÷240V
Iout 350mA: 6x1W/100÷240V
IP20 CLASS II SELV EQ.

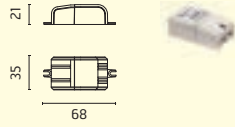

106
POWER SUPPLY DUAL FUNCTION
Vout 24Vdc: 8W/100÷240V
Iout 350mA: 6x1W/100÷240V
IP65 CLASS II SELV EQ.

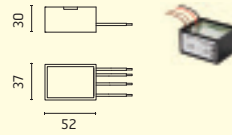

87
POWER SUPPLY 10W/110÷240V -
24Vdc IP20 CLASS II SELV.

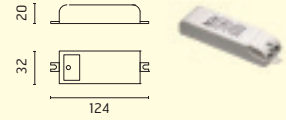

175
POWER SUPPLY 10W/110÷240V -
24Vdc IP67 CLASS II SELV.

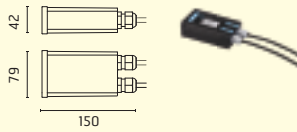

144
POWER SUPPLY 17W/110÷240V -
24Vdc (15W@110V) IP20 CLASS
II SELV.

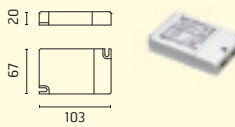

176
POWER SUPPLY 17W/110÷240V -
24Vdc (15W@110V) IP67 CLASS
II SELV.

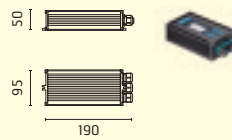

252
POWER SUPPLY 20W/110-240Vdc
(15W@110V) IP67 CLASS II SELV.

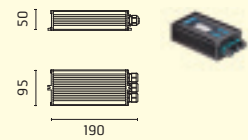

... DIMMABLE: PUSH-DIM OR 1...10V
See Page 558 Wiring Diagram n.4

... DIMMABLE: PUSH-DIM OR 1...10V
See Page 558 Wiring Diagram n.4

... DIMMABLE: DALI
See Page 558 Wiring Diagram n.4

147
POWER SUPPLY 20W/220÷240V -
24Vdc IP67 CLASS II SELV.

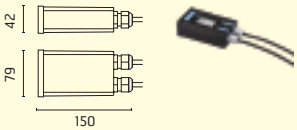

155
POWER SUPPLY 50W/120÷240V -
24Vdc IP67 CLASS II SELV.

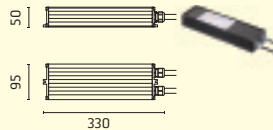

110
POWER SUPPLY 70W/220÷240V -
24Vdc IP67 CLASS II SELV EQ.

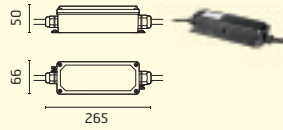

156
POWER SUPPLY 96W /120÷277V -
24Vdc IP67 CLASS II SELV EQ.

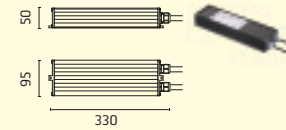

Beta with box cod.105

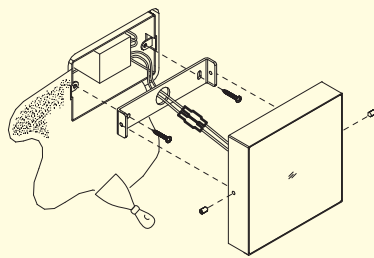

Beta without box cod.105

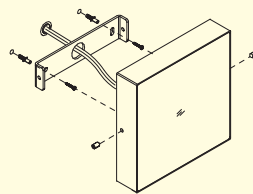

Optional: power supply code 106 in
recessed box

acc. code ▶	105	150	106	87	175	144	176	252	147	155	110	156
prod. code ▼												
506002	●	2	2	3	3	5	5	5	6	15	20	28
506003	●	2	2	3	3	5	5	5	6	15	20	28
506005	●	2	2	3	3	5	5	5	6	15	20	28

Max fixtures for each power supply (Vin 220÷240). Data in the chart are provided as a guide only. Please verify according to your installation.



- Square luminaire for installation on wall – surface mounted.
- Configuration: turned aluminium body (EN AW6060 alloy) and AISI 316L stainless steel fixing bracket. Methacrylate diffuser fixed to the body by a double-sided tape.
- Double layer coating for high resistance to corrosion: the aluminium components are painted with a double coat using powders that are compliant with QUALICOAT standards: a first layer of epoxy powder (with excellent chemical and mechanical resistance) and a second finishing layer of polyester powder (resistant to UV rays and atmospheric agents). The entire painting process of the aluminium fitting starts from components that have been sandblasted in advance to make the surface more porous and increase the adherence of the paint. Ares effects alkaline and acid washing to clean the surfaces completely, then rinses with demineralised water to remove any residue particles, subsequently a chemical conversion treatment is done to protect against rusting.
- Protection rating: IP65
- In compliance with EN 60598-1 standards
- Class of insulation: III
- Installation: the luminaire is supplied with a piece of cable (approx. 250mm) for an easy-to-make connection and it is protected against polarity reversal and sudden voltage peak. Parallel wiring required.
- We recommend the use of a connection system with a protection degree greater than or equal to the protection degree of the luminaire.
- During the installation and the maintenance of the fixtures it is important to be careful and avoid damages on the paint coating. Damages on the coating exposed to outdoor conditions or water, could cause corrosion. Chemical substances affect the anticorrosion covering protection.

EU Regulation 874/2012 - Illumination equipment energy classes



LED VERSION:
Class A/A+/A++
Luminaire supplied
with integrated LED modules
that cannot be replaced



.1 White



.6 Grey



.3 Anthracite



.4 Black



.18 Deep Brown



Wall fitting



Recessed wall fitting.



Remote device required.



Pre-wired with approx 250mm of cable



Protection against impact.
IK 03 - 0,35 joule

Gamma - Unidirectional

Light Source: Mid Power LED / 1,8W / Total power 2,5W / CRI>80 / 24Vdc / Remote electronic power supply to be ordered



512005
White 2700K
lm LED 246 ≠ lm OUTPUT 125
Acc. 144, 176 or 252

512003
White 3000K
lm LED 265 ≠ lm OUTPUT 134
Acc. 144, 176 or 252

512002
White 4000K
lm LED 278 ≠ lm OUTPUT 142
Acc. 144, 176 or 252

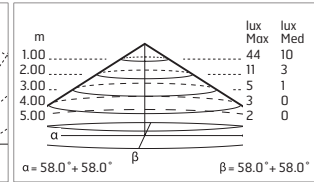
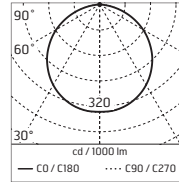

@ 4000K

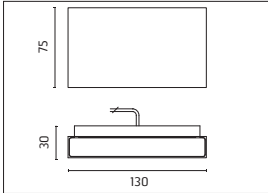

IP65

Gamma - Bidirectional

Light Source: Mid Power LED / 3,6W / Total power 5W / CRI>80 / 24Vdc / Remote electronic power supply to be ordered



512015
White 2700K
lm LED 2x246 ≠ lm OUTPUT 2x125
Acc. 144, 176 or 252

512013
White 3000K
lm LED 2x265 ≠ lm OUTPUT 2x134
Acc. 144, 176 or 252

512012
White 4000K
lm LED 2x278 ≠ lm OUTPUT 2x142
Acc. 144, 176 or 252

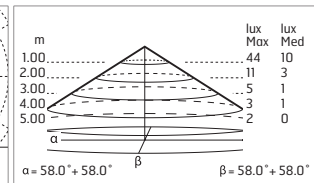
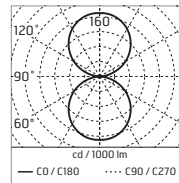

@ 4000K

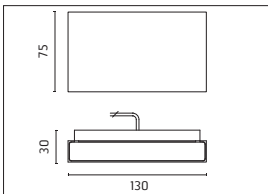

IP65

Accessories: Gamma

105
3 MODULES RECESSED BOX
106 x 75 H 55mm

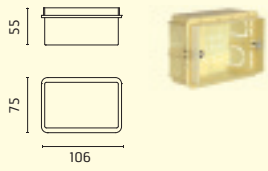

150
POWER SUPPLY DUAL FUNCTION
Vout 24Vdc: 8W/100÷240V
Iout 350mA: 6x1W/100÷240V
IP20 CLASS II SELV EQ.

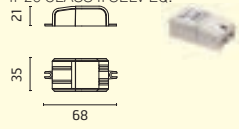

106
POWER SUPPLY DUAL FUNCTION
Vout 24Vdc: 8W/100÷240V
Iout 350mA: 6x1W/100÷240V
IP65 CLASS II SELV EQ.

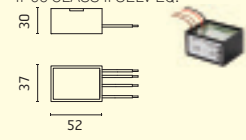

87
POWER SUPPLY 10W/110÷240V -
24Vdc IP20 CLASS II SELV.

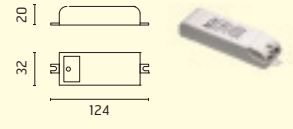

175
POWER SUPPLY 10W/110÷240V -
24Vdc IP67 CLASS II SELV.

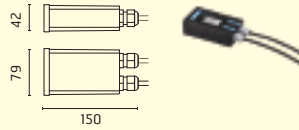

144
POWER SUPPLY 17W/110÷240V -
24Vdc (15W@110V) IP20 CLASS II
SELV.

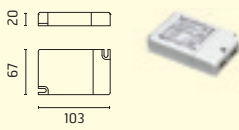

176
POWER SUPPLY 17W/110÷240V -
24Vdc (15W@110V) IP67 CLASS
II SELV.

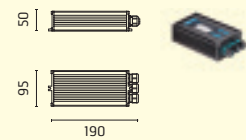

252
POWER SUPPLY 20W/110-240Vdc
(15W@110V) IP67 CLASS II SELV.

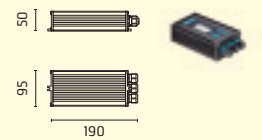

... DIMMABLE: PUSH-DIM OR 1...10V
See Page 558 Wiring Diagram n.4

... DIMMABLE: PUSH-DIM OR 1...10V
See Page 558 Wiring Diagram n.4

... DIMMABLE: DALI
See Page 558 Wiring Diagram n.4

147
POWER SUPPLY 20W/220÷240V -
24Vdc IP67 CLASS II SELV.

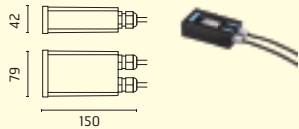

155
POWER SUPPLY 50W/120÷240V -
24Vdc IP67 CLASS II SELV.

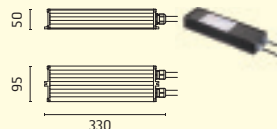

110
POWER SUPPLY 70W/220÷240V -
24Vdc IP67 CLASS II SELV EQ.

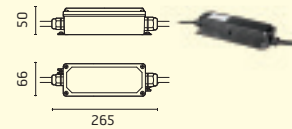

156
POWER SUPPLY 96W /120÷277V -
24Vdc IP67 CLASS II SELV.

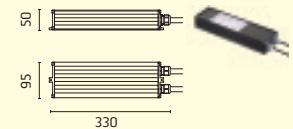

Gamma with box cod.105

Gamma without box cod.105

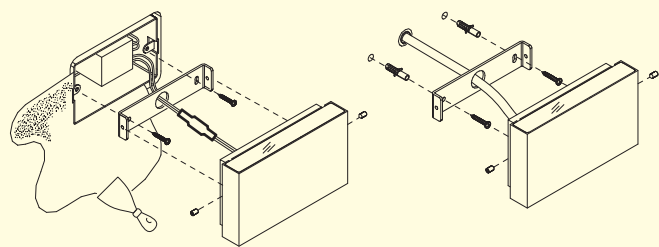

Optional: power supply code 106 in
recessed box

acc. code ▶	105	150	106	87	175	144	176	252	147	155	110	156
512002	•	3	3	4	4	6	6	6	8	20	25	35
512003	•	3	3	4	4	6	6	6	8	20	25	35
512005	•	3	3	4	4	6	6	6	8	20	25	35
512012	•	1	1	2	2	3	3	3	4	10	13	17
512013	•	1	1	2	2	3	3	3	4	10	13	17
512015	•	1	1	2	2	3	3	3	4	10	13	17

Max fixtures for each power supply (Vin 220÷240). Data in the chart are provided as a guide only. Please verify according to your installation.



- Luminaire for installation on wall – surface mounted.
- Configuration: die-cast aluminium structure, EN AB-47100 alloy (low copper content) and AISI 304 stainless steel fixing plate. Glass diffuser: transparent with silkscreen border, fixed to the aluminium structure through a robotic gluing system.
- Double layer coating for high resistance to corrosion: the aluminium components are painted with a double coat using powders that are compliant with QUALICOAT standards: a first layer of epoxy powder (with excellent chemical and mechanical resistance) and a second finishing layer of polyester powder (resistant to UV rays and atmospheric agents). The entire painting process of the aluminium fitting starts from components that have been sandblasted in advance to make the surface more porous and increase the adherence of the paint. Ares effects alkaline and acid washing to clean the surfaces completely, then rinses with demineralised water to remove any residue particles, subsequently a chemical conversion treatment is done to protect against rusting.
- Protection rating: IP65
- In compliance with EN 60598-1 standards
- Class of insulation: II
- Installation: wiring through two rubber cable glands (5mm\times9mm cables). Outdoor use requires suitable flexible cables assuring the watertightness of the cable gland.
- During the installation and the maintenance of the fixtures it is important to be careful and avoid damages on the paint coating. Damages on the coating exposed to outdoor conditions or water, could cause corrosion. Chemical substances affect the anticorrosion covering protection.

EU Regulation 874/2012 - Illumination equipment energy classes



LED VERSION:
Class A/A+/A++
Luminaire supplied
with integrated LED modules
that cannot be replaced



.1 White



.6 Grey



.3 Anthracite



.4 Black



.18 Deep Brown



Wall fitting



The fitting is
equipped with
2 cable input



Protection against
impact.
IK 02 - 0,20 joule

Marco - Unidirectional - 10°

Light Source: Power LED / 1,1W / Total power 3W / CRI>80 / 100÷240V / Integral electronic power supply

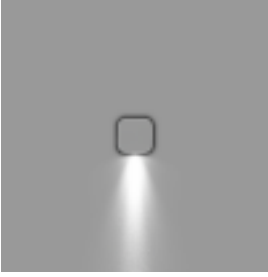

10727643
White 2700K
lm LED 112 ≈ lm OUTPUT 89



10711643
White 3000K
lm LED 120 ≈ lm OUTPUT 96

10723043
White 4000K
lm LED 130 ≈ lm OUTPUT 104

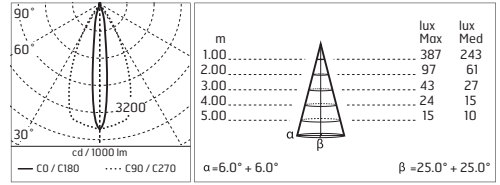

@ 4000K

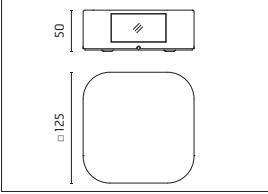

IP65

Marco - Unidirectional - 75°

Light Source: Power LED / 1,1W / Total power 3W / CRI>80 / 100÷240V / Integral electronic power supply



10727650
White 2700K
lm LED 112 ≈ lm OUTPUT 90



10711650
White 3000K
lm LED 120 ≈ lm OUTPUT 97

10723050
White 4000K
lm LED 130 ≈ lm OUTPUT 105

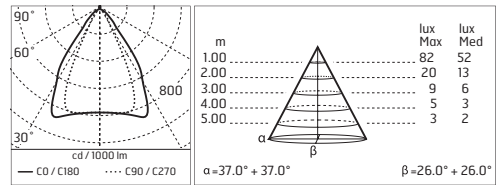

@ 4000K

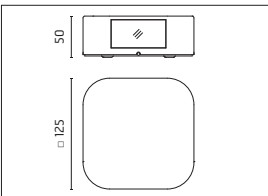

IP65

Marco - Bidirectional - 10°

Light Source: Power LED / 2,2W / Total power 4W / CRI>80 / 100÷240V / Integral electronic power supply



10727944
White 2700K
lm LED 2x112 ≠ lm OUTPUT 2x89

10711944
White 3000K
lm LED 2x120 ≠ lm OUTPUT 2x96

10723144
White 4000K
lm LED 2x130 ≠ lm OUTPUT 2x104

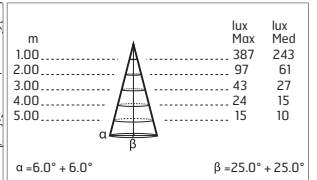
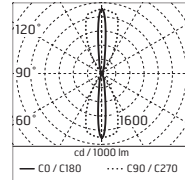
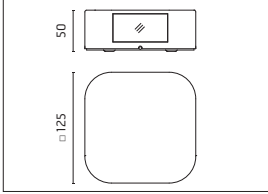

@ 4000K

IP65

Marco - Bidirectional - 75°

Light Source: Power LED / 2,2W / Total power 4W / CRI>80 / 100÷240V / Integral electronic power supply

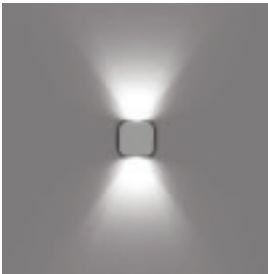

10727951
White 2700K
lm LED 2x112 ≠ lm OUTPUT 2x90

10711951
White 3000K
lm LED 2x120 ≠ lm OUTPUT 2x97

10723151
White 4000K
lm LED 2x130 ≠ lm OUTPUT 2x105

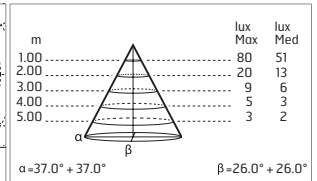
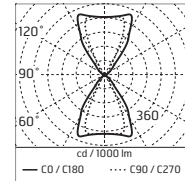
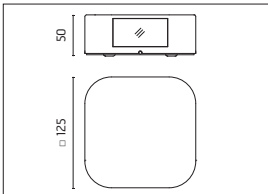

@ 4000K

IP65

Marco - Bidirectional - Combined: 10° + 75°

Light Source: Power LED / 2,2W / Total power 4W / CRI>80 / 100÷240V / Integral electronic power supply

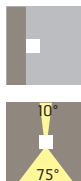

10727253
White 2700K
lm LED 2x112 ≠ lm OUTPUT 2x89+90

10712253
White 3000K
lm LED 2x120 ≠ lm OUTPUT 96+97

10723153
White 4000K
lm LED 2x130 ≠ lm OUTPUT 104+105

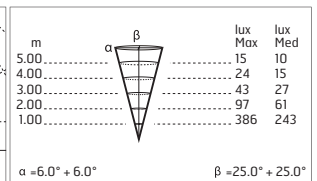
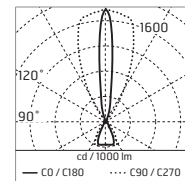
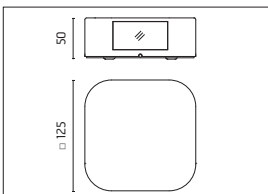

@ 4000K

IP65

Marco - Omnidirectional - 10°

Light Source: Power LED / 4,4W / Total power 7W / CRI>80 / 100÷240V / Integral electronic power supply

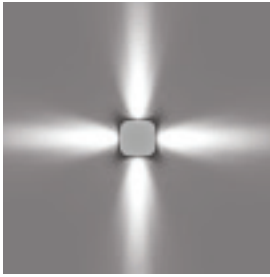

10727247
White 2700K
lm LED 4x112 ≈ lm OUTPUT 4x89

1079245
White 3000K
lm LED 4x120 ≈ lm OUTPUT 4x96

10723245
White 4000K
lm LED 4x130 ≈ lm OUTPUT 4x104

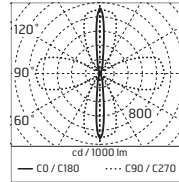

@ 4000K

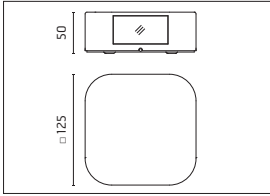

IP65

Marco - Omnidirectional - 75°

Light Source: Power LED / 4,4W / Total power 7W / CRI>80 / 100÷240V / Integral electronic power supply

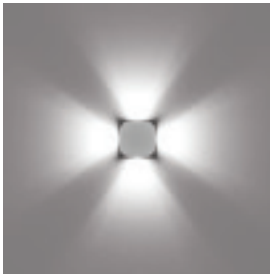

10727249
White 2700K
lm LED 4x112 ≈ lm OUTPUT 4x90

1079252
White 3000K
lm LED 4x120 ≈ lm OUTPUT 4x97

10723252
White 4000K
lm LED 4x130 ≈ lm OUTPUT 4x105

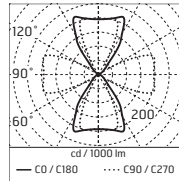

@ 4000K

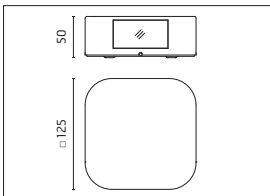

IP65





Accessories: Marco

237

SPD: (SURGE PROTECTION DEVICE)
 275Vac
 MAXIMUM DISCHARGE CURRENT
 10KA (8/20µs)
 MAXIMUM OPERATING CURRENT 5A
 SUITABLE FOR SERIES CONNEC-
 TION - IP66

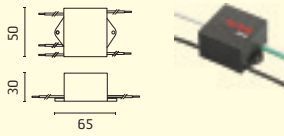





acc. code ▶	237
prod. code ▼	
1079245	•
1079252	•
10711643	•
10711650	•
10711944	•
10711951	•
10712253	•
10723043	•
10723050	•
10723144	•
10723151	•
10723153	•
10723245	•
10723252	•
10727247	•
10727249	•
10727253	•
10727643	•
10727650	•
10727944	•
10727951	•



- Luminaire for installation on wall – surface mounted.
- Configuration: die-cast aluminium structure, EN AB-47100 alloy (low copper content). Glass diffuser: transparent.
- Double layer coating for high resistance to corrosion: the aluminium components are painted with a double coat using powders that are compliant with QUALICOAT standards: a first layer of epoxy powder (with excellent chemical and mechanical resistance) and a second finishing layer of polyester powder (resistant to UV rays and atmospheric agents). The entire painting process of the aluminium fitting starts from components that have been sandblasted in advance to make the surface more porous and increase the adherence of the paint. Ares effects alkaline and acid washing to clean the surfaces completely, then rinses with demineralised water to remove any residue particles, subsequently a chemical conversion treatment is done to protect against rusting.
- Protection rating: IP54
- In compliance with EN 60598-1 standards
- Class of insulation: mains: I; low voltage: III
- Installation: wiring through a rubber cable holder (5mm\times10mm cables). Outdoor use requires suitable flexible cables assuring the watertightness of the cable holder.
- During the installation and the maintenance of the fixtures it is important to be careful and avoid damages on the paint coating. Damages on the coating exposed to outdoor conditions or water, could cause corrosion. Chemical substances affect the anticorrosion covering protection.

EU Regulation 874/2012 - Illumination equipment energy classes

    	<p>LED VERSION: Class A/A+/A++ Luminaire supplied with integrated LED modules that cannot be replaced</p> <p>HALOGEN VERSION: Class B QR.CBC51/GU5,3</p> <p>HALOGEN VERSION: Class D QPARCBC51/GZ10</p>
---	--

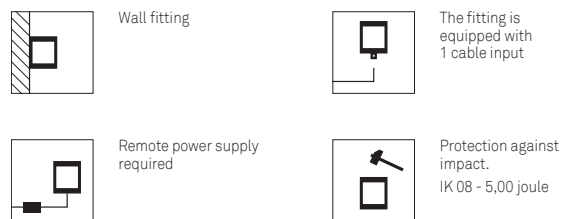

Jackie - Transparent Glass



842800

PAR 16 35W/230V GZ10
Lamp max size: Ø50 mm H.55 mm

Optional LED bulb
DR PAR 7,5W/230V GZ10
Lamp max size: Ø50 mm H.55 mm

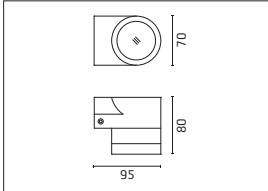
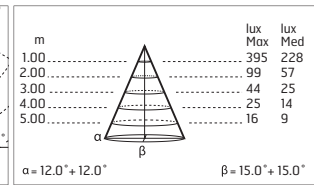
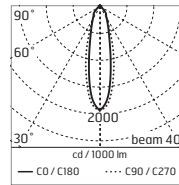

IP54

Jackie - Transparent Glass - 40° - Direct 230V

Light Source: CoB LED / 5W / Total power 6W / CRI>80 / 220÷230V / LED module set up to work directly connected to the mains



8412801

White 3000K
lm LED 688 ≈ lm OUTPUT 327

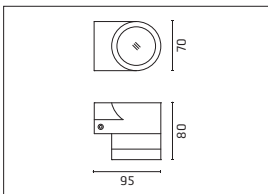
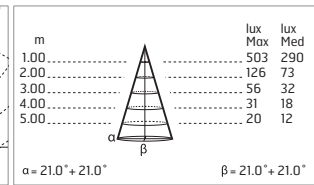
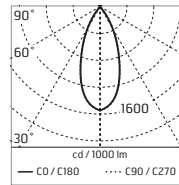

IP54

Accessories: Jackie

237

SPD: (SURGE PROTECTION DEVICE)
275Vac
MAXIMUM DISCHARGE CURRENT
10KA (8/20µs)
MAXIMUM OPERATING CURRENT 5A
SUITABLE FOR SERIES CONNEC-
TION - IP66

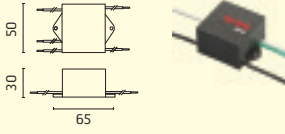











acc. code ▶	237
prod. code ▼	
842800	
8412801	●



- Luminaire for installation on wall – surface mounted.
- Configuration: die-cast aluminium structure, EN AB-47100 alloy (low copper content). Glass diffuser: sandblasted.
- Double layer coating for high resistance to corrosion: the aluminium components are painted with a double coat using powders that are compliant with QUALICOAT standards: a first layer of epoxy powder (with excellent chemical and mechanical resistance) and a second finishing layer of polyester powder (resistant to UV rays and atmospheric agents). The entire painting process of the aluminium fitting starts from components that have been sandblasted in advance to make the surface more porous and increase the adherence of the paint. Ares effects alkaline and acid washing to clean the surfaces completely, then rinses with demineralised water to remove any residue particles, subsequently a chemical conversion treatment is done to protect against rusting.
- Protection rating: IP65
- In compliance with EN 60598-1 standards
- Class of insulation: I
- Installation: wiring through M16 plastic cable gland (4,5mm\times10mm cables). Outdoor use requires suitable flexible cables assuring the watertightness of the cable gland.
- During the installation and the maintenance of the fixtures it is important to be careful and avoid damages on the paint coating. Damages on the coating exposed to outdoor conditions or water, could cause corrosion. Chemical substances affect the anticorrosion covering protection.

EU Regulation 874/2012 - Illumination equipment energy classes

	LED VERSION: Class A+/A++ Luminaire supplied with integrated LED modules that cannot be replaced
	
	
	METAL HALIDE VERSION: Class A+ HIT-DE/RX7s
	
	FLUORESCENT VERSION: Class A TC-DEL/G24q-2
	
	FLUORESCENT VERSION: Class A/B TC-D/G24d-3
	
	HALOGEN VERSION: Class D QT32/E27



Wall fitting



The fitting is equipped with 1 cable input



Protection against impact.
IK 07 - 2,00 joule

Memi - Sandblasted Glass



490100
 QT 32 100W E27
 Lamp max size: Ø40 mm H.150 mm

496000
 TC-DEL 2x18W G24 q-2

Electronic ballast

491600
 TC-D 2x26W G24 d-3

Electronic ballast

492900
 HIT-DE 70W Rx7s

Electronic ballast

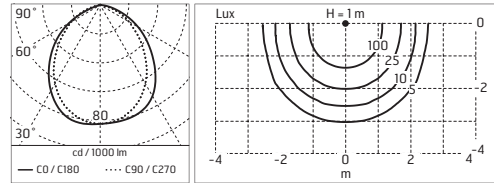
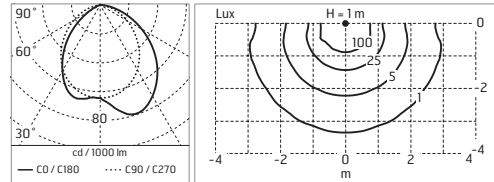
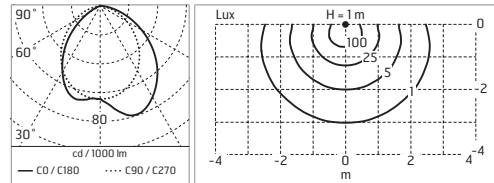
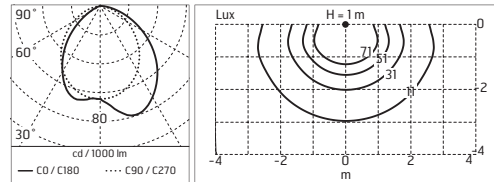
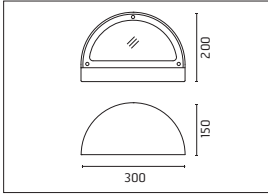

IP65

Memi - Sandblasted Glass

Light Source: Mid-Power LED / 15W / Total power 18W / CRI>80 / 220÷240V / Integral electronic power supply



4927900
 White 2700K
 lm LED 2146 ≈ lm OUTPUT 1018

4927800
 White 3000K
 lm LED 2307 ≈ lm OUTPUT 1095

4927700
 White 4000K
 lm LED 2422 ≈ lm OUTPUT 1150

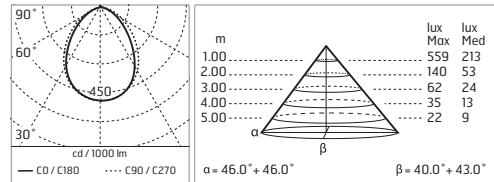
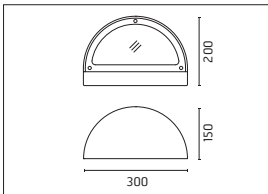

m	lux Max	lux Med
1.00	559	213
2.00	140	53
3.00	62	24
4.00	35	13
5.00	22	9

$\alpha = 46.0^\circ + 46.0^\circ$ $\beta = 40.0^\circ + 43.0^\circ$

@ 4000K

IP65

Accessories: Memi

237

SPD: (SURGE PROTECTION DEVICE)
 275Vac
 MAXIMUM DISCHARGE CURRENT
 10KA (8/20µs)
 MAXIMUM OPERATING CURRENT 5A
 SUITABLE FOR SERIES CONNEC-
 TION - IP66

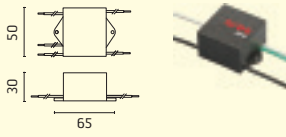

acc. code ▶	237
prod. code ▼	
490100	
491600	
492900	
496000	
4927700	•
4927800	•
4927900	•



- Luminaire for installation on wall or on ceiling – surface mounted.
- Configuration: die-cast aluminium structure, EN AB-47100 alloy (low copper content). Polycarbonate diffuser: opal, self-extinguishing.
- Double layer coating for high resistance to corrosion: the aluminium components are painted with a double coat using powders that are compliant with QUALICOAT standards: a first layer of epoxy powder (with excellent chemical and mechanical resistance) and a second finishing layer of polyester powder (resistant to UV rays and atmospheric agents). The entire painting process of the aluminium fitting starts from components that have been sandblasted in advance to make the surface more porous and increase the adherence of the paint. Ares effects alkaline and acid washing to clean the surfaces completely, then rinses with demineralised water to remove any residue particles, subsequently a chemical conversion treatment is done to protect against rusting.
- Protection rating: IP65
- In compliance with EN 60598-1 standards
- Class of insulation: I
- Installation: Mini Pat: wiring through one rubber cable gland (5mm\times9mm cables); Pat - Maxi Pat: wiring through a rubber cable holder (5mm\times10mm cables). Outdoor use requires suitable flexible cables assuring the watertightness of the cable gland / cable holder.
- During the installation and the maintenance of the fixtures it is important to be careful and avoid damages on the paint coating. Damages on the coating exposed to outdoor conditions or water, could cause corrosion. Chemical substances affect the anticorrosion covering protection.

EU Regulation 874/2012 - Illumination equipment energy classes

A	FLUORESCENT VERSION: Class A TC-DEL/G24q-1 TC-DEL/G24q-2 TC-DEL/G24q-3 TC-SEL/2G7
D	HALOGEN VERSION: Class D QT32/E27 D45/E14

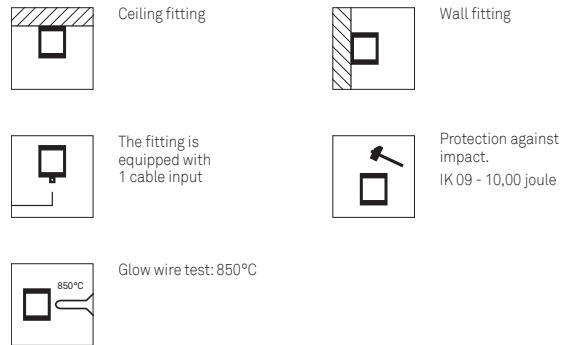

MiniPat



421100
D45 40W E14
Lamp max size: Ø40 mm H.95 mm

425700
TC-SEL 2x9W 2G7
Electronic ballast

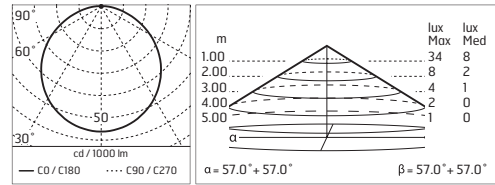
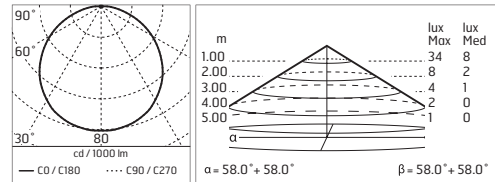
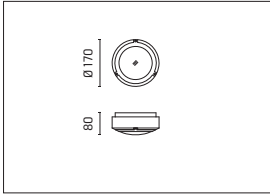

IP65

Pat - All-light



430123
QT 32 100W E27
Lamp max size: Ø40 mm H.125 mm

434123
TC-SEL 2x9W 2G7
Electronic ballast

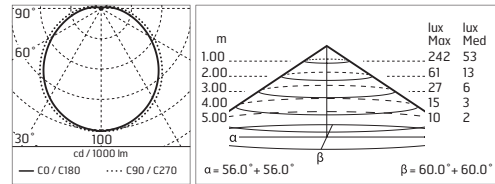
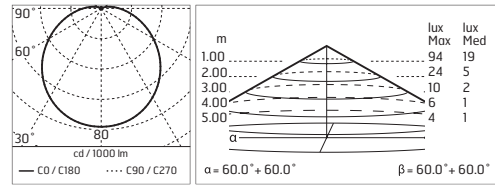
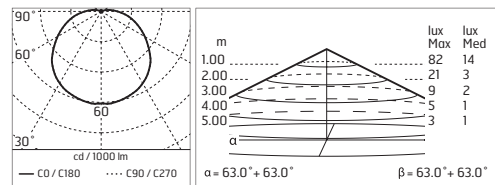
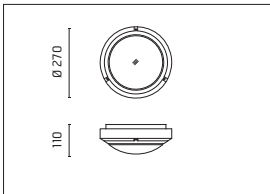

IP65

Pat - Louvre



430105
 QT 32 100W E27
 Lamp max size: Ø40 mm H.125 mm

434105
 TC-SEL 2x9W 2G7
 Electronic ballast

436005
 TC-DEL 2x18W G24q-2
 Electronic ballast

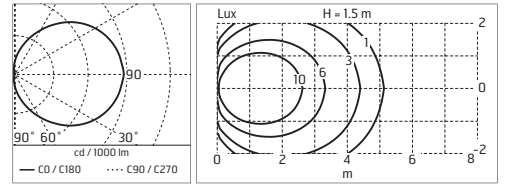
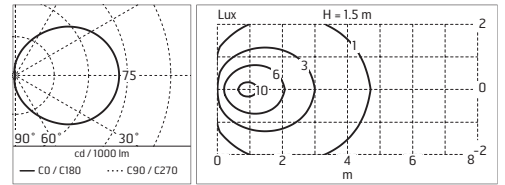
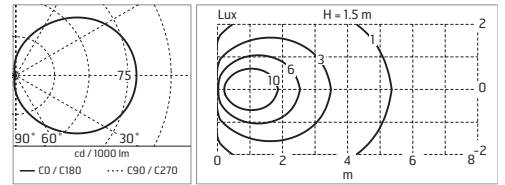
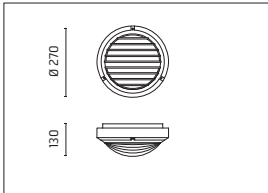

IP65

Pat - Half Louvre



430110
 QT 32 100W E27
 Lamp max size: Ø40 mm H.125 mm

434110
 TC-SEL 2x9W 2G7
 Electronic ballast

436010
 TC-DEL 2x18W G24q-2
 Electronic ballast

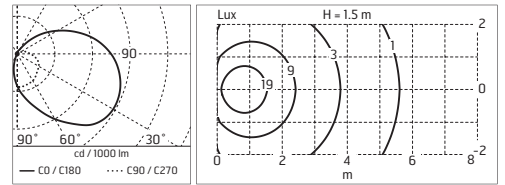
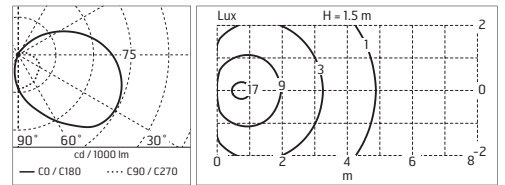
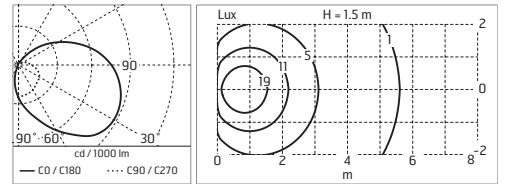
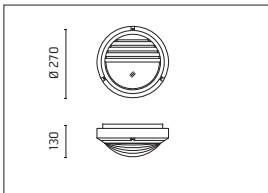

IP65

Pat - Visor



430107
 QT 32 100W E27
 Lamp max size: Ø40 mm H.125 mm

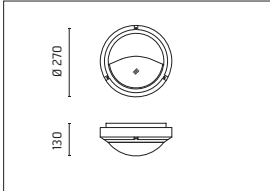
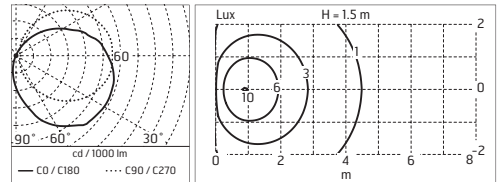

434107
 TC-SEL 2x9W 2G7
 Electronic ballast

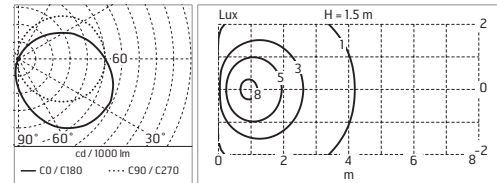

436007
 TC-DEL 2x18W G24q-2
 Electronic ballast

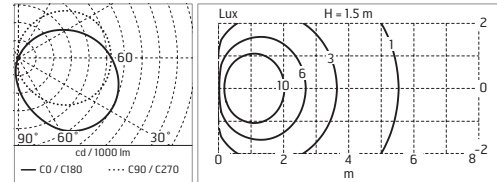

IP65

Pat - Emergency



455923
 TC-DEL 18W G24q-2
 Electronic ballast

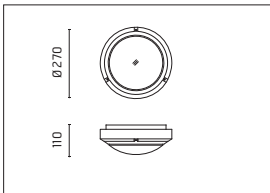
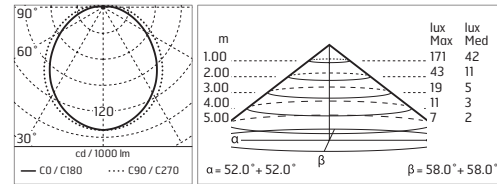

Autonomy: 1h 30 min
 The emergency unit and the power supply unit have a common neutral

IP65

MaxiPat



440223
 QT 32 2x75W E27
 Lamp max size: Ø40 mm H.125 mm

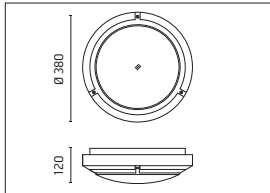

446223
 TC-DEL 2x26W G24q-3
 Electronic ballast

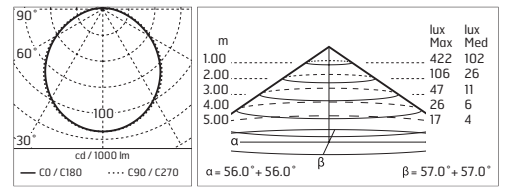
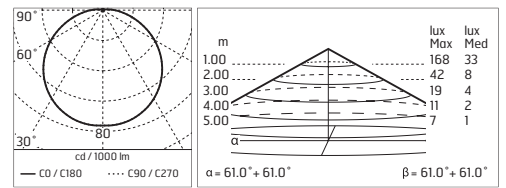

IP65

MaxiPat - Emergency



456223
 TC-DEL 2x26W G24q-3
 Electronic ballast

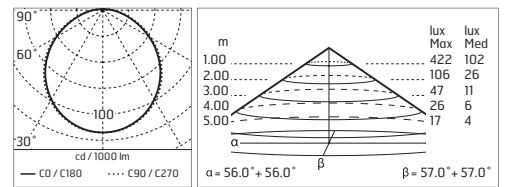
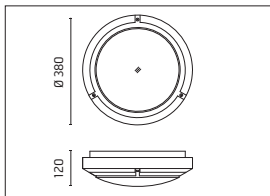

Autonomy: 1h 30 min



The emergency unit and the power supply unit have a common neutral

IP65



- Luminaire for installation on wall or on ceiling – surface mounted.
- Configuration: die-cast aluminium structure, EN AB-47100 alloy (low copper content). Polycarbonate diffuser: opal, self-extinguishing.
- Double layer coating for high resistance to corrosion: the aluminium components are painted with a double coat using powders that are compliant with QUALICOAT standards: a first layer of epoxy powder (with excellent chemical and mechanical resistance) and a second finishing layer of polyester powder (resistant to UV rays and atmospheric agents). The entire painting process of the aluminium fitting starts from components that have been sandblasted in advance to make the surface more porous and increase the adherence of the paint. Ares effects alkaline and acid washing to clean the surfaces completely, then rinses with demineralised water to remove any residue particles, subsequently a chemical conversion treatment is done to protect against rusting.
- Protection rating: IP65
- In compliance with EN 60598-1 standards
- Class of insulation: I
- Installation: wiring through a rubber cable holder (5mm<math>\lt\mathit{D}<\mathit{D}<10\text{mm}</math> cables). Outdoor use requires suitable flexible cables assuring the watertightness of the cable holder.
- During the installation and the maintenance of the fixtures it is important to be careful and avoid damages on the paint coating. Damages on the coating exposed to outdoor conditions or water, could cause corrosion. Chemical substances affect the anticorrosion covering protection.

EU Regulation 874/2012 - Illumination equipment energy classes

- A**  **FLUORESCENT VERSION:**
Class A
TC-SEL/2G7
- D**  **HALOGEN VERSION:**
Class D
QT32/E27

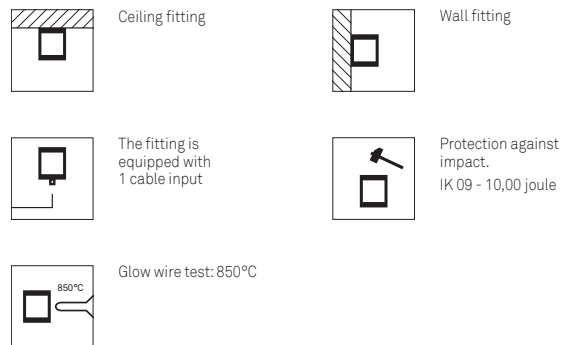

Sam - All-light



520123
 QT 32 60W E27
 Lamp max size: Ø40 mm H.115 mm

5214123
 TC-SEL 2x9W 2G7
 Electronic ballast

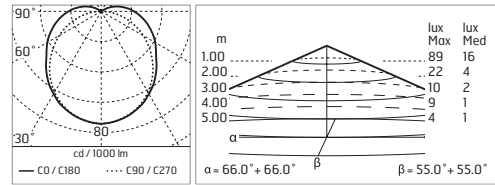
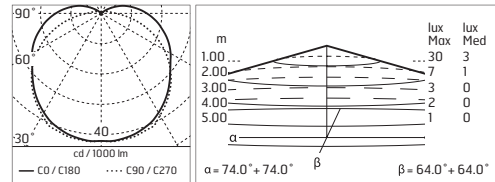
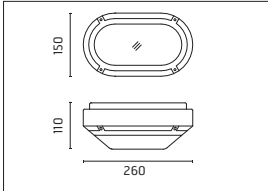

IP65

Sam - Half Louvre



520110
 QT 32 60W E27
 Lamp max size: Ø40 mm H.115 mm

5214110
 TC-SEL 2x9W 2G7
 Electronic ballast

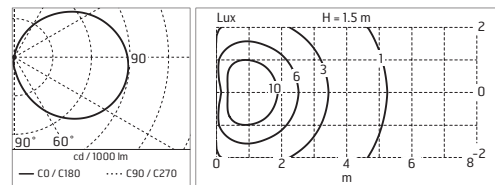
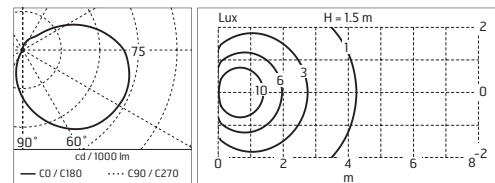
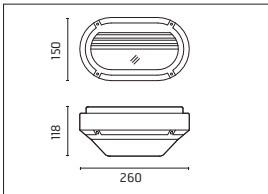

IP65

Sam - Horizontal Visor



520107
 QT 32 60W E27
 Lamp max size: Ø40 mm H.115 mm

5214107
 TC-SEL 2x9W 2G7
 Electronic ballast

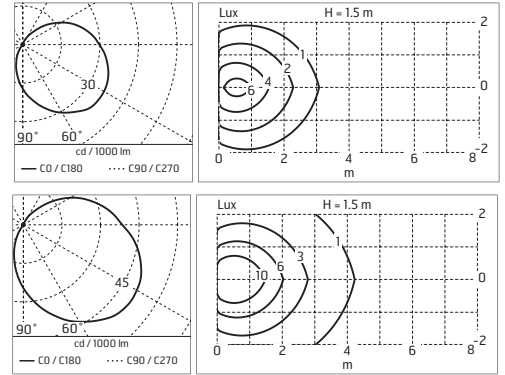
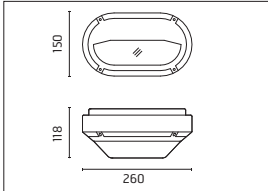

IP65

Sam - Vertical Visor



520137
 QT 32 60W E27
 Lamp max size: Ø40 mm H.115 mm

5214137
 TC-SEL 2x9W 2G7
 Electronic ballast

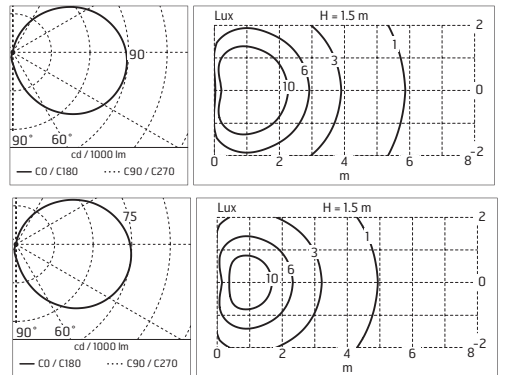
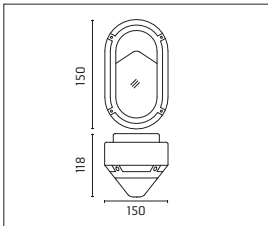











IP65



PAOLA

- Luminaire for installation on wall or on ceiling – surface mounted.
- Configuration: die-cast aluminium structure, EN AB-47100 alloy (low copper content). Glass diffuser: transparent or sandblasted, fixed to the aluminium frame through a robotic gluing system.
- Double layer coating for high resistance to corrosion: the aluminium components are painted with a double coat using powders that are compliant with QUALICOAT standards: a first layer of epoxy powder (with excellent chemical and mechanical resistance) and a second finishing layer of polyester powder (resistant to UV rays and atmospheric agents). The entire painting process of the aluminium fitting starts from components that have been sandblasted in advance to make the surface more porous and increase the adherence of the paint. Ares effects alkaline and acid washing to clean the surfaces completely, then rinses with demineralised water to remove any residue particles, subsequently a chemical conversion treatment is done to protect against rusting.
- Protection rating: IP65
- In compliance with EN 60598-1 standards
- Class of insulation: I
- Installation: Paolina: wiring through a PG9 nickel-plated brass cable gland (3,5mm\times8mm cables); Paola: wiring through two M16 plastic cable glands (4,5mm\times10mm cables). Outdoor use requires suitable flexible cables assuring the watertightness of the cable gland.
- During the installation and the maintenance of the fixtures it is important to be careful and avoid damages on the paint coating. Damages on the coating exposed to outdoor conditions or water, could cause corrosion. Chemical substances affect the anticorrosion covering protection.

EU Regulation 874/2012 - Illumination equipment energy classes

	LED VERSION: Class A/A+/A++ Luminaire supplied with integrated LED modules that cannot be replaced
	
	
	FLUORESCENT VERSION: Class A TC-TEL/GX24q-2
	
	FLUORESCENT VERSION: Class A TC-D/G24d-3
	
	HALOGEN VERSION: Class C/D QT-DE12/R7s
	
	HALOGEN VERSION: Class D QT32/E27 QT-DE12/R7s

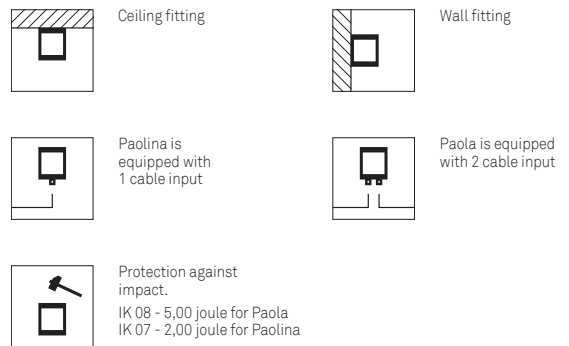

Paolina - All-light - Sandblasted Glass



898523
TC-TEL 18W GX24q-2
Electronic ballast

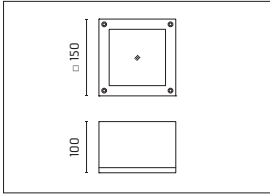
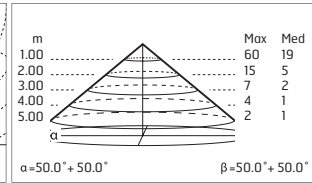
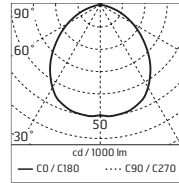

IP65

Paolina - Transparent Glass - Symmetric Optic - 10°

Light Source: Power LED / 9,9W / Total power 12W / CRI>80 / 220÷240V / Integral electronic power supply



8927012
White 2700K
lm LED 896 \approx lm OUTPUT 789

8911012
White 3000K
lm LED 963 \approx lm OUTPUT 848

8922812
White 4000K
lm LED 1026 \approx lm OUTPUT 939

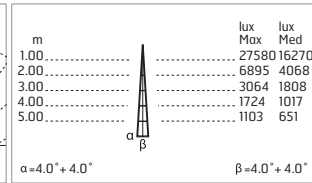
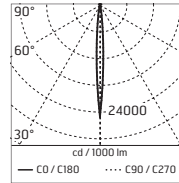

@ 4000K

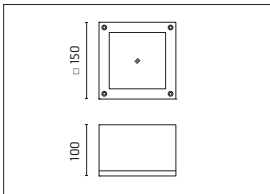

IP65

Paolina - Transparent Glass - Symmetric Optic - 40°

Light Source: Power LED / 9,9W / Total power 12W / CRI>80 / 220÷240V / Integral electronic power supply



8927023
White 2700K
lm LED 896 \approx lm OUTPUT 690

8911023
White 3000K
lm LED 963 \approx lm OUTPUT 742

8922823
White 4000K
lm LED 1026 \approx lm OUTPUT 820

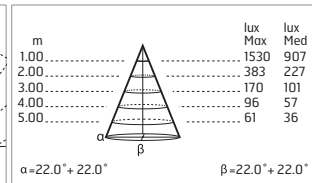
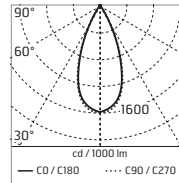

@ 4000K

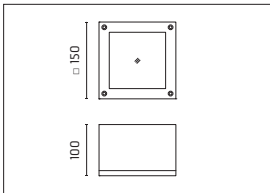

IP65

Paolina - Transparent Glass - Symmetric Optic

Light Source: Power LED / 9,9W / Total power 12W / CRI>80 / 220÷240V / Integral electronic power supply



8927057
White 2700K
lm LED 896 ≠ lm OUTPUT 446

8911057
White 3000K
lm LED 963 ≠ lm OUTPUT 480

8922857
White 4000K
lm LED 1026 ≠ lm OUTPUT 531

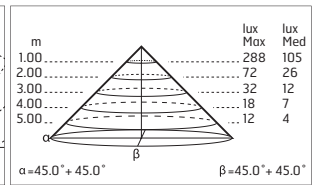
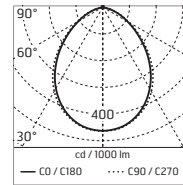
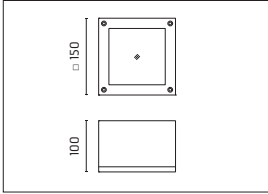

@ 4000K

IP65

Paola - All-light - Sandblasted Glass - Symmetric Optic



890200
QT 32 2x60W E27
Lamp max size: Ø40 mm H.125 mm

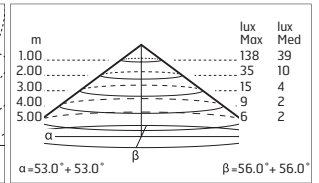
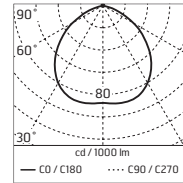
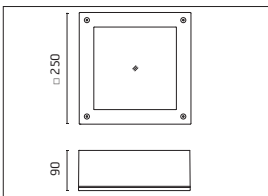

IP65

Paola - Transparent Glass - Symmetric Optic - 10°

Light Source: Power LED / 17,6W / Total power 20W / CRI>80 / 220÷240V / Integral electronic power supply



8927112
White 2700K
lm LED 1592 ≠ lm OUTPUT 1335

8910112
White 3000K
lm LED 1712 ≠ lm OUTPUT 1435

8922412
White 4000K
lm LED 1824 ≠ lm OUTPUT 1588

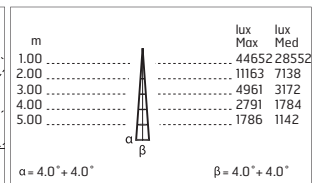
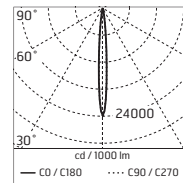
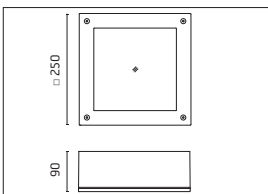

@ 4000K

Dimmable on request

IP65

Paola - Transparent Glass - Symmetric Optic - 40°

Light Source: Power LED / 17,6W / Total power 20W / CRI>80 / 220÷240V / Integral electronic power supply



8927123
White 2700K
lm LED 1592 ≠ lm OUTPUT 1150

8910123
White 3000K
lm LED 1712 ≠ lm OUTPUT 1237

8922423
White 4000K
lm LED 1824 ≠ lm OUTPUT 1368

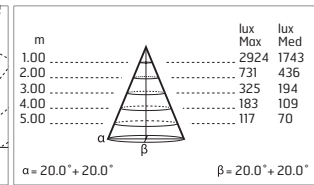
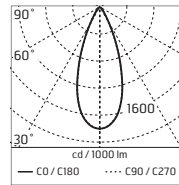

@ 4000K

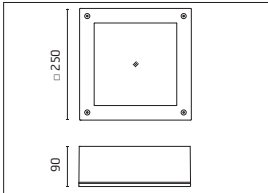

Dimmable on request

IP65

Paola - Sandblasted Glass - Symmetric Optic

Light Source: Power LED / 17,6W / Total power 20W / CRI>80 / 220÷240V / Integral electronic power supply



8927157
White 2700K
lm LED 1592 ≠ lm OUTPUT 929

8910157
White 3000K
lm LED 1712 ≠ lm OUTPUT 999

8922457
White 4000K
lm LED 1824 ≠ lm OUTPUT 1103

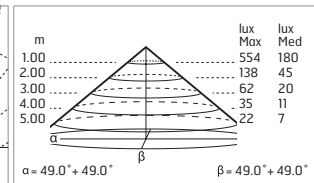
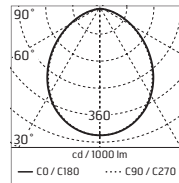

@ 4000K

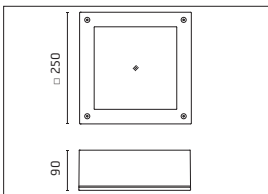

Dimmable on request

IP65

Accessories: Paola

237

SPD: (SURGE PROTECTION DEVICE)
 275Vac
 MAXIMUM DISCHARGE CURRENT
 10KA (8/20µs)
 MAXIMUM OPERATING CURRENT 5A
 SUITABLE FOR SERIES CONNEC-
 TION - IP66

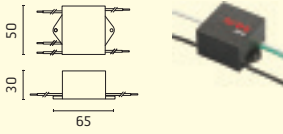

acc. code ▶	237
prod. code ▼	
890200	
898523	
8910112	•
8910123	•
8910157	•
8911012	•
8911023	•
8911057	•
8922412	•
8922423	•
8922457	•
8922812	•
8922823	•
8922857	•
8927012	•
8927023	•
8927057	•
8927112	•
8927123	•
8927157	•



- Cylindrical luminaire for installation on ceiling – surface mounted.
- Configuration: extruded aluminium structure with die-cast aluminium fixing base and frame EN AB-47100 alloy (low copper content). Glass diffuser: transparent or textured with silkscreen border, fixed to the aluminium body through a robotic gluing system.
- Double layer coating for high resistance to corrosion: the aluminium components are painted with a double coat using powders that are compliant with QUALICOAT standards: a first layer of epoxy powder (with excellent chemical and mechanical resistance) and a second finishing layer of polyester powder (resistant to UV rays and atmospheric agents). The entire painting process of the aluminium fitting starts from components that have been sandblasted in advance to make the surface more porous and increase the adherence of the paint. Ares effects alkaline and acid washing to clean the surfaces completely, then rinses with demineralised water to remove any residue particles, subsequently a chemical conversion treatment is done to protect against rusting.
- Protection rating: IP65
- In compliance with EN 60598-1 standards
- Class of insulation: I, Ø60:II
- Installation: Ø60mm is equipped with one cable holder (5mm<Ø<9mm cables); H170-300mm: wiring through two rubber cable holders (5mm<Ø<9mm cables). Outdoor use requires suitable flexible cables assuring the watertightness of the cable holder.
- During the installation and the maintenance of the fixtures it is important to be careful and avoid damages on the paint coating. Damages on the coating exposed to outdoor conditions or water, could cause corrosion. Chemical substances affect the anticorrosion covering protection.

EU Regulation 874/2012 - Illumination equipment energy classes



LED VERSION:
Class A/A+/A++
Luminaire supplied with integrated LED modules that cannot be replaced



.1 White



.6 Grey



.3 Anthracite



.4 Black



.18 Deep Brown



Ceiling fitting



Yama H 170-300mm: equipped with 2 cable input



Yama Ø60mm: The fitting is equipped with 1 cable input



Protection against impact.
IK 05 - 0,70 joule*
IK 07 - 2,00 joule**
*(version ø 60/ ø 110 mm)
**(version ø 150 mm)

Yama Ø 60mm - H 110mm - Textured Glass - 15°

Light Source: Power LED / 4,4W / Total power 6W / CRI>80 / 220÷240V / Integral electronic power supply



531242
White 2700K
lm LED 442 ≈ lm OUTPUT 396

531042
White 3000K
lm LED 475 ≈ lm OUTPUT 426

531041
White 4000K
lm LED 510 ≈ lm OUTPUT 458

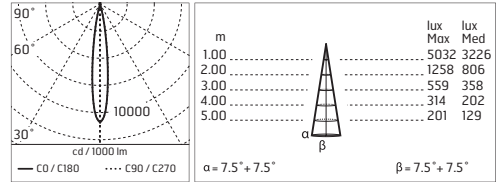

@ 4000K

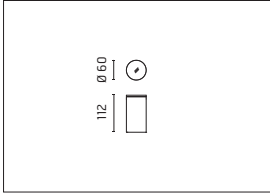

IP65

Yama Ø 60mm - H 110mm - Textured Glass - 65°

Light Source: Power LED / 4,4W / Total power 6W / CRI>80 / 220÷240V / Integral electronic power supply



531244
White 2700K
lm LED 442 ≈ lm OUTPUT 314

531044
White 3000K
lm LED 475 ≈ lm OUTPUT 338

531043
White 4000K
lm LED 510 ≈ lm OUTPUT 363

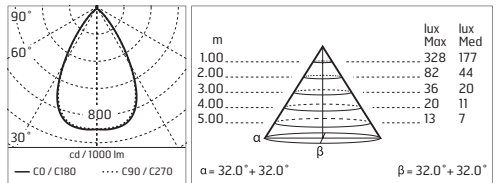

@ 4000K

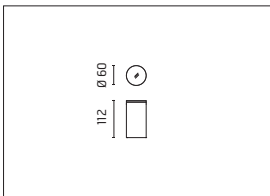

IP65

Yama Ø 110mm - H 170mm - Textured Glass - 20° - Direct 230V

Light Source: CoB LED / 10W / Total power 12W / CRI>80 / 220±230V / LED module set up to work directly connected to the mains



531029
White 3000K
lm LED 951 ± lm OUTPUT 752

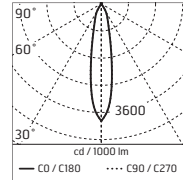

m	lux	
	Max	Med
1.00	2955	1850
2.00	739	462
3.00	328	206
4.00	185	116
5.00	118	74

$\alpha = 10.0^\circ + 10.0^\circ$ $\beta = 10.0^\circ + 10.0^\circ$

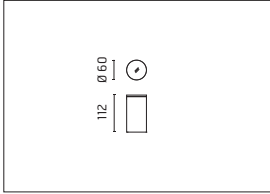

IP65

Yama Ø 110mm - H 170mm - Textured Glass - 30° - Direct 230V

Light Source: CoB LED / 10W / Total power 12W / CRI>80 / 220±230V / LED module set up to work directly connected to the mains



531030
White 3000K
lm LED 951 ± lm OUTPUT 713

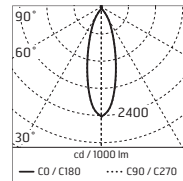

m	lux	
	Max	Med
1.00	1726	1036
2.00	432	259
3.00	192	115
4.00	108	65
5.00	69	41

$\alpha = 15.0^\circ + 15.0^\circ$ $\beta = 15.0^\circ + 15.0^\circ$

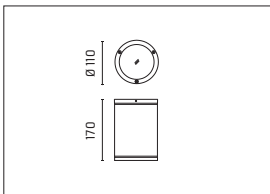

IP65

Yama Ø 110mm - H 300mm - Transparent Glass - 20°

Light Source: CoB LED / 12W / Total power 15W / CRI>80 / 220÷240V / Integral electronic power supply



531212
531212-300 Dimmable Dali
531212-310 Dimmable 1-10
 White 2700K
 lm LED 1622 ≠ lm OUTPUT 1455

531012
531012-300 Dimmable Dali
531012-310 Dimmable 1-10
 White 3000K
 lm LED 1744 ≠ lm OUTPUT 1564

531011
531011-300 Dimmable Dali
531011-310 Dimmable 1-10
 White 4000K
 lm LED 1829 ≠ lm OUTPUT 1641

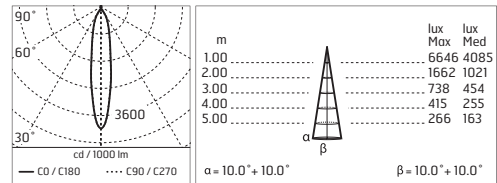
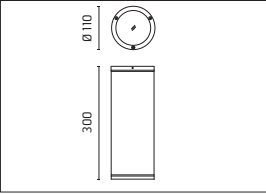

@ 4000K

IP65

Yama Ø 110mm - H 300mm - Transparent Glass - 40°

Light Source: CoB LED / 12W / Total power 15W / CRI>80 / 220÷240V / Integral electronic power supply



531209
531209-300 Dimmable Dali
531209-310 Dimmable 1-10
 White 2700K
 lm LED 1622 ≠ lm OUTPUT 1443

531009
531009-300 Dimmable Dali
531009-310 Dimmable 1-10
 White 3000K
 lm LED 1744 ≠ lm OUTPUT 1552

531008
531008-300 Dimmable Dali
531008-310 Dimmable 1-10
 White 4000K
 lm LED 1829 ≠ lm OUTPUT 1628

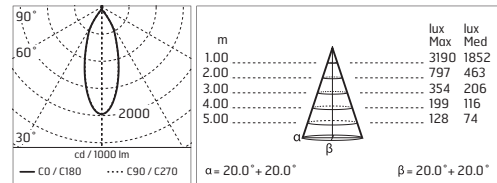
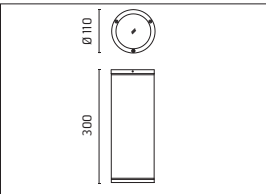

@ 4000K

IP65

Yama Ø 150mm - H 170mm - Textured Glass -20° - Direct 230V

Light Source: CoB LED / 22W / Total power 24W / CRI>80 / 220÷230V / LED module set up to work directly connected to the mains



531031
White 3000K
lm LED 2303 ≈ lm OUTPUT 1659

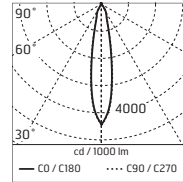

m	lux	
	Max	Med
1.00	7460	4698
2.00	1865	1174
3.00	829	522
4.00	466	294
5.00	298	188

$\alpha = 10.0^\circ + 10.0^\circ$ $\beta = 10.0^\circ + 10.0^\circ$

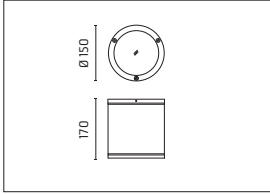

IP65

Yama Ø 150mm - H 170mm - Textured Glass -40° - Direct 230V

Light Source: CoB LED / 22W / Total power 24W / CRI>80 / 220÷230V / LED module set up to work directly connected to the mains



531032
White 3000K
lm LED 2303 ≈ lm OUTPUT 1610

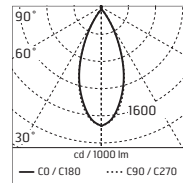

m	lux	
	Max	Med
1.00	2808	1598
2.00	702	399
3.00	312	178
4.00	176	100
5.00	112	64

$\alpha = 20.0^\circ + 20.0^\circ$ $\beta = 20.0^\circ + 20.0^\circ$

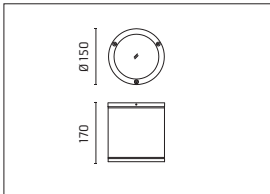

IP65

Yama Ø 150mm - H 300mm - Transparent Glass - 20°

Light Source: CoB LED / 17W / Total power 20W / CRI>80 / 220÷240V / Integral electronic power supply



531224
531224-300 Dimmable Dali
531224-310 Dimmable 1-10
 White 2700K
 lm LED 2387 ≠ lm OUTPUT 1907

531024
531024-300 Dimmable Dali
531024-310 Dimmable 1-10
 White 3000K
 lm LED 2567 ≠ lm OUTPUT 2050

531025
531025-300 Dimmable Dali
531025-310 Dimmable 1-10
 White 4000K
 lm LED 2632 ≠ lm OUTPUT 2102

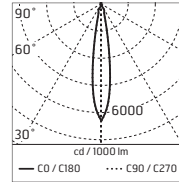
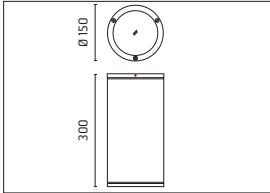

m	lux	
	Max	Med
1.00	13609	8428
2.00	3402	2107
3.00	1512	936
4.00	851	527
5.00	544	337

$\alpha = 10.0^\circ + 10.0^\circ$ $\beta = 10.0^\circ + 10.0^\circ$

@ 4000K

IP65

Yama Ø 150mm - H 300mm - Transparent Glass - 40°

Light Source: CoB LED / 17W / Total power 20W / CRI>80 / 220÷240V / Integral electronic power supply



531221
531221-300 Dimmable Dali
531221-310 Dimmable 1-10
 White 2700K
 lm LED 2387 ≠ lm OUTPUT 1923

531021
531021-300 Dimmable Dali
531021-310 Dimmable 1-10
 White 3000K
 lm LED 2567 ≠ lm OUTPUT 2068

531020
531020-300 Dimmable Dali
531020-310 Dimmable 1-10
 White 4000K
 lm LED 2632 ≠ lm OUTPUT 2121

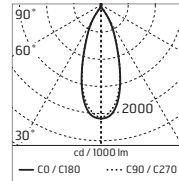
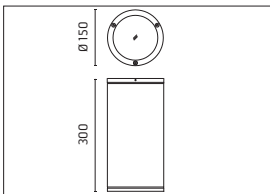

m	lux	
	Max	Med
1.00	4435	2623
2.00	1109	656
3.00	493	291
4.00	277	164
5.00	177	105

$\alpha = 20.0^\circ + 20.0^\circ$ $\beta = 20.0^\circ + 20.0^\circ$

@ 4000K

IP65

Accessories: Yama

237

SPD: (SURGE PROTECTION DEVICE)
 275Vac
 MAXIMUM DISCHARGE CURRENT
 10KA (8/20µs)
 MAXIMUM OPERATING CURRENT 5A
 SUITABLE FOR SERIES CONNEC-
 TION - IP66

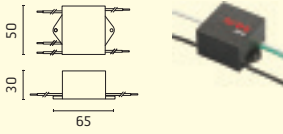

acc. code ▶	dimmi DALI	dimmi 1-10	237
531008	-300	-310	•
531009	-300	-310	•
531011	-300	-310	•
531012	-300	-310	•
531020	-300	-310	•
531021	-300	-310	•
531024	-300	-310	•
531025	-300	-310	•
531029			•
531030			•
531031			•
531032			•
531041			•
531042			•
531043			•
531044			•
531209	-300	-310	•
531212	-300	-310	•
531221	-300	-310	•
531224	-300	-310	•
531242			•
531244			•

IP DEGREE OF PROTECTION AND CLASS OF INSULATION

First Digit IP - Protection Against Solid Bodies

- 0 Non protected.
 - 1 A large surface of the body, such as a hand (but no protection against deliberate access). Solid objects exceeding 50mm in diameter.
 - 2 Finger or similar objects not exceeding 80 mm in length. Solid objects exceeding 12 mm in diameter.
 - 3 Tools, wires, etc. of diameter thickness greater than 2,5mm. Solid objects exceeding 2,5mm in diameter.
 - 4 Wires or strips of thickness greater than 1,0 mm. Solid objects exceeding 1,0 mm diameter.
 - 5 Ingress of dust is not totally prevented but dust does not enter in sufficient quantity to interfere with satisfactory operation of the equipment.
 - 6 No ingress of dust.
-

Second Digit IP - Protection Against Water

- 0 Non protected.
 - 1 Dripping water (vertically falling drops) shall have no harmful effect.
 - 2 Vertically dripping water shall have no harmful effect when the enclosure is tilted at any angle up to 15° from its normal position.
 - 3 Water falling as a spray at an angle up to 60° from the vertical shall have no harmful effect.
 - 4 Water splashed against the enclosure from any direction shall have no harmful effect.
 - 5 Water projected by a nozzle against the enclosure from any direction shall have no harmful effect.
 - 6 Water from heavy seas or water projected in powerful jets shall not enter the enclosure in harmful quantities.
 - 7 Ingress of water in a harmful quantity shall not be possible when the enclosure is immersed in water under defined conditions of pressure and time.
 - 8 The equipment is suitable for continuous submersion in water under conditions which shall be specified by the manufacturer
-



Class I
Light fixture with earth connector
or terminal



Class II
Light fixture with double insulation or
reinforced insulation



Class III
Protection is assured by the presence
of a safety extra low voltage (SELV) not
exceeding 50V



F mark
Suitable for installation on normally
flammable surface



CE Mark
Compliance with all applicable
EC directives



Dimmable

SYMBOLS



Static load: Resistance to static load.
In compliance with CEI EN 60598-2-13 standards.



Drive over Resistance to torque and shear loads.
In compliance with CEI EN 60598-2-13 standards.



Diffuser temperature according to CEI EN 60598-2-13. Check that diffuser's temperature "T max °C" (tested at 25°C) complies with your local regulation. Glass surface temperature <70°C for LED source



Advice on installation of recessed luminaires:
It is important to provide a consistent gravel layer or drain system to ensure good drainage and to avoid water stagnation.
The luminaire must not be installed in hollow surfaces.

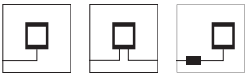

Electric connection:
Wiring through cable input, through two cable inputs or through a feeding transformer installed on remote position (to be ordered separately).

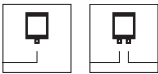

Luminaire is equipped with 1 or 2 cable input.



Luminaire is equipped with cable and plug.



Protection against water ingress from the cable



Surface installation on wall, on ground or on ceiling.

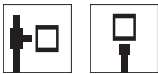

Installation on pole.



In-ground installation (recessed luminaire)
Suspended fitting.



Glow wire test IEC 60695-2-10: the glow wire test is used to simulate the effect of heat as may arise in malfunctioning electrical equipment, such as with overloaded or allowing components (specified temperature).



Resistance to external mechanical impacts:
IK code refers to the maximum external impact the luminaire is capable to withstand, without irreversible damage.
In compliance with EN50102 standards.

IK code	Impact Energy (Joule)	Mass/Height
IK00	0,00	----
IK01	0,15	0,2Kg/70mm
IK02	0,20	0,2Kg/100mm
IK03	0,35	0,2Kg/175mm
IK04	0,50	0,2Kg/250mm
IK05	0,70	0,2Kg/350mm
IK06	1,00	0,5Kg/200mm
IK07	2,00	0,5Kg/400mm
IK08	5,00	1,7Kg/295mm
IK09	10,00	5,0Kg/200mm
IK10	20,00	5,0Kg/400mm

TECNICAL SCHEMES

Wiring Diagram and sample series installation n.1

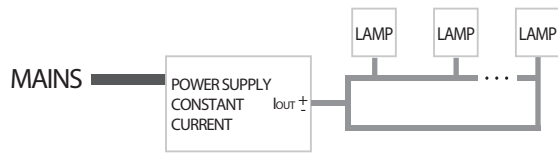

Wiring Diagram and sample parallel installation n.2

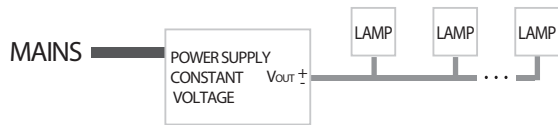

Wiring Diagram and sample dimmable series installation n.3

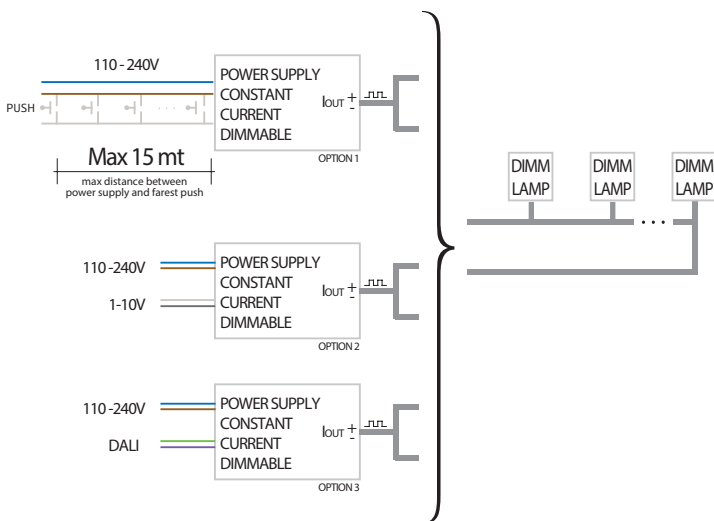

Wiring Diagram and sample dimmable parallel installation n.4

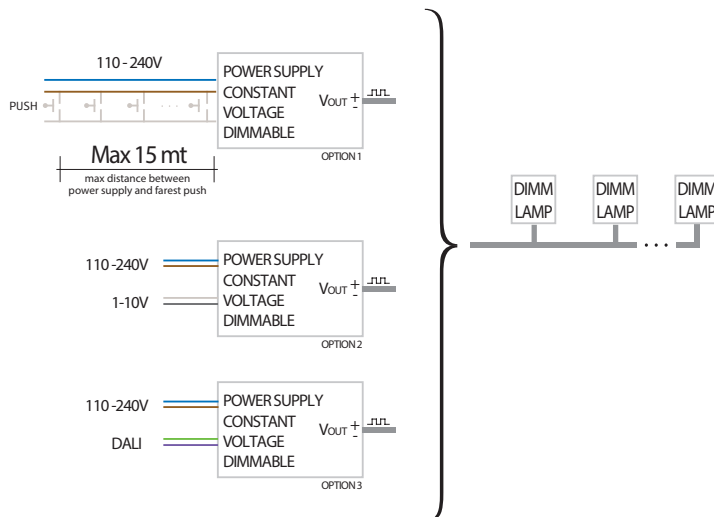

Basic DMX Wiring Scheme

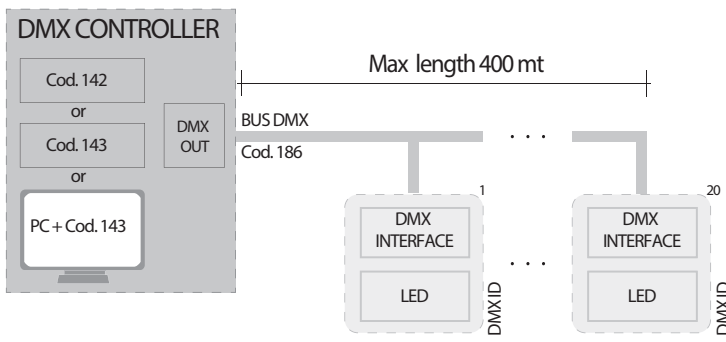

A DMX system can include an unlimited number of fixtures on condition that the following rules are respected:

- Use suitable cables for DMX bus: shielded twisted pair with 110 Ohm constant impedance (e.g. Cod.186). The use of different cables doesn't assure the same performance.
- Every 400mt of cable the DMX bus signal needs to be regenerated with a Splitter. This allows to extend the installation.
- Every 20 fixtures the DMX bus signal needs to be regenerated with a Splitter. This allows to extend the installation.
- All fixtures have to be connected in series to the DMX bus. No star connection allowed. It has to be taken into account that the use of a splitter can solve the problem having one bus input and more bus output.
- Each cable must have a 120 Ohm termination resistor.

Extended DMX Wiring Pattern

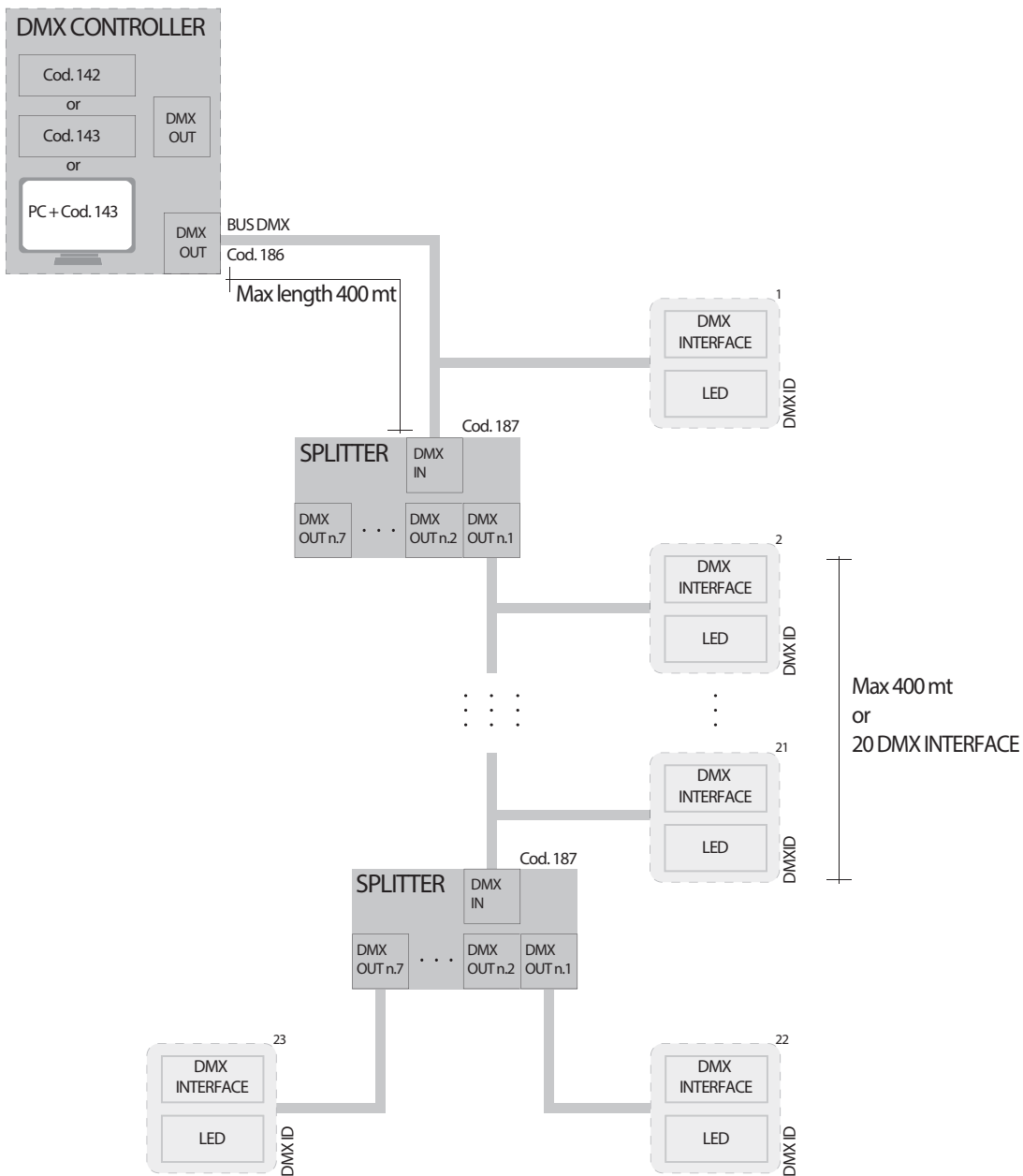

Wiring Diagram and sample installation n.5

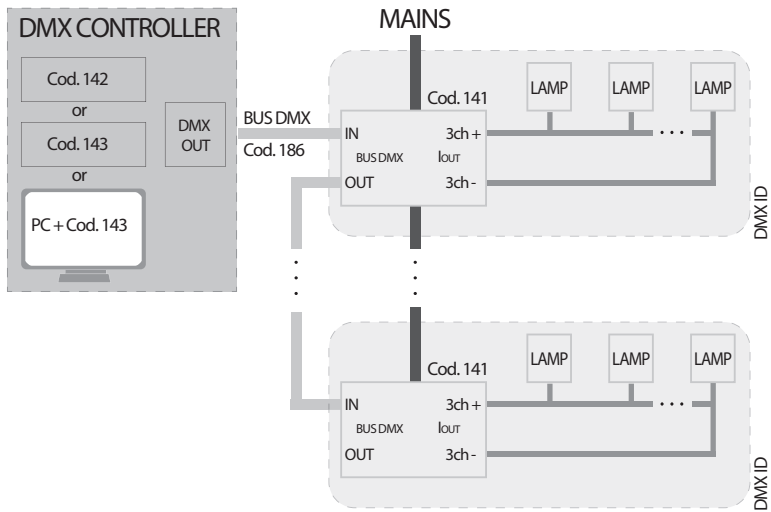

Wiring Diagram and sample installation n.6

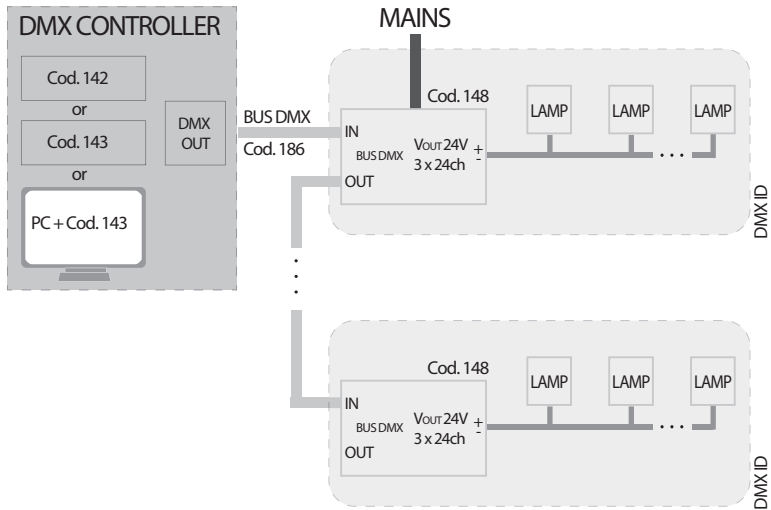

Wiring Diagram and sample installation n.7

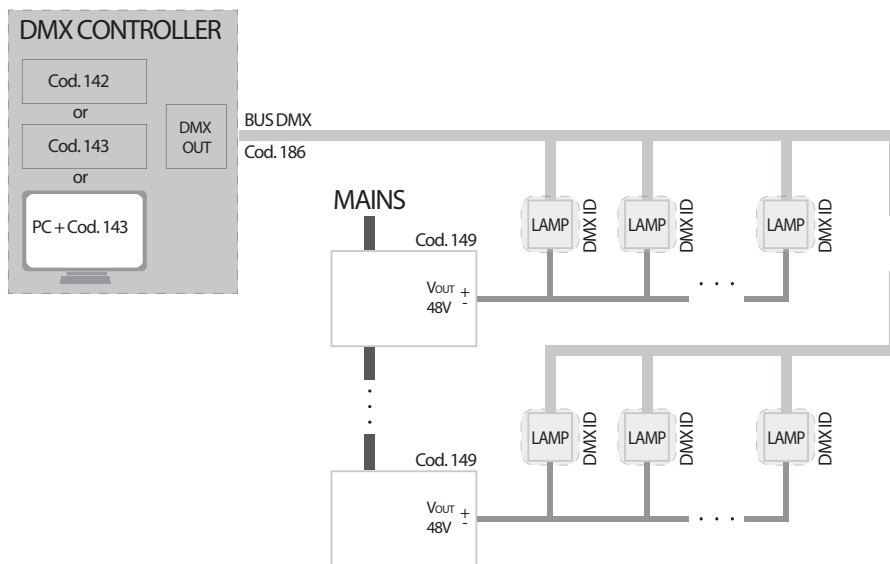

Wiring Diagram and sample installation n.8

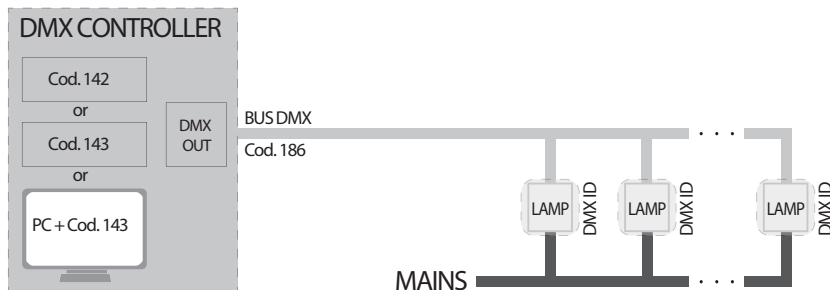

ATTENTION

Wiring of LED luminaires run in constant current and connected in series (schemes 1,3 and 5): Never connect the luminaire to a switched on power supply. Always connect luminaires to the power supply, and only after connect the power supply to the mains.

Connection schemes: Luminaires in constant current must always be connected in series; luminaires in constant tension must always be connected in parallel. Always respect polarity according to the DC system.

Power Supplies must always match installation features: Never use a constant current power supply on a constant tension luminaire and vice versa.

The choice of the power supply must take into account the real power consumption of the luminaire (data shown in the catalogue) with a 20% increase to face any potential loss on the installation.

LED Luminaires and power supplies are protected against interferences on the line, it is anyway highly recommended to set dedicated feeding lines to avoid any potential sudden and severe interference (inductive loads like pumps or discharge lamps) that are likely to damage the LED module.

Prod. Codex	Page	Prod. Codex	Page	Prod. Codex	Page	Prod. Codex	Page
16	123	141	81	220	54	250157	143
17	123	142	408	221	305	252815	142
18	123	143	408	222	305	253315	142
20	135	144	416	223	305	255612	142
21	203	147	416	224	305	255622	142
26	145	148	66	225	305	255628	143
42	123	150	416	226	305	255638	143
50	129	151	66	227	305	256713	143
51	352	152	66	228	320	421100	534
52	352	153	66	229	305	425700	534
59	169	155	416	230	305	430105	535
60	169	156	416	231	305	430107	536
68	352	157	293	232	305	430110	535
71	101	158	293	235	288	430123	534
72	101	160	383	236	408	434105	535
73	89	161	297	237	408	434107	536
74	89	162	297	238	352	434110	535
77	163	165	304	239	352	434123	534
78	312	166	304	243	320	436005	535
79	312	167	313	245	380	436007	536
80	101	168	313	247	383	436010	535
81	101	169	109	248	258	436023	534
82	101	170	119	249	258	440223	537
85	145	172	416	252	416	446223	537
87	416	173	416	260	231	455923	536
88	304	174	416	261	276	456223	537
89	312	175	416	262	276	481121	464
90	312	176	416	263	276	481122	465
93	312	182	297	264	265	483001	464
94	312	183	66	266	265	483002	464
95	312	184	352	268	265	483003	465
96	312	186	408	4140	310	483004	465
98	80	187	408	4145	310	483005	464
99	80	188	47	4150	310	483006	465
101	80	189	47	4155	310	485721	464
102	80	190	47	12325	437	485722	465
105	507	192	54	12355	437	486121	466
106	416	193	54	12390	437	486122	467
107	189	194	54	012815	133	490100	530
108	189	195	54	012828	133	491600	530
109	219	196	182	012856	133	492900	530
110	416	197	182	013315	133	496000	530
112	312	198	182	013328	133	500001	30
113	312	199	182	013356	133	500002	30
114	312	203	277	032815	132	500003	30
115	312	205	276	032823	132	500004	30
116	304	206	276	032856	132	500005	30
123	157	207	276	033315	132	500006	30
124	157	208	276	033323	132	500007	30
125	343	209	276	033356	132	500008	30
129	352	210	276	073513	138	500009	30
130	441	211	276	073514	138	502002	212
131	453	212	276	073515	139	502003	212
135	352	213	276	077113	138	502005	212
136	288	215	408	077114	138	502006	212
138	213	218	352	077115	139	502007	212
139	209	219	54	250113	143	502009	212

Prod. Codex	Page	Prod. Codex	Page	Prod. Codex	Page	Prod. Codex	Page
503002	207	509023	364	517013	105	518043	115
503004	207	509025	364	517014	105	518052	115
503006	206	509032	365	517015	105	518053	115
503008	206	509033	365	517016	105	518062	115
503009	207	509035	365	517017	105	518063	115
503010	207	509042	365	517022	105	518072	116
503011	206	509043	365	517023	105	518073	116
503012	206	509045	365	517025	105	518082	116
505002	506	509052	365	517032	106	518083	116
505003	506	509053	365	517033	106	518085	116
505005	506	509055	365	517035	106	518086	116
506002	510	512002	514	517042	106	518092	117
506003	510	512003	514	517043	106	518093	117
506005	510	512005	514	517045	106	518095	117
507002	500	512012	514	517052	106	518096	117
507003	500	512013	514	517053	106	518102	117
507005	500	512015	514	517055	106	518103	117
507012	500	513002	280	517062	107	518202	112
507013	500	513003	280	517063	107	518205	112
507015	500	513012	280	517065	107	518208	112
507022	500	513013	280	517072	107	518212	113
507023	500	513022	280	517073	107	518215	113
507025	500	513023	280	517075	107	518222	114
507032	501	513032	281	517082	108	518225	114
507033	501	513033	281	517083	108	518232	114
507035	501	513035	282	517085	108	518234	113
507102	501	513036	282	517112	104	518242	115
507103	501	513038	282	517113	104	518252	115
507105	501	513039	282	517115	104	518262	115
507112	501	513047	282	517122	104	518272	116
507113	501	513048	282	517123	104	518282	116
507115	501	513050	283	517125	104	518285	116
507122	502	513051	283	517132	107	518292	117
507123	502	513059	284	517133	107	518295	117
507125	502	513060	284	517135	107	518302	117
507132	502	513062	284	517142	108	520107	541
507133	502	513063	284	517143	108	520110	540
507135	502	513065	284	517145	108	520123	540
508002	494	513066	284	518002	112	520137	541
508003	494	513068	285	518003	112	523002	412
508005	494	513069	285	518005	112	523003	412
508012	494	513080	280	518006	112	523012	412
508013	494	513082	280	518008	112	523013	412
508015	494	513084	280	518009	112	523022	412
508022	495	513086	281	518012	113	523023	412
508023	495	513088	282	518013	113	523032	413
508025	495	513090	282	518015	113	523033	413
508032	495	513092	282	518016	113	523042	413
508033	495	513094	283	518022	114	523043	413
508035	495	513096	284	518023	114	523052	413
509002	364	513098	284	518025	114	523053	413
509003	364	513100	284	518026	114	523062	414
509005	364	513102	285	518032	114	523063	414
509012	364	517002	104	518033	114	523072	414
509013	364	517003	104	518034	113	523073	414
509015	364	517005	104	518035	113	524002	59
509022	364	517012	105	518042	115	524003	59

Prod. Codex	Page	Prod. Codex	Page	Prod. Codex	Page	Prod. Codex	Page
524004	59	529005	457	532029	201	534017	38
524005	59	529007	457	532030	201	534018	38
524012	58	529008	457	533001	20	534020	39
524013	58	529024	456	533002	20	534021	39
524015	58	529028	457	533003	20	534023	39
524022	58	529051	460	533004	20	534024	39
524023	58	529052	460	533005	21	534026	39
524025	58	529053	460	533006	21	534027	39
524102	63	529054	460	533007	20	534029	40
524103	63	529055	460	533008	20	534030	40
524104	63	529056	460	533009	21	534031	40
524105	63	530002	126	533010	21	534032	40
524112	62	530003	126	533011	22	534033	40
524113	62	530005	127	533012	22	534034	40
524115	62	530006	127	533013	22	534036	41
524122	62	530007	126	533014	22	534037	41
524123	62	530008	126	533015	23	534039	41
524125	62	530009	127	533016	23	534040	41
524502	61	530010	127	533017	22	534042	41
524503	61	531008	552	533018	22	534043	41
524504	61	531009	552	533019	23	534045	42
524505	61	531011	552	533020	23	534046	42
524512	60	531012	552	533021	24	534047	42
524513	60	531020	554	533022	24	534048	42
524515	60	531021	554	533023	24	534051	37
524522	60	531024	554	533024	24	534052	37
524523	60	531025	554	533025	25	534053	37
524525	60	531029	551	533026	25	534054	38
525002	292	531030	551	533027	24	534055	38
525003	292	531031	553	533028	24	534056	38
525012	292	531032	553	533029	25	534057	39
525013	292	531041	550	533030	25	534058	39
525022	292	531042	550	533050	20	534059	39
525023	292	531043	550	533051	22	534060	40
525032	296	531044	550	533052	24	534061	40
525033	296	531209	552	533053	20	534062	40
525124	309	531212	552	533054	20	534063	41
525140	292	531221	554	533055	21	534064	41
525142	292	531224	554	533056	21	534065	41
525144	292	531242	550	533057	22	534066	42
525150	296	531244	550	533058	22	534067	42
526002	148	532002	200	533059	23	535002	50
526003	148	532003	200	533060	23	535003	50
526005	148	532005	200	533061	24	535005	50
527002	380	532006	200	533062	24	535006	50
527003	380	532008	200	533063	25	535008	51
527005	380	532009	200	533064	25	535009	51
527012	380	532014	200	534002	37	535011	51
527013	380	532017	200	534003	37	535012	51
527015	380	532020	200	534005	37	535014	52
528004	222	532022	201	534006	37	535015	52
528005	222	532023	201	534008	37	535017	52
528009	222	532024	201	534009	37	535018	52
528010	222	532025	201	534011	38	535020	50
529001	456	532026	201	534012	38	535021	50
529003	456	532027	201	534014	38	535023	50
529004	456	532028	201	534015	38	535024	50

Prod. Codex	Page	Prod. Codex	Page	Prod. Codex	Page	Prod. Codex	Page
535026	51	536042	178	539024	255	539120	256
535027	51	536043	178	539026	255	539122	257
535029	51	536044	178	539027	255	539124	257
535030	51	536047	178	539029	256	539130	240
535032	52	536048	178	539030	256	539132	242
535033	52	536049	179	539032	257	539134	244
535035	52	536050	179	539033	257	539136	246
535036	52	536051	179	539035	257	539138	248
535041	50	536052	179	539036	257	539140	250
535042	50	536055	179	539038	242	539142	252
535043	50	536056	179	539039	242	539144	254
535044	50	536057	180	539041	243	539146	256
535045	51	536058	180	539042	243	539148	240
535046	51	536059	180	539044	243	539150	242
535047	51	536060	180	539045	243	539152	244
535048	51	536061	180	539047	244	539154	246
535049	52	536062	181	539048	244	539156	248
535050	52	536063	181	539050	245	539158	250
535051	52	536064	181	539051	245	539160	252
535052	52	536103	172	539053	245	539162	254
536002	172	536109	172	539054	245	539164	256
536003	172	536112	173	539056	246	539166	240
536005	172	536114	173	539057	246	539168	242
536006	172	536116	173	539059	247	539170	244
536008	172	536118	174	539060	247	539172	246
536009	172	536120	174	539062	247	539174	248
536011	173	536122	174	539063	247	539176	250
536012	173	536124	175	539065	248	539178	252
536013	173	536126	175	539066	248	539180	254
536014	173	536128	175	539068	249	539182	256
536015	173	536130	176	539069	249	540002	262
536016	173	536132	176	539071	249	540003	262
536017	174	536134	176	539072	249	541002	268
536018	174	536136	177	539074	240	541003	268
536019	174	536140	177	539075	240	541005	268
536020	174	536142	178	539076	240	541006	268
536021	174	536144	178	539078	242	541007	268
536022	174	536148	178	539080	243	541008	268
536023	175	536150	179	539082	243	541009	269
536024	175	536152	179	539084	244	541010	269
536025	175	536156	179	539086	245	541011	269
536026	175	536158	180	539088	245	541012	269
536027	175	536160	180	539090	246	541013	269
536028	175	539002	250	539092	247	541014	269
536029	176	539003	250	539094	247	541023	268
536030	176	539005	251	539096	248	541026	268
536031	176	539006	251	539098	249	541028	268
536032	176	539008	251	539100	249	541030	269
536033	176	539009	251	539102	250	541032	269
536034	176	539011	252	539104	251	541034	269
536035	177	539012	252	539106	251	541100	270
536036	177	539014	253	539108	252	541102	270
536037	177	539015	253	539110	253	542002	376
536038	177	539017	253	539112	253	542003	376
536039	177	539018	253	539114	254	542005	376
536040	177	539021	254	539116	255	542006	376
536041	178	539023	255	539118	255	542007	376

Prod. Codex	Page	Prod. Codex	Page	Prod. Codex	Page	Prod. Codex	Page
542009	376	545092	404	936785	231	2517228	143
544001	386	545100	390	936787	230	2556128	142
544002	386	545102	392	936788	230	2556228	142
544003	386	545104	396	944213	92	4827421	466
544004	386	545106	398	944214	92	4827422	467
544005	386	545108	402	944257	92	4827521	466
544006	386	545110	404	944813	94	4827522	467
544007	386	652815	122	944814	95	4827524	466
544008	386	652828	122	944857	94	4827525	467
544009	386	653315	122	945413	96	4927700	530
545002	390	653328	122	945414	97	4927800	530
545003	390	662815	122	945457	97	4927900	530
545005	390	662823	123	948012	95	5000010	30
545006	390	663315	122	948013	95	5000011	30
545007	391	663323	123	948313	93	5000012	30
545008	391	0735129	139	948512	93	5214107	541
545011	392	0771129	139	948513	93	5214110	540
545012	392	816400	166	948612	95	5214123	540
545014	392	816420	166	948613	95	5214137	541
545015	392	820100	166	962913	324	7511312	84
545016	393	820117	160	962914	324	7511313	84
545017	393	820123	160	971913	332	7511413	84
545020	396	822800	167	971914	332	7511512	84
545021	396	822801	167	1029500	148	7518412	84
545023	396	822805	167	1029600	148	7518413	84
545024	396	842800	526	1032823	186	7611312	86
545025	397	850100	234	1033323	186	7611313	86
545026	397	850121	234	1055600	348	7611512	86
545029	398	850167	236	1055612	347	7611513	86
545030	398	850168	237	1055620	348	7618412	86
545032	398	850169	236	1055622	347	7618413	86
545033	398	850170	236	1079245	520	8121300	166
545034	399	850173	235	1079252	520	8121500	166
545035	399	850174	235	1233543	444	8121600	166
545038	402	850175	234	1233545	446	8121620	166
545039	402	850176	235	1233547	446	8202001	160
545041	402	853500	234	1233547	450	8202002	160
545042	402	853521	234	1233548	447	8202005	160
545043	403	853568	237	1233548	451	8212218	161
545044	403	853570	236	1233550	444	8212228	161
545047	404	853573	235	1233553	447	8212517	161
545048	404	853574	235	1233554	446	8212527	161
545050	404	853575	234	1237147	450	8218218	161
545051	404	853576	235	1237148	451	8220917	161
545052	405	857167	236	1610112	317	8225817	161
545053	405	857168	237	1610113	317	8225917	161
545070	390	857169	236	1610122	317	8225927	161
545072	390	857170	236	1610123	317	8226118	161
545074	392	890200	545	1622412	317	8226218	161
545076	392	898523	544	1622413	317	8226228	161
545078	396	930100	228	1628013	316	8412801	526
545080	396	930121	228	1628014	316	8910112	545
545082	398	930178	229	1628113	316	8910123	546
545084	398	930179	229	1628114	316	8910157	546
545086	402	930181	228	1628123	316	8911012	544
545088	402	930182	229	1628124	316	8911023	544
545090	404	936784	230	2517212	142	8911057	545

Prod. Codex	Page	Prod. Codex	Page	Prod. Codex	Page	Prod. Codex	Page
8922412	545	10018040	73	10723245	520	12316250	426
8922423	546	10018041	78	10723252	520	12316253	430
8922457	546	10018100	71	10727247	520	12316254	428
8922812	544	10018112	70	10727249	520	12316343	420
8922823	544	10018140	70	10727253	519	12316450	420
8922857	545	10018141	76	10727643	518	12316451	421
8927012	544	10018212	72	10727650	518	12316453	421
8927023	544	10018227	75	10727944	519	12316644	426
8927057	545	10018240	73	10727951	519	12316652	427
8927112	545	10018241	78	10813092	192	12316744	426
8927123	546	10222900	148	10813093	192	12316752	427
8927157	546	10328134	186	10813094	193	12316854	430
9418613	93	10333134	186	10813095	193	12317054	430
9418812	95	10410400	216	10813334	195	12324044	444
9418813	95	10410600	216	10813396	194	12324052	445
9428424	333	10419700	216	10813397	194	12324144	444
9428514	333	10510700	348	10813398	194	12324152	445
9480131	96	10510712	347	10813399	195	12324354	447
9483131	94	10510720	348	10814092	192	12324454	447
9485131	94	10510722	347	10814093	192	12335117	451
9486131	96	10514400	346	10814094	193	12335136	450
9628213	324	10514412	346	10814095	193	25172128	142
9628214	325	10514420	346	10814334	195	94186131	94
9628313	324	10514422	346	10814396	194	94188131	96
9628314	325	10517100	346	10814397	194	100174121	75
9628323	324	10517112	346	10814398	194	100174122	73
9628324	325	10517200	348	10814399	195	100174123	74
9715109	334	10517212	347	10819592	192	100174125	78
9724713	333	10517300	346	10819593	192	100174132	77
9724714	334	10517400	348	10819594	193	100176118	70
9724723	333	10517412	347	10819595	193	100176119	71
9724724	334	10519000	348	10819634	195	100176120	71
9724813	333	10519012	347	10819696	194	100176124	76
9724814	334	10525100	350	10819697	194	100176133	76
9728413	333	10525112	349	10819698	194	100177118	70
9728414	333	10525200	350	10819699	195	100177119	71
9728423	333	10525212	349	12311643	420	100177120	71
9728513	333	10525220	350	12311650	420	100177124	76
9771109	334	10525222	349	12311951	421	100177133	76
10017412	72	10525400	350	12312253	421	100179121	75
10017427	74	10525412	349	12313253	421	100179122	73
10017440	72	10525500	350	12313643	420	100179123	74
10017441	77	10525512	349	12313650	420	100179125	78
10017600	71	10525520	350	12313951	421	100179132	77
10017612	70	10525522	349	12314644	426	100180121	75
10017640	70	10525600	350	12314652	427	100180122	73
10017641	76	10525612	349	12315144	444	100180123	74
10017700	71	10711643	518	12315152	445	100180125	78
10017712	70	10711650	518	12315454	447	100180132	77
10017740	70	10711944	519	12316243	426	100181118	70
10017741	76	10711951	519	12316245	430	100181119	71
10017912	72	10712253	519	12316246	427	100181120	71
10017927	75	10723043	518	12316246	434	100181124	76
10017940	73	10723050	518	12316247	428	100181133	76
10017941	78	10723144	519	12316247	435	100182121	75
10018012	72	10723151	519	12316248	431	100182122	73
10018027	75	10723153	519	12316248	436	100182123	74

Prod. Codex	Page	Prod. Codex	Page	Prod. Codex	Page	Prod. Codex	Page
100182125	78	1039223.A	187	2518312.A	144	525133.A-310	308
100182132	77	1039242.A	186	2518328.A	144	525146.A	296
105171143	356	1039243.A	187	257712.A	144	525148.A	296
105172144	357	116172113.A	473	257722.A	144	525152.A	300
105173143	356	11617212.A	472	257728.A	144	525152.A-300	300
105174144	357	11617221.A	472	257738.A	144	525152.A-310	300
105211145	358	11617242.A	473	525042.A	296	525154.A	300
105256145	358	11627113.A	473	525043.A	296	525154.A-300	300
105266145	358	1162712.A	472	525052.A	296	525154.A-310	300
115147112	154	1162721.A	472	525053.A	296	525156.A	300
115147113	154	1162742.A	473	525062.A	300	525156.A-300	300
115147114	154	1162821.A	472	525062.A-300	300	525156.A-310	300
115147115	154	1162842.A	473	525062.A-310	300	525158.A	301
115147116	155	11656113.A	473	525063.A	300	525158.A-300	301
115147117	155	1165612.A	472	525063.A-300	300	525158.A-310	301
115147118	155	1165621.A	472	525063.A-310	300	525160.A	308
115147119	155	1165642.A	473	525072.A	301	525160.A	308
115147212	154	1170121.A	478	525072.A-300	301	525160.A-300	308
115147214	154	1170242.A	480	525072.A-310	301	525162-300	308
115147216	155	11715012.A	480	525073.A	301	525162.A	308
115147218	155	1171542.A	480	525073.A-300	301	525162.A-310	308
121264112	340	117268146.A	479	525073.A-310	301	525164.A	308
121264114	340	117268147.A	479	525082.A	300	525164.A-300	308
121265112	340	117268148.A	481	525082.A-300	300	525164.A-310	308
121265114	340	117268149.A	481	525082.A-310	300	525166.A	309
123114118	436	117269146.A	479	525083.A	300	525166.A-300	309
123114137	435	117269147.A	479	525083.A-300	300	525166.A-310	309
123151137	450	117269148.A	481	525083.A-310	300	529003-300	456
123154118	451	117269149.A	481	525092.A	300	529003-310	456
123162116	434	117279146.A	479	525092.A-300	300	529004-300	456
123162117	436	117279147.A	479	525092.A-310	300	529004-310	456
123162136	435	117279148.A	481	525093.A	300	529007-300	457
123166137	435	117279149.A	481	525093.A-300	300	529007-310	457
123167137	435	1176612.A	478	525093.A-310	300	529008-300	457
123168118	436	1176621.A	478	525102.A	308	529008-310	457
123170118	436	1180121.A	486	525102.A-300	308	529024-300	456
123214117	434	1180242.A	488	525102.A-310	308	529024-310	456
123234117	434	11815142.A	488	525103.A	308	529028-300	457
123235117	434	11815212.A	488	525103.A-300	308	529028-310	457
123240137	450	11815242.A	488	525103.A-310	308	529051-300	460
123241137	450	118271150.A	487	525112.A	309	529051-310	460
123243118	451	118271151.A	487	525112.A-300	309	529052-300	460
123244118	451	118271152.A	489	525112.A-310	309	529052-310	460
103101135.A	188	118271153.A	489	525113.A	309	529053-300	460
103101145.A	188	118272150.A	487	525113.A-300	309	529053-310	460
10310123.A	188	118272151.A	487	525113.A-310	309	529054-300	460
10310142.A	188	118272152.A	489	525122.A	308	529054-310	460
10310143.A	188	118272153.A	489	525122.A-300	308	529055-300	460
10321712.A	186	118282150.A	487	525122.A-310	308	529055-310	460
103217134.A	187	118282151.A	487	525123.A	308	529056-300	460
10321723.A	187	118282152.A	489	525123.A-300	308	529056-310	460
10322412.A	188	118282153.A	489	525123.A-310	308	531008-300	552
103224135.A	188	1186712.A	486	525132.A	308	531008-310	552
10322423.A	188	1186721.A	486	525132.A-300	308	531009-300	552
1039212.A	186	1189821.A	486	525132.A-310	308	531009-310	552
10392134.A	187	12314854	430	525133.A	308	531011-300	552
10392144.A	187	185.A	203	525133.A-300	308	531011-310	552

Prod. Codex	Page	Prod. Codex	Page	Prod. Codex	Page	Prod. Codex	Page
531012 -300	552	533012-310	22	534021-300	39	534064-310	41
531012 -310	552	533013-300	22	534021-310	39	534065-300	41
531020-300	554	533013-310	22	534023-300	39	534065-310	41
531020-310	554	533014-300	22	534023-310	39	534066-300	42
531021-300	554	533014-310	22	534024-300	39	534066-310	42
531021-310	554	533015-300	23	534024-310	39	534067-300	42
531024-300	554	533015-310	23	534026-300	39	534067-310	42
531024-310	554	533016-300	23	534026-310	39	536013-300	173
531025-300	554	533016-310	23	534027-300	39	536013-310	173
531025-310	554	533017-300	22	534027-310	39	536014-300	173
531209-300	552	533017-310	22	534029-300	40	536014-310	173
531209-310	552	533018-300	22	534029-310	40	536015-300	173
531212-300	552	533018-310	22	534030-300	40	536015-310	173
531212-310	552	533019-300	23	534030-310	40	536016-300	173
531221-300	554	533019-310	23	534031-300	40	536016-310	173
531221-310	554	533020-300	23	534031-310	40	536017-300	174
531224-300	554	533020-310	23	534032-300	40	536017-310	174
531224-310	554	533021-300	24	534032-310	40	536018-300	174
532002-300	200	533021-310	24	534033-300	40	536018-310	174
532002-310	200	533022-300	24	534033-310	40	536019-300	174
532003-300	200	533022-310	24	534034-300	40	536019-310	174
532003-310	200	533023-300	24	534034-310	40	536020-300	174
532005-300	200	533023-310	24	534036-300	41	536020-310	174
532005-310	200	533024-300	24	534036-310	41	536021-300	174
532006-300	200	533024-310	24	534037-300	41	536021-310	174
532006-310	200	533025-300	25	534037-310	41	536022-300	174
532008-300	200	533025-310	25	534039-300	41	536022-310	174
532008-310	200	533026-300	25	534039-310	41	536023-300	175
532009-300	200	533026-310	25	534040-300	41	536023-310	175
532009-310	200	533027-300	24	534040-310	41	536024-300	175
532014-300	200	533027-310	24	534042-300	41	536024-310	175
532014-310	200	533028-300	24	534042-310	41	536025-300	175
532017-300	200	533028-310	24	534043-300	41	536025-310	175
532017-310	200	533029-300	25	534043-310	41	536026-300	175
532020-300	200	533029-310	25	534045-300	42	536026-310	175
532020-310	200	533030-300	25	534045-310	42	536027-300	175
532022-300	201	533030-310	25	534046-300	42	536027-310	175
532022-310	201	533052-300	24	534046-310	42	536028-300	175
532023-300	201	533052-310	24	534047-300	42	536028-310	175
532023-310	201	533057-300	22	534047-310	42	536029-300	176
532024-300	201	533057-310	22	534048-300	42	536029-310	176
532024-310	201	533058-300	22	534048-310	42	536030-300	176
532025-300	201	533058-310	22	534057-300	39	536030-310	176
532025-310	201	533059-300	23	534057-310	39	536031-300	176
532026-300	201	533059-310	23	534058-300	39	536031-310	176
532026-310	201	533060-300	23	534058-310	39	536032-300	176
532027-300	201	533060-310	23	534059-300	39	536032-310	176
532027-310	201	533061-300	24	534059-310	39	536033-300	176
532028-300	201	533061-310	24	534060-300	40	536033-310	176
532028-310	201	533062-300	24	534060-310	40	536034-300	176
532029-300	201	533062-310	24	534061-300	40	536034-310	176
532029-310	201	533063-300	25	534061-310	40	536035-300	177
532030-300	201	533063-310	25	534062-300	40	536035-310	177
532030-310	201	533064-300	25	534062-310	40	536036-300	177
533011-300	22	533064-310	25	534063-300	41	536036-310	177
533011-310	22	534020-300	39	534063-310	41	536037-300	177
533012-300	22	534020-310	39	534064-300	41	536037-310	177

Prod. Codex	Page	Prod. Codex	Page	Prod. Codex	Page	Prod. Codex	Page
536038-300	177	536132-310	176	539027-300	255	539069-310	249
536038-310	177	536134-300	176	539027-310	255	539071-300	249
536039-300	177	536134-310	176	539029-300	256	539071-310	249
536039-310	177	536136-300	177	539029-310	256	539072-300	249
536040-300	177	536136-310	177	539030-300	256	539072-310	249
536040-310	177	536138-310	177	539030-310	256	539074-300	240
536041-300	178	536140-300	177	539032-300	257	539074-310	240
536041-310	178	536140-310	177	539032-310	257	539075-300	240
536042-300	178	536142-300	178	539033-300	257	539075-310	240
536042-310	178	536142-310	178	539033-310	257	539076-300	240
536043-300	178	536144-300	178	539035-300	257	539076-310	240
536043-310	178	536144-310	178	539035-310	257	539078-300	242
536044-300	178	536148-300	178	539036-300	257	539078-310	242
536044-310	178	536148-310	178	539036-310	257	539080-300	243
536047-300	178	536150-300	179	539038-300	242	539080-310	243
536047-310	178	536150-310	179	539038-310	242	539082-300	243
536048-300	178	536152-300	179	539039-300	242	539082-310	243
536048-310	178	536152-310	179	539039-310	242	539084-300	244
536049-300	179	536156-300	179	539041-300	243	539084-310	244
536049-310	179	536156-310	179	539041-310	243	539086-300	245
536050-300	179	536158-300	180	539042-300	243	539086-310	245
536050-310	179	536158-310	180	539042-310	243	539088-300	245
536051-300	179	536160-300	180	539044-300	243	539088-310	245
536051-310	179	536160-310	180	539044-310	243	539090-300	246
536052-300	179	539002-300	250	539045-300	243	539090-310	246
536052-310	179	539002-310	250	539045-310	243	539092-300	247
536055-300	179	539003-300	250	539047-300	244	539092-310	247
536055-310	179	539003-310	250	539047-310	244	539094-300	247
536056-300	179	539005-300	251	539048-300	244	539094-310	247
536056-310	179	539005-310	251	539048-310	244	539096-300	248
536057-300	180	539006-300	251	539050-300	245	539096-310	248
536057-310	180	539006-310	251	539050-310	245	539098-300	249
536058-300	180	539008-300	251	539051-300	245	539098-310	249
536058-310	180	539008-310	251	539051-310	245	539100-300	249
536059-300	180	539009-300	251	539053-300	245	539100-310	249
536059-310	180	539009-310	251	539053-310	245	539102-300	250
536060-300	180	539011-300	252	539054-300	245	539102-310	250
536060-310	180	539011-310	252	539054-310	245	539104-300	251
536114-300	173	539012-300	252	539056-300	246	539104-310	251
536114-310	173	539012-310	252	539056-310	246	539106-300	251
536116-300	173	539014-300	253	539057-300	246	539106-310	251
536116-310	173	539014-310	253	539057-310	246	539108-300	252
536118-300	174	539015-300	253	539059-300	247	539108-310	252
536118-310	174	539015-310	253	539059-310	247	539110-300	253
536120-300	174	539017-300	253	539060-300	247	539110-310	253
536120-310	174	539017-310	253	539060-310	247	539112-300	253
536122-300	174	539018-300	253	539062-300	247	539112-310	253
536122-310	174	539018-310	253	539062-310	247	539114-300	254
536124-300	175	539020-310	254	539063-300	247	539114-310	254
536124-310	175	539021-300	254	539063-310	247	539116-300	255
536126-300	175	539021-310	254	539065-300	248	539116-310	255
536126-310	175	539023-300	255	539065-310	248	539118-300	255
536128-300	175	539023-310	255	539066-300	248	539118-310	255
536128-310	175	539024-300	255	539066-310	248	539120-300	256
536130-300	176	539024-310	255	539068-300	249	539120-310	256
536130-310	176	539026-300	255	539068-310	249	539122-300	257
536132-300	176	539026-310	255	539069-300	249	539122-310	257

Prod. Codex	Page	Prod. Codex	Page	Prod. Codex	Page	Prod. Codex	Page
539124-300	257	544003-300	386	545041-310	402	7611512-300	86
539124-310	257	544003-310	386	545042-300	402	7611512-310	86
539130-300	240	544004-300	386	545042-310	402	7611513-300	86
539130-310	240	544004-310	386	545043-300	403	7611513-310	86
539132-300	242	544005-300	386	545044-300	403	7618412-300	86
539132-310	242	544005-310	386	545047-300	404	7618412-310	86
539134-300	244	544006-300	386	545047-310	404	7618413-300	86
539134-310	244	544006-310	386	545048-300	404	7618413-310	86
539136-300	246	544008-300	386	545048-310	404	7618512.A	87
539136-310	246	544008-310	386	545050-300	404	7618513.A	87
539138-300	248	544009-300	386	545050-310	404	9418613-300	93
539138-310	248	544009-310	386	545051-300	404	9418613-310	93
539140-300	250	545002-300	390	545051-310	404	94186131-300	94
539140-310	250	545002-310	390	545052-300	405	94186131-310	94
539142-300	252	545003-300	390	545053-300	405	9418713.A	93
539142-310	252	545003-310	390	545070-300	390	9418812-300	95
539144-300	254	545005-300	390	545070-310	390	9418812-310	95
539144-310	254	545005-310	390	545072-300	390	9418813-300	95
539146-300	256	545006-300	390	545072-310	390	9418813-310	95
539146-310	256	545006-310	390	545074-300	392	94188131-300	96
539148-300	240	545007-300	391	545074-310	392	94188131-310	96
539148-310	240	545008-300	391	545076-300	392	9418913.A	96
539150-300	242	545011-300	392	545076-310	392	944213-300	92
539150-310	242	545011-310	392	545078-300	396	944214-300	92
539152-300	244	545012-300	392	545078-310	396	944257-300	92
539152-310	244	545012-310	392	545080-300	396	944813-300	94
539154-300	246	545014-300	392	545080-310	396	944814-300	95
539154-310	246	545014-310	392	545082-300	398	944857-300	94
539156-300	248	545015-300	392	545082-310	398	945413-300	96
539156-310	248	545015-310	392	545084-300	398	945414-300	97
539158-300	250	545016-300	393	545084-310	398	945457-300	97
539158-310	250	545017-300	393	545086-300	402	948012-300	95
539160-300	252	545020-300	396	545086-310	402	948012-310	95
539160-310	252	545020-310	396	545088-300	402	948013-300	95
539162-300	254	545021-300	396	545088-310	402	948013-310	95
539162-310	254	545021-310	396	545090-300	404	9480131-300	96
539164-300	256	545023-300	396	545090-310	404	9480131-310	96
539164-310	256	545023-310	396	545092-300	404	948313-300	93
539166-300	240	545024-300	396	545092-310	404	948313-310	93
539166-310	240	545024-310	396	7511312-300	84	9483131-300	94
539168-300	242	545025-300	397	7511312-310	84	9483131-310	94
539168-310	242	545026-300	397	7511313-300	84	948512-300	93
539170-300	244	545029-300	398	7511313-310	84	948512-310	93
539170-310	244	545029-310	398	7511413-300	84	948513-300	93
539172-300	246	545030-300	398	7511413-310	84	948513-310	93
539172-310	246	545030-310	398	7511512-300	84	9485131-300	94
539174-300	248	545032-300	398	7511512-310	84	9485131-310	94
539174-310	248	545032-310	398	7518412-300	84	948612-300	95
539176-300	250	545033-300	398	7518412-310	84	948612-310	95
539176-310	250	545033-310	398	7518413-300	84	948613-300	95
539178-300	252	545034-300	399	7518413-310	84	948613-310	95
539178-310	252	545035-300	399	7518512.A	85	9486131-300	96
539180-300	254	545038-300	402	7518513.A	85	9486131-310	96
539180-310	254	545038-310	402	7611312-300	86	9724713-300	333
539182-300	256	545039-300	402	7611312-310	86	9724713-310	333
539182-310	256	545039-310	402	7611313-300	86	9724714-300	334
540001.A	262	545041-300	402	7611313-310	86	9724714-310	334

Prod. Codex	Page
9724723-300	333
9724723-310	333
9724724-300	334
9724724-310	334
9724813-300	333
9724813-310	333
9724814-300	334
9724814-310	334

ALPHABETICAL INDEX

Alfa	504	Leila	170
Alfia	164	Leo	418
Alice	158	Marco	516
Andrea	338	Martina	344
Anna	18	Martina Aqua	354
Ara	184	Melrie	462
Arcadia	388	Memi	528
Bea	120	Midna	454
Beta	508	Naboo	32
Camilla	152	New Torcia	220
Cassiopea	82	Pan	368
Chiara	124	Paola	542
Cielo	90	Pat	532
Clio	130	Perseo	290
Delta	498	Petra	136
Dooku	238	Pi	362
Eclipse	374	Rho	102
Emma	470	Sam	538
Epsilon	492	Sandro	210
Franco	314	Sigma	110
Gamma	512	Silvia	226
Giulia	384	Spock	266
Hyperion	378	Talia	204
Idra	140	Tapioca	68
Iota	278	Tau	410
Jackie	524	Trixie	146
K12	56	Vincenza	190
Kamino	48	Viviana	214
Kirk	258	Yama	548
Ladina	28	Zefiro	198

WARRANTY

ARES warrants to the Buyer the satisfactory operation of its products for the period of two years from date of Purchaser's purchase (the invoice date).

Within the warranty period any defects with ARES products as a result of faulty materials or workmanship will be rectified free of charge.

ARES reserves the right to rectify the fault by repair, exchange or replacement.

The warranty does not cover and the manufacturer will not be liable for:

- Parts and materials subject to continuous wear;
- Problems resulting from external causes such as accident, abuse, misuse, mishandling, negligence, fire, theft, vandalism, riot, explosion, natural disaster, or other external causes unrelated to product defect;
- Conditions demonstrating faulty installation, misapplication, extreme environmental conditions beyond those defined in the product specification, under/over voltage situations, lack of compliance with applicable instructions, improper or inadequate handling, shipping, maintenance, negligence, accident, or tampering;
- Incompatibility, improper design, manufacture, installation, operation or maintenance of products not supplied by Manufacturer;
- Situations in which manufacturer's control gears fixtures and or any parts are replaced with those from other manufacturers;
- The quality of the installation on Manufacturer products by the installer of those products. For example, the above warranties would not cover problems resulting from such an installer's installation methods.
- Small defects having a negligible effect in value or operation.

The warranty does not apply to any other claims (for instance additional cost incurred by the customer) unless agreed and accepted by the manufacturer in writing.

Contact Italy

Flos Spa
Via Angelo Faini, 2
25073 Bovezzo (Brescia)
Tel +39 0302438.1
flos.outdoor@flos.com

Distribution Spain

Antares Iluminación S.A.U.
Calle Mallorca, 1
Polígono Industrial Reva
46394 Ribarroja (Valencia)
Tel +34 96 166 95 20
flos.architectural@flos.com

**Distribution Belgium And
Luxembourg**

Flos Belux
M +32 474 413 485
flosbelux@flos.com

Distribution France

Flos Projets
20-22, passage Dauphine
75006 Paris
Tel +33 (0)1 40 64 17 44
flos.projets@flos.com

Distribution Germany

Flos G.m.b.H.
Obermünsterstraße 18
93047 Regensburg
Tel: +49-941-630837-00
info@flos-gmbh.de

Distribution United Kingdom

Atrium Ltd.
28 Leonard Street
EC2A 4BY London
Tel +44 (0)20 7681 9933
flos@atrium.ltd.uk

Distribution Denmark

Flos Scandinavia A/S
Sydhavnsgade 28
DK-2450 København SV
Tel +45 (0) 3388 60 00
info@flos.dk

Distribution Norway

Flos Norge A/S
Drammensveien 120
N-0277 Oslo
Tel +47 (0) 2212 86 00
info@flos.no

Distribution The Netherlands

Flos BV
Cruquiusweg 109Q
1019 AG Amsterdam
Tel +31 (0) 20 560 50 60
flosnetherlands@flos.com

Distribution U. S. A.

Flos USA Inc.
110 York Street - 5th Floor
Brooklyn, NY 11201
Tel +1 (718) 875-3472
info@flosusa.com

Distribution Japan

Flos Co., Ltd.
PMC Building 9F
1-23-5 Higashiazabu Minato-Ku
Tokyo 104-0044
Tel +81 (0) 3 35 82 14 68
info@flosjapan.com

Distribution Far East

Flos Representative Office 1,
Commonwealth Lane #08-12
149544 Singapore
Tel +65 (0) 6372 1495
flosasia@flos.com

Distribution China

Flos illumination Shanghai Co Ltd
Unit 101, Floor 1, Building B9
No 800 of Chang De Road,
Jing An District
Shanghai 200040, China
Tel +86-21-61176187
floschina@flos.com

Distribution Latin America

Flos LatAm
Tel: +54 9 11 6817 8543
flos.latam@flos.com

Showroom Milano

Corso Monforte, 15
20122 Milano
Tel +39 02 79 84 57
contract.milano@flos.com

Showroom Copenhagen

Sydhavns-gade 28
DK-2450 København SV
Tel +45 (0) 3388 60 00
info@flos.dk

Showroom Amsterdam

Cruquiusweg 109Q
1019 AG Amsterdam
The Netherlands
Tel +31 (0) 20 560 50 60
info@flosmail.nl

Showroom Oslo

Drammensveien 120
N-0277 Oslo
Tel +47 (0) 2212 86 00
info@flos.no

Showroom Tokyo

PMC Building 9F
1-23-5 Higashiazabu Minato-Ku
Tokyo 104-0044
Tel +81 (0) 3 35 82 14 68
info@flosjapan.com

Showroom France

Flos Projets
20-22, passage Dauphine
75006 Paris
Tel +33 (0)1 40 64 17 44
flos.projets@flos.com

Flagship Store Milano

Corso Monforte, 9 - 20122
Tel +39 02 37011080
flosmilano@flos.com

Flagship Store Roma

Via del Babuino, 85 - 00187
Tel +39 06 3207631
flosroma@flos.com

Flagship Store Paris

15, rue de Bourgogne - 75007
Tel +33 (0)1 53 85 49 93
shop@flos.fr

Flagship Store Lyon

17 rue Jarente - 69002
Tel +33 478621301
lyon@flos.fr

Flagship Store Stockholm

Karlaplan Lützengatan 1 - S-115-20
Tel +46 (0) 8 660 4405
info@flos.se

Flagship Store New York

152 Greene Street - NY 10012
Tel +1 212 941 4760
info@flosusa.com

Copyright © June 2019 by Ares S.r.l.

We are not responsible for printing errors, wrong dimensions, descriptions or technical data.
The company reserves the right to amend all products herein detailed, any time and without prior notice.
Unauthorized reproductions and copies are prohibited

