

NEWS
2020
COLLECTION
UPDATE

ARKOSLIGHT®

LIGHT&LIFE
— DESDE 1984 —

ARKOSLIGHT®

THE HOME OF LIGHT

ARKOSLIGHT HEADQUARTERS
VALENCIA · SPAIN



EINE NEUE KOLLEKTION

ZWEI BÄNDE



News 2020 Collection Update

Mit völlig neuen Produkten sowie aktualisierten Leuchten. Für letztere bieten wir Ihnen Codegeneratoren an, um Ihnen bei Ihrer Bestellung zu helfen.

The 2019 Collection

Gültige Fassung des aktuellen Hauptkatalogs. Wird verwendet, um das Stammverzeichnis der Codes der in diesem Katalog News 2020 aktualisierten Produkte zu ermitteln. Falls Ihnen 'The New Collection 2019' nicht vorliegt, können Sie diesen Katalog herunterladen oder Ihren Vertreter oder Ihre Verkaufsstelle danach fragen.

DESIGN SIGN AWARDS

2 DESIGN PLUS



FLAP
2016

LEX ECO
2012

2 GOOD DESIGN



SIX
2018

IO
2017

3 ARCHIPRODUCTS DESIGN AWARDS

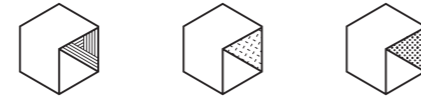

ART
2019

TOP
2018

POINTER
2017

2 EUROPEAN PRODUCT DESIGN AWARD



TOP
2019

POP UP
2018

2 FX AWARD



ART
2019

PLUS
2019

1 PREMIO BIENAL IBEROAMERICANA DE DISEÑO



ZEN
2014

1 BOY AWARD



BLACK FOSTER
2019

8 IF DESIGN AWARD



RHINO
2020

BLACK FOSTER
2019

SHOT LIGHT
2017

IO
2017

FLAP
2016

SALT
2015

SLIMGOT
2014

ZEN
2014

5 RED DOT DESIGN AWARD



ART
2019

DRUM
2016

SWAP
2015

LARK-111
2014

SLIMGOT
2014

7 A'DESIGN AWARD



FLAP
2016

DRUM
2016

SPIN
2015

THOR
2015

SKY
2015

DROP
2015

ZEN
2014

7 DELTA AWARDS



POINTER
2018

SHOT LIGHT
2018 Selección

IO
2016

AURAE
2014 Selección

STRAM
2014 Selección

ZEN
2013 Selección

LEX ECO
2012 Selección

7 GERMAN DESIGN AWARD



SIX
2019

THOR
2016 Nominee

SPIN
2016 Nominee

SALT
2016 Nominee

SWAP
2016 Nominee

LARK-111
2016 Nominee

SLIMGOT
2016 Nominee

5 ICONIC AWARDS



SHOT LIGHT
2017

PUCK
2017

OLYMPIA
2017 Selection

THOR
2016

SPIN
2016

4 PREMIOS ADCV



PLUS
2019

ART
2019

IO
2017

FLAP
2017

HIGHLIGHTS

ARKOSLIGHT FREUT SICH, IHNEN DIE NEUESTEN DESIGNS UND PRODUKTAKTUALISIERUNGEN DER FIRMA PRÄSENTIEREN ZU KÖNNEN. ENTDECKEN SIE HIER DIE VORSCHLÄGE VON ARKOSLIGHT, DAMIT IHRE PROJEKTE WEITERHIN ZUR AVANTGARDE VON BELEUCHTUNG UND PRODUKTDESIGN GEHÖREN.



P. 010

Minimal Track
Neues miniaturisiertes Schienensystem.



P. 030

Track 48V
Neue 48V-Niederspannungsschienen.

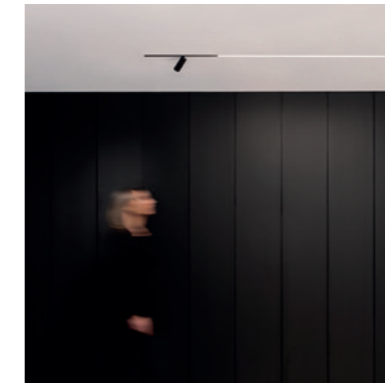

P. 040

Nueva Line
Jetzt in drei neuen Längen erhältlich.



P. 042

Black Foster Spotlights
Mit den Strahlern Plus Mini, Six S und Fit 35.



P. 048

Black Foster, now Asymmetric
'Recessed', 'Trimless' und 'Custom'.



P. 056

Art Modular
Neue Maße und Verarbeitungen.



P. 062

Wellit
Ausrichtbare Leuchte für Einzelhandel und Objektausstattung.



P. 068

Lex Eco Mini
Die kleinere Version von Lex Eco.



P. 072

Stram Surface Mini
Stram Surface in einer Mini-Version.

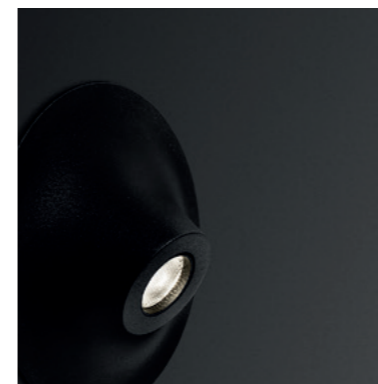

P. 074

Rinho
Halb-eingebaute Leuchte für die Bodenbestrahlung.



P. 078

Wally
Leuchte zur Bodenbestrahlung mit architektonischer Ästhetik.



P. 080

Other Updated Products
Neue Produktaktualisierungen.



MINIMAL TRACK

Das unglaublichste miniaturisierte
Schienensystem auf dem Markt.

MINIMAL TRACK INSTALLATION

1. Erstellen Sie Ihr eigenes Design mit Minimal Track.

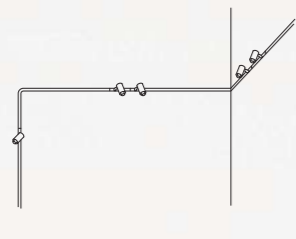

2. Befestigen Sie den Rahmen an der Wand.

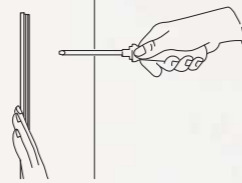

3. Elektrifizieren Sie den gesamten Weg mit dem flexiblen Band.



4. Platzieren Sie die Leuchte von der gegenüberliegenden Kante des Konektors aus.

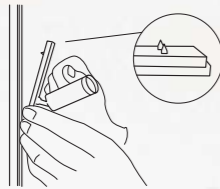

5. Drücken Sie die Leuchte in das flexible Band.

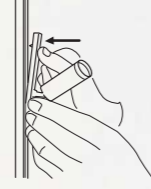

6. Befestigen.

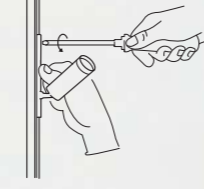

24V SYSTEM MINIMAL TRACK

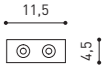
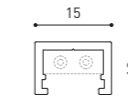
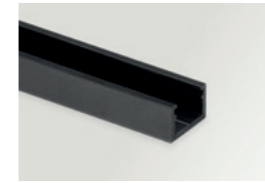

MINIMAL TRACK 24V Profile 2m

A384-02-00- | N |

MINIMAL TRACK 24V Rubber Cable n x 1m

A384-00-01- | N |

n = Total Length of System.



24V | Max. 4A | CE | III

MINIMAL TRACK 24V Corner 90° 1 Plane

A384-00-02- | N |

Cable Length = 35mm.

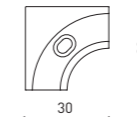

MINIMAL TRACK 24V End Cap

A384-00-05- | N |



MINIMAL TRACK 24V Corner 90° 1 Plane Rounded

A384-00-03- | N |

Cable Length = 35mm.

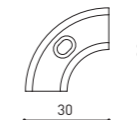

MINIMAL TRACK 24V Connection Box

A384-00-06- | N |

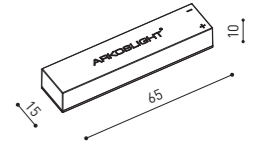

MINIMAL TRACK 24V Corner 90° 2 Planes

A384-00-04- | N |

Cable Length = 100mm.

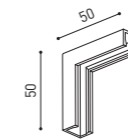

			P	V	D (A x B x C)
MINIMAL TRACK 24V Power Supply Box	ON/OFF	A384-00-07- N	40W	24V	280 x 30 x 24mm
		A384-00-08- N	100W	24V	280 x 30 x 24mm

Driver must be placed adjacently to the Minimal Track 24Vdc Profile. Included ON/OFF 24Vdc Power Supply.

MINIMAL TRACK 24V Remote Power Supply	ON/OFF	0434-01-37	60W	24V	180 x 52 x 30mm
		0433-10-22	100W	24V	295 x 43 x 30mm

Driver must be placed on Remote. Included ON/OFF 24Vdc Power Supply.

DROP VOLTAGE TABLE

POWER (W)	CABLE SECTION (mm ²)	CABLE LENGTH (m)			
		<5	<10	<20	<30
40	0,75	30	30	30	30
	1,5	30	30	30	30
60	0,75	30	30	20	10
	1,5	30	30	30	20
100	0,75	20	10	X	X
	1,5	20	20	10	X

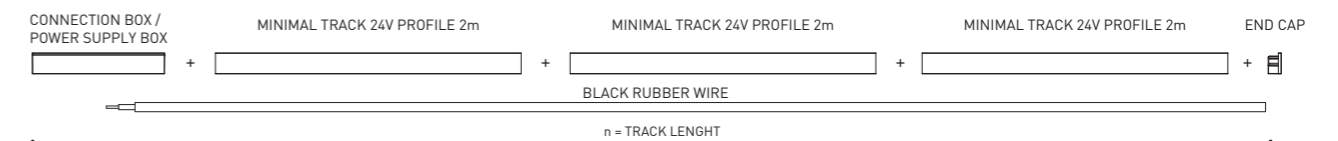
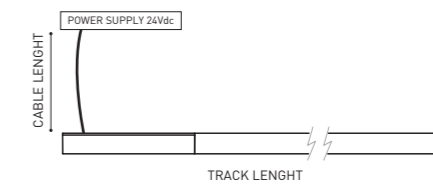

COLOUR | N ■ RAL 9005 |

DIM OPTIONS PLEASE CONSULT





Alaska ist die zeitgenössische Neuinterpretation der klassischen Glühbirne mit Glühfaden. Alaska besteht aus einer Kugel aus massivem optischem Glas als Symbol für die Glasbirne der herkömmlichen Glühlampe. Der kompakte Körper aus einem Guss wird wie ein Schmuckstück von Hand geformt und poliert. Jede der Leuchten wird nach traditionellen Methoden gefertigt und besitzt darum den Wert eines einzigartigen Dekorationsobjekts.



		P	CCT	I	Flux	LOR
ALASKA 24V	A385-00-00- N	3,5W	2700K	400mA	390Lm	30%
	A385-00-01- N	3,5W	3000K	400mA	410Lm	30%

LED | 24 V | CE | III | IP20 | CRI>90 | L80B10 >60.000h

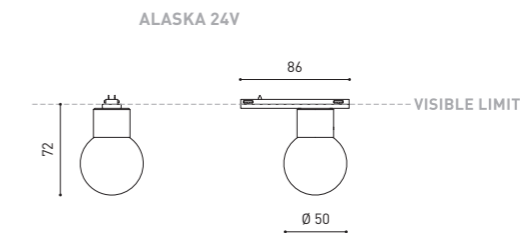

COLOUR | N ■ RAL 9005 | MATERIAL | AL | OPTICAL GLASS |

» PLEASE CONSULT

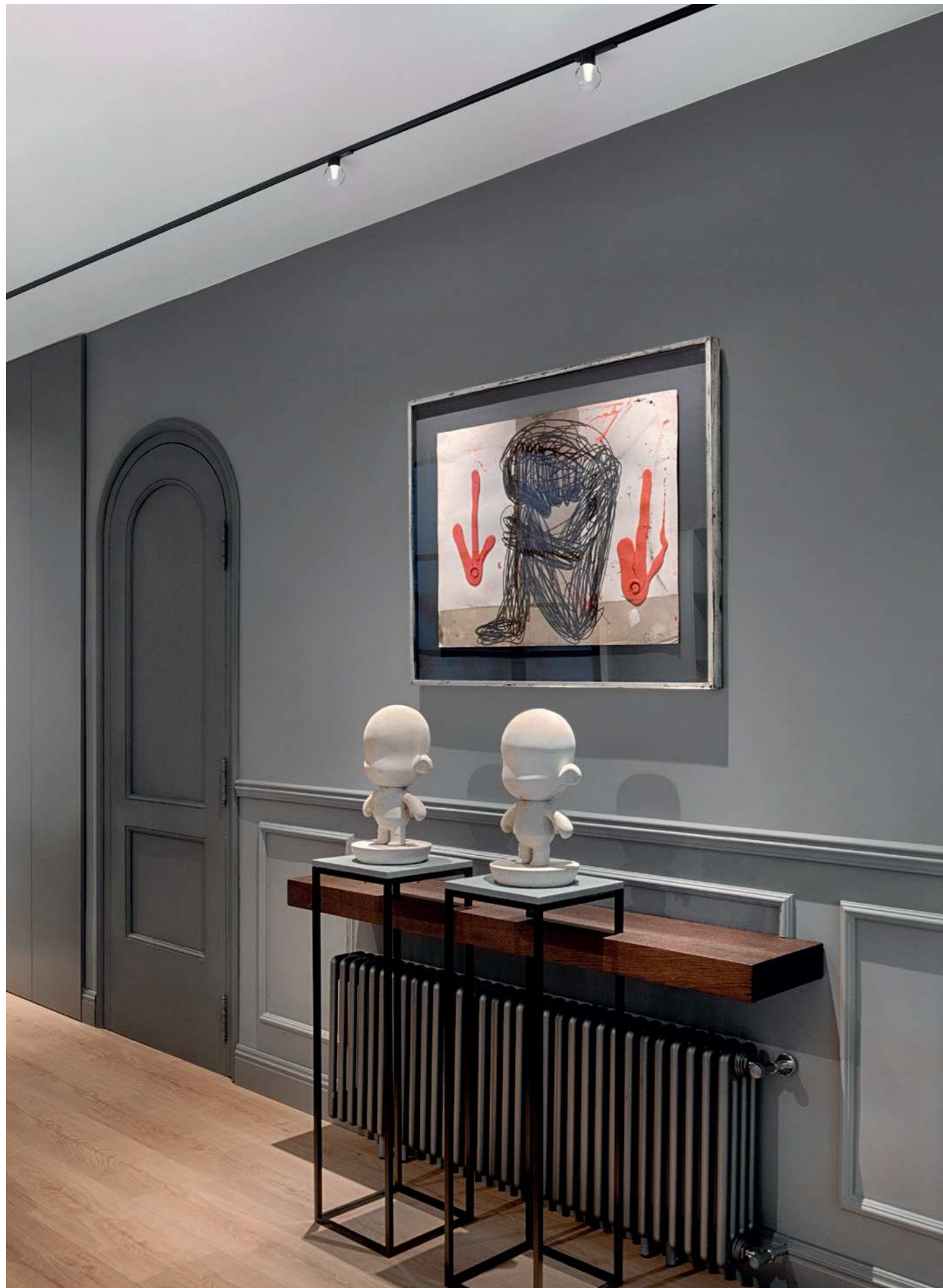

Private residence (Spain) | Design: Leticia Vila & Vicente Olivares

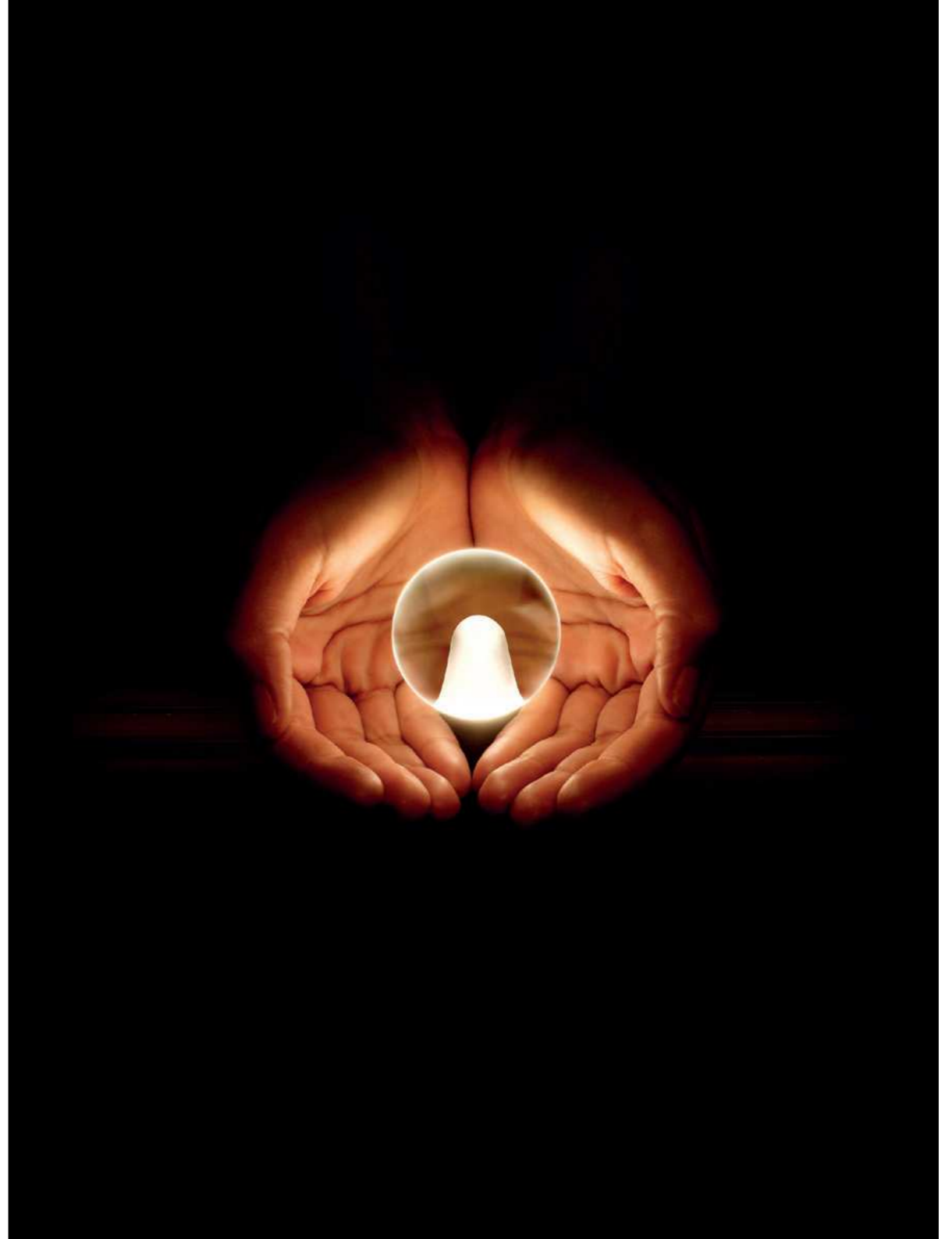



		P	CCT	BEAM	I	Flux	LOR
SIX XS 24V	A389-00-10- WT NT	3,5W	2700K	17°	400mA	400Lm	90%
	A389-00-11- WT NT	3,5W	3000K	17°	400mA	420Lm	90%
	A389-00-12- WT NT	3,5W	4000K	17°	400mA	450Lm	90%
	A389-00-20- WT NT	3,5W	2700K	23°	400mA	400Lm	86%
	A389-00-21- WT NT	3,5W	3000K	23°	400mA	420Lm	86%
	A389-00-22- WT NT	3,5W	4000K	23°	400mA	450Lm	86%
	A389-00-30- WT NT	3,5W	2700K	34°	400mA	400Lm	88%
	A389-00-31- WT NT	3,5W	3000K	34°	400mA	420Lm	88%
	A389-00-32- WT NT	3,5W	4000K	34°	400mA	450Lm	88%

LED | 24V | **CE** | **III** | **IP20** | **CRI>90** | **L80B10 >60.000h**

MacAdam Step 2 | **INCL** | **MINIMAL TRACK 24V** | **355°** | **310°** | **17° / 23° / 34°**

ACCESSORY

SIX High Chromatic LED*

NOT SOLD SEPARATELY

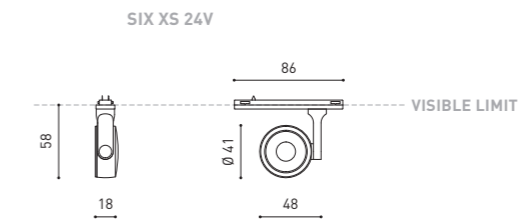

COLOUR | **W** RAL 9016 | **N** RAL 9005 | MATERIAL | **AL** | **PC**

* ACCESSORY & COLOURS AFFECT THE LIGHTING PARAMETERS

» PLEASE CONSULT



				P	CCT	I	Flux	LOR
PLUS Micro 24V	A388-00-00-	WT	NT	4,7W	2700K	400mA	500Lm	10-17%
	A388-00-01-	WT	NT	4,7W	3000K	400mA	520Lm	10-17%
	A388-00-02-	WT	NT	4,7W	4000K	400mA	570Lm	10-17%

LED | 24 V | CE | III | IP20 | CRI>90 |
 MacAdam Step 2 | INCL | MINIMAL TRACK 24V |
 355° | 180° | 10-35° | 10-35°

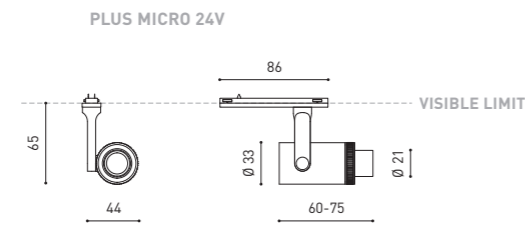

COLOUR | W □ RAL 9016 | N ■ RAL 9005 | MATERIAL | AL | OPTICAL PMMA |

» PLEASE CONSULT





		P	CCT	BEAM	I	Flux	LOR
iO Micro 24V	A387-00-10- WT NT	4,7W	2700K	20°	400mA	500Lm	88%
	A387-00-11- WT NT	4,7W	3000K	20°	400mA	520Lm	88%
	A387-00-12- WT NT	4,7W	4000K	20°	400mA	570Lm	88%
	A387-00-20- WT NT	4,7W	2700K	40°	400mA	500Lm	86%
	A387-00-21- WT NT	4,7W	3000K	40°	400mA	520Lm	86%
	A387-00-22- WT NT	4,7W	4000K	40°	400mA	570Lm	86%
	A387-00-30- WT NT	4,7W	2700K	54°	400mA	500Lm	86%
	A387-00-31- WT NT	4,7W	3000K	54°	400mA	520Lm	86%
	A387-00-32- WT NT	4,7W	4000K	54°	400mA	570Lm	86%

LED | 24V | CE | III | IP20 | CRI>90



ACCESSORIES

NOT SOLD SEPARATELY

iO Micro 24V Beam Mixer Diffuser* A387-00-00



iO Micro 24V Anti-glare Honeycomb Louver* A387-00-01- | WT | NT |



IO MICRO 24V

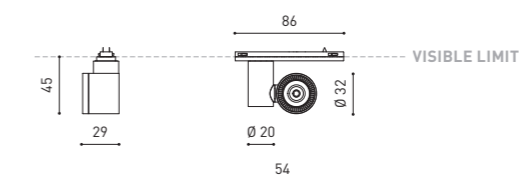

COLOUR | W □ RAL 9016 | N ■ RAL 9005 | MATERIAL | AL | PC

* ACCESSORY AFFECTS THE LIGHTING PARAMETERS

» PLEASE CONSULT



		P	CCT	BEAM	I	Flux	LOR
TOP Micro 24V	A383-00-10- WT NT	2,1W	2700K	17°	700mA	190Lm	92%
	A383-00-11- WT NT	2,1W	3000K	17°	700mA	210Lm	92%
	A383-00-20- WT NT	2,1W	2700K	35°	700mA	190Lm	93%
	A383-00-21- WT NT	2,1W	3000K	35°	700mA	210Lm	93%

LED | 24 V | CE | III | IP20 | CRI>90 | L80B10 >60.000h

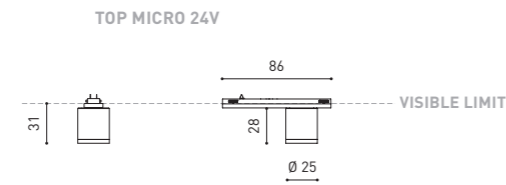

COLOUR | W □ RAL 9016 | N ■ RAL 9005 | MATERIAL | AL

» PLEASE CONSULT

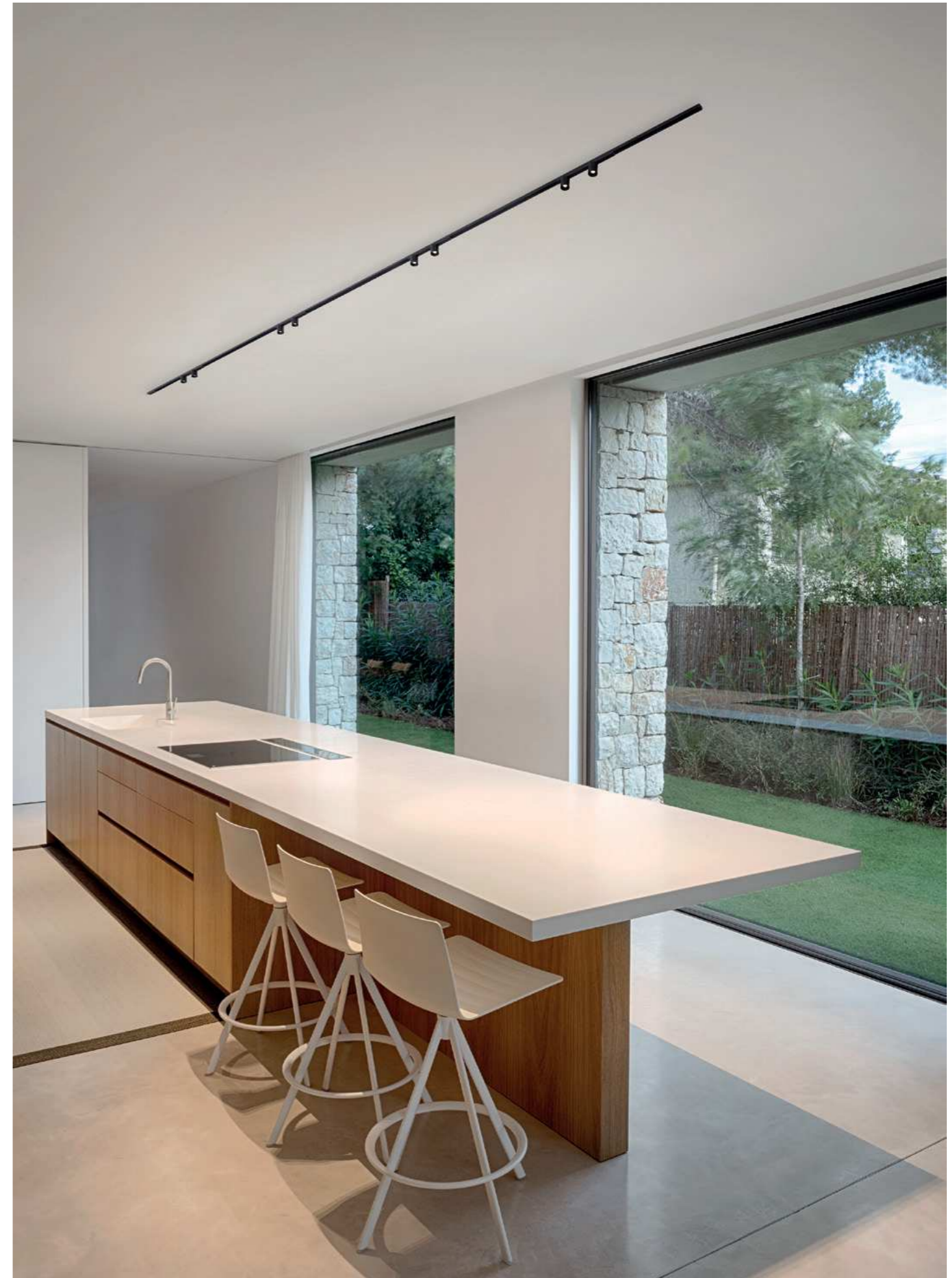

Casa PA (Spain) | Design: Ormos Estudio | Built: STR; Soluciones Técnicas Obras y Rehabilitación | Photography: Diego Opazo



				P	CCT	BEAM	I	Flux	LOR
FIT 20 24V	A386-00-10-	WT	NT	2,1W	2700K	12°	700mA	127Lm	87%
	A386-00-11-	WT	NT	2,1W	3000K	12°	700mA	150Lm	87%
	A386-00-20-	WT	NT	2,1W	2700K	30°	700mA	127Lm	88%
	A386-00-21-	WT	NT	2,1W	3000K	30°	700mA	150Lm	88%
	A386-00-30-	WT	NT	2,1W	2700K	54°	700mA	127Lm	81%
	A386-00-31-	WT	NT	2,1W	3000K	54°	700mA	150Lm	81%

LED | 24 V | **CE** | **III** | IP20 | CRI>90 | L80B10 >50.000 h

MacAdam Step 3 | **INCL** | **MINIMAL TRACK 24V** | 355° | 90° | 12° / 30° / 54°

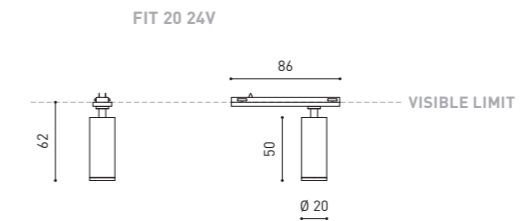

COLOUR | W □ RAL 9016 | N ■ RAL 9005 | MATERIAL | ▮ AL | ⊕ PC |

» PLEASE CONSULT



NEW

TRACK 48V

Arkoslight erweitert seine Reihe von 48V-Niederspannungsschienen. Track 48V "Surface" ist jetzt in zwei Versionen erhältlich: Standard und "Short", 25mm kürzer (54mm gegenüber 29mm). Track 48V Surface Short ist für Anwendungen gedacht, bei denen die Schiene mehr in die Decke integriert werden soll.

48V SYSTEM
TRACK 48V

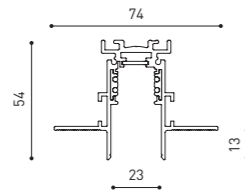
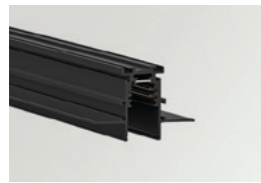

TRACK 48V TRIMLESS

TRACK 48V TRIMLESS 1m	A338-01-00-	N
TRACK 48V TRIMLESS 2m	A338-02-00-	N
TRACK 48V TRIMLESS 3m	A338-03-00-	N
TRACK 48V TRIMLESS Corner 90° One Plane	A338-06-00-	N
TRACK 48V TRIMLESS Corner 90° Two Planes	A338-07-00-	N

PLASTERBOARD CEILING, MANDATORY THICKNESS 12,5mm.
RECOMMENDED FOR INSTALLATIONS WHERE THE PROFILE CAN BE
INSTALLED BEFORE THE FALSE PLASTERBOARD CEILING.



TRACK 48V TRIMLESS
Corner 90° One Plane

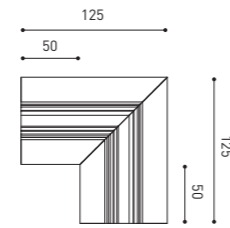

*Electrical connection not included

TRACK 48V TRIMLESS
Corner 90° Two Planes

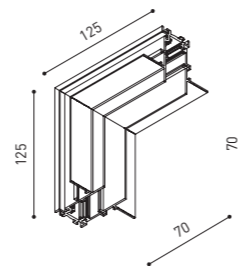

*Electrical connection not included

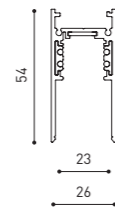

TRACK 48V SURFACE

TRACK 48V SURFACE 1m	A338-11-00-	N
TRACK 48V SURFACE 2m	A338-12-00-	N
TRACK 48V SURFACE 3m	A338-13-00-	N
TRACK 48V SURFACE Corner 90° One Plane	A338-14-00-	N



TRACK 48V SURFACE
Corner 90° One Plane

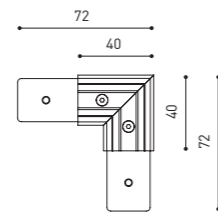

*Electrical connection not included

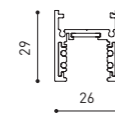

TRACK 48V SURFACE SHORT

TRACK 48V SURFACE SHORT 1m	A338-21-00-	N
TRACK 48V SURFACE SHORT 2m	A338-22-00-	N
TRACK 48V SURFACE SHORT 3m	A338-23-00-	N
TRACK 48V SURFACE SHORT Corner 90° One Plane	A338-24-00-	N



TRACK 48V SURFACE SHORT
Corner 90° One Plane

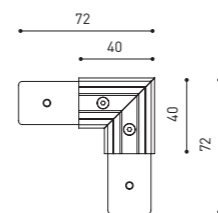

*Electrical connection not included

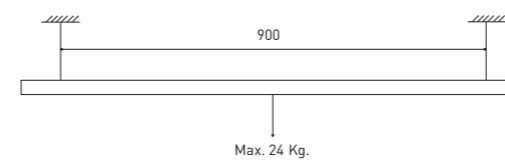
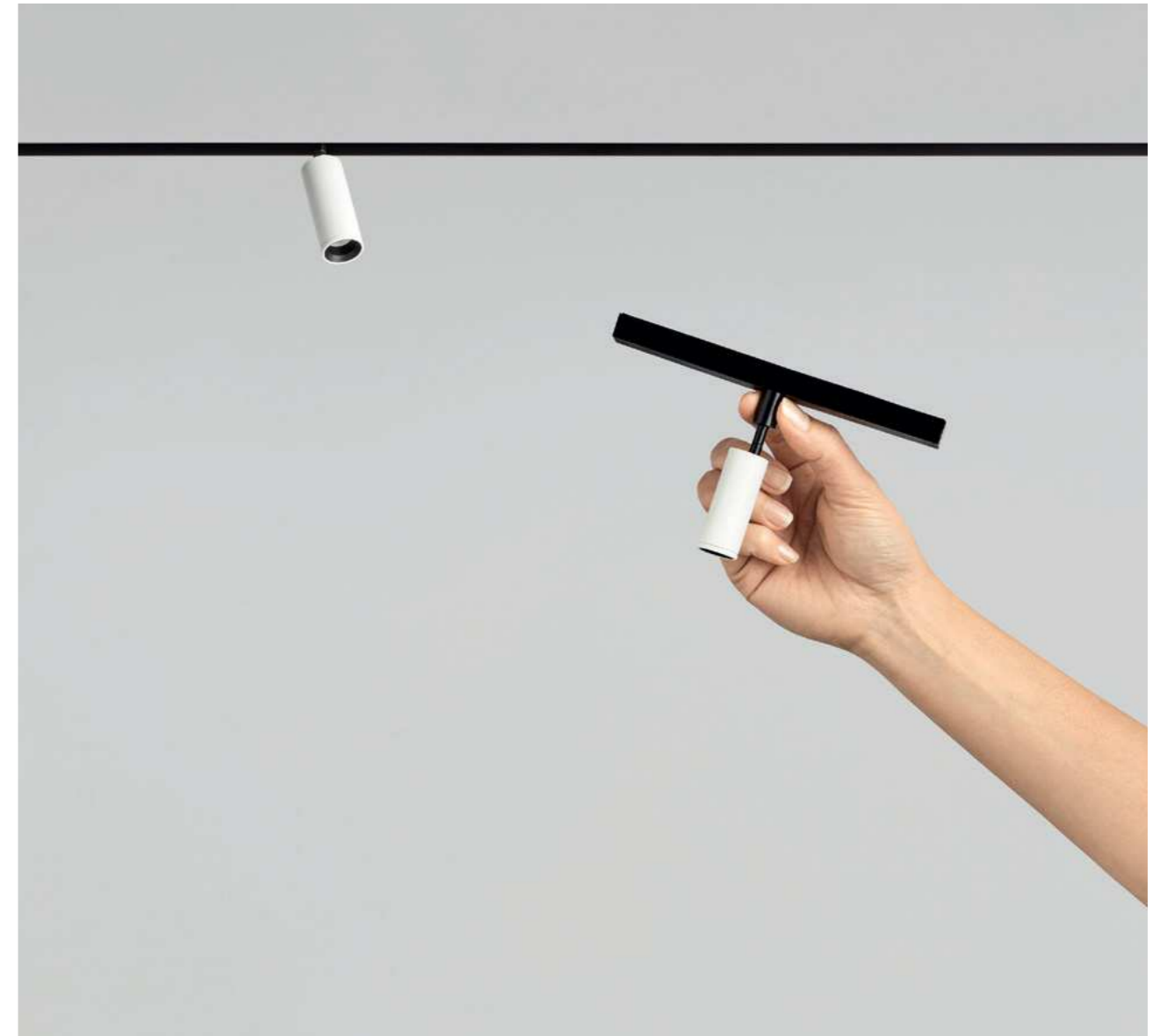

	P	V	D
CONSTANT VOLTAGE	0434-01-21	75W	48V
LED POWER SUPPLY	0434-01-22	150W	48V

DROP VOLTAGE TABLE

POWER (W)	CABLE SECTION (mm ²)	CABLE LENGTH (m)			
		5	10	20	30
75	0,75	50	50	30	X
	1,5	50	50	50	50
150	0,75	40	15	X	X
	1,5	50	40	20	X

ACCESSORIES

TRACK 48V

ALL 48V TRACKS

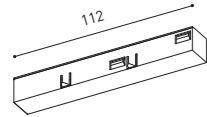

TRACK 48V Live-End Connector

A338-00-01- | N |

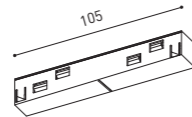

TRACK 48V Central Connector

A338-00-02- | N |

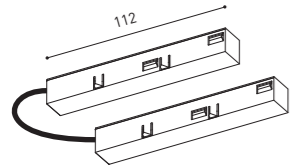

TRACK 48V Corner 90° Connector

A338-00-12- | N |

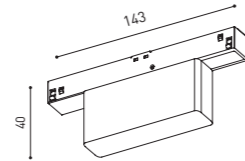

TRACK 48V Wireless Control

0434-01-31- | N | Casambi/AAG Stucchi App

0434-01-32- | N | AAG Stucchi App

TRIMLESS 48V



TRACK 48V TRIMLESS Short T-Bracket

A338-00-03



TRACK 48V TRIMLESS Clamp for M6 ROD

A338-00-09

*See accessories quantities

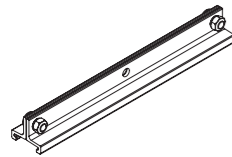

TRACK 48V TRIMLESS Long T-Bracket

A338-00-04



TRACK 48V TRIMLESS Track Clamp

A338-00-10

*See accessories quantities

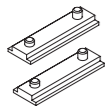

TRACK 48V TRIMLESS Straight Joiners (2 units)

A338-00-05



TRACK 48V TRIMLESS Suspension Kit

A338-00-08

*See accessories quantities

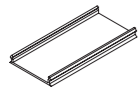

TRACK 48V TRIMLESS Plaster Installation Guard 1m

A338-00-21

* SUGGESTED MOUNTING ACCESSORIES QUANTITIES

1000mm - 2 Pcs.

2000mm - 3 Pcs.

3000mm - 4 Pcs.

SURFACE, SUSPENSION, SURFACE SHORT & SUSPENSION SHORT 48V

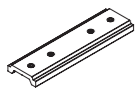

TRACK 48V SURFACE Straight Joiner

A338-00-11- | N |

COLOUR | N ■ |

ACCESSORIES

TRACK 48V

TRIMLESS, SURFACE & SUSPENSION 48V



TRACK 48V TRIMLESS & SURFACE End

A338-00-06- | N |



TRACK 48V TRIMLESS & SURFACE End Feed

A338-00-07- | N |

SURFACE SHORT & SUSPENSION SHORT 48V



TRACK 48V SURFACE SHORT End

A338-00-18- | N |



TRACK 48V SURFACE SHORT End Feed

A338-00-19- | N |

SURFACE & SURFACE SHORT 48V

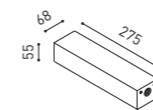

TRACK 48V Power Supply Case

A338-00-20- | N |



*To be installed aside 48V Surface Tracks
Power supply not included

SUSPENSION & SUSPENSION SHORT 48V

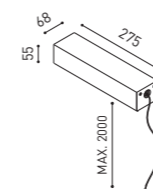

TRACK 48V Wired Power Supply Case

A338-00-22- | N |



A338-00-23- | N |

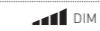

*Power supply not included



TRACK 48V SURFACE Suspension Kit (2 units)

A338-00-15- | N |



TRACK 48V SURFACE Suspension Feed Kit

A338-00-16- | N |



A338-00-17- | N |



*For remote power supply

COLOUR | N ■ |

TRACK 48V SURFACE



TRACK 48V SURFACE SHORT



TRACK 48V Products
CODE Generator Example - FIT

Reference from *The 2019 Collection*

A346 01 10 WT -S

REFERENCE ENDING ADD-ON
Track 48V Surface Short

KOMPATIBILITÄT

JE NACH SCHIENENTYP

TRACK 48V

Mit den Codes von *The 2019 Collection* bestellen

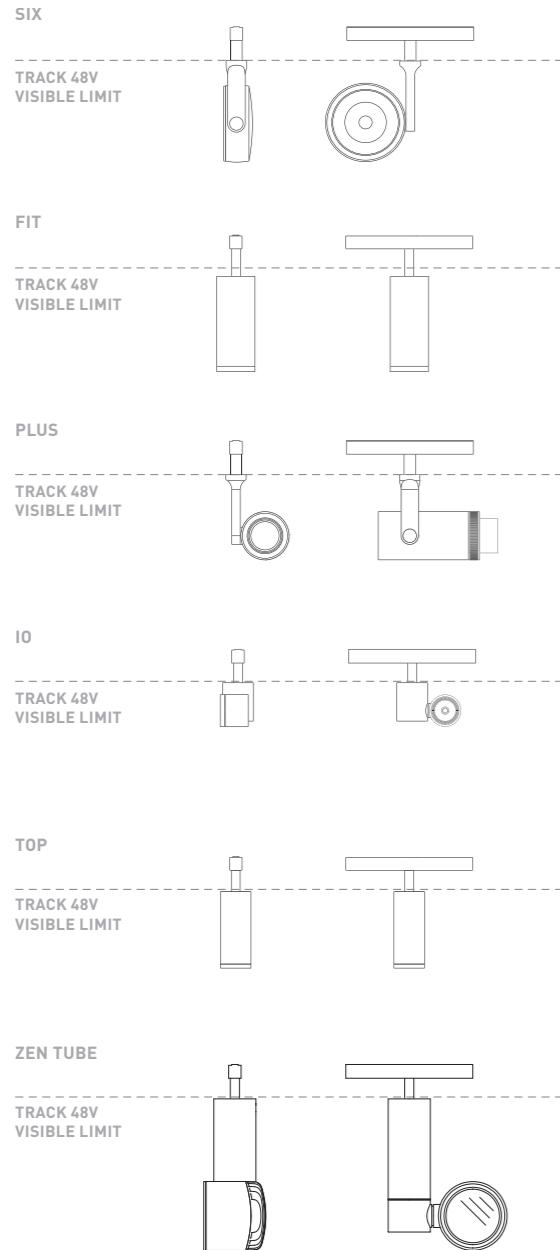

TRACK 48V SURFACE SHORT

Mit den Codes von *The 2019 Collection* + der auf "ADD-ON" endenden Artikelnummer bestellen: "S"

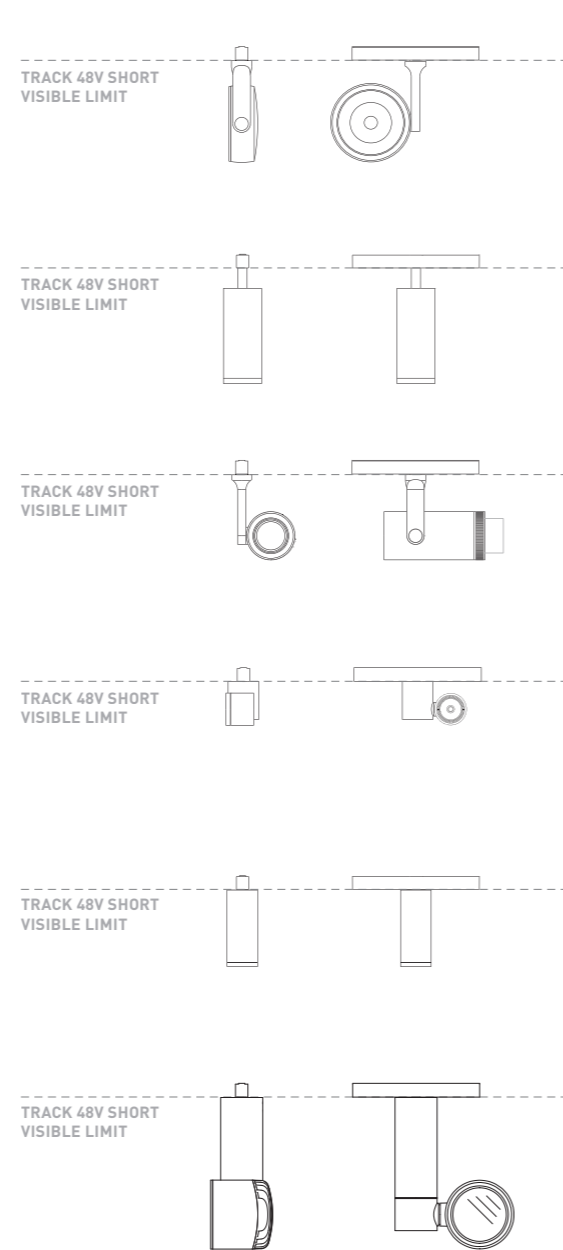

TRACK 48V & TRACK 48V SURFACE SHORT

Codes von *The 2019 Collection*. Produkte mit einer einzigen Version für beide Schienen.

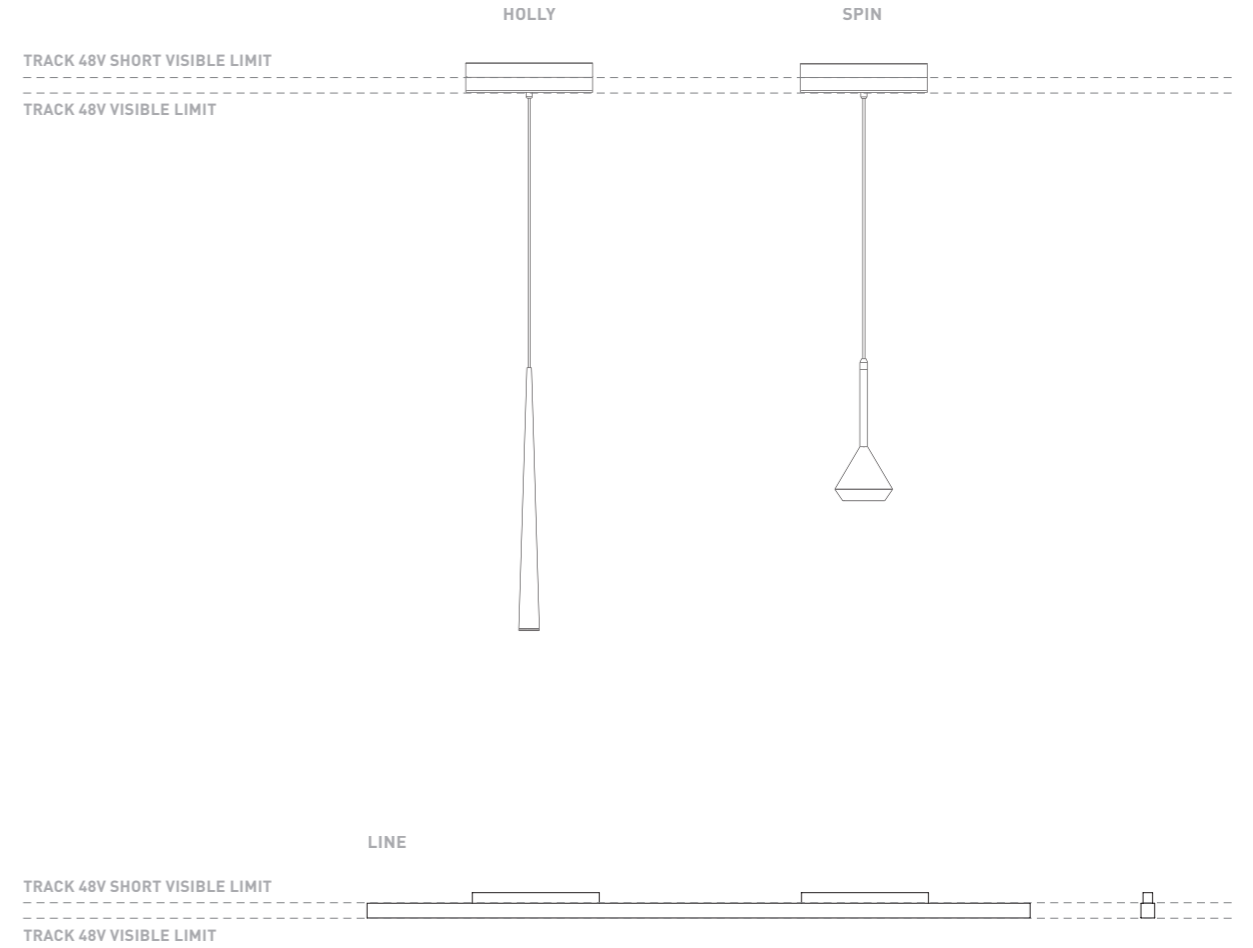



NEW
LINE



		P	CCT	I	Flux	LOR
LINE 500 48V	A376-10- Ⓞ -0- N	10,5W	2700K	350mA	1480Lm	43%
	A376-10- Ⓞ -1- N	10,5W	3000K	350mA	1600Lm	43%
LINE 1000 48V	A376-20- Ⓞ -0- N	21W	2700K	700mA	2960Lm	43%
	A376-20- Ⓞ -1- N	21W	3000K	700mA	3200Lm	43%
LINE 2000 48V	A376-30- Ⓞ -0- N	42W	2700K	700mA	5920Lm	43%
	A376-30- Ⓞ -1- N	42W	3000K	700mA	6400Lm	43%

LED | 48 V | CE | III | IP20 | CRI>90 | L80B10 >60.000 h
 MacAdam Step 2
OPTONS*
INCL
TRACK 48V
98°
98°

Ⓞ *OPTIONS

- 1 No DIM
- 2 DIM DALI

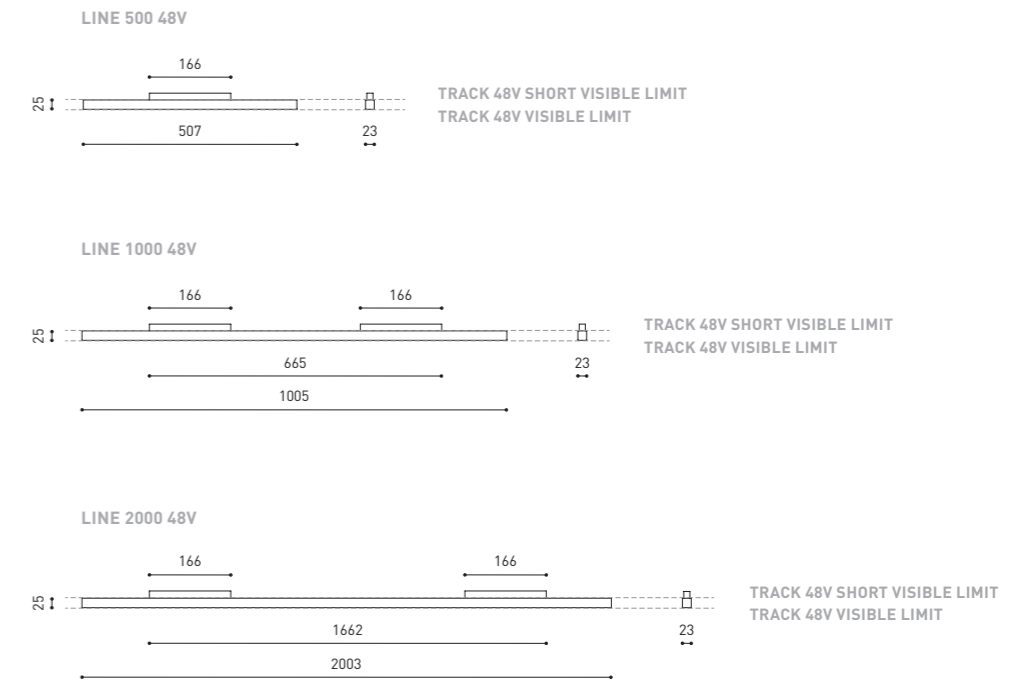

COLOUR | N ■ | MATERIAL | AL | PC |

» PLEASE CONSULT



BLACK FOSTER

SPOTLIGHTS

Black Foster kombiniert jetzt 'The Invisible Black'-Effekt mit Akzentbeleuchtung und bewahrt zugleich eine elegante unauffällige Ästhetik.





		P	CCT	BEAM	I	Flux	LOR
BLACK FOSTER PLUS Mini	A362-00- Ⓞ -0- WT NT	6,5W	2700K	10°-41°	700mA	630Lm	20-40%
	A362-00- Ⓞ -1- WT NT	6,5W	3000K	10°-41°	700mA	660Lm	20-40%
	A362-00- Ⓞ -2- WT NT	6,5W	4000K	10°-41°	700mA	680Lm	20-40%

LED | 220/240 V~ | CE | IP20 | CRI>90 | L80B10 >60.000h |
 MacAdam Step 2 | OPTIONS* | INCL | 350° | 180° | 10° - 41°



		P	CCT	BEAM	I	Flux	LOR
BLACK FOSTER FIT Ø35	A363-0- Ⓞ -10- WT NT	5,5W	2700K	19°	500mA	590Lm	82%
	A363-0- Ⓞ -11- WT NT	5,5W	3000K	19°	500mA	630Lm	82%
	A363-0- Ⓞ -20- WT NT	5,5W	2700K	29°	500mA	590Lm	80%
	A363-0- Ⓞ -21- WT NT	5,5W	3000K	29°	500mA	630Lm	80%
	A363-0- Ⓞ -30- WT NT	5,5W	2700K	38°	500mA	590Lm	80%
	A363-0- Ⓞ -31- WT NT	5,5W	3000K	38°	500mA	630Lm	80%

LED | 220/240 V~ | CE | IP20 | CRI>90 | L80B10 >60.000h |
 MacAdam Step 2 | OPTIONS* | INCL | 350° | 90° | 19° / 29° / 38°

Ⓞ *OPTIONS

1	No DIM
2	DIM DALI

ACCESSORY

PLUS mini High Chromatic LED**

NOT SOLD SEPARATELY



Ⓞ *OPTIONS

1	No DIM
2	DIM DALI

ACCESSORY

FIT Ø35 Anti-glare Honeycomb Louver ** A345-00-00

NOT SOLD SEPARATELY

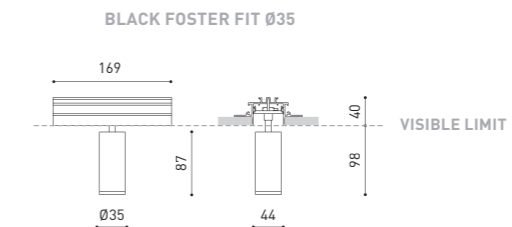
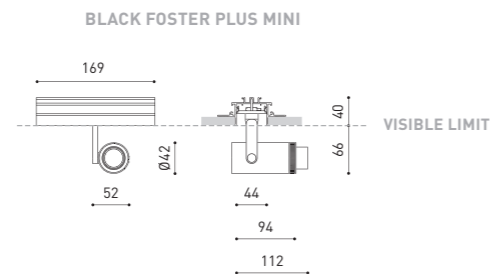
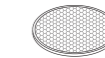

COLOUR | WT □ RAL 9016 | NT ■ RAL 9005 | MATERIAL | AL | OPTICAL PMMA | ABS+PC |

** ACCESSORY AFFECTS THE LIGHTING PARAMETERS
RECOMMENDED FOR INSTALLATIONS WHERE THE PROFILE CAN BE INSTALLED BEFORE THE FALSE PLASTERBOARD CEILING (THICKNESS 12,5mm.)



COLOUR | WT □ RAL 9016 | NT ■ RAL 9005 | MATERIAL | AL | PC | ABS+PC |

** ACCESSORY AFFECTS THE LIGHTING PARAMETERS
RECOMMENDED FOR INSTALLATIONS WHERE THE PROFILE CAN BE INSTALLED BEFORE THE FALSE PLASTERBOARD CEILING (THICKNESS 12,5mm.)





Das System Black Foster Custom erweitert seine Möglichkeiten mit den neuen Strahlern Plus Mini, Six S und Fit 35.

Außer den genannten Strahlern sind Fit 20 Double, Fit 20, iO, Six M, Six XS und Six XS Double für das System Black Foster Custom auf Anfrage erhältlich.



		P	CCT	BEAM	I	Flux	LOR
BLACK FOSTER SIX S	A360-0- Ⓞ -10- WT NT	8,5W	2700K	17°	500mA	1030Lm	86%
	A360-0- Ⓞ -11- WT NT	8,5W	3000K	17°	500mA	1070Lm	86%
	A360-0- Ⓞ -12- WT NT	8,5W	4000K	17°	500mA	1100Lm	86%
	A360-0- Ⓞ -20- WT NT	8,5W	2700K	24°	500mA	1030Lm	84%
	A360-0- Ⓞ -21- WT NT	8,5W	3000K	24°	500mA	1070Lm	84%
	A360-0- Ⓞ -22- WT NT	8,5W	4000K	24°	500mA	1100Lm	84%
	A360-0- Ⓞ -30- WT NT	8,5W	2700K	34°	500mA	1030Lm	89%
	A360-0- Ⓞ -31- WT NT	8,5W	3000K	34°	500mA	1070Lm	89%
	A360-0- Ⓞ -32- WT NT	8,5W	4000K	34°	500mA	1100Lm	89%

LED | 220/240 V~ | **CE** | IP20 | CRI>90 | L80B10 >60.000h |
 MacAdam Step 2 | OPTIONS* | INCL | 350° | 310° | 17°/24°/34°

Ⓞ *OPTIONS

1	No DIM
2	DIM DALI

ACCESSORY

SIX S High Chromatic LED**

NOT SOLD SEPARATELY

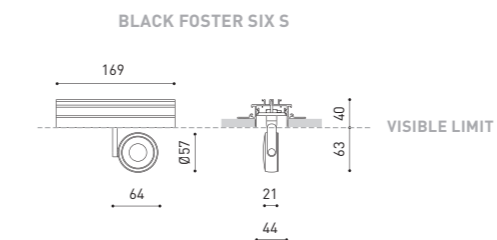

COLOUR | WT □ RAL 9016 | NT ■ RAL 9005 | MATERIAL | AL | PC | ABS+PC |

** ACCESSORY & COLOURS AFFECT THE LIGHTING PARAMETERS
RECOMMENDED FOR INSTALLATIONS WHERE THE PROFILE CAN BE INSTALLED BEFORE THE FALSE PLASTERBOARD CEILING (THICKNESS 12,5mm.)





BLACK FOSTER

NOW ASYMMETRIC

Black Foster ist nun mit asymmetrischer Lichtausgabe in den Varianten 'Recessed', 'Trimless' und 'Custom' erhältlich.





Ⓞ	*OPTIONS
1	No DIM
2	DIM Push
3	DIM 1-10V
4	DIM DALI

BLACK FOSTER ASYMMETRIC RECESSED

		P	CCT	I	Flux	LOR
BLACK FOSTER ASYMMETRIC Recessed 2	A374-20- Ⓞ -0- N WN	4,2W	2700K	700mA	380Lm	90%
	A374-20- Ⓞ -1- N WN	4,2W	3000K	700mA	420Lm	90%
	A374-20- Ⓞ -2- N WN	4,2W	4000K	700mA	500Lm	90%

LED | 220 V~ | CE | IP20 | CRI>90 | L80B10 >60.000h |
 MacAdam Step 3 | OPTIONS* | CONNEX | INCL | 50 X 93 | 38°

		P	CCT	I	Flux	LOR
BLACK FOSTER ASYMMETRIC Recessed 3	A374-30- Ⓞ -0- N WN	6,3W	2700K	700mA	570Lm	90%
	A374-30- Ⓞ -1- N WN	6,3W	3000K	700mA	630Lm	90%
	A374-30- Ⓞ -2- N WN	6,3W	4000K	700mA	750Lm	90%

LED | 220 V~ | CE | IP20 | CRI>90 | L80B10 >60.000h |
 MacAdam Step 3 | OPTIONS* | CONNEX | INCL | 50 X 136 | 38°

		P	CCT	I	Flux	LOR
BLACK FOSTER ASYMMETRIC Recessed 5	A374-40- Ⓞ -0- N WN	10,5W	2700K	700mA	950Lm	90%
	A374-40- Ⓞ -1- N WN	10,5W	3000K	700mA	1050Lm	90%
	A374-40- Ⓞ -2- N WN	10,5W	4000K	700mA	1250Lm	90%

LED | 220 V~ | CE | IP20 | CRI>90 | L80B10 >60.000h |
 MacAdam Step 3 | OPTIONS* | CONNEX | INCL | 50 X 222 | 38°

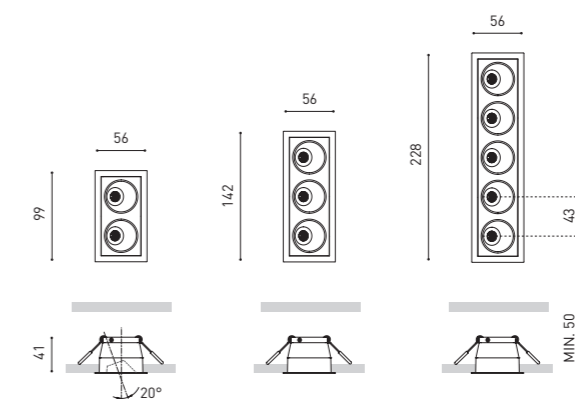

COLOUR | N ■ RAL 9005 | WN ■ RAL 9016 | RAL 9005 | MATERIAL | AL | ABS+PC |

Bluetooth & DALI » PLEASE CONSULT

BLACK FOSTER ASYMMETRIC TRIMLESS



		P	CCT	I	Flux	LOR
BLACK FOSTER ASYMMETRIC Trimless 2	A373-20- 00 -0- N	4,2W	2700K	700mA	380Lm	90%
	A373-20- 00 -1- N	4,2W	3000K	700mA	420Lm	90%
	A373-20- 00 -2- N	4,2W	4000K	700mA	500Lm	90%

LED | 220 V~ | 240 V~ | CE | IP20 | CRI>90 | L80B10 >60.000h | MacAdam Step 3 | OPTIONS* | CONNEC | INCL | 50 X 93 | 38°



		P	CCT	I	Flux	LOR
BLACK FOSTER ASYMMETRIC Trimless 3	A373-30- 00 -0- N	6,3W	2700K	700mA	570Lm	90%
	A373-30- 00 -1- N	6,3W	3000K	700mA	630Lm	90%
	A373-30- 00 -2- N	6,3W	4000K	700mA	750Lm	90%

LED | 220 V~ | 240 V~ | CE | IP20 | CRI>90 | L80B10 >60.000h | MacAdam Step 3 | OPTIONS* | CONNEC | INCL | 50 X 136 | 38°



		P	CCT	I	Flux	LOR
BLACK FOSTER ASYMMETRIC Trimless 5	A373-40- 00 -0- N	10,5W	2700K	700mA	950Lm	90%
	A373-40- 00 -1- N	10,5W	3000K	700mA	1050Lm	90%
	A373-40- 00 -2- N	10,5W	4000K	700mA	1250Lm	90%

LED | 220 V~ | 240 V~ | CE | IP20 | CRI>90 | L80B10 >60.000h | MacAdam Step 3 | OPTIONS* | CONNEC | INCL | 50 X 222 | 38°

00	*OPTIONS
1	No DIM
2	DIM Push
3	DIM 1-10V
4	DIM DALI

COLOUR | N ■ RAL 9005 | MATERIAL | AL | ABS+PC |

RECOMMENDED FOR INSTALLATIONS WHERE THE PROFILE CAN BE INSTALLED BEFORE THE FALSE PLASTERBOARD CEILING (THICKNESS 12,5mm.)



		P	CCT	I	Flux	LOR
BLACK FOSTER ASYMMETRIC Trimless 10	A373-50- 00 -0- N	21W	2700K	700mA	1900Lm	90%
	A373-50- 00 -1- N	21W	3000K	700mA	2100Lm	90%
	A373-50- 00 -2- N	21W	4000K	700mA	2500Lm	90%

LED | 220 V~ | 240 V~ | CE | IP20 | CRI>90 | L80B10 >60.000h | MacAdam Step 3 | OPTIONS* | CONNEC | INCL | 50 X 437 | 38°



		P	CCT	I	Flux	LOR
BLACK FOSTER ASYMMETRIC Trimless 15	A373-60- 00 -0- N	31,5W	2700K	700mA	2850Lm	90%
	A373-60- 00 -1- N	31,5W	3000K	700mA	3150Lm	90%
	A373-60- 00 -2- N	31,5W	4000K	700mA	3750Lm	90%

LED | 220 V~ | 240 V~ | CE | IP20 | CRI>90 | L80B10 >60.000h | MacAdam Step 3 | OPTIONS* | CONNEC | INCL | 50 X 652 | 38°

00	*OPTIONS
1	No DIM
2	DIM Push
3	DIM 1-10V
4	DIM DALI

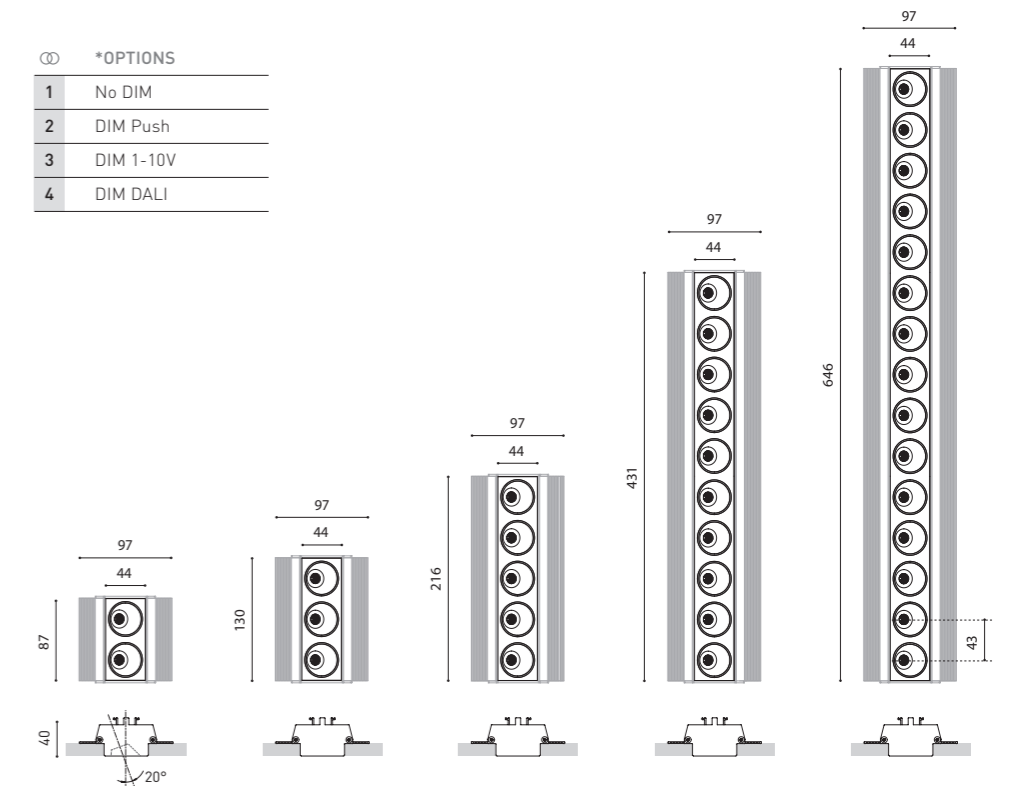

COLOUR | N ■ RAL 9005 | MATERIAL | AL | ABS+PC |

RECOMMENDED FOR INSTALLATIONS WHERE THE PROFILE CAN BE INSTALLED BEFORE THE FALSE PLASTERBOARD CEILING (THICKNESS 12,5mm.)





BLACK FOSTER ASYMMETRIC CUSTOM

		P	CCT	I	Flux	LOR	L
BLACK FOSTER ASYMMETRIC Custom 2	A372-20-00- N	4,2W	2700K	700mA	380Lm	90%	87mm
	A372-20-01- N	4,2W	3000K	700mA	420Lm	90%	87mm
	A372-20-02- N	4,2W	4000K	700mA	500Lm	90%	87mm
BLACK FOSTER ASYMMETRIC Custom 3	A372-30-00- N	6,3W	2700K	700mA	570Lm	90%	130mm
	A372-30-01- N	6,3W	3000K	700mA	630Lm	90%	130mm
	A372-30-02- N	6,3W	4000K	700mA	750Lm	90%	130mm
BLACK FOSTER ASYMMETRIC Custom 5	A372-40-00- N	10,5W	2700K	700mA	950Lm	90%	216mm
	A372-40-01- N	10,5W	3000K	700mA	1050Lm	90%	216mm
	A372-40-02- N	10,5W	4000K	700mA	1250Lm	90%	216mm
BLACK FOSTER ASYMMETRIC Custom 10	A372-50-00- N	21W	2700K	700mA	1900Lm	90%	431mm
	A372-50-01- N	21W	3000K	700mA	2100Lm	90%	431mm
	A372-50-02- N	21W	4000K	700mA	2500Lm	90%	431mm
BLACK FOSTER ASYMMETRIC Custom 15	A372-60-00- N	31,5W	2700K	700mA	2850Lm	90%	646mm
	A372-60-01- N	31,5W	3000K	700mA	3150Lm	90%	646mm
	A372-60-02- N	31,5W	4000K	700mA	3750Lm	90%	646mm

LED | CE | III | IP20 | CRI>90 | L80B10 >60.000h

MacAdam Step 3 | OPTIONS | EXCL | 38°

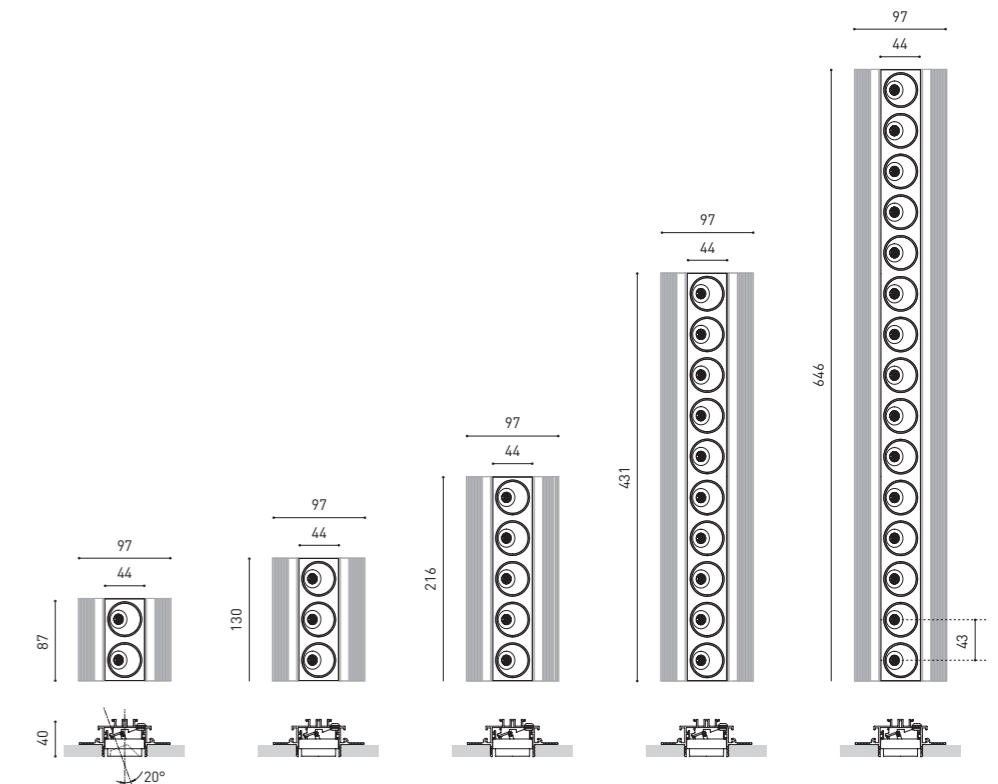

COLOUR | N ■ RAL 9005 | MATERIAL | AL | ABS+PC

PLASTERBOARD CEILING, MANDATORY THICKNESS 12,5mm. RECOMMENDED FOR INSTALLATIONS WHERE THE PROFILE CAN BE INSTALLED BEFORE THE FALSE PLASTERBOARD CEILING.

» PLEASE CONSULT

ART MODULAR

Auf Anfrage sind drei Versionen von *Art Modular* (mit 3, 4 und 5 Lichtpunkten im gleichen Abstand) erhältlich. Die mittleren Lichtpunkte lassen sich als *Direct & Indirect* Leuchten konfigurieren.



BRASSA DE MAR
RICE CLUB



reddot design award
winner 2019



archiproducts
DESIGN AWARDS
WINNER 2019



FX
INTERNATIONAL INTERIOR
DESIGN AWARDS
SHORTLIST
2019



PREMIO
ADCV 2019
PLATA

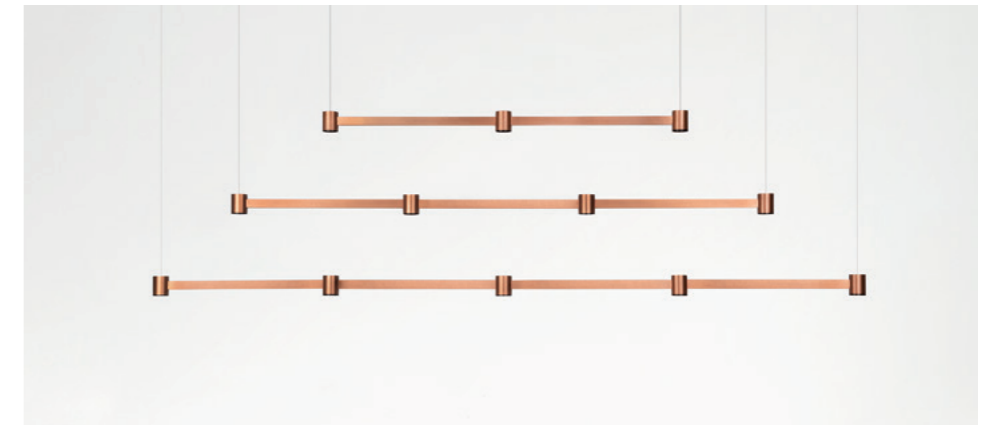

		P	CCT	I	Flux	LOR
ART Modular 3	WT NT BC BG	6,3W	2700K	700mA	570Lm	93%
	WT NT BC BG	6,3W	3000K	700mA	630Lm	93%
DALI*	WT NT BC BG	6,3W	2700K	700mA	570Lm	93%
	WT NT BC BG	6,3W	3000K	700mA	630Lm	93%
ART Modular 4	WT NT BC BG	8,4W	2700K	700mA	760Lm	93%
	WT NT BC BG	8,4W	3000K	700mA	840Lm	93%
DALI*	WT NT BC BG	8,4W	2700K	700mA	760Lm	93%
	WT NT BC BG	8,4W	3000K	700mA	840Lm	93%
ART Modular 5	WT NT BC BG	10,5W	2700K	700mA	950Lm	93%
	WT NT BC BG	10,5W	3000K	700mA	1050Lm	93%
DALI*	WT NT BC BG	10,5W	2700K	700mA	950Lm	93%
	WT NT BC BG	10,5W	3000K	700mA	1050Lm	93%

220 V~ | IP20 | CRI>90 | L80B10 >60.000h

 MacAdam Step 3
 INCL
 2 X Ø50
 UGR <19
 35°
 35°

FINISHING**	Lamp	Base
	WT <input type="checkbox"/>	WT <input type="checkbox"/>
	NT <input type="checkbox"/>	NT <input type="checkbox"/>
	BC <input type="checkbox"/>	WT <input type="checkbox"/>
	BG <input type="checkbox"/>	WT <input type="checkbox"/>

COLOUR | WT RAL 9016 | NT RAL 9005 | BC | BG | MATERIAL | BR | ABS+PC |

OTHER CCT | * OTHER DIM OPTIONS | ** OTHER FINISHING COMBINATIONS » PLEASE CONSULT

» PLEASE CONSULT

ART MODULAR. TISCHAUSLEUCHTUNG

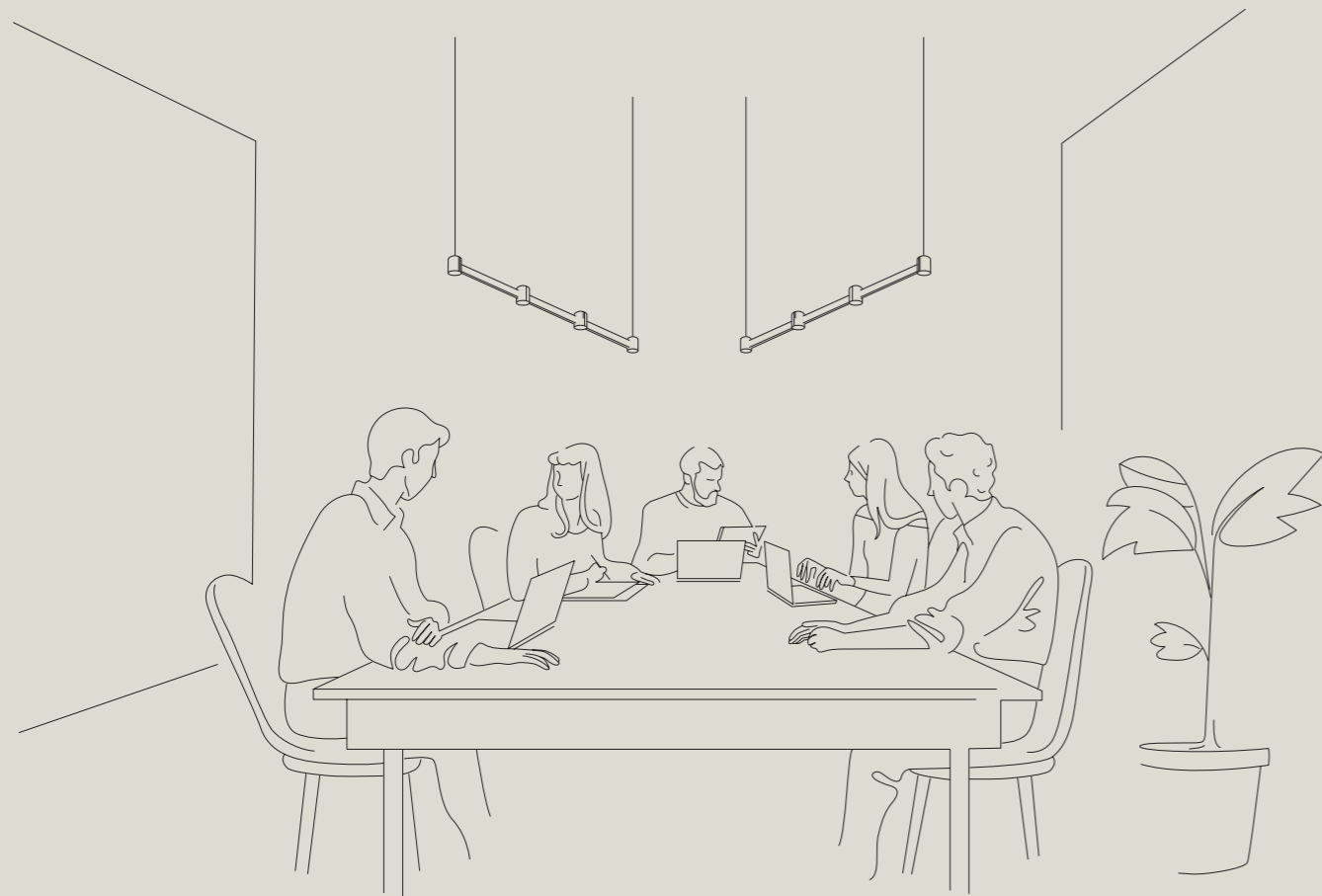

150 x 90 cm.



1520 | 1680 Lm



2280 | 2520 Lm

200 x 90 cm.

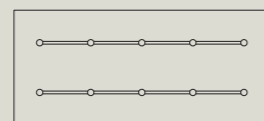

1900 | 2100 Lm

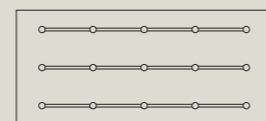

2850 | 3150 Lm

ANREGUNGEN FÜR DIE VERTEILUNG VON ART MODULAR ÜBER TISCHEN MIT STANDARDABMESSUNGEN.

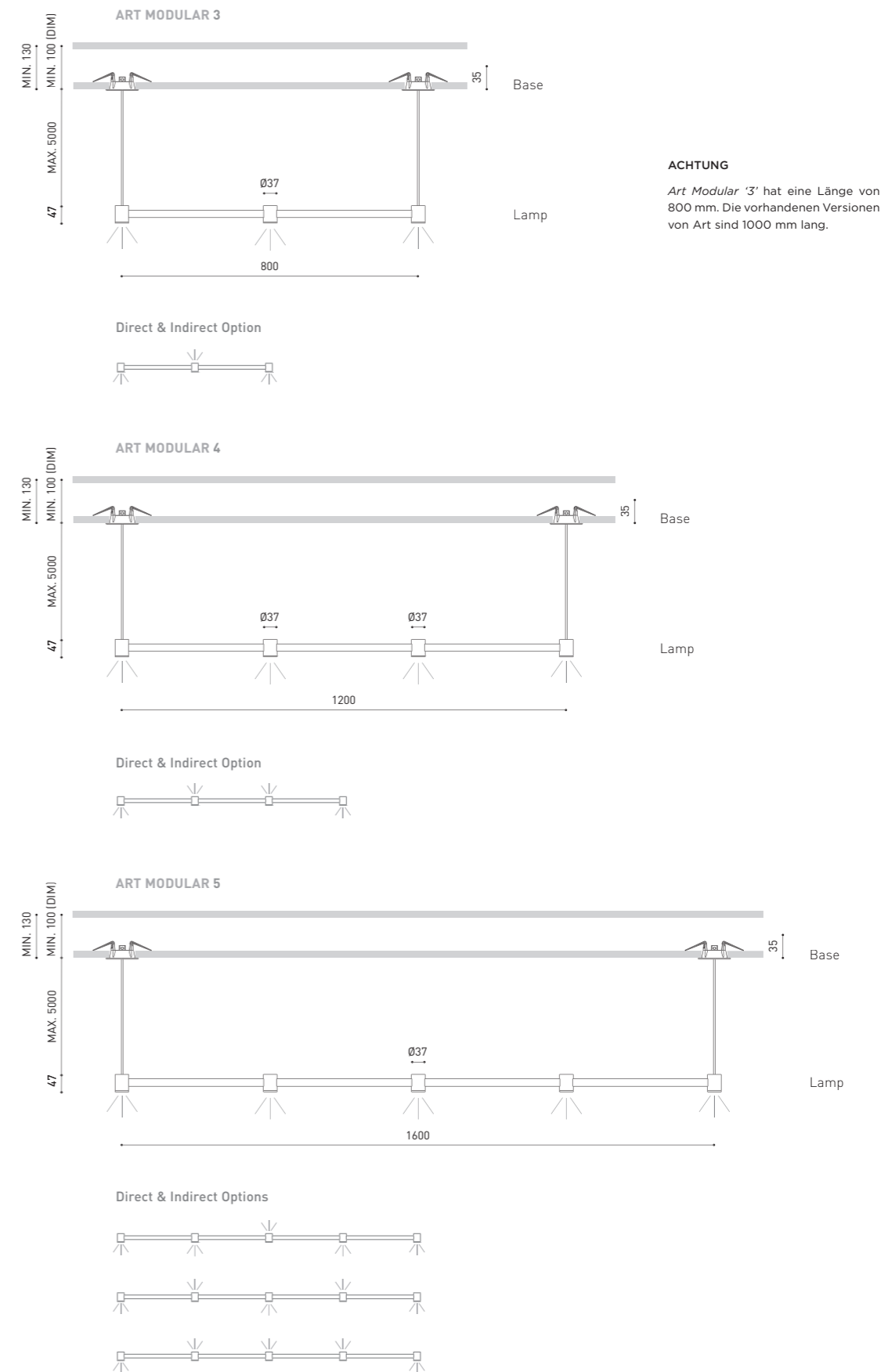



WELLIT

Wellit ist eine ausrichtbare Leuchte in drei Größen für Beleuchtungsanwendungen im Einzelhandel und in der Objektausstattung. Effizienz, technische Leistungen und visuelle Ordnung.



		P	CCT	BEAM	I	Flux	LOR
WELLIT S1	A380-11-11- WT NT	5W	3000K	19°	150mA	700Lm	80%
	A380-11-12- WT NT	5W	4000K	19°	150mA	710Lm	80%
	A380-11-21- WT NT	5W	3000K	26°	150mA	700Lm	89%
	A380-11-22- WT NT	5W	4000K	26°	150mA	710Lm	89%
	A380-11-31- WT NT	5W	3000K	41°	150mA	700Lm	84%
	A380-11-32- WT NT	5W	4000K	41°	150mA	710Lm	84%
WELLIT S2	A380-2- Ⓞ -11- WT NT	7W	3000K	19°	200mA	940Lm	80%
	A380-2- Ⓞ -12- WT NT	7W	4000K	19°	200mA	960Lm	80%
	A380-2- Ⓞ -21- WT NT	7W	3000K	26°	200mA	940Lm	89%
	A380-2- Ⓞ -22- WT NT	7W	4000K	26°	200mA	960Lm	89%
	A380-2- Ⓞ -31- WT NT	7W	3000K	41°	200mA	940Lm	84%
	A380-2- Ⓞ -32- WT NT	7W	4000K	41°	200mA	960Lm	84%



Ⓞ	*OPTIONS
1	No DIM
2	DIM DALI
3	DIM Push

ACCESSORY

WELLIT S Anti-glare Honeycomb Louver ** A380-00-00
NOT SOLD SEPARATELY



WELLIT S

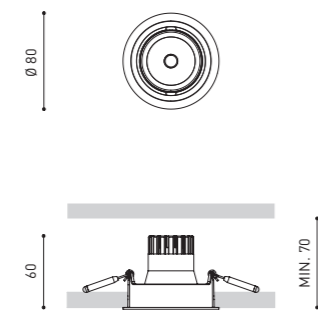

COLOUR | WT □ RAL 9016 | NT ■ RAL 9005 | MATERIAL | AL | PC |

** ACCESSORY AFFECTS THE LIGHTING PARAMETERS



		P	CCT	BEAM	I	Flux	LOR
WELLIT M1	A381-11-11- WT NT	8W	3000K	19°	250mA	1190Lm	81%
	A381-11-12- WT NT	8W	4000K	19°	250mA	1210Lm	81%
	A381-11-21- WT NT	8W	3000K	24°	250mA	1190Lm	83%
	A381-11-22- WT NT	8W	4000K	24°	250mA	1210Lm	83%
	A381-11-31- WT NT	8W	3000K	39°	250mA	1190Lm	83%
	A381-11-32- WT NT	8W	4000K	39°	250mA	1210Lm	83%
WELLIT M2	A381-2- Ⓞ -11- WT NT	15W	3000K	19°	450mA	1970Lm	81%
	A381-2- Ⓞ -12- WT NT	15W	4000K	19°	450mA	2000Lm	81%
	A381-2- Ⓞ -21- WT NT	15W	3000K	24°	450mA	1970Lm	83%
	A381-2- Ⓞ -22- WT NT	15W	4000K	24°	450mA	2000Lm	83%
	A381-2- Ⓞ -31- WT NT	15W	3000K	39°	450mA	1970Lm	83%
	A381-2- Ⓞ -32- WT NT	15W	4000K	39°	450mA	2000Lm	83%

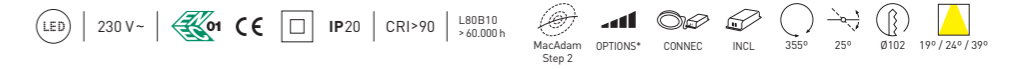

		P	CCT	BEAM	I	Flux	LOR
WELLIT M Tunable White	A381-02-18- WT NT	10,5W	2700-5000K	14°	600mA	1250Lm	83%
	A381-02-28- WT NT	10,5W	2700-5000K	20°	600mA	1250Lm	82%
	A381-02-38- WT NT	10,5W	2700-5000K	34°	600mA	1250Lm	80%



Ⓞ	*OPTIONS
1	No DIM
2	DIM DALI
3	DIM Push

ACCESSORY

WELLIT M Anti-glare Honeycomb Louver *** A381-00-00
NOT SOLD SEPARATELY



WELLIT M

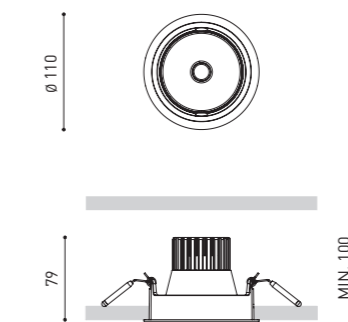

COLOUR | WT □ RAL 9016 | NT ■ RAL 9005 | MATERIAL | AL | PC |

** DIM OPTIONS PLEASE CONSULT | *** ACCESSORY AFFECTS THE LIGHTING PARAMETERS



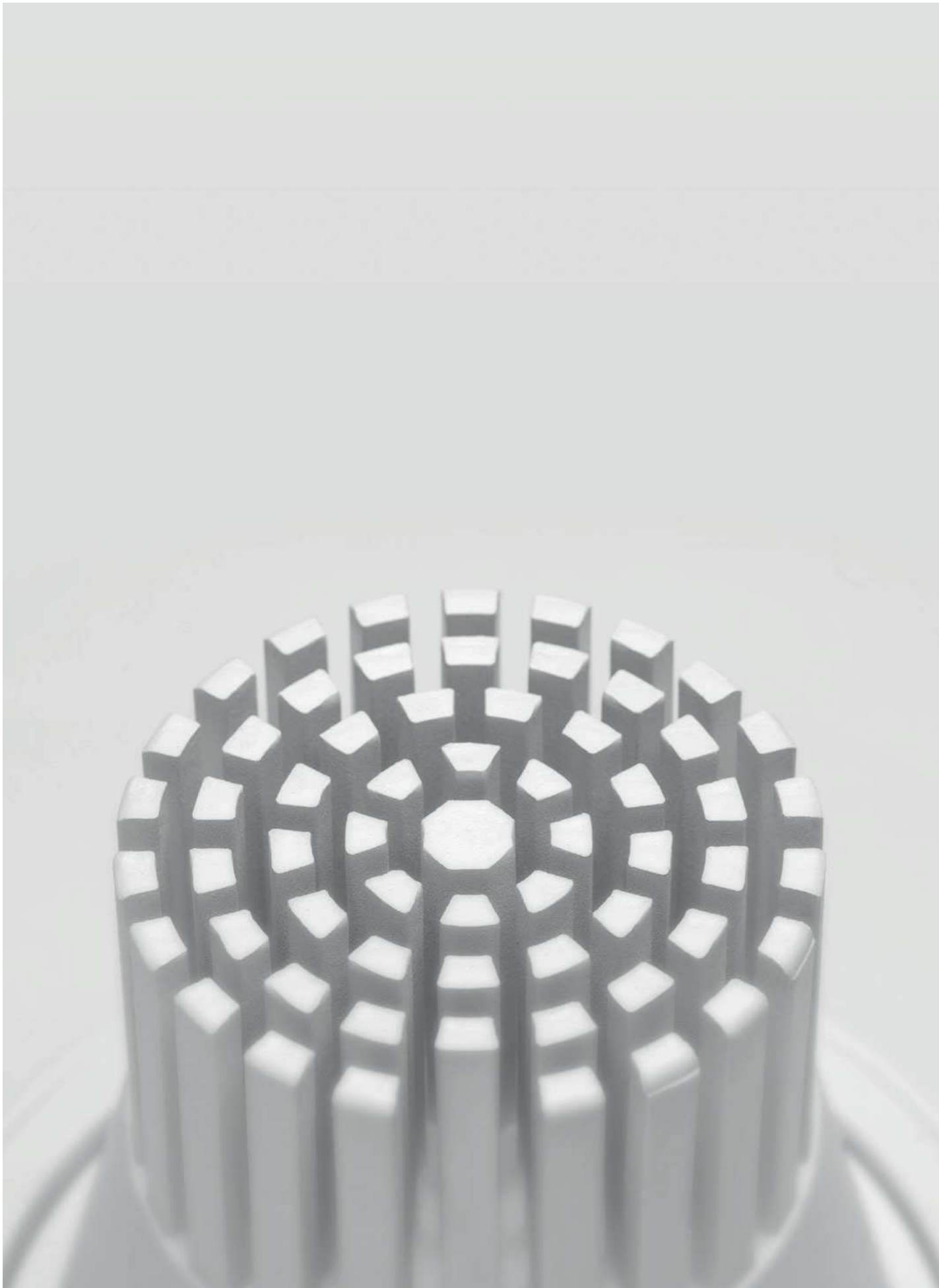

			P	CCT	BEAM	I	Flux	LOR
WELLIT L1	A382 -11-11-	WT NT	15W	3000K	14°	450mA	2060Lm	90%
	A382 -11-12-	WT NT	15W	4000K	14°	450mA	2100Lm	90%
	A382 -11-21-	WT NT	15W	3000K	22°	450mA	2060Lm	91%
	A382 -11-22-	WT NT	15W	4000K	22°	450mA	2100Lm	91%
	A382 -11-31-	WT NT	15W	3000K	42°	450mA	2060Lm	91%
	A382 -11-32-	WT NT	15W	4000K	42°	450mA	2100Lm	91%
WELLIT L2	A382 -2- ∞ -11-	WT NT	25W	3000K	14°	700mA	2960Lm	90%
	A382 -2- ∞ -12-	WT NT	25W	4000K	14°	700mA	3000Lm	90%
	A382 -2- ∞ -21-	WT NT	25W	3000K	22°	700mA	2960Lm	91%
	A382 -2- ∞ -22-	WT NT	25W	4000K	22°	700mA	3000Lm	91%
	A382 -2- ∞ -31-	WT NT	25W	3000K	42°	700mA	2960Lm	91%
	A382 -2- ∞ -32-	WT NT	25W	4000K	42°	700mA	3000Lm	91%



			P	CCT	BEAM	I	Flux	LOR
WELLIT L Tunable White	A382-02-18-	WT NT	21,5W	2700-5000K	12°	600mA	2300Lm	89%
	A382-02-28-	WT NT	21,5W	2700-5000K	21°	600mA	2300Lm	84%
	A382-02-38-	WT NT	21,5W	2700-5000K	43°	600mA	2300Lm	87%



∞	*OPTIONS
1	No DIM
2	DIM DALI
3	DIM Push

ACCESSORY

WELLIT L Anti-glare Honeycomb Louver *** A382-00-00
NOT SOLD SEPARATELY

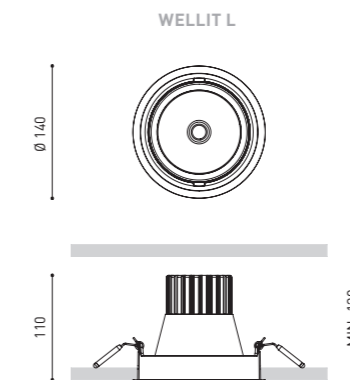
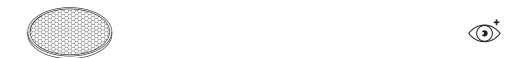

COLOUR | WT □ RAL 9016 | NT ■ RAL 9005 | MATERIAL | AL | PC |

** DIM OPTIONS PLEASE CONSULT | *** ACCESSORY AFFECTS THE LIGHTING PARAMETERS

LEX ECO MINI

Lex Eco Mini ist die kleinere Version von Lex Eco. Die in Bezug auf Proportionen, Leistung und Lichtstrom kohärente Leuchte ist vielseitig einsetzbar und eignet sich sowohl für private Projekte als auch Objektausstattungen.



DESIGN PLUS
2012 AWARD



Premios
Delta'12
Δ
Selección



LEX ECO MINI & LEX ECO MINI BLUE ON

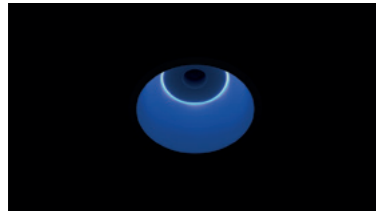

LEX ECO MINI BLUE OFF

			P	CCT	I	Flux	LOR
LEX ECO MINI 1	A378-01-10-	W R G Z WN N	6,5W	2700K	200mA	910Lm	70%
	A378-01-11-	W R G Z WN N	6,5W	3000K	200mA	940Lm	70%
	A378-01-12-	W R G Z WN N	6,5W	4000K	200mA	960Lm	70%
LEX ECO MINI Blue 1	A378-11-10-	W	6,5W	2700K	200mA	910Lm	70%
	A378-11-11-	W	6,5W	3000K	200mA	940Lm	70%
	A378-11-12-	W	6,5W	4000K	200mA	960Lm	70%
LEX ECO MINI 2	A378-02- ① -0-	W R G Z WN N	12W	2700K	350mA	1400Lm	70%
	A378-02- ① -1-	W R G Z WN N	12W	3000K	350mA	1460Lm	70%
	A378-02- ① -2-	W R G Z WN N	12W	4000K	350mA	1480Lm	70%
LEX ECO MINI Blue 2	A378-12- ① -0-	W	12W	2700K	350mA	1400Lm	70%
	A378-12- ① -1-	W	12W	3000K	350mA	1460Lm	70%
	A378-12- ① -2-	W	12W	4000K	350mA	1480Lm	70%

LED | 220-240 V~ | CE | IP20 | CRI>90 | L80B10 >60.000h



①	*OPTIONS
1	No DIM
2	DIM DALI
3	DIM Push

ACCESSORY

LEX ECO High Chromatic LED **

NOT SOLD SEPARATELY



			P	CCT	I	Flux	LOR
LEX ECO MINI Tunable White	A378-00-28-	W R G Z WN N	10,5W	2700-5000K	600mA	1250Lm	70%
LEX ECO MINI Blue Tunable White	A378-10-28-	W	10,5W	2700-5000K	600mA	1250Lm	70%

LED | 220-240 V~ | CE | IP20 | CRI>90 | L80B10 >55.000h



			P	CCT	I	Flux	LOR
LEX ECO MINI DIM to Warm	A378-00-29-	W R G Z WN N	11,5W	1800-3000K	350mA	1265Lm	70%
LEX ECO MINI Blue DIM to Warm	A378-10-29-	W	11,5W	1800-3000K	350mA	1265Lm	70%

LED | 220-240 V~ | CE | IP20 | CRI>90 | L80B10 >55.000h



LEX ECO MINI

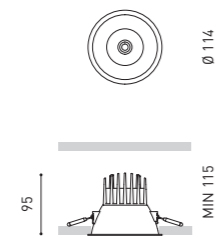

COLOUR | W | R | G | Z | WN | N | MATERIAL | AL | PC

* OTHER DIM OPTIONS PLEASE CONSULT
** ACCESSORY & COLOURS MAY AFFECT THE LIGHTING PARAMETERS



LEX ECO MINI ASYMMETRIC & MINI ASYMMETRIC BLUE ON

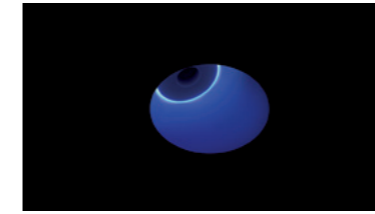

LEX ECO MINI ASYMMETRIC BLUE OFF

			P	CCT	I	Flux	LOR
LEX ECO MINI Asymmetric 1	A379-01-10-	W R G Z WN N	6,5W	2700K	200mA	910Lm	70%
	A379-01-11-	W R G Z WN N	6,5W	3000K	200mA	940Lm	70%
	A379-01-12-	W R G Z WN N	6,5W	4000K	200mA	960Lm	70%
LEX ECO MINI Asymmetric Blue 1	A379-11-10-	W	6,5W	2700K	200mA	910Lm	70%
	A379-11-11-	W	6,5W	3000K	200mA	940Lm	70%
	A379-11-12-	W	6,5W	4000K	200mA	960Lm	70%
LEX ECO MINI Asymmetric 2	A379-02- ① -0-	W R G Z WN N	12W	2700K	350mA	1400Lm	70%
	A379-02- ① -1-	W R G Z WN N	12W	3000K	350mA	1460Lm	70%
	A379-02- ① -2-	W R G Z WN N	12W	4000K	350mA	1480Lm	70%
LEX ECO MINI Asymmetric Blue 2	A379-12- ① -0-	W	12W	2700K	350mA	1400Lm	70%
	A379-12- ① -1-	W	12W	3000K	350mA	1460Lm	70%
	A379-12- ① -2-	W	12W	4000K	350mA	1480Lm	70%

LED | 220-240 V~ | CE | IP20 | CRI>90 | L80B10 >60.000h



①	*OPTIONS
1	No DIM
2	DIM DALI
3	DIM Push

ACCESSORY

LEX ECO High Chromatic LED **

NOT SOLD SEPARATELY



			P	CCT	I	Flux	LOR
LEX ECO MINI Asymmetric Tunable White	A379-00-28-	W R G Z WN N	10,5W	2700-5000K	600mA	1250Lm	70%
LEX ECO MINI Asymmetric Blue Tunable White	A379-10-28-	W	10,5W	2700-5000K	600mA	1250Lm	70%

LED | 220-240 V~ | CE | IP20 | CRI>90 | L80B10 >55.000h



			P	CCT	I	Flux	LOR
LEX ECO MINI Asymmetric DIM to Warm	A379-00-29-	W R G Z WN N	11,5W	1800-3000K	350mA	1265Lm	70%
LEX ECO MINI Asymmetric Blue DIM to Warm	A379-10-29-	W	11,5W	1800-3000K	350mA	1265Lm	70%

LED | 220-240 V~ | CE | IP20 | CRI>90 | L80B10 >55.000h



LEX ECO MINI ASYMMETRIC

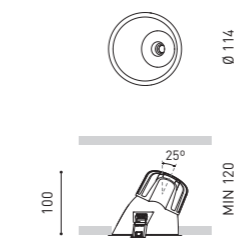

COLOUR | W | R | G | Z | WN | N | MATERIAL | AL | PC

* OTHER DIM OPTIONS PLEASE CONSULT
** ACCESSORY & COLOURS MAY AFFECT THE LIGHTING PARAMETERS



STRAM SURFACE MINI

Stram Surface verfügt jetzt über eine Mini-Version für Projekte mit geringerem Beleuchtungsbedarf, um die Größe entsprechend anzupassen.



				P	CCT	I	Flux	LOR
STRAM SURFACE MINI 2	A377-02-10-	WT	NT	7W	2700K	500mA	975Lm	80%
	A377-02-11-	WT	NT	7W	3000K	500mA	1050Lm	80%
	A377-02-12-	WT	NT	7W	4000K	500mA	1075Lm	80%
STRAM SURFACE MINI 3	A377-03-Ⓞ-0-	WT	NT	10W	2700K	700mA	1275Lm	80%
	A377-03-Ⓞ-1-	WT	NT	10W	3000K	700mA	1375Lm	80%
	A377-03-Ⓞ-2-	WT	NT	10W	4000K	700mA	1400Lm	80%

LED | 220-240V~ | CE | IP20 | CRI>90 | L80B10 >60.000h



Ⓞ *OPTIONS

1	No DIM
5	DIM Phase Cut



STRAM SURFACE MINI

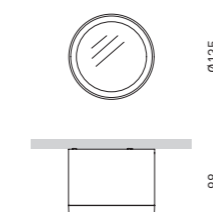

COLOUR | WT □ RAL 9016 | NT ■ RAL 9005 | MATERIAL | AL | PMMA |

PRISMATIC DIFFUSER PLEASE CONSULT

» PLEASE CONSULT

RHINO

Rhino ist ein halb-eingebaute Leuchte für die Bodenbestrahlung mit direkter Lichtausgabe. Von ihrer aus der Wand herausragenden Form her erweckt sie den Eindruck, als werde sie aus der Mauer herausgedrückt.





				P	CCT	I	Flux	LOR
RHINO	A351-00-10-	WT	NT	2W	2700K	700mA	190Lm	90%
	A351-00-11-	WT	NT	2W	3000K	700mA	205Lm	90%

LED | 220-240V~ | CE | IP20 | CRI>90 | L80B10 >60.000h | MacAdam Step 3 | INCL | Ø79 | 35° | 35°

				P	CCT	Flux	LOR
RHINO w/o Driver	A351-00-00-	WT	NT	1 / 2 / 3W	2700K	105 / 190 / 255Lm	90%
	A351-00-01-	WT	NT	1 / 2 / 3W	3000K	115 / 205 / 280Lm	90%

LED | CE | III | IP20 | CRI>90 | L80B10 >60.000h | MacAdam Step 3 | EXCL* | Ø79 | 35° | 35°

*DRIVER OPTIONS

	P	I
0434-00-39	1W	350mA 1 to 12 Rhino
0434-00-40	2W	700mA 1 to 12 Rhino
0434-00-41	3W	1050mA 1 to 11 Rhino
0434-01-23	1W	350mA 1 to 20 Rhino
0434-01-25	2W	700mA 1 to 20 Rhino
0434-01-26	3W	1050mA 1 to 16 Rhino

DRIVER MUST BE PLACED ON REMOTE

ACCESSORY

RHINO Concrete Box Accessory A351-90-00

Only needed when installed in concrete walls. Boxes can be ordered in advance, in order to place the housings in the wall before the final Rhino installation.

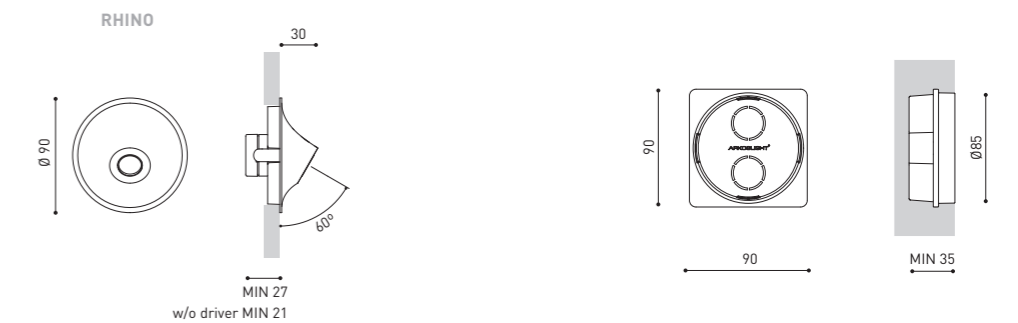

COLOUR | WT □ RAL 9016 | NT ■ RAL 9005 | MATERIAL | AL | PC

» PLEASE CONSULT





		P	CCT	I	Flux	LOR
WALLY	A353-00-10- W N	2,1W	2700K	250mA	260Lm	23%
	A353-00-11- W N	2,1W	3000K	250mA	270Lm	23%
	A353-00-12- W N	2,1W	4000K	250mA	290Lm	23%

LED | 220-240V~ | CE | IP20 | CRI>90 | L80B10 >60.000h |
 MacAdam Step 2 | INCL | 162 X 62 | 73° | 73°

		P	CCT	Flux	LOR
WALLY w/o Driver	A353-00-00- W N	2,1 / 3W	2700K	260 / 350Lm	23%
	A353-00-01- W N	2,1 / 3W	3000K	270 / 360Lm	23%
	A353-00-02- W N	2,1 / 3W	4000K	290 / 390Lm	23%

LED | CE | III | IP20 | CRI>90 | L80B10 >60.000h |
 MacAdam Step 2 | EXCL* | 162 X 62 | 73° | 73°

*DRIVER OPTIONS

	P	I	
 0434-01-30	2,1W	250mA	1 to 3 Wally
0486-04-35	3W	350mA	1 Wally
0434-00-39	3W	350mA	1 to 4 Wally
 0434-01-29	2,1W	250mA	1 to 3 Wally
0434-00-79	3W	350mA	1 to 4 Wally

DRIVER MUST BE PLACED ON REMOTE

ACCESSORY

WALLY Concrete Box Accessory

A353-90-00

Only needed when installed in concrete walls.

Boxes can be ordered in advance, in order to place the housings in the wall before the final Wally installation.



185 X 85

WALLY

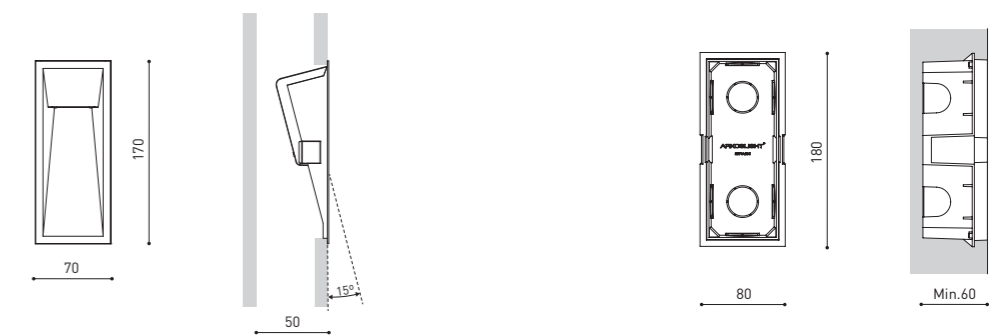

COLOUR | W □ RAL 9016 | N ■ RAL 9005 | MATERIAL | ▭ AL | ○ PC |

COLOURS MAY AFFECT THE LIGHTING PARAMETERS

 » PLEASE CONSULT

WALLY

Wally ist eine Leuchte für die Bodenbestrahlung in geometrischen Formen und architektonischer Ästhetik. Sachlichkeit, formaler Minimalismus und gleichmäßige Beleuchtung.

UP_ DATES

HEREUNDER...



P. 082

New Colors
Neue Metallic-Verarbeitungen.



P. 092

Neue Puck Recessed IP
Mit Schutzart IP54.

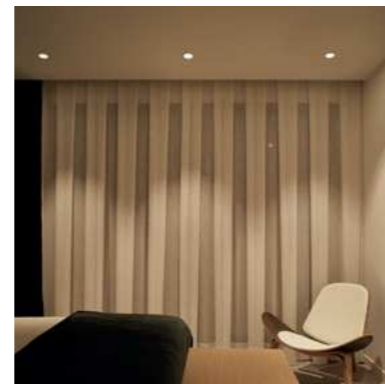

P. 094

Swap, mehr Dimm-Optionen?
Und jetzt für Betondecken geeignet.



P. 096

Rec Mini, jetzt DALI dimmbar
Für eine modernere Steuerung.



P. 098

Warmes Licht
2700K in der Downlight-Reihe.

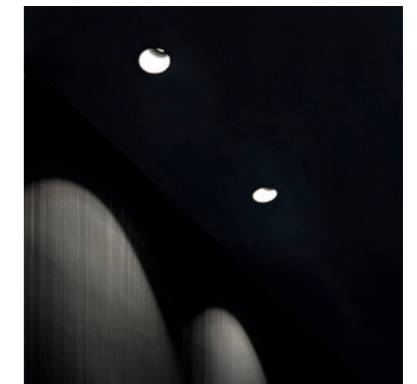

P. 100

Lex Eco noch technischer
Technologie Dim to Warm und Tunable White.



P. 102

Spin
Neue farbige Haltekabel.



P. 103

Salt Mini
Neues Befestigungssystem.



P. 104

Fit 65 1L
Für Einphasenschienen erhältlich.



P. 106

Thor
Neue Proportionen.



P. 108

ARK-Control
Das Licht fest in Ihrer Hand.

NEUE FARBEN

Arkoslight erweitert sein Angebot an Farben und Finish-Optionen um die Verarbeitungen Kupfer metallisiert, Gold metallisiert und Gold gebürstet. Diese neue Farben sorgen für ein Plus an erkennbarer Qualität und vermitteln Robustheit, Luxus, Wärme und Komfort.

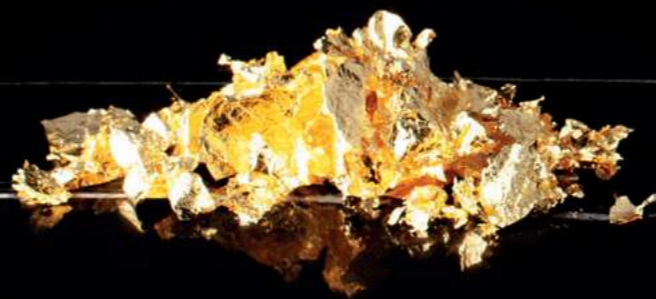



ERHÄLTICH FÜR DIE PRODUKTE



BLACK FOSTER
NMG | NTMG | WTMG



SHOT LIGHT
NMG | WMG*



PUCK
MG | MC



SPIN
MG | MC



ART
BG



HOLLY
MG | MC

New Colors

CODE Generator Example - Black Foster

Reference from *The 2019 Collection*

A319 10 10 XX

NEW FINISHINGS

- NMG:** Black Metallic Gold
- NTMG:** Textured Black Metallic Gold
- WTMG:** Textured White Metallic Gold

NEW FINISHINGS

- BG:** Brushed Gold
- MG:** Metallic Gold
- MC:** Metallic Copper
- NTMG:** Textured Black Metallic Gold
- WTMG:** Textured White Metallic Gold
- NMG:** Black Metallic Gold
- WMG:** White Metallic Gold*

* Not available in trimless version





ASH London (United Kingdom) | Design: Francesc Ribé Studio | Photography: David Zarzoso



Black Foster Recessed
CODE Generator Example

Reference from *The 2019 Collection*

A319 10 10 X

NEW BEZEL
N: Black
WN: White-Black

BLACK FOSTER

WEISSER RAHMEN

Black Foster Recessed, symmetrisch und asymmetrisch, ist jetzt mit weißer Einfassung erhältlich.



NEW
PUCK
RECESSED IP

Puck Recessed ist jetzt mit der Schutzart IP54 gegen das Eindringen von Flüssigkeiten und festen Fremdkörpern geschützt.

Puck Recessed IP
CODE Generator Example

Reference from *The 2019 Collection*

A31X 00 10 WT

PRODUCT
3: PUCK Recessed
4: PUCK Recessed IP54



100% - 3000K



50% - 2900K



10% - 1950K

Swap DIM to WARM
CODE Generator Example

Reference from *The 2019 Collection*

A212 13 X9 W

- DIM OPTIONS**
2: Phase Cut
3: DALI | Push

SWAP

JETZT GEEIGNET FÜR BETONDECKEN UND MIT NEUEN DIMM-OPTIONEN FÜR DIM TO WARM.

Alle Swap Dim to Warm sind nun mit Protokoll für Phasenanschnittdimmer erhältlich. Außerdem kann Swap mit dem neuen Zubehörteil Flat Spring für den Einbau in Betondecken bestellt werden (in den Größen M, L und XL).

Accessory
for concrete ceilings



Swap. (M)

Swap. (L)

Swap. (XL)

SWAP Flat Spring Accessory

A212-00-00

FLAT SPRING NOT PRE-ASSEMBLED.
ISSUED ALONGSIDE THE FIXTURE, IN A SELF-INSTALLATION KIT.

REC MINI

JETZT DALI DIMMBAR

Rec Mini ist jetzt mit einem neuen Steuerprotokoll (DALI) für eine komfortablere Steuerung erhältlich.

Rec Mini
CODE Generator Example

Reference from *The 2019 Collection*

A308 00 X0 WT

DIM OPTIONS

- 1: No DIM
- 2: DALI
- 3: Push



WARMES LICHT

Die Arkoslight Downlight-Reihe wird mit einer neuen Farbtemperatur aktualisiert: 2700K.

PRODUCT	MODEL	P	CCT	I	Flux
DEEP DROP STRAM	1	10,5W	2700K	350mA	1525Lm
STRAM Prismatic MIX	2	15,5W	2700K	500mA	2100Lm
	3	22W	2700K	700mA	2800Lm
FOX	1	10,5W	2700K	350mA	1500Lm
	2	15,5W	2700K	500mA	2050Lm
FOX Mini	2	7W	2700K	500mA	925Lm
	3	10W	2700K	700mA	1200Lm
DEEP Mini DROP Mini STRAM Mini STRAM Mini Prismatic MIX Mini	2	7W	2700K	500mA	975Lm
	3	10W	2700K	700mA	1275Lm

DIM Options: 1: No DIM · 2: DIM Push · 3: DIM 1-10V · 4: DIM DALI

PRODUCT	MODEL	P	CCT	I	Flux
STRAM SURFACE	1	10,5W	2700K	350mA	1525Lm
	2	15,5W	2700K	500mA	2100Lm
	3	22W	2700K	700mA	2800Lm

DIM Options: 1: No DIM · 2: DIM DALI | Push / 1-10V

PRODUCT	MODEL	P	CCT	I	Flux
SALT	3	22W	2700K	700mA	2800Lm

DIM Options: 1: No DIM

PRODUCT	MODEL	P	CCT	I	Flux
SALT Mini	0	10W	2700K	700mA	1300Lm

DIM Options: 1: DIM Phase Cut

Downlights New 2700K
CODE Generator Example - Drop

Reference from *The 2019 Collection*

A193	OX	X0	WT
PRODUCT	MODEL	DIM	

LEX ECO

AKTUALISIERT UND DAMIT
NOCH TECHNISCHER

Lex Eco wird jetzt mit einer neuen Farbtemperatur (2700K) angeboten und enthält die Technologie Dim to Warm und Tunable White.

LEX ECO 2700K

A		C		P	CCT	I	Flux	LOR
0	SYMMETRIC	25		10W	2700K	300mA	1370Lm	70%
1	ASYMMETRIC	26		17W	2700K	500mA	2070Lm	70%
		27		17W	2700K	500mA	2070Lm	70%
		28		17W	2700K	500mA	2070Lm	70%
		29		17W	2700K	500mA	2070Lm	70%
01	LEX ECO	30		24W	2700K	700mA	2690Lm	70%
02	LEX ECO BLUE	31		24W	2700K	700mA	2690Lm	70%
03	LEX ECO 205	32		24W	2700K	700mA	2690Lm	70%
04	LEX ECO 205 BLUE	33		24W	2700K	700mA	2690Lm	70%

OTHER DIM OPTIONS PLEASE CONSULT

LEX ECO New 2700K
CODE Generator Example

Reference from *The 2019 Collection*

A07X XX XX W
A B C

LEX ECO Tunable White & DIM to WARM

A		B		P	CCT	I	Flux	LOR
8	SYMMETRIC	01		21,5W	2700-5000K	600mA	2300Lm	70%
9	ASYMMETRIC	11		21,5W	2700-5000K	600mA	2300Lm	70%
		02		20W	1800-3000K	600mA	2150Lm	70%
		12		20W	1800-3000K	600mA	2150Lm	70%

Lex Eco New Tunable White & DIM to WARM
CODE Generator Example



OTHER DIM OPTIONS PLEASE CONSULT

New references

A36X XX 00 W
A B

New Spin 2700K
CODE Generator Example

Reference from *The 2019 Collection*

A222 02 0X WT

COLOR TEMPERATURE

0: 2700K

1: 3000K

2: 4000K*

* NOT AVAILABLE FOR SPIN 48V TRACK

SPIN

JETZT IN 2700K UND NEUEN
FARBIGEN HALTEKABELN

Spin ist jetzt in warmer Farbtemperatur (2700K) erhältlich. Außerdem ist das Halte-/Stromkabel nicht länger transparent, sondern wird passend zur Verarbeitung der Leuchte in einem eleganten Weiß oder Schwarz geliefert.

Private residence, Valencia (Spain) | Design: Leticia Vila & Vicente Olivares



SALT MINI

NEUES BEFESTIGUNGSSYSTEM

Bei Salt Mini sind die drei Haltekabel neu angeordnet worden, die nun in der Deckendose statt an der Decke verankert werden. Auf diese Weise lässt sich die Leuchte einfacher installieren.



FIT 65 1L

Der Strahler Fit erweitert in seiner Version 65 seine Kompatibilität und ist nun auch für Einphasenschienen erhältlich.



		P	CCT	Beam	I	Flux	LOR
FIT Ø65 1L	A366-01-11- WT NT	10,3W	3000K	18°	300mA	1300Lm	90%
	A366-01-12- WT NT	10,3W	4000K	18°	300mA	1320Lm	90%
	A366-01-21- WT NT	10,3W	3000K	26°	300mA	1300Lm	88%
	A366-01-22- WT NT	10,3W	4000K	26°	300mA	1320Lm	88%
	A366-01-31- WT NT	10,3W	3000K	36°	300mA	1300Lm	84%
	A366-01-32- WT NT	10,3W	4000K	36°	300mA	1320Lm	84%

220 V~ | IP20 | CRI>90 | L80B10 >60.000h

 MacAdam Step 2
 INCL
 TRACK 1L
 355°
 90°
 18°/26°/36°

ACCESSORY

FIT Ø65 Anti-glare Honeycomb Louver ** A356-00-00
NOT SOLD SEPARATELY

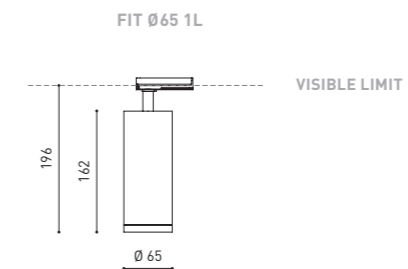

COLOUR | WT RAL 9016 | NT RAL 9005 | MATERIAL | AL | PC |

** ACCESSORY AFFECTS THE LIGHTING PARAMETERS



		P	CCT	I	Flux	LOR
THOR 1	A226-11- ① -1- WT NT	27W	3000K	800mA	3750Lm	90%
	A226-11- ② -2- WT NT	27W	4000K	800mA	3820Lm	90%
THOR 2	A226-21- ① -1- WT NT	36W	3000K	1050mA	4750Lm	90%
	A226-21- ② -2- WT NT	36W	4000K	1050mA	4820Lm	90%
DALI	A226-24- ① -1- WT NT	36W	3000K	1050mA	4750Lm	90%
	A226-24- ② -2- WT NT	36W	4000K	1050mA	4820Lm	90%

| 220 V~ | | | | | | | | | |

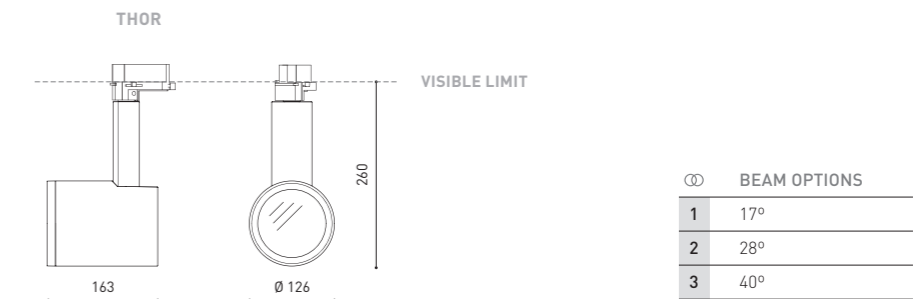

ACCESSORIES

<p>TRACKLIGHT Surface Adapter</p> <p>0000-55-43- W </p> <p>0000-55-39- N </p> <p>NO DIM</p>	<p>THOR Anti-glare Screen*</p> <p>0802-00-00- WT </p> <p>0802-00-00- NT </p>
<p>TRACKLIGHT Recessed Adapter</p> <p>0000-55-44- W </p> <p>0000-55-40- N </p> <p>NO DIM ①105</p>	<p>THOR Anti-glare Honeycomb Louver*</p> <p>0802-02-00</p> <p>NOT SOLD SEPARATELY</p>
<p>THOR High Chromatic Led*</p> <p>NOT SOLD SEPARATELY</p>	<p>THOR Elliptical Refractor*</p> <p>0802-04-00</p> <p>NOT SOLD SEPARATELY</p>
	<p>THOR Beam Mixer Diffuser*</p> <p>0805-03-00</p> <p>NOT SOLD SEPARATELY</p>

COLOUR | WT □ RAL 9016 | NT ■ RAL 9005 | MATERIAL | AL | GL-TRANS | OTHER CCT PLEASE CONSULT | * AFFECTS THE LIGHTING PARAMETERS » PLEASE CONSULT

THOR

NEUE PROPORTIONEN

Bei Thor wird dank der Optimierung des Treibers der Arm um 30 mm verkürzt. Harmonischere Proportionen für den leistungsstärksten Strahler von Arkoslight.



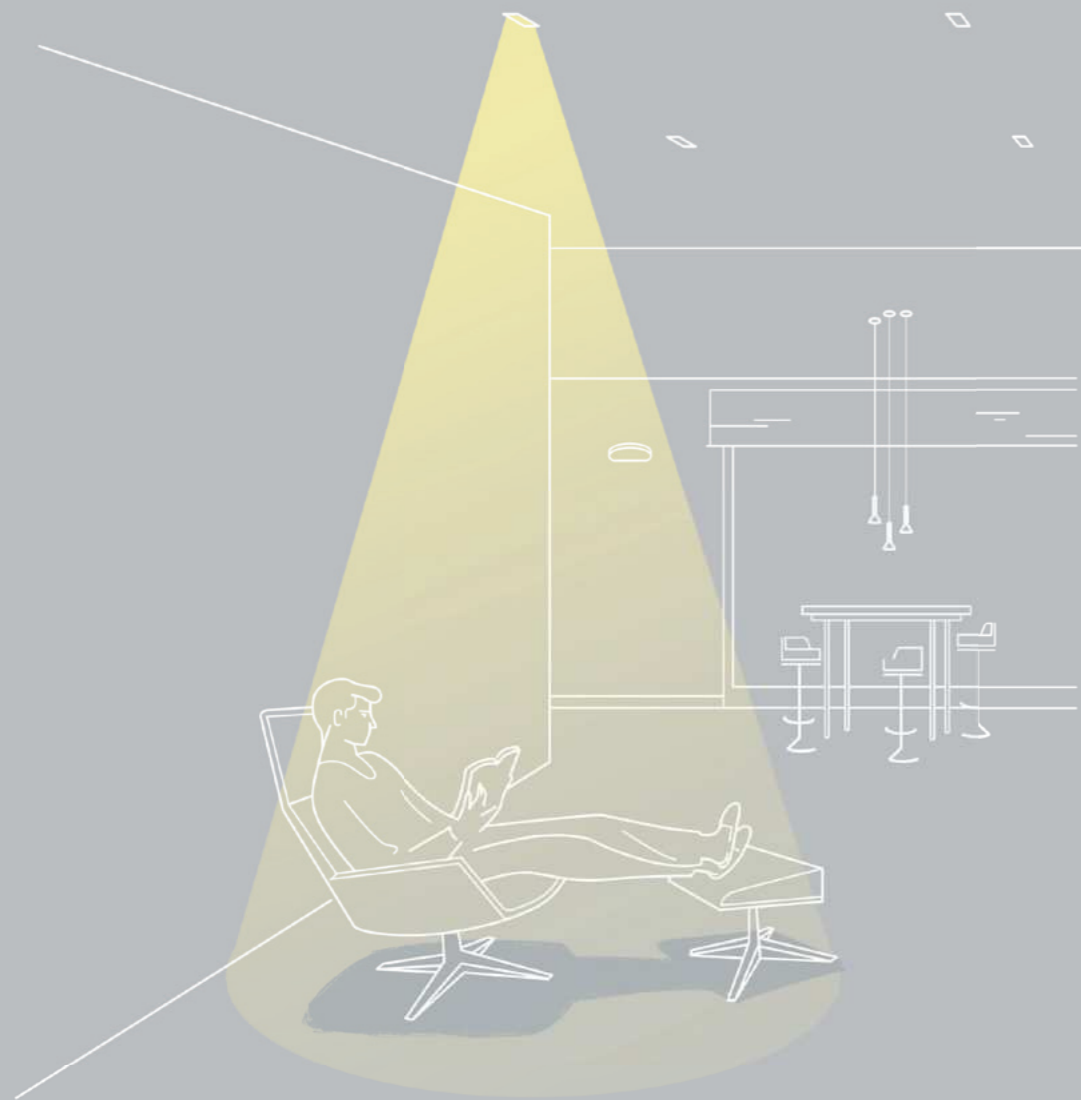

NEW

ARK-CONTROL SYSTEM

ARK-Control ist ein drahtloses System, mit dem wir mit unserer Installation interagieren und ein wesentlich vielseitigeres und maßgeschneidertes System gestalten können.

Dank der absoluten Kompatibilität mit den herkömmlichen Systemen zum Ein- und Ausschalten lassen sich auf unsere Routinen oder Raumaufteilungen zugeschnittene automatische Abläufe programmieren.

EINZEL-/GRUPPENSTEUERUNG

Ermöglicht die Einzel- oder Gruppensteuerung von Leuchten, damit diese zusammen schnell und einfach Beleuchtungsfunktionen erfüllen.

SZENEN

Gestalten Sie Lichtszenen für unterschiedliche Anlässe: Arbeit, Filmabend, romantische Stimmung...

Je nach Anlass und Konfiguration werden die Leuchten so gesteuert, dass sie das gewünschte Ambiente wiedergeben.

ANIMATIONEN

Gestalten Sie dynamische Stimmungen durch wechselnde Szenen.

PROGRAMMIERUNG NACH UHRZEITEN

Legen Sie gemäß Ihrem persönlichen Stundenplan eine Routine fest, damit das Licht mit dem Raum interagiert.

BELEUCHTUNG MIT 'SMART'-TECHNOLOGIE

ARK-Control nutzt das technische Potential unserer Leuchten, was insbesondere für die Modelle mit der Technologie *Dim To Warm* und *Tunable White* gilt. Das System ermöglicht die Einstellung der korrekten Intensität und Farbtemperatur des Lichts, um sich in Innenräumen den Anforderungen der Menschen anzupassen. Dank der aktiven Rolle des Lichts lässt sich der Raum in eine dynamische Umgebung verwandeln. Dies alles ganz einfach mit unserem Gerät.

SUNRISE & SUNSET SCHEDULE

ARK-Control analysiert die Zeit von Sonnenaufgang und -untergang entsprechend unserem Standort, den GPS ermittelt-, um eine optimale Lichtregelung über den gesamten Zeitraum zu erreichen.

Diese Funktionalität kann mit Tageslichtsensoren kombiniert werden, um das Sonnenlicht zu nutzen und Energie zu sparen.

OK ARKOSLIGHT, TURN ON THE LIGHT!

Control the luminaries with voice orders using virtual assistants such as Alexa or others.

0434-00-31

Ark-Control 1-10V / DALI

Gerät zur drahtlosen Steuerung von LED-Netzteilen mit Dimmschnittstelle 0-10V, 1-10V oder DALI.



0434-00-34

Ark-Control Dimmer

Bluetooth-Regler für durch Phasenanschnitt regelbare LED-Netzteile.



0433-10-25

Ark-Control Passive

Bluetooth-Controller für DALI-Netze im Broadcast-Modus - Steuerung aller Leuchten gleichzeitig. Ohne eigenes DALI-Netzteil. Wird darum direkt über eine DALI-Busleitung mit Strom versorgt.



0434-00-35 | W | N |

Ark-Control User Interface W | N

Drahtlose Benutzerschnittstelle, die über die App Casambi konfiguriert werden kann. Je nach der vom Benutzer gewünschten Konfiguration können die vier zuweisbaren Knöpfe eine Szene, eine Animation, eine Leuchte oder eine Leuchtengruppierung steuern.



0434-01-07

Ark-Control Sensor

Drahtloser Sensor zur Steuerung in Abhängigkeit von Umgebungslicht und Präsenzmelder.



0434-01-08

Ark-Control Driver

60W-Netzteil mit integrierter drahtloser Bluetooth-Schnittstelle.



0434-01-39

Ark control Zigbee driver

60-W-Netzteil mit ZigBee-Interface.



0434-01-38

Ark control Zigbee interface

ZigBee-Controller für Leuchten mit DALI-Netzteilen. Steuerung von bis zu 8 DALI-Leuchten. Kompatibel mit *Tunable White*.



0434-01-31 | N |

Adapter for Wireless Control. Double Compatibility

ARK-Control Ready:

Kompatibel mit Casambi-Technologie. Steuert bis zu 4 Leuchtengruppierungen (an ein und derselben Schiene).

A.A.G. Stucchi LightControl Ready:

Kompatibel mit der App A.A.G. Stucchi LightControl. Steuert bis zu 64 Leuchten einzeln (an ein und derselben Schiene).

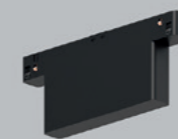

0434-01-32 | N |

Adapter for Wireless Control Stucchi

Kompatibel mit der App A.A.G. Stucchi LightControl. Steuert bis zu 64 Leuchten einzeln (an ein und derselben Schiene).

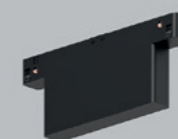

ARKOSLIGHT®

Calle N · Pol. Ind. EL OLIVERAL
46394 Ribarroja del Turia · Valencia (Spain)
Tel. +34 961 667 207 · Fax +34 961 667 054
info@arkoslight.com · www.arkoslight.com
France: +33 182 885 200 · Italia: +39 02 9475 0007
Deutschland: +49 22 182 829 313



LIGHT&LIFE
— DESDE 1984 —