

PRICE LIST
LISTA DE PRECIOS
2023



Euros VAT. excluded
Euros IVA no incluido

AWARDS AND RECOGNITIONS / PREMIOS Y RECONOCIMIENTOS

COMPANY AWARDS / PREMIOS A LA EMPRESA

1989	PREMIO NACIONAL DE DISEÑO
1990	EUROPEAN COMMUNITY DESIGN PRIZE
2022	DELTA CAREER AWARD

AWARDS / PREMIOS

1974	DELTA AWARD	ESTANTERÍA HIALINA , Anna Bohigas, Lluís Clotet y Oscar Tusquets
1975	GOLDEN DELTA AWARD	ESPEJO LUMINOSO , Mireia Riera
1976	GOLDEN DELTA AWARD	MESA SEVILLA , Pep Bonet y Cristian Cirici
1979	GOLDEN DELTA AWARD	CAMPANA DIÁFANA , Lluís Clotet y Oscar Tusquets
1980	GOLDEN AND OPINION DELTA AWARD	ESTANTERÍA HYPÓSTILA , Lluís Clotet y Oscar Tusquets
1984	SILVER DELTA AWARD	CENICERO SURCO , Juancho de Mendoza y Maite Oriol
1986	SILVER DELTA AWARD	CATENARIA , Pep Bonet
1986	GOLDEN DELTA AWARD 25 YEARS	ESTANTERÍA HIALINA , Lluís Clotet y Oscar Tusquets
1988	GOLDEN DELTA AWARD	SILLÓN COQUETA , Pete Sans
1991	SILVER DELTA AWARD	PARAGÜERO BARCELONÉS , Pep Bonet
1997	SILVER DELTA AWARD	CAMPANA EXTRACTORA DIÁFANA , Lluís Clotet y Oscar Tusquets
2007	GOLDEN DELTA AWARD	LOS BANCOS SUIZOS , Alfredo Häberli
2009	SILVER DELTA AWARD	TABLE B , Konstantin Grcic
2011	SILVER DELTA AWARD	CHAIR B , Konstantin Grcic
2011	RED DOT DESIGN AWARD	TABLE B , Konstantin Grcic
2013	SILVER DELTA AWARD	BENCH B , Konstantin Grcic
2014	SILVER DELTA AWARD	COLECCIÓN GARDENIAS , Jaime Hayon
2017	ECODISEÑO AWARD	REMIX COLLECTION , Curro Claret y Ramón Úbeda
2019	INTERIOR NYCDESIGN AWARD	BUTACA GRASSO , Stephen Burks
2020	GOLDEN DELTA AWARD	BUTACA GRASSO , Stephen Burks
2020	ARCHIPRODUCTS DESIGN AWARD	EXPLORER SIDE TABLE , Jaime Hayon

ADI-FAD AWARDS SELECTION / PREMIOS ADI-FAD

1971	LÁMPARA JIPI
1972	LÁMPARA FLAMINGO, LÁMPARA CUC, VELÓN, NEGRO
1974	LÁMPARA PIA, SILLA SEVILLA, LÁMPARA SYLVESTRE, CAMPANA CAMPANAE, HARPO, SCALA DE MILAN, BANCO CATALANO
1975	LÁMPARA POSTAL PIRAMIDE, BUZONES SARDINEL, LÁMPARA GALIA
1976	SILLA MOZART, CARRITO VERSÁTIL
1977	SERIE RACOR, EL GERRO
1978	HERRAJES MODERNISTAS, LÁMPARA TALLO, MESA CASINO, TAULETA
1979	CENICERO HOMENAJE A BARRAQUER, SERIE JARDÍN, PERCHA TECLA, LA FIGURA GALA
1980	GALÁN DE BAÑO
1981	CHAISE LONGUE DU CHAMP, GUARDADISCOS
1984	RELOJ SOLAR, BUZÓN 3/4/5, MUEBLE ROBERTO, ESPEJO GALANTE, PAPELERA ESCUADRA, TABURETE DUPLEX-SINGLE, TIRADOR MODULAR
1986	LÁMPARA BIB-LUZ LIBRO, LÁMPARA VAGUE STELLE, MESA MESITA, FAROLA Y APLIQUE TATI, MESA PHIDEA, LÁMPARA ARAÑA, LÁMPARA BIB-LUZ SEMIESFERA
1988	ESTANTERÍA CORNISA, MESA METARRÍGIDA, ALFOMBRA LUNA, APLIQUE TEA, SILLA METALÁSTICA, MESA ORBITA, SERIE ZORAIDA, ALFOMBRA TIERRA, ALFOMBRA LOTZ, ESTANTERÍA TALAYA, MESA COMITÉ, ALFOMBRA PXOCK
1990	MESA ARÁCNIDA, LÁMPARA MITRAL, LÁMPARA BIB LUZ DOBLE
1992	ESPEJO MIRALLMAR, CENICERO ZENIO, ESTANTERÍA AUTÓNOMA, TABURETE TUT ANK AHMON, MESA TORRE LLIMONA, LÁMPARA CÁSTOR, IMHOTEP, ATRIL DE ALEJANDRÍA, SILLÓN LEDA
1993	LÁMPARA PÓLUX, SILLA BIB, SERIE RACOR II
1995	ESTANTERÍA PHANTASMA, CENICERO PAPELERA PALAU, SERIE E.T.
1997	ALFOMBRA VÉRTIGO, LÁMPARA SKYLINE, MESA CHARLES, PARAGÜERO PLEC, LÁMPARA PLOMADA
2001	MESA ROMANA PREMIO DESIGN FOR THE WORLD
2003	BANCO BDLOVE
2005	MAILBOX MAIL ME
2007	SHOWTIME COLLECTION
2009	CABINET TOUT VA BIEN
2012	MESA GAULINO, FREE PORT
2014	CHANDLO
2016	DREAMS CABINET, FANG COLLECTION
2017	REMIX COLLECTION
2018	DALIA CABINET

INDEX

7 BD PRODUCT FINISHES / ACABADOS DE PRODUCTO

STORAGE AND SHELVING / CONTENEDORES Y ESTANTERÍAS

- 20 DREAMS CABINET - Cristian Zuzunaga
- 22 EXPLORER CABINET - Jaime Hayon
- 25 TOUT VA BIEN - Antoine et Manuel
- 28 MULTILEG SHOWTIME CABINET - Jaime Hayon
- 34 SHANTY - Doshi Levien
- 35 PERISTYLO shelving / estantería - Oscar Tusquets
- 38 HYPÓSTILA shelving / estantería - Lluís Clotet & Oscar Tusquets
- 42 ESBELTA shelving / estantería - Lluís Clotet & Oscar Tusquets
- 42 HIALINA - Lluís Clotet & Oscar Tusquets
- 43 CORNISA shelving / estantería - Lluís Clotet & Oscar Tusquets

TABLES / MESAS

- 44 GAULINO - Oscar Tusquets
- 45 CARLINAS - Oscar Tusquets
- 47 TABLE B - Konstantin Grcic
- 60 EXPLORER DINING TABLE - Jaime Hayon
- 62 MULTILEG LOW TABLE - Jaime Hayon
- 63 MONKEY SIDE TABLE - Jaime Hayon
- 64 SIDE TABLE B - Konstantin Grcic
- 64 2001 SIDE TABLES - Otto Canalda & Ramón Úbeda
- 64 EXPLORER SIDE TABLE - Jaime Hayon

ARMCHAIRS / BUTACAS

- 66 DINO - Jaime Hayon
- 67 GRASSO - Stephen Burks
- 68 ODYSSEY - Eugeni Quitllet
- 70 LOUNGER - Jaime Hayon
- 71 LOW LOUNGER - Jaime Hayon
- 72 GARDENIAS COLLECTION OUTDOOR- Jaime Hayon
- 73 GARDENIAS COLLECTION INDOOR- Jaime Hayon
- 74 LITTLE COUTURE - Färg & Blanche
- 74 COUTURE - Färg & Blanche
- 75 DALILIPS - Salvador Dalí
- 75 GAULINO EASY CHAIR - Oscar Tusquets

CHAIRS AND STOOLS / SILLAS Y TABURETES

- 76 GAULINETTA chair / *silla* - Oscar Tusquets
- 76 GAULINO chair / *silla* - Oscar Tusquets
- 77 GAULINO stool / *taburete* - Oscar Tusquets
- 77 CHAIR B chair / *silla* - Konstantin Grcic
- 78 MINIVARIUS chair / *silla* - Oscar Tusquets
- 78 VARIUS chair / *silla* - Oscar Tusquets
- 79 SHOWTIME & SHOWTIME NUDE chair / *silla* - Jaime Hayon
- 92 JAMAICA stool / *taburete* - Pepe Cortés
- 93 BINARIA stool / *taburete* - Jordi Badía & Otto Canalda
- 93 GRASSO stool / *taburete* - Stephen Burks

ACCESSORIES / ACCESORIOS

- 94 MIRALLMAR mirror / *espejo* - Eduard Samsó
- 94 SHOWTIME mirror / *espejo* - Jaime Hayon
- 95 KING KONG mirror / *espejo* - Jaime Hayon
- 95 SHIVA flower vase / *florero* - Ettore Sottsass Jr.
- 96 SHOWTIME vases / *jarrones* - Jaime Hayon
- 97 HAPPY SUSTO vases / *jarrones* - Jaime Hayon
- 97 HAPPY YETI vases / *jarrones* - Jaime Hayon
- 98 EXPLORER vases / *jarrones* - Jaime Hayon
- 98 GARDENIAS vases / *jarrones* - Jaime Hayon
- 99 MONKEY coat stand / *colgador* - Jaime Hayon
- 99 CASA DE FAMILIA bottle / *botella* - Josep Maria Jujol
- 100 HAPPY HOUR trolleys / *carritos* - Alfredo Häberli
- 100 PLEC umbrella stand / *paragüero* - Isabel Gamero & Jordi Pérez
- 101 ALBERTO candleholder / *candelabro* - Oscar Tusquets
- 101 3-4-5 mailbox / *buzón* - Lluís Clotet & Oscar Tusquets

LIGHTING / ILUMINACIÓN

- 102 FLAMINGO - Álvaro Siza Vieira
- 102 OLVIDADA - Pepe Cortés

OUTDOOR & PUBLIC SEATING / EXTERIOR Y ASIENTOS PÚBLICOS

- 104 CATALANO & PERFORANO bench / *banco* - Lluís Clotet & Oscar Tusquets
- 106 EL POETA bench / *banco* - Alfredo Häberli
- 106 BENCH B - Konstantin Grcic









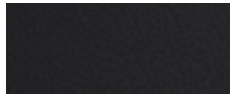

ART EDITIONS

- 108 **CALVET** hanger / *colgador* - Antoni Gaudí
- 108 **CALVET** stool / *taburete* - Antoni Gaudí
- 109 **CALVET** armchair / *sillón* - Antoni Gaudí
- 109 **CALVET** chair / *silla* - Antoni Gaudí
- 109 **CALVET** mirror / *espejo* - Antoni Gaudí
- 110 **CALVET** bench / *banco* - Antoni Gaudí
- 110 **BATLLÓ** bench / *banco* - Antoni Gaudí
- 110 **BATLLÓ** chair / *silla* - Antoni Gaudí
- 111 **GAUDÍ** door knobs / *herrajes* - Antoni Gaudí
- 111 **GAUDÍ** handles display / *expositor* - Antoni Gaudí
- 112 **PORTLLIGAT** sunbed / *tumbona* - Salvador Dalí
- 112 **VIS-À-VIS DE GALA** - Salvador Dalí
- 113 **LEDA** armchair / *butaca* - Salvador Dalí
- 113 **LEDA** low table / *mesa baja* - Salvador Dalí
- 114 **BRACELLI** lamp / *lámpara* - Salvador Dalí
- 114 **MULETAS** lamp / *lámpara* - Salvador Dalí
- 114 **CAJONES** lamp / *lámpara* - Salvador Dalí
- 114 **RINOCERÓNTICO** knob / *tirador* - Salvador Dalí
- 115 **XAI** - Salvador Dalí
- 115 **INVISIBLE PERSONAGE / PERSONAJE INVISIBLE** - Salvador Dalí
- 116 **CRISTALLO** - Alessandro Mendini
- 116 **TIGER ART GAULINO** - Oscar Tusquets
- 116 **METTSASS** - Ettore Sottsass Jr.
- 117 **DOOBIDE** - Alfredo Häberli
- 117 **REmix Vol. 2 CABINET** - Ramón Úbeda
- 117 **TALISMAN CABINET** - Maysam Al Nasser

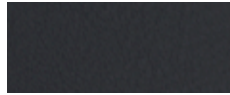
- 118 **GENERAL CONDITIONS OF SALE / CONDICIONES GENERALES DE VENTA**

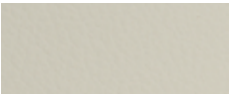





BD FINISHES / ACABADOS

LEATHER / PIELES

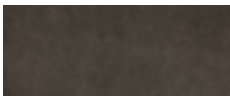
REF	NAME / TIPOLOGÍA	DESCRIPTION / DESCRIPCIÓN	COLOURS / COLORES	
F	Florida (recommended for contract use / recomendado para uso contract)	Composition / Composición Raw hide leather (corrected grain) through dyeing aniline / Piel de vacuno (flor corregida) tintada en anilina Tear resistance / Resistencia al desgarro >20N (UNI EN ISO 3377-1) Crack resistance / Resistencia a la flexión 50.000 Cycles / Ciclos (UNI EN ISO 5402) Dry rub fastness / Solidez del color a frote seco: 1.000 Cycles / Ciclos Vol. >4 Grey scale / Escala de grises (UNI EN ISO 11640) Light fastness / Solidez del color a la luz Vol. >6 Blue scale / Escala de azules (UNI EN ISO 105-B02) Fire test / Tratamiento ignifugo: BS5852 CRib5 (optional / opcional) UNI EN 1021-1 UNI EN 1021-2 NFPA 260/UFAC California TB 117 Section E	Black / Negro – F10 	Camel – F15 
			Dark orange / Teja – F20 	Yellow / Amarillo – F25 
			Charcoal grey / Gris antracita– F27 	Brown / Marrón – F51 
			Dark brown / Marrón oscuro – F52 	Beige – F53 
P	Panama (recommended for contract use / recomendado para uso contract)	Composition / Composición Raw hide leather (corrected grain) / Piel de vacuno (flor corregida) Tear resistance / Resistencia del desgarro 20N (EN3377-1) Crack resistance / Solidez a la flexión 50.000 Cycles / Ciclos (EN ISO 5402) Dry rub fastness / Solidez del color a frote seco 1.000 Cycles / Vol. 5 Grey scale 1.000 Ciclos / Vol. 5 Escala de grises (ISO 11640) Wet rub fastness / Solidez del color a frote húmedo 250 Cycles / Vol. 5 Grey scale 250 Ciclos / Vol. 5 Escala de grises (ISO 11640) Light fastness / Solidez a la luz 72 h. exposition / Vol. 5 Grey scale 72 h. de exposición / Vol. 5 Escala de grises (EN ISA 105-B02) Fire test / Tratamiento ignifugo BS5852 CRib5 (optional / opcional) UNI EN 1021-1 UNI EN 1021-2 NFPA 260/UFAC California TB 117 Section E	Sand / Arena – P01 	Black / Negro – P10 
			White / Blanco – P04 	Dark brown / Marrón oscuro – P15 

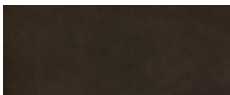
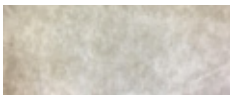
BD FINISHES / ACABADOS

LEATHER / PIELES

REF	NAME / TIPOLOGÍA	DESCRIPTION / DESCRIPCIÓN	COLOURS / COLORES	
V	Vintage (recommended for domestic use / recomendado para uso doméstico)	Composition / Composición NABUK: Through dyeing aniline <i>Piel NABUK tintado en anilina</i> Tear resistance / Resistencia al desgarro >20N (UNI EN ISO 3377-1:2012) Dry rub fastness / Solidez del color a frote seco 50 cycles / Vol. >3 Grey scale <i>50 ciclos / Vol. >3 Escala de grises</i> (ISO 11640) Light fastness / Solidez del color a la luz Vol. >3 Blue scale / Vol. >3 Escala de azules (EN ISA 105-B02) Fire test / Tratamiento ignífugo UNI EN 1021-1 UNI EN 1021-2 NFPA 260 / UFAC FS191 Método S903 - Port Authority of New York IMO Resolution A.652 (16) California TB 117 Section E	Aged Black <i>Negro envejecido – V10</i>	Grey / Gris – V22
				
			Aged Camel <i>Camel envejecido – V18</i>	Sepia – V23
				
			Aged Testa di Moro / Testa di Moro envejecido – V19	Creta – V24
				
S	Sauvage (recommended for domestic use / recomendado para uso doméstico)	Composition / Composición Chrome tanned raw hides. Full grain, aniline dyeing. <i>Piel bovina curtida. Anilina, plena flor.</i> Dry rub fastness / Solidez del color al frote en seco: 150 cycles / ciclos UNI EN ISO 11640 Wet rub fastness / Solidez del color al frote en húmedo: 50 cycles / ciclos UNI EN ISO 11640 Resistance to water drop / Solidez a la gota de agua: UNI EN ISO 15700 >3 Grey scale / Escala de grises Physical characteristics / Características físicas Tear resistance \geq 40N UNI EN ISO 3377-2 Flammability / Tratamiento ignífugo BS 5852:2006 Cigarette test BS 5852:2006 Match test UNI EN 1021-1:2014 Cigarette test UNI EN 1021-2:2014 California TB117 Section E	Black – S40	Iby – S46
				
			Argila – S45	Pomelo – S50
				

VINTAGE & SAUVAGE LEATHER IMPERFECTIONS / IMPERFECCIONES DE LAS PIELES VINTAGE Y SAUVAGE

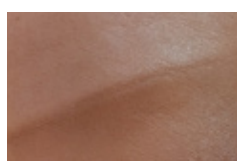

Wrinkles / Arrugas

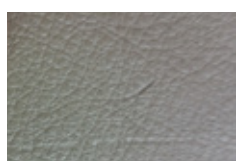

Scar / Cicatriz



Insect bites / Picadas de insectos

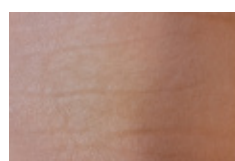







Neck folds / Pliegues del cuello

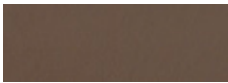

Warts / Verrugas

BD FINISHES / ACABADOS

LEATHER / PIELES

REF	NAME / TIPOLOGÍA	DESCRIPTION / DESCRIPCIÓN	COLOURS / COLORES
F 900			Dark grey / <i>Gris oscuro</i> F903  Green / <i>Verde</i> – F909  Brown / <i>Marrón</i> – F939  Chocolate – F947 
C	Hide / <i>Cuero</i>		Black / <i>Negro</i> – C10  Natural – C13  Toasted / <i>Tostado</i> – C20 

LEATHER CLEANING AND MAINTENANCE / LIMPIEZA Y MANTENIMIENTO DE LAS PIELES

- Avoid direct light.
 - Keep from direct heat.
 - Dust regularly with a soft and dry cloth.
 - Clean with a slightly damp cloth and mild soap. Dry immediately after treatment. Do not rub. Use a light circular motion working toward the center of the stain.
 - To Moisturize the leather we recommend to apply natural neutral creams.
 - Avoid sharp objects.
 - Do not use household cleaners.
-
- Evitar exponer la piel al sol directo.
 - Mantenga la piel alejada del calor directo.
 - Limpiar el polvo regularmente con un paño suave y seco.
 - Las manchas se pueden limpiar con un paño ligeramente húmedo y jabón neutro. Secar inmediatamente después del tratamiento. No frote. Use un ligero movimiento circular hacia el centro de la mancha.
 - Es aconsejable aplicar cremas naturales neutras incoloras, para hidratar la piel.
 - Evitar objetos punzantes.
 - No usar limpiadores del hogar

LEATHER CHARACTERISTICS / CARACTERÍSTICAS DE LAS PIELES

THE NATURAL CHARACTERISTICS OF LEATHER makes this product uneven as of all products that come from nature. Correcting processes make the leathers surface texture even and consequentially less natural. Grain changes, marks and scars caused during the life of an animal are attributes of fine quality and unaltered leather. Wrinkles, bites or other imperfections cannot be considered as defects in leather, but proof of its high quality.

The wrinkles on the surface are part of the original design. Both the number and size of the wrinkles can vary as natural leathers are being used. The elasticity itself enhances the diversity and variability of the wrinkles.

Las características naturales de la piel hacen que sea un producto irregular, como todos los productos que provienen de la naturaleza. Cuantos más procesos de rectificación sufre una piel más regular es la superficie, pero es menos natural. Las pequeñas cicatrices o marcas son características de una piel de primera calidad con poco rectificado, causadas por pequeñas heridas que el propio animal ha tenido a lo largo de su vida. Dichas marcas o cicatrices no pueden considerarse defectos de la piel pues son una muestra de su alta calidad.

Las arrugas producidas en la superficie son originales del propio diseño. Tanto el número de arrugas como el tamaño pueden variar debido a utilizar pieles naturales. La propia elasticidad potencia la diversidad y variabilidad de las arrugas.

BD FINISHES / ACABADOS

FABRICS / TELAS

COMPOSITION KEY / CLAVES DE COMPOSICIÓN

PES - POLYESTER / POLIÉSTER	WO - NATURAL WOOL / LANA NATURAL
PP - POLYPROPYLENE / POLIPROPILENO	CV - VISCOSE / VISCOSA
CO - COTTON / ALGODÓN	MA - MINERAL FIBRE / FIBRA MINERAL

REF	NAME / TIPOLOGÍA	DESCRIPTION / DESCRIPCIÓN	COLOURS / COLORES
CAT 1	Libra (recommended for contract use / recomendado para uso contract)	<p>Composition / Composición 50%PP 32%PES 18%CO</p> <p>Abrasion resistance (End point) / Resistencia a la abrasión (Rotura hilos): EN ISO 12947-2:1998 - 66000</p> <p>Pilling resistance / Resistencia al pilling EN ISO 12945/2:2000; Modified martindale method (2000 and 7000 cycles) (Scale from 1 worst to 5 best): 4-5 EN ISO 12945/2:2000; Método martindale modificado (2000 y 7000 ciclos) (Escala de valores de 1 peor a 5 mejor): 4-5</p> <p>Assessment of ignitability / Reacción al fuego BS 5852 Source 0 BS 5852 Source 1 (opcional) EN 1021- Part 1:2006 EN 1021- Part 2:2006 (opcional) CAL TB 117:2013 California NFPA 260:2013 BS 7176 Low Hazard (opcional) UNI 9175 Clase 3IM (opcional)</p> <p>Lightfastness / Solidez a la luz artificial EN ISO 105-B02:1998 & EN ISO 105 B02/A01:2002 Colour degradation on blue scale (Scale from 1 worst to 8 best): 6-7 Degradación de color en la escala de azules (Escala de 1 peor a 8 mejor): 6-7</p> <p>Colour fastness to rubbing (dry and wet) / Solidez al frote (seco y húmedo) EN ISO 105-X12:2002 (Scale from 1 worst to 5 best): 4-5 (Escala de valores de 1 peor a 5 mejor): 4-5</p> <p>Washing conditions / Condiciones de lavado </p>	<p>Brown / Marrón – TL10 </p> <p>Beige – TL20 </p> <p>Pale Pink / Rosa pálido – TL29 </p> <p>Grey / Gris – TL49 </p> <p>Dark Brown / Marrón oscuro – TL53 </p> <p>Pink / Rosa – TL62 </p>
CAT 2	Iris (recommended for domestic use / recomendado para uso doméstico)	<p>Composition / Composición 41%CO 29%PES 24%PP 6%CV</p> <p>Abrasion resistance (End point) / Resistencia a la abrasión (Rotura hilos) EN ISO 12947-2:1998 - 32000</p> <p>Pilling resistance / Resistencia al pilling EN ISO 12945/2:2000; Modified martindale method (2000 and 7000 cycles) (Scale from 1 worst to 5 best): 4 EN ISO 12945/2:2000; Método martindale modificado (2000 y 7000 ciclos) (Escala de valores de 1 peor a 5 mejor): 4</p> <p>Assessment of ignitability / Reacción al fuego BS 5852 Source 0 BS 5852 Source 1 (opcional) EN 1021- Part 1:2006 EN 1021- Part 2:2006 (opcional) CAL TB 117:2013 California NFPA 260:2013</p> <p>Lightfastness / Solidez a la luz artificial EN ISO 105-B02:1998 & EN ISO 105 B02/A01:2002 Colour degradation on blue scale (Scale from 1 worst to 8 best): 5-6 Degradación de color en la escala de azules (Escala de 1 peor a 8 mejor): 5-6</p> <p>Water repellency / Repelencia al agua (Hidrofobia) AATCC 79:2000 (value > 300): 70</p> <p>Oil repellency / Repelencia al aceite (Oleophobia) EN ISO 14419:1999 / AC:2006 - AATCC 118:2002 (Scale from 1 worst to 8 best): 5-6 (Escala de valores de 1 peor a 8 mejor): 5-6</p> <p>Washing conditions / Condiciones de lavado </p> <p>Repellence Protection / Acabado Protector Manchas</p>	<p>Beige – TI05 </p> <p>Grey / Gris – TI11 </p> <p>Brown / Marrón – TI20 </p>



BD FINISHES / ACABADOS

FABRICS / TELAS









REF	NAME / TIPOLOGÍA	DESCRIPTION / DESCRIPCIÓN	COLOURS / COLORES
CAT 2	Gaudí (recommended domestic & contract use / uso doméstico y contract)	<p>Composition / Composición 60%PP 35%PES 5%CO</p> <p>Abrasion resistance (End point) / Resistencia a la abrasión (Rotura hilos): EN ISO 12947-2:1998 - 46000</p> <p>Pilling resistance / Resistencia al pilling Abrasion resistance (Change of aspect: 3000 cycles) EN ISO 12947/4:1998 & EN 14465:2003/A1:2006 (Scale from 1 worst to 5 best): 5 <i>(Escala de valores de 1 peor a 5 mejor): 5</i></p> <p>Assessment of ignitability / Reacción al fuego BS 5852 Source 0 BS 5852 Source 1 (opcional) EN 1021- Part 1:2006 EN 1021- Part 2:2006 (opcional) CAL TB 117:2013 California NFPA 260:2013 BS 7176 Low Hazard (opcional) UNI 9175 Clase 3IM (opcional)</p> <p>Lightfastness / Solidez a la luz artificial EN ISO 105-B02:1998 & EN ISO 105 B02/A01:2002 Colour degradation on blue scale (Scale from 1 worst to 8 best): 5-6 <i>Degradación de color en la escala de azules (Escala de 1 peor a 8 mejor): 5-6</i></p> <p>Washing conditions / Condiciones de lavado </p>	<p>Light Grey / Gris claro – TG02 </p> <p>Grey / Gris – TG12 </p> <p>Pale Pink / Rosa pálido – TG29 </p> <p>Purple / Morado – TG48 </p> <p>Black / Negro – TG53 </p> <p>Orange / Naranja – TG60 </p>
CAT 2	Laser J Flash (recommended domestic & contract use / uso doméstico y contract)	<p>Melange fabric in 25 colorshades.</p> <p>Weight: 770 g/ml - 550 g/m²</p> <p>Height: 140 cm</p> <p>Composition: 100% Polyester Trevira CS</p> <p>Abrasion resistance ISO 12947/2: 150.000 Rubs</p> <p>Light fastness ISO 105-B02: 6 (blue scale)</p> <p>Fastness to rubbing ISO 105-X12: 4/5 (grey scale)</p> <p>Fire resistance: 1 IM (UNI 9175) can meet AM 18 (NF D 60013) B1 (DIN 4102) BS 7176 can meet C1 (UNI 9174 - UNI 8456) can meet California TB 117 CRIB 5 (BS 5852 part II) EN 1021-1&2 can meet EN 13773, IMO for upholstery Part 8 M1 (NF P 92501-7) can meet ONORM B 3825-Onorm A 3800-1 Class B1-Q1-TR1 can meet USA NFPA 260 can meet USA NFPA 701</p> <p>Stain repellent treatment.</p> <p>Certifications: Oekotex; Euflower - Ecolabel</p>	<p>Mustard / Mostaza - TJ01 </p> <p>Black / Negro - TJ02 </p> <p>Grey / Gris - TJ03 </p> <p>Red / Rojo - TJ04 </p> <p>Navy / Azul marino - TJ05 </p> <p>Green / Verde - TJ06 </p> <p>Brown / Marrón - TJ07 </p> <p>Blue / Azul - TJ08 </p>

BD FINISHES / ACABADOS

FABRICS / TELAS

COMPOSITION KEY / CLAVES DE COMPOSICIÓN

PES - POLYESTER / POLIÉSTER	WO - NATURAL WOOL / LANA NATURAL
PP - POLYPROPYLENE / POLIPROPILENO	CV - VISCOSE / VISCOOSA
CO - COTTON / ALGODÓN	MA - MINERAL FIBRE / FIBRA MINERAL













REF	NAME / TIPOLOGÍA	DESCRIPTION / DESCRIPCIÓN	COLOURS / COLORES
CAT 3	Fusion (recommended for contract use / recomendado para uso contract)	<p>Composition / Composición 34%WO 28%PES 23%PP 15%CO</p> <p>Abrasion resistance (End point) / Resistencia a la abrasión (Rotura hilos): EN ISO 12947-2:1998 - 62000</p> <p>Pilling resistance / Resistencia al pilling EN ISO 12945/2:2000; Modified martindale method (2000 and 7000 cycles) (Scale from 1 worst to 5 best): 4-5 EN ISO 12945/2:2000; Método martindale modificado (2000 y 7000 ciclos) (Escala de valores de 1 peor a 5 mejor): 4-5</p> <p>Assessment of ignitability / Reacción al fuego BS 5852 Source 0 BS 5852 Source 1 EN 1021- Part 1:2006 EN 1021- Part 2:2006 CAL TB 117:2013 California NFPA 260:2013 BS 7176 Low Hazard UNI 9175 Clase 3IM IMO Anexo 1 Parte 8</p> <p>Lightfastness / Solidez a la luz artificial EN ISO 105-B02:1998 & EN ISO 105 B02/A01:2002 Colour degradation on blue scale (Scale from 1 worst to 8 best): 7-8 Degradación de color en la escala de azules (Escala de 1 peor a 8 mejor): 7-8</p> <p>Colour fastness to rubbing (dry and wet) / Solidez al frote (seco y húmedo) EN ISO 105-X12:2002 (Scale from 1 worst to 5 best): 4-5 (Escala de valores de 1 peor a 5 mejor): 4-5</p> <p>Washing conditions / Condiciones de lavado 🧺🚫🧼🚫🧻</p>	<p>Beige – TF05 </p> <p>Dark Grey / Gris – TF53 </p> <p>Light Grey / Gris – TF54 </p> <p>Garnet / Granate – TF122 </p> <p>Mustard / Mostaza – TF125 </p> <p>Green / Verde – TF138 </p> <p>Blue / Azul – TF143 </p> <p>Antacite grey / Gris antracita – TF155 </p>

BD FINISHES / ACABADOS

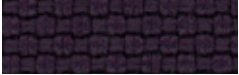
FABRICS / TELAS

COMPOSITION KEY / CLAVES DE COMPOSICIÓN

PES - POLYESTER / POLIÉSTER	WO - NATURAL WOOL / LANA NATURAL
PP - POLYPROPYLENE / POLIPROPILENO	CV - VISCOSE / VISCOSA
CO - COTTON / ALGODÓN	MA - MINERAL FIBRE / FIBRA MINERAL







REF	NAME / TIPOLOGÍA	DESCRIPTION / DESCRIPCIÓN	COLOURS / COLORES
CAT 3	Nabucco (recommended domestic & contract use / uso doméstico y contract)	<p>Description: Heavy structured fabric with a high resistance . 19 colors</p> <p>Weight: 1290 g/ml - 920 g/m²</p> <p>Height: 140 cm</p> <p>Composition: 100% Trevira CS</p> <p>Abrasion resistance: ISO 12947/2: 120.000 Rubs</p> <p>Light fastness ISO 105-B02: 6 (blue scale)</p> <p>Fastness to rubbing ISO 105-X12: 4/5 (grey scale)</p> <p>Fire resistance: can meet 1 IM (UNI 9175) can meet AM 18 (NF D 60013) B1 (DIN 4102) can meet C1 (UNI 9174 - UNI 8456) can meet California TB 117 EN 1021-1&2 IMO for upholstery Part 8 M1 (NF P 92501-7) can meet ONORM B 3825-Onorm A 3800-1 Class B1-Q1-TR1 can meet USA NFPA 260</p> <p>Certifications: Oekotex</p>	<p>Mustard / Mostaza - TN01 </p> <p>Dark orange / Teja - TN02 </p> <p>Beige - TN03 </p> <p>Green / Verde - TN04 </p> <p>Grey / Gris - TN05 </p> <p>Navy / Azul marino - TN06 </p> <p>Violet / Violeta - TN07 </p> <p>Black / Negro - TN08 </p>
CAT 4	Moss (recommended for contract use / recomendado para uso contract)	<p>Composition / Composición 100% PES FR</p> <p>Abrasion resistance (End point) / Resistencia a la abrasión (Rotura hilos): EN ISO 12947-2:1998 - 50.000</p> <p>Pilling resistance / Resistencia al pilling EN ISO 12945/2:2000; Modified martindale method (2000 and 7000 cycles) (Scale from 1 worst to 5 best): 4-5 EN ISO 12945/2:2000; Método martindale modificado (2000 y 7000 ciclos) (Escala de valores de 1 peor a 5 mejor): 4-5</p> <p>Assessment of ignitability / Reacción al fuego BS 5852 Source 0 BS 5852 Source 1 EN 1021- Part 1:2006 EN 1021- Part 2:2006 CAL TB 117:2013 California NFPA 260:2013 BS 7176 Low Hazard UNI 9175 Clase 1IM IMO Anexo 1 Parte 8 NF D 60 013 DIN 4102 B2</p> <p>Acoustic certificate -EN ISO 354</p> <p>Lightfastness / Solidez a la luz artificial EN ISO 105-B02:1998 & EN ISO 105 B02/A01:2002 Colour degradation on blue scale (Scale from 1 worst to 8 best): 6-7 Degradación de color en la escala de azules (Escala de 1 peor a 5 mejor): 6-7</p> <p>Colour fastness to rubbing / Solidez al frote EN ISO 105-X12:2002 (Scale from 1 worst to 5 best) Dry: 5; Wet: 4-5 EN ISO 105-X12:2002 (Escala de valores de 1 peor a 5 mejor) Seco: 4; Húmedo: 4-5</p> <p>Washing conditions / Condiciones de lavado</p> <p></p>	<p>Orange Brown / Marrón naranja - TM24 </p> <p>Blue / Azul - TM45 </p> <p>Dark Grey / Gris oscuro - TM53 </p> <p>Red / Rojo - TM65 </p>

BD FINISHES / ACABADOS

FABRICS / TELAS









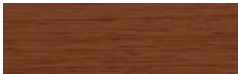

COMPOSITION KEY / CLAVES DE COMPOSICIÓN

PES - POLYESTER / POLIÉSTER	WO - NATURAL WOOL / LANA NATURAL
PP - POLYPROPYLENE / POLIPROPILENO	CV - VISCOSE / VISCOSA
CO - COTTON / ALGODÓN	MA - MINERAL FIBRE / FIBRA MINERAL











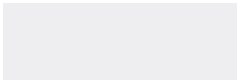
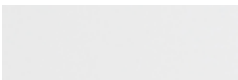



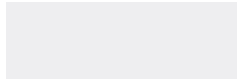

REF	NAME / TIPOLOGÍA	DESCRIPTION / DESCRIPCIÓN	COLOURS / COLORES
CAT 5	Shaun	<p>Composition / Composición 29%PES 29%PAN 21%CO 15%WO 6%CV</p> <p></p>	<p>White / Blanco – Col. 1</p>  <p>Yellow / Amarillo – Col. 5</p>  <p>Green / Verde – Col. 6</p> 
G	Gamma	<p>Composition / Composición 100% PP, outdoor use / uso exterior</p> <p>Weight / Ancho: 200g/mq</p> <p>Tear resistance / Resistencia del desgarro 40.000 Martindale (UNE EN ISO 12947-1)</p> <p>Colour fastness / Solidez de color 8-8 (UNI EN 180 105B02)</p> <p>Cleaning / Limpieza Dry clean / <i>Nettoyage à sec</i> Lavaggio a secco / <i>Chemische Reinigung</i></p> <p>UV protection / Protección UV (0-50): 50+</p> <p>Fire test / Tratamiento ignífugo UE: EN 1021 - 1 :2006 UK: BS 5852 - 2006 D: DIN 66084 : 2003 clasification P-c USA: CALTB 117 : 2000 Section E NFPA 260 : 2009 Class 1</p> <p>Colour matching / Semejanza de colores Colour variations between batches (3%) <i>Variaciones de color entre lotes (3%)</i></p> <p>Maintenance / Mantenimiento Vacuum regularly. In case of stains, use a damp cloth with neutral soap suitable for cleaning upholstery. <i>Aspirar regularmente. En caso de manchas, use un paño húmedo con jabón neutro adecuado para limpiar la tapicería.</i></p>	<p>White / Blanco – G04</p>  <p>Grey / Gris – G13</p>  <p>Green / Verde – G16</p> 

BD FINISHES / ACABADOS

WOOD / MADERA

REF	NAME / TIPOLOGÍA	DESCRIPTION / DESCRIPCIÓN	COLOURS / COLORES
RM	Varnished Oak / <i>Roble barnizado</i>	Stained oak and varnished. <i>Roble teñido y barnizado</i>	
NGEN	Walnut / <i>Nogal</i>	Walnut Nature Effect <i>Nogal Efecto Nature</i>	
FR13	Ash / <i>Fresno</i>	Natural varnished <i>Natural barnizado</i>	
FR20	Ash / <i>Fresno</i>	Open pore lacquered in coral red <i>Lacado a poro abierto en rojo coral (RAL 3016)</i>	
FT10	Ash / <i>Fresno</i>	Stained Black <i>Teñido negro</i>	
FT18	Ash / <i>Fresno</i>	Stained Oak <i>Teñido Roble</i>	
ES	Laminated <i>Estratificado</i>	Grey perle <i>Gris perla</i>	
		Beige	
		Nearly Black <i>Casi negro</i>	
		Natural oak <i>Roble natural</i>	

BD FINISHES / ACABADOS

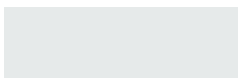
REF	NAME / TIPOLOGÍA	DESCRIPTION / DESCRIPCIÓN	COLOURS / COLORES	
LAC	High Gloss lacquer <i>Lacado brillo</i>	MDF lacquered gloss <i>MDF lacado brillo</i>	White / Blanco – 04 (RAL 9003) 	White / Blanco – B31 (RAL 9016) 
			Black / Negro – 10 (RAL 9005) 	Green / Verde - B33 (RAL 6021) 
			Blue / Azul – 09 (RAL 5002) 	Blue / Azul – B32 (RAL 5011) 
			White / Blanco (RAL 9016) 	Pastel Green / Verde pastel (RAL 6019) 
			Salmon (RAL D2 040 50 30) 	Coral red / Rojo coral (RAL 3016) 
LAC	Matte lacquer <i>Lacado mate</i>	MDF matte-lacquered. <i>MDF lacado mate</i>	White / Blanco – M04 (RAL 9003) 	Dark Blue / Azul oscuro – M17 (RAL 5003) 
			Black / Negro – M10 (RAL 9005) 	Blue / Azul – 09 (RAL 5002) 
			Dark red / Rojo oscuro M19 (RAL 3004) 	Crema / Crema NCS 1005-Y20R 
			Blue / Azul (RAL 5000) 	Green – Verde (NCS 5540-G20Y) 
			Yellow / Amarillo (RAL 1012) 	Grey / Gris (NCS S 0502-G) 

BD FINISHES / ACABADOS

WOOD & LACQUER MAINTENANCE AND CLEANING / MANTENIMIENTO Y LIMPIEZA DE LA MADERA Y LA LACA

Furniture pieces should be placed in areas with stable temperatures and humidity. Only suitable for indoor use. It is recommended that items be placed in areas with no direct exposure to air conditioners, heat or sunlight.

Rub gently with a dry cotton cloth or with a natural wax product. Solvents and abrasive detergents should especially be avoided.

Maintenance and cleaning

BD recommends using a damp cloth using only water. For oily, greasy stains (finger prints) we recommend using a sponge with water and a neutral detergent, and afterwards finishing off with a water dampened cloth. Using detergents containing solvents and or pure ethyl alcohol should be avoided.

As these are natural colours and tones, there may be some differences. Clear woods always tend to darken with time but this also depends on the direct exposure to light.

Los muebles deben colocarse en áreas con temperatura y humedad estables. Sólo apto para uso en interiores. Se recomienda evitar la exposición directa a los aires acondicionados, el calor directo o la luz solar.

Frote suavemente con un paño seco de algodón o con un producto de cera natural. No utilice disolventes ni productos abrasivos.

Mantenimiento y Limpieza

BD recomienda utilizar un trapo humedecido con agua. Para manchas grasientas/untuoso (huellas), se aconseja pasar una esponja con agua y detergente neutro y luego con un paño humedecido con agua. Se debe evitar la utilización de detergente que contengan solventes y/o alcohol etílico puro.

Al tratarse de colores y tonos naturales, pueden haber algunas diferencias. Las maderas claras con el tiempo tienden siempre a oscurecer, dependiendo de la exposición directa de la luz.

PLASTIC / PLÁSTICO

PL Polypropylene / Polipropileno
Polyurethane / Poliuretano
Polyethylene / Polietileno

Black / Negro



White / Blanco



Red / Rojo



PLASTIC MAINTENANCE AND CLEANING / MANTENIMIENTO Y LIMPIEZA DEL PLÁSTICO

BD recommends using a damp cloth using only water. For oily, greasy stains (finger prints) we recommend using a sponge with water and a neutral detergent, and afterwards finishing off with a water dampened cloth. Using detergents containing solvents and or pure ethyl alcohol should be avoided.

BD aconseja un trapo humedecido con agua. Para manchas grasientas/untuoso (huellas), se aconseja pasar una esponja con agua y detergente neutro y luego con un paño humedecido con agua. Se debe evitar la utilización de detergente que contengan solventes y/o alcohol etílico puro.

MARBLE / MÁRMOL

White / Blanco Carrara Venato



Black / Negro Nero Marquina



Green / Verde Patrizia



MARBLE MAINTENANCE AND CLEANING / MANTENIMIENTO Y LIMPIEZA DEL MÁRMOL

BD recommends using a damp cloth using only lukewarm water. For oily, greasy stains (finger prints) we recommend using a sponge with water and a neutral detergent, and afterwards finishing off with a water dampened cloth. Using detergents containing solvents and or pure ethyl alcohol should be avoided.

BD recomienda utilizar un paño mojado con agua tibia. En caso de manchas, provocadas por líquidos y/o sustancias untuosas, en seguida hay que extraer/sacar lo sucio con un paño que absorba y luego, pasar toda la superficie con un paño mojado en agua tibia. Hay que evitar específicamente disolventes y detergentes abrasivos.

GLIDES FOR CHAIRS & ARMCHAIRS / TACOS PARA SILLAS Y BUTACAS

SHOWTIME & NUDE 4 LEGS / PATAS WOOD MADERA

QUICKCLICK SYNO (included / incluido)

Novel, natural special fibre mixture; abrasion proof, humidity repellent and sound dampening. E.g.: linoleum, ceramic, terrazzo.

*Mezcla natural de fibra especial; a prueba de abrasión, repelente de humedad y amortiguación acústica.
Por ejemplo: linóleo, cerámica, terrazo.*



QUICKCLICK ULTRASOFT (included / incluido)

High quality pressed wool felt glide for highly sensitive hard floorings. E.g.: Wood.

*Taco de fieltro de lana prensada de alta calidad para suelos duros altamente sensibles.
Por ejemplo: madera.*



SHOWTIME & NUDE 4 LEGS / PATAS METAL

QUICKCLICK SUPER (included / incluido)

From high technical POM plastic; very good sliding properties; for all soft surfaces. E.g.: Carpet.

*De plástico de alta técnica POM; muy buenas propiedades deslizantes; para todas las superficies blandas.
Por ejemplo: alfombra.*



QUICKCLICK ULTRASOFT (included / incluido)

High quality pressed wool felt glide for highly sensitive hard floorings. E.g.: Wood.

*Taco de fieltro de lana prensada de alta calidad para suelos duros altamente sensibles.
Por ejemplo: madera.*



SHOWTIME & NUDE SLED / PATÍN

STANDARD (included / incluido)

Polyethylene lightweight insert; for hard and semi-hard surfaces. E.g.: Concrete, ceramic, wood.

*Taco redondo ligero de polietileno; para superficies duras y semiduras.
Por ejemplo: hormigón, cerámica, madera.*



QUICKCLICK ULTRASOFT (included on request / incluido bajo pedido)

High quality pressed wool felt glide for highly sensitive hard floorings. E.g.: Wood.

*Taco de fieltro de lana prensada de alta calidad para suelos duros altamente sensibles.
Por ejemplo: madera.*



QUICKCLICK SYNO (special order only / bajo pedido)

Novel, natural special fibre mixture; abrasion proof, humidity repellent and sound dampening. E.g.: linoleum, ceramic, terrazzo.

*Mezcla natural de fibra especial; a prueba de abrasión, repelente de humedad y amortiguación acústica.
Por ejemplo: linóleo, cerámica, terrazo.*



SHOWTIME & NUDE SWIVEL / GIRATORIA

STANDARD (included / incluido)

Polyethylene lightweight rounded insert; for hard and semi-hard surfaces. E.g.: Concrete, ceramic, wood.

*Taco redondo ligero de polietileno; para superficies duras y semiduras.
Por ejemplo: hormigón, cerámica, madera.*



QUICKCLICK SUPER (special order only / bajo pedido)

From high technical POM plastic; very good sliding properties; for all soft surfaces. E.g.: Carpet.

Valid until stock lasts.

*De plástico de alta técnica POM; muy buenas propiedades deslizantes; para todas las superficies blandas.
Por ejemplo: alfombra.
Válido hasta agotar existencias.*



QUICKCLICK SYNO (special order only / bajo pedido)

Novel, natural special fibre mixture; abrasion proof, humidity repellent and sound dampening. E.g.: linoleum, ceramic, terrazzo.

*Mezcla natural de fibra especial; a prueba de abrasión, repelente de humedad y amortiguación acústica.
Por ejemplo: linóleo, cerámica, terrazo.*



QUICKCLICK ULTRASOFT (special order only / bajo pedido)

High quality pressed wool felt glide for highly sensitive hard floorings. E.g.: Wood flooring only.

*Taco de fieltro de lana prensada de alta calidad para suelos duros altamente sensibles.
Por ejemplo: solo suelos madera.*



GAULINO GAULINETTA CHAIR & ARMCHAIR SILLA Y CHAIR B

QUICKCLICK SYNO (included / incluido)

Novel, natural special fibre mixture; abrasion proof, humidity repellent and sound dampening. E.g.: linoleum, ceramic, terrazzo.

*Mezcla natural de fibra especial; a prueba de abrasión, repelente de humedad y amortiguación acústica.
Por ejemplo: linóleo, cerámica, terrazo.*



QUICKCLICK ULTRASOFT (included / incluido)

High quality pressed wool felt glide for highly sensitive hard floorings. E.g.: Wood.

*Taco de fieltro de lana prensada de alta calidad para suelos duros altamente sensibles.
Por ejemplo: madera.*



MINIVARIUS

STANDARD (included / incluido)

Polyethylene lightweight rounded insert; for hard and semi-hard surfaces. E.g.: Concrete, ceramic, wood.

*Taco redondo ligero de polietileno; para superficies duras y semiduras.
Por ejemplo: hormigón, cerámica, madera.*



GLIDES FOR CHAIRS & ARMCHAIRS / TACOS PARA SILLAS Y BUTACAS

JAMAICA STOOL TABURETE
STANDARD
 (included / incluido)
 Polyethylene lightweight rounded insert; for hard and semi-hard surfaces.
 E.g.: Concrete, ceramic, wood.
*Taco redondo ligero de polietileno; para superficies duras y semiduras.
 Por ejemplo: hormigón, cerámica, madera.*



JANET STOOL TABURETE
STANDARD
 (included / incluido)
 Polyethylene lightweight rounded insert; for hard and semi-hard surfaces.
 E.g.: Concrete, ceramic, wood.
*Taco redondo ligero de polietileno; para superficies duras y semiduras.
 Por ejemplo: hormigón, cerámica, madera.*



GRASSO STOOL TABURETE
STANDARD
 (included / incluido)
 Rubber semispherical non-slipping insert; for standard floorings.
 E.g.: Concrete, ceramic, wood.
*Taco antideslizante semiesférico de goma; para pavimentos estándar.
 Por ejemplo: hormigón, cerámica, madera.*



POLTRONA SHOWTIME
STOP
 (included / incluido)
 The safety insert with the stop effect for all smooth, slippery surfaces.
 E.g.: Marble, ceramic tiles, natural stone, wooden floors.
*Taco de seguridad con efecto de parada para todas las superficies lisas y resbaladizas.
 Por ejemplo: mármol, baldosas de cerámica, piedra natural, suelos de madera.*



GRASSO ARMCHAIR BUTACA
STANDARD
 (included / incluido)
 Rubber semispherical non-slipping insert. For standard floorings.
 E.g.: Concrete, ceramic, wood.
*Taco antideslizante semiesférico de goma; para pavimentos estándar.
 Por ejemplo: hormigón, cerámica, madera.*



DINO
QUICKCLICK ULTRASOFT
 (included for iron standard legs / incluido para patas de hierro standard)
 High quality pressed wool felt glide for highly sensitive hard floorings.
 E.g.: Wood.
*Taco de fieltro de lana prensada de alta calidad para suelos duros altamente sensibles.
 Por ejemplo: madera.*



COUTURE / LITTLE COUTURE
QUICKCLICK ULTRASOFT
 (included for fixed base model / incluido para el modelo con base fija)
 High quality pressed wool felt glide for highly sensitive hard floorings.
 E.g.: Wood.
*Taco de fieltro de lana prensada de alta calidad para suelos duros altamente sensibles.
 Por ejemplo: madera.*



QUICKCLICK ULTRASOFT
 (included for aluminium legs / incluido para patas de aluminio)
 High quality pressed wool felt glide for highly sensitive hard floorings.
 E.g.: Wood.
*Taco de fieltro de lana prensada de alta calidad para suelos duros altamente sensibles.
 Por ejemplo: madera.*

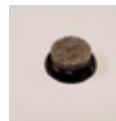

QUICKCLICK ULTRASOFT
 (included for swivel system model / incluido para el modelo con sistema giratorio)
 High quality pressed wool felt glide for highly sensitive hard floorings.
 E.g.: Wood.
*Taco de fieltro de lana prensada de alta calidad para suelos duros altamente sensibles.
 Por ejemplo: madera.*



QUICKCLICK SYNO
 (included for aluminium legs / incluido para patas de aluminio)
 Novel, natural special fibre mixture; abrasion proof, humidity repellent and sound dampening.
 E.g.: linoleum, ceramic, terrazzo.
*Mezcla natural de fibra especial; a prueba de abrasión, repelente de humedad y amortiguación acústica.
 Por ejemplo: linóleo, cerámica, terrazo.*



LOUNGER & LOW LOUNGER
STANDARD
 (included / incluido)
 Polyethylene lightweight rounded insert; for hard and semi-hard surfaces.
 E.g.: Concrete, ceramic, wood.
*Taco redondo ligero de polietileno; para superficies duras y semiduras.
 Por ejemplo: hormigón, cerámica, madera.*



GARDENIAS
STANDARD
 (included / incluido)
 Polyethylene lightweight glide with rounded insert; for hard and semi-hard surfaces.
 E.g.: Concrete, ceramic, wood.
*Taco ligero de polietileno con inserción redondeada; para superficies duras y semiduras.
 Por ejemplo: hormigón, cerámica, madera.*



LOW LOUNGER 4 LEG 4 PATAS
STANDARD
 (included / incluido)
 Polyethylene lightweight rounded insert; for hard and semi-hard surfaces.
 E.g.: Concrete, ceramic, wood.
*Taco redondo ligero de polietileno; para superficies duras y semiduras.
 Por ejemplo: hormigón, cerámica, madera.*



STANDARD
 (included / incluido)
 Polyethylene lightweight rounded insert; for hard and semi-hard surfaces.
 E.g.: Concrete, ceramic, wood.
*Taco redondo ligero de polietileno; para superficies duras y semiduras.
 Por ejemplo: hormigón, cerámica, madera.*



SHELVING / CONTENEDORES

DREAMS CABINET

Cristian Zuzunaga

Modules, doors, shelves and drawers lacquered in a matte black finish. Tops, doors and sides mounted with 6mm tempered printed glass.
Legs: Solid beech wood lacquered in matte black. Available in 2 versions: colour and All Black. Shelves included.

*Contenedores, puertas, estantes y cajones lacados en negro mate. Tops superiores, frontales y laterales en vidrio templado impreso de 6mm.
Patas en haya maciza lacadas negro mate. 2 versiones: color y All Black. Estantes incluidos.*

2M

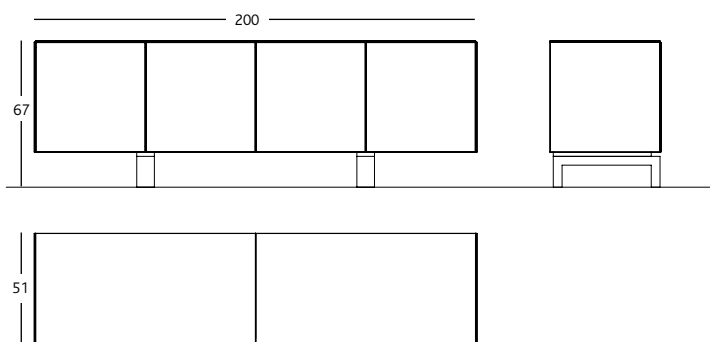

2M 7.834
(includes 4 shelves / incluye 4 estantes)

3M 11.919
(includes 6 shelves / incluye 6 estantes)

Single drawer 723
Cajón individual

3M

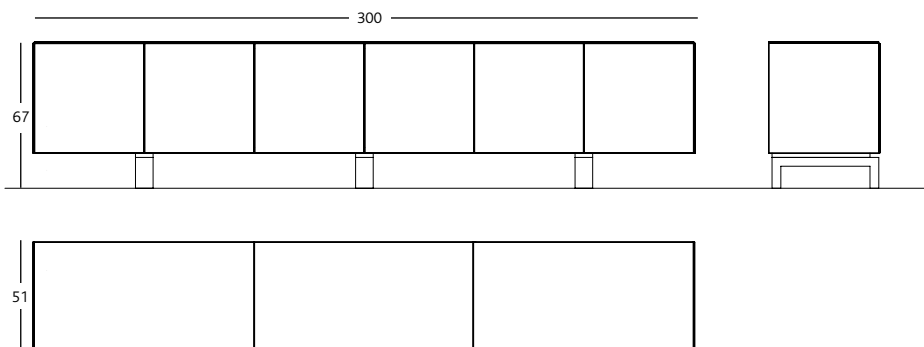

Single drawer (optional) Cajón individual (opcional)

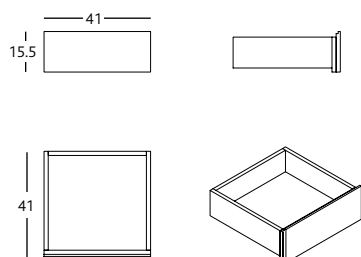

PACKAGING

PCS	DIMENSIONS CM	GROSS KG
1	115 x 60 x 72	86

Module 1M / Módulo 1M
(without drawers / sin cajones)

MODELS / MODELOS

Colour / Color



All Black

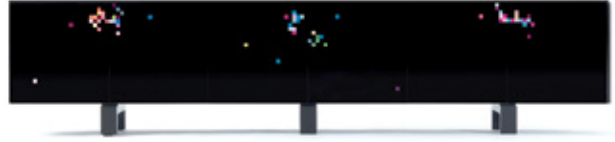

TABLES
MESAS

ARMCHAIRS
BUTACAS

EXAMPLES / EJEMPLOS

Example / Ejemplo 1

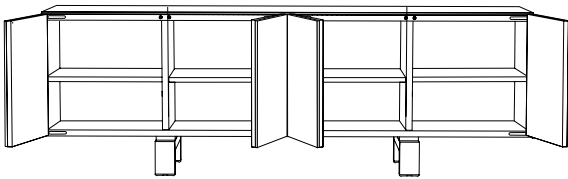

2M (4 shelves / estantes)

TOTAL 7.834

PACKAGING

PCS	DIMENSIONS CM	GROSS KG
2	115 x 60 x 72	172

CHAIRS AND STOOLS
SILLAS Y TABURETES

ACCESSORIES
ACCESORIOS

Example / Ejemplo 2

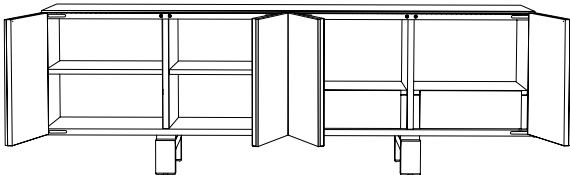

2M (4 drawers / cajones)

TOTAL 9.280

PACKAGING

PCS	DIMENSIONS CM	GROSS KG
2	116 x 62 x 72	192

LIGHTING
ILUMINACIÓN

Example / Ejemplo 3

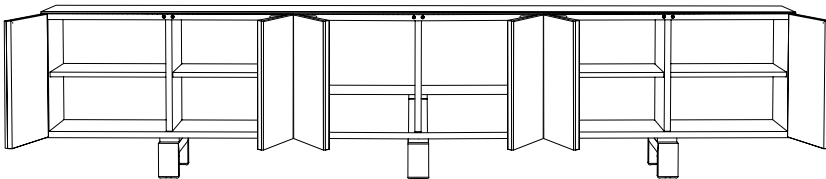

3M (4 shelves + 2 drawers / 4 estantes + 2 cajones)

TOTAL 13.365

PACKAGING

PCS	DIMENSIONS CM	GROSS KG
3	115 x 60 x 72	266

PUBLIC SEATING
ASIENTOS PÚBLICOS

ART EDITIONS

EXPLORER CABINET

Jaime Hayon

Cupboards, doors and drawers in MDF. Gloss lacquered external finish and matte lacquered interior finish. Legs made from solid alder wood, gloss lacquer finish. Horizontal shelving and vertical bracket supports in MDF, gloss lacquer finish. Drawer units interior structure in MDF, matte lacquer finish.

Armarios, puertas y cajones en MDF. Acabado exterior lacado brillo y acabado interior lacado mate. Patas en madera maciza de aliso, acabado lacado brillo. Estanterías horizontales y soportes verticales en MDF, acabado lacado brillo. Estructura interior de cajones en MDF, acabado lacado mate.

192 S

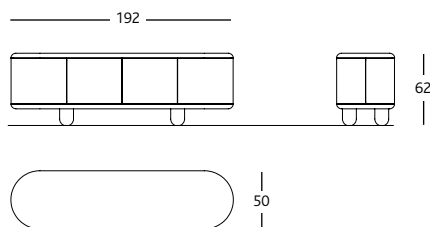

192 S

8.212

PACKAGING

	PCS	DIMENSIONS CM	GROSS KG
Modules+4 legs / Módulos+4 patas	1	120 x 100 x 95	65
Top / Sobre	1	60 x 200 x 75	35

192 M

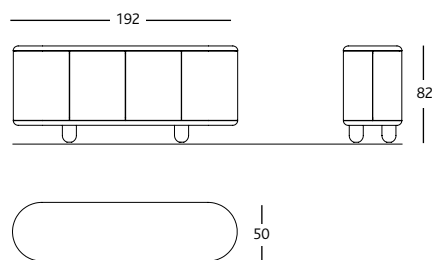

192 M

8.818

PACKAGING

	PCS	DIMENSIONS CM	GROSS KG
Modules+4 legs / Módulos+4 patas	1	120 x 100 x 115	75
Top / Sobre	1	60 x 200 x 75	35

192 XL

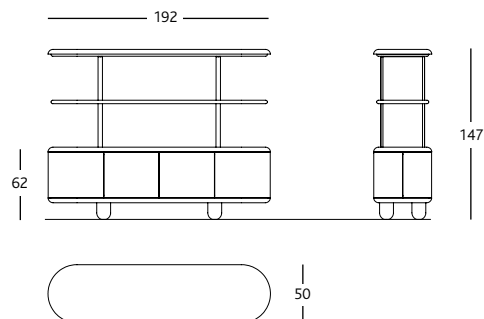

192 XL

10.892

PACKAGING

	PCS	DIMENSIONS CM	GROSS KG
Modules+4 legs+shelves / Módulos+4 patas+baldas	1	120 x 100 x 115	80
Top / Sobre	1	60 x 200 x 75	35

240 S

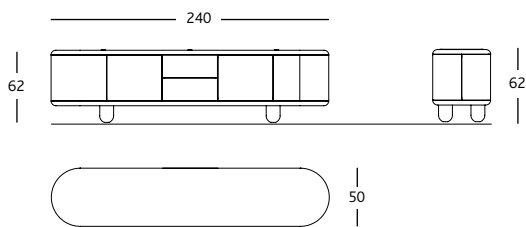

240 S

10.976

PACKAGING			
	PCS	DIMENSIONS CM	GROSS KG
Modules+4 legs / Módulos+4 patas	1	120 x 100 x 135	75
Top / Sobre	1	60 x 250 x 75	35

TABLES
MESAS

ARMCHAIRS
BUTACAS

240 M

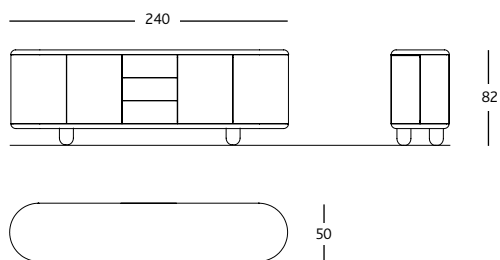

240 M

12.081

PACKAGING			
	PCS	DIMENSIONS CM	GROSS KG
Modules+4 legs / Módulos+4 patas	1	120 x 100 x 155	85
Top / Sobre	1	60 x 250 x 75	35

CHAIRS AND STOOLS
SILLAS Y TABURETES

ACCESSORIES
ACCESORIOS

240 XL

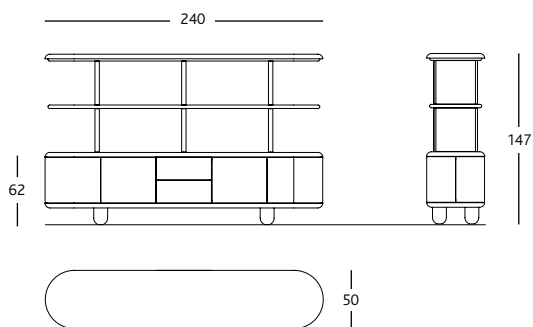

240 XL

14.633

PACKAGING			
	PCS	DIMENSIONS CM	GROSS KG
Modules+4 legs+shelves / Módulos+4 patas+baldas	1	120 x 100 x 155	90
Top / Sobre	1	60 x 250 x 75	35

LIGHTING
ILUMINACIÓN

PUBLIC SEATING
ASIENTOS PÚBLICOS

ART EDITIONS

EXPLORER CABINET COLOR COMBINATIONS



- White RAL 9016
- Blue RAL 5000



- Black RAL 9005
- Yellow RAL 1012



- Green RAL 6019
- Green NCS 5540-G20Y



- Blue RAL 5024
- Creme NCS 1005-Y20R



- Salmon RAL D2 040 50 30
- Yellow RAL 1012



- Red RAL 3016
- Grey NCS S 0502-G

TOUT VA BIEN CABINET

Antoine et Manuel

Modules and shelves made of lacquered MDF in greyish white RAL 9002, RAL 8028 or graphite grey RAL 7024. Doors, flat top(s), sides and leg AM04 in injected integral polyurethane with a plywood support. Solid alder wooden legs in a microtextured lacquered finish (in the same colour as the piece).

Contenedor y estante fabricado en MDF lacado en blanco grisáceo RAL 9002, RAL 8028 o gris grafito RAL 7024. Puertas, sobre liso, laterales y pata AMØ4 en inyección de poliuretano integral, con soporte de tablero de melamina. Patas en aliso macizo de una sola pieza, lacada microtexturizado en el mismo color que las puertas.

Module 60 / Módulo 60

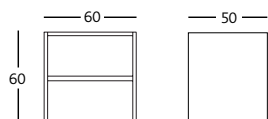
Top with mountain
Top con Montaña

Module 60
(doors and shelves included /*incluido*
puertas y estantes)
60x50x60 cm

2.149

Module 120 / Módulo 120

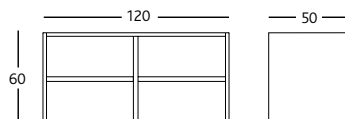
Flat top
Top liso

Module 120
(doors and shelves included /*incluido*
puertas y estantes)
120x50x60 cm

3.789

Legs / Patas

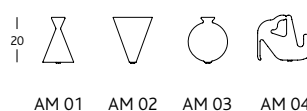

AM 01 AM 02 AM 03 AM 04

Prism lateral
Lateral prisma

295

**Flat top
or lateral**
*Laterales
o tops lisos*

338

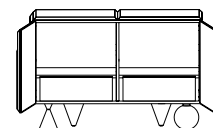
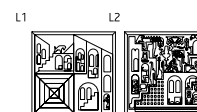
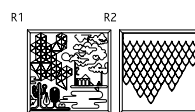
Optional drawers /
Cajones opcionalesLeft doors
Puertas izquierdasRight doors
Puertas derechas

Top with mountain
Top con montaña

685

Legs
Patas

253

Lower drawer (un.)
Cajón inferior (un.)

702

Greyish White / Blanco grisáceo
RAL 9002Graphite Grey / Gris Grafito
RAL 7024Chocolate
RAL 8028

- Choose combination doors: right (R1 or R2) and left (L1 or L2).
- Each 120 cm module has four legs. The 60 cm module has two legs (this option cannot be ordered separately).
- Leg AM 04 and the mountain top may have a different tone in colour due to the material (integral polyurethane).
- It is recommended not to place any objects on top of the top(s). Any damage caused will not be the responsibility of BD Barcelona.

- Escoge puertas combinadas: derecha (R1 o R2) e izquierda (L1 o L2).
- Cada módulo de 120 cm tiene cuatro patas. El módulo de 60 cm tiene 2 patas (esta opción no se puede pedir por separado).
- El color de la pata AM 04 y el top de montaña puede tener diferente tonalidad debido al material empleado (poliuretano integral).
- Se recomienda no colocar ningún objeto encima de los top(s). Cualquier daño ocasionado no será responsabilidad de BD Barcelona.

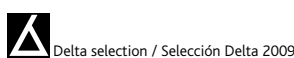

Delta selection / Selección Delta 2009

TOUT VA BIEN EXAMPLES / EJEMPLOS

Example / Ejemplo 1

TVBEJ01034 Greyish White / Blanco grisáceo
 TVBEJ01014 Graphite Grey / Gris grafito
 TVBEJ01028 Chocolate

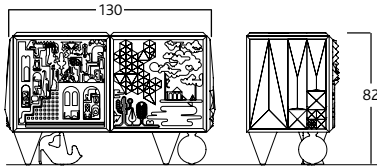

Module 120 Módulo 120	(1 unit x 3.789)	3.789
Legs Patas	(4 units x 253)	1.012
Prism lateral Lateral prisma	(2 units x 338)	676
Flat top Top liso	(2 units x 295)	590
TOTAL		6.067

PACKAGING

Module / Módulo Legs / Patas	PCS	DIMENSIONS CM	GROSS KG
1	1	138 x 67 x 82	94
	1	60 x 50 x 40	6

Example / Ejemplo 2

TVBEJ02034 Greyish White / Blanco grisáceo
 TVBEJ02014 Graphite Grey / Gris grafito
 TVBEJ02028 Chocolate

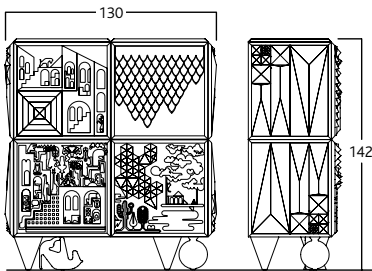

Module 120 Módulo 120	(2 units x 3.789)	7.578
Legs Patas	(4 units x 253)	1.012
Prism lateral Lateral prisma	(4 units x 338)	1.352
Flat top Top liso	(2 units x 295)	590
TOTAL		10.532

PACKAGING

Module / Módulo Legs / Patas	PCS	DIMENSIONS CM	GROSS KG
2	1	138 x 67 x 82	188
	1	65 x 60 x 35	6

Example / Ejemplo 3A

TVBEJ03A034 Greyish White / Blanco grisáceo
 TVBEJ03A014 Graphite Grey / Gris grafito
 TVBEJ03A028 Chocolate

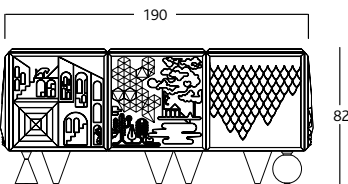

Example / Ejemplo 3B

TVBEJ03B034 Greyish White / Blanco grisáceo
 TVBEJ03B014 Graphite Grey / Gris grafito
 TVBEJ03B028 Chocolate

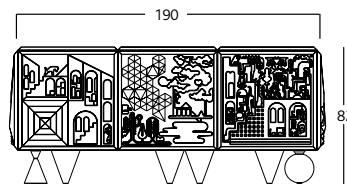

Module 120 Módulo 120	(1 unit x 3.789)	3.789
Module 60 Módulo 60	(1 unit x 2.149)	2.149
Legs Patas	(6 units x 253)	1.518
Prism lateral Lateral prisma	(2 units x 338)	676
Flat top Top liso	(3 units x 295)	885
TOTAL		9.017

PACKAGING

Module / Módulo Legs / Patas	PCS	DIMENSIONS CM	GROSS KG
1	1	138 x 67 x 82	94
1	1	78 x 66 x 82	61
1	1	65 x 60 x 35	9



TOUT VA BIEN EXAMPLES / EJEMPLOS

Example / Ejemplo 4A

TVBEJ04A034 Greyish White / Blanco grisáceo
 TVBEJ04A014 Graphite Grey / Gris grafito
 TVBEJ04A028 Chocolate

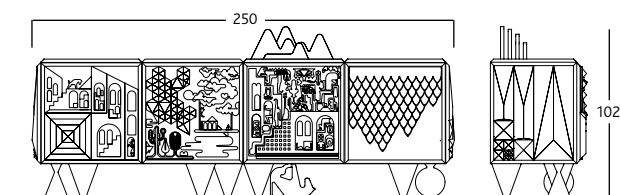

Module 120 <i>Módulo 120</i>	(2 units x 3.789)	7.578
Legs <i>Patas</i>	(8 units x 253)	2.024
Prism lateral <i>Lateral prisma</i>	(2 units x 338)	676
Flat top <i>Top liso</i>	(3 units x 295)	885
Top with mountain <i>Top con montaña</i>	(1 unit x 685)	685
TOTAL		11.848

PACKAGING

	PCS	DIMENSIONS CM	GROSS KG
Module / <i>Módulo</i>	1	138 x 67 x 82	94
Module with mountain / <i>Módulo con montaña</i>	1	138 x 67 x 101	97
Legs / <i>Patas</i>	1	65 x 50 x 50	18

Example / Ejemplo 4B 

TVBEJ04B034 Greyish White / Blanco grisáceo
 TVBEJ04B014 Graphite Grey / Gris grafito
 TVBEJ04B028 Chocolate

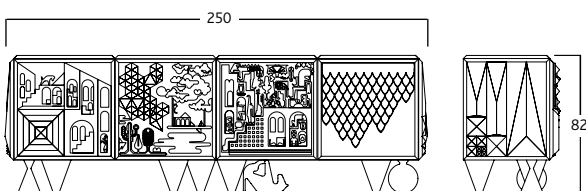

Module 120 <i>Módulo 120</i>	(2 unit x 3.789)	7.578
Legs <i>Patas</i>	(8 units x 253)	2.024
Prism lateral <i>Lateral prisma</i>	(2 units x 338)	676
Flat top <i>Top liso</i>	(4 units x 295)	1.180
TOTAL		11.458

PACKAGING

	PCS	DIMENSIONS CM	GROSS KG
Module / <i>Módulo 120</i>	2	138 x 67 x 82	188
Legs / <i>Patas</i>	1	60 x 50 x 50	18

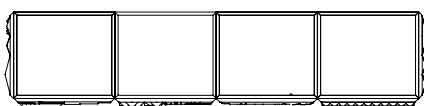

*Delivery in 3 weeks / *Entrega en 3 semanas*

MULTILEG SHOWTIME CABINET

Jaime Hayon

Modules and doors in MDF and lacquered high-gloss, matte or veneered in varnished walnut nature effect. The interior finish is matte for the lacquered version and veneered for the walnut nature effect option. Legs in solid turned alder-wood, lacquered in high-gloss or matte or stained in a walnut colour. Drawers with metallic laterals with lengths of half a module, a module or a drawer with the bottle holder. The drawer handles and bottle holder finish are in a brass finish.

Tops: 1cm glass painted, MDF veneered walnut nature effect or 2cm thick marble.

Four finishes available:

Matte lacquered with glass top / Gloss lacquered with glass top / Gloss lacquered with marble top / Walnut nature effect with walnut top.

Contenedor y frontales en MDF lacado en mate o brillo, o chapado en nogal barnizado efecto nature. Interior siempre en laca mate o chapado en nogal barnizado efecto nature. Patas en aliso macizo torneado, lacado en mate o brillo, o teñido color nogal.

Cajones con lateral metálico individuales, dobles o con sistema de botellero. Los tiradores y el botellero son cobreados.

Sobres: vidrio de 1cm pintado, en MDF chapado en nogal barnizado efecto nature o en mármol de 2cm.

Cuarto opciones de acabado:

Laca mate con sobre vidrio / Laca brillo con sobre vidrio / Laca brillo con sobre mármol / Nogal barnizado efecto nature con sobre nogal.

MODELS / MODELOS

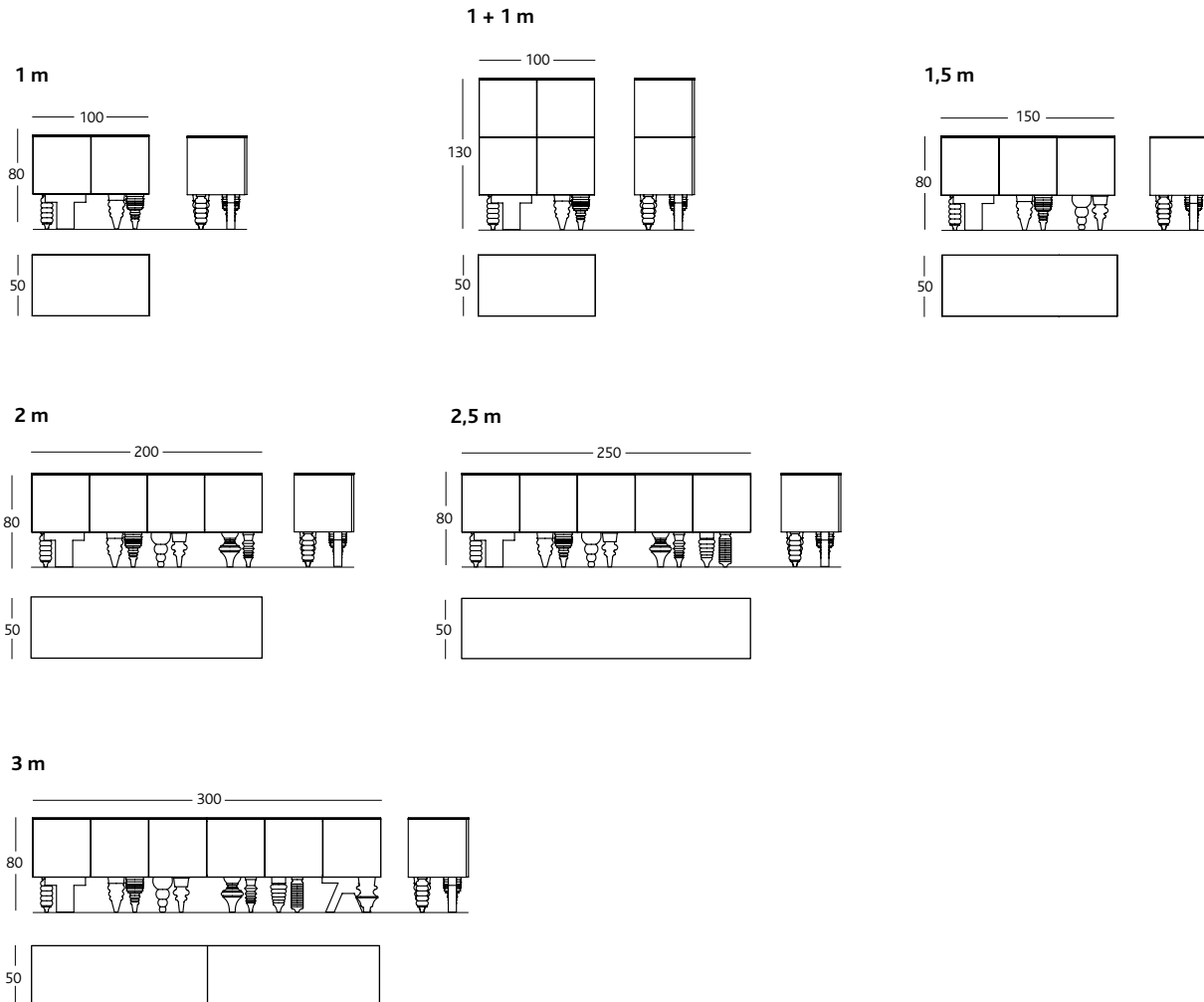

EXAMPLES / EJEMPLOS MULTILEG CABINET

Example / Ejemplo 1 (1 m)

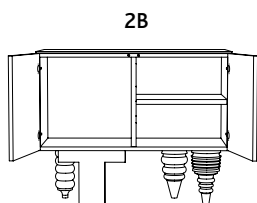

PACKAGING

	PCS	DIMENSIONS CM	GROSS KG
Glass top + module + legs / Sobre vidrio + módulo + patas	1	120 x 80 x 110	116
Walnut top + module + legs / Sobre nogal + módulo + patas	1	120 x 80 x 110	109
Marble top + module + legs / Sobre mármol + módulo + patas	1	120 x 80 x 110	133

		Matte Mate	High Gloss Brillante	Walnut Nogal	High Gloss Brillante
TOP / SOBRE		Glass Vidrio	Glass Vidrio	Walnut Nogal	Marble Mármol
Module 2B	1 un	2.288	2.352	2.635	2.352
Top / sobre 1m	1 un	524	524	322	970
Legs / patas	4 un	1.020	1.020	1.276	1.020
TOTAL		3.832	3.896	4.233	4.342

Example / Ejemplo 2 (1 + 1 m)

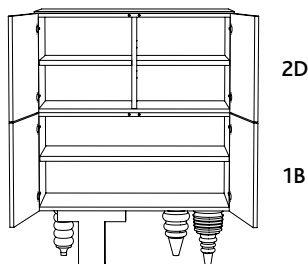

PACKAGING

	PCS	DIMENSIONS CM	GROSS KG
Glass top + modules + legs / Sobre vidrio + módulos + patas	1	120 x 80 x 159	175
Walnut top + modules + legs / Sobre nogal + módulos + patas	1	120 x 80 x 159	168
Marble top + modules + legs / Sobre mármol + módulos + patas	1	120 x 80 x 159	192

		Matte Mate	High Gloss Brillante	Walnut Nogal	High Gloss Brillante
TOP / SOBRE		Glass Vidrio	Glass Vidrio	Walnut Nogal	Marble Mármol
Module 2D	1 un	2.391	2.455	2.751	2.455
Module 1B	1 un	2.282	2.346	2.616	2.346
Top / sobre 1m	1 un	524	524	322	970
Legs / patas	4 un	1.020	1.020	1.276	1.020
TOTAL		6.217	6.345	6.965	6.791

*All vertically mounted double modules should always be fixed to the wall
Todos los módulos dobles montados verticalmente deben fijarse siempre a la pared.

Example / Ejemplo 3 (1,5 m)

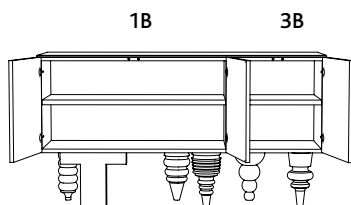

PACKAGING

	PCS	DIMENSIONS CM	GROSS KG
Glass top / Sobre vidrio	1	165 x 50 x 72	44
Walnut top / Sobre nogal	1	165 x 50 x 72	31
Marble top / Sobre mármol	1	165 x 50 x 72	65
Modules + 6 legs / Módulos + 6 patas	1	120 x 80 x 130	120

		Matte Mate	High Gloss Brillante	Walnut Nogal	High Gloss Brillante
TOP / SOBRE		Glass Vidrio	Glass Vidrio	Walnut Nogal	Marble Mármol
Module 1B	1 un	2.282	2.346	2.616	2.346
Module 3B	1 un	1.549	1.581	1.755	1.581
Top / sobre 1,5m	1 un	782	782	436	1.238
Legs / patas	6 un	1.530	1.530	1.914	1.530
TOTAL		6.143	6.239	6.721	6.695

EXAMPLES / EJEMPLOS MULTILEG CABINET

Example / Ejemplo 4 (2 m)

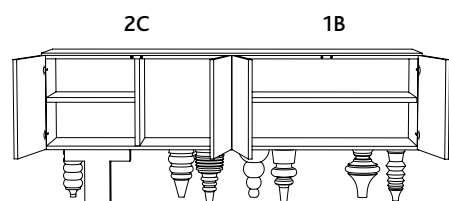

PACKAGING

	PCS	DIMENSIONS CM	GROSS KG
Glass top / Sobre vidrio	1	212 x 50 x 72	58
Walnut top / Sobre nogal	1	212 x 50 x 72	42
Marble top / Sobre mármol	1	212 x 50 x 72	90
Modules + 8 legs / Módulos + 8 patas	1	120 x 80 x 165	151

		Matte Mate	High Gloss Brillante	Walnut Nogal	High Gloss Brillante
TOP / SOBRE		Glass Vidrio	Glass Vidrio	Walnut Nogal	Marble Mármol
Module 2C	1 un	2.288	2.352	2.635	2.352
Module 1B	1 un	2.282	2.346	2.616	2.346
Top / sobre 2m	1 un	1.043	1.043	586	1.750
Legs / patas	8 un	2.040	2.040	2.552	2.040
TOTAL		7.653	7.781	8.389	8.488

Example / Ejemplo 5 (2,5 m)

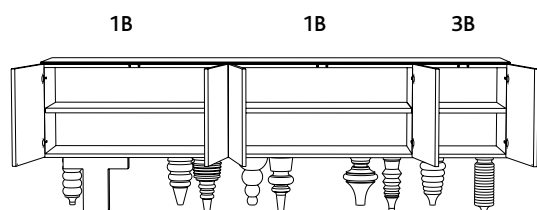

PACKAGING

	PCS	DIMENSIONS CM	GROSS KG
Glass top / Sobre vidrio	1	262 x 50 x 72	88
Walnut top / Sobre nogal	1	262 x 50 x 72	62
Marble top / Sobre mármol	1	262 x 50 x 72	130
Module 1B / Módulo 1B	1	120 x 80 x 190	135
Module 3B + 10 legs / Módulo 3B + 10 patas	1	60 x 40 x 102	60

		Matte Mate	High Gloss Brillante	Walnut Nogal	High Gloss Brillante
TOP / SOBRE		Glass Vidrio	Glass Vidrio	Walnut Nogal	Marble Mármol
Module 1B	2 un	4.564	4.692	5.232	4.692
Module 3B	1 un	1.549	1.581	1.755	1.581
Top / sobre 2,5m	1 un	1.318	1.318	764	2.401
Legs / patas	10 un	2.550	2.550	3.190	2.550
TOTAL		9.981	10.141	10.941	11.224

Example / Ejemplo 6 (3 m)

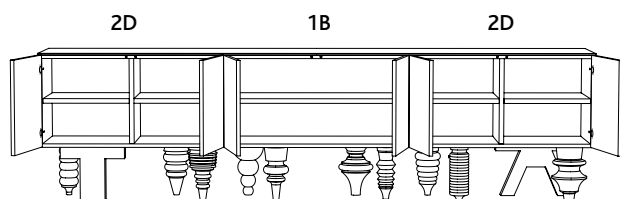

PACKAGING

	PCS	DIMENSIONS CM	GROSS KG
Glass top / Sobre vidrio	2	163 x 50 x 72	44
Walnut top / Sobre nogal	1	312 x 50 x 72	62
Marble top / Sobre mármol	2	163 x 50 x 72	65
Module 1B + 12 legs / Módulo 1B + 12 patas	1	120 x 80 x 120	104
Modules 2D / Módulos 2D	1	120 x 80 x 130	151

		Matte Mate	High Gloss Brillante	Walnut Nogal	High Gloss Brillante
TOP / SOBRE		Glass Vidrio	Glass Vidrio	Walnut Nogal	Marble Mármol
Module 2D	2 un	4.782	4.910	5.502	4.910
Module 1B	1 un	2.282	2.346	2.616	2.346
Top / sobre 1,5m	2 un	1.564	1.564	879*	2.476
Legs / patas	12 un	3.060	3.060	3.828	3.060
TOTAL		11.688	11.880	12.825	12.792

*Top / sobre 3m (1 un)



EXAMPLES FULL EQUIPMENT / EJEMPLOS EQUIPO COMPLETO MULTILEG CABINET

Example / Ejemplo 7 (2 m)

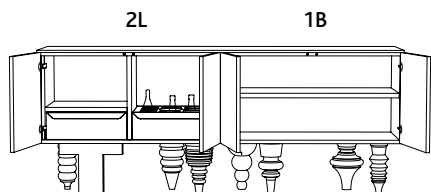

PACKAGING

	PCS	DIMENSIONS CM	GROSS KG
Glass top / Sobre vidrio	1	212 x 50 x 72	58
Walnut top / Sobre nogal	1	212 x 50 x 72	42
Marble top / Sobre mármol	1	212 x 50 x 72	90
Modules + 8 legs / Módulos + 8 patas	1	120 x 80 x 165	172

	Matte Mate	High Gloss Brillante	Walnut Nogal	High Gloss Brillante
--	---------------	-------------------------	-----------------	-------------------------

TOP / SOBRE		Glass Vidrio	Glass Vidrio	Walnut Nogal	Marble Mármol
Module 2L	1 un	4.138	4.202	4.603	4.202
Module 1B	1 un	2.173	2.234	2.491	2.234
Top / sobre 2m	1 un	965	965	543	1.620
Legs / patas	8 un	1.888	1.888	2.360	1.888
TOTAL		9.164	9.289	9.997	9.944

Example / Ejemplo 8 (2,5 m)

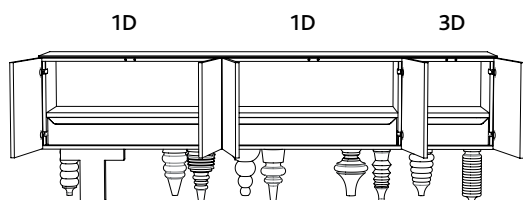

PACKAGING

	PCS	DIMENSIONS CM	GROSS KG
Glass top / Sobre vidrio	1	262 x 50 x 72	72
Walnut top / Sobre nogal	1	262 x 50 x 72	52
Marble top / Sobre mármol	1	262 x 50 x 72	110
Modules 1D / Módulos 1D	1	120 x 80 x 190	177
Module 3D + 10 legs / Módulo 3D + 10 patas	1	60 x 40 x 102	71

	Matte Mate	High Gloss Brillante	Walnut Nogal	High Gloss Brillante
--	---------------	-------------------------	-----------------	-------------------------

TOP / SOBRE		Glass Vidrio	Glass Vidrio	Walnut Nogal	Marble Mármol
Module 1D	2 un	5.746	5.874	6.482	5.874
Module 3D	1 un	2.130	2.163	2.388	2.163
Top / sobre 2,5m	1 un	1.220	1.220	708	2.224
Legs / patas	10 un	2.360	2.360	2.950	2.360
TOTAL		11.456	11.617	12.528	12.621

Example / Ejemplo 9 (3 m)

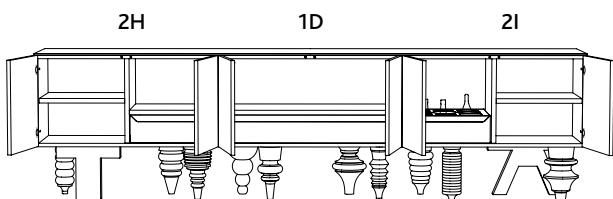

PACKAGING

	PCS	DIMENSIONS CM	GROSS KG
Glass top / Sobre vidrio	2	163 x 50 x 72	44
Walnut top / Sobre nogal	1	312 x 50 x 72	62
Marble top / Sobre mármol	2	163 x 50 x 72	65
Module 2I + 12 legs / Módulo 2I + 12 patas	1	120 x 80 x 120	114
Modules 2H + 1D / Módulos 2H + 1D	1	120 x 80 x 130	167

	Matte Mate	High Gloss Brillante	Walnut Nogal	High Gloss Brillante
--	---------------	-------------------------	-----------------	-------------------------

TOP / SOBRE		Glass Vidrio	Glass Vidrio	Walnut Nogal	Marble Mármol
Module 2H	1 un	3.079	3.144	3.505	3.144
Module 1D	1 un	2.873	2.937	3.241	2.937
Module 2I	1 un	3.460	3.525	3.860	3.525
Top / sobre 1,5m	2 un	1.448	1.448	814*	2.294
Legs / patas	12 un	2.832	2.832	3.540	2.832
TOTAL		13.692	13.886	14.960	14.732

*Top / sobre 3m (1 un)

MULTILEG SHOWTIME CABINET FINISHES / ACABADOS

LACQUERS / LACAS

High Gloss lacquer <i>Lacas brillo</i>	LAC04 - White / <i>Blanco</i> RAL 9003
	LAC09 - Blue / <i>Azul</i> RAL 5002
	LAC10 - Black / <i>Negro</i> RAL 9005
	B31 - White / <i>Blanco</i> RAL 9016
	B32 - Blue / <i>Azul</i> RAL 5011
	B33 - Green / <i>Verde</i> RAL 6021
Matte lacquer <i>Laca mate</i>	LACM04 - White / <i>Blanco</i> RAL 9003
	LACM09 - Blue / <i>Azul</i> RAL 5002
	LACM10 - Black / <i>Negro</i> RAL 9005

MARBLE TOP / SOBRE MÁRMOL

Marble tops <i>Sobres mármol</i>	Green / <i>Verde</i> Patrizia
	White / <i>Blanco</i> Carrara Venato
	Black / <i>Negro</i> Marquina













WALNUT / NOGAL

Walnut Nature <i>Effect Nogal</i> <i>Efecto Nature</i>	NG EN
---	-------

- Special colours according to RAL chart.
- Custom colour +10 % (minimum 2 boxes).

- Colores especiales según carta RAL.
- Color cliente +10% (mínimo 2 cajas).

CONFIGURE YOUR OWN MULTILEG CABINET / CONFIGURA TU MULTILEG CABINET

TOPS / SOBRES	Glass <i>Vidrio</i>	Walnut <i>Nogal</i>	Marble <i>Mármol</i>	LEGS / PATAS	Matte <i>Mate</i>	Gloss <i>Brillo</i>	Walnut <i>Nogal</i>		
L. 1 m	524	322	970	Unit / <i>Unidad</i>	255	255	319		
L. 1,5 m	782	436	1.238						
L. 2 m	1.043	586	1.750	 n°1	 n°2	 n°3	 n°4	 n°5	 n°6
L. 2,5 m	1.318	764	2.401	 n°7	 n°8	 n°9	 n°10	 n°11	 n°12
L. 3 m (only in walnut / <i>solo en nogal</i>)		879							

CONFIGURATION MODELS / MODELOS DE CONFIGURACIÓN

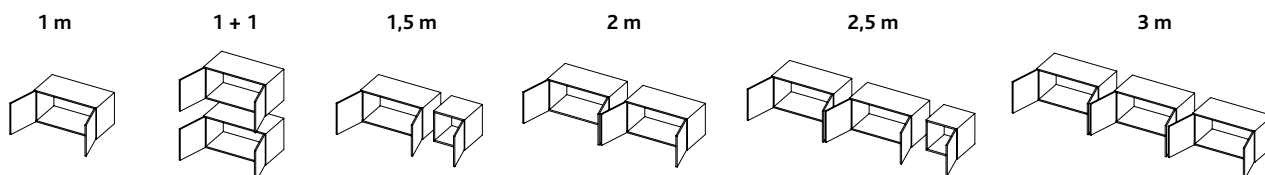

INTERIOR OPTION / OPCIÓN INTERIOR

Module / Módulo 1m			Matte Mate	High Gloss Brillo	Walnut Nogal
		1 A Basic / Básico	2.153	2.218	2.487
		1 B Horizontal shelf / Estante horizontal	2.282	2.346	2.616
		1 D Double Drawer / Cajón doble	3.016	3.084	3.403
		2 A Vertical divider / División vertical	2.185	2.250	2.520
		2 B Shelf Right / Estante derecha	2.288	2.352	2.635
		2 C Shelf left / Estante izquierda	2.288	2.352	2.635
		2 D Vertical divider and shelves / División vertical y estantes	2.391	2.455	2.751
		2 G Single Drawer + Shelf Right / Cajón + Estante Derecho	3.233	3.301	3.681
		2 H Single Drawer + Shelf Left / Cajón + Estante Izquierdo	3.233	3.301	3.681
		2 I Shelf right + Bottle Drawer / Estante Derecho + botellero	3.633	3.701	4.053
		2 J Shelf Left + Bottle Drawer / Estante Izquierdo + botellero	3.633	3.701	4.053
		2 K Single Drawer + Bottle Drawer / Cajón + botellero	4.345	4.413	4.833
		2 L Single Drawer + Bottle Drawer / Cajón + botellero	4.345	4.413	4.833
		2 M Shelf Right + 3 Drawers Left / Estante Der. + 3 cajones Izq.	4.548	4.616	5.118
		2 N Shelf Left + 3 Drawers Right / Estante Izq. + 3 cajones Der.	4.548	4.616	5.118
					
Module / Módulo 0,5m			Matte Mate	High Gloss Brillo	Walnut Nogal
		3 A Without shelf / Sin estante	1.446	1.478	1.639
		3 B Horizontal shelf / Estante horizontal	1.549	1.581	1.755
		3 D Single Drawer / Cajón individual	2.237	2.271	2.508
		3 F 3 Drawers / Cajones	3.660	3.694	4.067

TABLES
MESASARMCHAIRS
BUTACASCHAIRS AND STOOLS
SILLAS Y TABURETESACCESSORIES
ACCESORIOSLIGHTING
ILUMINACIÓNPUBLIC SEATING
ASIENTOS PÚBLICOS

ART EDITIONS

SHANTY CABINET

Doshi Levien

Modules in MDF fibreboard with a lacquered matte finish. Modules are joined together using a mechanical fixing system. Doors in MDF fibreboard with a mechanised waveform frontal and matte lacquered finish. 8mm painted glass top. Octagonal legs made of extruded anodised gold aluminium. Structure in tubular steel with welded strips to assemble legs. Steel structure painted in black or white satin polyester.

Contenedores en MDF lacados en mate. Fijados mediante sistema mecánico. Puertas fabricadas en MDF lacadas mate con frontales mecanizados en forma de onda. Vidrio pintado de 8mm. Patas octogonales fabricadas en aluminio extrusionado anodizado en dorado. Estructura de acero pintada en poliester satinado negro o blanco.

Shanty Small

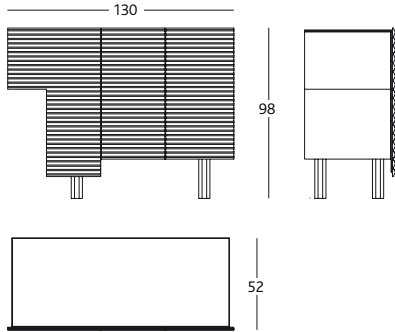

Summer / Winter Verano / Invierno

Shanty Small / Shanty pequeño	5.152
Model A: double folding door <i>Modelo A: doble puerta abatible</i>	8.345
Model B: folding door + drawers <i>Modelo B: puerta abatible + cajones</i>	9.499

Model A

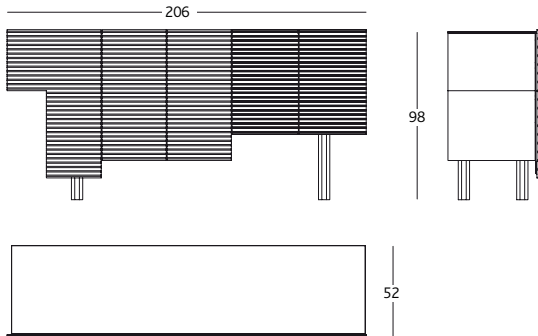

Model B

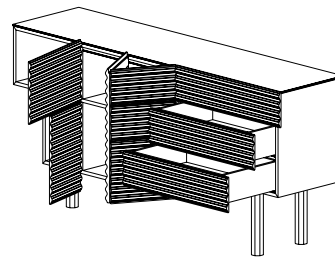
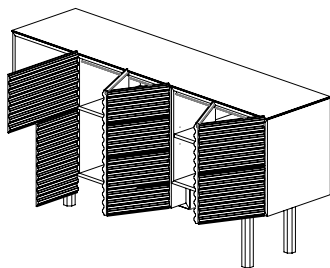
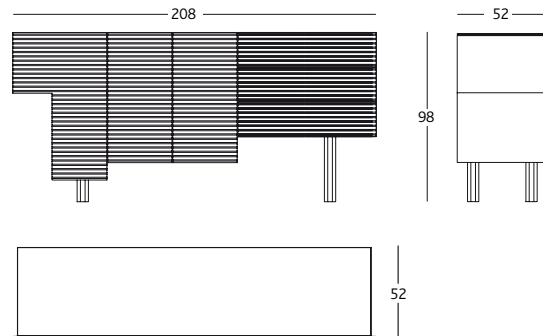

Summer: Multicolour
Verano: Multicolor

Winter: Grey & white
Invierno: Gris y blanco

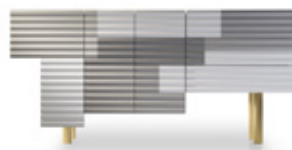

PACKAGING

	PCS	DIMENSIONS CM	GROSS KG
Module / Módulo Model A	1	120 x 100 x 190	150
Module / Módulo Model B	1	120 x 100 x 190	166
Glass / Vidrio	1	215 x 50 x 70	45
Module Small / Módulo pequeño	1	135 x 80 x 85	112
Glass Small / Vidrio pequeño	1	160 x 50 x 70	44

PERISTYLO

Oscar Tusquets

Shelving and base in solid ash wood and turned vertical supports in stained black wood.

Estantes y base en fresno macizo y soportes verticales en fresno macizo torneados, acabado en teñido negro.

MODELS / MODELOS

With baseboard / Con zócalo

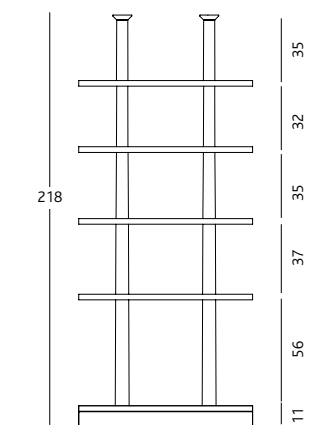
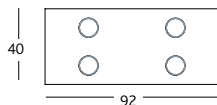

4 shelves / baldas € 5.493

50 kg
(x1) 60 x 40 x 45 cm
(x1) 100 x 50 x 40 cm

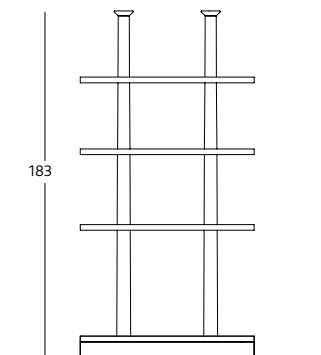

3 shelves / baldas € 4.512

45 kg
(x1) 60 x 40 x 45 cm
(x1) 100 x 50 x 40 cm

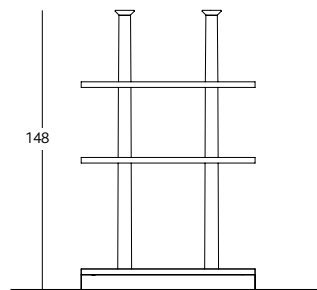

2 shelves / baldas € 3.530

40 kg
(x1) 60 x 40 x 30 cm
(x1) 100 x 50 x 25 cm

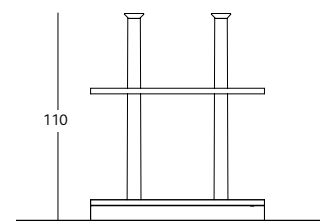

1 shelf / balda € 2.524

35 kg
(x1) 60 x 40 x 25 cm
(x1) 100 x 50 x 20 cm

Without baseboard / Sin zócalo

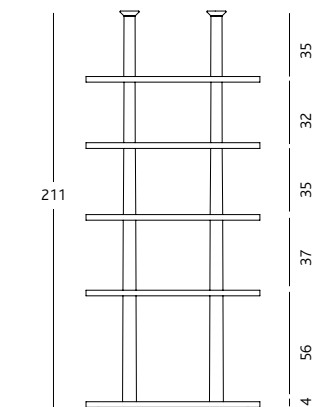
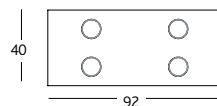

4 shelves / baldas € 5.071

45 kg
(x1) 60 x 40 x 45 cm
(x1) 100 x 50 x 30 cm

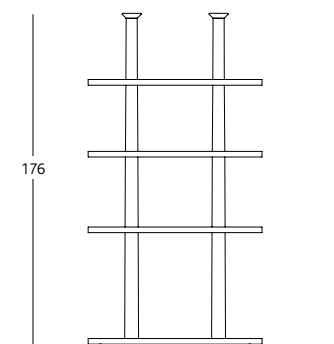

3 shelves / baldas € 4.090

40 kg
(x1) 60 x 40 x 45 cm
(x1) 100 x 50 x 30 cm

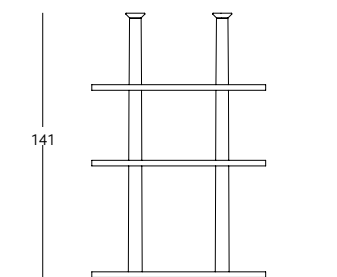

2 shelves / baldas € 3.108

35 kg
(x1) 60 x 40 x 30 cm
(x1) 100 x 50 x 30 cm

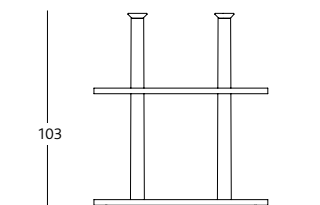

1 shelf / balda € 2.102

30 kg
(x1) 60 x 40 x 25 cm
(x1) 100 x 50 x 15 cm

Example / Ejemplo 1

Example 1

16.059

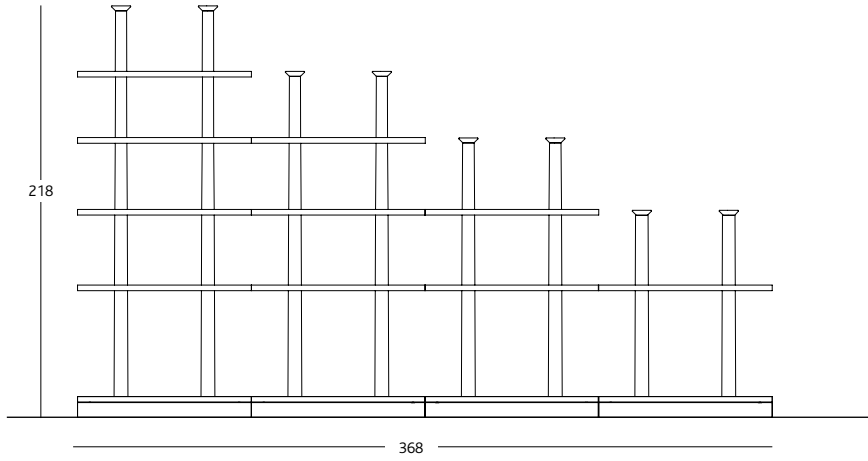

Example / Ejemplo 2

Example 2

6.306

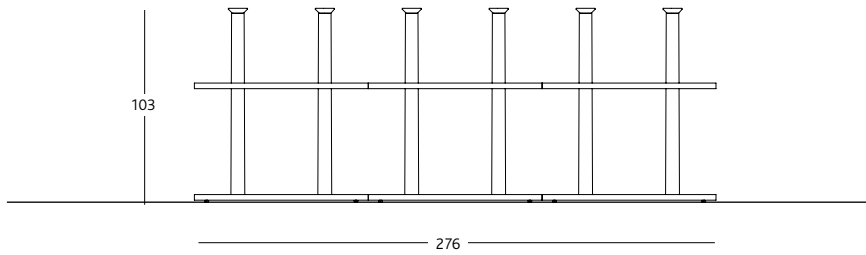

Example / Ejemplo 3

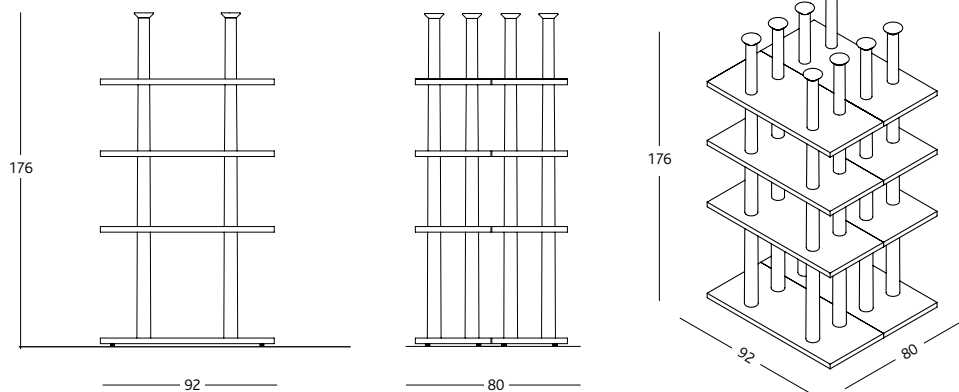

Example 3

8.180

TABLES
MESAS

ARMCHAIRS
BUTACAS

CHAIRS AND STOOLS
SILLAS Y TABURETES

Example / Ejemplo 4

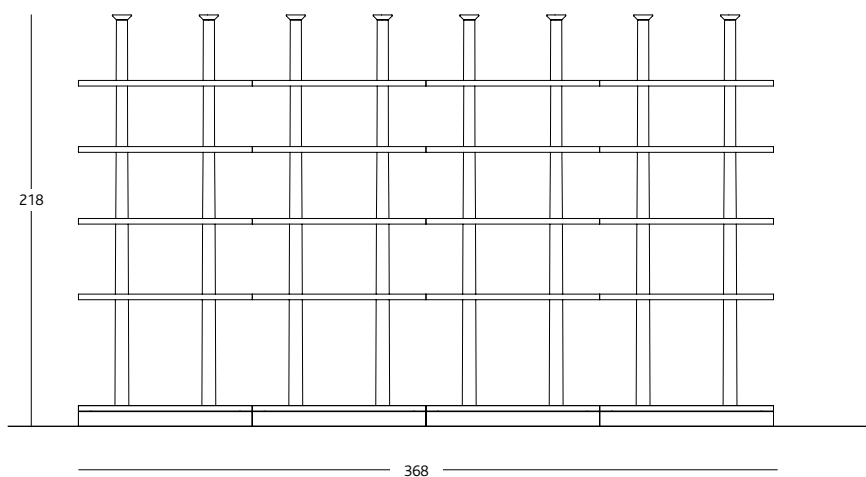

Example 4

21.972

ACCESSORIES
ACCESORIOS

LIGHTING
ILUMINACIÓN

PUBLIC SEATING
ASIENTOS PÚBLICOS

ART EDITIONS

HYPÓSTILA

Lluís Clotet & Oscar Tusquets

Shelves and vertical supports in extruded aluminium, brushed and anodised silver or black. Fixing metalwork in zincated iron. Feet in cast aluminium anodised silver or black. Screws in stainless steel.

The maximum distance between vertical supports for flat shelves is 150cm, 100cm for bar shelves, and 90cm for MDF shelves and tables.

Estantes y soporte vertical en extrusión de aluminio, cepillado y anodizado plata o negro. Herrajes de sujeción en hierro zincado. Pie en fundición de aluminio anodizada plata o negro. Tornillería en acero inoxidable.

La distancia máxima entre soportes verticales para estantes planos será de 150 cm. Para estantes de barras será de 100 cm. Para estantes o mesas de MDF será de 90 cm.



PARTS / PIEZAS

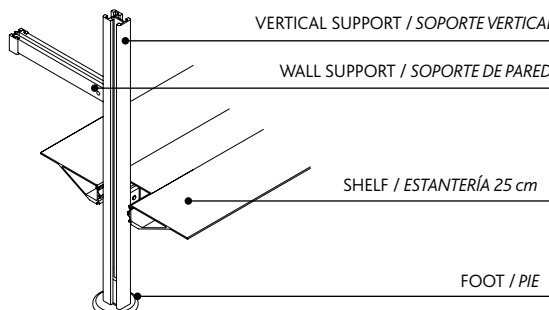
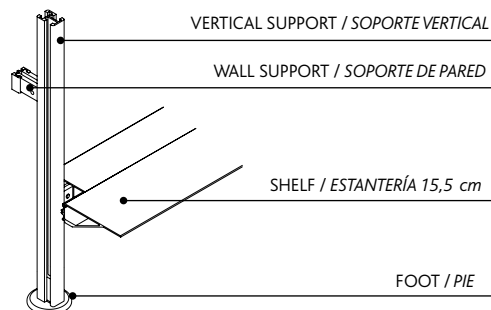

SHELVES / ESTANTES

SHELF / ESTANTE 15,5 cm	HY0844	Silver / Plata	154/m
	HY0855	Black / Negro	154/m

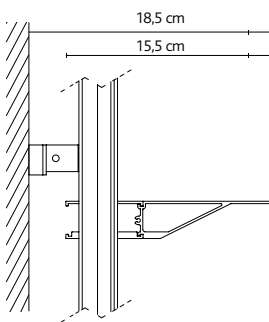
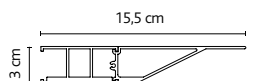

- Maximum bearing weight: 40Kg/LM. Equally distributed cargo weight.
- Maximum length: 250cm per shelf. Multiple pieces can be combined to obtain lengths longer than 250cm.
- The cost of the Hypóstila shelves will be calculated in multiples of 50cm, taking into account the total length of shelves ordered.

- Capacidad máxima: 40kg/m. Carga repartida.
- Longitud máxima: 250cm de una sola pieza. Se pueden combinar múltiples piezas para obtener longitudes superiores a 250cm.
- El coste de los estantes Hypóstila se efectuará a razón de múltiplos de 50cm teniendo en cuenta la suma total de los estantes de la composición.

WITHOUT CANTILEVER
SIN VOLADIZO

WITH CANTILEVER
CON VOLADIZO

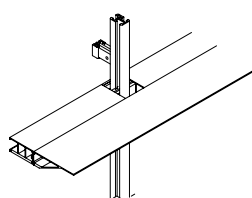
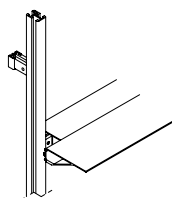

SHELF / ESTANTE 25 cm	HY0845	Silver / Plata	217/m
	HY0854 <td>Black / Negro</td> <th>217/m</th>	Black / Negro	217/m

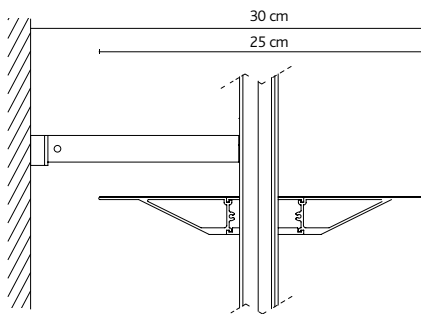

- Maximum bearing weight: 60Kg/LM. Equally distributed cargo weight.
- Maximum length: 250cm per shelf. Multiple pieces can be combined to obtain lengths longer than 250cm.
- The cost of the Hypóstila shelves will be calculated in multiples of 50cm, taking into account the total length of shelves ordered.

- Capacidad máxima: 60kg/m. Carga repartida.
- Longitud máxima: 250cm de una sola pieza. Se pueden combinar múltiples piezas para obtener longitudes superiores a 250cm.
- El coste de los estantes Hypóstila se efectuará a razón de múltiplos de 50cm teniendo en cuenta la suma total de los estantes de la composición.

WITHOUT CANTILEVER
SIN VOLADIZO

WITH CANTILEVER
CON VOLADIZO

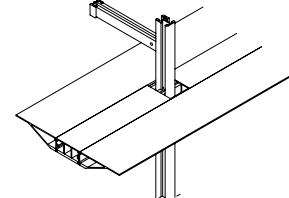
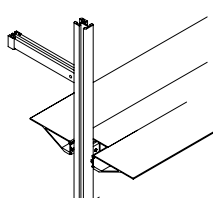

ROUND CORNER / ESQUINA REDONDEADA

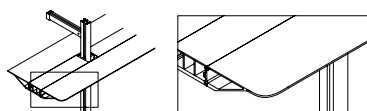

- The corners to be rounded must be indicated.
- Las esquinas a redondear deben ser indicadas.

HY0846	Rounded corner (each) / Esquina redondeada (cada una)	8
--------	---	---



VERTICAL STRUCTURE / ESTRUCTURA VERTICAL

Vertical structure for 15,5 cm shelf
Estructura vertical para estantes de 15,5 cm

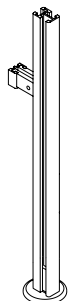

HY0838	Silver / Plata	2m	125€
HY0856	Black / Negro		
HY0839	Silver / Plata	3m	182€
HY0857	Black / Negro		
HY0840	Silver / Plata	4m	226€
HY0858	Black / Negro		

Vertical structure for 25 cm shelf
Estructura vertical para estantes de 25 cm

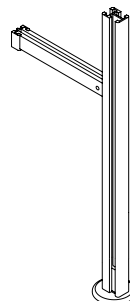

HY0841	Silver / Plata	2m	125€
HY0847	Black / Negro		
HY0842	Silver / Plata	3m	182€
HY0848	Black / Negro		
HY0843	Silver / Plata	4m	226€
HY0849	Black / Negro		

- Maximum height: 400cm.
- The cost of the Hypóstila vertical structure is calculated based on the highest measurement of the post.

- *Altura máxima: 400cm.*
- *El coste de la estructura vertical Hypóstila se calculará en base a la medida superior de poste.*

DIMENSIONAL CONSTRAINTS / RESTRICCIONES DIMENSIONALES

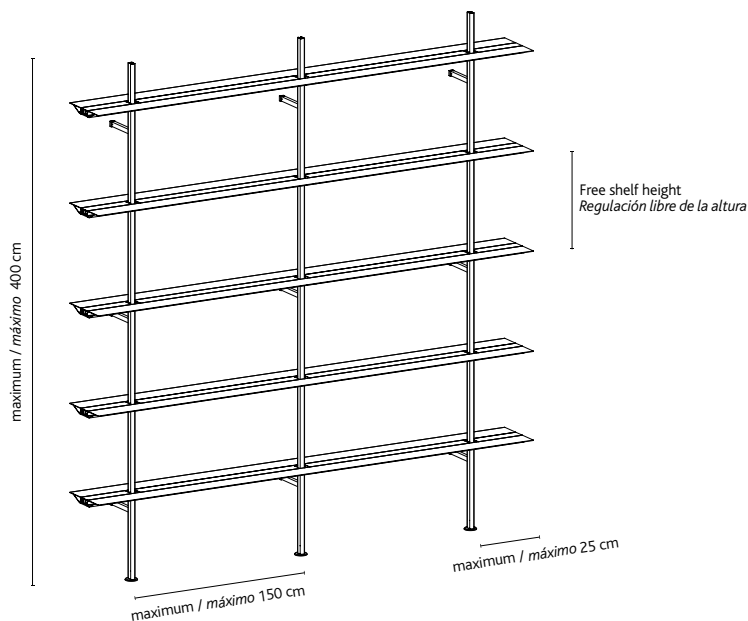

**FREE SHELF HEIGHT ADJUSTMENT
REGULACIÓN LIBRE DE LA ALTURA DE LOS ESTANTES**

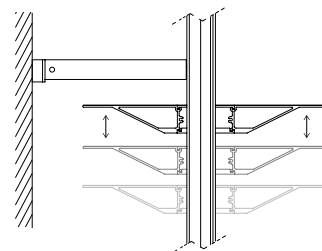

**ADJUSTMENT MECHANISM
MECANISMO DE REGULACIÓN**

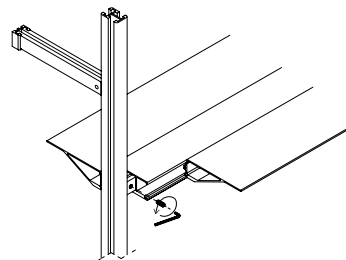

HYPÓSTILA II - BAR SHELF (until stocks last / hasta agotar existencias)

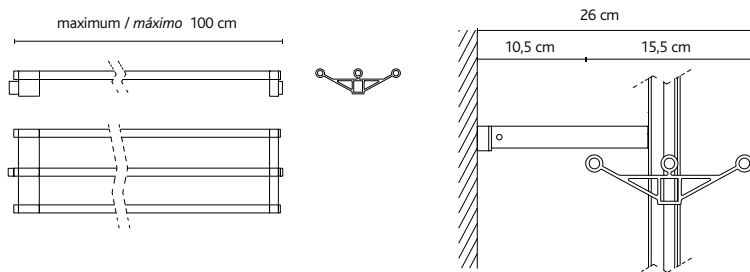

From 0 to 100cm
De 0 a 100cm

Bar shelf / Estantería de barras

121€

HYPÓSTILA EXAMPLES / EJEMPLOS (Silver finish / Acabado plata)

EXAMPLE / EJEMPLO 1

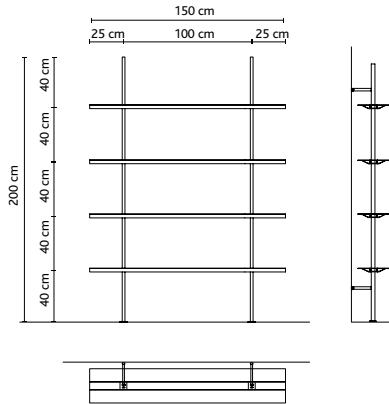

Vertical structure 2m <i>Estructura vertical 2m</i>	200cm (x2)	125 (x2)	250
Shelf 25cm <i>Estantería 25cm</i>	150cm (x4) = 6m	217 x 6m	1.302
TOTAL			1.552

30 kg
 (x1) 8 x 10 x 210 cm (0.02 m³)
 (x2) 13 x 12 x 160 cm (0.02 m³)
 (x1) 10 x 8 x 160 cm (0.01 m³)
 (x1) 18 x 18 x 13 cm (0.004 m³)

EXAMPLE / EJEMPLO 2

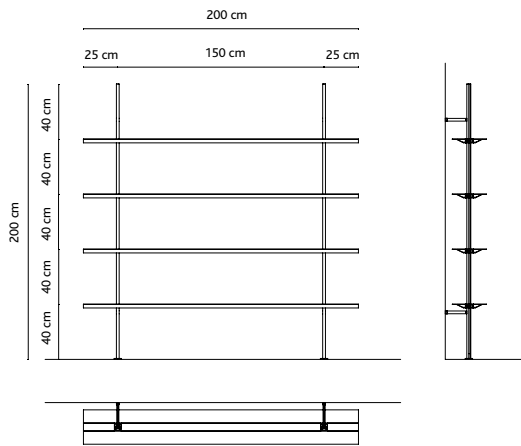

Vertical structure 2m <i>Estructura vertical 2m</i>	200cm (x2)	125 (x2)	250
Shelf 25cm <i>Estantería 25cm</i>	200cm (x4) = 8m	217 x 8m	1.736
TOTAL			1.986



Delivery in 2 weeks. Consult conditions.
Entrega en 2 semanas. Consultar condiciones.

30 kg
 (x1) 8 x 10 x 210 cm (0.02 m³)
 (x2) 13 x 12 x 210 cm (0.02 m³)
 (x1) 10 x 8 x 210 cm (0.01 m³)
 (x1) 18 x 18 x 13 cm (0.004 m³)

EXAMPLE / EJEMPLO 3

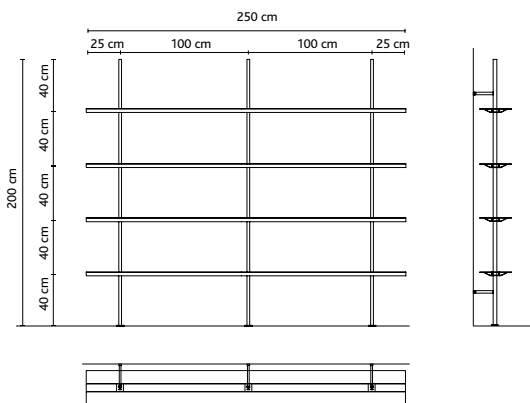

Vertical structure 2m <i>Estructura vertical 2m</i>	200cm (x3)	125 (x3)	375
Shelf 25cm <i>Estantería 25cm</i>	250cm (x4) = 10m	217 x 10m	2.170
TOTAL			2.545

47 kg
 (x1) 16 x 9 x 210 cm (0.03 m³)
 (x2) 13 x 12 x 260 cm (0.04 m³)
 (x1) 10 x 8 x 260 cm (0.02 m³)
 (x1) 18 x 18 x 13 cm (0.004 m³)

- The cost of the Hypóstila vertical structure is calculated based on the highest measurement of the post.
- The cost of the Hypóstila shelves will be calculated in multiples of 50cm, taking into account the total length of shelves ordered.
- *El coste de la estructura vertical Hypóstila se calculará en base a la medida superior de poste.*
- *El coste de los estantes Hypóstila se calculará en múltiplos de 50cm, teniendo en cuenta la longitud total de las estanterías solicitadas.*

HYPÓSTILA EXAMPLES / EJEMPLOS (Silver finish / Acabado plata)

EXAMPLE / EJEMPLO 4

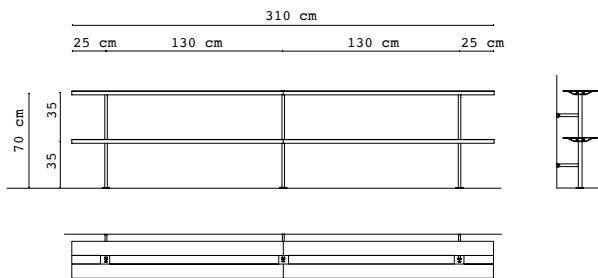

Vertical structure 2m <i>Estructura vertical 2m</i>	70cm (x3)	125 (x3)	375
	310cm (x2) = 6,2m	217 x 6,5m	1.410
TOTAL			1.785

30 kg
 (x1) 8x10x91 cm (0.007m³)
 (x3) 17x15x165 cm (0.04m³)
 (x1) 18x18x13 cm (0.004m³)

TABLES
MESAS

ARMCHAIRS
BUTACAS

EXAMPLE / EJEMPLO 5

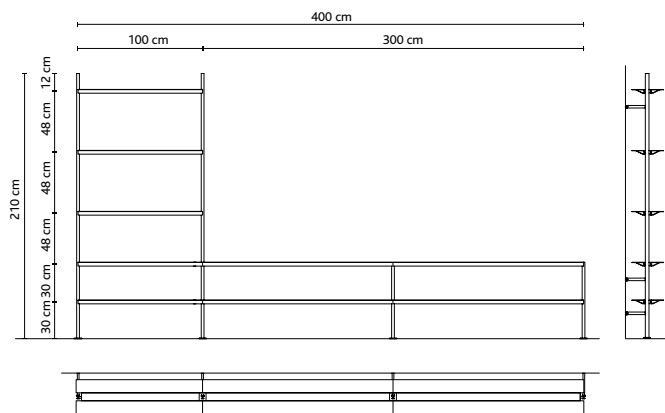

Vertical structure 2m & 3m <i>Estructura vertical 2m y 3m</i>	210cm (x2) 60cm (x2)	182 (x2) 125 (x2)	364 250
Shelf 25cm <i>Estantería 25cm</i>	100cm (x3)=3m 400cm (x2)=8m	217 x 11m	2.387
TOTAL			3.001

50 kg
 (x1) 8 x 10 x 220 cm (0.02 m³)
 (x3) 15 x 16 x 160 cm (0.04 m³)
 (x2) 12 x 8 x 160 cm (0.02 m³)
 (x1) 20 x 20 x 110 cm (0.04 m³)
 (x1) 20 x 20 x 15 cm (0.006 m³)

CHAIRS AND STOOLS
SILLAS Y TABURETES

ACCESSORIES
ACCESORIOS

EXAMPLE / EJEMPLO 6

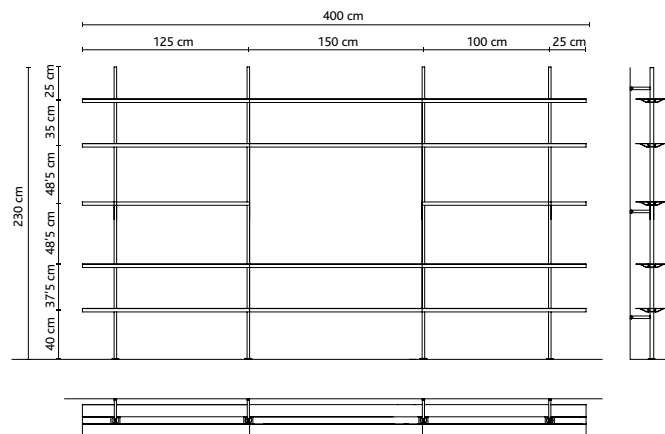

Vertical structure 3m <i>Estructura vertical 3m</i>	230cm (x4)	182 (x4)	728
Shelf 25cm <i>Estantería 25cm</i>	400cm (x4) = 16 m 125cm (x2) = 2'5 m	217 x 18'5m	4.014
TOTAL			4.742

85 kg
 (x1) 10 x 10 x 240 cm (0.02 m³)
 (x10) 13 x 12 x 160 cm (0.04 m³)
 (x1) 18 x 18 x 13 cm (0.004 m³)

LIGHTING
ILUMINACIÓN

PUBLIC SEATING
ASIENTOS PÚBLICOS

ART EDITIONS

- The cost of the Hypóstila vertical structure is calculated based on the highest measurement of the post.
- The cost of the Hypóstila shelves will be calculated in multiples of 50cm, taking into account the total length of shelves ordered.
- El coste de la estructura vertical Hypóstila se calculará en base a la medida superior de poste.
- El coste de los estantes Hypóstila se calculará en múltiplos de 50cm, teniendo en cuenta la longitud total de las estanterías solicitadas.

ESBELTA (until stocks last / hasta agotar existencias)

Lluís Clotet & Oscar Tusquets

FIXTURE FROM FLOOR TO CEILING / SOPORTE SIMPLE A TECHO

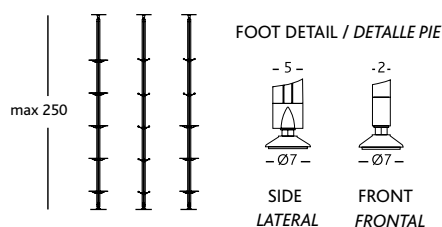

SUPPORT FOR FLAT SHELVES 25cm AND BARS 15'5cm
SOPORTE PARA ESTANTES PLANOS 25cm Y BARRAS 15'5cm

HY38501	Silver / Plata	H.2,5m - 1 un.	335
HY38601	Black Edition		

· Maximum height 250cm / Altura máxima 250cm

ESBELTA EXAMPLE / EJEMPLO

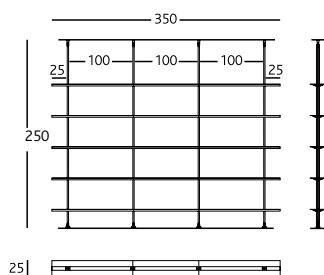

ESBELTA

HY3850	Vertical supports / Soportes verticales ESBELTA H.3m - (4u x 335€)	1.340
HY0845	Flat shelf / Estante plano HYP I, 25cm - (17'5m x 217€)	3.797
TOTAL 350 x 25 x H.250cm		5.137

HIALINA (until stocks last / hasta agotar existencias)

Lluís Clotet & Oscar Tusquets

Support in anodised silver matte aluminium hung on the wall and 6mm transparent tempered glass shelf with polished tinted edges.

Soporte en aluminio anodizado plata mate colgado a pared. Estante en vidrio transparente laminado 3+3 mm con cantos pulidos con una franja matizada.

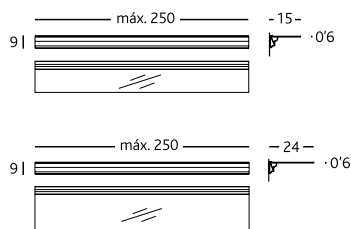

HI0786	Matte aluminium profile / LM (double support included) Perfil de aluminio mate / ML (incluye taco soporte doble)	70
HI0782	15cm transparent glass / LM Vidrio 15cm transparente / ML	184
HI0783	24cm transparent glass / LM Vidrio 24cm transparente / ML	236
HI0775	Rubber support / LM Soporte de goma / ML	6
HI0779	Black wooden side cover / (1u) (optional) Tapa lateral madera negra / (1u) (opcional)	12
HI0777	Led light kit / Kit lámpara led (optional / opcional) 1 M	190

- Luminous flux (lumens): 1.350 LM 14W/LM / T. 3.000K
- 1 Led Kit for every 50cm of shelf. Multiples of 50 cm.
- Led light kit certified by CE UNE-EN 60598-1.
- Maximum length of profile and shelf: 2.5m.
- Orders will be supplied cut to the requested length.
- Profiles and Led light kits are invoiced in multiples of 50cm.

- Flujo luminoso (lúmenes): 1.350 ML 14W / ML / T. 3.000K
- 1 Kit Led por cada 50cm de estantería. Múltiplos de 50 cm.
- Kit eléctrico led certificado por la CE UNE-EN 60598-1.
- Longitud máxima de perfil y estante: 2.5m.
- Los pedidos se entregarán cortados a la longitud solicitada.
- Los perfiles y los kits Led se facturarán en múltiplos de 50cm.

- Maximum load / Carga máxima
- 15 cm - 16 kg / LM
- 24 cm - 10 kg / LM

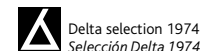

CORNISA

Lluís Clotet & Oscar Tusquets

Support and shelves in matte silver anodised aluminum, black anodised, painted white and powder coated according to RAL chart. Maximum length of one shelf is 2.5m.

Soporte y estantes en aluminio anodizado plata mate, anodizado negro, pintado blanco y pintado color cliente según carta RAL. Longitud máxima de una sola pieza 2,5m.

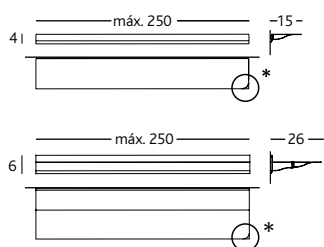

EC0760	Anodized silver / Anodizado plata	15 cm LM / ML	106
EC0761	Anodized silver / Anodizado plata	26 cm LM / ML	202
EC0762	Anodized black / Anodizado negro	15 cm LM / ML	116
EC0763	Anodized black / Anodizado negro	26 cm LM / ML	210
EC0764	Powder coated white / Pintado blanco	15 cm LM / ML	147
EC0765	Powder coated white / Pintado blanco	26 cm LM / ML	242
	Powder coated custom colour (consult RAL chart) / Pintado color cliente (consultar carta RAL)	15 cm LM / ML (min 4 m)	168
	Powder coated custom colour (consult RAL chart) / Pintado color cliente (consultar carta RAL)	26 cm LM / ML (min 2 m)	315

- Orders will be supplied cut to the requested length and invoiced in multiples of 50 cm.
- Los pedidos se servirán cortados a la medida que nos soliciten y se facturarán en múltiplos de 50cm.

Delivery in 2 weeks. Consult conditions.
Entrega en 2 semanas. Consultar condiciones.

ACCESSORIES AND EXTRAS / ACCESORIOS Y EXTRAS

HY0846	To round each corner / Redondeo voladizo en cada esquina	8
--------	--	---

*Corners to be rounded must be indicated
Las esquinas a redondear deben ser indicadas.

- Maximun load (always load distributed)
15 cm - 35 kg / LM
26 cm - 20 kg / LM
- Carga máxima (siempre carga repartida)
15 cm - 35 kg / ML
26 cm - 20 kg / ML

EXAMPLES & PRICES / EJEMPLOS Y PRECIOS	100cm	150cm	200cm	250cm
Anodized silver / Anodizado plata 15cm	106	159	212	265
Anodized silver / Anodizado plata 26cm	202	303	404	505
Anodized black / Anodizado negro 15cm	116	174	232	290
Anodized black / Anodizado negro 26cm	210	315	420	525
Powder coated white / Pintado blanco 15cm	147	221	294	368
Powder coated white / Pintado blanco 26cm	242	363	484	605

TABLES / MESAS

GAULINO

TOP in MDF veneered in ash with two finishes: natural varnished or stained black, or veneered in walnut wood varnished nature effect. The underside and edges are lacquered according to the top finish: natural ash in RAL 1001; ash stained black in RAL 9005 or ash stained in walnut.

LEGS: Solid structure in ash wood with three optional finishes: natural varnished, stained black or stained walnut.

SOBRE en MDF en fresno con dos acabados: barnizado natural o teñido en negro o chapado en nogal barnizado efecto nature. La parte inferior y el canto van lacados según el acabado del sobre: fresno natural en RAL 1001, fresno teñido en negro en RAL 9005 o teñido en color nogal.

PATAS: Estructura maciza de fresno con tres opciones diferentes: barnizado natural, teñido en negro o teñido color nogal.

Table / Mesa 240 cm

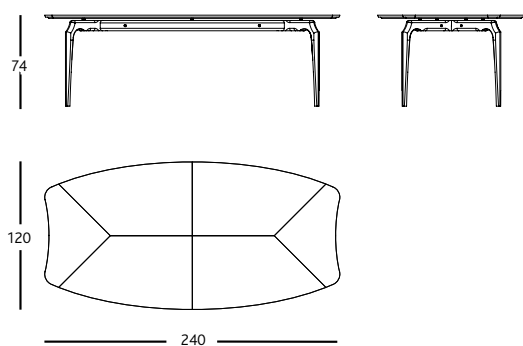

GAUM2400P13S13	Natural wood / Madera natural 240 cm	4.368
GAUM3000P13S13	Natural wood / Madera natural 300 cm	4.825
GAUM2400P10S10	Black / Negra 240 cm	4.978
GAUM3000P10S10	Black / Negra 300 cm	5.329
GAUM2400PNESNE	Walnut / Nogal 240 cm	5.155
GAUM3000PNESNE	Walnut / Nogal 300 cm	5.918

Table / Mesa 300 cm

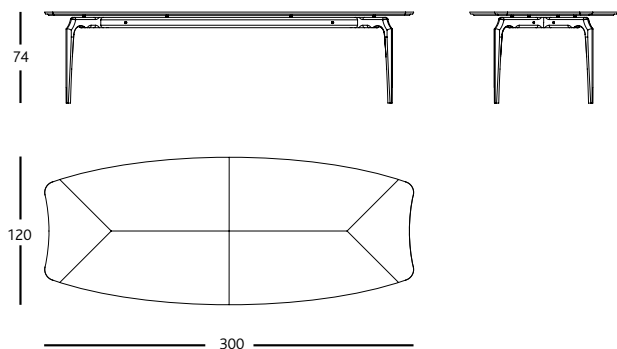

See matching chair on page 76 / Ver silla o a juego en página 76.



Delta Selection / Selección Delta 2012

PACKAGING

	PCS	DIMENSIONS CM	GROSS KG
MODEL 240			
Cross-piece (legs) / Travesaño	1	13 x 13 x 194	14
Legs / Patas	2	75 x 13 x 80	14
Wood top / Sobre madera	1	250 x 15 x 130	86
MODEL 300			
Cross-piece (legs) / Travesaño	1	15 x 17 x 252	16
Legs / Patas	2	75 x 13 x 80	14
Wood top / Sobre madera	1	311 x 15 x 130	120

CARLINA TABLES / MESAS CARLINA

Oscar Tusquets

Solid ash wooden structure, stained black. 1cm thick tempered smoked glass top.

Estructura maciza de fresno acabado en teñido negro, sobre de vidrio templado de 1cm en acabado fumé.

Carlina Dining 220

Carlina Dining 220

4.429

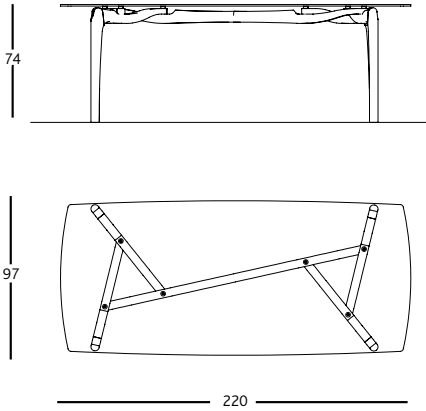

- (1x) 24 x 74 x 85cm - 10Kg
- (1x) 13x13x195 - 3Kg
- (1x) 235 x 112 x 14 - 55Kg

Carlina Dining 180

Carlina Dining 180

4.004

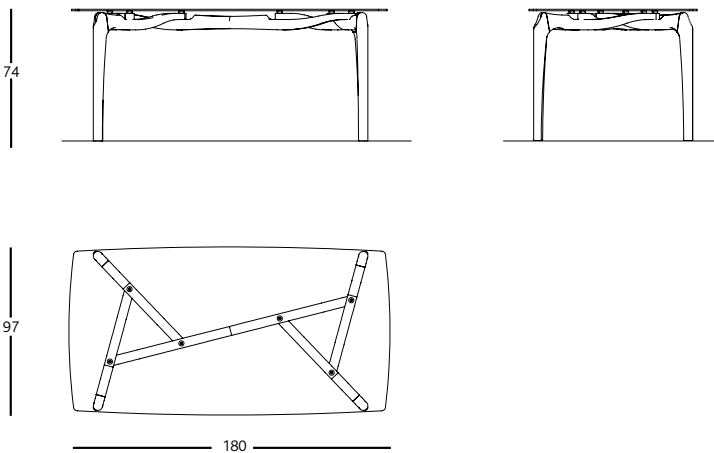

- (1x) 24 x 74 x 85cm - 8Kg
- (1x) 13x13x150 - 3Kg
- (1x) 195 x 112 x 14 - 50Kg

Carlina Dining 120

Carlina Dining 120

3.032

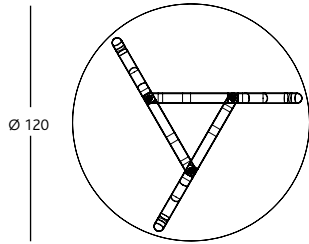
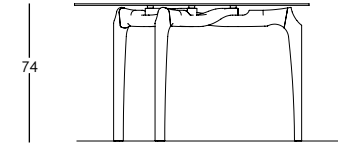

1x) 24 x 74 x 85cm - 8Kg
(1x) 133 x 133 x 14 cm - 40Kg

Carlina Side Table 40

Carlina Side Table 40

946

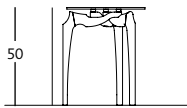

(1x) 50x50x65 cm - 12Kg

Carlina Low 120

Carlina Low 120

2.510

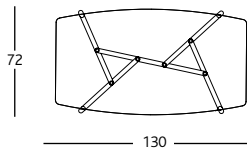
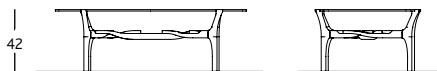

(1x) 20 x 60 x 60 cm - 3 Kg
(1x) 140 x 82 x 15 cm - 25Kg

TABLE B

Konstantin Grcic

TOP in extruded, scotch polished and anodized silver aluminium. Surface laminating available in matte from Fenix or natural oak (Oberflex).

LEGS OPTIONS

- Architectural concrete in grey with steel concrete base fastening plate painted in epoxy polyester, silver color, for both interior and exterior use.
- Solid ash stained and varnished oak wooden legs, for indoor use only.
- Rod legs in electro polished stainless steel, for both indoor and outdoor use.
- Cast painted aluminium for both indoor and outdoor use.

SOBRE en extrusión de aluminio pulido scotch y anodizado plata. La cara superior se puede chapar en estratificado mate de Fenix o en roble natural (Oberflex).

OPCIONES DE PATAS

- Hormigón arquitectónico en color gris con pletina sujeción base hormigón de acero pintado en epoxi poliéster, color plata, para uso tanto interior como exterior.
- Patas de madera maciza de fresno teñido color roble y barnizado, solo para uso interior.
- Patas de varilla en acero inoxidable electro pulido, para uso tanto interior como exterior.
- Patas en fundición de aluminio pintado, para uso tanto interior como exterior.

WIDTHS / ANCHOS

TABLE B DESK

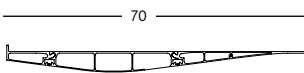

TABLE B 90

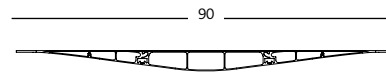

TABLE B 120

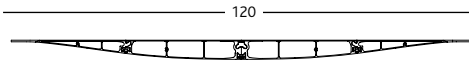
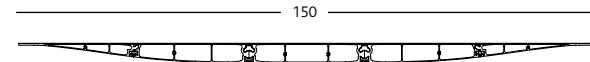

TABLE B 150



LEGS	TABLE B DESK	TABLE B 90	TABLE B 120	TABLE B 150
Wooden legs Patatas madera				
Wood trestle Caballote madera				
Stainless steel Acero inoxidable				
Concrete Hormigón				
Aluminium Aluminio				

TABLE B GENERAL DIMENSIONS / DIMENSIONES GENERALES

TABLE B DESK

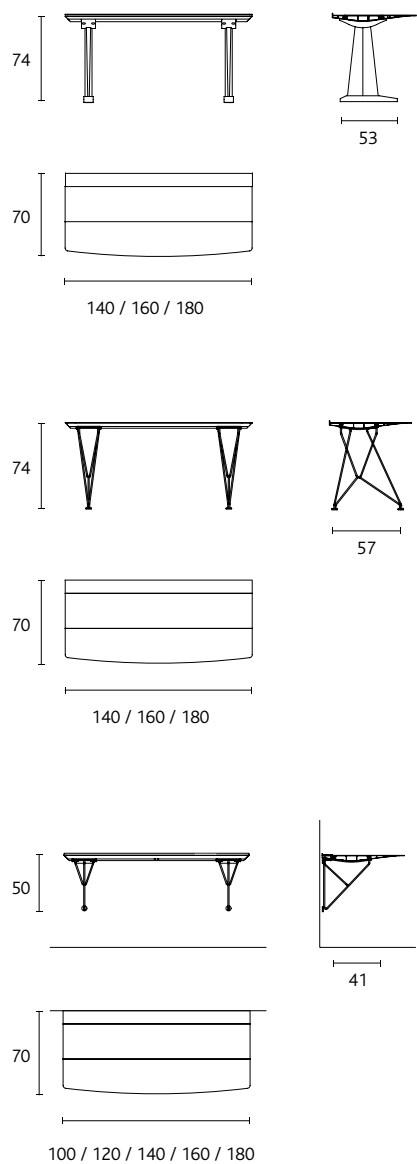

TABLE B 90

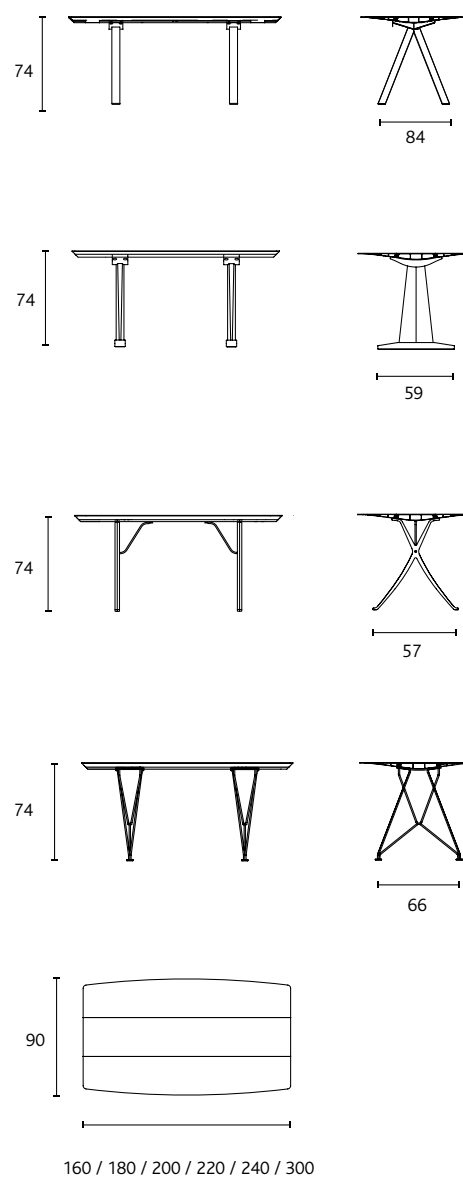

TABLE B GENERAL DIMENSIONS / DIMENSIONES GENERALES

TABLE B 120

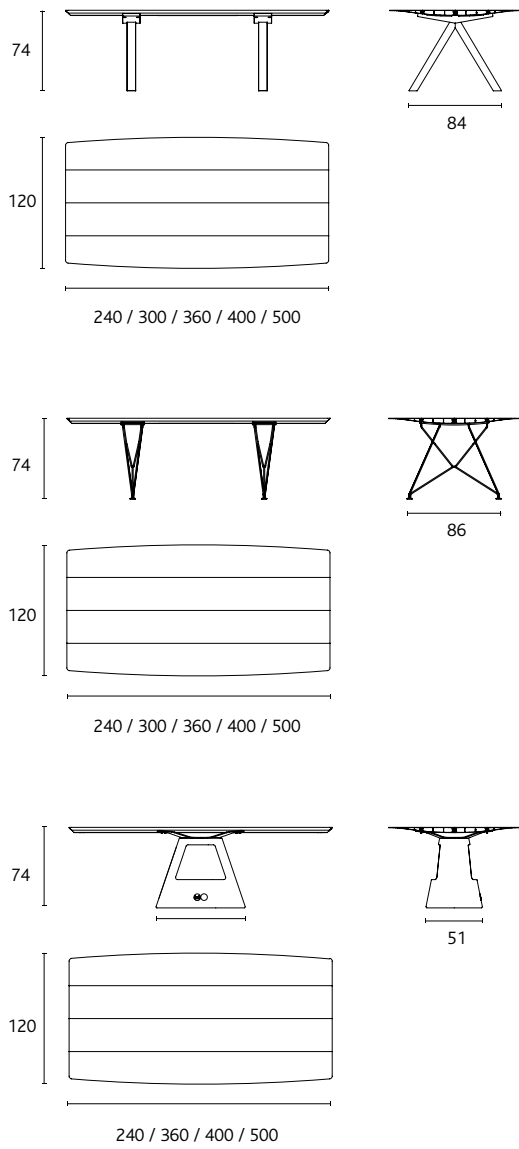

TABLE B 150

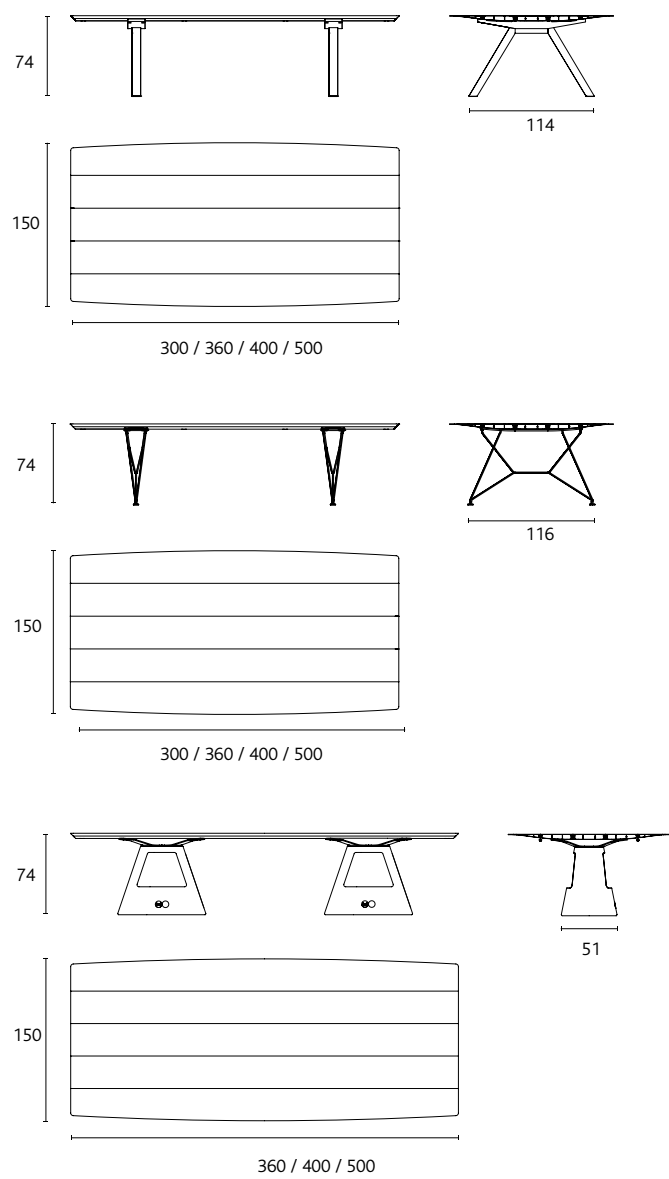
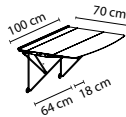

TABLE B DESK

All prices are for the complete table (Top + Legs)
 Todos los precios son para la mesa completa (Sobre + Patas)

LENGTH / LONGITUD 100 cm



LEGS	Stainless Steel (wall) / Acero inoxidable (pared)	
TOP	Anodized silver Anodizado plata	2.719

PACKAGING			
	PCS	DIMENSIONS CM	GROSS KG
Legs / Patas	1	90 x 80 x 60	15
Top / Sobre	1	120 x 20 x 90	24

LENGTH / LONGITUD 120 cm

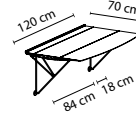

LEGS	Stainless Steel (wall) / Acero inoxidable (pared)	
TOP	Anodized silver Anodizado plata	2.817

PACKAGING			
	PCS	DIMENSIONS CM	GROSS KG
Legs / Patas	1	90 x 80 x 60	15
Top / Sobre	1	140 x 20 x 90	26

LENGTH / LONGITUD 140 cm

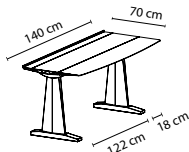

LEGS	Wooden trestle / Caballete madera	
TOP	Anodized silver Anodizado plata	3.200

PACKAGING			
	PCS	DIMENSIONS CM	GROSS KG
Legs / Patas	1	90 x 80 x 40	21
Top / Sobre	1	160 x 20 x 90	28

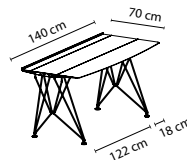

LEGS	Stainless Steel / Acero inoxidable	
TOP	Anodized silver Anodizado plata	3.134

PACKAGING			
	PCS	DIMENSIONS CM	GROSS KG
Legs / Patas	1	90 x 80 x 80	18
Top / Sobre	1	160 x 20 x 90	28

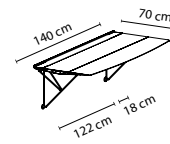

LEGS	Stainless Steel (wall) / Acero inoxidable (pared)	
TOP	Anodized silver Anodizado plata	2.916

PACKAGING			
	PCS	DIMENSIONS CM	GROSS KG
Legs / Patas	1	90 x 80 x 60	15
Top / Sobre	1	160 x 20 x 90	28

LENGTH / LONGITUD 160 cm

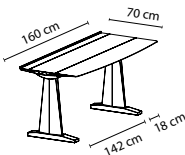

LEGS	Wooden trestle / Caballete madera	
TOP	Anodized silver Anodizado plata	3.374

PACKAGING			
	PCS	DIMENSIONS CM	GROSS KG
Legs / Patas	1	90 x 80 x 40	21
Top / Sobre	1	180 x 20 x 90	30



LEGS	Stainless Steel / Acero inoxidable	
TOP	Anodized silver Anodizado plata	3.309

PACKAGING			
	PCS	DIMENSIONS CM	GROSS KG
Legs / Patas	1	90 x 80 x 80	18
Top / Sobre	1	180 x 20 x 90	30

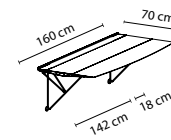

LEGS	Stainless Steel (wall) / Acero inoxidable (pared)	
TOP	Anodized silver Anodizado plata	3.090

PACKAGING			
	PCS	DIMENSIONS CM	GROSS KG
Legs / Patas	1	90 x 80 x 60	15
Top / Sobre	1	180 x 20 x 90	30

LENGTH / LONGITUD 180 cm

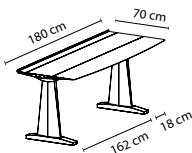

LEGS	Wooden trestle / Caballete madera	
TOP	Anodized silver Anodizado plata	3.554

PACKAGING			
	PCS	DIMENSIONS CM	GROSS KG
Legs / Patas	1	90 x 80 x 40	21
Top / Sobre	1	200 x 20 x 90	35

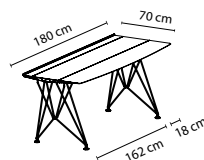

LEGS	Stainless Steel / Acero inoxidable	
TOP	Anodized silver Anodizado plata	3.489

PACKAGING			
	PCS	DIMENSIONS CM	GROSS KG
Legs / Patas	1	90 x 80 x 80	18
Top / Sobre	1	200 x 20 x 90	35

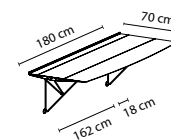

LEGS	Stainless Steel (wall) / Acero inoxidable (pared)	
TOP	Anodized silver Anodizado plata	3.271

PACKAGING			
	PCS	DIMENSIONS CM	GROSS KG
Legs / Patas	1	90 x 80 x 60	15
Top / Sobre	1	200 x 20 x 90	35



TABLE B 90

All prices are for the complete table (Top + Legs)
 Todos los precios son para la mesa completa (Sobre + Patas)

LENGTH / LONGITUD 160 cm

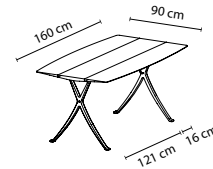
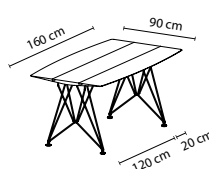
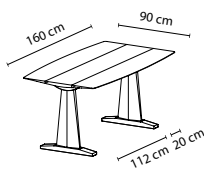
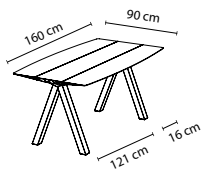

LEGS	Wood / Madera	
TOP	Anodized silver Anodizado plata	3.773
	Laminated Laminado	5.220
	Natural oak Roble natural	

LEGS	Wooden trestle / Caballete madera	
TOP	Anodized silver Anodizado plata	3.729
	Laminated Laminado	5.172
	Natural oak Roble natural	

LEGS	Stainless Steel / Acero inoxidable	
TOP	Anodized silver Anodizado plata	3.662
	Laminated Laminado	5.104
	Natural oak Roble natural	

LEGS	Aluminium / Aluminio	
TOP	Anodized silver Anodizado plata	3.606
	Laminated Laminado	5.052
	Natural oak Roble natural	

PACKAGING		
PCS	DIMENSIONS CM	GROSS KG
Legs / Patas	1 90 x 80 x 40	18
Top / Sobre	1 180 x 20 x 110	34

PACKAGING		
PCS	DIMENSIONS CM	GROSS KG
Legs / Patas	1 90 x 80 x 40	20
Top / Sobre	1 180 x 20 x 110	34

PACKAGING		
PCS	DIMENSIONS CM	GROSS KG
Legs / Patas	1 90 x 80 x 80	15
Top / Sobre	1 180 x 20 x 110	34

PACKAGING		
PCS	DIMENSIONS CM	GROSS KG
Legs / Patas	1 90 x 80 x 40	16
Top / Sobre	1 180 x 20 x 110	34

LENGTH / LONGITUD 180 cm

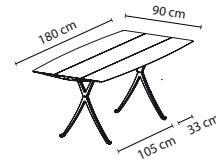
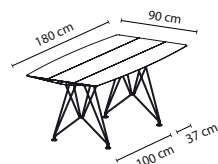
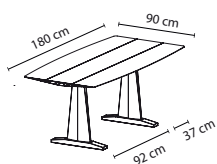
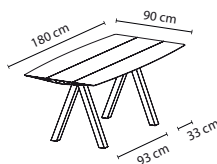

LEGS	Wood / Madera	
TOP	Anodized silver Anodizado plata	3.968
	Laminated Laminado	5.414
	Natural oak Roble natural	

LEGS	Wooden trestle / Caballete madera	
TOP	Anodized silver Anodizado plata	3.923
	Laminated Laminado	5.367
	Natural oak Roble natural	

LEGS	Stainless Steel / Acero inoxidable	
TOP	Anodized silver Anodizado plata	3.857
	Laminated Laminado	5.304
	Natural oak Roble natural	

LEGS	Aluminium / Aluminio	
TOP	Anodized silver Anodizado plata	3.801
	Laminated Laminado	5.241
	Natural oak Roble natural	

PACKAGING		
PCS	DIMENSIONS CM	GROSS KG
Legs / Patas	1 90 x 80 x 40	18
Top / Sobre	1 200 x 20 x 110	38

PACKAGING		
PCS	DIMENSIONS CM	GROSS KG
Legs / Patas	1 90 x 80 x 40	20
Top / Sobre	1 200 x 20 x 110	38

PACKAGING		
PCS	DIMENSIONS CM	GROSS KG
Legs / Patas	1 90 x 80 x 80	15
Top / Sobre	1 200 x 20 x 110	38

PACKAGING		
PCS	DIMENSIONS CM	GROSS KG
Legs / Patas	1 90 x 80 x 40	16
Top / Sobre	1 200 x 20 x 110	38

LENGTH / LONGITUD 200 cm

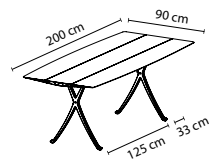
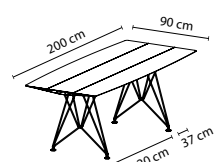
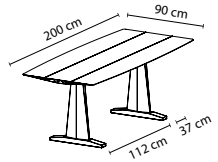
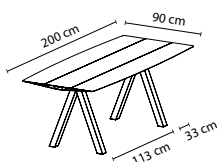

LEGS	Wood / Madera	
TOP	Anodized silver Anodizado plata	4.218
	Laminated Laminado	5.766
	Natural oak Roble natural	

LEGS	Wooden trestle / Caballete madera	
TOP	Anodized silver Anodizado plata	4.174
	Laminated Laminado	5.771
	Natural oak Roble natural	

LEGS	Stainless Steel / Acero inoxidable	
TOP	Anodized silver Anodizado plata	4.107
	Laminated Laminado	5.650
	Natural oak Roble natural	

LEGS	Aluminium / Aluminio	
TOP	Anodized silver Anodizado plata	4.051
	Laminated Laminado	5.598
	Natural oak Roble natural	

PACKAGING		
PCS	DIMENSIONS CM	GROSS KG
Legs / Patas	1 90 x 80 x 40	18
Top / Sobre	1 220 x 20 x 110	45

PACKAGING		
PCS	DIMENSIONS CM	GROSS KG
Legs / Patas	1 90 x 80 x 40	20
Top / Sobre	1 220 x 20 x 110	45

PACKAGING		
PCS	DIMENSIONS CM	GROSS KG
Legs / Patas	1 90 x 80 x 80	15
Top / Sobre	1 220 x 20 x 110	45

PACKAGING		
PCS	DIMENSIONS CM	GROSS KG
Legs / Patas	1 90 x 80 x 40	16
Top / Sobre	1 220 x 20 x 110	45

TABLE B 90

All prices are for the complete table (Top + Legs)
 Todos los precios son para la mesa completa (Sobre + Patas)

LENGTH / LONGITUD 220 cm

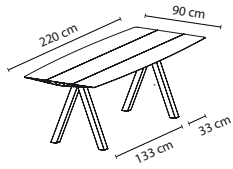

LEGS	Wood / Madera	
TOP	Anodized silver Anodizado plata	4.341
	Laminated Laminado	5.918
	Natural oak Roble natural	

PACKAGING

	PCS	DIMENSIONS CM	GROSS KG
Legs / Patas	1	90 x 80 x 40	18
Top / Sobre	1	240 x 20 x 110	48

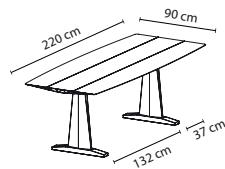

LEGS	Wooden trestle / Caballete madera	
TOP	Anodized silver Anodizado plata	4.296
	Laminated Laminado	5.876
	Natural oak Roble natural	

PACKAGING

	PCS	DIMENSIONS CM	GROSS KG
Legs / Patas	1	90 x 80 x 40	20
Top / Sobre	1	240 x 20 x 110	48

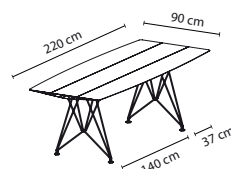

LEGS	Stainless Steel / Acero inoxidable	
TOP	Anodized silver Anodizado plata	4.229
	Laminated Laminado	5.808
	Natural oak Roble natural	

PACKAGING

	PCS	DIMENSIONS CM	GROSS KG
Legs / Patas	1	90 x 80 x 80	15
Top / Sobre	1	240 x 20 x 110	48

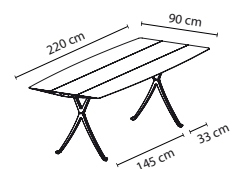

LEGS	Aluminium / Aluminio	
TOP	Anodized silver Anodizado plata	4.174
	Laminated Laminado	5.750
	Natural oak Roble natural	

PACKAGING

	PCS	DIMENSIONS CM	GROSS KG
Legs / Patas	1	90 x 80 x 40	16
Top / Sobre	1	240 x 20 x 110	48

LENGTH / LONGITUD 240 cm

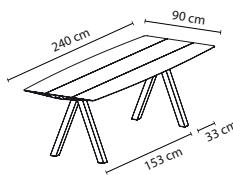

LEGS	Wood / Madera	
TOP	Anodized silver Anodizado plata	4.580
	Laminated Laminado	6.201
	Natural oak Roble natural	

PACKAGING

	PCS	DIMENSIONS CM	GROSS KG
Legs / Patas	1	90 x 80 x 40	18
Top / Sobre	1	260 x 20 x 110	54

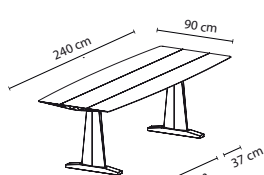

LEGS	Wooden trestle / Caballete madera	
TOP	Anodized silver Anodizado plata	4.535
	Laminated Laminado	6.159
	Natural oak Roble natural	

PACKAGING

	PCS	DIMENSIONS CM	GROSS KG
Legs / Patas	1	90 x 80 x 40	20
Top / Sobre	1	260 x 20 x 110	54

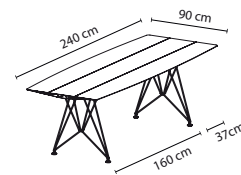

LEGS	Stainless Steel / Acero inoxidable	
TOP	Anodized silver Anodizado plata	4.469
	Laminated Laminado	6.091
	Natural oak Roble natural	

PACKAGING

	PCS	DIMENSIONS CM	GROSS KG
Legs / Patas	1	90 x 80 x 80	15
Top / Sobre	1	260 x 20 x 110	54

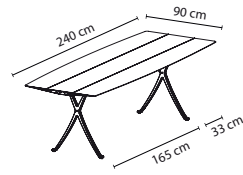

LEGS	Aluminium / Aluminio	
TOP	Anodized silver Anodizado plata	4.413
	Laminated Laminado	6.039
	Natural oak Roble natural	

PACKAGING

	PCS	DIMENSIONS CM	GROSS KG
Legs / Patas	1	90 x 80 x 40	16
Top / Sobre	1	260 x 20 x 110	54

LENGTH / LONGITUD 300 cm

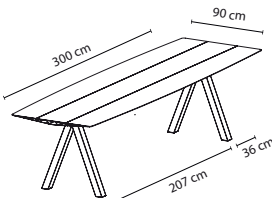

LEGS	Wood / Madera	
TOP	Anodized silver Anodizado plata	5.064
	Laminated Laminado	6.984
	Natural oak Roble natural	

PACKAGING

	PCS	DIMENSIONS CM	GROSS KG
Legs / Patas	1	90 x 80 x 40	18
Top / Sobre	1	320 x 20 x 110	72

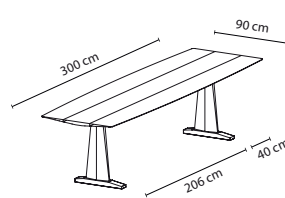

LEGS	Wooden trestle / Caballete madera	
TOP	Anodized silver Anodizado plata	5.020
	Laminated Laminado	6.936
	Natural oak Roble natural	

PACKAGING

	PCS	DIMENSIONS CM	GROSS KG
Legs / Patas	1	90 x 80 x 40	20
Top / Sobre	1	320 x 20 x 110	72

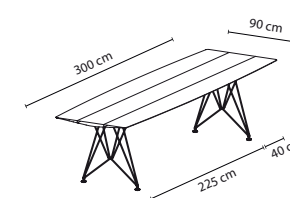

LEGS	Stainless Steel / Acero inoxidable	
TOP	Anodized silver Anodizado plata	4.953
	Laminated Laminado	6.873
	Natural oak Roble natural	

PACKAGING

	PCS	DIMENSIONS CM	GROSS KG
Legs / Patas	1	90 x 80 x 80	15
Top / Sobre	1	320 x 20 x 110	72

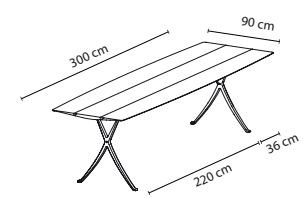

LEGS	Aluminium / Aluminio	
TOP	Anodized silver Anodizado plata	4.897
	Laminated Laminado	6.816
	Natural oak Roble natural	

PACKAGING

	PCS	DIMENSIONS CM	GROSS KG
Legs / Patas	1	90 x 80 x 40	16
Top / Sobre	1	320 x 20 x 110	72



TABLE B 120 cm

All prices are for the complete table (Top + Legs)
Todos los precios son para la mesa completa (Sobre + Patas)

LENGTH / LONGITUD 240 cm

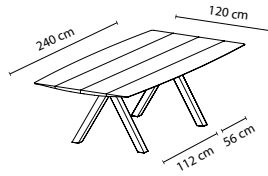

LEGS	Wood / Madera	
TOP	Anodized silver Anodizado plata	5.975
	Laminated Laminado	8.421
	Natural oak Roble natural	
PACKAGING		
	PCS	DIMENSIONS CM GROSS KG
Legs / Patas	1	90 x 40 x 80 22
Top / Sobre	1	260 x 20 x 140 95

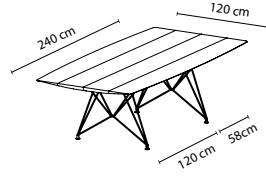

LEGS	Stainless Steel / Acero inoxidable	
TOP	Anodized silver Anodizado plata	5.775
	Laminated Laminado	8.216
	Natural oak Roble natural	
PACKAGING		
	PCS	DIMENSIONS CM GROSS KG
Legs / Patas	1	90 x 40 x 80 23
Top / Sobre	1	260 x 20 x 140 95

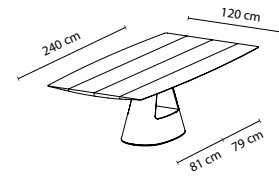

LEGS	Concrete / Hormigón	
TOP	Anodized silver Anodizado plata	6.074
	Laminated Laminado	8.714
	Natural oak Roble natural	
PACKAGING		
	PCS	DIMENSIONS CM GROSS KG
Legs / Patas	1	120 x 80 x 85 90
Top / Sobre	1	260 x 20 x 140 95

LENGTH / LONGITUD 300 cm

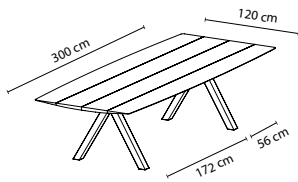

LEGS	Wood / Madera	
TOP	Anodized silver Anodizado plata	6.630
	Laminated Laminado	9.320
	Natural oak Roble natural	
PACKAGING		
	PCS	DIMENSIONS CM GROSS KG
Legs / Patas	1	90 x 40 x 80 22
Top / Sobre	1	320 x 20 x 140 152

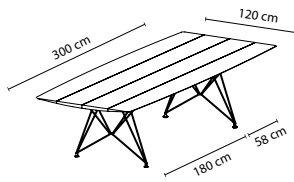

LEGS	Stainless Steel / Acero inoxidable	
TOP	Anodized silver Anodizado plata	6.431
	Laminated Laminado	9.114
	Natural oak Roble natural	
PACKAGING		
	PCS	DIMENSIONS CM GROSS KG
Legs / Patas	1	90 x 40 x 80 23
Top / Sobre	1	320 x 20 x 140 152

LENGTH / LONGITUD 360 cm

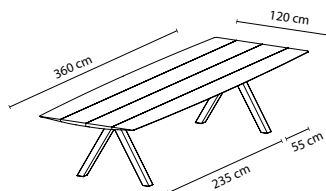

LEGS	Wood / Madera	
TOP	Anodized silver Anodizado plata	7.472
	Laminated Laminado	10.584
	Natural oak Roble natural	
PACKAGING		
	PCS	DIMENSIONS CM GROSS KG
Legs / Patas	1	90 x 40 x 80 22
Top / Sobre	1	380 x 20 x 140 185

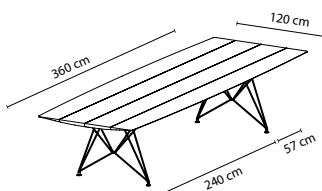

LEGS	Stainless Steel / Acero inoxidable	
TOP	Anodized silver Anodizado plata	7.276
	Laminated Laminado	10.190
	Natural oak Roble natural	
PACKAGING		
	PCS	DIMENSIONS CM GROSS KG
Legs / Patas	1	90 x 40 x 80 23
Top / Sobre	1	380 x 20 x 140 185

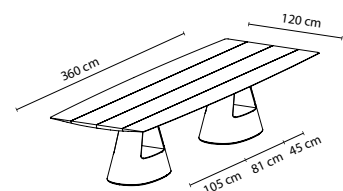

LEGS	Concrete / Hormigón	
TOP	Anodized silver Anodizado plata	9.286
	Laminated Laminado	12.752
	Natural oak Roble natural	
PACKAGING		
	PCS	DIMENSIONS CM GROSS KG
Legs / Patas	2	120 x 80 x 85 180
Top / Sobre	1	380 x 20 x 140 185

TABLE B 120 cm

All prices are for the complete table (Top + Legs)
 Todos los precios son para la mesa completa (Sobre + Patas)

LENGTH / LONGITUD 400 cm

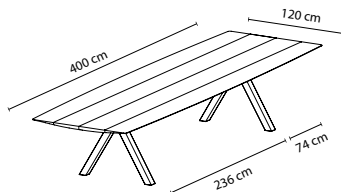

LEGS	Wood / Madera
	Anodized silver Anodizado plata 8.653
TOP	Laminated Laminado 11.951
	Natural oak Roble natural

PACKAGING

	PCS	DIMENSIONS CM	GROSS KG
Legs / Patas	1	90 x 40 x 80	22
Top / Sobre	1	420 x 20 x 140	205

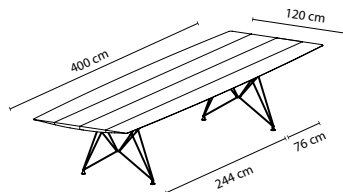

LEGS	Stainless Steel / Acero inoxidable
	Anodized silver Anodizado plata 8.454
TOP	Laminated Laminado 11.746
	Natural oak Roble natural

PACKAGING

	PCS	DIMENSIONS CM	GROSS KG
Legs / Patas	1	90 x 40 x 80	23
Top / Sobre	1	420 x 20 x 140	205

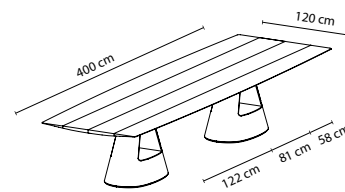

LEGS	Concrete / Hormigón
	Anodized silver Anodizado plata 10.520
TOP	Laminated Laminado 14.168
	Natural oak Roble natural

PACKAGING

	PCS	DIMENSIONS CM	GROSS KG
Legs / Patas	2	120 x 80 x 85	180
Top / Sobre	1	420 x 20 x 140	205

LENGTH / LONGITUD 500 cm

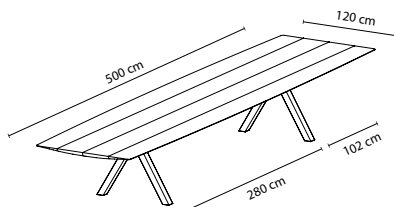

LEGS	Wood / Madera
	Anodized silver Anodizado plata 10.302
TOP	Laminated Laminado 13.780
	Natural oak Roble natural

PACKAGING

	PCS	DIMENSIONS CM	GROSS KG
Legs / Patas	1	90 x 40 x 80	22
Top / Sobre	1	520 x 20 x 140	255

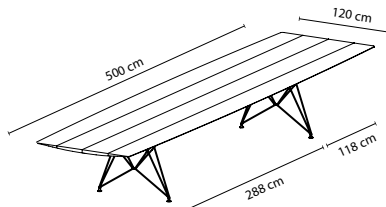

LEGS	Stainless Steel / Acero inoxidable
	Anodized silver Anodizado plata 9.913
TOP	Laminated Laminado 13.575
	Natural oak Roble natural

PACKAGING

	PCS	DIMENSIONS CM	GROSS KG
Legs / Patas	1	90 x 40 x 80	23
Top / Sobre	1	520 x 20 x 140	255

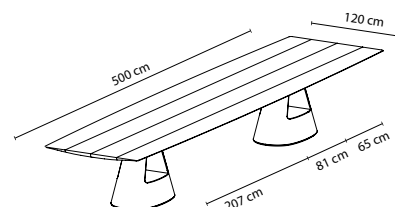

LEGS	Concrete / Hormigón
	Anodized silver Anodizado plata 12.199
TOP	Laminated Laminado 16.064
	Natural oak Roble natural

PACKAGING

	PCS	DIMENSIONS CM	GROSS KG
Legs / Patas	2	120 x 80 x 85	180
Top / Sobre	1	520 x 20 x 140	255

LAMINATE RESTRICTIONS LENGTH 360 - 400 - 500 cm / RESTRICCIONES DEL LAMINADO LARGO 360 - 400 - 500 cm

- In the case of the laminated finish, the top is formed by placing the laminates in a patchwork layout for lengths of 360cm, 400cm and 500cm.
- In the case of the natural oak finish, the top is formed by placing the laminates in a patchwork layout for lengths of 400cm and 500cm.
- En los casos de los acabados laminados, el sobre se conforma colocando las láminas cómo un patchwork para longitudes de 360cm, 400 cm y 500 cm.
- En el caso del acabado laminado roble natural, el sobre se conforma colocando las láminas cómo un patchwork para longitudes de 400 cm y 500 cm.

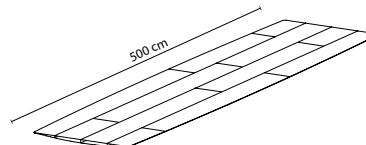
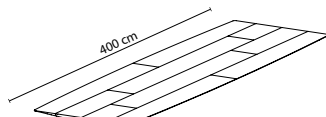
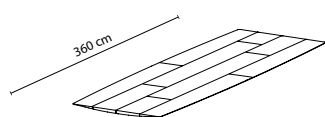
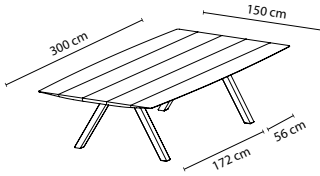

TABLE B 150 cm

All prices are for the complete table (Top + Legs)
Todos los precios son para la mesa completa (Sobre + Patas)

LENGTH / LONGITUD 300 cm



LEGS	Wood / Madera	
	Anodized silver Anodizado plata	9.146
TOP	Laminated Laminado	12.400
	Natural oak Roble natural	

PACKAGING			
	PCS	DIMENSIONS CM	GROSS KG
Legs / Patas	1	90 x 80 x 120	30
Top / Sobre	1	320 x 20 x 170	95

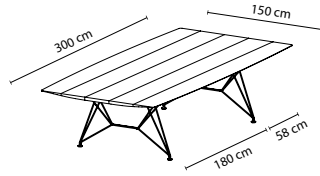

LEGS	Stainless Steel / Acero inoxidable	
	Anodized silver Anodizado plata	8.950
TOP	Laminated Laminado	13.639
	Natural oak Roble natural	

PACKAGING			
	PCS	DIMENSIONS CM	GROSS KG
Legs / Patas	1	90 x 80 x 120	25
Top / Sobre	1	320 x 20 x 170	95

LENGTH / LONGITUD 360 cm

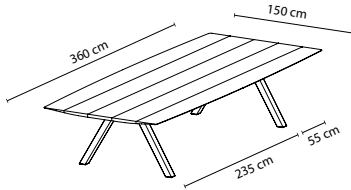

LEGS	Wood / Madera	
	Anodized silver Anodizado plata	10.077
TOP	Laminated Laminado	14.096
	Natural oak Roble natural	

PACKAGING			
	PCS	DIMENSIONS CM	GROSS KG
Legs / Patas	1	90 x 80 x 120	30
Top / Sobre	1	380 x 20 x 170	120

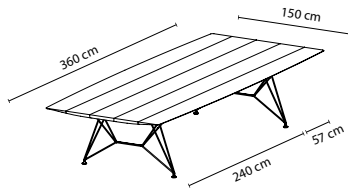

LEGS	Stainless Steel / Acero inoxidable	
	Anodized silver Anodizado plata	9.877
TOP	Laminated Laminado	13.887
	Natural oak Roble natural	

PACKAGING			
	PCS	DIMENSIONS CM	GROSS KG
Legs / Patas	1	90 x 80 x 120	25
Top / Sobre	1	380 x 20 x 170	120

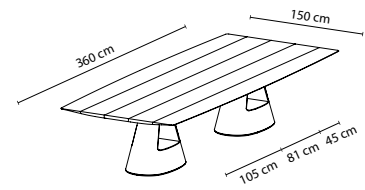

LEGS	Concrete / Hormigón	
	Anodized silver Anodizado plata	12.860
TOP	Laminated Laminado	17.372
	Natural oak Roble natural	

PACKAGING			
	PCS	DIMENSIONS CM	GROSS KG
Legs / Patas	2	120 x 120 x 85	180
Top / Sobre	1	380 x 20 x 170	120

LENGTH / LONGITUD 400 cm

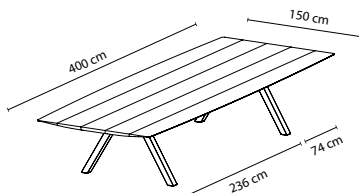

LEGS	Wood / Madera	
	Anodized silver Anodizado plata	11.020
TOP	Laminated Laminado	15.077
	Natural oak Roble natural	

PACKAGING			
	PCS	DIMENSIONS CM	GROSS KG
Legs / Patas	1	90 x 80 x 120	30
Top / Sobre	1	420 x 20 x 170	125

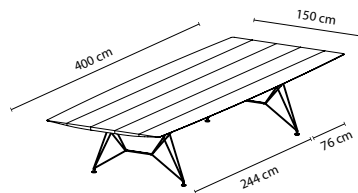

LEGS	Stainless Steel / Acero inoxidable	
	Anodized silver Anodizado plata	10.820
TOP	Laminated Laminado	14.872
	Natural oak Roble natural	

PACKAGING			
	PCS	DIMENSIONS CM	GROSS KG
Legs / Patas	1	90 x 80 x 120	25
Top / Sobre	1	420 x 20 x 170	125

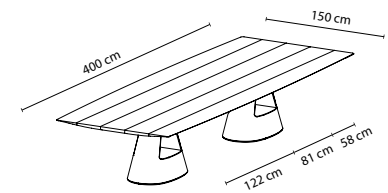

LEGS	Concrete / Hormigón	
	Anodized silver Anodizado plata	13.820
TOP	Laminated Laminado	18.339
	Natural oak Roble natural	

PACKAGING			
	PCS	DIMENSIONS CM	GROSS KG
Legs / Patas	2	120 x 120 x 85	180
Top / Sobre	1	520 x 20 x 140	125

TABLE B 150 cm

All prices are for the complete table (Top + Legs)
 Todos los precios son para la mesa completa (Sobre + Patas)

LENGTH / LONGITUD 500 cm

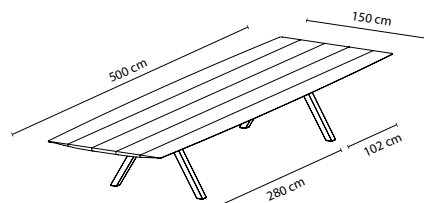

LEGS	Wood / Madera	
	Anodized silver Anodizado plata	12.899
TOP	Laminated Laminado	17.131
	Natural oak Roble natural	

PACKAGING

	PCS	DIMENSIONS CM	GROSS KG
Legs / Patas	1	90 x 80 x 120	30
Top / Sobre	1	520 x 20 x 170	150

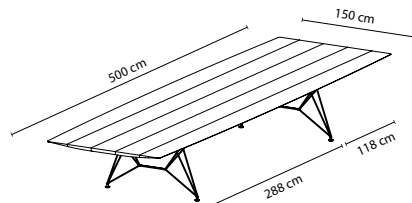

LEGS	Stainless Steel / Acero inoxidable	
	Anodized silver Anodizado plata	12.699
TOP	Laminated Laminado	16.925
	Natural oak Roble natural	

PACKAGING

	PCS	DIMENSIONS CM	GROSS KG
Legs / Patas	1	90 x 80 x 120	25
Top / Sobre	1	520 x 20 x 170	150

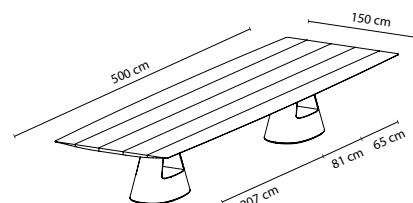

LEGS	Concrete / Hormigón	
	Anodized silver Anodizado plata	15.735
TOP	Laminated Laminado	20.468
	Natural oak Roble natural	

PACKAGING

	PCS	DIMENSIONS CM	GROSS KG
Legs / Patas	2	120 x 120 x 85	180
Top / Sobre	1	520 x 20 x 170	150

LAMINATE RESTRICTIONS LENGTH 360 - 400 - 500 cm / RESTRICCIONES DEL LAMINADO LARGO 360 - 400 - 500 cm

- In the case of the laminated finish, the top is formed by placing the laminates in a patchwork layout for lengths of 360cm, 400cm and 500cm.
- In the case of the natural oak finish, the top is formed by placing the laminates in a patchwork layout for lengths of 400cm and 500cm.
- En los casos de los acabados laminados, el sobre se conforma colocando las láminas cómo un patchwork para longitudes de 360cm, 400 cm y 500 cm.
- En el caso del acabado laminado roble natural, el sobre se conforma colocando las láminas cómo un patchwork para longitudes de 400 cm y 500 cm.

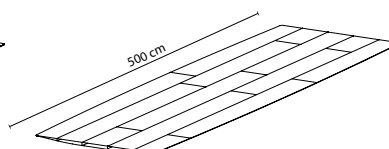
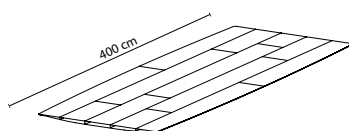
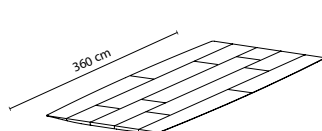
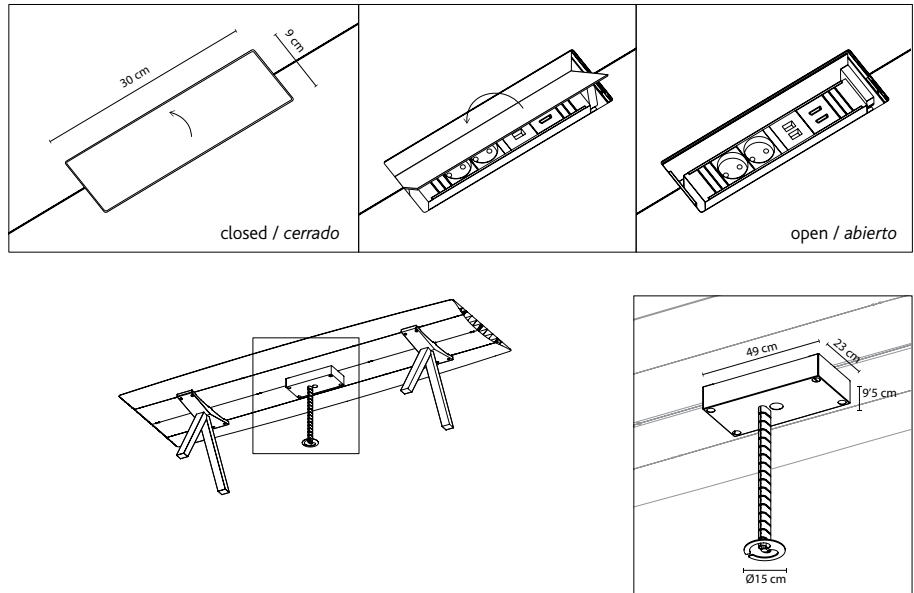

TABLE B ELECTRIC CABLE MANAGEMENT / ELECTRIFICACIÓN (examples on page 52-53 / ejemplos en pág. 52-53)

1. TOP FRAME (for Table B 90, 120 & 150)



POWER STRIP KIT INCLUDES
EL KIT DE ELECTRIFICACIÓN INCLUYE:

- Anodized aluminum case with open-close cover / Caja de aluminio anodizado con tapa plegable
- 2 Schuko Sockets / 2 Enchufes Schuko
- 2 USB connectors / 2 conectores USB
- 2 HDMI connectors / 2 conectores HDMI
- Snake Cable Premium Silver / Cables Premium Plata
- Electric cord / Cable de corriente

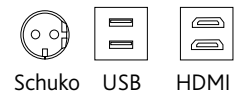

Top frame (per unit / por unidad)

2.127

2. SOCKETS & GROMMETS / ENCHUFES Y PASACABLES

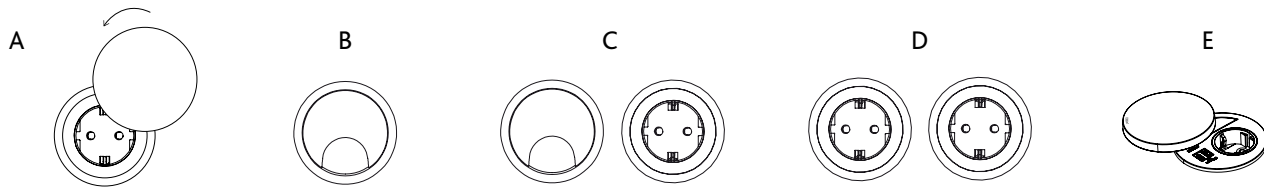

SCHUKO SOCKET
ENCHUFE SCHUKO

CABLE GROMMET
PASACABLES

CABLE GROMMET + SCHUKO
CABLE GROMMET + ENCHUFE

2 SCHUKO
2 ENCHUFES

EVOLINE DISQ

Circle 80 includes / incluye

- 1 Schuko
- 1 USB
- 1 USB-C

270° swivel tabletop cover plate.

TBPIXA	A. 1 Schuko	399
TBPIXB	B. 1 Cable Grommet / 1 Pasacables	226
TBPIXC	C. 1 Cable Grommet + 1 Schuko / 1 Cable Grommet + 1 Schuko	625
TBPIXD	D. 2 Schuko	798
TBPIXE	E. 1 EVOLine DisQ	980

EVOLine DisQ not suitable for Table B Desk.
Finish in Black RAL 9005.
Consult socket type for your country.

EVOLine DisQ no apto para Table B Desk.
Acabado en negro RAL 9005.
Consultar enchufes para tu país.

ELECTRIC CABLE MANAGEMENT EXAMPLES / EJEMPLOS

All prices are for the complete table (Top + Legs + Electrification Kit)
 Todos los precios son para la mesa completa (Sobre + Patas + Electrificación)

TABLE B Desk

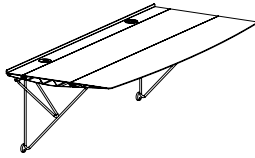

180 x 70 x 50 cm 3.271
 LEGS / PATAS: Stainless steel (wall) /
 Acero inoxidable (pared)
 TOP / SOBRE: Anodized silver /
 Anodizado plata

1 Schuko 399

1 Grommet / Pasacables 226

TOTAL 3.896



180 x 70 x 74 cm 3.489
 LEGS / PATAS: Stainless steel /
 Acero inoxidable
 TOP / SOBRE: Anodized silver /
 Anodizado plata

1 Grommet / Pasacables 226

TOTAL 3.715



180 x 70 x 74 cm 3.554
 LEGS / PATAS: Wooden trestle /
 Caballete madera
 TOP / SOBRE: Anodized silver /
 Anodizado plata

1 Grommet + 1 Schuko
 1 Pasacables + 1 Schuko 625

TOTAL 4.179

TABLE B 90 cm

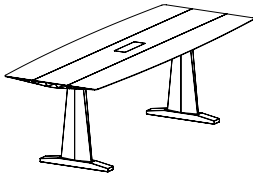

240 x 90 x 74 cm 4.535
 LEGS / PATAS: Wooden trestle /
 Caballete madera
 TOP / SOBRE: Anodized silver /
 Anodizado plata

Top frame 2.080

TOTAL 6.615



240 x 90 x 74 cm 4.413
 LEGS / PATAS: Aluminium / Aluminio
 TOP / SOBRE: Anodized silver /
 Anodizado plata

1 Schuko 399

TOTAL 4.812

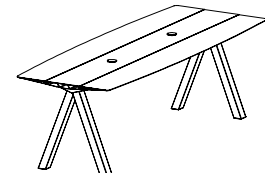

240 x 90 x 74 cm 4.580
 LEGS / PATAS: Wood / Madera
 TOP / SOBRE: Anodized silver /
 Anodizado plata

2 Schuko 798

TOTAL 5.378

ELECTRIC CABLE MANAGEMENT EXAMPLES / EJEMPLOS

All prices are for the complete table (Top + Legs + Electrification Kit)
 Todos los precios son para la mesa completa (Sobre + Patas + Electrificación)

TABLE B 120 cm

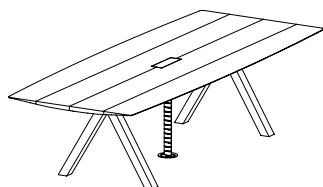

300 x 120 x 74 cm 6.630
 LEGS / PATAS: Wood / Madera
 TOP / SOBRE: Anodized silver / Anodizado plata

Top frame 2.080

TOTAL 8.710



360 x 120 x 74 cm 7.276
 LEGS / PATAS: Stainless steel / Acero inoxidable
 TOP / SOBRE: Anodized silver / Anodizado plata

Top frame 2.080

TOTAL 9.356

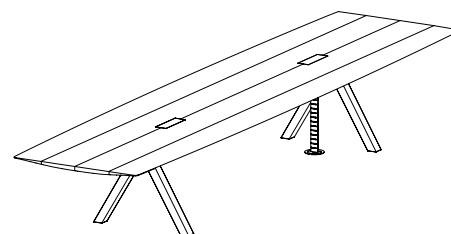

500 x 120 x 74 cm 10.302
 LEGS / PATAS: Wood / Madera
 TOP / SOBRE: Anodized silver / Anodizado plata

2 Top frame 4.160

TOTAL 14.462

TABLE B 150 cm

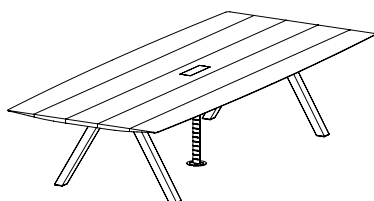

360 x 150 x 74 cm 10.077
 LEGS / PATAS: Wood / Madera
 TOP / SOBRE: Anodized silver / Anodizado plata

Top frame 2.080

TOTAL 12.157

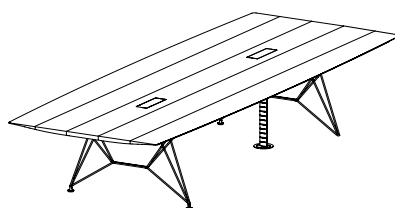

400 x 150 x 74 cm 10.820
 LEGS / PATAS: Stainless steel / Acero inoxidable
 TOP / SOBRE: Anodized silver / Anodizado plata

2 Top frame 4.160

TOTAL 14.980

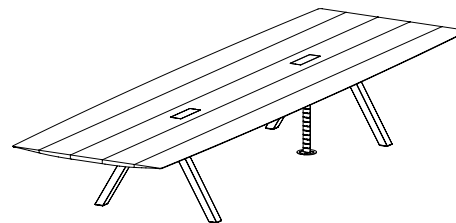

500 x 150 x 74 cm 12.899
 LEGS / PATAS: Wood / Madera
 TOP / SOBRE: Anodized silver / Anodizado plata

2 Top frame 4.160

TOTAL 17.059

STORAGE AND SHELVING
ESTANTERÍAS Y CONTENEDORES

TABLES
MESAS

ARMCHAIRS
BUTACAS

CHAIRS AND STOOLS
SILLAS Y TABURETES

ACCESSORIES
ACCESORIOS

LIGHTING
ILUMINACIÓN

PUBLIC SEATING
ASIENTOS PÚBLICOS

ART EDITIONS

EXPLORER DINING TABLE

Jaime Hayon

Interior painted steel structure. Central leg and base in fibreglass with a gloss (strengthened gel for durability) finish. A MDF veneered table top with a matte finish by Fenix. The underside and the borders of the top are lacquered in a matte finish. Nylon leveling glides. Multicolour options for three models.

Estructura interna de acero pintada. Cuerpo y base en fibra de vidrio lacado en brillo. La base está pintada con gelcoat de alta durabilidad. Sobre en MDF chapado en estratificado mate de Fenix. Parte inferior y canto van lacados en mate. Tacos reguladores en nylon. 3 opciones multicolor para todos los modelos.

	Top Fenix	Top Glass / Sobre Vidrio
Explorer 4XS (120 cm)	4.856	5.531
Explorer 4 (130 cm)	4.921	5.646
Explorer 5A (190 cm)	5.678	6.538
Explorer 5B (220 cm)	5.820	6.806
Explorer 6 (300 cm)	9.680	-

Explorer 4 XS / Explorer 4

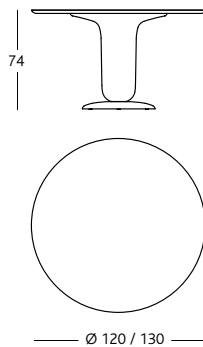

Explorer 5A (190 cm)

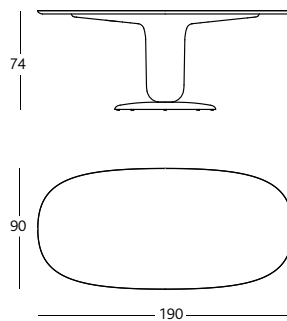

Explorer 5B (220 cm)

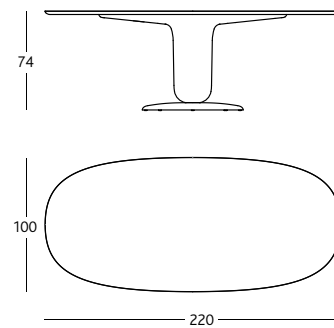

Explorer 6 (300 cm)

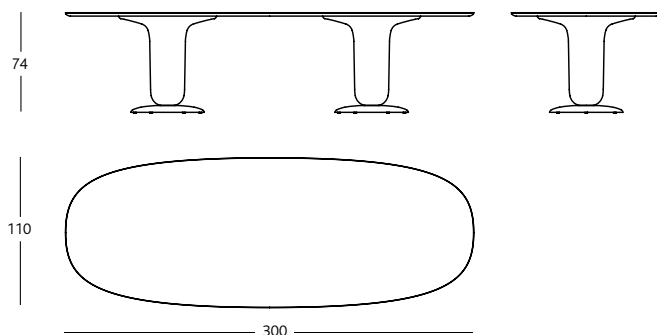

PACKAGING

Explorer 4XS / 4			Explorer 5A 190			Explorer 5B 220			Explorer 6 300		
PCS	DIMENSIONS CM	GROSS KG	PCS	DIMENSIONS CM	GROSS KG	PCS	DIMENSIONS CM	GROSS KG	PCS	DIMENSIONS CM	GROSS KG
Leg / Pata	1 87 x 87 x 92	85	Leg / Pata	1 175 x 71 x 92	128	Leg / Pata	1 175 x 71 x 92	128	Leg / Pata	2 87 x 87 x 92	170
Top 120 / Sobre 120	1 133 x 14 x 133	38	Top / Sobre	1 203 x 14 x 102	49	Top / Sobre	1 232 x 14 x 114	61	Top / Sobre	1 314 x 14 x 125	81
Top 130 / Sobre 130	1 143 x 14 x 143	42									



EXPLORER DINING MODELS & COLOURS / MODELOS Y COLORES



EXP04XSCL04
Explorer 4XS - Multicolor Blue

EXP04COL04
Explorer 4 - Multicolor Blue

EXP05ACOL04
Explorer 5A 190 - Multicolor Blue

EXP05BCOL04
Explorer 5B 220 - Multicolor Blue

EXP06COL04
Explorer 6 300 - Multicolor Blue

-Laminated top / *Sobre estratificado*: Fenix 725 (Grey Perle / *Gris perla*)
 -Underside top / *Sobre parte inferior*: Ral 5008 Mate (Grey blue / *Azul grisáceo*)
 -Body / *cuerpo*: Ral 5008 Gloss (Grey blue / *Azul grisáceo*)
 -Base: Ral 1015 Gloss (Light Ivory / *Marfil claro*)



EXP04XSCL05
Explorer 4XS - Multicolor Ivory

EXP04COL05
Explorer 4 - Multicolor Ivory

EXP05ACOL05
Explorer 5A 190 - Multicolor Ivory

EXP05BCOL05
Explorer 5B 220 - Multicolor Ivory

EXP06COL05
Explorer 6 300 - Multicolor Ivory

-Laminated top / *Sobre estratificado*: Fenix 725 (Grey Perle / *Gris perla*)
 -Underside top / *Sobre parte inferior*: Ral 5008 Mate (Grey blue / *Azul grisáceo*)
 -Body / *cuerpo*: Ral 1015 Gloss (Light Ivory / *Marfil claro*)
 -Base: Ral 6009 Gloss (Fir green / *Verde abeto*)

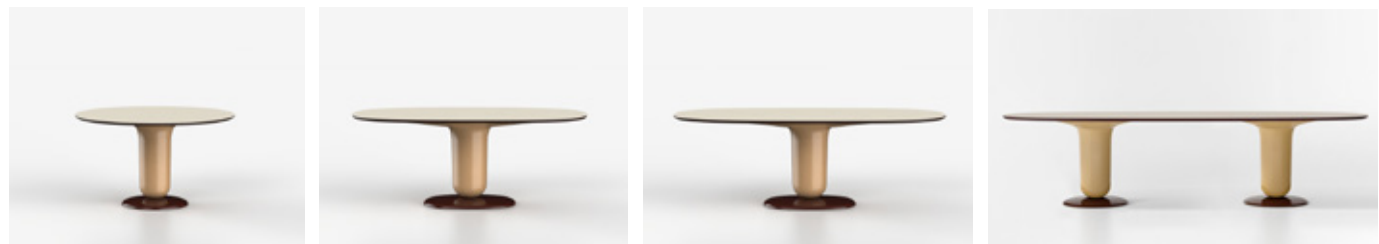

EXP04XSCL06
Explorer 4XS - Multicolor Beige

EXP04COL06
Explorer 4 - Multicolor Beige

EXP05ACOL06
Explorer 5A 190 - Multicolor Beige

EXP05BCOL06
Explorer 5B 220 - Multicolor Beige

EXP06COL06
Explorer 6 300 - Multicolor Beige

-Laminated top / *Sobre estratificado*: Fenix 719 (Beige)
 -Underside top / *Sobre parte inferior*: Ral 8017 Mate (Chocolate brown / *Marrón chocolate*)
 -Body / *cuerpo*: Ral 1001 Gloss (Beige)
 -Base: Ral 8015 Gloss (Chestnut brown / *Marrón castaño*)

Laminated & Glass top finishes / *Acabados estratificado y sobre vidrio*



MULTILEG LOW TABLE / MESA BAJA MULTILEG

Jaime Hayon

MDF base top and lacquered high-gloss, matte or veneered in varnished walnut nature effect. Legs in solid turned alder-wood, lacquered in high-gloss or matte or stained in a walnut colour.

Tops: 1cm glass painted, MDF veneered walnut nature effect or 2cm thick marble.

Four finishes available: Matte lacquered (without additional top) / Gloss lacquered with additional glass top / Gloss lacquered with additional marble top / Walnut nature effect (without additional top).

Base en MDF lacado en mate o brillo, o chapado en nogal barnizado efecto nature. Patas en aliso macizo torneado, lacado en mate o brillo, o teñido color nogal. Sobres: vidrio de 1cm pintado, en MDF chapado en nogal barnizado efecto nature o en mármol de 2cm.

Cuatro opciones de acabado: Laca mate (sin sobre adicional) / Laca brillo con sobre adicional de vidrio / Laca brillo con sobre adicional de mármol / Nogal barnizado efecto nature (sin sobre adicional).

ROUND / REDONDA



ROUND / REDONDA Ø120 cm

Matte / Mate (Glass top not included in this model / Este modelo no incluye sobre de vidrio)	2.302
High Gloss with glass top <i>Lacado brillo con sobre vidrio</i>	3.167
High Gloss with marble top <i>Lacado brillo con sobre mármol</i>	5.215

PACKAGING

	PCS	DIMENSIONS CM	GROSS KG
Matte & High gloss (glass top) / <i>Mate y Brillante (sobre de vidrio)</i>	1	130x21x130	58
High gloss (marble top) / <i>Brillante (sobre de mármol)</i>	1	130x21x130	100
Walnut top / <i>Sobre de nogal</i>	1	130x21x130	38
4 legs / <i>4 patas</i>	1	61x60x30	6

RECTANGULAR

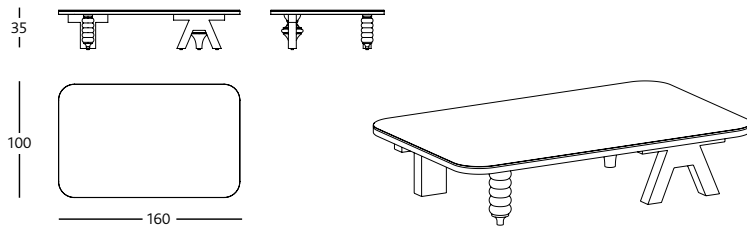

RECTANGULAR 160 x100 cm

Matte / Mate (Glass top not included in this model / Este modelo no incluye sobre de vidrio)	2.366
*Walnut / Nogal (Glass top not included in this model / Este modelo no incluye sobre de vidrio)	2.429
High Gloss with glass top <i>Lacado brillo con sobre vidrio</i>	3.396
High Gloss with marble top <i>Lacado brillo con sobre mármol</i>	4.884

PACKAGING

	PCS	DIMENSIONS CM	GROSS KG
Matte & High gloss (glass top) / <i>Mate y Brillante (sobre de vidrio)</i>	1	170x18x110	80
High gloss (marble top) / <i>Brillante (sobre de mármol)</i>	1	170x18x110	140
Walnut top / <i>Sobre de nogal</i>	1	170x18x110	52
4 legs / <i>4 patas</i>	1	61x60x30	6

*Until stocks last / *Hasta agotar existencias*

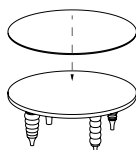

- 1cm thick additional glass top.
 - 2cm thick additional marble top.
- The high gloss models require a top.

- *Sobre de vidrio adicional de 1cm de grosor.*
 - *Sobre de mármol adicional de 2cm de grosor.*
- El top es obligatorio en el caso de las mesas con acabado brillante.*

LEGS / PATAS

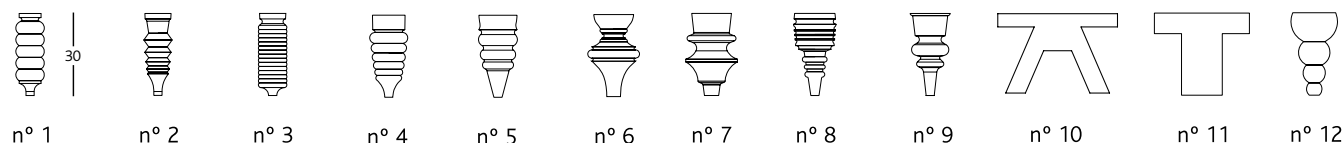

LEGS / PATAS	Matte Mate	Gloss Brillo	Walnut Nogal
Unit / Unidad	255	255	319

Each table needs 4 legs / Cada mesa necesita 4 patas

MULTILEG LOW TABLE FINISHES / ACABADOS

High Gloss lacquer <i>Lacas brillo</i>	LAC04 - White / Blanco RAL 9003 LAC09 - Blue / Azul RAL 5002 LAC10 - Black / Negro RAL 9005	High Gloss lacquer <i>Lacas brillo</i>	B31 - White / Blanco RAL 9016 B32 - Blue / Azul RAL 5011 B33 - Green / Verde RAL 6021	NG EN Walnut Nature Effect / Nogal efecto nature
Matte lacquer <i>Lacas mate</i>	LACM04 - White / Blanco RAL 9003 LACM09 - Blue / Azul RAL 5002 LACM10 - Black / Negro RAL 9005	Marble tops <i>Sobre mármol</i>	Green / Verde Patrizia White / Blanco Carrara Venato Black / Negro Marquina	*Custom colour + 10 %. *Color personalizado +10%.

MONKEY SIDE TABLE 

Jaime Hayon

Side table manufactured in one solid piece of architectural concrete in different colors. Includes regulatory glides.
Mesa auxiliar fabricada en una sola pieza de hormigón arquitectónico en diferentes colores. Incorpora tacos reguladores.

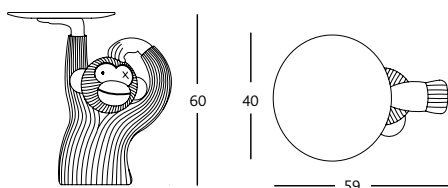

MKSIDE013	Grey / Gris	(Indoor and outdoor use / uso interior y exterior)	969
MKSIDE004	White / Blanco	(Indoor and outdoor use / uso interior y exterior)	1.032
MKSIDE010	Black / Negro	(Indoor use only / uso solo interior)	

Custom colour according to RAL chart min. 4 units.
Color personalizado según carta RAL min. 4 unidades.

Consult

Maximum load on the table is 10 Kg. / Carga máxima encima de la mesa 10 Kg.
It is recommended not to sit on the tables. / Se recomienda no sentarse encima de las mesas.

PACKAGING



Delivery in 2 weeks. Consult conditions.
Entrega en 2 semanas. Consultar condiciones.

Standard / Estándar	PCS	DIMENSIONS CM	GROSS KG
	1	68 x 54 x 80	33

SIDE TABLE B

Konstantin Grcic

A solid architectural concrete piece in grey or black. Incorporated with regulatory glides.
Fabricada de una sola pieza con hormigón arquitectónico gris o negro. Incorpora tacos.

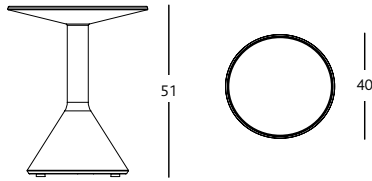

TBSIDE013	Grey / Gris (indoor and outdoor use / uso interior y exterior)	600
TBSIDE010	Black / Negro (indoor use only / uso solo interior)	651

 Delivery in 2 weeks. Consult conditions.
Entrega en 2 semanas. Consultar condiciones.

Maximum load on the table is 10 Kg. / Carga máxima encima de la mesa 10 Kg.
It is recommended not to sit on the tables. / Se recomienda no sentarse encima de las mesas.

PACKAGING

PCS	DIMENSIONS CM	GROSS KG
1	43 x 43 x 54	15

2001 SIDE TABLES

Ramón Úbeda & Otto Canalda

Ultra-clear tempered glass top and a pyrex tube leg, both with a mirrored finish.
Sobre de vidrio ultraclaro templado con acabado espejado. Pie de tubo de pyrex con acabado espejado.

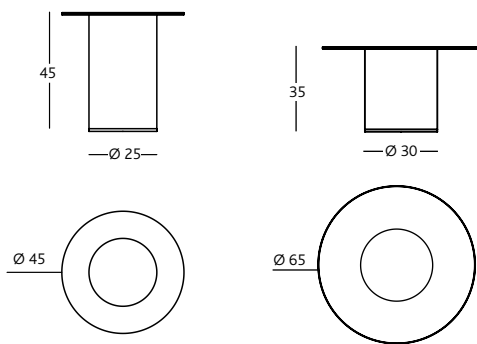

2001SIDE45	H. 45 cm	1.307
2001SIDE35	H. 35 cm	1.824

Maximum load on the table is 8 Kg. / Carga máxima encima de la mesa 8 Kg.
It is recommended not to sit on the tables. / Se recomienda no sentarse encima de las mesas.

PACKAGING

	PCS	DIMENSIONS CM	GROSS KG
N.1: Ø65 x h.45 cm	1	51 x 51 x 58	12
N.2: Ø65 x h.35 cm	1	71 x 71 x 48	22

EXPLORER SIDE TABLE / MESA AUXILIAR

Jaime Hayon

A laquered fibreglass body with matte and gloss finishes. Solid alder-wood legs, lacquered in a matte finish and glass top painted in dark grey.
Cuerpo de fibra de vidrio lacado mate y brillante. Patas de madera de aliso lacadas mate. Sobre de cristal pintado gris negruzco.

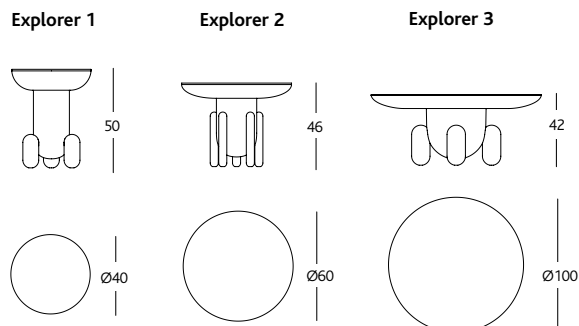

	Monocolor	Multicolor V1 / V2
Explorer 1	1.499	1.582
Explorer 2	1.917	2.069
Explorer 3	2.519	2.704

Soft felt glides included. See page 18 / Tacos de fieltro incluidos. Ver pág. 18



EXPLORER MODELS & COLOURS / MODELOS Y COLORES



EXP01COL01
Explorer 1 - Multicolor Green / Verde - V1
- Glass / Cristal: Ral 7021
- Top / Sobre: Ral 7001 Mate
- Middle / Medio: Ral 6005 Gloss
- Legs / Patas: Ral 3012 Mate



EXP02COL01
Explorer 2 - Multicolor Dark Blue / Azul oscuro - V1
- Glass / Cristal: Ral 7021
- Top / Sobre: Ral 5002 Mate
- Middle / Medio: Ral 5004 Gloss
- Legs / Patas: Ral 1019 Mate



EXP03COL01
Explorer 3 - Multicolor Red / Rojo - V1
- Glass / Cristal: Ral 7021
- Top / Sobre: Ral 3012 Mate
- Middle / Medio: Ral 3011 Gloss
- Legs / Patas: Ral 7006 Mate



EXP01COL02
Explorer 1 - Multicolor Beige - V2
- Glass / Cristal: Ral 7021
- Top / Sobre: Ral 5007 Mate
- Middle / Medio: Ral 1019 Gloss
- Legs / Patas: Ral 5003 Mate



EXP02COL02
Explorer 2 - Multicolor Brown / Marrón - V2
- Glass / Cristal: Ral 7021
- Top / Sobre: Ral 1001 Mate
- Middle / Medio: Ral 8011 Gloss
- Legs / Patas: Ral 8004 Mate



EXP03COL02
Explorer 3 - Multicolor Grey / Gris - V2
- Glass / Cristal: Ral 7021
- Top / Sobre: Ral 7001 Mate
- Middle / Medio: Ral 7001 Gloss
- Legs / Patas: Ral 6028 Mate



EXP01MON01
Explorer 1 - Monocolor Dark Grey / Gris oscuro
- Glass / Cristal: Ral 7021
- Body / Cuerpo: Ral 7021 Gloss
- Legs / Patas: Ral 7021 Mate



EXP02MON01
Explorer 2 - Monocolor Dark Grey / Gris oscuro
- Glass / Cristal: Ral 7021
- Body / Cuerpo: Ral 7021 Gloss
- Legs / Patas: Ral 7021 Mate



EXP03MON01
Explorer 3 - Monocolor Dark Grey / Gris oscuro
- Glass / Cristal: Ral 7021
- Body / Cuerpo: Ral 7021 Gloss
- Legs / Patas: Ral 7021 Mate



EXP01MON02
Explorer 1 - Monocolor Light Grey / Gris claro
- Glass / Cristal: Ral 7021
- Body / Cuerpo: Ral 7044 Gloss
- Legs / Patas: Ral 7044 Mate

Maximum load on each table / Carga máxima sobre cada mesa:

- Explorer 1: 8 kg max.
- Explorer 2: 10 kg max.
- Explorer 3: 12 kg max.

BD recommends not to sit on the tables.
BD recomienda no sentarse encima de las mesas.



Delivery in 3 weeks. Consult conditions.
Entrega en 3 semanas. Consultar condiciones.

	PACKAGING		
	PCS	DIMENSIONS CM	GROSS KG
Explorer 1	1	68 x 56 x 70	21
Explorer 2	1	80 x 70 x 66	24
Explorer 3	1	120 x 110 x 62	42

ARMCHAIRS / BUTACAS

DINO ARMCHAIR / BUTACA

Jaime Hayon

A rigid polyurethane structure covered with polyether foam cushioning and polyether foam headrest, seat cushion and backrest. Upholstered in different fabrics and leathers provided by BD. Steel legs in a dark bronze colour.

Hayon Edition: Two colours available: dark red or green in a combination of Steelcut 2 and Vidar 3 fabric by Kvadrat and Florida leather with armrests in the same colour. Cast aluminium legs painted in a powder coating in the same colour.

Cuerpo en inyección de poliuretano rígido, con estructura interior de acero tapizado. Cojines tapizados en los diferentes tejidos y pieles de BD. Patas de acero en color bronce oscuro.

Hayon Edition: dos opciones de color: burdeos y verde, combinando tejidos Steelcut 2 y Vidar 3 de Kvadrat y piel Florida a tono para los brazos. Patas en fundición de aluminio pintado en polvo a tono.

	Fabrics / Telas					Leather / Piel	
	*COM	CAT 1	CAT 2	CAT 3	CAT 4	S	V
Dino	3.077	3.374	3.503	3.673	3.838	4.649	4.887
Aluminium leg (optional) / Pata aluminio (opcional)						264	
Dino Hayon Edition	DINOBEDROJO	Red / Rojo				5.183	
	DINOBEDVERDE	Green / Verde					

*COM : Customer's own material / Tejido o piel del cliente

Metres of material required / Metros de material requerido
Fabric / Tela 500 x140cm - Leather / Piel 7m²

Customize your own version with our online configurator
Personaliza tu propia versión con nuestro configurador online
www.bdbarcelona.com

Dino

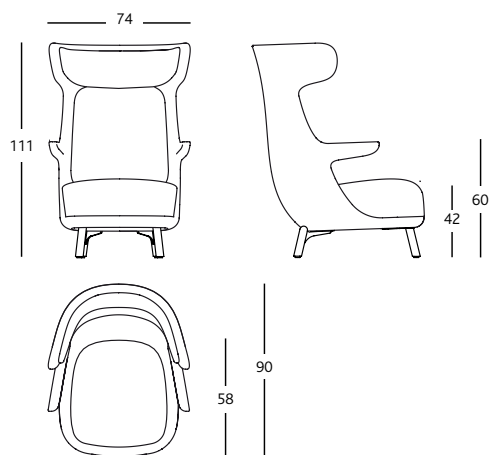

 Steel leg / Pata acero (included / incluida)

 Aluminium leg / Pata aluminio (optional / opcional)

Dino Hayon Edition

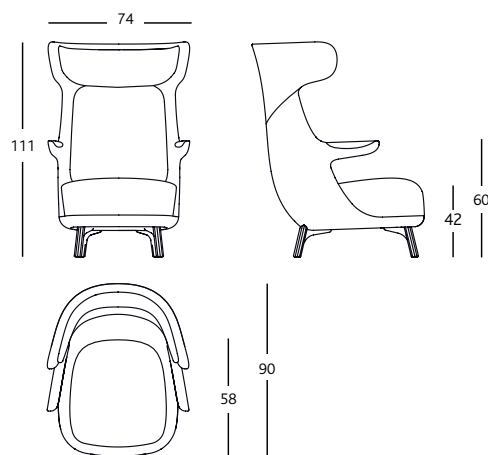

 Aluminium leg / Pata aluminio (included / incluida)

PACKAGING

PCS	DIMENSIONS CM	GROSS KG
1	98 x 82 x 132	43



GRASSO ARMCHAIR AND FOOTSTOOL / BUTACA Y REPOSAPIÉS

Stephen Burks

Tubular steel structure painted in polyester. Upholstered seat and backrest in different leathers and fabrics provided by BD.

Footstool in tubular steel structure painted in polyester. Upholstered in different leathers and fabrics provided by BD.

The wrinkles on the surface are part of the original design. Both the number and size of the wrinkles can vary as natural leathers are being used. The elasticity itself enhances the diversity and variability of the wrinkles.

Estructura de tubo de acero pintado en poliéster, asiento y respaldo tapizados con las distintas pieles y tejidos de BD.

Reposapiés con estructura de tubo de acero pintado en poliéster, tapizado con las distintas pieles y tejidos de BD.

Las arrugas producidas en la superficie son originales del propio diseño. Tanto el número de arrugas como el tamaño pueden variar debido a utilizar pieles naturales. La propia elasticidad potencia la diversidad y variabilidad de las arrugas.

	Fabrics / Telas					Leather / Piel		
	*COM	CAT 1	CAT 2	CAT 3	CAT 4	P	S	V/F
Armchair / butaca	2.771	2.971	3.124	3.309	3.494	3.543	3.937	4.072
Footstool / reposapiés	996	1.006	1.030	1.043	1.119	1.217	1.329	1.371

*COM : Customer's own material / Tejido o piel del cliente

Metres of material required / Metros de material requerido

Armchair / butaca: Leather / Piel 7m² - Fabric / Tela 550 x 140 cm

Footstool / reposapiés: Leather / Piel 1,5m² - Fabric / Tela 150 x 140 cm

Customize your own version with our online configurator
Personaliza tu propia versión con nuestro configurador online
www.bdbarcelona.com

Structure colour	RAL 3013 red / rojo
Color estructura	RAL 7022 gris oscuro / dark grey
	RAL 5011 blue / azul
	RAL 9011 black / negro

Armchair / butaca

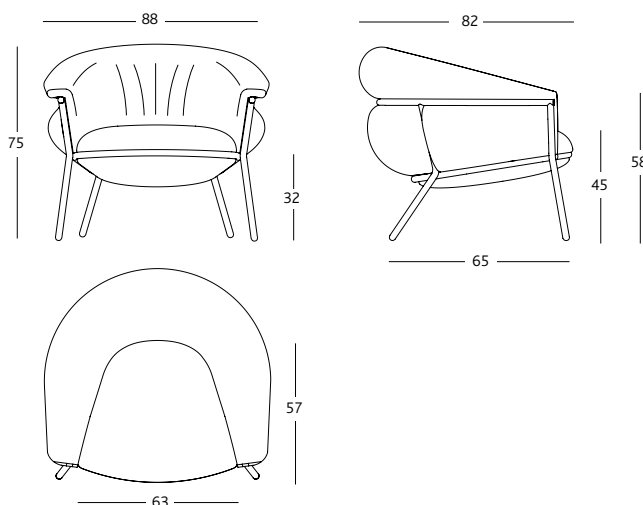

Footstool / reposapiés

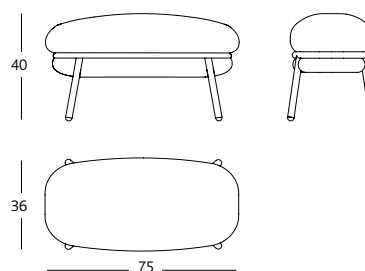

See matching stool on page 93 / Ver taburete a juego en página 93

NYC X DESIGN NYC X DESIGN AWARDS 2019



2020 ADI-FAD GOLD DELTA

PACKAGING

	PCS	DIMENSIONS CM	GROSS KG
Armchair / butaca	1	94 x 91 x 91	36
Footstool / reposapiés	1	74 x 43 x 43	8

ODYSSEY

Eugeni Quitllet

A flexible moulded polyurethane injected foam body, seat cushion and headrest. Both the body and headrest have an integral steel structure. Two adjustable headrest options. Upholstery choices: Monochrome in any of the fabrics and leathers offered by BD. Colour duo combination: The top, seat cushion and headrest are upholstered in the same fabric or leather, and the lower external base are upholstered in another fabric or leather from the BD catalogue. Aluminium swivel base and tilting mechanism in two colours: Matte black or polished die-cast aluminium. Felt glides.

Cuerpo en inyección de poliuretano flexible con estructura interior de acero. Cojín en espuma de poliuretano flexible con estructura interior de acero, ambos regulables en altura. Dos opciones de tapizado: Monocolor en los diferentes tejidos y pieles de BD. Bicolor: interior cabeza y cojín tapizado en un mismo tejido o piel, y la parte exterior tapizada en otro tejido o piel del catálogo de BD. Base giratoria y basculante fabricado en aluminio, acabado en color negro mate o pulido brillante, con tacos en fieltro.

Small headrest / Cabecero pequeño

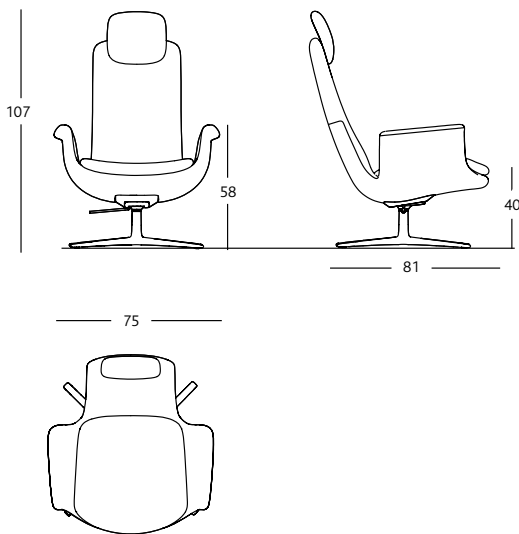

Large headrest (optional) / Cabecero grande (opcional)

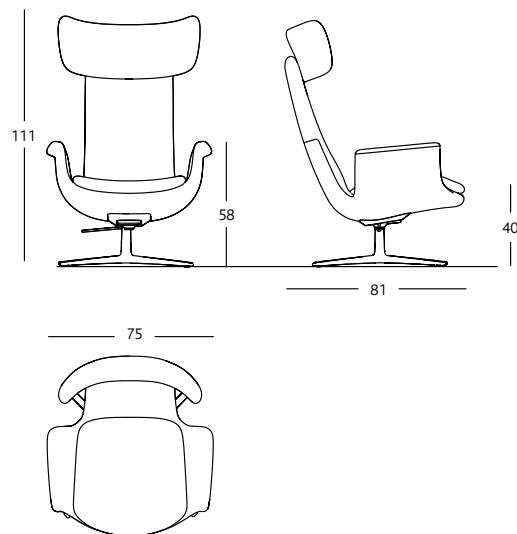

Base / Base

Aluminium matte black
Aluminio negro mate



Polished die-cast aluminium (optional)
Aluminio cromado (opcional)



Customize your own version with our online configurator
Personaliza tu propia versión con nuestro configurador online
www.bdbarcelona.com

PACKAGING

PCS	DIMENSIONS CM	GROSS KG
1	100 x 83 x 150	30



ODYSSEY SMALL HEADREST / CABECERO PEQUEÑO

MONOCHROME / MONOCOLOR

COM	Fabrics / Telas					Leather / Piel		
	CAT 1	CAT 2	CAT 3	CAT 4	CAT 5	P	S	F
2.913	3.034	3.114	3.194	3.254	3.696	4.141	4.313	4.552

BICOLOR



Interior options / Opciones de interior

Exterior	COM	CAT 1	CAT 2	CAT 3	CAT 4	CAT 5	P	S	F
CAT 1	3.231	3.256	3.306	3.356	3.394	3.670	3.626	3.714	3.835
CAT 2	3.281	3.306	3.356	3.406	3.444	3.720	3.676	3.764	3.885
CAT 3	3.331	3.356	3.406	3.456	3.494	3.770	3.726	3.814	3.935
CAT 4	3.369	3.394	3.444	3.494	3.531	3.808	3.764	3.851	3.973
CAT 5	3.645	3.670	3.720	3.770	3.808	4.084	4.040	4.128	4.249
P	3.601	3.626	3.676	3.726	3.764	4.040	4.160	4.248	4.369
S	3.689	3.714	3.764	3.814	3.851	4.128	4.248	4.336	4.457
F	3.810	3.835	3.885	3.935	3.973	4.249	4.369	4.457	4.579

EXTRAS



Optional aluminium chrome base 55

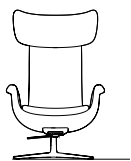

COM	CAT 1	CAT 2	CAT 3	CAT 4	CAT 5	P	S	F	
Optional big headrest	131	137	143	149	153	186	257	280	312

LOUNGER

Jaime Hayon

Armchair with a cast aluminium base structure and footstool with tubular steel legs and painted. Seat, backrest and footstool in plywood and veneered in beech wood. Also available in other finishes: natural ash, ash stained oak or ash stained black and walnut, nature effect. Also available in a single colour, lacquered in red RAL 3004 (LAC M19) and Fusion Granat (TF122) material.

Decorative metal buttons coated in the same finish as the structure. Armrests, seat, backrest and footstool upholstered in different materials and leathers provided by BD.

Estructura de la butaca en fundición de aluminio y reposapiés en tubo de acero pintado. Asiento, respaldo y reposapiés en madera contrachapada de haya. Existen diferentes acabados: fresno natural, fresno teñido color roble, fresno teñido negro y nogal efecto nature. También existe una versión monocolor en rojo RAL 3004 (LAC M19) y tejido Fusion Granate (TF122). Botones embellecedores metálicos en el mismo acabado de la estructura. Brazos, asiento, respaldo y reposapiés tapizados en los diferentes tejidos y pieles de BD.

WALNUT / NOGAL ASH / FRESNO	*COM	CAT 1	CAT 2	CAT 3	CAT 4	P	S	V/F
Armchair / Butaca	3.803	3.866	3.927	4.000	4.052	4.564	4.767	5.229
Footstool / Reposapiés	1.309	1.389	1.414	1.440	1.465	1.572	1.609	1.770
MONOCOLOR RED / ROJO				CAT 3				
Armchair / Butaca						4.103		
Footstool / Reposapiés						1.604		

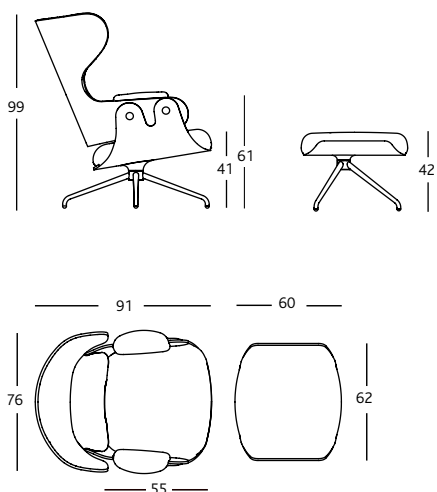

*COM : Customer's own material / Tejido o piel del cliente

Metres of material required / Metros de material requerido

Lounger: Fabric / Tela 240 x140cm - Leather / Piel 3,7m²
Footstool / Reposapiés: Fabric / Tela 85 x140cm - Leather / Piel 1,2m²



Walnut with V19 leather finish delivery in 3 weeks

Acabado en Nogal con Tela V19 entrega en 3 semanas

Customize your own version with our online configurator
Personaliza tu propia versión con nuestro configurador online
www.bdbarcelona.com

LOUNGER FINISHES / ACABADOS LOUNGER

WOOD / MADERA

Walnut Nature Effect / Nogal Efecto Nature NGEN
Natural ash / Fresno natural FR13
Ash stained oak / Fresno teñido roble FT18
Ash stained black / Fresno teñido negro FT10

COLOUR OF STRUCTURE / COLOR DE ESTRUCTURA

Anthracite grey / Gris antracita (RAL 7021 matte)
Pale brown / Marrón claro (RAL 8025 matte)
Beige (RAL 1001 matte)

FABRICS AND LEATHER / TELAS Y PIELES

CAT 1 Libra
CAT 2 Iris & Gaudí
CAT 2 Laser J Flash
CAT 3 Fusion
CAT 3 Nabucco
CAT 4 Moss

P - Panama
S - Sauvage
V - Vintage

MONOCOLOUR RED / MONOCOLOR ROJO

LACQUER / LACA

LAC19 Red / Rojo RAL 3004

FABRIC

Fusion TF122

PACKAGING

	PCS	DIMENSIONS CM	GROSS KG
Armchair / Butaca	1	100 x 83 x 150	43
Footstool / Reposapiés	1	66 x 68 x 52	8



LOW LOUNGER

Jaime Hayon

Armchair with a cast aluminium tubular base structure and a powder coated finish. Seat and backrest in plywood with surfaces in walnut nature effect, natural ash, ash stained oak and ash stained black.

Decorative metal buttons coated in the same finish as the structure. Armrests, seat and backrest upholstered in different fabrics and leathers provided by BD. Optional footstool (same as Lounger).

Estructura de la butaca en fundición de aluminio. Asiento y respaldo en madera contrachapada con caras exteriores en nogal efecto nature, fresno natural, fresno teñido roble, fresno teñido negro. Botones embellecedores metálicos en el mismo acabado de la estructura. Brazos, asiento y respaldo tapizados en los diferentes tejidos y pieles de BD.

4 legs / Estructura 4 patas

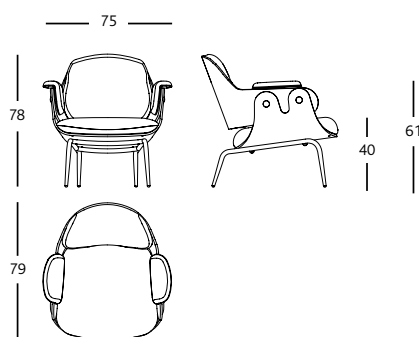

Fabrics / Telas

Leather / Piel

	FABRICS / TELAS					LEATHER / PIEL				
	WALNUT / NOGAL	ASH / FRESNO	*COM	CAT 1	CAT 2	CAT 3	CAT 4	P	S	V/F
4 legs / 4 patas			2.928	2.955	2.973	2.998	3.137	3.365	3.522	3.587
Swivel / Giratoria			3.363	3.376	3.407	3.433	3.582	3.800	3.919	4.022

*COM : Customer's own material / Tejido o piel del cliente

Metres of material required / Metros de material requerido

Fabric / Tela 220 x140cm - Leather / Piel 3,5m²

Swivel / Estructura Giratoria

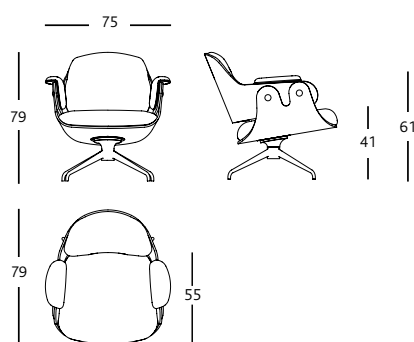

Walnut with V19 leather finish delivery in 3 weeks
Acabado en Nogal con Tela V19 entrega en 3 semanas

Customize your own version with our online configurator
Personaliza tu propia versión con nuestro configurador online
www.bdbarcelona.com

LOW LOUNGER FINISHES / ACABADOS

WOOD / MADERA

Walnut Nature Effect / Nogal Efecto Nature NG EN
Natural ash / Fresno natural FR 13
Ash stained oak / Fresno teñido roble FT18
Ash stained black / Fresno teñido negro FT10

COLOUR OF STRUCTURE / COLOR DE ESTRUCTURA

Anthracite grey / Gris antracita (RAL 7021 matte)
Pale brown / Marrón claro (RAL 8025 matte)
Beige (RAL 1001 matte)

FABRICS AND LEATHER / TELAS Y PIELES

CAT 1 Libra
CAT 2 Iris & Gaudí
CAT 2 Laser J Flash
CAT 3 Fusión
CAT 3 Nabucco
CAT 4 Moss
P - Panama
S - Sauvage
V - Vintage
F - Florida

PACKAGING

	PCS	MEDIDAS CM	BRUTO KG
Low Lounger Swivel / Giratorio	1	88 x 83 x 100	35
Low lounger 4 legs / 4 patas	1	88 x 83 x 100	26
Footstool / Reposapiés	1	66 x 68 x 52	8

GARDENIAS COLLECTION

GARDENIAS OUTDOOR

Jaime Hayon

Structure in aluminium and laminates in extruded aluminium. Powder coating in white (RAL 9001), grey (RAL 7015) or green (RAL 6021). Detachable upholstered cushions; Covers are removable for washing; Apt for outdoors with water-repellent foam.

Estructura fabricada en fundición y laminas en extrusión de aluminio. Pintadas en blanco (RAL 9001), gris (RAL 7015) o verde (RAL 6021). Tapicería desmontable, desenfundable y con tejido apto para exterior y espuma hidrófuga.

ARMCHAIR / SILLÓN

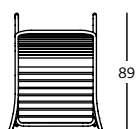
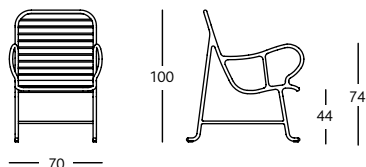

GARSIND04	White / Blanco	1.495
GARSIND16	Green / Verde	1.495
GARSIND13	Grey (cool effect) / Gris (efecto cool)	1.636

Outdoor cushions / Cojines outdoor
(GAMA fabrics / Tejidos GAMA) 403

BENCH / SOFÁ (Until stocks last / hasta agotar existencias)

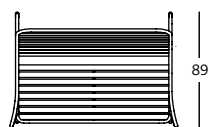
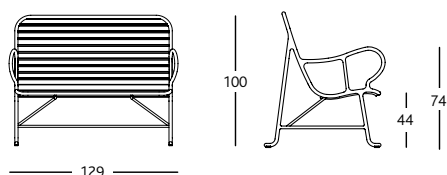

GARSDOB04	White / Blanco	2.258
GARSDOB16	Green / Verde	2.258
GARSDOB13	Grey (cool effect) / Gris (efecto cool)	2.463

Outdoor cushions / Cojines outdoor
(GAMA fabrics / Tejidos GAMA) 750

ARMCHAIR WITH PERGOLA / SILLÓN CON PÉRGOLA

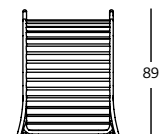
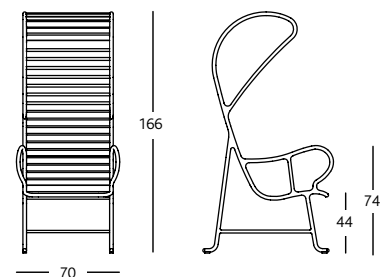

GARSPER04	White / Blanco	2.668
GARSPER16	Green / Verde	2.668
GARSPER13	Grey (cool effect) / Gris (efecto cool)	2.753

Outdoor cushions / Cojines outdoor
(GAMA fabrics / Tejidos GAMA) 403

PACKAGING

	PCS	DIMENSIONS CM	GROSS KG
Armchair / Sillón	1	100 x 82 x 112	26
Bench / Sofá	1	155 x 100 x 112	53
Armchair with pergola / Sillón con pérgola	1	100 x 90 x 188	40



Delta Silver Award 2014 / Premio Delta Plata 2014



GARDENIAS INDOOR

Jaime Hayon

Structure in cast aluminium and laminates in extruded aluminium. Powder coating in Alesta Anodic Black or in high-gloss yellow (RAL 1005).
Seat and backrest upholstered in different fabrics and leathers provided by BD. Piping in the same colour as the structure.

Estructura fabricada en fundición y laminas en extrusión de aluminio. Pintada en polvo en Anodic Black o en Amarillo brillante (RAL 1005).
Asiento y respaldo tapizados en los diferentes tejidos y pieles de BD. Ribete del mismo color de la estructura.

ARMCHAIR / SILLÓN

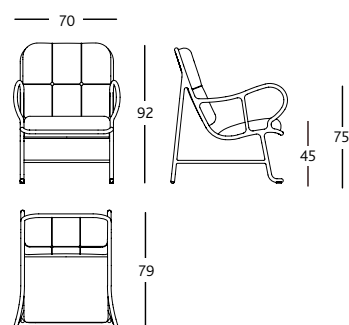

*COM	Fabrics / Telas					Leather / Piel		
	CAT 1	CAT 2	CAT 3	CAT 4	P	S	V/F	
2.633	2.642	2.648	2.654	2.713	2.877	2.999	3.037	
STRUCTURE AND LEATHER IN YELLOW / ESTRUCTURA Y PIEL EN AMARILLO							F	
								3.222

*COM : Customer own material / material del cliente

Metres of material required / Metros de material requerido

Fabric 80 x 140 cm - Leather 1,67m² / Tela 80 x 140 cm - Piel 1,67m²

Customize your own version with our online configurator
Personaliza tu propia versión con nuestro configurador online
www.bdbarcelona.com

BENCH / SOFÁ

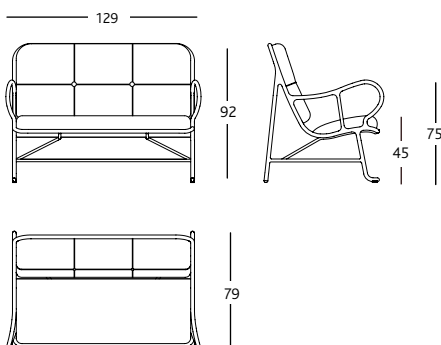

*COM	Fabrics / Telas					Leather / Piel		
	CAT 1	CAT 2	CAT 3	CAT 4	P	S	V/F	
4.082	4.026	4.071	4.275	4.330	4.418	4.481	4.679	
STRUCTURE AND LEATHER IN YELLOW / ESTRUCTURA Y PIEL EN AMARILLO							F	
								5.131

*COM : Customer own material / material del cliente

Metres of material required / Metros de material requerido

Fabric 360 x 140 cm - Leather 2,5m² / Tela 360 x 140 cm - Piel 2,5m²

F

5.131

ARMCHAIR WITH PERGOLA / SILLÓN CON PÉRGOLA

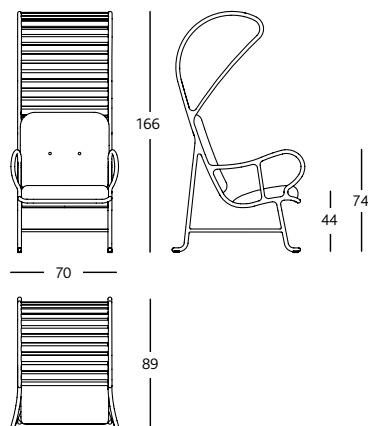

*COM	Fabrics / Telas					Leather / Piel		
	CAT 1	CAT 2	CAT 3	CAT 4	P	S	V/F	
4.180	4.239	4.275	4.414	4.473	4.508	4.473	4.601	
STRUCTURE AND LEATHER IN YELLOW / ESTRUCTURA Y PIEL EN AMARILLO							F	
								4.923

*COM : Customer own material / material del cliente

Metres of material required / Metros de material requerido

Fabric 180 x 140 cm - Leather 1,67m² / Tela 180 x 140 cm - Piel 1,67m²

PACKAGING

	PCS	DIMENSIONS CM	GROSS KG
Armchair / Sillón	1	100 x 82 x 112	26
Bench / Sofá	1	155 x 100 x 112	53
Armchair with pergola / Sillón con pérgola	1	100 x 90 x 188	40

LITTLE COUTURE

Färg & Blanche

Solid wooden seat structure and upholstered. Exterior backrest made up of two birch plywood pieces sewn together and stained in a degraded colour. Upholstered in different materials and leathers provided by BD. Optional swivel system.

Estructura del asiento en madera de haya maciza, tapizada. Respaldo en madera contrachapada de abedul, teñido con un degradado de color, formado por dos piezas cosidas entre sí con hilo de poliamida. Tapizado no desenfundable en los diferentes tejidos y pieles de BD. Sistema giratorio opcional.

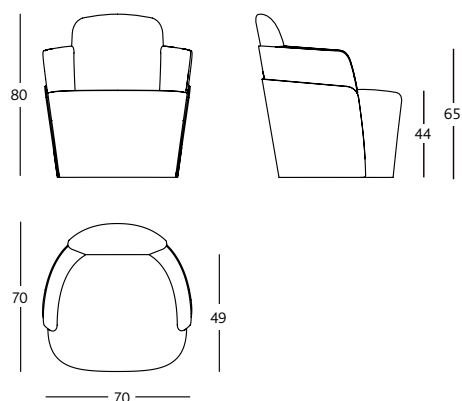

	Fabrics / Telas					Leather / Piel		
	*COM	CAT 1	CAT 2	CAT 3	CAT 4	P	S	V/F
Little Couture	2.795	2.929	2.965	3.026	3.087	3.251	3.372	3.501

Swivel System / Sistema giratorio +368

*COM : Customer's own material / Tejido o piel del cliente

Metres of material required / Metros de material requerido
Fabric / Tela 150 x 140 cm - Leather / Piel 3 m²

PACKAGING

PCS	DIMENSIONS CM	GROSS KG
1	100 x 83 x 100	30

COUTURE ARMCHAIR / BUTACA

Färg & Blanche

Solid wooden structure and upholstered seat. Birch plywood backrest made up of pieces sewn together with a polyamide thread and stained in a degraded color or in walnut nature effect. Upholstered in different leathers or fabrics provided by BD. Optional swivel system.

Estructura del asiento en madera maciza tapizada. Respaldo en madera contrachapada de abedul, teñido con un degradado de color o nogal formada por piezas cosidas entre ellas con hilo de poliamida. Tapizado en los diferentes tejidos y pieles de BD. Incorpora la posibilidad de sistema giratorio.

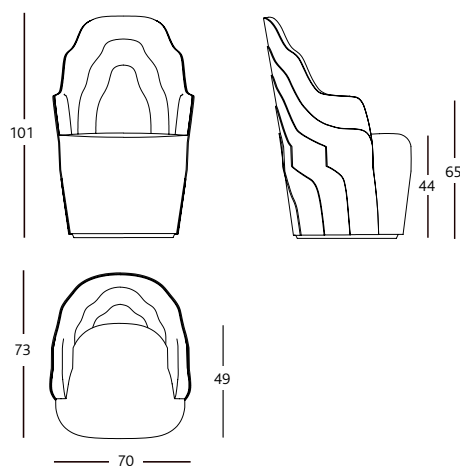

	Fabrics / Telas					Leather / Piel		
	*COM	CAT 1	CAT 2	CAT 3	CAT 4	P	S	V/F
Degraded birch / Abedul degradado	3.571	3.632	3.681	3.742	3.803	4.244	4.338	4.547
Walnut nature effect / Nogal efecto nature	3.215	3.271	3.320	3.377	3.434	3.850	3.942	4.135

(Until stocks last / hasta agotar existencias)

Swivel System / Sistema giratorio +368

*COM : Customer's own material / Tejido o piel del cliente

Metres of material required / Metros de material requerido
Fabric / Tela 250 x 140 cm - Leather / Piel 4 m²

PACKAGING

PCS	DIMENSIONS CM	GROSS KG
1	100 x 83 x 120	38



DALILIPS 

Salvador Dalí

A two-seat sofa made of polyethylene with a rotational moulding process in red. For indoor and outdoor use.
Sofá de dos plazas realizado en polietileno rotomoldeado en masa. Color Rojo Bermellón. Para uso interior y exterior.

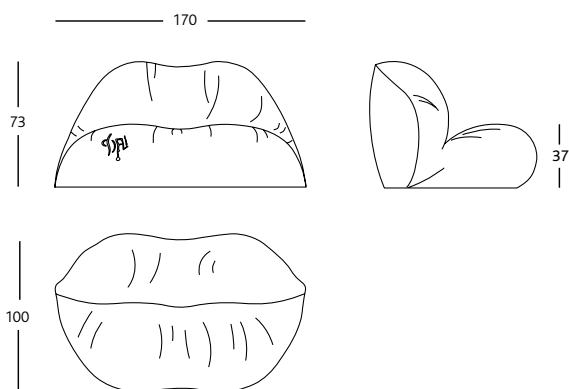

DA1006 **Dalilips Red / Rojo (Pantone 200C)** 2.219

Extra reinforced packaging (Crate) + 680€
Packaging reforzado extra (Jaula)

National transport included. Transport outside of Spain not included.
Transporte nacional incluido. Transporte fuera de España no incluido.

 Delivery in 3 weeks. Consult conditions.
Entrega en 3 semanas. Consultar condiciones.

PACKAGING

PCS	DIMENSIONS CM	GROSS KG
1	175 x 110 x 95	35

© SALVADOR DALÍ / FUNDACIÓN GALA-SALVADOR DALÍ, BARCELONA, 2023

GAULINO EASY CHAIR / SILLONCITO

Oscar Tusquets

Frame in natural varnished solid ash, ash stained black or coral red (RAL 3016).
Seat upholstered in natural hide, black hide or toasted hide.

Estructura y respaldo en fresno macizo natural barnizado, fresno teñido en negro o en rojo coral (RAL 3016).
Asiento tapizado en cuero natural, negro o tostado.

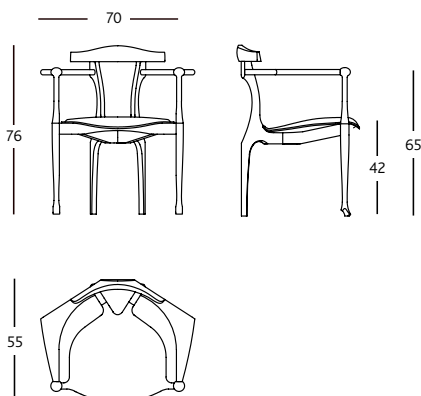

GAUBUFR13C13	Natural	
GAUBUFR10C10	 Black / Negro	1.787
GAUBUFR20C20	Coral red / Rojo coral	

Soft felt glides included. See page 18 / Tacos de fieltro incluidos. Ver página 18

 Delivery in 3 weeks. Consult conditions.
Entrega en 3 semanas. Consultar condiciones.

PACKAGING

PCS	DIMENSIONS CM	GROSS KG
1	78 x 84 x 83	13

CHAIRS AND STOOLS / SILLAS Y TABURETES

GAULINETTA CHAIR / SILLA

Oscar Tusquets

Frame in natural varnished solid ash, ash stained black or coral red (RAL 3016).

Seat upholstered in natural hide, black hide or toasted hide.

Estructura y respaldo en fresno macizo natural barnizado, fresno teñido en negro o en rojo coral (RAL 3016).

Asiento tapizado en cuero natural, negro o tostado.

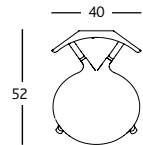
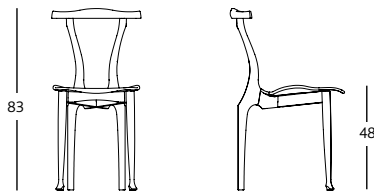

GAUTFR13C13	Natural	
GAUTFR10C10	Black / Negro	1.072
GAUTFR20C20	Coral red / Rojo coral	

Soft felt glides included. See page 18 / *Tacos de fieltro incluidos. Ver pág. 18*

Delivery in 3 weeks. Consult conditions.
Entrega en 3 semanas. Consultar condiciones.

PACKAGING

PCS	DIMENSIONS CM	GROSS KG
1	60 x 60 x 85	5

GAULINO CHAIR / SILLA

Oscar Tusquets

Frame in natural varnished solid ash, ash stained black or coral red (RAL 3016).

Seat upholstered in natural hide, black hide or toasted hide.

Estructura y respaldo en fresno macizo natural barnizado, fresno teñido en negro o en rojo coral (RAL 3016).

Asiento tapizado en cuero natural, negro o tostado.

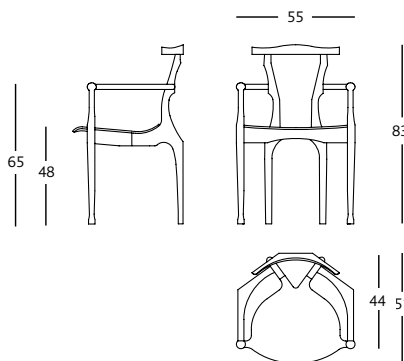

GAUFR13C13	Natural	
GAUFR10C10	Black / Negro	1.286
GAUFR20C20	Coral red / Rojo coral	

Soft felt glides included. See page 18 / *Tacos de fieltro incluidos. Ver pág. 18*

Delivery in 3 weeks. Consult conditions.
Entrega en 3 semanas. Consultar condiciones.

See matching table on pag. 44 / *Ver mesa a juego en pág. 44*

PACKAGING

PCS	DIMENSIONS CM	GROSS KG
1	60 x 60 x 90	8



GAULINO STOOL / TABURETE

Oscar Tusquets

Frame in natural varnished solid ash, ash stained black or coral red (RAL 3016).
Seat upholstered in natural hide, black hide or toasted hide.

Estructura y respaldo en fresno macizo natural barnizado, fresno teñido en negro o en rojo coral (RAL 3016).
Asiento tapizado en cuero natural, negro o tostado.

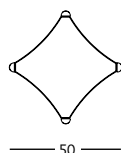
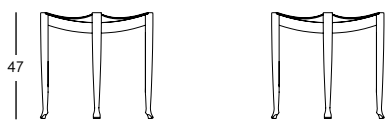

Natural

Black / Negro

924

Coral red / Rojo coral

PACKAGING

PCS	DIMENSIONS CM	GROSS KG
1	60 x 60 x 60	4

CHAIR B

Konstantin Grcic

The lateral sides and upper side of the seat are made of veneered beech plywood. The underside is veneered in ash wood. The backrest is made of solid ash wood. Finishes: varnished in natural ash or lacquered black. Bottom structure in tubular steel and pieces in cast aluminium with a powder coating in white or black. An upholstered leather or fabric seat version is also available.

Laterales en madera contrachapada de haya. Asiento en madera contrachapada de haya con cara superior en fresno y inferior en haya. Respaldo en madera maciza de fresno. Madera barnizada o teñido negro. Estructura inferior en tubo de acero y piezas de fundición en aluminio. Pintada en polvo en blanco o negro. Disponible versión con asiento tapizado en piel y tejido.

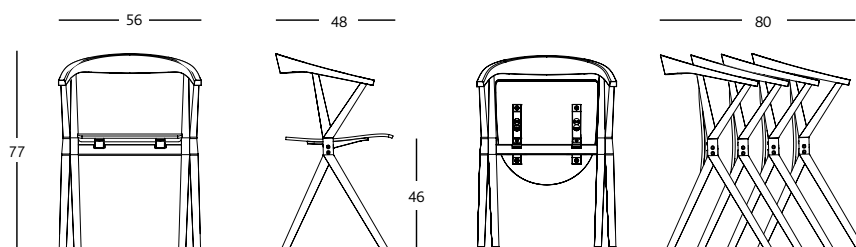

	Fabrics / Telas				Leather / Piel			
	CAT 1	CAT 2	CAT 3	CAT 4	P	S	V/F	
Natural ash Fresno natural	764	917	927	937	954	977	1.010	1.036
Black lacquered ash Fresno lacado negro	787	927	938	954	966	987	1.019	1.045

Soft felt glides included. See page 18 / Tacos de fieltro incluidos. Ver pág 18

See matching table on page 47 / Ver mesa a juego en pág. 47



Delta Silver Award 2011 / Premio Delta Plata 2011

	PCS	DIMENSIONS CM	GROSS KG
Not upholstered seat / Asiento no tapizado	1	60 x 45 x 82	8
Upholstered seat / Asiento tapizado	1	60 x 45 x 82	10

MINIVARIUS CHAIR / SILLA

Oscar Tusquets

Structure in tubular steel painted in anodic black. A one-piece seat in gas injected polypropylene in black or white. Also available in an upholstered version in BD materials.

Estructura en tubo de acero pintado en anodic black. Asiento monocarcasa, en polipropileno inyectado con gas en blanco o negro. Asiento tapizado en los diferentes tejidos de BD.

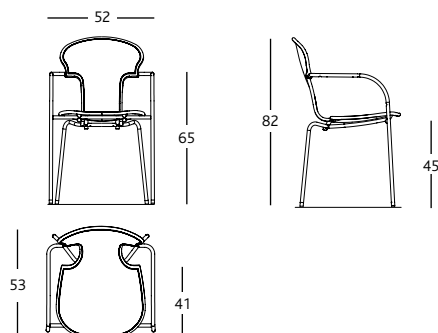

Fabrics / Telas

	PL	*COM	CAT1	CAT2	CAT3	CAT4
Minivarius	233	485	592	619	664	700

- For fabric widths of 1'6m, 1'3m is needed.
- For fabric widths of 1'4m, 1'5m is needed.
- See finishes pages 7-14

- Para anchos de tela de 1'6m, se necesitan 1'3m.
- Para anchos de tela de 1'4m, se necesitan 1'5m.
- Ver acabados páginas 7-17

*COM : Customer's own material / Tejido o piel del cliente



Delivery in 3 weeks. Consult conditions.
Entrega en 3 semanas. Consultar condiciones.

PACKAGING

PCS	MEDIDAS CM	GROSS KG
1	65 x 58 x 110	11

VARIUS CHAIR / SILLA

Oscar Tusquets

Structure in tubular steel and coated with polyester paint in black. Upholstered in the various BD fabrics and leather finishes. Armrests available in black or toasted hide.

Estructura en tubo de acero pintado en poliéster en color negro. Tapicería en los diferentes tejidos y pieles de BD. Apoyabrazos en cuero Negro o tostado.

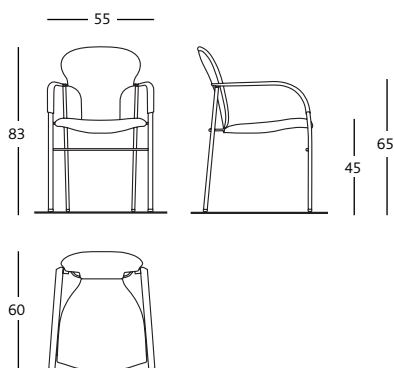

Fabrics / Telas

Leather / Piel

	*COM	CAT 1	CAT 2	CAT 3	CAT 4	P	F900
Varius	1.029	1.071	1.092	1.113	1.134	1.377	1.481

*COM : Customer's own material / Tejido o piel del cliente

Metres of material required / Metros de material requerido

Fabric / Tela 150 x 140 cm - Leather / Piel 2,5 m²

PACKAGING

PCS	MEDIDAS CM	GROSS KG
1	65 x 58 x 110	11



SHOWTIME & SHOWTIME NUDE CHAIR / SILLA

Jaime Hayon

Two backrests: low backrest (Showtime), medium backrest (Showtime Nude). 4 distinct leg structures. Available in a wide variety of finishes - wooden or lacquered (in diverse colours) and upholstered in different materials and leathers by BD, which avails all possible combinations and contrasts.

Dos alturas diferentes para el respaldo: respaldo bajo (Showtime), respaldo medio (Showtime Nude). 4 estructuras distintas para las patas. Disponible en un amplio programa de acabados - madera o lacados en diversos colores y tapizados en diferentes tejidos y pieles de BD - que admiten todas las combinaciones y contrastes posibles.

SHOWTIME (low backrest / respaldo bajo)

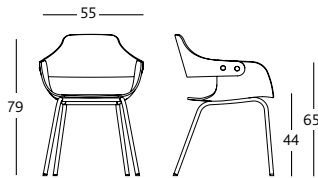
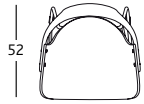
SHOWTIME
METAL LEGS / PATAS METAL

Lacquered or Natural ash
Laca o fresno natural

Walnut / Ash stained (oak or black)
Nogal / Fresno teñido (roble o negro)

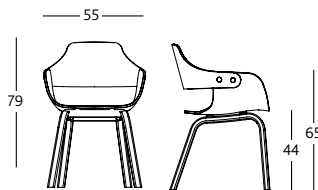
SHOWTIME
WOODEN LEGS / PATAS MADERA

Lacquered or Natural ash
Laca o fresno natural

Walnut / Ash stained (oak or black)
Nogal / Fresno teñido (roble o negro)

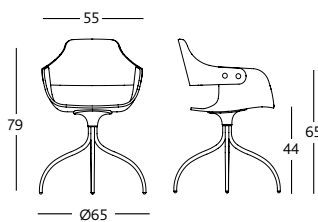
SHOWTIME
SWIVEL BASE / PIE GIRATORIO

Lacquered or Natural ash
Laca o fresno natural

Walnut / Ash stained (oak or black)
Nogal / Fresno teñido (roble o negro)

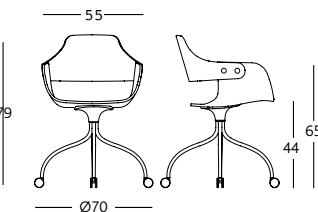
SHOWTIME
WHEELS / RUEDAS

Lacquered or Natural ash
Laca o fresno natural

Walnut / Ash stained (oak or black)
Nogal / Fresno teñido (roble o negro)

SHOWTIME NUDE (medium backrest / respaldo medio)

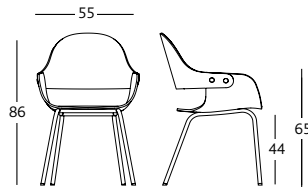
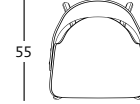
SHOWTIME NUDE
METAL LEGS / PATAS METAL

Natural ash
Fresno natural

Walnut / Ash stained black
Nogal / Fresno teñido negro

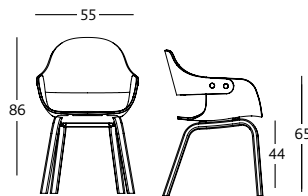
SHOWTIME NUDE
WOODEN LEGS / PATAS MADERA

Natural ash
Fresno natural

Walnut / Ash stained black
Nogal / Fresno teñido negro

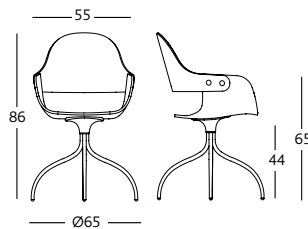
SHOWTIME NUDE
SWIVEL BASE / PIE GIRATORIO

Natural ash
Fresno natural

Walnut / Ash stained black
Nogal / Fresno teñido negro

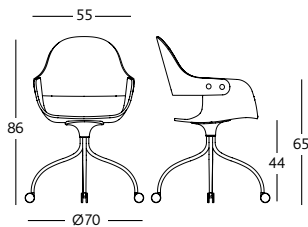



SHOWTIME NUDE
WHEELS / RUEDAS

Natural ash
Fresno natural

Walnut / Ash stained black
Nogal / Fresno teñido negro





Upholstered seat height will be 45cm and arm height in case of additional armrests will be 67cm
La altura del asiento tapizado será de 45 cm y la altura del brazo en caso de reposabrazos adicionales será de 67 cm.

SHOWTIME 4 METAL LEGS / 4 PATAS METAL

	WOOD	COM	CAT 1	CAT 2	CAT 3	CAT 4	P	S	V / F
	Lacquered or Natural ash / <i>Laca o fresno natural</i>	618							
	Walnut / Ash stained (oak or black) <i>Nogal / Fresno teñido (roble o negro)</i>	644							
	Lacquered or Natural ash / <i>Laca o fresno natural</i>	793	821	833	838	850	870	893	907
	Walnut / Ash stained (oak or black) <i>Nogal / Fresno teñido (roble o negro)</i>	821	850	861	867	878	899	922	935
	Lacquered or Natural ash / <i>Laca o fresno natural</i> (Armrests included / <i>Reposabrazos incluidos</i>)	865	942	963	984	1.020	1.075	1.127	1.164
	Walnut / Ash stained (oak or black) <i>Nogal / Fresno teñido (roble o negro)</i> (Armrests included / <i>Reposabrazos incluidos</i>)	891	968	989	1.009	1.045	1.101	1.153	1.190
	Lacquered or Natural ash / <i>Laca o fresno natural</i>	840	930	961	988	1.035	1.096	1.171	1.214
	Walnut / Ash stained (oak or black) <i>Nogal / Fresno teñido (roble o negro)</i>	867	956	988	1.014	1.061	1.123	1.197	1.240
	Lacquered or Natural ash / <i>Laca o fresno natural</i> (Armrests included / <i>Reposabrazos incluidos</i>)	968	1.107	1.148	1.190	1.262	1.358	1.463	1.530
	Walnut / Ash stained (oak or black) <i>Nogal / Fresno teñido (roble o negro)</i> (Armrests included / <i>Reposabrazos incluidos</i>)	994	1.133	1.174	1.215	1.288	1.384	1.489	1.555





See optional accessories on pag. 80 / Ver accesorios opcionales en pág. 80

SHOWTIME 4 WOODEN LEGS / 4 PATAS MADERA

	WOOD	COM	CAT 1	CAT 2	CAT 3	CAT 4	P	S	V / F
	Lacquered or Natural ash / <i>Laca o fresno natural</i>	795							
	Walnut / Ash stained (oak or black) <i>Nogal / Fresno teñido (roble o negro)</i>	822							
	Lacquered or Natural ash / <i>Laca o fresno natural</i>	988	1.016	1.027	1.033	1.044	1.065	1.088	1.102
	Walnut / Ash stained (oak or black) <i>Nogal / Fresno teñido (roble o negro)</i>	1.017	1.045	1.057	1.062	1.074	1.094	1.117	1.131
	Lacquered or Natural ash / <i>Laca o fresno natural</i> (Armrests included / <i>Reposabrazos incluidos</i>)	1.042	1.119	1.140	1.161	1.197	1.252	1.304	1.341
	Walnut / Ash stained (oak or black) <i>Nogal / Fresno teñido (roble o negro)</i> (Armrests included / <i>Reposabrazos incluidos</i>)	1.069	1.146	1.167	1.187	1.223	1.278	1.331	1.367
	Lacquered or Natural ash / <i>Laca o fresno natural</i>	1.021	1.110	1.142	1.168	1.215	1.277	1.352	1.395
	Walnut / Ash stained (oak or black) <i>Nogal / Fresno teñido (roble o negro)</i>	1.048	1.137	1.169	1.195	1.242	1.304	1.379	1.422
	Lacquered or Natural ash / <i>Laca o fresno natural</i> (Armrests included / <i>Reposabrazos incluidos</i>)	1.145	1.284	1.325	1.367	1.439	1.535	1.640	1.707
	Walnut / Ash stained (oak or black) <i>Nogal / Fresno teñido (roble o negro)</i> (Armrests included / <i>Reposabrazos incluidos</i>)	1.172	1.311	1.352	1.393	1.465	1.562	1.667	1.733

See optional accessories on pag. 87 / Ver accesorios opcionales en pág. 87

SHOWTIME SWIVEL BASE / BASE GIRATORIA

		WOOD	COM	CAT 1	CAT 2	CAT 3	CAT 4	P	S	V / F
	Lacquered or Natural ash / <i>Laca o fresno natural</i>	893								
	Walnut / Ash stained (oak or black) <i>Nogal / Fresno teñido (roble o negro)</i>	919								
	Lacquered or Natural ash / <i>Laca o fresno natural</i>		1.095	1.123	1.135	1.140	1.152	1.172	1.195	1.209
	Walnut / Ash stained (oak or black) <i>Nogal / Fresno teñido (roble o negro)</i>		1.124	1.152	1.164	1.169	1.181	1.201	1.224	1.238
	Lacquered or Natural ash / <i>Laca o fresno natural</i> (Armrests included / <i>Reposabrazos incluidos</i>)		1.140	1.217	1.238	1.258	1.294	1.349	1.402	1.438
	Walnut / Ash stained (oak or black) <i>Nogal / Fresno teñido (roble o negro)</i> (Armrests included / <i>Reposabrazos incluidos</i>)		1.166	1.243	1.264	1.284	1.320	1.376	1.428	1.465
	Lacquered or Natural ash / <i>Laca o fresno natural</i>		1.120	1.210	1.241	1.268	1.315	1.376	1.451	1.494
	Walnut / Ash stained (oak or black) <i>Nogal / Fresno teñido (roble o negro)</i>		1.147	1.237	1.268	1.294	1.342	1.403	1.478	1.521
	Lacquered or Natural ash / <i>Laca o fresno natural</i> (Armrests included / <i>Reposabrazos incluidos</i>)		1.243	1.382	1.423	1.464	1.536	1.633	1.738	1.804
	Walnut / Ash stained (oak or black) <i>Nogal / Fresno teñido (roble o negro)</i> (Armrests included / <i>Reposabrazos incluidos</i>)		1.269	1.408	1.449	1.490	1.563	1.659	1.764	1.830

See optional accessories on pag. 87 / Ver accesorios opcionales en pág. 87

STORAGE AND SHELVING
ESTANTERÍAS Y CONTENEDORES

TABLES
MESAS

ARMCHAIRS
BUTACAS

CHAIRS AND STOOLS
SILLAS Y TABURETES





ACCESSORIES
ACCESORIOS

LIGHTING
ILUMINACIÓN

PUBLIC SEATING
ASIENTOS PÚBLICOS







ART EDITIONS

SHOWTIME WHEELS / RUEDAS

	WOOD	COM	CAT 1	CAT 2	CAT 3	CAT 4	P	S	V / F
	Lacquered or Natural ash / <i>Laca o fresno natural</i>	1.007							
	Walnut / Ash stained (oak or black) <i>Nogal / Fresno teñido (roble o negro)</i>	1.034							
	Lacquered or Natural ash / <i>Laca o fresno natural</i>	1.221	1.249	1.261	1.266	1.278	1.298	1.321	1.335
	Walnut / Ash stained (oak or black) <i>Nogal / Fresno teñido (roble o negro)</i>	1.250	1.278	1.290	1.295	1.307	1.327	1.351	1.364
	Lacquered or Natural ash / <i>Laca o fresno natural</i> (Armrests included / <i>Reposabrazos incluidos</i>)	1.254	1.331	1.352	1.373	1.409	1.464	1.516	1.553
	Walnut / Ash stained (oak or black) <i>Nogal / Fresno teñido (roble o negro)</i> (Armrests included / <i>Reposabrazos incluidos</i>)	1.281	1.358	1.379	1.399	1.435	1.490	1.543	1.579
	Lacquered or Natural ash / <i>Laca o fresno natural</i>	1.237	1.327	1.358	1.384	1.432	1.493	1.568	1.611
	Walnut / Ash stained (oak or black) <i>Nogal / Fresno teñido (roble o negro)</i>	1.264	1.354	1.385	1.411	1.459	1.520	1.595	1.638
	Lacquered or Natural ash / <i>Laca o fresno natural</i> (Armrests included / <i>Reposabrazos incluidos</i>)	1.357	1.496	1.537	1.579	1.651	1.747	1.852	1.919
	Walnut / Ash stained (oak or black) <i>Nogal / Fresno teñido (roble o negro)</i> (Armrests included / <i>Reposabrazos incluidos</i>)	1.384	1.523	1.564	1.605	1.677	1.774	1.879	1.945







See optional accessories on pag. 87 / *Ver accesorios opcionales en pág. 87*

SHOWTIME NUDE 4 METAL LEGS / 4 PATAS METAL

	WOOD	COM	CAT 1	CAT 2	CAT 3	CAT 4	P	S	V / F
	Natural ash / <i>Fresno natural</i>	644							
	Walnut / Ash stained black <i>Nogal / Fresno teñido negro</i>	670							
	Natural ash / <i>Fresno natural</i>		821	850	861	867	878	899	922 935
	Walnut / Ash stained black <i>Nogal / Fresno teñido negro</i>		850	878	889	895	906	927	950 964
	Natural ash / <i>Fresno natural</i> (Armrests included / <i>Reposabrazos incluidos</i>)		891	968	989	1.009	1.045	1.101	1.153 1.190
	Walnut / Ash stained black <i>Nogal / Fresno teñido negro</i> (Armrests included / <i>Reposabrazos incluidos</i>)		917	994	1.015	1.035	1.071	1.126	1.179 1.215
	Natural ash / <i>Fresno natural</i>		893	972	1.003	1.030	1.077	1.149	1.224 1.273
	Walnut / Ash stained black <i>Nogal / Fresno teñido negro</i>		919	998	1.030	1.056	1.103	1.176	1.251 1.299
	Natural ash / <i>Fresno natural</i> (Armrests included / <i>Reposabrazos incluidos</i>)		979	1.148	1.190	1.231	1.303	1.410	1.515 1.587
	Walnut / Ash stained black <i>Nogal / Fresno teñido negro</i> (Armrests included / <i>Reposabrazos incluidos</i>)		1.004	1.174	1.215	1.257	1.329	1.436	1.541 1.613
	Natural ash / <i>Fresno natural</i>		912	999	1.020	1.030	1.051	1.090	1.132 1.158
	Walnut / Ash stained black <i>Nogal / Fresno teñido negro</i>		937	1.025	1.045	1.056	1.076	1.116	1.158 1.184
	Natural ash / <i>Fresno natural</i> (Armrests included / <i>Reposabrazos incluidos</i>)		1.056	1.179	1.221	1.251	1.324	1.410	1.526 1.598
	Walnut / Ash stained black <i>Nogal / Fresno teñido negro</i> (Armrests included / <i>Reposabrazos incluidos</i>)		1.082	1.205	1.246	1.277	1.349	1.436	1.552 1.624







See optional accessories on pag. 87 / Ver accesorios opcionales en pág. 87

SHOWTIME NUDE 4 WOODEN LEGS / 4 PATAS MADERA

	WOOD	COM	CAT 1	CAT 2	CAT 3	CAT 4	P	S	V / F
	Natural ash / <i>Fresno natural</i>	822							
	Walnut / Ash stained black <i>Nogal / Fresno teñido negro</i>	848							
	Natural ash / <i>Fresno natural</i>		1.017	1.045	1.057	1.062	1.074	1.094	1.117 1.131
	Walnut / Ash stained black <i>Nogal / Fresno teñido negro</i>		1.046	1.074	1.086	1.091	1.103	1.123	1.146 1.160
	Natural ash / <i>Fresno natural</i> (Armrests included / <i>Reposabrazos incluidos</i>)		1.069	1.146	1.167	1.187	1.223	1.278	1.331 1.367
	Walnut / Ash stained black <i>Nogal / Fresno teñido negro</i> (Armrests included / <i>Reposabrazos incluidos</i>)		1.095	1.172	1.193	1.214	1.250	1.305	1.357 1.394
	Natural ash / <i>Fresno natural</i>		1.074	1.153	1.185	1.211	1.258	1.331	1.406 1.454
	Walnut / Ash stained black <i>Nogal / Fresno teñido negro</i>		1.101	1.180	1.212	1.238	1.285	1.358	1.433 1.481
	Natural ash / <i>Fresno natural</i> (Armrests included / <i>Reposabrazos incluidos</i>)		1.156	1.326	1.367	1.409	1.481	1.588	1.693 1.765
	Walnut / Ash stained black <i>Nogal / Fresno teñido negro</i> (Armrests included / <i>Reposabrazos incluidos</i>)		1.183	1.353	1.394	1.435	1.507	1.615	1.720 1.791
	Natural ash / <i>Fresno natural</i>		1.089	1.177	1.197	1.208	1.228	1.268	1.310 1.336
	Walnut / Ash stained black <i>Nogal / Fresno teñido negro</i>		1.116	1.203	1.224	1.234	1.255	1.294	1.336 1.362
	Natural ash / <i>Fresno natural</i> (Armrests included / <i>Reposabrazos incluidos</i>)		1.234	1.357	1.398	1.429	1.501	1.588	1.704 1.776
	Walnut / Ash stained black <i>Nogal / Fresno teñido negro</i> (Armrests included / <i>Reposabrazos incluidos</i>)		1.260	1.384	1.425	1.456	1.528	1.615	1.730 1.802







See optional accessories on pag. 87 / Ver accesorios opcionales en pág. 87

SHOWTIME NUDE SWIVEL BASE / BASE GIRATORIA

		WOOD	COM	CAT 1	CAT 2	CAT 3	CAT 4	P	S	V / F
	Natural ash / <i>Fresno natural</i>	919								
	Walnut / Ash stained black <i>Nogal / Fresno teñido negro</i>	945								
	Natural ash / <i>Fresno natural</i>		1.124	1.152	1.164	1.169	1.181	1.201	1.224	1.238
	Walnut / Ash stained black <i>Nogal / Fresno teñido negro</i>		1.153	1.181	1.192	1.198	1.209	1.230	1.253	1.267
	Natural ash / <i>Fresno natural</i> (Armrests included / <i>Reposabrazos incluidos</i>)		1.166	1.243	1.264	1.284	1.320	1.376	1.428	1.465
	Walnut / Ash stained black <i>Nogal / Fresno teñido negro</i> (Armrests included / <i>Reposabrazos incluidos</i>)		1.192	1.269	1.290	1.311	1.347	1.402	1.454	1.491
	Natural ash / <i>Fresno natural</i>		1.174	1.252	1.284	1.310	1.357	1.430	1.505	1.553
	Walnut / Ash stained black <i>Nogal / Fresno teñido negro</i>		1.200	1.279	1.311	1.337	1.384	1.457	1.532	1.580
	Natural ash / <i>Fresno natural</i> (Armrests included / <i>Reposabrazos incluidos</i>)		1.254	1.423	1.465	1.506	1.578	1.685	1.790	1.862
	Walnut / Ash stained black <i>Nogal / Fresno teñido negro</i> (Armrests included / <i>Reposabrazos incluidos</i>)		1.280	1.450	1.491	1.532	1.604	1.712	1.817	1.888
	Natural ash / <i>Fresno natural</i>		1.187	1.274	1.295	1.305	1.326	1.365	1.407	1.433
	Walnut / Ash stained black <i>Nogal / Fresno teñido negro</i>		1.213	1.300	1.321	1.331	1.352	1.391	1.433	1.459
	Natural ash / <i>Fresno natural</i> (Armrests included / <i>Reposabrazos incluidos</i>)		1.331	1.454	1.496	1.526	1.599	1.685	1.801	1.873
	Walnut / Ash stained black <i>Nogal / Fresno teñido negro</i> (Armrests included / <i>Reposabrazos incluidos</i>)		1.357	1.481	1.522	1.553	1.625	1.712	1.827	1.899







See optional accessories on pag. 87 / Ver accesorios opcionales en pág. 87

SHOWTIME NUDE WHEELS / RUEDAS

	WOOD	COM	CAT 1	CAT 2	CAT 3	CAT 4	P	S	V / F	
	Natural ash / <i>Fresno natural</i>	1.034								
	Walnut / Ash stained black <i>Nogal / Fresno teñido negro</i>	1.060								
	Natural ash / <i>Fresno natural</i>		1.250	1.278	1.290	1.295	1.307	1.327	1.351	1.364
	Walnut / Ash stained black <i>Nogal / Fresno teñido negro</i>		1.279	1.308	1.319	1.325	1.336	1.357	1.380	1.393
	Natural ash / <i>Fresno natural</i> (Armrests included / <i>Reposabrazos incluidos</i>)		1.281	1.358	1.379	1.399	1.435	1.490	1.543	1.579
	Walnut / Ash stained black <i>Nogal / Fresno teñido negro</i> (Armrests included / <i>Reposabrazos incluidos</i>)		1.307	1.384	1.405	1.426	1.462	1.517	1.569	1.606
	Natural ash / <i>Fresno natural</i>		1.291	1.369	1.401	1.427	1.474	1.547	1.622	1.670
	Walnut / Ash stained black <i>Nogal / Fresno teñido negro</i>		1.318	1.396	1.428	1.454	1.501	1.574	1.649	1.697
	Natural ash / <i>Fresno natural</i> (Armrests included / <i>Reposabrazos incluidos</i>)		1.368	1.538	1.579	1.621	1.693	1.800	1.905	1.977
	Walnut / Ash stained black <i>Nogal / Fresno teñido negro</i> (Armrests included / <i>Reposabrazos incluidos</i>)		1.395	1.565	1.606	1.647	1.719	1.827	1.932	2.003
	Natural ash / <i>Fresno natural</i>		1.301	1.389	1.409	1.420	1.440	1.480	1.522	1.548
	Walnut / Ash stained black <i>Nogal / Fresno teñido negro</i>		1.328	1.415	1.436	1.446	1.467	1.506	1.548	1.574
	Natural ash / <i>Fresno natural</i> (Armrests included / <i>Reposabrazos incluidos</i>)		1.446	1.569	1.610	1.641	1.713	1.800	1.916	1.988
	Walnut / Ash stained black <i>Nogal / Fresno teñido negro</i> (Armrests included / <i>Reposabrazos incluidos</i>)		1.472	1.596	1.637	1.668	1.740	1.827	1.942	2.014

See optional accessories on pag. 87 / *Ver accesorios opcionales en pág. 87*

SHOWTIME & SHOWTIME NUDE OPTIONAL ACCESSORIES / ACCESORIOS OPCIONALES

	COM	CAT1	CAT2	CAT3	CAT4	P	S	V/F
 Armrests / Brazos	131	158	169	175	186	206	228	236
 Removable cushion / Cojín extraíble Showtime & Nude	134	161	171	177	187	207	229	237
 Upholstered Seat / Asiento Tapizado Showtime & Nude	118	147	149	165	178	196	220	234
 *Upholstered interior seat/ Contra-Asiento Tapizado Showtime & Nude	257	337	342	380	421	461	498	525
 Upholstered Backrest / Respaldo Tapizado Showtime	109	175	184	218	259	297	353	384
 Upholstered Backrest / Respaldo Tapizado Showtime Nude	136	191	199	235	275	325	380	417
 Upholstered Interior Backrest / Respaldo Interior Tapizado Showtime Nude	175	240	235	256	270	286	308	322

*Armrests are compulsory for this option (see above for price) / Los brazos son obligatorios en esta versión (ver precio arriba).



Cushion diamond stitching / Cojín cosido rombos	66
Interior seat diamond stitching / Cosido rombos contra-asiento	83
Extra cost for non standard thread (per order) / Coste extra hilo no estándar	120
Soft felt glides swivel structure (4 un) / Tacos con fieltro base giratoria (4u)	38

For glides see page 18. / Para tacos ver página 18.

Metres of material required

Seat cushion - Fabric 60 x 140 cm - Leather 0,55 m²
 Removable cushion - Fabric 60 x 140 cm - Leather 0,55 m²
 Interior seat - Fabric 70 x 140 cm - Leather 0,65 m²
 Backrest Showtime - Fabric 80 x 140 cm - Leather 1,10 m²
 Backrest Nude - Fabric 90 x 140 cm - Leather 1,20 m²
 Interior backrest - Fabric 70 x 140 cm - leather 0,9 m²
 Armrests - Fabric 18 x 140 cm - Leather 0,2 m²

Metros de material requerido

Cojín - Tela 60 x 140 cm - Piel 0,55 m²
 Cojín extraíble - Tela 60 x 140 cm - Piel 0,55 m²
 Contra-Asiento - Tela 70 x 140 cm - Piel 0,65 m²
 Respaldo Showtime - Tela 80 x 140 cm - Piel 1,10 m²
 Respaldo Nude - Tela 90 x 140 cm - Piel 1,20 m²
 Respaldo interior - Tela 70 x 140 cm - Piel 0,9 m²
 Brazos - Tela 18 x 140 cm - Piel 0,2 m²

Customize your own version with our online configurator
 Personaliza tu propia versión con nuestro configurador online
www.bdbarcelona.com

PACKAGING			
	PCS	MEDIDAS CM	BRUTO KG
Showtime	1	65 x 58 x 86	11
Showtime Nude	1	60 x 65 x 95	12

SHOWTIME & SHOWTIME NUDE CHAIR FINISHES / ACABADOS

COLOUR OF STRUCTURE / COLOR DE ESTRUCTURA

Anthracite grey / *Gris antracita* (RAL 7021 matte)

Pale brown / *Marrón claro* (RAL 8025 matte)

Beige (RAL 1001 matte)

FABRICS AND LEATHER / TELAS Y PIELES

CAT 1 Libra P - Panama

CAT 2 Iris & Gaudí S - Sauvage

CAT 2 Laser J Flash V - Vintage

CAT 3 Fusion F - Florida

CAT 3 Nabucco

CAT 4 Moss

SEAT AND BACKREST FINISHES / ACABADOS RESPALDO Y

SHOWTIME CHAIR

MATTE LACQUER / LACA MATE:

White / *Blanco* LACM04 (RAL 9003)

Black / *Negro* LACM10 (RAL 9005)

Red / *Rojo* LACM19 (RAL 3004)

Blue / *Azul* LACM17 (RAL 5003)

WOOD / MADERA:

Walnut Nature Effect / *Nogal Efecto Nature*

Natural ash / *Fresno natural*

Ash stained oak / *Fresno teñido roble*

Ash stained black / *Fresno teñido negro*

SHOWTIME NUDE CHAIR

WOOD / MADERA:

Walnut Nature Effect / *Nogal Efecto Nature*

Natural ash / *Fresno natural*

Ash stained black / *Fresno teñido negro*

SHOWTIME & NUDE DIAMOND STITCHING FINISHES / ACABADO COSIDO ROMBOS - FABRICS / TELAS

CAT 1 - LIBRA

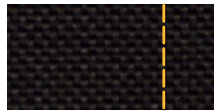

TL53 Dark Brown
+ Yellow 106



TL49 Grey
+ Dark Blue 13



TL62 Pink
+ Light Grey 70+2613

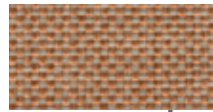

TL29 Pale Pink
+ Light Grey 70+2613

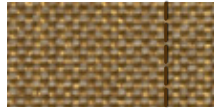

TL20 Beige
+ Brown 696

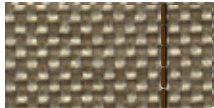

TL10 Brown
+ Brown 696

CAT 2 - IRIS

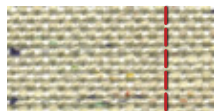

T15 Beige
+ Red 156



T11 Grey
+ Dark Grey 36

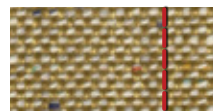

T120 Brown
+ Red 156

CAT 2 - GAUDÍ



TG02 Light Grey
+ Dark Grey 36

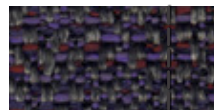

TG48 Purple
+ Dark Grey 36



TG60 Orange
+ Dark Grey 36

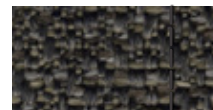

TG53 Dark Grey
+ Dark Grey 36



TG29 Pale Pink
+ Dark Grey 36

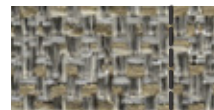

TG12 Grey
+ Dark Grey 36

CAT 2 - LASER J FLASH

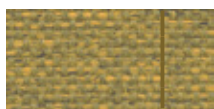

TJ01 Mustard
+ Brown 696



TJ02 Black
+ Cian 761



TJ03 Grey
+ Dark Grey 36



TJ04 Red
+ Dark Grey 36

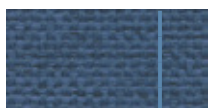

TJ05 Navy
+ Light Blue 112



TJ06 Green
+ Dark Grey 36

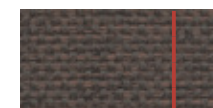

TJ07 Brown
+ Red 156

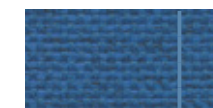

TJ08 Blue
+ Light Blue 112

STORAGE AND SHELVING
ESTANTERÍAS Y CONTENEDORES

TABLES
MESAS

ARMCHAIRS
BUTACAS

CHAIRS AND STOOLS
SILLAS Y TABURETES

ACCESSORIES
ACCESORIOS

LIGHTING
ILUMINACIÓN

PUBLIC SEATING
ASIENTOS PÚBLICOS

SHOWTIME & NUDE DIAMOND STITCHING FINISHES / ACABADO COSIDO ROMBOS - FABRICS / TELAS

CAT 3 - NABUCCO

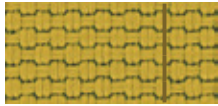

TN01 Mustard
+ Brown 696



TN02 Dark Orange
+ Dark Grey 36

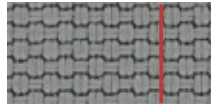

TN03 Beige
+ Red 156



TN04 Green
+ Dark Grey 36

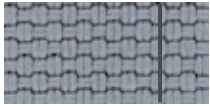

TN05 Grey
+ Dark Grey 36



TN06 Navy
+ Light Blue 112



TN07 Violeta
+ Dark Grey 36



TN08 Black
+ Cian 761

CAT 3 - FUSION



TF05 Beige
+ Red 156



TF125 Mustard
+ Brown 696

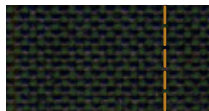

TF138 Green
+ Mustard 968

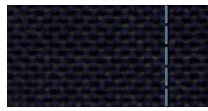

TF143 Blue
+ Light Blue 112



TF54 Light Grey
+ Dark Grey 36

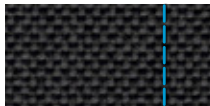

TF53 Dark Grey
+ Cian 761



TF122 Granet
+ Dark Grey 36



TF155 Anthracite
+ Cian 761

CAT 4 - MOSS

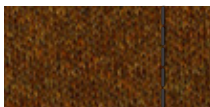

TM24 Orange Brown
+ Dark Grey 36

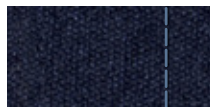

TM45 Blue
+ Light Blue 112



TM53 Dark Grey
+ Cian 761



TM65 Red
+ Dark grey 36

SHOWTIME & NUDE DIAMOND STITCHING FINISHES / ACABADO COSIDO ROMBOS - LEATHERS / PIELES

V - VINTAGE



V18 Camel
+ Brown 696



V24 Creta
+ Light Grey 70+2613



V23 Sepia
+ Dark Grey 36



V22 Grey
+ Brown 696



V19 T.Moro
+ Mustard 968

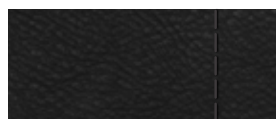

V10 Black
+ Dark Grey 36

S - SAUVAGE



S45 Clay
+ Brown 696



S40 Black
+ Dark Grey 36



S46 Alpine
+ Dark Grey 36



S50 Grapefruit
+ Dark Grey 36

F - FLORIDA



F25 Yellow
+ Brown 696



F15 Camel
+ Brown 696



F20 Dark Orange
+ Dark Grey 36

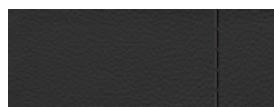

F27 CharcoalGrey
+ Dark Grey 36



F10 Black
+ Cian 761



F51 Brown
+ Brown 696



F52 Brown
+ Brown 696

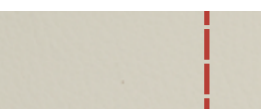

F53 Beige
+ Red 156

P - PANAMA

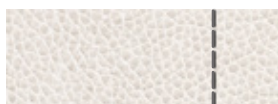

P04 White
+ Light Grey



P01 Sand
+ Burgundy 226



P15 Brown
+ Brown 696

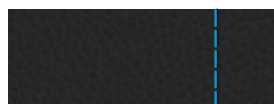

P10 Black
+ Cian 761

JAMAICA STOOL / TABURETE



Pepe Cortés

A steel chromed five legged stool. Swivel seat in a bright polished cast aluminium AG3 and anodised silver, or integrated with a solid varnished beech wooden seat. Available with wheels in a lower version.

All Black version (66cm and 77cm): anodic black steel structure and seat in stained beech wood or painted Anodic Black aluminium.

Taburete con estructura de 5 patas realizada en acero cromado. Asiento giratorio en fundición AG3 pulido scotch y anodizado plata o mecanizado en haya maciza barnizada. Versión taburete bajo con ruedas.

Versión All Black (66cm y 77cm): estructura de acero pintada en anodic black y asiento en madera de haya teñida o aluminio pintado anodic black.

	CHROMED STEEL / ACERO CROMADO		ALL BLACK	
	Aluminium seat Asiento aluminio	Beech seat Asiento madera	Aluminium seat Asiento aluminio	Beech seat Asiento madera
H. 45/48 *	599	757	-	-
H. 66/70 (Counter)	 556	729	 515	729
H. 77/80 (Bar)	 565	736	531	736

Aluminium / Aluminio

 Delivery in 1 week. Consult conditions.
Entrega en 1 semana. Consultar condiciones.

*Until stocks lasts / Hasta agotar existencias

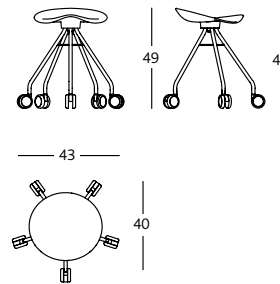
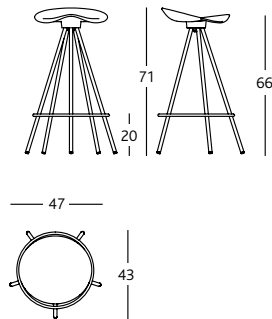
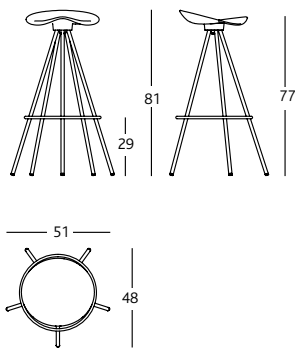

Wood / Madera

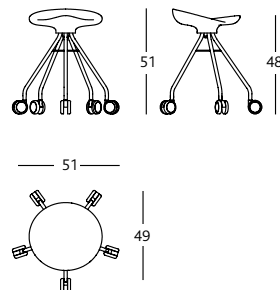
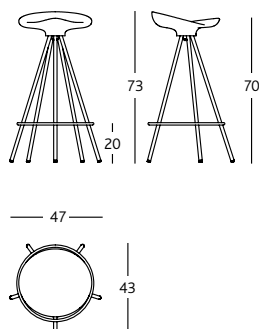
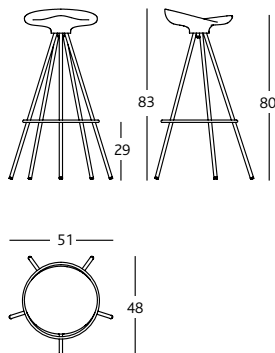

PACKAGING - ALUMINIUM / ALUMINIO

PACKAGING - WOOD / MADERA

	PCS	DIMENSIONS CM	GROSS KG		PCS	DIMENSIONS CM	GROSS KG
High / Alto	1	54 x 52 x 88	9	High / Alto	1	54 x 52 x 88	10
Medium / Medio	1	50 x 46 x 78	8	Medium / Medio	1	50 x 46 x 78	9
Low / Bajo	1	42 x 42 x 54	6	Low / Bajo	1	42 x 42 x 54	7



BINARIA STOOL / TABURETE 

Jordi Badia & Otto Canalda

Steel structure and lever painted in a polyester powder coating and satin finish. Available in White RAL 1013, Red RAL 3002 or Black RAL 9005. Integral polyurethane injected seat. Gas piston for height regulation (200mm) in a polished steel finish. Castors in a reinforced polyamide and rubber grey rings.

Estructura y maneta en acero, pintados con pintura de polvo poliéster satinado. Blanco RAL 1013, Rojo RAL 3002 y Negro RAL 9005. Asiento inyectado en poliuretano integral. Pistón de gas regulable en altura (200mm.) acabado acero pulido. Ruedas en poliamida reforzada con banda de goma gris.

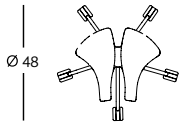
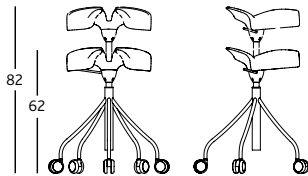

BINB040404	White / Blanco	
BINB070707	Red / Rojo	496
BINB101010	Black / Negro	

 Delivery in 1 week. Consult conditions.
Entrega en 1 semana. Consultar condiciones.

PACKAGING

PCS	DIMENSIONS CM	GROSS KG
1	50 x 48 x 64	8

GRASSO STOOL / TABURETE (until stocks lasts / hasta agotar existencias)

Stephen Burks

Steel painted structure and seat upholstered in different materials and leathers provided by BD. The Bolon material is made of PVC and wool.

Taburete con estructura de acero pintado y asiento tapizado con las distintos tejidos y pieles de BD. Tejido Bolon fabricado en PVC + lana.

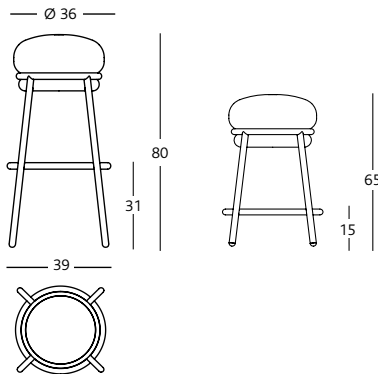

	Fabrics / Telas					Leather / Piel		
	*COM	CAT 1	CAT 2	CAT 3	CAT 4	P	S	V/F
Medium / Mediano (Counter)	734	794	818	848	884	890	944	968
High / Alto (Bar)	755	813	838	872	904	916	1.000	1.031

*COM : Customer's own material / Tejido o piel del cliente

Metres of material required / Metros de material requerido

Leather / piel 1m² - Fabric / Tela 100 x 140 cm

For colours see Grasso armchair / Para colores ver butaca Grasso pag. 67

PACKAGING

	PCS	DIMENSIONS CM	GROSS KG
H.65	1	54 x 51 x 73	8
H.80	1	54 x 51 x 88	10

ACCESSORIES / ACCESORIOS

MIRALLMAR MIRROR / ESPEJO

Eduard Samsó

A multi-mirror display made up of 7 separate squared double faced mirrors in different sizes with variable positions. Flat mirrors except one concave mirror. Structure, nuts + bolts and discs in zinc-coated iron.

Multiespejo formado por 7 espejos cuadrados de diferentes medidas, con posición variable. Espejos planos a excepción de uno que es cóncavo. Estructura, casquillos y discos en hierro zincado.

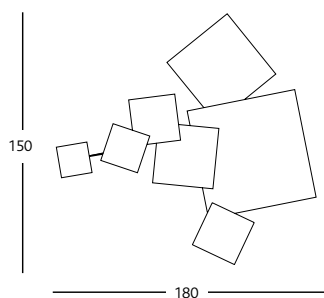

EM0398

Mirallmar mirror / espejo

1.911

OTHER COMPOSITIONS / OTRAS COMPOSICIONES

2 standard units / 2 unidades estándar

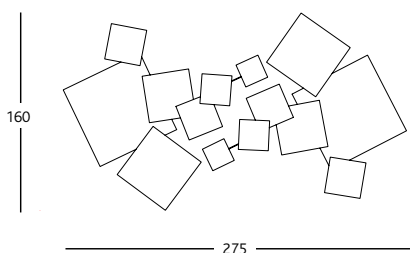

3 standard units / 3 unidades estándar

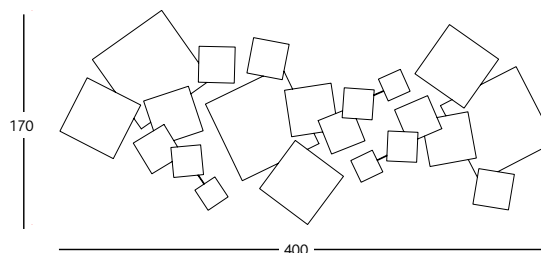

PACKAGING



Delta selection / Selección Delta 1992

PCS	DIMENSIONS CM	GROSS KG
1	130 x 90 x 60	26

SHOWTIME MIRROR / ESPEJO

Jaime Hayon

A one-sided multi-mirror mural. The back of each mirror is painted in matte black.

Mural multiespejo a una sola cara. La cara posterior siempre va pintada en negro mate.

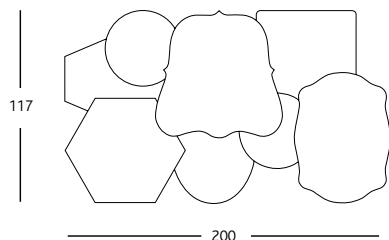

SWESPEJO

Showtime Multi-mirror / Multi Espejo Showtime

1.850

PACKAGING

PCS	DIMENSIONS CM	GROSS KG
1	100 x 65 x 100	42

KING KONG MIRRORS / ESPEJOS

Jaime Hayon

Mirrors available in two sizes. Decorative patterns are applied in gold and black. The back of each mirror is covered with black vinyl.
Espejos en dos tamaños diferentes, con decoraciones aplicadas en dorado y negro. Trasera cubierta con vinilo de seguridad negro.

KING

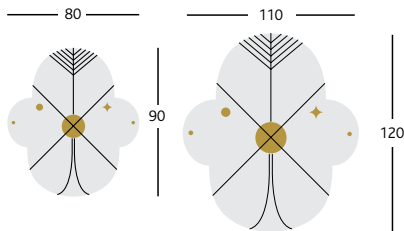

KONG

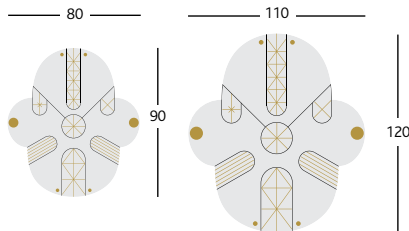

KING90SMALL	King 90 cm	958
KING120BIG	King 120 cm	1.386
KONG90SMALL	Kong 90 cm	1.130
KONG120BIG	Kong 120 cm	1.526

PACKAGING

	PCS	DIMENSIONS CM	GROSS KG
Mirror 90	1	92 x 12 x 102	12
Mirror 120	1	128 x 12 x 138	20

SHIVA FLOWER VASE / FLORERO 

Ettore Sottsass Jr.

Pink glazed ceramic vase / Cerámica esmaltada en color rosa.

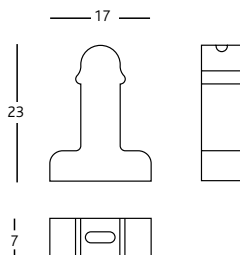

SH0439	Shiva	198
--------	-------	-----

 Delivery in 1 week. Consult conditions.
Entrega en 1 semana. Consultar condiciones.

PACKAGING

PCS	DIMENSIONS CM	GROSS KG
1	12 x 33 x 24	3

SHOWTIME VASES / JARRONES

Jaime Hayon

Top and base glazed ceramic pieces. Monochromed (interior and exterior in white) or bi-coloured vases (interior in white and exterior available in standard colours).
Fabricados en dos piezas en cerámica esmaltada; monocolor (interior y exterior en blanco) o bicolor (interior en blanco y exterior en varios colores, según el jarrón).

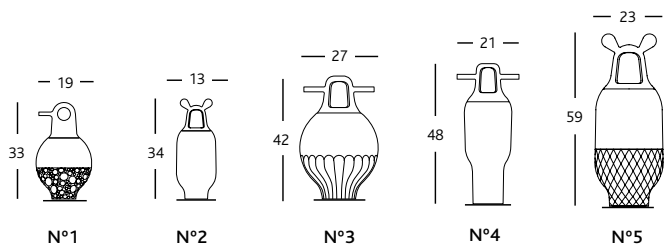

SWJAR1BL	N° 1	Int. / Ext. white Int. / Ext. blanco	337
SWJAR2BL	N° 2		259
SWJAR3BL	N° 3		583
SWJAR4BL	N° 4		344
SWJAR5BL	N° 5		595

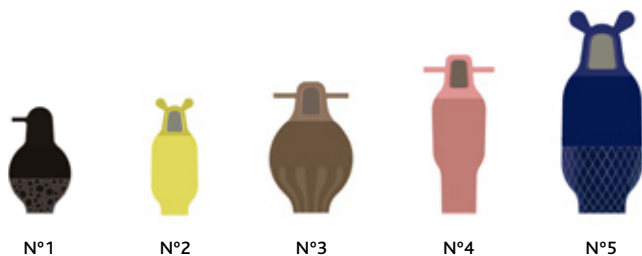

SWJAR1NG	N° 1 / Int. white - Ext. black N° 1 / Int. blanco - Ext. negro	522
SWJAR2AE	N° 2 / Int. white - Ext. electric yellow N° 2 / Int. blanco - Ext. amarillo eléctrico	370
SWJAR3VG	N° 3 / Int. white - Ext. greyish green N° 3 / Int. blanco - Ext. verde grisáceo	894
SWJAR4RR	N° 4 / Int. white - Ext. pink N° 4 / Int. blanco - Ext. rosa	522
SWJAR5AN	N° 5 / Int. white - Ext. Napoleon blue N° 5 / Int. blanco - Ext. azul Napoleón	894

SHOWTIME 10 VASES / JARRONES

Jaime Hayon

Manufactured in two pieces of enameled white ceramic and decorated in 24 carat gold painting.
Fabricados en dos piezas de cerámica esmaltada en blanco, con decoraciones en pintura oro de 24 quilates.

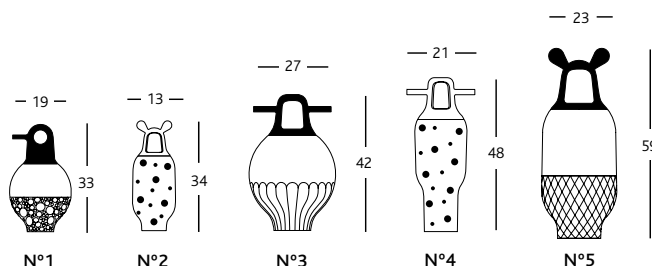

SWJAR110ANIV	N° 1 / White - Golden lid N° 1 / Blanco - Tapa dorada	446
SWJAR210ANIV	N° 2 / White with golden dots N° 2 / Blanco con puntos dorados	328
SWJAR310ANIV	N° 3 / White - Golden lid N° 3 / Blanco - Tapa dorada	747
SWJAR410ANIV	N° 4 / White with golden dots N° 4 / Blanco con puntos dorados	493
SWJAR510ANIV	N° 5 / White - Golden lid N° 5 / Blanco - Tapa dorada	786



Delivery in 1 week. Consult conditions.
Entrega en 1 semana. Consultar condiciones.

The base or top of each vase cannot be sold separately.
Las piezas no se pueden vender por separado.

SHOWTIME & SHOWTIME 10 PACKAGING

	PCS	DIMENSIONS CM	GROSS KG
N°1	1	23 x 23 x 42	6
N°2	1	23 x 23 x 42	3
N°3	1	35 x 35 x 51	6
N°4	1	29 x 29 x 66	5
N°5	1	29 x 29 x 66	6



HAPPY SUSTO VASES / JARRONES 

Jaime Hayon

Glazed ceramic vase(s) in white or blue with decorations in white or blue. One side has the decoration and the other side does not.
 Cerámica esmaltada en color blanco o azul con decoraciones en blanco o azul. Una cara con decoración, la otra cara sin.

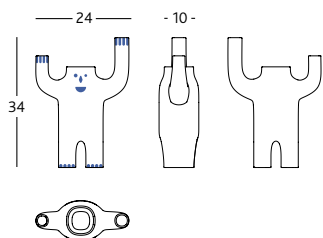

HSJARP04C/C	Small White / Pequeño Blanco	324
HSJARP09C/C	Small Blue / Pequeño Azul	405
HSJARG04C/C	Large White / Grande Blanco	544
HSJARG09C/C	Large Blue / Grande Azul	631

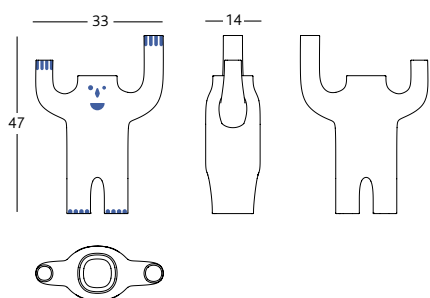

 Delivery in 1 week. Consult conditions.
 Entrega en 1 semana. Consultar condiciones.

PACKAGING			
	PCS	DIMENSIONS CM	GROSS KG
Small / Pequeño	1	44 x 33 x 17	3
Large / Grande	1	57 x 42 x 21	4

HAPPY YETI VASES / JARRONES 

Jaime Hayon

Glazed ceramic vase in white and decorations in black.
 Cerámica esmaltada en color blanco con decoración en negro.

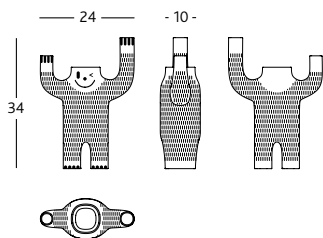

HSJARP04YETI	Small / Pequeño	506
HSJARG04YETI	Large / Grande	730

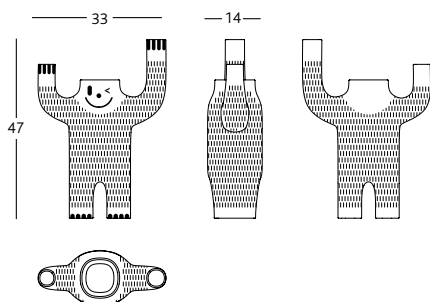

 Delivery in 1 week. Consult conditions.
 Entrega en 1 semana. Consultar condiciones.

PACKAGING			
	PCS	DIMENSIONS CM	GROSS KG
Small / Pequeño	1	44 x 33 x 17	3
Large / Grande	1	57 x 42 x 21	4

EXPLORER VASES / JARRONES

Jaime Hayon

Made of several pieces of glazed ceramic in different colors.
Fabricados en varias piezas de cerámica esmaltada en distintos colores.

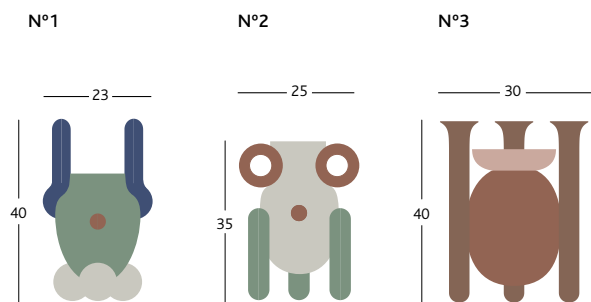

EXPJAR01COL	N°1	648
EXPJAR02COL	N°2	740
EXPJAR03COL	N°3	783

PACKAGING

	PCS	DIMENSIONS CM	GROSS KG
N°1	1	29 x 29 x 46	4
N°2	1	29 x 29 x 46	4
N°3	1	35 x 39 x 47	4

GARDENIAS VASES / JARRONES

Jaime Hayon

Terracotta and waterproof treated / Fabricados en terracota con un posterior tratamiento de impermeabilidad.

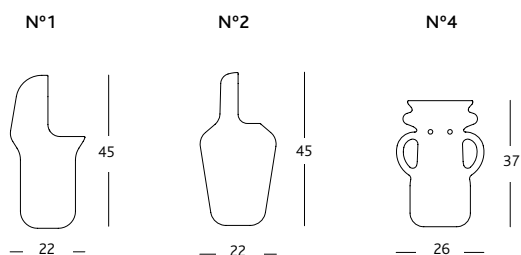

GARJAR01TER	N°1	295
GARJAR02TER	N°2	291
GARJAR04TER	N°4	331

 Delivery in 1 week. Consult conditions.
Entrega en 1 semana. Consultar condiciones.

PACKAGING

	PCS	DIMENSIONS CM	GROSS KG
N°1, N°2, N°4	1	29 x 29 x 51	4

MONKEY COAT STAND / PERCHERO 

Jaime Hayon

Coat stand: base in grey or black architectural concrete. Pole and banana in solid ash with an open-pore lacquer finish in grey or black. Includes regulatory glides. Banana wall hanger: solid ash in grey, black or yellow.

Perchero: cuerpo en hormigón arquitectónico gris o negro. Barra y banana en fresno macizo lacado a poro abierto en gris o negro. Incorpora tacos reguladores. Colgador de pared Banana: fresno macizo en gris, negro o amarillo.

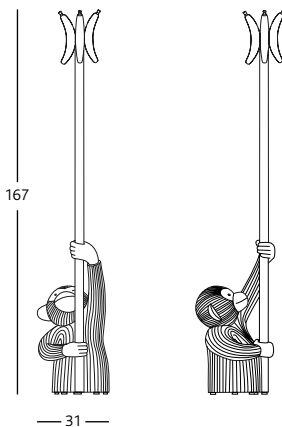
Coat stand
Perchero

— 31 —

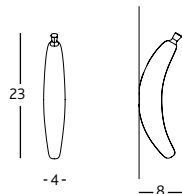

39

Banana wall hanger
Colgador pared

-4-

-8-

MKCOLG013	Coat stand grey / Perchero gris	1.454
MKCOLG010	Coat stand black / Perchero negro	1.496
	Banana wall hanger / colgador pared	152
MKCOLB006	-Yellow / Amarillo	
MKCOLB010	-Black / Negro	
MKCOLB013	-Grey / Gris	

Maximum load on each hanger / Carga máxima sobre cada colgador:
Coat stand / Perchero: 4 kg
Banana: 4 kg



Delivery in 2 weeks. Consult conditions.
Entrega en 2 semanas. Consultar condiciones.

PACKAGING

	PCS	DIMENSIONS CM	GROSS KG
COAT STAND	1	62 x 34 x 108	42
BANANA	1	4 x 8 x 24	0.5

CASA DE FAMILIA BOTTLE / BOTELLA 

Josep Maria Jujol

White matte glazed ceramic.

Cerámica blanca esmaltada en mate.

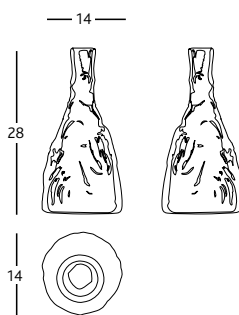

— 14 —

28

14

JU0304

158



Delivery in 1 week. Consult conditions.
Entrega en 1 semana. Consultar condiciones.

PACKAGING

PCS	DIMENSIONS CM	GROSS KG
1	14 x 14 x 24	0.5

HAPPY HOUR TROLLEYS / CARRITOS

Alfredo Häberli

Chromed iron structure. Heat-shaped ABS trays, painted in textured polyurethane in white matte (RAL 9003) or black (RAL 9005).
Back wheels in chromed iron and rubber gasket.

Estructura en hierro cromado. Bandejas en ABS termoconformado pintado en poliuretano texturizado mate color blanco RAL 9003 o negro RAL 9005.
Ruedas traseras en hierro cromado con junta de caucho.

Servicetable

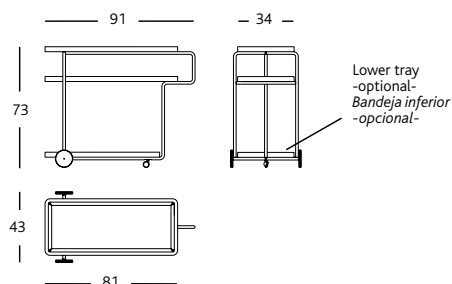

SERVICETABLE

HH2002	Trays painted white matte RAL 9003 Bandejas pintadas blanco mate RAL 9003	1.743
HH2003	Trays painted black matte RAL 9005 Bandejas pintadas en negro mate RAL 9005	

SERVICEBAR

HH3006	Trays painted white matte RAL 9003 Bandejas pintadas blanco mate RAL 9003	1.743
HH3007	Trays painted black matte RAL 9005 Bandejas pintadas en negro mate RAL 9005	

Servicebar

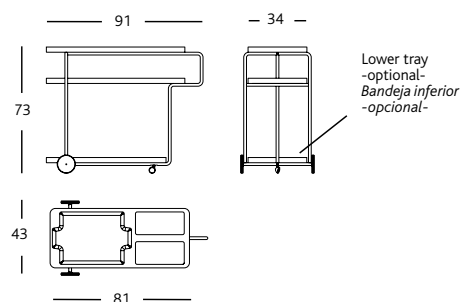

LOWER TRAY (OPTIONAL) / BANDEJA INFERIOR (OPCIONAL)

HH3004	Trays painted white matte RAL 9003 Bandejas pintadas blanco mate RAL 9003	273
HH3005	Trays painted black matte RAL 9005 Bandejas pintadas en negro mate RAL 9005	

PACKAGING

PCS	DIMENSIONS CM	GROSS KG
1	120 x 50 x 100	17

PLEC UMBRELLA STAND / PARAGÜERO

Isabel Gamero & Jordi Pérez

Main body in semi-matte polished stainless steel. Polyester foam placed on the inside base.
Cuerpo en acero inoxidable pulido semimate. Espuma de poliéster en la base interior.

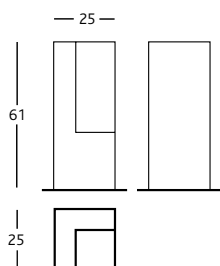

PL0757	Plec	717
--------	------	-----

 Delivery in 1 week. Consult conditions.
Entrega en 1 semana. Consultar condiciones.

PACKAGING

PCS	DIMENSIONS CM	GROSS KG
1	28 x 28 x 70	10

 Delta selection / Selección Delta 1997



ALBERTO CANDLEHOLDER / CANDELABRO

Oscar Tusquets

Cast brass piece painted in matte white.

Pieza en fundición de latón pintada en blanco mate. Existen dos alturas.

Low / Bajo

High / Alto

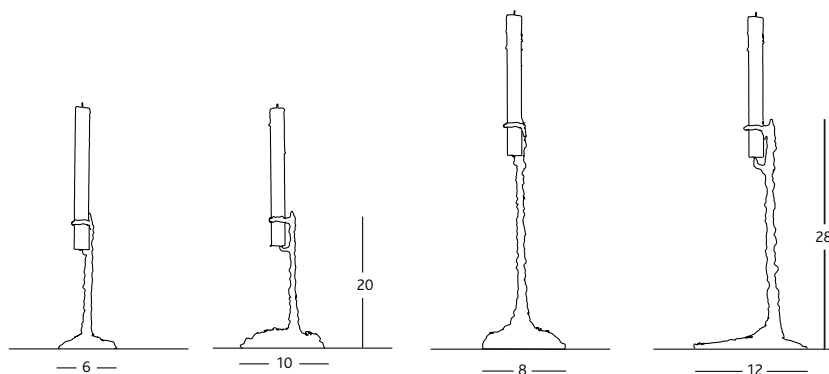

Low / Bajo 970

High / Alto 1.390

PACKAGING

	PCS	DIMENSIONS CM	GROSS KG
Low / Bajo	1	15x15x35	1,5
High / Alto	1	15x15x35	2

3-4-5 MAILBOX / BUZÓN 

Lluís Clotet & Oscar Tusquets

Made up of steel sheets painted in a black polyester powder coating (RAL 9005). Doors in polished stainless steel with a transparent acrylic window and white labelling card.

Cuerpo en chapa de acero pintada en polvo poliéster negro RAL 9005. Puertas en chapa de acero inoxidable pulido con visores de metacrilato transparente y etiquetas en cartulina blanca.

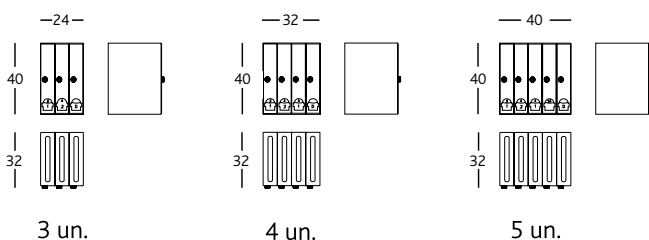

3 un.

4 un.

5 un.

BZ0497	3 un.	603
BZ0498	4 un.	723
BZ0499	5 un.	831



Delivery in 2 weeks. Consult conditions.

Entrega en 2 semanas. Consultar condiciones.

- Includes two keys per module
- For installations between walls, it is advisable to leave a space of between 1-2 cm of the total length for tolerance.
- For the mailbox 3un. total measure should be 24,5cm
- For the mailbox 4un. total measure should be 32,5cm
- For the mailbox 5un. total measure should be 40,5cm

- Incluye dos llaves por buzón
- Para instalaciones entre paredes, se aconseja dejar una tolerancia de 1 a 2 cm. de la medida total.
- Para el buzón 3un. medida total debe ser 24,5cm
- Para el buzón 4un. medida total debe ser 32,5cm
- Para el buzón 5un. medida total debe ser 40,5cm



Delta selection / Selección Delta 2005

PACKAGING

	PCS	DIMENSIONS CM	GROSS KG
Mailbox / Buzón 3	1	30 x 36 x 46	6
Mailbox / Buzón 4	1	38 x 36 x 46	8
Mailbox / Buzón 5	1	46 x 36 x 46	9

LIGHTING / ILUMINACIÓN

FLAMINGO LAMP / LÁMPARA

Álvaro Siza Vieira

Chromed iron bar structure which can be disassembled. Adjustable fine iron wings, painted in a silver matte grey to control light. Switch included.
Estructura desmontable en varilla de hierro cromado. Aletas orientables para el control de la luz en hierro pintado de gris plata mate. Incluye interruptor.

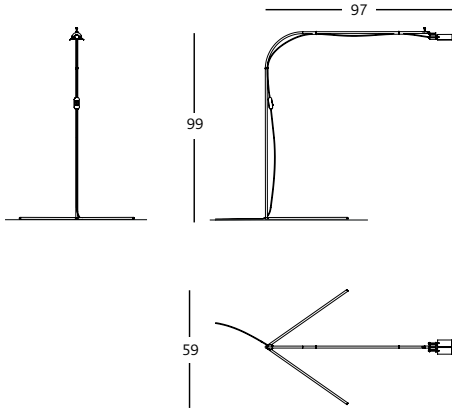

FLO100

Flamingo Lamp / Lámpara

1.204

- Includes LED bulb 4.8W. 600 lumens. T 2.700K.
- Energetic value E
- Incluye 1 bombilla LED 4.8W. 600 lumens - T 2.700K
- Valor energético E

PACKAGING

PCS	DIMENSIONS CM	GROSS KG
1	107 x 32 x 4	4

OLVIDADA LAMP / LÁMPARA

Pepe Cortés

Standing and ceiling lamps in a copper polished rigid tube finish and chromed lampholder. The black cable hanging lamp version (maximum length of 3m) is made up of the lampholder (attached to the electric cable) and a metal brass scotch polished rosette. Also available with a chromed metal lampholder and black anodic black rosette.

Rigid brass finished structures, scotch polished and varnished for the double, triple and chandelier hanging lamps with lampholders and rosettes in the same finish. All lamps include Led 7W linestras.

Lámpara de pie y suspensión rígida, en estructura cobreada y dado portalámpara cromado. Lámpara de suspensión de cable (longitud max 3m), con florón y dado portalámpara en acabado latonado pulido scotch barnizado, o versión en acabado florón pintado en color anodic black y dado portalámpara cromado. Lámpara Doble, Triple, Chandelier tanto en florón y dado portalámpara en acabado como el resto de la estructura, acabado latonado pulido scotch y barnizado. Portalámparas con linestras de led de 7W.

Bulbs included / Bombillas incluidas

OLSUSLATB	 A. Pending black cable lamp with brass finished rosette De suspensión con cable negro y florón en metálico latonado	847
OLSUSANBB	A. Pending black cable lamp with rosette in Anodic Black De suspensión con cable negro y florón en Anodic Black	917
OLSIMCOBB	B. Pending lamp with tube in copper finish De suspensión rígida cobreada	1.037
OLPIECOBB	C. Standing lamp in copper finish De pie cobreada	1.264
OLDOBLATB	D. Double /Doble	1.934
OLTRILATB	E. Triple **	2.830
OLCHALATB	F. Chandelier **	4.419
ST4061	Set of 3 led bulbs / Set de 3 bombillas LED S140/7W/UNIT-220-240V	151
ST6784	Dimmer (optional for standing lamp / opcional para lámpara pie)	196
	1 Converter from 220v to 110v (standing / de pie)	215
	1 Converter from 220v to 110v (pending / suspensión)	239

 Delivery in 2 weeks. Consult conditions.
Entrega en 2 semanas. Consultar condiciones.



OLVIDADA LAMP / LÁMPARA

A. Pending lamp with black cable De suspensión con cable negro

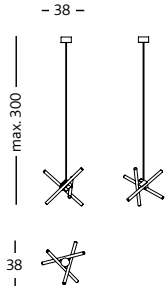

B. Pending lamp with rigid tube De suspensión rígida

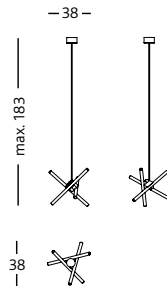

C. Standing lamp / De pie

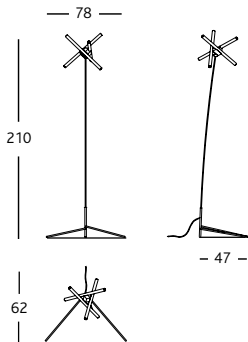

D. Double / Doble

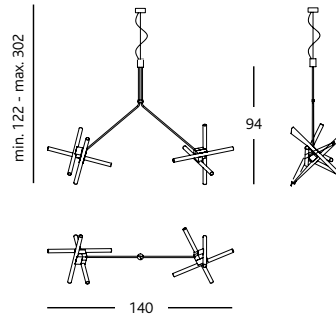

E. Triple

(Until stocks last / Hasta agotar existencias)

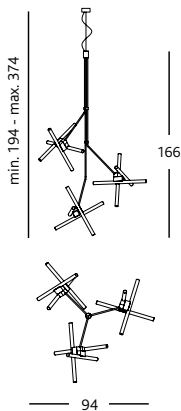

F. Chandelier

(Until stocks last / Hasta agotar existencias)

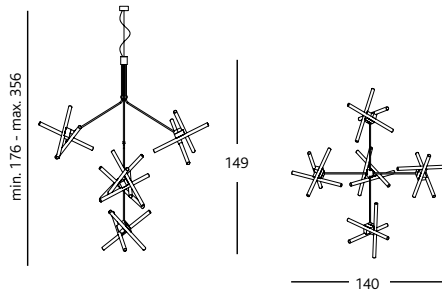

- 3 led linestras S140/7W/UNIT-220-240V
- Power 7W - 470 lumens - T2700K
- Regulation "Dimmable"
- Certified CE UNE-EN 60598-1
- Energetic value A+

- 3 bombillas led S140/9W/UNIT-220-240V
- Potencia 7W - 470 lumens - T 2700K
- Regulación "Dimmable".
- Certificación CE UNE-EN 60598-1
- Valor energético A+

PACKAGING			
	PCS	DIMENSIONS CM	GROSS KG
Standing / De pie	1	196 x 13 x 13	6
Pending lamp / De suspensión rígida	1	196 x 13 x 13	7
Hanging cable / De suspensión cable	1	20 x 20 x 20	1,5
Double / Doble	1	118 x 93 x 18	9
Triple	1	152 x 48 x 26	12
Chandelier	1	116 x 85 x 18	17

PUBLIC SEATING / ASIENTOS PÚBLICOS

CATALANO & PERFORANO BENCH / BANCO

PERFORANO: Perforated tubular bench seating in 30 micron white galvanised steel, painted using an epoxy resin primer and finished with a Qualicoat Class 2 polyester paint in a micro-textured Ral 9006 silver plate colour. Matching finish for legs, seating and armrests.

CATALANO: Expanded metal mesh bench seating in 30 micron white galvanised steel, using an epoxy resin primer and finished with a Qualicoat Class 2 polyester paint in a micro-textured Ral 9006 silver plate colour. Matching finish for legs, seating and armrests (optional).

PERFORANO: Asiento en tubo y chapa perforada de acero con recubrimiento en cincado blanco 30 micras, pintado con una imprimación en resina epoxi y decorado con pintura poliéster Qualicoat Class2 de color plata microtexturado Ral 9006. Patas, asientos y brazos en el mismo acabado

CATALANO: Asiento en tubo y chapa deployé de acero con un recubrimiento en cincado blanco 30 micras, pintado con una imprimación en resina epoxi y decorado con pintura poliéster Qualicoat Class2 de color plata microtexturado Ral 9006. Patas, asientos y brazos (opcional) en el mismo acabado.

CATALANO

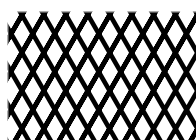

Malla Deployé

PERFORANO



Perforated / Perforada

SEAT / ASIENTOS

BC0511	CATALANO painted / pintado	987
BC0472	PERFORANO painted / pintado	941

PAINTED LEG / PATA PINTADA

BC0512	Single leg to hang Pata sencilla para colgar	236
BC0513	Single leg to build into the floor Pata sencilla para empotrar	200
BC0514	Single leg free-standing, to be screwed into the floor Pata sencilla para apoyar - atornillar	260
BC0515	Double leg free-standing, to be screwed into the floor Pata doble para apoyar - atornillar	279
BC0516	Double leg to build into the floor Pata doble para empotrar	279

ARMS (optional) / BRAZOS (opcional)

BC0518	CATALANO galvanized and painted / galvanizado y pintado	242
BC0504	PERFORANO painted steel / en acero pintado	251

PACKAGING

	PCS	DIMENSIONS CM	GROSS KG
CATALANO 1 unit / unidad	1	98 x 36 x 106	16
PERFORANO 1 unit / unidad	1	98 x 36 x 126	16
Projects / Proyectos	Details on request / Consultar		



CATALANO

To hang / Para colgar

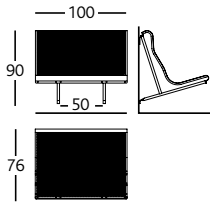
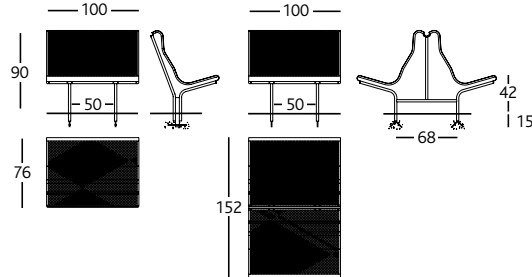
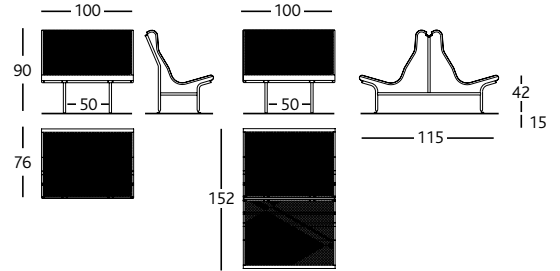
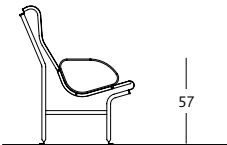
To build into the floor
Para empotrarFree-standing to be screwed into the floor
Para apoyar - atornillarOptional armrests
Brazos opcionales

PERFORANO

To hang / Para colgar

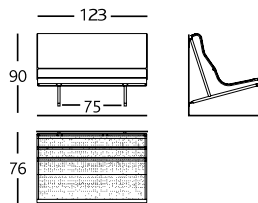
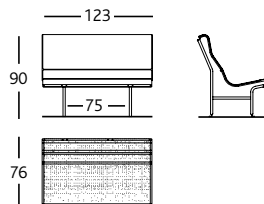
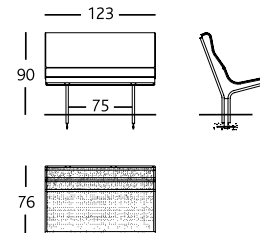
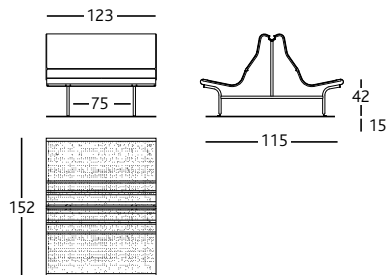
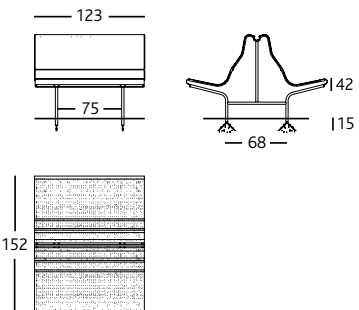
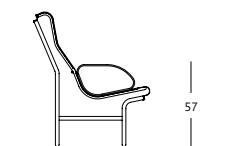
Simple leg Free-standing to be
screwed into the floor
Pata sencilla para apoyar - atornillarSimple leg to build into the floor
Pata sencilla para empotrarDouble leg Free-standing to be
screwed into the floor
Pata doble para apoyar - atornillarDouble leg to build into the floor
Pata doble para empotrarOptional armrests
Brazos opcionales

THE POET BENCH / BANCO EL POETA

Alfredo Häberli

Steel tubular legs and steel sheets for seating, covered in cataphoresis and painted in polyester resin in a corten colour, or in microtexturised silver (RAL 9006).

Patasy asiento en tubo y plancha perforada de acero, con recubrimiento en cataforesis y pintado en resina de poliéster color corten o plata (RAL 9006) microtexturado.

The Poet / El Poeta - Flowers

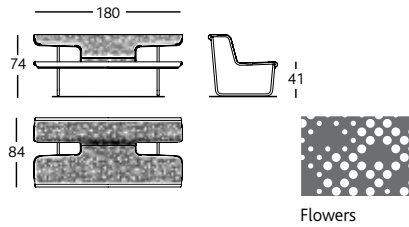

FLOWERS

BS0101	Corten	
BS0301	Silver Grey / Plata	3.440

- Benches should always be screwed to the ground.
- Fixing materials are not included.
- *Siempre deben ir atornillados al suelo.*
- *No incluyen tornillos de sujeción al suelo.*



Golden Delta Award 2007 / Premio Delta Oro 2007

BENCH B

Konstantin Grcic

Extruded anodised aluminium slats. Legs and armrests in cast aluminium and painted in silver grey (RAL 9006). Optional upholstery for indoor and outdoor use. Optional armrests.

Perfiles en aluminio extrusionado anodizado. Pies y brazos en fundición de aluminio pintados gris plata (RAL 9006). Puede tapizarse para uso en interiores y exteriores. Brazos opcionales.

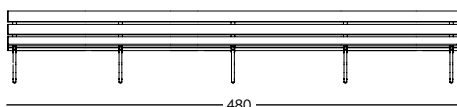
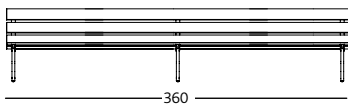
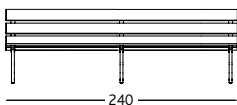
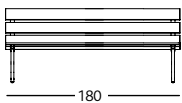
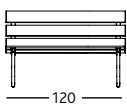
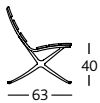

- 2 seater / 2 plazas (120 cm)
- 3 seater / 3 plazas (180 cm)
- 4 seater / 4 plazas (240 cm)
- 6 seater / 6 plazas (360 cm)
- 8 seater / 8 plazas (480 cm)

Only for projects. Prices on request.
Sólo para proyectos. Consultar precios.

PACKAGING

PCS	DIMENSIONS CM	GROSS KG
1	200 x 100 x 64	40





The ART EDITIONS collection are sculptural parts, so they must be handled very carefully. These products are not subject to tests for use, stability or any other aspect. For this reason, BD cannot be held responsible for damage caused to the Art Editions piece or to third parties due to improper use.

La colección ART EDITIONS son piezas escultóricas, por lo que su uso debe de realizarse con cuidado; estos productos no están sujetos a test de ensayos ni de estabilidad. Por tanto, BD no se hace responsable de los daños causados en la pieza o a terceros por un uso inadecuado.

GAUDÍ FURNITURE / MOBILIARIO

GAUDÍ FURNITURE items are made of solid wood, following the techniques that were used in the construction and carving of the original pieces. This process classifies the Gaudí furniture collection as sculptural art.

CONSERVATION AND MAINTENANCE: Furniture should be placed in areas with stable temperatures between 15-35 degrees Celcius and a humidity of 40 - 60%. Extreme changes in temperature and or humidity have a direct influence on the behaviour of material. Wood, being a natural (living) element, dilates or contracts, (absorbs or releases moisture). The parameter changes mentioned depend directly on the location of the furniture in the customer's home or improper storage.

BD Barcelona cannot be held responsible for constructive alterations caused by extreme changes as detailed above.

As for maintenance, only a natural wax product with a cotton cloth, or passing the surface gently with a dry cotton cloth should be used.

Do not use abrasive products or solvents.

Los MUEBLES GAUDÍ están fabricados en madera maciza, siguiendo las técnicas que se emplearon en la construcción y talla de los originales.

Este proceso clasifica al mobiliario Gaudí de escultura.

CONSERVACIÓN Y MANTENIMIENTO: los muebles deben colocarse en áreas con temperaturas estables de 15-35°C y una humedad de 40-60%.

Los cambios extremos de temperatura y/o humedad influyen directamente en el comportamiento de la materia, al ser un elemento natural (vivo) la madera se dilata o se contrae (absorbe o desprende humedad). Los cambios de parámetros mencionados dependen directamente de la ubicación del mueble en casa del cliente o de un almacenamiento indebido.

BD Barcelona no puede responsabilizarse de las alteraciones constructivas ocasionadas por los cambios extremos antes detallados.

Para el mantenimiento sólo necesita aplicarse un producto de ceras naturales con un paño de algodón o pasando un paño de algodón seco.

No utilizar productos abrasivos o disolventes.

CALVET HANGER / COLGADOR

Antoni Gaudí

Waxed natural solid oak wood. Forged iron structure with a burnished copper and varnished finish.

Madera de roble con encerado natural. Estructura de hierro forjado bruñido en bronce y barnizado.

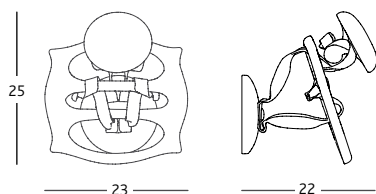

HG0051

1.023

PACKAGING

PCS	DIMENSIONS CM	GROSS KG
1	32 x 28 x 26	2

CALVET STOOL / TABURETE

Antoni Gaudí

Solid oak varnished / Roble macizo barnizado.

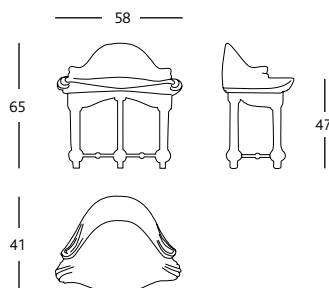

MG0003

5.805

PACKAGING

PCS	DIMENSIONS CM	GROSS KG
1	70 x 60 x 86	36



CALVET ARMCHAIR / SILLÓN

Antoni Gaudí

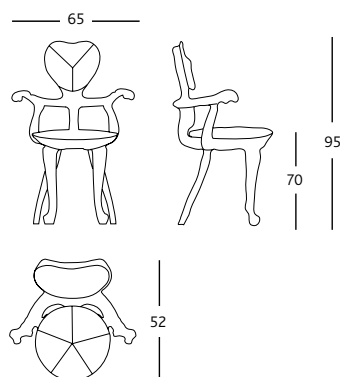
Solid dark varnished oak / *Roble macizo barnizado.*

MG0006	Stained oak and varnished / <i>Roble teñido y barnizado</i>	10.195
--------	---	--------

PACKAGING

PCS	DIMENSIONS CM	GROSS KG
1	119 x 78 x 65	42

CALVET CHAIR / SILLA

Antoni Gaudí

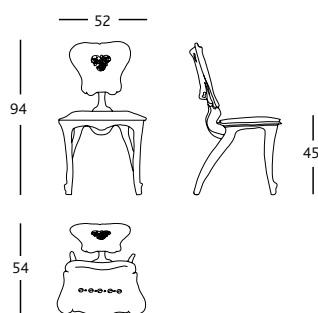
Solid dark varnished oak / *Roble macizo barnizado.*

MG0009		7.926
--------	--	-------

PACKAGING

PCS	DIMENSIONS CM	GROSS KG
1	60 x 60 x 100	35

CALVET MIRROR / ESPEJO

Antoni Gaudí

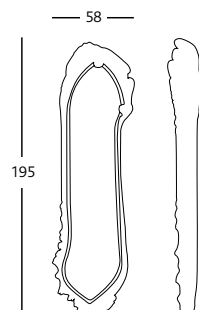
Solid oak varnished or coated in fine golden brass sheets using a gold leaf technique / *Roble macizo barnizado o recubierto con láminas de latón doradas mediante técnica de pan de oro.*

MG0001	Stained oak and varnished / <i>Roble teñido y barnizado</i>	14.991
--------	---	--------

MG0002	Covered in fine golden brass sheets <i>Recubierto con láminas de latón doradas</i>	20.223
--------	---	--------

PACKAGING

PCS	DIMENSIONS CM	GROSS KG
1	203 x 74 x 26	78

CALVET BENCH / BANCO

Antoni Gaudí

Solid dark varnished oak / *Roble macizo barnizado.*

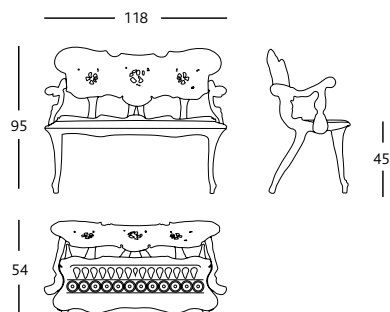

MG0008

20.463

PACKAGING		
PCS	DIMENSIONS CM	GROSS KG
1	125 x 60 x 110	50

BATLLÓ BENCH / BANCO

Antoni Gaudí

Solid dark varnished oak / *Roble macizo barnizado.*

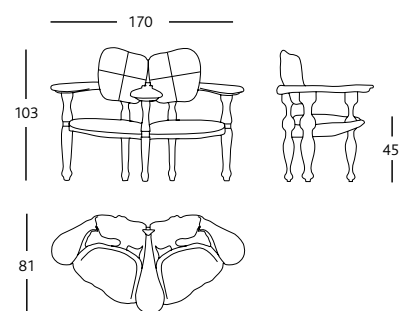

MG0007 Stained oak and varnished / *Roble teñido y barnizado*

17.552

PACKAGING		
PCS	DIMENSIONS CM	GROSS KG
1	94 x 183 x 129	70

BATLLÓ CHAIR / SILLA

Antoni Gaudí

Solid dark varnished oak / *Roble macizo barnizado.*

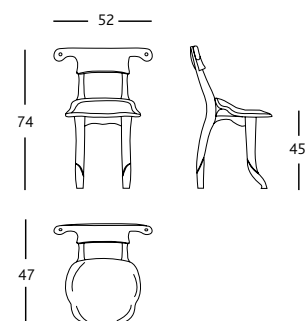

MG0004

4.963

PACKAGING		
PCS	DIMENSIONS CM	GROSS KG
1	60 x 63 x 87	50

GAUDÍ DOOR KNOBS / HERRAJES

Antoni Gaudí

Solid cast brass and polished finish. Note: Polished brass tends to darken with time.

Fundición de latón macizo con acabado pulido. Nota: el latón pulido con el tiempo tiende a oscurecer.

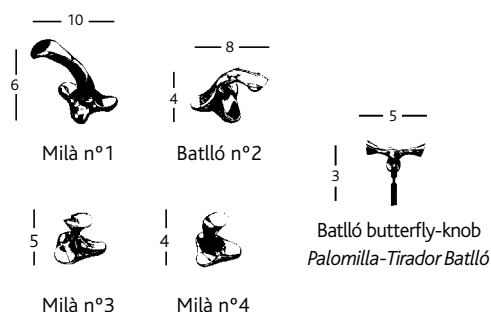

DOOR KNOBS / TIRADORES

HG0008	Milà n°1	147
HG0012	Batlló n°2	130
HG0016	Milà n°3	126
HG0020	Milà n°4	115
HG0124	Batlló butterfly - knob / Tirador Batlló	91



BUTTERFLY / PALOMILLAS

HG0024	Batlló Butterfly / palomilla (turns / con giro)	95
--------	---	----

DOOR HANDLE / MANUBRIOS

HG0032	2 units / 2 unidades	261
--------	----------------------	-----

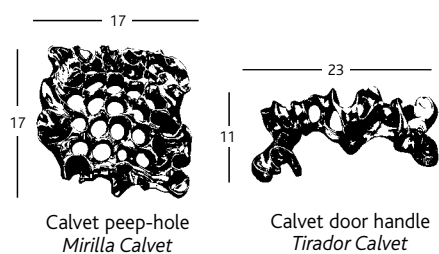

HG0040	Calvet peep-hole / Mirilla Calvet	2.366
--------	-----------------------------------	-------

HG0044	Calvet door handle / Tirador Calvet	2.384
--------	-------------------------------------	-------

Delivery in 1 week. Consult conditions.
Entrega en 1 semana. Consultar condiciones.

GAUDÍ HANDLES DISPLAY / EXPOSITOR

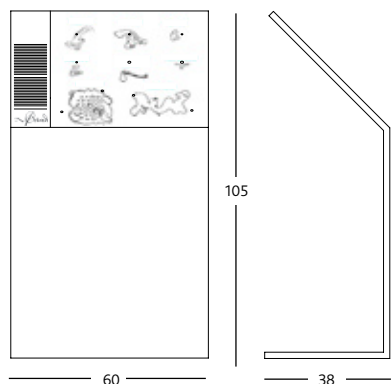

HG0008 - Milà n°1	147
HG0012 - Batlló n°2	130
HG0016 - Milà n°3	126
HG0020 - Milà n°4	115
HG0024 - Batlló butterfly	95
HG0099 - 1 Unit Handle	131
HG0040 - Calvet peep-hole	2.366
HG0044 - Calvet door handle	2.384
Total	3.110

PACKAGING

PCS	DIMENSIONS CM	GROSS KG
1	66 x 44 x 121	25

DALÍ FURNITURE / MOBILIARIO - ORIGINAL & BLACK LABEL COLLECTION

© SALVADOR DALÍ / FUNDACIÓN GALA-SALVADOR DALÍ, BARCELONA, 2023

PORTLLIGAT SUNBED / TUMBONA

Salvador Dalí

Solid Iroko wooden structure with polyamide wheels. Optional upholstered cushion with water repellent foam and material apt for outdoor use. The cover is removable.

Estructura de madera maciza de iroko con protección de aceite. Ruedas de poliamida y tornillería en acero inoxidable. Colchoneta opcional desenfundable tapizada con espuma hidrófuga y tejido apto para uso exterior.

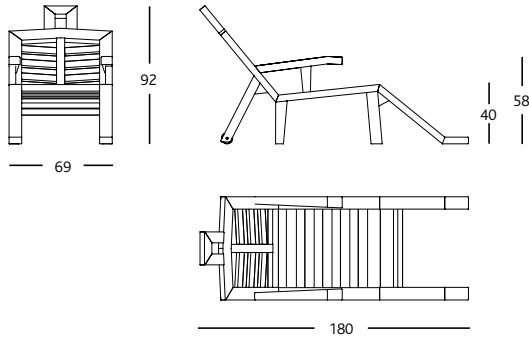

DATUMBONA	Portlligat sunbed / Tumbona	8.048
DACJTUMB	Cushion / Colchoneta	688
DAFUNTUMB	Protective cover / Funda protectora	615

Protective cover / Funda protectora

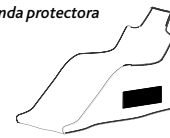

CLEANING AND MAINTENANCE

The WOOD should be cleaned with a damp cloth and or with neutral soap. Do not use cleaning products containing alcohol, solvents or any of their derivatives. BD recommends applying teak oil twice a year for good wood maintenance. Always apply the teak oil with a brush and when the wood is dry. It is recommended to cover the sun lounger with a cover in rainy and out-of-use seasons. FABRICS should be cleaned with a damp cloth and or with neutral soap. In case of difficult stains, a mixture of bleach (40%) and water (60%) can be applied.

LIMPIEZA Y MANTENIMIENTO

MADERA: Se debe limpiar con un paño húmedo y/o con jabón neutro. No utilizar productos de limpieza con alcoholes y disolventes o sus derivados. BD recomienda aplicar aceite de teca 2 veces al año para un buen mantenimiento de la madera. Aplicar con pincel o brocha siempre con la madera bien seca.
TEJIDO: Se debe limpiar con un paño húmedo y/o con jabón neutro. En caso de manchas difíciles se puede aplicar una mezcla de lejía 40% y agua 60%. Se recomienda tapar la tumbona con una funda en temporadas de lluvia y fuera de uso.

PACKAGING

PCS	DIMENSIONS CM	GROSS KG
1	190 x 80 x 100	35

VIS-À-VIS DE GALA

Salvador Dalí

Structure in solid wood. Wooden socket lined with a polished lacquered brass strip. 100% natural silk cover and buttons in parma violet colour or black satin. Upper trim (backrest) in a cast polished and varnished brass or black patina.

As we are treating artisanal processes, the small pores or irregularities on the surface are natural to the material (brass), adding value to the piece and are never considered to be defects.

Estructura de madera maciza. Zócalo de madera forrado con pletina de latón pulido y barnizado. Tapicería y botonadura en seda natural 100% color violeta de Parma o satén color negro. Brazo en fundición de latón pulido y barnizado o en pátina negra.

Al tratarse de un proceso artesano, los pequeños poros e irregularidades en la superficie del propio material (latón) es un valor añadido, nunca un defecto.

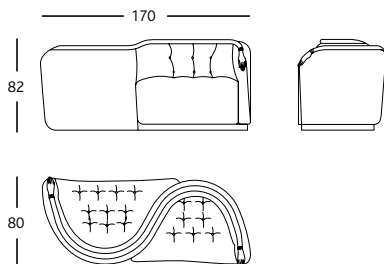

DA0061	Original	32.497
DA0061BL	Black Label (Limited Edition / Edición limitada)	36.328

PACKAGING

PCS	DIMENSIONS CM	GROSS KG
1	190 x 100 x 100	130



LEDA SCULPTURE-ARMCHAIR / SILLÓN-ESCALURA

Salvador Dalí

Design inspired on an artwork by Salvador Dalí: 'Femme à tête de roses' (1935). Structure in polished varnished cast brass or black patina not varnished (Black Label).

As we are treating artisanal processes, the small pores or irregularities on the surface are natural to the material (brass), adding value to the piece and are never considered to be defects.

Diseño inspirado en una obra de de Salvador Dalí: 'Femme à tête de roses' (1935). Estructura en fundición de latón pulido. Acabado barnizado o pátina negra sin barnizar (Black label).

Al tratarse de un proceso artesano, los pequeños poros e irregularidades en la superficie del propio material (latón) es un valor añadido, nunca un defecto.

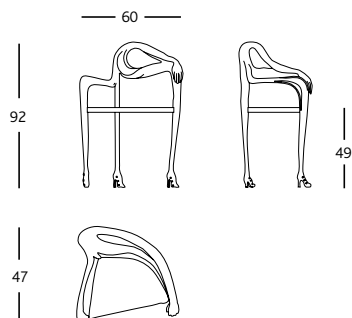

DA0059	Original	24.970
DA0059BL	Black Label (Limited edition of 105 units <i>Edición limitada de 105 unidades</i>)	29.620

PACKAGING

PCS	DIMENSIONS CM	GROSS KG
1	100 x 58 x 70	70

LEDA SCULPTURE-LOW TABLE / ESCULTURA -MESA BAJA

Salvador Dalí

Design inspired on an artwork by Salvador Dalí: 'Femme à tête de roses' (1935). Legs in cast varnished brass or black patina not varnished (Black Label). Table top in brushed and varnished brass or black patina (Black Label). Carrara marble egg on top or Nero Marquina marble egg (Black Label).

As we are treating artisanal processes, the small pores or irregularities on the surface are natural to the material (brass), adding value to the piece and are never considered to be defects.

Diseño inspirado en una obra de de Salvador Dalí: 'Femme à tête de roses' (1935). Pie en fundición de latón pulido. Acabado barnizado o pátina negra sin barnizar (Black label). Sobre en latón matizado y barnizado o pátina negra (Black label). Huevo en mármol de Carrara o Nero Marquina (Black Label).

Al tratarse de un proceso artesano, los pequeños poros e irregularidades en la superficie del propio material (latón) es un valor añadido, nunca un defecto.

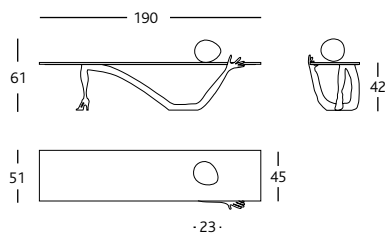

DA0060	Original	20.198
DA0060BL	Black Label (Limited edition of 105 units <i>Edición limitada de 105 unidades</i>)	24.005

PACKAGING

PCS	DIMENSIONS CM	GROSS KG
1	200 x 70 x 55	55

BRACELLI, MULETAS & CAJONES LAMPS / LÁMPARAS

Salvador Dalí

The Bracelli lamp has a wooden board structure covered in fine gilding also available in a darker version. The lampshade is covered in an ivory coloured cotton and rayon fabric. The Muletas and Cajones lampstands are made of bleached lime-wood, varnished or black stained and varnished. Lampshade covered in a beige coloured lingerie satin or lined in the same material and covered in a black transparent chiffon.

Bracelli: estructura de tablero recubierto con láminas de latón doradas mediante técnica de pan de oro, o versión pan de oro oscurecido. Pantalla de tejido de algodón y rayón color marfil. Muletas y Cajones: estructura de talla de tilo decolorada y barnizada o teñida en negro y barnizada. Pantalla de raso de lencería color beige o interior raso de lencería color beige y exterior gasa de lencería color negro.

Bracelli

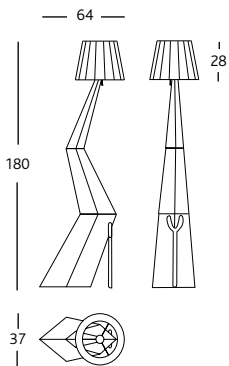

Muletas

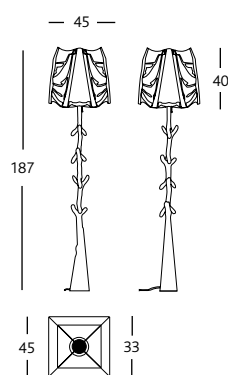

Cajones

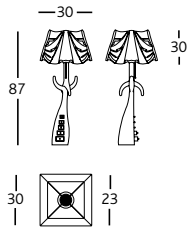

DA0064	Bracelli	6.327
DA0064BL	Bracelli Black Label*	7.592
DA0065	Muletas	4.149
DA0065BL	Muletas Black Label*	4.386
DA0066	Cajones	3.480
DA0066BL	Cajones Black Label*	3.760

- Hand-crafted lampshades
- Spherical bulb Led
- E27 power 9W T 3000K 850 lumen Energy Value A+
- CE UNE-EN 60598-1
- Cortinas hechas a mano.
- Bombilla esférica Led.
- E27 potencia 9W T 3000K 850 lumens Valor Energético A+
- CE UNE-EN 60598-1

*Limited edition of 105 units
Edición limitada de 105 unidades

PACKAGING

	PCS	DIMENSIONS CM	GROSS KG
Bracelli structure / estructura	1	83 x 43 x 190	42
Bracelli shade / pantalla	1	45 x 45 x 40	8
Muletas structure / estructura	1	80 x 28 x 30	28
Muletas shade / pantalla	1	60 x 60 x 60	6
Cajones structure / estructura	1	90 x 26 x 30	12
Cajones shade / pantalla	1	45 x 42 x 38	4

RINOCERÓNICO KNOB / TIRADOR

Salvador Dalí

Three polished lacquered cast bronze pieces joined together.
Tres piezas ensambladas en fundición de bronce pulido y barnizado.

Simple

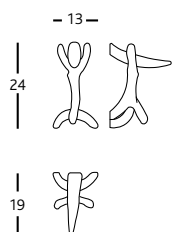

Double

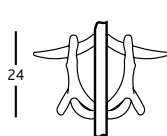

DA0062	Single / Sencillo	3.112
DA0063	Double / Doble	6.128

PACKAGING

	PCS	DIMENSIONS CM	GROSS KG
	1	35 x 42 x 30	6



XAI

Salvador Dalí

Design inspired on an artwork by Salvador Dalí: 'Interpretation Project for a stable-library' (1942). Limited Edition of 20 unique pieces in white and 1 in black. Stuffed lamb, elaborated with a technique by a taxidermist.

Diseño inspirado en una obra de Salvador Dalí: 'Proyecto de interpretación para un establo-biblioteca' (1942). Edición limitada de 20 piezas únicas en blanco y 1 en negro. Cordero disecado elaborado con la técnica de la taxidermia.

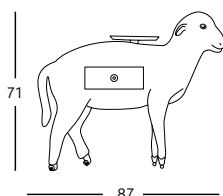

XAI04

44.000

PACKAGING

PCS	DIMENSIONS CM	GROSS KG
1	101 x 92 x 121	30

INVISIBLE PERSONAGE / PERSONAJE INVISIBLE

Salvador Dalí

Design inspired on an artwork by Salvador Dalí: 'Singularities' (1935). Limited Edition of 20 unique pieces. A composite structure upholstered in natural sheepskin with a gloss lacquered polyamide lamp (with a pearl finish with gold colour interior). Light: 500 lumens. Colour temperature: 3000K. Power: 4.8W.

Diseño inspirado en un cuadro de Salvador Dalí: 'Singularidades' (1935). Edición limitada de 20 piezas únicas. Estructura en composite tapizada en piel natural de oveja. Luminaria en poliamida lacada, exterior color perla e interior color oro perlado mate. La luminosidad es de 500 lumens a temperatura de 3000k y una potencia de 4,8W.

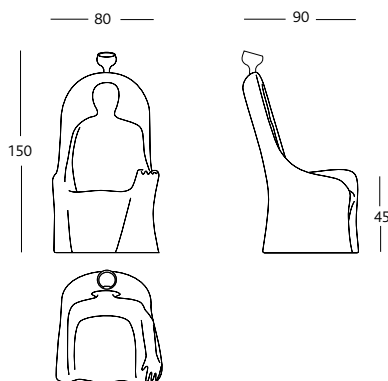

INVPER

52.500

LED lamp included / Incluye lámpara LED

PACKAGING

PCS	DIMENSIONS CM	GROSS KG
1	90 x 100 x 163	55

XAI AND INVISIBLE PERSONAGE MAINTENANCE AND CLEANING

It is important that these pieces not be exposed to a relative humidity above 65%. Avoid placing furniture in direct sunlight. These pieces should be cleaned with a cotton cloth at least once a week to take away any dirt from the upholstery. Clean using a vacuum on low to remove any natural dust. A humid cloth, using only water can also be applied to clean this item. For grease marks, please refer this piece onto a leather or a cleaning specialist.

MANTENIMIENTO Y LIMPIEZA DEL XAI Y PERSONAJE INVISIBLE

Es importante que estas piezas no estén expuestas a una humedad relativa superior al 65%. Evite colocar los muebles al sol directo. Estas piezas deben limpiarse con un paño de algodón al menos una vez a la semana para eliminar la suciedad de la tapicería. Utilice una aspiradora a baja potencia para eliminar el polvo. También se puede limpiar con un paño húmedo. Para marcas de grasa, diríjase a un especialista en limpieza de pieles.

CRISTALLO CUPBOARD / ARMARIO

Alessandro Mendini

MDF laquered in different colours. Interior veneered in sycamore wood with frontal finishes stained in a darker colour, the same as the base. The exterior faces of the doors are also veneered in sycamore, featuring a printed graphic. All of the wooden exterior sides have a satin finish, and the coloured sections in a glossed finish. Limited edition of 99 units.

Tableros de MDF lacados en diferentes colores. Interior chapado en madera de sicomoro con el frontal teñido de un color oscuro al igual que el zócalo. Las puertas, también chapadas en sicomoro en la parte frontal, presentan una gráfica impresa en la madera. Todas las caras vistas de la madera tienen un acabado satinado mientras que todas las caras coloreadas son brillantes. Edición limitada de 99 unidades.

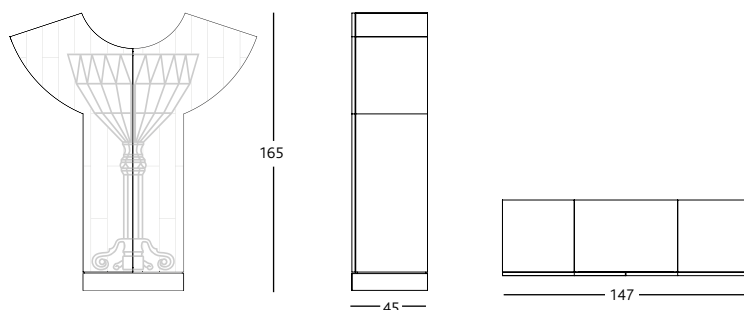

CRISTALLO 22.122

PACKAGING		
PCS	DIMENSIONS CM	GROSS KG
1	160 x 55 x 180	150

TIGER ART GAULINO EASY CHAIR / SILLONCITO

Oscar Tusquets

A limited edition of 50 unique pieces of hand-painted seats with tiger fur patterns by Oscar Tusquets. Ash wood with a coloured patina, dark stained and varnished. A hand painted natural leather seat.

Una serie limitada de 50 ejemplares con asiento pintado a mano con interpretaciones de la piel del tigre por Oscar Tusquets. Madera de fresno con patina de color en el poro, teñido oscuro y barnizado. Asiento en cuero natural pintado a mano.

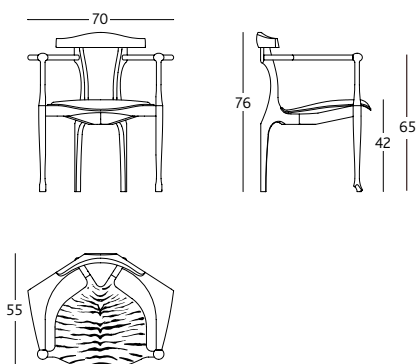

GAUBUEDLIM 8.000

PACKAGING		
PCS	DIMENSIONS CM	GROSS KG
1	78 x 84 x 83	13

METTSASS

Ettore Sottsass Jr.

The structure is of flat sheets of steel painted in red. The glass on the top is painted in the same colour as the structure.

Estructura en chapas planas de acero pintadas en rojo. El vidrio en la parte superior está pintado en el mismo color que la estructura.

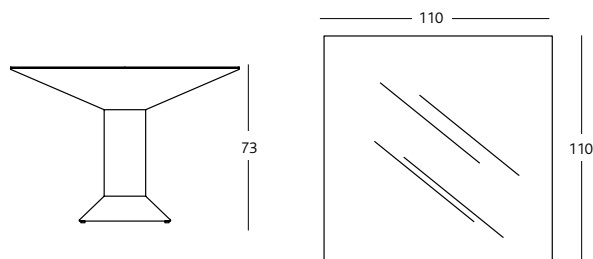

METE07V07 5.863

PACKAGING			
	PCS	DIMENSIONS CM	GROSS KG
glass + bell / vidrio + campana	1	120 x 120 x 40	40
set / conjunto	1	50 x 70 x 80	20



DOOBIDE

Alfredo Häberli

Limited edition of 50 numbered crockery sets. Available in five different colour ranges and 5 graphics: green, beige, flesh, grey and blue. Each range contains 10 crockery sets. Is it composed of a teapot and 6 teacups (3 different models). The pieces are made out of dyed porcelain and painted by hand in platinum.

50 unidades de sets numerado. Disponible en 5 gamas de color y 5 gráficas distintas (verde, beige, rosa anaranjado, gris y azul), las cuales constan de 10 unidades cada una. El set de vajilla hecho con porcelana teñida está compuesto por una tetera de una capacidad de 830 ml y seis tazas (tres modelos distintos). Cada pieza se pinta a mano en platino y la tetera de cada set lleva una calca con la numeración.

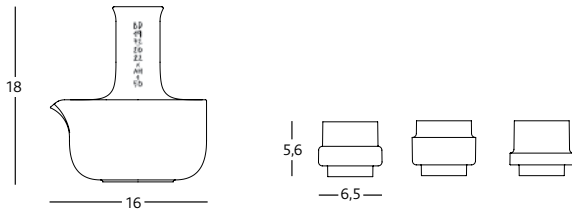

DOOBVERDE	Green / Verde	1.500
DOOBMARRON	Beige	
DOOBTEJA	Flesh / Rosa anaranjado	
DOOBGRIS	Grey / Gris	
DOOBAZUL	Blue / Azul	

PACKAGING

PCS	DIMENSIONS CM	GROSS KG
1	35 x 27,5 x 16,5	3

REMIX VOL. 2 CABINET

Ramón Úbeda

Modules, frontals and shelves veneered in natural stained dark oak. Legs in aluminium with a brass coating. Accessories plated in 24 carat gold and polished. Contenedor, frontales y estantes chapados en roble natural teñido oscuro. Patas en aluminio con baño de latón. Accesorios en latón pulido bañado en oro de 24K.

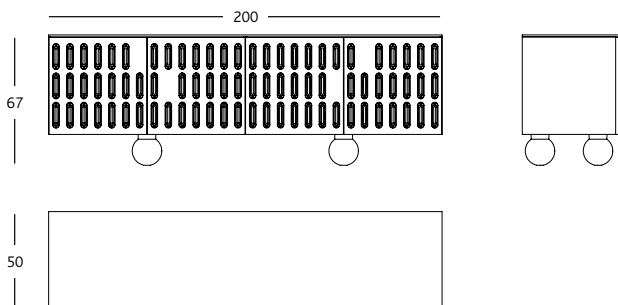

SLIDING CABINET	50.000
-----------------	--------

Limited Edition of 1u / Edición limitada de 1 un.

PACKAGING

PCS	DIMENSIONS CM	GROSS KG
2	110 x 65 x 90	100
1	210 x 50 x 70	55

TALISMAN CABINET (POSTCRAFT COLLECTION)

Maysam Al Nasser

A white matte lacquered MDF sideboard with an inscribed inset in solid teak. Interior veneered in teak and incorporates 3 drawers.

Contenedor de MDF lacado exteriormente color blanco mate, con grabado en teca maciza. Interior chapado en teca, incorpora 3 cajones.

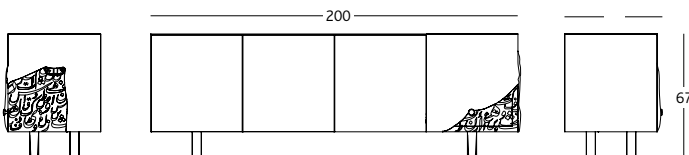

TALISMAN CABINET	33.600
------------------	--------

Limited edition 8 pieces + 2 prototypes + 2 A.P.

Edición limitada de 8 piezas + 2 prototipos + 2 pruebas de artista.

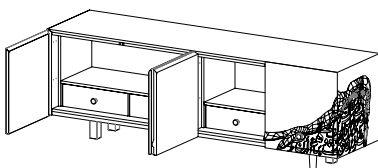

PACKAGING

PCS	DIMENSIONS CM	GROSS KG
1	220 x 60 x 90	150

GENERAL CONDITIONS OF SALE (APPLICABLE FOR ALL EXPORT SALES EXCEPT SPAIN)

1. CATALOGUES AND ORDERS

- 1.1 The information supplied regarding prices, models, dimensions, features and specifications may be modified at any time without prior notice.
- 1.2 The order confirmation is final and binding and must be returned by fax or e-mail duly signed or with the corresponding company stamp.
If we do not receive any news within 5 days, we consider the order confirmation as accepted.

2. CANCELLATION OF ORDERS

- 2.1 Accepted orders may not be cancelled when:
 - After 8 days from the confirmation order.
 - When shipment of the product has already been made.
 - Special materials are used and production has started.

3. PRICES

- 3.1 The present price list replaces all previous ones and may be subject to changes without prior notice.
- 3.2 All prices are in Euros excluding VAT. Discounts, payments and delivery conditions will be agreed between BD and customer.
- 3.3 The Spanish VAT of 21% is mandatory for all orders with the final delivery address in Spain (except the Canary Islands).
- 3.4 If a Certificate of Origin (COO) is required, this must be clearly indicated in writing on confirmation of the order. BD will charge 50€ for the cost of its issuance by the Chamber of Commerce, Industry and Navigation of Barcelona. An additional 50€ will be charged for the invoice to be certified. This will only be provided if requested. If the original copies need to be sent to the addressee/receptor, 50€ will be charged for a courier service.

4. DELIVERY

- 4.1 Terms of delivery should be considered indicative. BD Barcelona 1972 S.L. has no responsibility for delays beyond its control.
- 4.2 A time frame of 5 working days will need to be given for requests of changes in packaging, once items are already packaged and prepared for collection - be it to reduce size(s) or consolidate boxes/orders (or be it for any other reason). A 200€ minimum service charge will be invoiced for such changes, and will need to be paid before a pick-up is organised.
- 4.3 Once the production of an order is finalized, the client has one month, starting from the moment we inform that the order is ready, to come and collect the goods in our facilities. If this period is exceeded, BD reserves the right to charge storage costs for the amount of 1,50€ per day per m3.

5. PAYMENT

- 5.1 All bank charges are the responsibility of the buyer.
- 5.2 All goods not paid in full shall remain property of BD Barcelona 1972 S.L.
- 5.3 Payments not made by their due date as outlined on the client's invoice made by BD Barcelona 1972, S. L. gives BD the right to charge a late payment fixed surcharge of 50 Euros and interest on the total amount. The legal general interest rate applied is the percentage of the Euribor (the interest rate of the European Central Bank of 12 months) with an additional seven percent in accordance with Article 7, Law 3/2004 (29th December) in Prevention of Late Payments related to Commercial Operations. If demonstrated damages are superior to the interest rate applied above, these also will be included in any proceedings made by BD.

6. WARRANTY AND POST-SALE SERVICE

- 6.1 Products are guaranteed for two years from date of invoice, provided that they are used under normal circumstances and installed in accordance with prevailing normatives.
- 6.2 During this period BD will only cover the cost related to the repair of the product.
- 6.3 Liability is limited to defects of manufacture. Excluded from this guarantee are all damages made by transport, incorrect use, negligence and normal wear and tear of the merchandise. BD Barcelona 1972 S.L. is explicitly excluded from all responsibility for any damage or loss which such defects may cause, either directly or indirectly.
- 6.4 BD Barcelona 1972 S.L. is not liable under any circumstances for defects that may be present in merchandise when exported by the buyer.

7. CLAIMS

- 7.1 If transport is covered by BD, any damage incurred on packaging and products must be indicated on the transporters delivery note immediately on receipt at the delivery address indicated on the transport documents and BD invoice and must notify BD Barcelona 1972 S.L. within 24 hours of reception at the aforementioned delivery address. Failing to do this, BD Barcelona 1972 S.L. will not accept any further claim.
- 7.2 In addition to our product guarantee, BD Barcelona 1972 S.L. shall attend any written claims concerning errors in quantity or defects and any incidents regarding supply, within six days of the receipt of the goods.

8. RETURN OF THE GOODS

- 8.1 The return of the goods shall not be accepted without our express written authorisation.

9. VENUE, JURISDICTION AND APPLICABLE LAW

- 9.1 In any dispute arising out of or in any way related to this agreement, including any claim sounding in tort or contract (including, but not limited to any claim for negligence and/or products liability), parties agree that the Barcelona Courts shall have exclusive jurisdiction to hear the dispute; and parties agree that they shall not bring a claim in any other jurisdiction.
- 9.2 Parties further agree that any such dispute shall be exclusively governed by the laws of Barcelona, Cataluña and Spain, as applicable, without regard to any conflicts of law or choice of law principles thereof.



CONDICIONES GENERALES DE VENTA (APLICABLES SOLO A VENTAS REALIZADAS EN ESPAÑA)

1. GENERALIDADES

- 1.1 Todas las relaciones comerciales entre BD Barcelona 1972 S.L., domiciliada en C/ Ramón Turró 126, 08005 Barcelona, con NIF B61713756, (en adelante, el Vendedor) y sus Compradores se regirán por las presentes Condiciones Generales de Venta, excepto en todo aquello que esté expresamente acordado de forma distinta en la oferta correspondiente o en la aceptación del pedido y que constituyan las condiciones particulares del mismo.
- 1.2 Estas Condiciones Generales de Venta, así como aquellas particulares expresadas en el punto 1.1. cuando correspondan, se consideran aceptadas por el Comprador por el mero hecho de cursar un pedido.
- 1.3 El Vendedor se reserva el derecho de actualizar y/o modificar el contenido de las presentes Condiciones Generales de Venta en cualquier momento sin previo aviso, sin perjuicio de los contratos ya perfeccionados.

2. CATÁLOGOS

- 2.1 Todas las informaciones y descripciones contenidas en nuestros catálogos y demás documentación son puramente orientativas y no vinculantes.
- 2.2 El Vendedor se reserva el derecho a modificar sin previo aviso la información referente a precios, modelos, dimensiones, características y especificaciones contenida en catálogos y demás documentación, sin perjuicio de lo establecido en el punto 1.

3. PEDIDOS

- 3.1 Para que se considere efectivo y vinculante, el pedido tiene que recibir una aceptación expresa por parte del Vendedor. El comprador deberá devolver por fax firmada y sellada o por correo electrónico la confirmación de pedido. De no recibir noticias en un plazo de 5 días hábiles, se considera aceptado y vinculante.
- 3.2 Los pedidos aceptados no podrán ser anulados por parte del Comprador en los casos siguientes:
 - a) Transcurridos 5 días desde la confirmación del pedido por parte del Vendedor.
 - b) Cuando se ha efectuado la expedición del producto y así se ha comunicado al Comprador.
 - c) Cuando, tratándose de materiales de producción especial, ésta se hubiera comenzado y se hubiera comunicado al Comprador el inicio de la producción.

4. PRECIOS

- 4.1 Los precios de venta se rigen por la tarifa vigente en cada momento y podrán ser modificados por el Vendedor sin previo aviso, a no ser que ya hayan sido confirmados al Comprador.
- 4.2 Todos los precios son en EUROS y no incluyen el I.V.A. vigente ni cualquier otro impuesto, derecho o tasa, que se repercutirán posteriormente en la factura con los tipos correspondientes. Los descuentos, forma de pago y las condiciones de entrega serán acordados entre el Vendedor y el Comprador en cada caso individualmente.
- 4.3 Para entregas en España, los portes serán pagados para pedidos superiores a 500€ netos. Para entregas en Andorra, el pedido mínimo será de 600€ más unos portes de 60€. A partir de 1.000€ netos, la entrega será libre de portes.
- 4.4 En caso de ser necesaria la emisión de un certificado de origen, el cliente debe indicarlo en el momento de cursar el pedido. BD facturará 50€ para cubrir el coste de su emisión por la Cámara de Comercio, Industria y Navegación de Barcelona, y 50€ adicionales en caso de tener que enviar el original por mensajería. Se cobrarán 50€ adicionales por la certificación de la factura. Esto solo se proporcionará si se solicita.

5. CONDICIONES DE PAGO

- 5.1 El pago de las mercancías debe realizarse al contado mediante transferencia bancaria, cheque, recibo domiciliado, salvo que se conceda crédito al Comprador, en cuyo caso se hará efectivo mediante los medios acordados en el plazo o plazos estipulados expresamente.
- 5.2 Para los pedidos de fabricación especial, el Comprador deberá efectuar un pago a cuenta a determinar en cada caso del precio total estipulado, no comenzándose la producción del pedido hasta el abono de la cuantía correspondiente.
- 5.3 En todo caso, la demora de pago por facturas vencidas faculta al Vendedor a exigir el pago inmediato de todas las facturas no vencidas, así como el pago anticipado de todas las entregas no efectuadas hasta la fecha y correspondientes a pedidos confirmados. De igual forma, produce la cancelación automática del crédito, en caso de haberse concedido.
- 5.4 En caso de que exista un retraso en la realización del pago, el Vendedor tendrá derecho a exigir intereses de demora por cuantía del interés legal aplicable en cada momento por el Banco Central Europeo incrementado en 8 puntos. Además, el comprador soportará los gastos derivados de los retrasos en el pago de las cantidades acordados (honorarios de abogados, costas judiciales), siendo un mínimo de 50,00€ por caso, todo ello sin perjuicio de demostrar y reclamar un daño superior.
- 5.5 Las facturas han de ser satisfechas por el importe íntegro que se menciona en ella, no haciéndose el Vendedor responsable de los gastos bancarios que al Comprador puedan ocasionarle en función del método de pago seleccionado.

6. FORMA DE ENTREGA

- 6.1 La forma de entrega será indicada en caso en las condiciones particulares de cada pedido. Las mercancías vendidas se entienden a disposición del Comprador en los almacenes del Vendedor, cesando la responsabilidad del Vendedor sobre ellas desde el momento en que éste las pone a disposición del transportista (suministro EXW según INCOTERM 2010) a no ser que se haya estipulado otra forma de entrega.
- 6.2 El Vendedor no asume los riesgos del transporte, que serán totalmente a cargo del Comprador, incluso los daños y menoscabos producidos durante el transporte de mercancías, sin perjuicio de que el Vendedor pueda bonificar algún importe, lo cual no supondrá, en todo caso, la derogación de la cláusula anterior ni la aceptación por parte del Vendedor de los riesgos del mismo.
- 6.3 Los plazos de entrega de la mercancía deben considerarse indicativos. El Vendedor no asume responsabilidad alguna en caso de demoras, que no autorizan al Comprador a la anulación del pedido ni a la aplicación de penalizaciones o indemnizaciones, salvo que se haya convenido expresamente lo contrario por escrito. Aún en este caso, si fuera por causas de fuerza mayor y BD no pudiera cumplir algún compromiso acordado, no sería aplicable sanción alguna.
- 6.4 Será necesario dar un plazo de 5 días hábiles para las solicitudes de cambios en el embalaje, una vez que los artículos ya estén empaquetados y preparados para la recogida, ya sea para reducir tamaño(s) o agrupar cajas/pedidos (o por cualquier otro motivo). Se facturará un cargo de servicio mínimo de 200€ por dichos cambios, y deberá pagarse antes de que se organice la recogida.
- 6.5 Una vez terminada la producción del pedido, el cliente dispone de 1 mes para recoger la mercancía en nuestras instalaciones a contar desde nuestra comunicación de que el pedido está preparado. En caso de superar este plazo de tiempo, BD se reserva el derecho de cargar como gastos de almacenamiento el importe de 1,5€ al día por m³.

7 FUERZA MAYOR

7.1 En caso de que el Vendedor se vea impedido, total o parcialmente, para el cumplimiento de sus obligaciones contractuales por causa de fuerza mayor, el cumplimiento de la/s obligación/es afectada/s quedará suspendido, sin responsabilidad alguna del Vendedor, por el tiempo que sea razonablemente necesario según las circunstancias.

7.2 El Vendedor tendrá en casos de fuerza mayor derecho a retrasar la entrega de la mercancía y, en caso de que persistan durante más de un mes, a anular los pedidos, sin obligación de indemnización al Comprador.

Aún en el caso de que las partes hubieren acordado expresamente penalizaciones e indemnizaciones por demoras en la entrega de la mercancía, ésta no corresponderá en casos de que la demora sea debida a causas por fuerza mayor.

8. GARANTÍA Y SERVICIO POSTVENTA

8.1 Los productos del Vendedor tienen una garantía de dos años a partir de la fecha de emisión de la factura por el Vendedor.

8.2 Durante este plazo, el Vendedor cubrirá únicamente los defectos de fabricación, los gastos de envío, así como los costes internos de mano de obra y los materiales.

8.3 Se excluyen los daños originados por el transporte, uso indebido, negligencias, desgaste natural de la mercancía y los materiales suministrados por el Comprador. En ningún caso el Vendedor responderá por los daños y perjuicios que por el defecto en el producto hayan podido producirse, directa o indirectamente.

8.4 El Vendedor no se responsabiliza de una conservación incorrecta de los materiales plásticos frente a la repulsión al polvo y los acondicionamientos climáticos.

8.5 El vendedor no se responsabiliza en ningún caso de los defectos que pueda presentar la mercancía en el caso de que ésta haya sido exportada por el comprador.

9. RECLAMACIONES

9.1 Cualquier incidencia sufrida por los productos durante su transporte, deberá hacerse constar expresamente y con claridad suficiente en el albarán de entrega del transportista, debiendo ser comunicada esta incidencia al Vendedor antes de transcurridas 24 horas desde su recepción. En caso contrario, el Vendedor no responderá por reclamaciones del Comprador, a salvo de lo establecido en el artículo 8.1 de estas Condiciones Generales de Venta.

9.2 Además de la garantía recogida en el artículo 8.1 de estas Condiciones Generales de Venta, el Vendedor atenderá a reclamaciones basadas en errores o defectos en la cantidad suministrada de los productos o cualquier disconformidad en relación al suministro de los mismos, siempre que estas reclamaciones sean comunicadas al Vendedor por escrito dentro de los 6 días siguientes a la recepción de la mercancía. Cumplido ese plazo, se presume que la mercancía suministrada es conforme con el pedido realizado y no se admitirá reclamación alguna posterior.

9.3 Las posibles reclamaciones de cualquier tipo no dan derecho a suspender los pagos acordados (si las reclamaciones tienen origen en un incumplimiento de BD, el comprador debería poder rescindir el contrato y por lo tanto, suspender los pagos acordados).

10. DEVOLUCIONES

No se aceptarán devoluciones de las mercancías, salvo que el Vendedor expresamente las autorice por escrito.

11 PROPIEDAD DE LA MERCANCÍA

11.1 El Vendedor se reserva el derecho a la plena propiedad de los bienes vendidos hasta el pago total y efectivo por el Comprador del precio e importes facturados. El Comprador podrá transformar o revender dichos bienes en el marco de una normal gestión comercial, no transfiriéndose, en el marco de esta reserva de dominio, la propiedad de las mismas al Comprador ni, en su caso, al comprador de la reventa. En este sentido, el Comprador está obligado a informar al Vendedor sobre todas las medidas adoptadas por terceros que afecten a los bienes mientras sean propiedad del Vendedor.

12 PROTECCIÓN DE DATOS

12.1 Los datos personales facilitados por el Comprador serán incorporados a un fichero titularidad del Vendedor e inscrito en la Agencia de Protección de Datos, con la finalidad de tramitar y facturar los pedidos, resolver las posibles incidencias que se produzcan así como para facilitar al Comprador la recepción de información y/o correspondencia que pudiera ser de su interés.

12.2 Los datos del Comprador serán tratados exclusivamente por el Vendedor, quien decidirá sobre el contenido, la finalidad y el uso que se dé a las mismas.

12.3 En cumplimiento de lo dispuesto en la Ley Orgánica 15/1999, de 13 de diciembre, el Comprador podrá ejercer sus derechos de acceso, rectificación, cancelación y oposición dirigiéndose por escrito a BD Barcelona 1972, S.L., con domicilio en la C/ Ramón Turró 126, 08005 Barcelona.

12.4 En cualquier caso, se informa al Comprador que, cuando los datos estén asociados a una compra, deberán mantenerse durante el período que legal y fiscalmente indique la legislación española, pudiéndose bloquear, pero no borrar ni rectificar.

13 JURISDICCIÓN

13.1 Las partes acuerdan mutuamente que todo litigio, independiente de su naturaleza, relativo a la presente venta, su cumplimiento, ejecución e interpretación, incluyendo también reclamaciones de agravio o contrato (incluyendo pero no limitado a cualquier reclamación de negligencia y/o responsabilidad del producto), será sometida a la competencia exclusiva de los Juzgados y Tribunales de la ciudad de Barcelona (España), con expresa renuncia de las partes de reclamar en otra jurisdicción.

13.2 Además, las partes acuerdan que a cualquier disputa serán de aplicación exclusivamente las disposiciones legales y reglamentarias aplicables a la ciudad de Barcelona, Cataluña y España, sin perjuicio de conflictos de leyes o principios de derecho resultantes.

BD Barcelona Design

Ramon Turró,126
08005 Barcelona, Spain
+34 93 457 00 52
sales@bdbarcelona.com
comercial@bdbarcelona.com

www.bdbarcelona.com



Product specifications are for general information only. BD reserves the right to change design and finish without prior notice.

Las especificaciones que se facilitan son a título orientativo. BD se reserva el derecho de modificar sin previo aviso los diseños y acabados.

