

BRANDVAN
® **EGMOND**



2019

Brand van Egmond

Every year we at BRAND VAN EGMOND strive to use all our knowledge and experience in order to create some of the most astounding lighting sculptures.

We are constantly inspired by the world around us, the people we meet and the beautiful projects we are invited to be part of. In return, we are frequently asked to translate unique lighting wishes into handcrafted reality. Partners like Louis Vuitton, Chopard and the Four Seasons Hotels invited BRAND VAN EGMOND to create tailor-made lighting solutions for their spaces. We welcome everybody who wants to see our designs, or would like personal advice from William Brand and his team, to our office and ateliers in Naarden, The Netherlands.

WILLIAM BRAND
BRAND VAN EGMOND TEAM

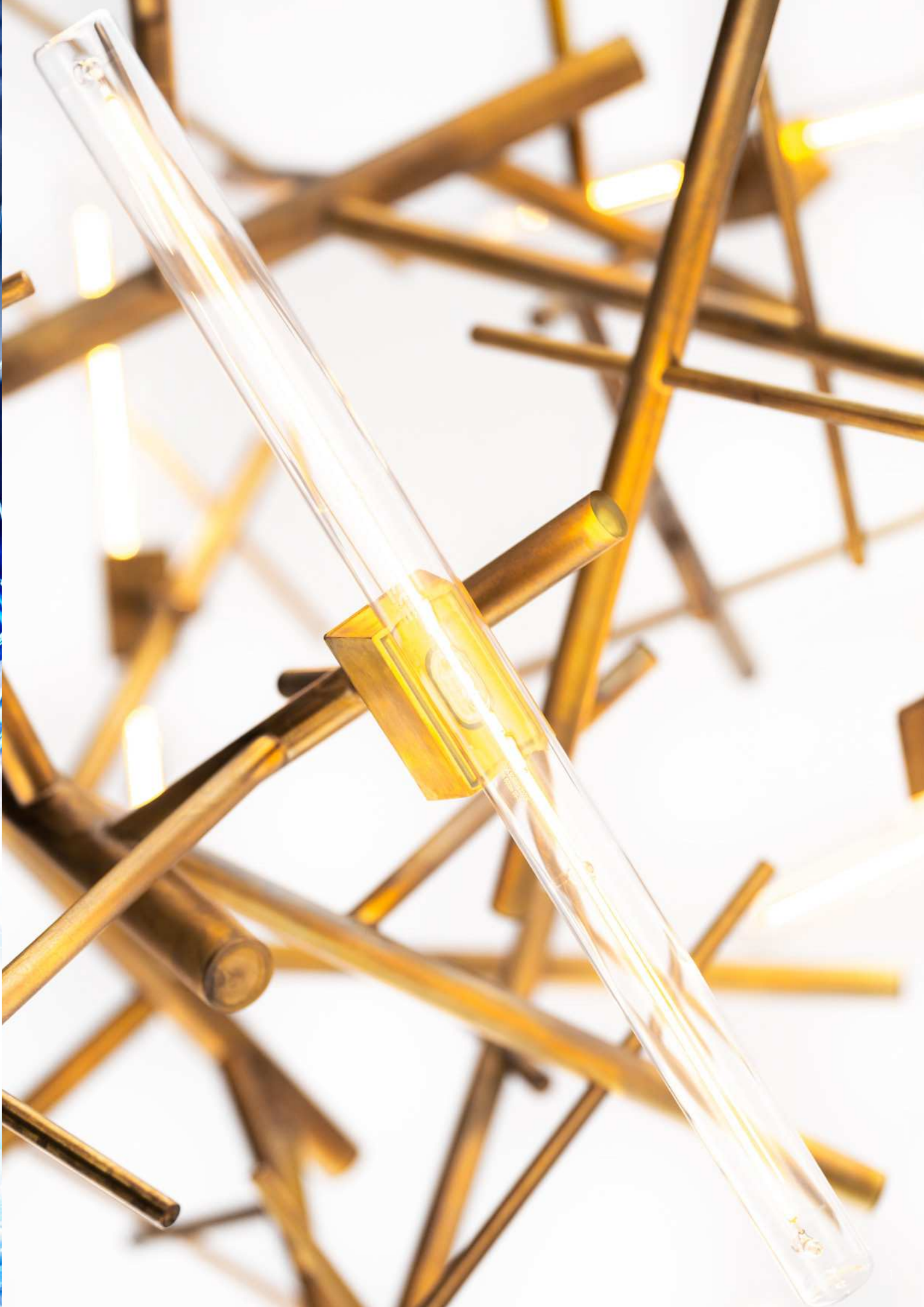

Linea

Design by William Brand

Truthful and pure, the Linea makes a precise yet playful statement through thin lines of beauty.

Floating through the sky, as if a magical formula brought to a standstill the whirlwind of steel, fire and light.

Frozen, both in time as well as in space.

Just like airplanes can leave a composition of line-shaped clouds -the passing proof of human movement in the air- the Linea is like a drawing of illuminating lines in the sky. Temporarily mid-air, permanently illuminating.

Creating a beautiful light is like good architecture: a matter of proportions.



LINC100BRBUR

Chandelier Round

(Ø100xH.70cm, brass burnished finish, 7 x S14D, 25.0kg)



LINW60BRBUR

Wall Lamp

(L.12xW.12xH.60 cm, brass burnished finish, 1 x S14DD, 4.0kg)

LINC100BRBUR

Chandelier Round

(Ø100xH.70cm, brass burnished finish, 7 x S14D, 25.0kg)



LINC100BLM
Chandelier Round
(Ø100xH.70cm, black matt finish, 7 x S14D, 25.0kg)

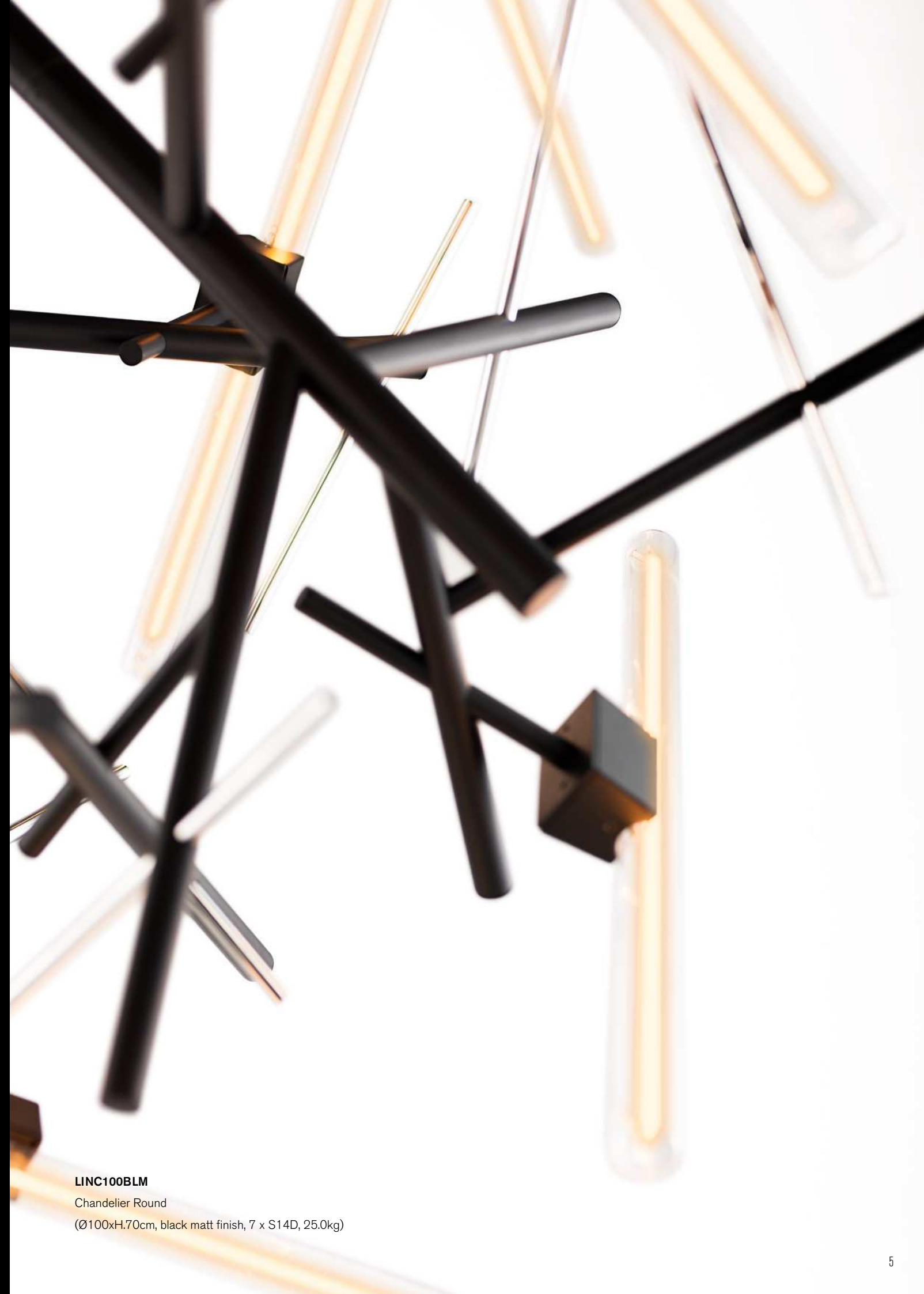

LINC100BLM
Chandelier Round
(Ø100xH.70cm, black matt finish, 7 x S14D, 25.0kg)



LINLT50-70BLM and LINLT50-70B
Composition of 7 Linea Elements
(Ø70xH.70cm, black matt and brass grinded finish, 5 x S14D, 6.0kg)

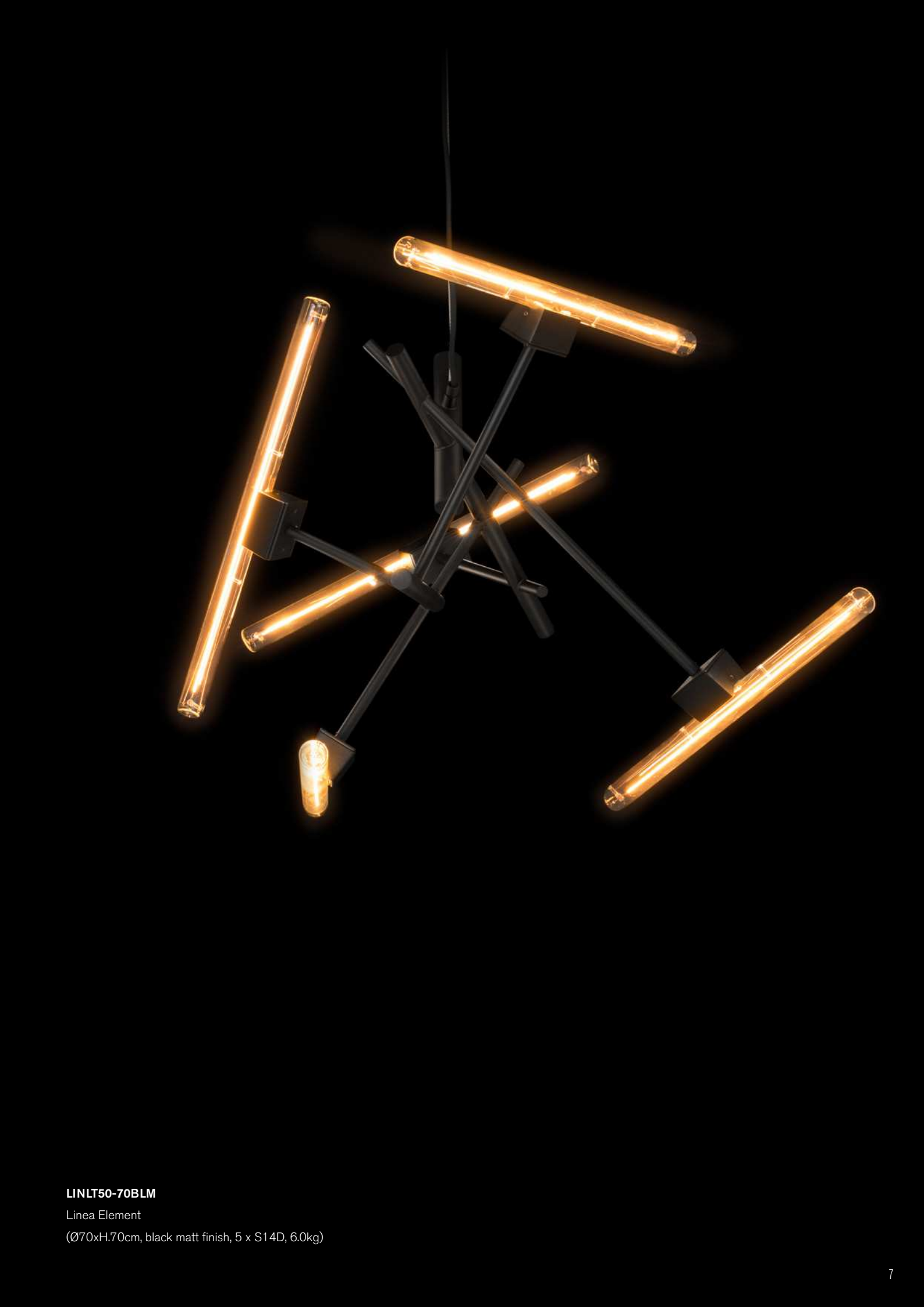

LINLT50-70BLM
Linea Element
(Ø70xH.70cm, black matt finish, 5 x S14D, 6.0kg)



LINLT50-70BLM

Linea Element

(Ø70xH.70cm, black matt finish, 5 x S14D, 6.0kg)



LINLT50-70BLM

Linea Element

(Ø70xH.70cm, black matt finish, 5 x S14D, 6.0kg)

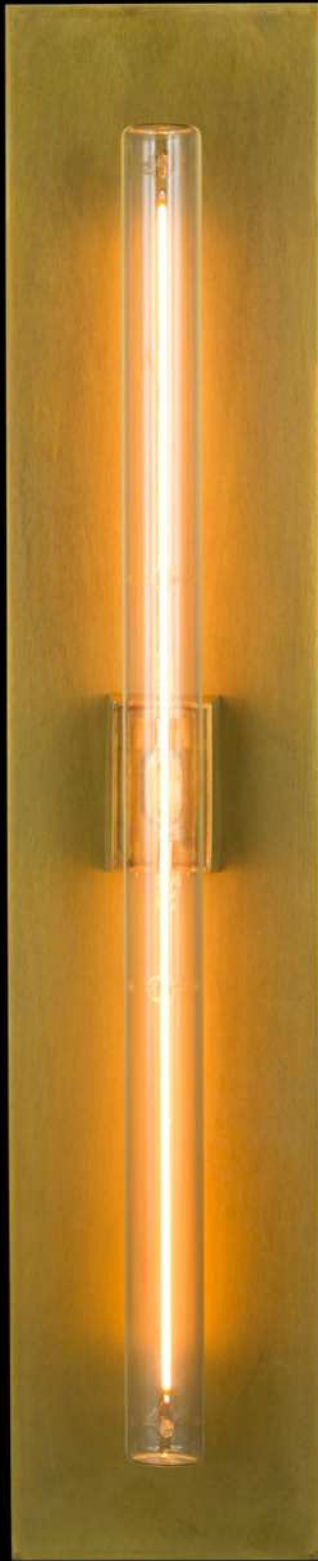

LINW60BRBUR

Linea Wall Lamp

(L.12xW.12xH.60 cm, brass burnished finish, 1 x S14D, 4.0kg)



LINW60NA

Linea Wall Lamp

(L.12xW.12xH.60 cm, nickel aged finish, 1 x S14D, 4.0kg)

Galaxy

Design by William Brand

The Galaxy is a constellation of energy, movement and form. Propelling away from the centre of gravity towards clouds of stardust and outer planets.

Avant-Garde by nature, the shapes and forms of the Galaxy relate to each other as the planets towards the sun. The artist and the dreamer both know, space is where an image grows.

The new collection Galaxy fell into the 21st century without a trace of regret from a different era, lightyears away. A lasting design has to have roots.



GALHL140BLM-LGBR

Galaxy Hanging Lamp Long

(L.140xW.50xH.40 cm, black matt finish, light globes in brass finish, 3x GU10 spot downlight, 3 x E27, 15.0kg)



GALHL140BLM-LGBR

Galaxy Hanging Lamp Long

(L.140xW.50xH.40 cm, black matt finish, light globes in brass finish, 3x GU10 spot downlight, 3 x E27, 15.0kg)



GALC100BR
Galaxy Chandelier Round
(Ø90xH.110 cm, brass finish, 5 x E27, 17.0kg)



GALC100BR
Galaxy Chandelier Round
(Ø90xH.110 cm, brass finish, 5 x E27, 17.0kg)

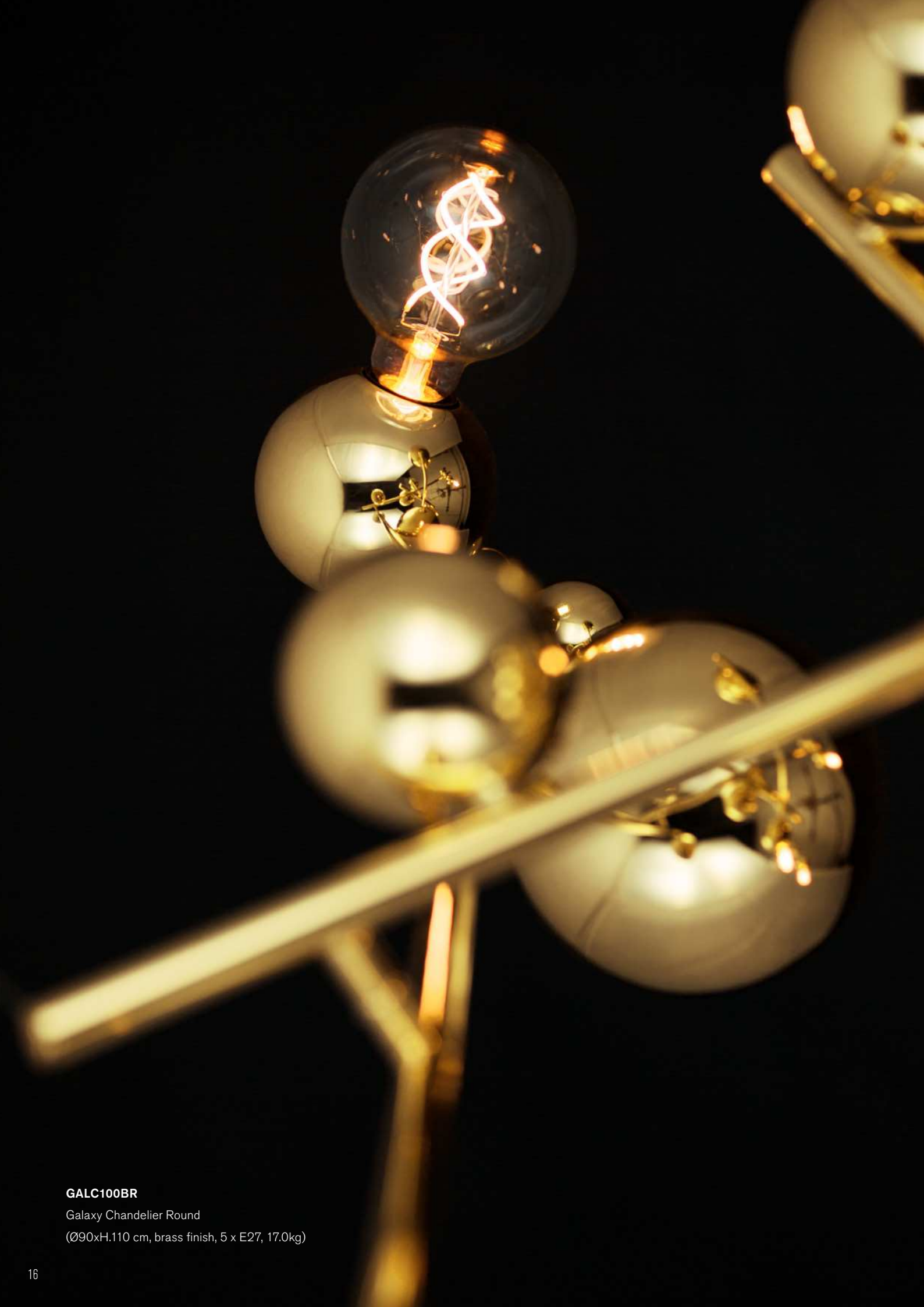

GALC100BR
Galaxy Chandelier Round
(Ø90xH.110 cm, brass finish, 5 x E27, 17.0kg)



GALC100BR
Composition of 9 Galaxy Chandeliers Round
(Ø90xH.110 cm, brass finish, 5 x E27, 17.0kg)



GALC80BRBUR
Galaxy Chandelier Round
(Ø80xH.70 cm, brass burnished finish, 3 x E27, 17.0kg)



GALC80BRBUR
Galaxy Chandelier Round
(Ø80xH.70 cm, brass burnished finish, 3 x E27, 17.0kg)

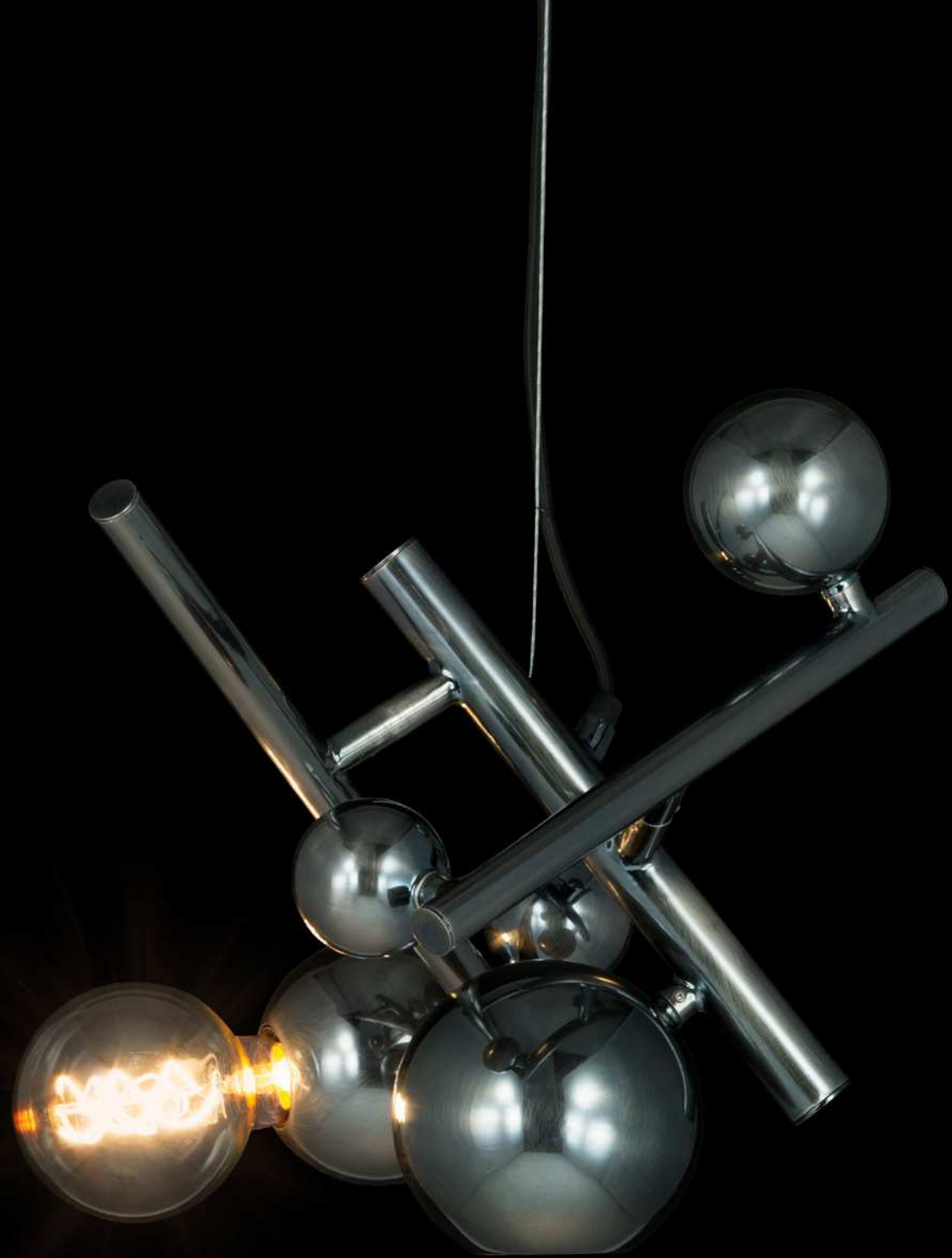

GALDL45NA

Galaxy Element

(L.40xW.45xH.50 cm, nickel aged finish, 1x GU10 spot downlight, 1 x E27, 5.0kg)



GALDL45NA

3 Galaxy Elements Inline

(L.40xW.45xH.50 cm, nickel aged finish, 1x GU10 spot downlight, 1 x E27, 5.0kg)



GALF180N

Galaxy Floor Lamp

(L.70xW.40xH.190 cm, nickel finish, 3 x E27, 21.0kg)



GALF180N

Galaxy Floor Lamp

(L.70xW.40xH.190 cm, nickel finish, 3 x E27, 21.0kg)

Louise

Design by William Brand

With almost carefree delight, William designed this Louise collection: A simple frame, decorated in a pleasing rhythm with glass lanterns.

A hint of chaos, never far away in designs from William Brand, is present: the different colours and positions of the glass lanterns have a joyful effect.

The frame is available in nickel aged, brass grinded, black matt, copper burnished and the lanterns in 4 different types of glass: bronze, clear satin, grey and iridescent.



LO4BRBUR - STANDARD

Standard Louise Hanging lamp in brass burnished finish with a bronze, clear satin, grey and iridescent glass lantern
(Ø60xH.78cm, brass burnished finish, 1x GLLOBRO22, 1x GLLOGREY22, 1x GLLOSAT22, 1x GLLIIRI22, 4 x E27, 14.0kg)



LO3BRBUR - STANDARD

Standard Louise Hanging lamp in brass burnished finish with a clear satin, grey and iridescent glass lantern
(Ø60xH.70cm, brass burnished finish, 1x GLLOGREY22, 1x GLLIIRI22, 1x GLLOSAT22, 3 x E27, 11.5kg)



LO4BRBUR - STANDARD

Standard Louise Hanging lamp in brass burnished finish with a bronze, clear satin, grey and iridescent glass lantern
(Ø60xH.78cm, brass burnished finish, 1x GLLOBRO22 ,1x GLLOGREY22,1x GLLOSAT22, 1x GLLIIRI22, 4 x E27, 14.0kg)



LO5BRBUR - STANDARD

Standard Louise Hanging lamp in brass burnished finish with a bronze, clear satin, grey and iridescent glass lantern
(Ø60xH.105cm, brass burnished finish, 1x GLLOBRO22 ,1x GLLOGREY22, 2x GLLOSAT22, 1x GLLIIRI22, 5 x E27, 18.0kg)



LOC80BRBUR-STANDARD

Standard Louise Chandelier Round in brass burnished finish with a bronze, clear satin, grey and iridescent glass lantern
 (Ø82xH.53 cm, brass burnished finish, 3x GLLBRO22 ,1x GLLGREY22,1x GLLSAT22, 2x GLLIIRI22, 7 x E27, 25.0kg)



LOF200BRG-STANDARD

Standard Floor Lamp in brass grinded finish with a bronze, clear satin and iridescent glass lantern
 (Ø50xH.202 cm, brass grinded finish, 1x GLLBRO22, 1x GLLSAT22, 1x GLLIIRI22, 3 x E27, 16.0kg)

LOC80BRBUR-STANDARD

Standard Louise Chandelier Round in brass burnished finish with a bronze, clear satin, grey and iridescent glass lantern
 (Ø82xH.53 cm, brass burnished finish, 3x GLLBRO22 ,1x GLLGREY22,1x GLLSAT22, 2x GLLIIRI22, 7 x E27, 25.0kg)



LO8BRBUR - STANDARD

Standard Louise Hanging lamp in brass burnished finish with a bronze, clear satin, grey and iridescent glass lantern
(Ø60xH.205cm, brass burnished finish, 2x GLL0BRO22 ,2x GLL0GREY22, 2x GLL0SAT22, 2x GLL0IRI22, 8 x E27, 28.0kg)





SPLOHL140BRBUR

Hanging Lamp Long in brass burnished finish with 10 iridescent glass lanterns
(L.140xW.55xH.62 cm, brass burnished finish, 10x GLLDIRI22, 10 x E27, 22.0kg)



LOHL140BRBUR-STANDARD

Standard Hanging Lamp Long in brass burnished finish with bronze, clear satin, grey and iridescent glass lantern
(L.140xW.55xH.62 cm, brass burnished finish, 3x GLLBRO22 ,2x GLLGREY22, 2x GLLSAT22, 3x GLLDIRI22,)



LO1BRBUR-GLLOSAT22

Louise Hanging lamp in brass burnished finish, clear satin glass lantern
(Ø60xH.36cm, brass burnished finish, 1x GLLOSAT22, 1 x E27, 2.4kg)



LO1BRBUR-GLLOGREY22

Louise Hanging lamp in brass burnished finish, grey glass lantern
(Ø60xH.36cm, brass burnished finish, 1x GLLOGREY22, 1 x E27, 2.4kg)



LO1BRBUR-GLOBRO22

Louise Hanging lamp in brass burnished finish, bronze glass lantern
(Ø60xH.36cm, brass burnished finish, 1x GLOBRO22, 1 x E27, 2.4kg)



LO1BRBUR-GLLOIRI22

Louise Hanging lamp in brass burnished finish, iridescent glass lantern
(Ø60xH.36cm, brass burnished finish, 1x GLLOIRI22, 1 x E27, 2.4kg)



LO1BRBUR-GLLOSAT22

Louise Hanging lamp in brass burnished finish, clear satin glass lantern
(Ø60xH.36cm, brass burnished finish, 1x GLLOSAT22, 1 x E27, 2.4kg)

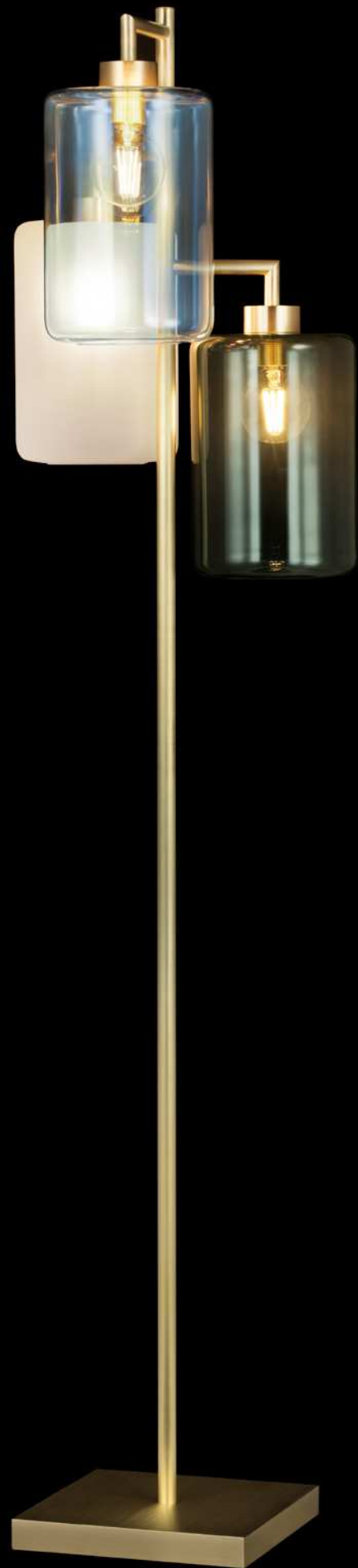

LOF200BRG-STANDARD

Standard Floor Lamp in brass grinded finish with a bronze, clear satin and iridescent glass lantern
(Ø50xH.202 cm brass grinded finish, 1x GLOBRO22, 1x GLOSAT22, 1x GLOIRI22, 3 x E27, 16.0kg)



LOF180COPBUR-GLOIRI22

Louise Floor Lamp in copper burnished finish with an iridescent glass lantern
(Ø30xH.182 cm, copper burnished finish, 1x GLOIRI22, 1 x E27, 11.0kg)



LOT75NA-GLLOIRI22

Louise Table Lamp in nickel aged finish with an iridescent glass lantern
(L.35xW.22xH.76 cm, nickel aged finish, 1x GLLOIRI22, 1 x E27, 8.0kg)



LOT75BRBUR-GLLOSAT22

Louise Table Lamp in brass burnished finish with a clear satin glass lantern
(L.35xW.22xH.76 cm, brass burnished finish, 1x GLLOSAT22, 1 x E27, 8.0kg)



LOP60BRBUR-STANDARD

Standard Louise Ceiling Lamp Round in brass burnished finish with a bronze, grey and iridescent glass lantern (Ø60xH.50 cm, brass burnished finish, 1x GLLOBRO22 ,1x GLLOGREY22, 1x GLLOIRI22, 3 x E27, 10.0kg)



LOP60NA-STANDARD

Standard Louise Ceiling Lamp Round in nickel aged finish with a clear satin, grey and iridescent glass lantern (Ø60xH.50 cm, nickel aged finish, 1x GLLOSAT22 ,1x GLLOGREY22, 1x GLLOIRI22, 3 x E27, 10.0kg)



LOW60NA
Louise Wall Lamp in nickel aged finish with a iridescent glass lantern
(L.22xW.30xH.58 cm, nickel aged finish, 1x GLLOIRI22, 1 x E27, 4.0kg)



LOW60BRBUR
Louise Wall Lamp in brass burnished finish with a grey glass lantern
(L.22xW.30xH.58 cm, brass burnished finish, 1x GLLOGREY22,
1 x E27, 4.0kg)



LOW60BRBUR
Louise Wall Lamp in brass burnished finish with a bronze glass lantern
(L.22xW.30xH.58 cm, brass burnished finish, 1x GLLOBRO22,
1 x E27, 4.0kg)



LOW60BRBUR
Louise Wall Lamp in brass burnished finish with a iridescent glass lantern
(L.22xW.30xH.58 cm, brass burnished finish, 1x GLLOIRI22,
1 x E27, 4.0kg)



LOW60BRBUR
Louise Wall Lamp in brass burnished finish with a clear satin glass lantern
(L.22xW.30xH.58 cm, brass burnished finish, 1x GLLOSAT22,
1 x E27, 4.0kg)



ERSACC90N-GLIRI

Ersa Chandelier Conical with iridescent glass spheres.
(Ø90xH.120 cm, nickel finish, 9 x E27, 35kg)



ERSACC90N-GLIRI

Ersa Chandelier Conical with iridescent glass spheres.
(Ø90xH.120 cm, nickel finish, 9 x E27, 35kg)



ERSAOC140BRBUR-GLIRI

Ersa Chandelier Oval with iridescent glass spheres
(L.140xW.60xH.70 cm, brass burnished finish, 7 x E27, 20kg)



ERSAOC140BRBUR-GLIRI

Ersa Chandelier Oval with iridescent glass spheres
(L.140xW.60xH.70 cm, brass burnished finish, 7 x E27, 20kg)



ERSAOC140BRBUR-GLIRI

Ersa Chandelier Oval with iridescent glass spheres

(L.140xW.60xH.70 cm, brass burnished finish, 7 x E27, 20kg)



ERSAC120N-GLIRI

Ersa Chandelier Round with iridescent glass spheres
(Ø120xH.70 cm, nickel finish, 9 x E27, 32kg)



ERSAC120N-GLIRI

Ersa Chandelier Round with iridescent glass spheres
(Ø120xH.70 cm, nickel finish, 9 x E27, 32kg)



ERSAC100BRBUR-GLBRO

Ersa Chandelier Round with bronze translucent glass spheres
(Ø110x H.75 cm, brass burnished finish, 7 x E27, 23kg)



ERSAC100N-GLCLE

Ersa Chandelier Round with clear glass spheres
(Ø110x H.75 cm, nickel finish, 7 x E27, 23kg)



ERSAC100B-GLBRO

Ersa Chandelier Round with bronze translucent glass spheres
(Ø110x H.75 cm, bronze finish, 7 x E27, 23kg)



ERSAC80BRBUR-GLIRI

Ersa Chandelier Round with iridescent glass spheres
(Ø80xH.65 cm, brass burnished finish, 5 x E27, 15kg)



ERSAC80N-GLIRI

Ersa Chandelier Round with iridescent glass spheres
(Ø80xH.65 cm, nickel finish, 5 x E27, 15kg)



ERSAC80BLM-GLCLE

Ersa Chandelier Round with clear glass spheres
(Ø80xH.65 cm, black matt finish, 5 x E27, 15kg)



ERSA4BR-GLBRO

Ersa Chandelier Round with bronze translucent glass spheres
(L.80xW.55xH.50 cm, brass finish, 4 x E27, 11kg)



ERSA4N-GLIRI

Ersa Chandelier Round with iridescent glass spheres
(L.80xW.55xH.50 cm, nickel finish, 4 x E27, 11kg)



ERSA4BLM-GLIRI

Ersa Chandelier Round with iridescent glass spheres
(L.80xW.55xH.50 cm, black matt finish, 4 x E27, 11kg)



ERSA4BLM-GLIRI

Ersa Chandelier Round with glass iridescent spheres
(L.80xW.55xH.50 cm, black matt finish, 4 x E27, 11kg)



ERSAV110N-GLCLE

Ersa Suspension Vertical with clear glass spheres
(Ø60xH.110 cm, nickel finish, 5 x E27, 15kg)



ERSAV110BR-GLIRI

Composition of 2 Ersa Suspension Vertical with iridescent glass spheres
(Ø60xH.110 cm, brass finish, 5 x E27, 15kg)



ERSAV130BRBUR-GLIRI

Ersa Suspension Vertical with iridescent glass spheres.
(Ø90xH.130 cm, brass burnished finish, 8 x E27, 25kg)



ERSAV130BRBUR-GLIRI

Ersa Suspension Vertical with iridescent glass spheres.
(Ø90xH.130 cm, brass burnished finish, 8 x E27, 25kg)



ERSAHL150N-GLCLE

Ersa Hanging Lamp Long with clear glass spheres
(L.155xW.45xH.35 cm, nickel finish, 5 x E27, 15kg)



ERSAHL150N-GLCLE

Ersa Hanging Lamp Long with clear glass spheres
(L.155xW.45xH.35 cm, nickel finish, 5 x E27, 15kg)



ERSA3BRBUR-GLBRO

Ersa Element with bronze translucent glass spheres,
(L 65cm, H 60cm, D 55cm, brass burnished finish, 3 x E27, 10kg)



ERSA3BRBUR-GLBRO

Ersa Element with bronze translucent glass spheres
(L 65cm, H 60cm, D 55cm, brass burnished finish, 3 x E27, 10kg)



ERSA2N-GLIRI

Ersa Element with iridescent glass spheres
(L 60cm, H 60cm, D 55cm, nickel finish, 2 x E27, 8kg)



COMPOSITION OF 3X ERSA2BR-GLIRI

Ersa Elements with iridescent glass spheres
(L 60cm, H 60cm, D 55cm, brass finish, 2 x E27, 8kg)



COMPOSITION OF 4X ERS1BLM-GLIRI

4 Ersa Elements Inline with iridescent glass sphere
(L 30cm, H 50cm, D 30cm, black matt finish, 1 x E27, 6kg)



ERS1BLM-GLIRI

Ersa Element with iridescent glass sphere
(L 30cm, H 50cm, D 30cm, black matt finish, 1 x E27, 6kg)



ERSACP80BRBUR-GLBRO

Ersa Ceiling Chandelier with bronze translucent glass spheres
(Ø80xH.65 cm, brass burnished finish, 5 x E27, 13kg)



ERSACP80BRBUR-GLBRO

Ersa Ceiling Chandelier with bronze translucent glass spheres
(Ø80xH.65 cm, brass burnished finish, 5 x E27, 13kg)



ERSAP60BR-GLBRO

Ersa Ceiling Lamp Round with bronze translucent glass spheres
(Ø60xH.25 cm, brass finish, 3 x E27, 10kg)



ERSAP60N-GLIRI

Ersa Ceiling Lamp Round with iridescent glass spheres
(Ø60xH.25 cm, nickel finish, 3 x E27, 10kg)



ERSAW30N-GLIRI

Ersa Wall Lamp with clear glass sphere
(W.30xH.45xD.29 cm, nickel finish, 1 x E27, 4kg)

ERSAHL150N-GLCLE

Ersa Hanging Lamp Long with clear glass spheres
(L.155xW.45xH.35 cm, nickel finish, 5 x E27, 15kg)



ERSAF200N-GLIRI

Ersa Floor Lamp with iridescent glass spheres
(Ø40xH.205cm, nickel finish, 3 x E27, 24kg)



ERSAF200BRBUR-GLBRO

Ersa Floor Lamp with bronze translucent glass spheres
(Ø40xH.205cm, brass burnished finish, 3 x E27, 24kg)

Eve Icicles

Design by William Brand

Combining the Eve with the time honoured tradition of hand-blown glass: the Eve Icicles has been created.

Eve Icicles can be customised to any dimension, allowing for a tailor-made lighting sculpture for your space.



CUSTOMISED EVECCGL160N

Eve Chandelier Conical Glass
(Ø60xH.160 cm, nickel finish, 14 x E14, 36 kg)



CUSTOMISED EVECCGL160N

Eve Chandelier Conical Glass
(Ø60xH.160 cm, nickel finish, 14 x E14, 36 kg)

EVEOC140N

Eve Chandelier Oval
(L.140xW.60xH.60 cm, nickel finish, 12 x E14, 16 kg)



CUSTOMISED EVECCGL300N

Eve Chandelier Conical Glass

(Ø150xH.300 cm, nickel finish, 52 x E14, 100 kg)



CUSTOMISED EVECCGL300N

Eve Chandelier Conical Glass

(Ø150xH.300 cm, nickel finish, 52 x E14, 100 kg)



CUSTOMISED EVEOCGL140RUST

Eve Chandelier Oval Glass

(L. 140cmxW. 60cmxH. 60cm, rusty finish 16xE14, 25kg.)



CUSTOMISED EVEOCGL140RUST

Eve Chandelier Oval Glass

(L. 140cmxW. 60cmxH. 60cm, rusty finish 16xE14, 25kg.)



CUSTOMISED EVEOCGL140RUST

Eve Chandelier Oval Glass

(L. 140cmxW. 60cmxH. 60cm, rusty finish 16xE14, 25kg.)

Flower Power Icicles

Design by William Brand

Our exquisite 'Flower Power' has been given an additional set of jewelry, with this splendid set of icicles.



SPFPI100BL

Customised Flower Power Icicles Chandelier Round
(Ø 100, H 70 cm, 8xE27, 25kg, black finish)



SPFPI100BL

Customised Flower Power Icicles Chandelier Round
(Ø 100, H 70 cm, 8xE27, 25kg, black finish)



CUSTOMISED FLOWER POWER

Customised Flower Power Icicles Chandelier for Residential Villa
(Ø180xH.400 cm, black finish with black glass icicles)

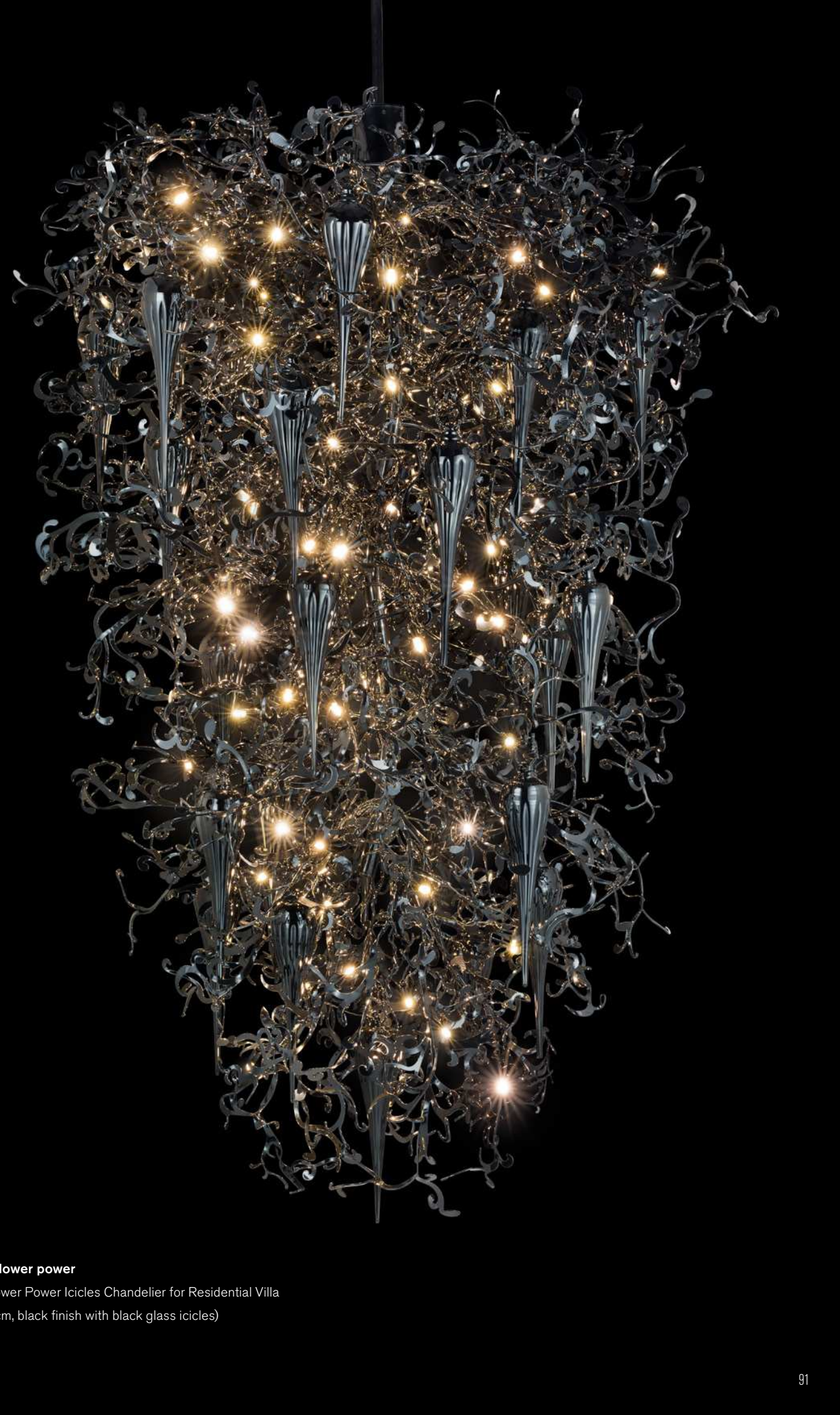

Customised Flower power

Customised Flower Power Icicles Chandelier for Residential Villa
(Ø180xH.400 cm, black finish with black glass icicles)

Orpheus

Design by William Brand

One of the most legendary poets and singers in Greek mythology is Orpheus. He sang so beautifully that he touched everyone and all around him. The King and Queen were moved to tears, but also the birds, trees and even the stones were hypnotized by his magical voice.

We have found several objects of desire amidst the nymphs and trees, and formed them into new lights. A semi-precious stone, a golden mineral and a delicate rose: all captured in a protective embrace of casted bronze.



Orpheus-Amethyst

This semi-precious stone, embraced through the millennia by ancient Greeks, Russian Tsars and English bishops is seen as a protector against dark magic, and a symbol for those in love.

ORC25BDP-AM

Orpheus-Amethyst Art Element

(Ø35xH.85 cm, cast bronze dark patina finish with amethyst, 1x GU10, 4kg)



Orpheus-Pyrite

An astonishing mineral, seemingly made by human hands but in fact found in nature, is called Pyrite.

Given its strong resemblance to gold, it was nicknamed by gold diggers as 'fool's gold'. The surfaces reflect the light in a fabulous way; creating a splendour of golden light.



ORC25BDP-PYR

Orpheus-Pyrite Art Element

(Ø35xH.85 cm, cast bronze dark patina finish with Pyrite, 1x GU10, 4kg)



Orpheus- Nymphenburg

The handcrafted rose is from Porzellan Manufaktur Nymphenburg, creating the finest porcelain for over 260 years. Crafted on the Nymphenburg palace grounds outside Munich, their handcrafted porcelain has been treasured by aristocracy and collectors from around the world



ORC25BDP-NYMR

Orpheus- Nymphenburg Art Element

(Ø35xH.85 cm, cast bronze dark patina finish Nymphenburg Rose,1x GU10, 4kg)



4xORC25BDP-AM

Composition of 4 Orpheus-Amethyst Art Elements Inline
(Ø35xH.85 cm, cast bronze dark patina finish, 1x GU10, 4kg)

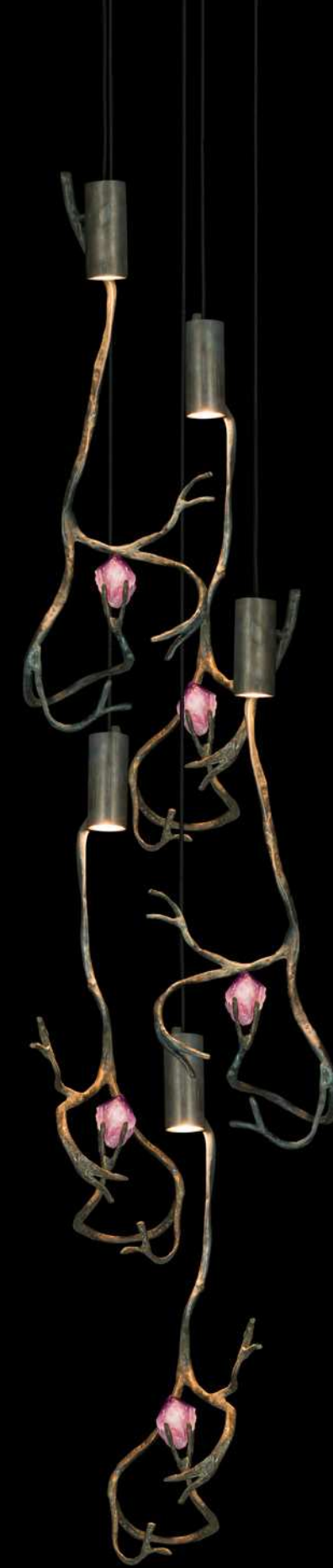

4xORC25BDP-AM

Composition of 4 Orpheus-Amethyst Art Elements Vertical
(Ø35xH.85 cm, cast bronze dark patina finish, 1x GU10, 4kg)



OR30-CANDBRBUR

Orpheus Element

(Ø30xH.57 cm, 1x E14, brass aged finish, 1x GU10 spot downlight, 3kg)



OR30-CANDBRBUR

Orpheus Element

(Ø30xH.57 cm, 1x E14, brass aged finish, 1x GU10 spot downlight, 3kg)

Fractal Cloud

Design by William Brand

Available in 55 cm and 70 cm, carrying 3 lights inside.

Finishes in stainless steel, brass,
brass burnished, brass grinded, black matt and white matt.



FRACHR55BRG

Fractal Cloud Hanging lamp

(Ø 55cm, H 60cm, 3 x E27, brass grinded finish, 13kg)



FRACHR55BR
Fractal Cloud Hanging lamp
(Ø 55cm, H 60cm, 3 x E27, brass finish, 13kg)



FRACHR55BLM
Fractal Cloud Hanging lamp
(Ø 55cm, H 60cm, 3 x E27, black matt finish, 13kg)

FRACHR55BRG
Fractal Cloud Hanging lamp
(Ø 55cm, H 60cm, 3 x E27, brass grinded finish, 13kg)



FRACHR55ST
Fractal Cloud Hanging lamp
(Ø 55cm, H 60cm, 3 x E27, stainless steel, 13kg)

Fractal

Design by William Brand

Our brains are set up to bring order in chaos, find logic in confusion and recognise patterns in the opaque. However, what to make of the puzzle of the exact yet endless repetition found at times around us?

Fractal is a natural phenomenon as well as a mathematical set that exhibits a repeating pattern.

The organised chaos of the reflecting elements of the Fractal dispenses the light beautifully in all directions.

The finishes are in stainless steel, brass grinded, black matt and white matt.



FRACC100BRG

Fractal Chandelier Round

(Ø 100cm, H 45cm, 12 x E14, brass grinded finish, 27 kg)



FRACC100BRG

Fractal Chandelier Round

(Ø 100cm, H 45cm, 12 x E14, brass grinded finish, 27 kg)



FRACC100ST
Fractal Chandelier Round
(Ø 100cm, H 45cm, 12 x E14, stainless steel, 27 kg)



FRACC80BLM
Fractal Chandelier Round
(Ø 80cm, H 35cm, 10 x E14, black matt finish, 19 kg)



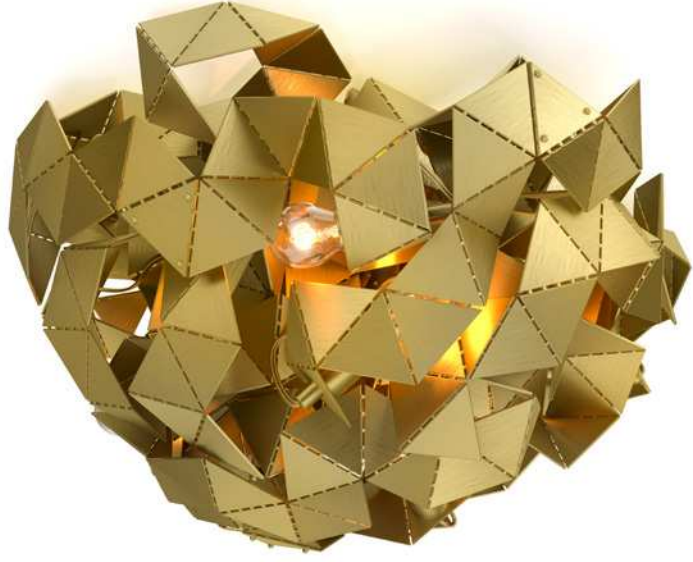

FRACP60BRG
Fractal Ceiling Lamp Round
(Ø60xH.30 cm, 8x E14, brass grinded finish, 15 kg)



FRACP80BRG
Fractal Ceiling Lamp Round
(Ø80xH.35 cm, 10x E14, brass grinded finish, 20 kg)



FRACP100BRG
Fractal Ceiling Lamp Round
(Ø100xH.35 cm, 10x E14, brass grinded finish, 25 kg)



downlight

downlight

downlight

FRACOC140BRG

Fractal Chandelier Oval

(L.140xW.55xH.60 cm, brass grinded finish, 3x GU10 spot downlight, 12x E14, 50 kg)



SPFRACTAL

Customised Fractal Chandelier Long

(L.200xW.50xH.50 cm, brass finish, 12 x E14, 55kg)

Edison's Tail

Design by William Brand

Unadorned yet full of energy, contemporary and elegant: Edison's Tail moves freely through space and reveals that bringing light and vitality can go hand in hand.

Introduced successfully by the inventor Thomas Edison, the light bulb is - more than in any other collection - an integral part of the overall design. The spirited and energetic shape of Edison's Tail is evocative of the initial burst of life when a seed opens and through the cracks the first green shoots appear.

To see this exact moment, is to see a wonder in the making. To capture this moment, is what Edison's Tail attempts.



ED1QN

Edison's Tail Element

(L 30cm, H 45cm, D 30cm, nickel finish, 1 x E27, 2,5kg)



ED2BLM

Edison's Tail Element

(L 45cm, H 50cm, D 40cm, black matt finish, 2 x E27, 5kg)



COMPOSITION OF 2X ED1OBR, 1X ED3BR, 2X ED5BR

Edison's Tail Elements in brass finish



ED3N

Edison's Tail Element

(L 45cm, H 50cm, D 40cm, nickel finish, 3 x E27, 8kg)



COMPOSITION OF 4X ED1OBRBUR, 2X ED1ZBRBUR, 1X ED5BRBUR
Edison's Tail Elements in brass burnished finish



SPED6BRBUR

Customised Edison's Tail Element

(L 140cm, H 75cm, W 70cm, brass burnished finish, 6 x E27, 13kg)

Shiro

Design by William Brand

By means of the deduction of every unnecessary layer of decoration, a calmness of mind appears allowing for a new collection to be born. The Shiro – Japanese for castle - is the result of a journey of deconstruction.

Stripped of all but the bare yet beautiful essentials, this new collection permits for a well composed equilibrium.

It allows serenity to triumph over chaos.



SHSR100BRBUR
Shiro Suspension Ring
(Ø 115cm, H 33cm, brass burnished finish, 18 x E14, 23kg)



SHSR100BRBUR
Shiro Suspension Ring
(Ø 115cm, H 33cm, brass burnished finish, 18 x E14, 23kg)



SPSHSR160BRBUR

Customised Shiro Suspension Ring

(Ø 175cm, H 33cm, brass burnished finish, 20 x E14, 50kg)



SPSHSR160BRBUR

Customised Shiro Suspension Ring

(Ø 175cm, H 33cm, brass burnished finish, 20 x E14, 50kg)



SHSV200BRBUR

Shiro Suspension Vertical

(Ø 22cm, H 210cm, brass burnished finish, 12 x E14, 22kg)



COMPOSITION OF 2XSHSV70BRBUR

Shiro Suspension Vertical

(Ø 22cm, H 80cm, brass burnished finish, 6 x E14, 8kg)



SHSH150BRBUR

Shiro Suspension Horizontal

(L 150cm, H 33cm, W 25cm, brass burnished finish, 3x MR11 spot downlight, 12Volt, 14 x E14, 18kg)



SHW34BRBUR

Shiro Wall Lamp

(W.12xH.34xD.9 cm, brass burnished finish, 1 x E14, 2kg)

Kelp Fortuna

Design by William Brand

Overwhelmed by the warm reception the Kelp collection received, William Brand was intrigued to experiment further and sought to add new elements.

The grand icicles, blown and pulled at the same time by our glassblowers, add a striking monumental facet to the frivolously shaped Kelp. To be able to create icicles of this quality and size demanded rigorous experimenting and exploration of new techniques. As the 16th century Florentine diplomat and poet Machiavelli wrote, 'It's better to be adventurous than cautious, as Fortuna is a woman'.



KEF90BR

Kelp Fortuna Element

(Ø 90cm, H 195cm, brass finish, 3 x E27, 35kg)



KEF90BR

Kelp Fortuna Element

(Ø 90cm, H 195cm, brass finish, 3 x E27, 35kg)



KEF90COP

Kelp Fortuna Element

(Ø 90cm, H 195cm, copper finish, 3 x E27, 35kg)

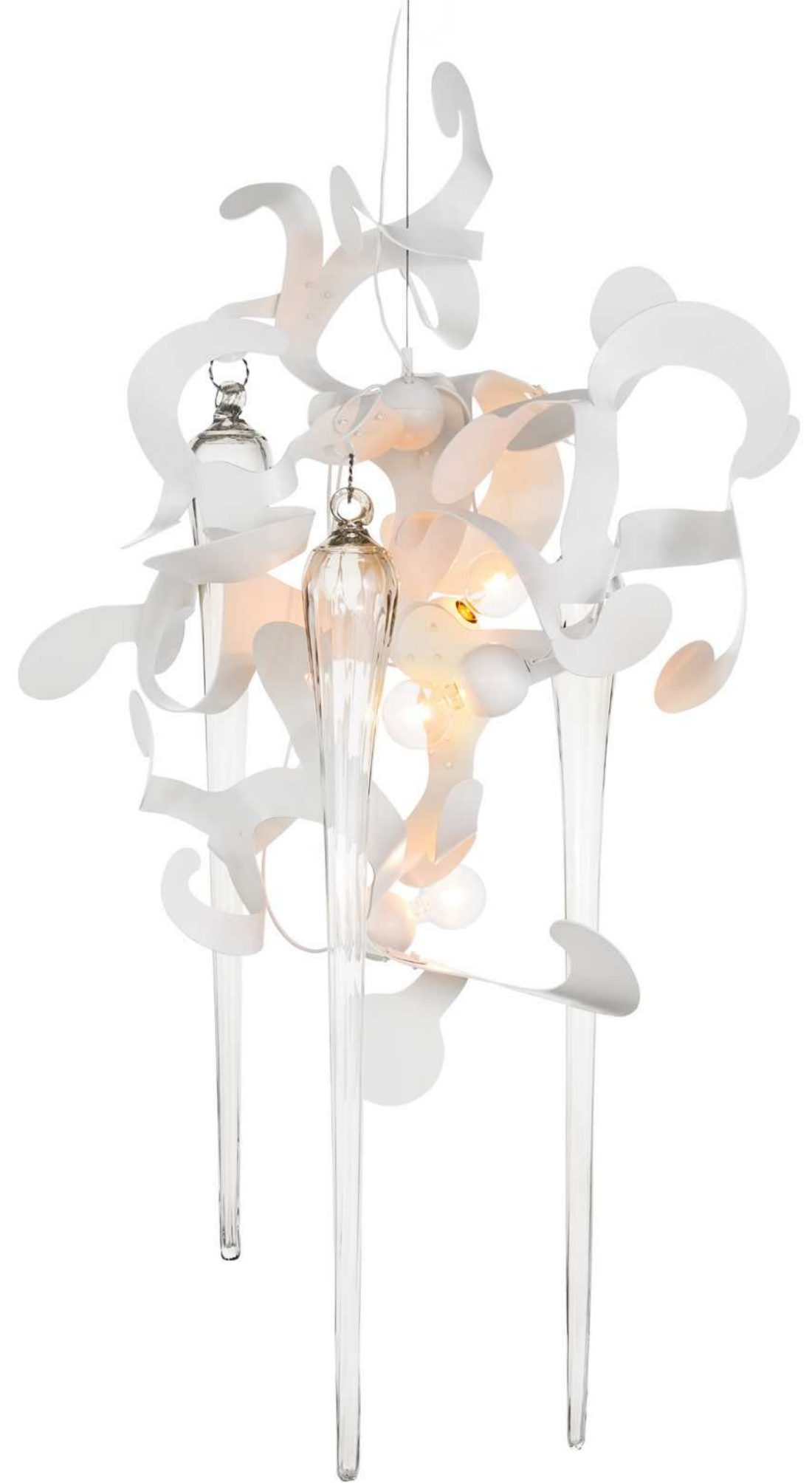

KEF90WM

Kelp Fortuna Element

(Ø 90cm, H 195cm, white matt finish, 3 x E27, 35kg)



SPKEF90ST

Customised Kelp Fortuna Element

(Ø 90cm, H 300cm, stainless steel, 6 x E27, 70kg)



SPKEF90ST

Customised Kelp Fortuna Element

(Ø 90cm, H 300cm, stainless steel, 6 x E27, 70kg)



KEF60BRBUR

Kelp Fortuna Element

(Ø 60cm, H 120cm, brass burnished finish, 3 x E27, 25kg)



KEF60BRBUR

Kelp Fortuna Element

(Ø 60cm, H 120cm, brass burnished finish, 3 x E27, 25kg)



KEF90BLM

Kelp Fortuna Element

(Ø 90cm, H 195cm, black matt finish, 3 x E27, 35kg)



KEF60BLM

Kelp Fortuna Element

(Ø 60cm, H 120cm, black matt finish, 3 x E27, 25kg)



KEF40ST

Kelp Fortuna Element

(Ø 40cm, H 105cm, stainless steel, 1 x E27, 14kg)



COMPOSITION OF 3X KEF40ST

Composition of 3 Kelp Fortuna 40 Elements

(Ø 40cm, H 105cm, stainless steel, 1 x E27, 14kg)

Kelp 100

Design by William Brand

Frivolous and light-hearted, spirited and energetic, the arched and curved Kelp in red copper reflects the light warmly, as in a crackling open fireplace.



100KELPCOP
Composition of 3 Kelp Element
(L 80 cm, W 100 cm, H 80 cm, 5 x E14, copper finish, 15 kg)



100KELPCOP
Kelp Element
(L 80 cm, W 100 cm, H 80 cm, 5 x E14, copper finish, 15 kg)



3X100KELPBR

Composition of 3 Kelp100 Elements
(L 150 cm, W 150 cm, H 150 cm, 10 x E14, brass finish, 25 kg)

100KELPBR

Composition of 3 Kelp Element
(L 80xW 100xH 80 cm, brass finish, 5 x E14, 15 kg)



100KELPBRA

Kelp Element
(L 80 cm, W 100 cm, H 80 cm, 5 x E14, brass aged finish, 15 kg)



William Brand

designer / owner

William Brand (Owner/Designer) graduated at the University of the Arts in Utrecht, The Netherlands as an architect and sculptor.

As an award-winning furniture designer he for many years designed buildings and interiors for fashion brands, including the headquarters of BRAND VAN EGMOND. His interior designs are always minimalist, in contrast to his lighting designs which have a powerful sculptural presence. He considers his lighting objects to be "the cherry on the cake". His way of working is quite specific. Immediately after defining the concept he starts working in the workshop like a sculptor; experimenting and crafting while having the object grow in his hands, often with unexpected results. Therefore the journey is just as exciting and important as the destination.





Architects and other co-creatives are invited to discover the endless possibilities of customising our lighting sculptures.

We hope to inspire you through the different colours and forms of various compositions, just as we enjoy being stimulated by your requests. William Brand's background in architecture gives him the insight to fully understand the demands and challenges of your work. Combined with his experience he is the perfect partner to translate your needs into handcrafted reality.

For our clients we not only customise to different dimensions, but also in different finishes: allowing for a truly personal lighting sculpture to be created.

The possibilities with our lighting sculptures are, in fact, limitless.

We would like to show some of the new possibilities.



Optional finishes

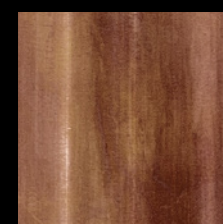

020

Copper Burnished finish

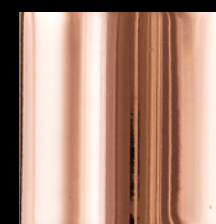

013

Copper finish

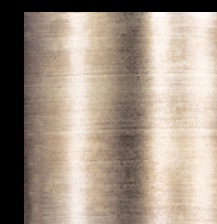

018

Nickel aged finish

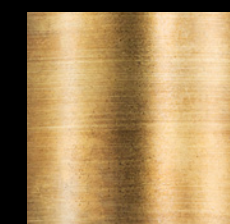

012

Brass aged finish



017

Brass grinded finish



010

Brass finish



002

Black matt finish



004

White matt finish



001

Nickel finish

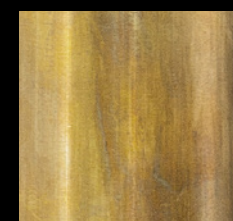

019

Brass burnished finish

Technical information

Collection Louise 2018

Lanterns

Art.nr.	Finish
GLLOBRO22	Louise, Glass Bronze Ø22cm
GLLOGREY22	Louise, Glass Grey Ø22cm
GLLOIRI22	Louise, Glass Iridescent Ø22cm
GLLOSAT22	Louise, Glass Clear Satin Ø22cm

Hanging Lamp

Art.nr.	Dimensions	Light bulb	Weight	Finish
LO1BLM	Ø22xH.36 cm	1x E27	2,4 kg	black matt finish
LO1N	Ø22xH.36 cm	1x E27	2,4 kg	nickel finish
LO1BR	Ø22xH.36 cm	1x E27	2,4 kg	brass finish
LO1BRG	Ø22xH.36 cm	1x E27	2,4 kg	brass grinded finish
LO1BRBUR	Ø22xH.36 cm	1x E27	2,4 kg	brass burnished finish
LO1NA	Ø22xH.36 cm	1x E27	2,4 kg	nickel aged finish
LO1COPBUR	Ø22xH.36 cm	1x E27	2,4 kg	copper burnished finish
LO3BLM	Ø60xH.70 cm	3x E27	11,5 kg	black matt finish
LO3N	Ø60xH.70 cm	3x E27	11,5 kg	nickel finish
LO3BR	Ø60xH.70 cm	3x E27	11,5 kg	brass finish
LO3BRG	Ø60xH.70 cm	3x E27	11,5 kg	brass grinded finish
LO3BRBUR	Ø60xH.70 cm	3x E27	11,5 kg	brass burnished finish
LO3NA	Ø60xH.70 cm	3x E27	11,5 kg	nickel aged finish
LO3COPBUR	Ø60xH.70 cm	3x E27	11,5 kg	copper burnished finish
LO4BLM	Ø60xH.78 cm	4x E27	14,0 kg	black matt finish
LO4N	Ø60xH.78 cm	4x E31	14,0 kg	nickel finish
LO4BR	Ø60xH.78 cm	4x E28	14,0 kg	brass finish
LO4BRG	Ø60xH.78 cm	4x E29	14,0 kg	brass grinded finish
LO4BRBUR	Ø60xH.78 cm	4x E27	14,0 kg	brass burnished finish
LO4NA	Ø60xH.78 cm	4x E32	14,0 kg	nickel aged finish
LO4COPBUR	Ø60xH.78 cm	4x E30	14,0 kg	copper burnished finish
LO5BLM	Ø60xH.105 cm	5x E27	18,0 kg	black matt finish
LO5N	Ø60xH.105 cm	5x E27	18,0 kg	nickel finish
LO5BR	Ø60xH.105 cm	5x E27	18,0 kg	brass finish
LO5BRG	Ø60xH.105 cm	5x E27	18,0 kg	brass grinded finish
LO5BRBUR	Ø60xH.105 cm	5x E27	18,0 kg	brass burnished finish
LO5NA	Ø60xH.105 cm	5x E27	18,0 kg	nickel aged finish
LO5COPBUR	Ø60xH.105 cm	5x E27	18,0 kg	copper burnished finish
LO8BLM	Ø60xH.205 cm	8x E27	28,0 kg	black matt finish
LO8N	Ø60xH.205 cm	8x E27	28,0 kg	nickel finish
LO8BR	Ø60xH.205 cm	8x E27	28,0 kg	brass finish
LO8BRG	Ø60xH.205 cm	8x E27	28,0 kg	brass grinded finish
LO8BRBUR	Ø60xH.205 cm	8x E27	28,0 kg	brass burnished finish
LO8NA	Ø60xH.205 cm	8x E27	28,0 kg	nickel aged finish
LO8COPBUR	Ø60xH.205 cm	8x E27	28,0 kg	copper burnished finish

The lanterns are available in 4 different types of glass: bronze, clear satin, grey and iridescent.

Technical information

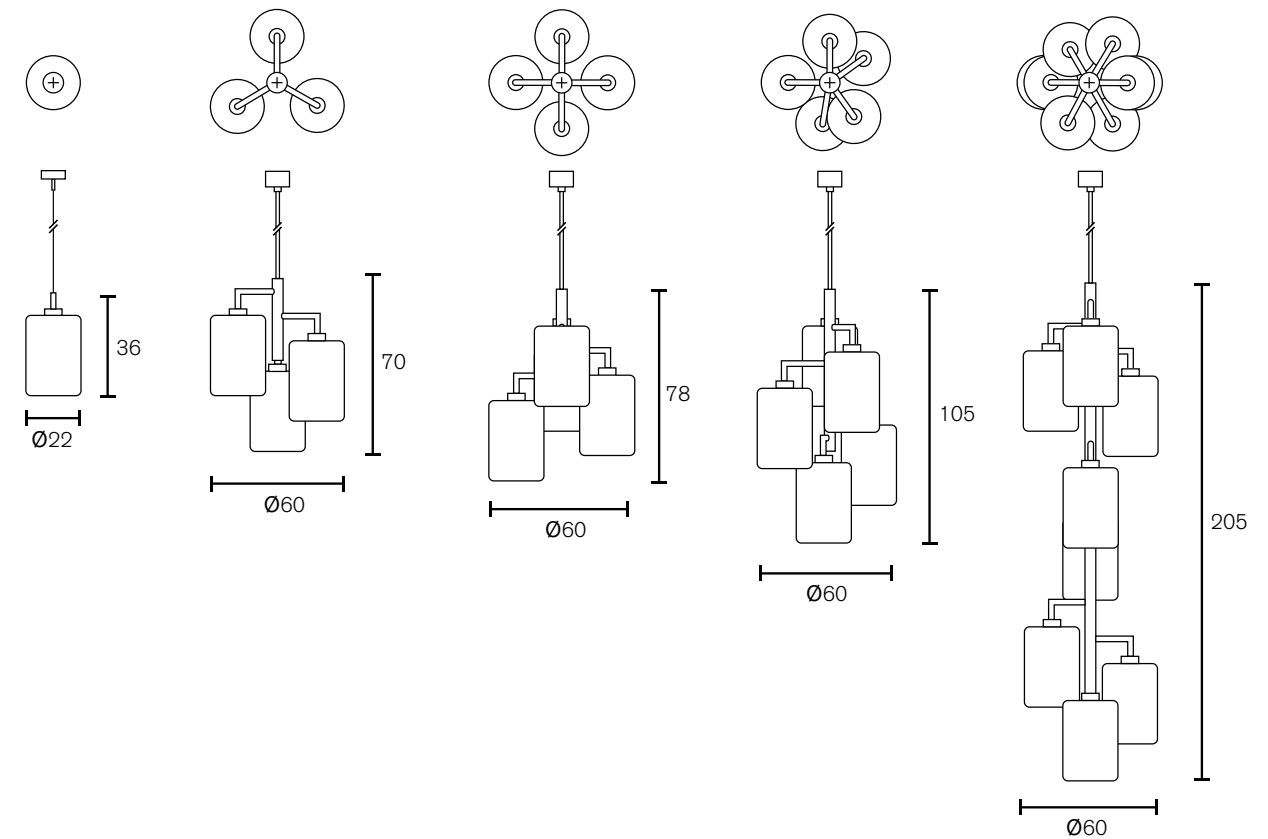

The lanterns are available in 4 different types of glass: bronze, clear satin, grey and iridescent.

Technical information

Chandelier Round

Art.nr.	Dimensions	Light bulb	Weight	Finish
LOC60BLM	Ø60xH.53 cm	5x E27	15,0 kg	black matt finish
LOC60N	Ø60xH.53 cm	5x E27	15,0 kg	nickel finish
LOC60BR	Ø60xH.53 cm	5x E27	15,0 kg	brass finish
LOC60BRG	Ø60xH.53 cm	5x E27	15,0 kg	brass grinded finish
LOC60BRBUR	Ø60xH.53 cm	5x E27	15,0 kg	brass burnished finish
LOC60NA	Ø60xH.53 cm	5x E27	15,0 kg	nickel aged finish
LOC60COPBUR	Ø60xH.53 cm	5x E27	15,0 kg	copper burnished finish
LOC80BLM	Ø82xH.53 cm	7x E27	25,0 kg	black matt finish
LOC80N	Ø82xH.53 cm	7x E27	25,0 kg	nickel finish
LOC80BR	Ø82xH.53 cm	7x E27	25,0 kg	brass finish
LOC80BRG	Ø82xH.53 cm	7x E27	25,0 kg	brass grinded finish
LOC80BRBUR	Ø82xH.53 cm	7x E27	25,0 kg	brass burnished finish
LOC80NA	Ø82xH.53 cm	7x E27	25,0 kg	nickel aged finish
LOC80COPBUR	Ø82xH.53 cm	7x E27	25,0 kg	copper burnished finish
LOC100BLM	Ø100xH.60 cm	8x E27	30,0 kg	black matt finish
LOC100N	Ø100xH.60 cm	8x E27	30,0 kg	nickel finish
LOC100BR	Ø100xH.60 cm	8x E27	30,0 kg	brass finish
LOC100BRG	Ø100xH.60 cm	8x E27	30,0 kg	brass grinded finish
LOC100BRBUR	Ø100xH.60 cm	8x E27	30,0 kg	brass burnished finish
LOC100NA	Ø100xH.60 cm	8x E27	30,0 kg	nickel aged finish
LOC100COPBUR	Ø100xH.60 cm	8x E27	30,0 kg	copper burnished finish
LOC120BLM	Ø120xH.65 cm	12x E27	40,0 kg	black matt finish
LOC120N	Ø120xH.65 cm	12x E27	40,0 kg	nickel finish
LOC120BR	Ø120xH.65 cm	12x E27	40,0 kg	brass finish
LOC120BRG	Ø120xH.65 cm	12x E27	40,0 kg	brass grinded finish
LOC120BRBUR	Ø120xH.65 cm	12x E27	40,0 kg	brass burnished finish
LOC120NA	Ø120xH.65 cm	12x E27	40,0 kg	nickel aged finish
LOC120COPBUR	Ø120xH.65 cm	12x E27	40,0 kg	copper burnished finish

The lanterns are available in 4 different types of glass: bronze, clear satin, grey and iridescent.

Technical information

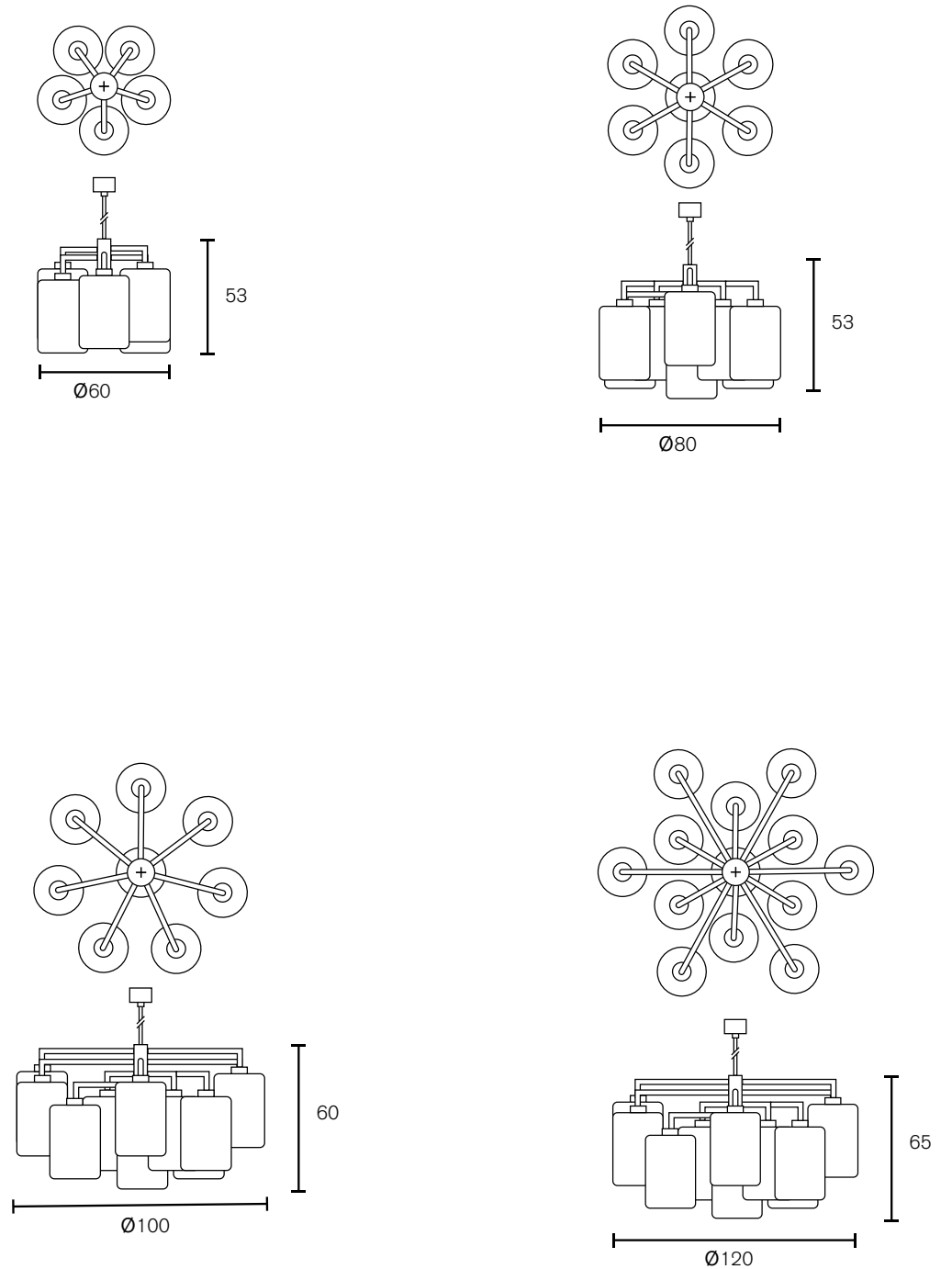

The lanterns are available in 4 different types of glass: bronze, clear satin, grey and iridescent.

Technical information

Hanging Lamp Long

Art.nr.	Dimensions	Light bulb	Weight	Finish
LOHL120BLM	L.120xW.55xH.62 cm	8x E27	28,0 kg	black matt finish
LOHL120N	L.120xW.55xH.62 cm	8x E27	28,0 kg	nickel finish
LOHL120BR	L.120xW.55xH.62 cm	8x E27	28,0 kg	brass finish
LOHL120BRG	L.120xW.55xH.62 cm	8x E27	28,0 kg	brass grinded finish
LOHL120BRBUR	L.120xW.55xH.62 cm	8x E27	28,0 kg	brass burnished finish
LOHL120NA	L.120xW.55xH.62 cm	8x E27	28,0 kg	nickel aged finish
LOHL120COPBUR	L.120xW.55xH.62 cm	8x E27	28,0 kg	copper burnished finish
LOHL140BLM	L.140xW.55xH.62 cm	10x E27	32,0 kg	black matt finish
LOHL140N	L.140xW.55xH.62 cm	10x E27	32,0 kg	nickel finish
LOHL140BR	L.140xW.55xH.62 cm	10x E27	32,0 kg	brass finish
LOHL140BRG	L.140xW.55xH.62 cm	10x E27	32,0 kg	brass grinded finish
LOHL140BRBUR	L.140xW.55xH.62 cm	10x E27	32,0 kg	brass burnished finish
LOHL140NA	L.140xW.55xH.62 cm	10x E27	32,0 kg	nickel aged finish
LOHL140COPBUR	L.140xW.55xH.62 cm	10x E27	32,0 kg	copper burnished finish
LOHL160BLM	L.160xW.55xH.62 cm	10x E27	35,0 kg	black matt finish
LOHL160N	L.160xW.55xH.62 cm	10x E27	35,0 kg	nickel finish
LOHL160BR	L.160xW.55xH.62 cm	10x E27	35,0 kg	brass finish
LOHL160BRG	L.160xW.55xH.62 cm	10x E27	35,0 kg	brass grinded finish
LOHL160BRBUR	L.160xW.55xH.62 cm	10x E27	35,0 kg	brass burnished finish
LOHL160NA	L.160xW.55xH.62 cm	10x E27	35,0 kg	nickel aged finish
LOHL160COPBUR	L.160xW.55xH.62 cm	10x E27	35,0 kg	copper burnished finish
LOHL180BLM	L.180xW.55xH.62 cm	12x E27	42,0 kg	black matt finish
LOHL180N	L.180xW.55xH.62 cm	12x E27	42,0 kg	nickel finish
LOHL180BR	L.180xW.55xH.62 cm	12x E27	42,0 kg	brass finish
LOHL180BRG	L.180xW.55xH.62 cm	12x E27	42,0 kg	brass grinded finish
LOHL180BRBUR	L.180xW.55xH.62 cm	12x E27	42,0 kg	brass burnished finish
LOHL180NA	L.180xW.55xH.62 cm	12x E27	42,0 kg	nickel aged finish
LOHL180COPBUR	L.180xW.55xH.62 cm	12x E27	42,0 kg	copper burnished finish

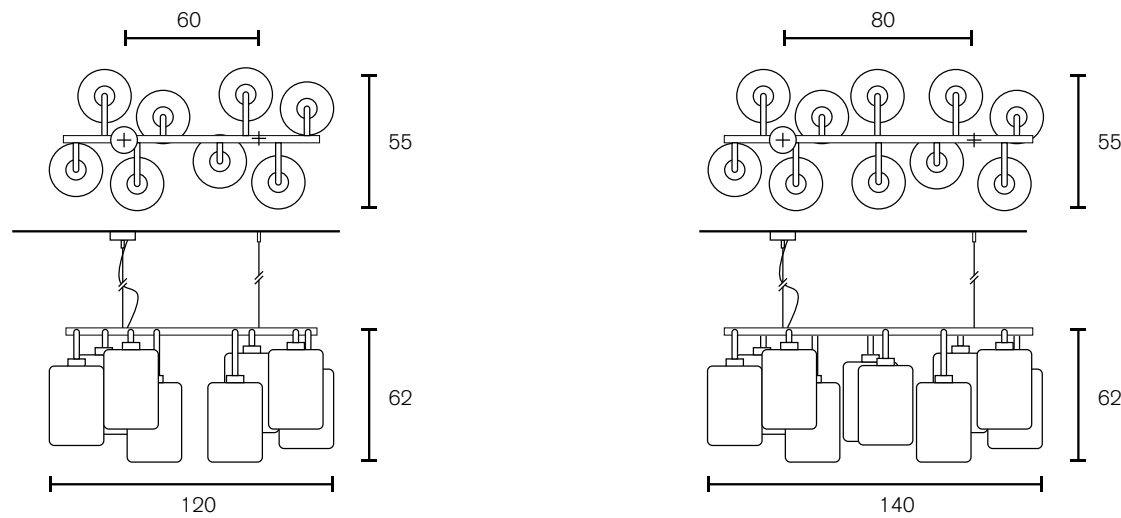

The lanterns are available in 4 different types of glass: bronze, clear satin, grey and iridescent.

Technical information

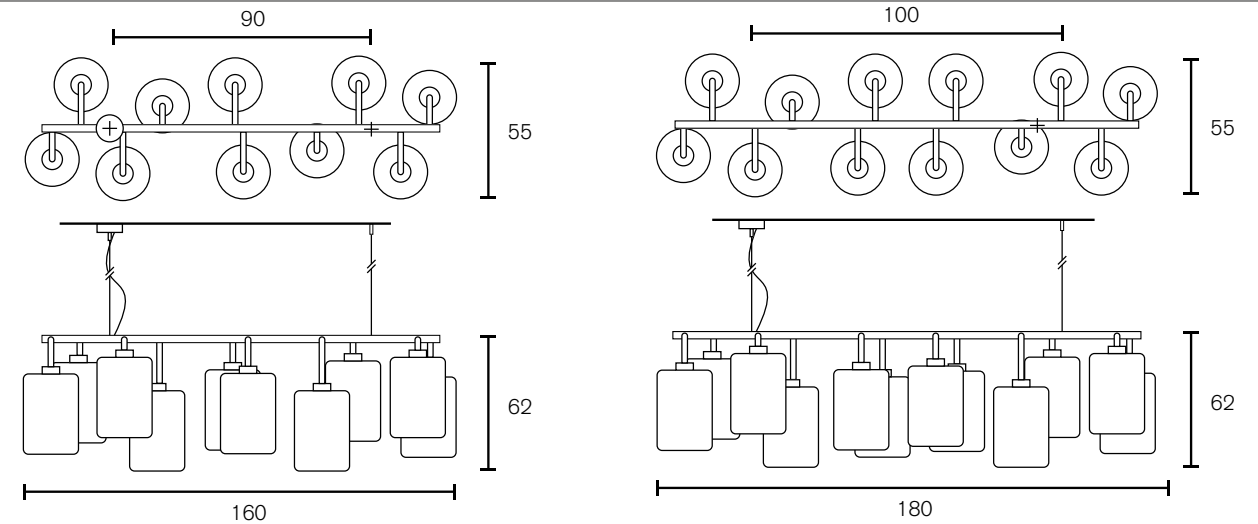

Ceiling Lamp Round

Art.nr.	Dimensions	Light bulb	Weight	Finish
LOP60BLM	Ø60xH.50 cm	3x E27	10,0 kg	black matt finish
LOP60N	Ø60xH.50 cm	3x E27	10,0 kg	nickel finish
LOP60BR	Ø60xH.50 cm	3x E27	10,0 kg	brass finish
LOP60BRG	Ø60xH.50 cm	3x E27	10,0 kg	brass grinded finish
LOP60BRBUR	Ø60xH.50 cm	3x E27	10,0 kg	brass burnished finish
LOP60NA	Ø60xH.50 cm	3x E27	10,0 kg	nickel aged finish
LOP60COPBUR	Ø60xH.50 cm	3x E27	10,0 kg	copper burnished finish
LOP80BLM	Ø80xH.50 cm	4x E27	15,0 kg	black matt finish
LOP80N	Ø80xH.50 cm	4x E27	15,0 kg	nickel finish
LOP80BR	Ø80xH.50 cm	4x E27	15,0 kg	brass finish
LOP80BRG	Ø80xH.50 cm	4x E27	15,0 kg	brass grinded finish
LOP80BRBUR	Ø80xH.50 cm	4x E27	15,0 kg	brass burnished finish
LOP80NA	Ø80xH.50 cm	4x E27	15,0 kg	nickel aged finish
LOP80COPBUR	Ø80xH.50 cm	4x E27	15,0 kg	copper burnished finish
LOP100BLM	Ø100xH.55 cm	5x E27	20,0 kg	black matt finish
LOP100N	Ø100xH.55 cm	5x E27	20,0 kg	nickel finish
LOP100BR	Ø100xH.55 cm	5x E27	20,0 kg	brass finish
LOP100BRG	Ø100xH.55 cm	5x E27	20,0 kg	brass grinded finish
LOP100BRBUR	Ø100xH.55 cm	5x E27	20,0 kg	brass burnished finish
LOP100NA	Ø100xH.55 cm	5x E27	20,0 kg	nickel aged finish
LOP100COPBUR	Ø100xH.55 cm	5x E27	20,0 kg	copper burnished finish

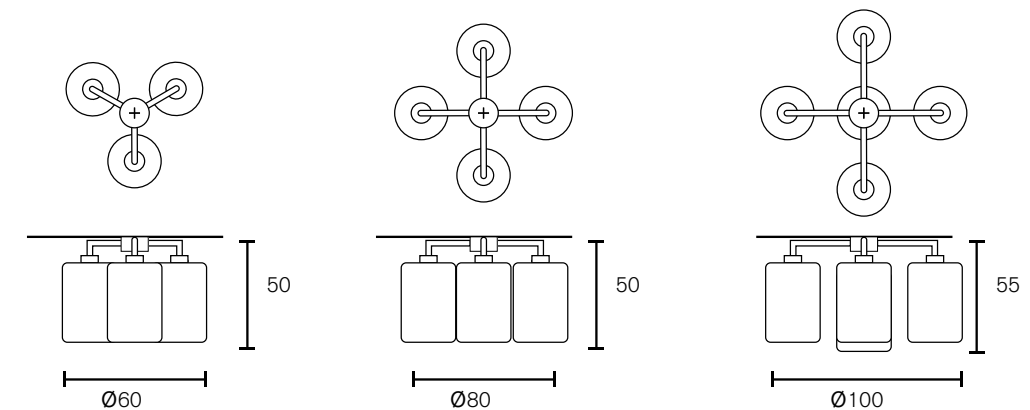

The lanterns are available in 4 different types of glass: bronze, clear satin, grey and iridescent.

Technical information

Floor Lamp

Art.nr.	Dimensions	Light bulb	Weight	Finish
LOF180BLM	Ø30xH.182 cm	1x E27	11,0 kg	black matt finish
LOF180N	Ø30xH.182 cm	1x E27	11,0 kg	nickel finish
LOF180BR	Ø30xH.182 cm	1x E27	11,0 kg	brass finish
LOF180BRG	Ø30xH.182 cm	1x E27	11,0 kg	brass grinded finish
LOF180BRBUR	Ø30xH.182 cm	1x E27	11,0 kg	brass burnished finish
LOF180NA	Ø30xH.182 cm	1x E27	11,0 kg	nickel aged finish
LOF180COPBUR	Ø30xH.182 cm	1x E27	11,0 kg	copper burnished finish
LOF200BLM	Ø50xH.202 cm	3x E27	16,0 kg	black matt finish
LOF200N	Ø50xH.202 cm	3x E27	16,0 kg	nickel finish
LOF200BR	Ø50xH.202 cm	3x E27	16,0 kg	brass finish
LOF200BRG	Ø50xH.202 cm	3x E27	16,0 kg	brass grinded finish
LOF200BRBUR	Ø50xH.202 cm	3x E27	16,0 kg	brass burnished finish
LOF200NA	Ø50xH.202 cm	3x E27	16,0 kg	nickel aged finish
LOF200COPBUR	Ø50xH.202 cm	3x E27	16,0 kg	copper burnished finish

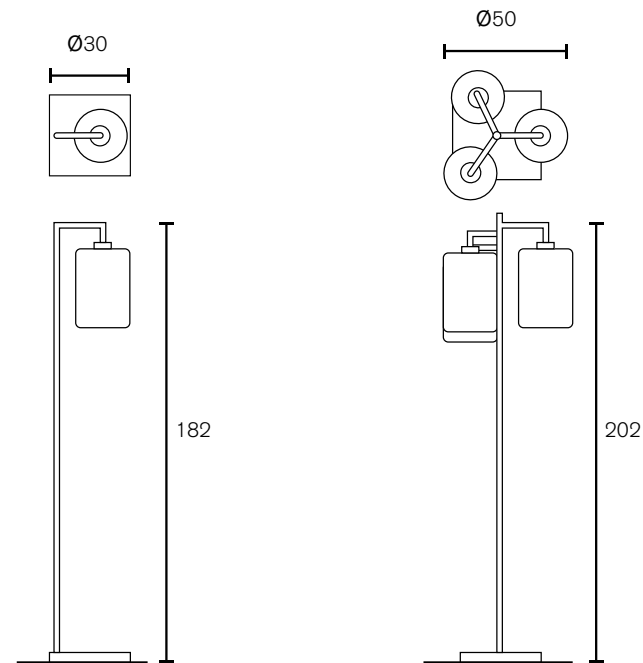

The lanterns are available in 4 different types of glass: bronze, clear satin, grey and iridescent.

Technical information

Table Lamp

Art.nr.	Dimensions	Light bulb	Weight	Finish
LOT75BLM	L.35xW.22xH.76 cm	1x E27	8,0 kg	black matt finish
LOT75N	L.35xW.22xH.76 cm	1x E27	8,0 kg	nickel finish
LOT75BR	L.35xW.22xH.76 cm	1x E27	8,0 kg	brass finish
LOT75BRG	L.35xW.22xH.76 cm	1x E27	8,0 kg	brass grinded finish
LOT75BRBUR	L.35xW.22xH.76 cm	1x E27	8,0 kg	brass burnished finish
LOT75NA	L.35xW.22xH.76 cm	1x E27	8,0 kg	nickel aged finish
LOT75COPBUR	L.35xW.22xH.76 cm	1x E27	8,0 kg	copper burnished finish

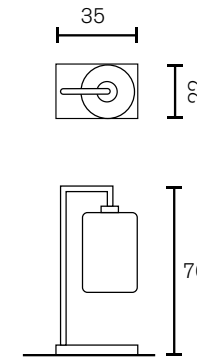

Wall Lamp

Art.nr.	Dimensions	Light bulb	Weight	Finish
LOW60BLM	L.22xW.30xH.58 cm	1x E27	4,0 kg	black matt finish
LOW60N	L.22xW.30xH.58 cm	1x E27	4,0 kg	nickel finish
LOW60BR	L.22xW.30xH.58 cm	1x E27	4,0 kg	brass finish
LOW60BRG	L.22xW.30xH.58 cm	1x E27	4,0 kg	brass grinded finish
LOW60BRBUR	L.22xW.30xH.58 cm	1x E27	4,0 kg	brass burnished finish
LOW60NA	L.22xW.30xH.58 cm	1x E27	4,0 kg	nickel aged finish
LOW60COPBUR	L.22xW.30xH.58 cm	1x E27	4,0 kg	copper burnished finish

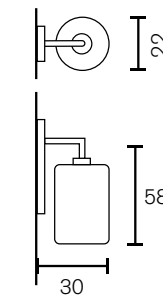

The lanterns are available in 4 different types of glass: bronze, clear satin, grey and iridescent.

Technical information

Collection Ersa 2018

Chandelier

Art.nr.	Dimensions	Light bulb	Weight	Finish
ERSA4BLM-GLIRI	L.80xW.55xH.50 cm	4x E27	11.0 kg	black matt finish, glass sphere iridescent
ERSA4B-GLIRI	L.80xW.55xH.50 cm	4x E27	11.0 kg	bronze finish, glass sphere iridescent
ERSA4N-GLIRI	L.80xW.55xH.50 cm	4x E27	11.0 kg	nickel finish, glass sphere iridescent
ERSA4BR-GLIRI	L.80xW.55xH.50 cm	4x E27	11.0 kg	brass finish, glass sphere iridescent
ERSA4BRA-GLIRI	L.80xW.55xH.50 cm	4x E27	11.0 kg	brass aged finish, glass sphere iridescent
ERSA4BRBUR-GLIRI	L.80xW.55xH.50 cm	4x E27	11.0 kg	brass burnished finish, glass sphere iridescent
ERSA4COPBUR-GLIRI	L.80xW.55xH.50 cm	4x E27	11.0 kg	copper burnished finish, glass sphere iridescent
ERSAC80BLM-GLIRI	Ø80xH.65 cm	5x E27	15.0 kg	black matt finish, glass sphere iridescent
ERSAC80B-GLIRI	Ø80xH.65 cm	5x E27	15.0 kg	bronze finish, glass sphere iridescent
ERSAC80N-GLIRI	Ø80xH.65 cm	5x E27	15.0 kg	nickel finish, glass sphere iridescent
ERSAC80BR-GLIRI	Ø80xH.65 cm	5x E27	15.0 kg	brass finish, glass sphere iridescent
ERSAC80BRA-GLIRI	Ø80xH.65 cm	5x E27 <td 15.0 kg	brass aged finish, glass sphere iridescent	
ERSAC80BRBUR-GLIRI	Ø80xH.65 cm	5x E27	15.0 kg	brass burnished finish, glass sphere iridescent
ERSAC80COPBUR-GLIRI	Ø80xH.65 cm	5x E27	15.0 kg	copper burnished finish, glass sphere iridescent
ERSAC100BLM-GLIRI	Ø110xH.75 cm	7x E27	23.0 kg	black matt finish, glass sphere iridescent
ERSAC100B-GLIRI	Ø110xH.75 cm	7x E27	23.0 kg	bronze finish, glass sphere iridescent
ERSAC100N-GLIRI	Ø110xH.75 cm	7x E27	23.0 kg	nickel finish, glass sphere iridescent
ERSAC100BR-GLIRI	Ø110xH.75 cm	7x E27	23.0 kg	brass finish, glass sphere iridescent
ERSAC100BRA-GLIRI	Ø110xH.75 cm	7x E27	23.0 kg	brass aged finish, glass sphere iridescent
ERSAC100BRBUR-GLIRI	Ø110xH.75 cm	7x E27	23.0 kg	brass burnished finish, glass sphere iridescent
ERSAC100COPBUR-GLIRI	Ø110xH.75 cm	7x E27	23.0 kg	copper burnished finish, glass sphere iridescent
ERSAC120BLM-GLIRI	Ø120xH.70 cm	7x E27	32.0 kg	black matt finish, glass sphere iridescent
ERSAC120B-GLIRI	Ø120xH.70 cm	7x E27	32.0 kg	bronze finish, glass sphere iridescent
ERSAC120N-GLIRI	Ø120xH.70 cm	7x E27	32.0 kg	nickel finish, glass sphere iridescent
ERSAC120BR-GLIRI	Ø120xH.70 cm	7x E27	32.0 kg	brass finish, glass sphere iridescent
ERSAC120BRBUR-GLIRI	Ø120xH.70 cm	7x E27	32.0 kg	brass burnished finish, glass sphere iridescent
ERSAC120NA-GLIRI	Ø120xH.70 cm	7x E27	32.0 kg	nickel aged finish, glass sphere iridescent
ERSAC120COPBUR-GLIRI	Ø120xH.70 cm	7x E27	32.0 kg	copper burnished finish, glass sphere iridescent
ERSAC140BLM-GLIRI	Ø140xH.80 cm	8x E27	40.0 kg	black matt finish, glass sphere iridescent
ERSAC140B-GLIRI	Ø140xH.80 cm	8x E27	40.0 kg	bronze finish, glass sphere iridescent
ERSAC140N-GLIRI	Ø140xH.80 cm	8x E27	40.0 kg	nickel finish, glass sphere iridescent
ERSAC140BR-GLIRI	Ø140xH.80 cm	8x E27	40.0 kg	brass finish, glass sphere iridescent
ERSAC140BRBUR-GLIRI	Ø140xH.80 cm	8x E27	40.0 kg	brass burnished finish, glass sphere iridescent
ERSAC140NA-GLIRI	Ø140xH.80 cm	8x E27	40.0 kg	nickel aged finish, glass sphere iridescent
ERSAC140COPBUR-GLIRI	Ø140xH.80 cm	8x E27	40.0 kg	copper burnished finish, glass sphere iridescent

Standard the ERSA will be delivered with iridescent glass spheres. Other options are bronze translucent or clear glass spheres.

Technical information

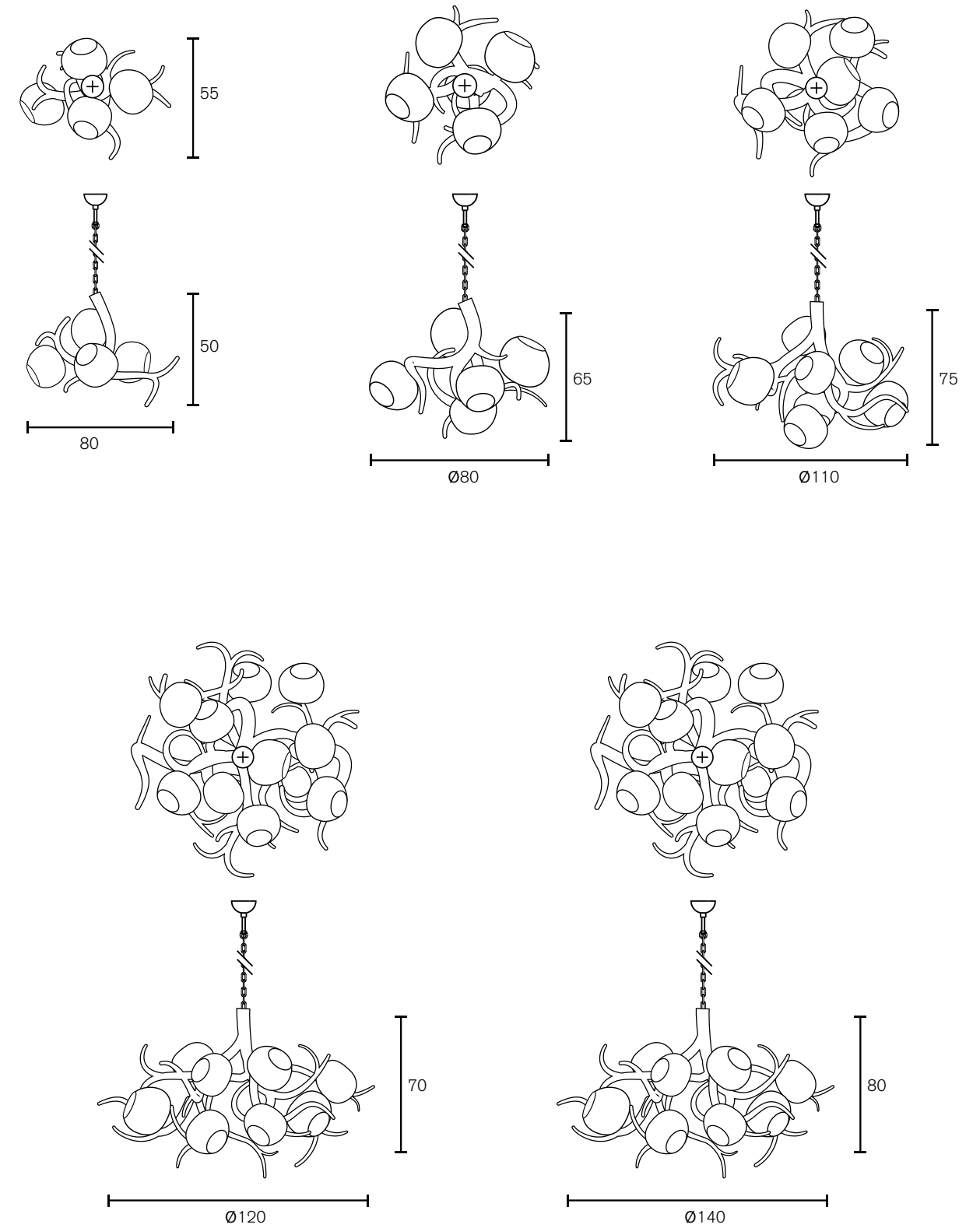

Standard the ERSA will be delivered with iridescent glass spheres. Other options are bronze translucent or clear glass spheres.

Technical information

Chandelier Conical

Art.nr.	Dimensions	Light bulb	Weight	Finish
ERSACC90BLM-GLIRI	Ø90xH.120 cm	9x E27	35,0 kg	black matt finish, glass sphere iridescent
ERSACC90B-GLIRI	Ø90xH.120 cm	9x E27	35,0 kg	bronze finish, glass sphere iridescent
ERSACC90N-GLIRI	Ø90xH.120 cm	9x E27	35,0 kg	nickel finish, glass sphere iridescent
ERSACC90BR-GLIRI	Ø90xH.120 cm	9x E27	35,0 kg	brass finish, glass sphere iridescent
ERSACC90BRBUR-GLIRI	Ø90xH.120 cm	9x E27	35,0 kg	brass burnished finish, glass sphere iridescent
ERSACC90NA-GLIRI	Ø90xH.120 cm	9x E27	35,0 kg	nickel aged finish, glass sphere iridescent
ERSACC90COPBUR-GLIRI	Ø90xH.120 cm	9x E27	35,0 kg	copper burnished finish, glass sphere iridescent
ERSACC110BLM-GLIRI	Ø110xH.130 cm	9x E27	45,0 kg	black matt finish, glass sphere iridescent
ERSACC110B-GLIRI	Ø110xH.130 cm	9x E27	45,0 kg	bronze finish, glass sphere iridescent
ERSACC110N-GLIRI	Ø110xH.130 cm	9x E27	45,0 kg	nickel finish, glass sphere iridescent
ERSACC110BR-GLIRI	Ø110xH.130 cm	9x E27	45,0 kg	brass finish, glass sphere iridescent
ERSACC110BRBUR-GLIRI	Ø110xH.130 cm	9x E27	45,0 kg	brass burnished finish, glass sphere iridescent
ERSACC110NA-GLIRI	Ø110xH.130 cm	9x E27	45,0 kg	nickel aged finish, glass sphere iridescent
ERSACC110COPBUR-GLIRI	Ø110xH.130 cm	9x E27	45,0 kg	copper burnished finish, glass sphere iridescent
ERSACC130BLM-GLIRI	Ø120xH.140 cm	11x E27	55,0 kg	black matt finish, glass sphere iridescent
ERSACC130B-GLIRI	Ø120xH.140 cm	11x E27	55,0 kg	bronze finish, glass sphere iridescent
ERSACC130N-GLIRI	Ø120xH.140 cm	11x E27	55,0 kg	nickel finish, glass sphere iridescent
ERSACC130BR-GLIRI	Ø120xH.140 cm	11x E27	55,0 kg	brass finish, glass sphere iridescent
ERSACC130BRBUR-GLIRI	Ø120xH.140 cm	11x E27	55,0 kg	brass burnished finish, glass sphere iridescent
ERSACC130NA-GLIRI	Ø120xH.140 cm	11x E27	55,0 kg	nickel aged finish, glass sphere iridescent
ERSACC130COPBUR-GLIRI	Ø120xH.140 cm	11x E27	55,0 kg	copper burnished finish, glass sphere iridescent

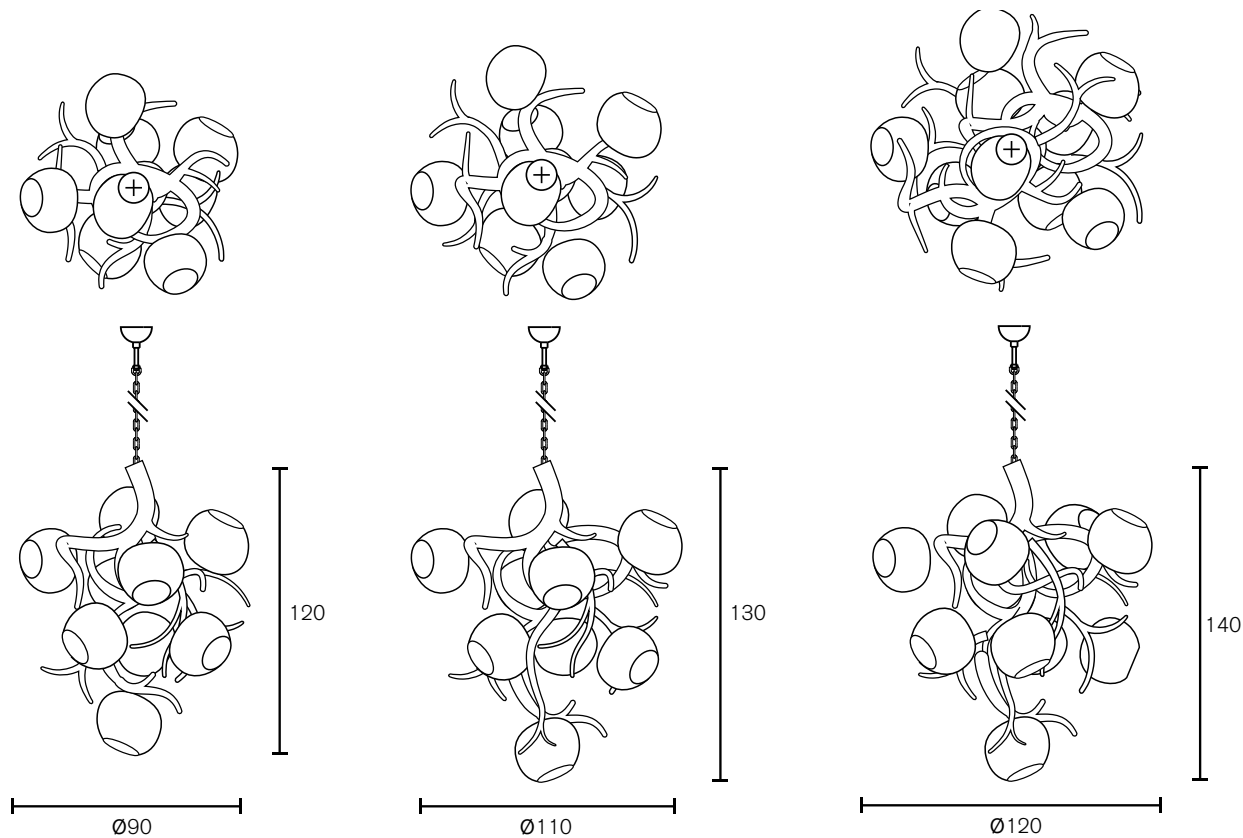

Standard the ERSA will be delivered with iridescent glass spheres. Other options are bronze translucent or clear glass spheres.

Technical information

Element

Art.nr.	Dimensions	Light bulb	Weight	Finish
ERSA1BLM-GLIRI	L.30xH.50x D.30 cm	1x E27	6,0 kg	black matt finish, glass sphere iridescent
ERSA1B-GLIRI	L.30xH.50x D.30 cm	1x E27	6,0 kg	bronze finish, glass sphere iridescent
ERSA1N-GLIRI	L.30xH.50x D.30 cm	1x E27	6,0 kg	nickel finish, glass sphere iridescent
ERSA1BR-GLIRI	L.30xH.50x D.30 cm	1x E27	6,0 kg	brass finish, glass sphere iridescent
ERSA1BRA-GLIRI	L.30xH.50x D.30 cm	1x E27	6,0 kg	brass aged finish, glass sphere iridescent
ERSA1BRBUR-GLIRI	L.30xH.50x D.30 cm	1x E27	6,0 kg	brass burnished finish, glass sphere iridescent
ERSA1COPBUR-GLIRI	L.30xH.50x D.30 cm	1x E27	6,0 kg	copper burnished finish, glass sphere iridescent
ERSA2BLM-GLIRI	L.60xH.60x D.55 cm	2x E27	8,0 kg	black matt finish, glass sphere iridescent
ERSA2B-GLIRI	L.60xH.60x D.55 cm	2x E27	8,0 kg	bronze finish, glass sphere iridescent
ERSA2N-GLIRI	L.60xH.60x D.55 cm	2x E27	8,0 kg	nickel finish, glass sphere iridescent
ERSA2BR-GLIRI	L.60xH.60x D.55 cm	2x E27	8,0 kg	brass finish, glass sphere iridescent
ERSA2BRA-GLIRI	L.60xH.60x D.55 cm	2x E27	8,0 kg	brass aged finish, glass sphere iridescent
ERSA2BRBUR-GLIRI	L.60xH.60x D.55 cm	2x E27	8,0 kg	brass burnished finish, glass sphere iridescent
ERSA2COPBUR-GLIRI	L.60xH.60x D.55 cm	2x E27	8,0 kg	copper burnished finish, glass sphere iridescent
ERSA3BLM-GLIRI	L.65xH.60x D.55 cm	3x E27	10,0 kg	black matt finish, glass sphere iridescent
ERSA3B-GLIRI	L.65xH.60x D.55 cm	3x E27	10,0 kg	bronze finish, glass sphere iridescent
ERSA3N-GLIRI	L.65xH.60x D.55 cm	3x E27	10,0 kg	nickel finish, glass sphere iridescent
ERSA3BR-GLIRI	L.65xH.60x D.55 cm	3x E27	10,0 kg	brass finish, glass sphere iridescent
ERSA3BRA-GLIRI	L.65xH.60x D.55 cm	3x E27	10,0 kg	brass aged finish, glass sphere iridescent
ERSA3BRBUR-GLIRI	L.65xH.60x D.55 cm	3x E27	10,0 kg	brass burnished finish, glass sphere iridescent
ERSA3COPBUR-GLIRI	L.65xH.60x D.55 cm	3x E27	10,0 kg	copper burnished finish, glass sphere iridescent

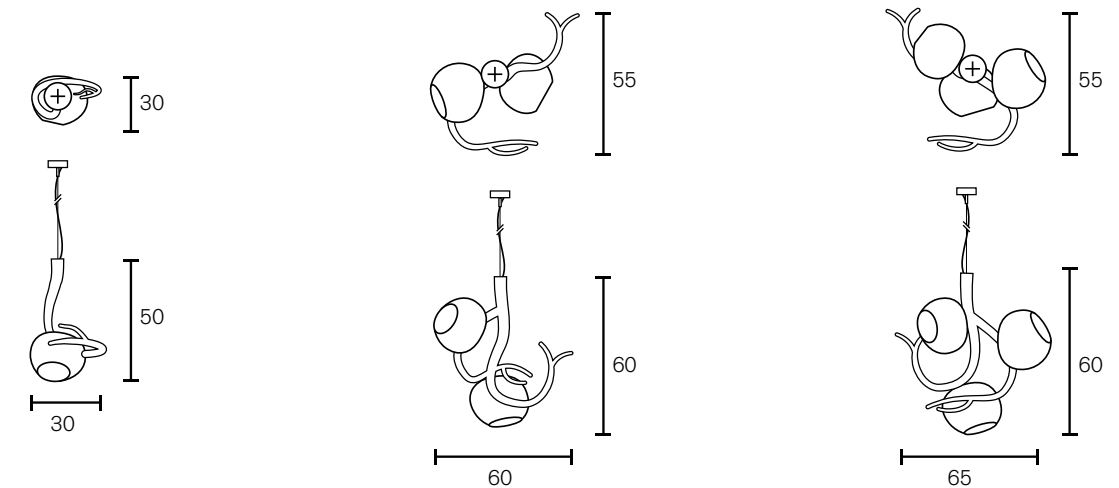

Standard the ERSA will be delivered with iridescent glass spheres. Other options are bronze translucent or clear glass spheres.

Technical information

Vertical

Art.nr.	Dimensions	Light bulb	Weight	Finish
ERSAV110BLM-GLIRI	Ø60xH.110 cm	5x E27	15,0 kg	black matt finish, glass sphere iridescent
ERSAV110B-GLIRI	Ø60xH.110 cm	5x E27	15,0 kg	bronze finish, glass sphere iridescent
ERSAV110N-GLIRI	Ø60xH.110 cm	5x E27	15,0 kg	nickel finish, glass sphere iridescent
ERSAV110BR-GLIRI	Ø60xH.110 cm	5x E27	15,0 kg	brass finish, glass sphere iridescent
ERSAV110BRA-GLIRI	Ø60xH.110 cm	5x E27	15,0 kg	brass aged finish, glass sphere iridescent
ERSAV110BRBUR-GLIRI	Ø60xH.110 cm	5x E27	15,0 kg	brass burnished finish, glass sphere iridescent
ERSAV110COPBUR-GLIRI	Ø60xH.110 cm	5x E27	15,0 kg	copper burnished finish, glass sphere iridescent
ERSAV130BLM-GLIRI	Ø90xH.130 cm	8x E27	20,0 kg	black matt finish, glass sphere iridescent
ERSAV130B-GLIRI	Ø90xH.130 cm	8x E27	20,0 kg	bronze finish, glass sphere iridescent
ERSAV130N-GLIRI	Ø90xH.130 cm	8x E27	20,0 kg	nickel finish, glass sphere iridescent
ERSAV130BR-GLIRI	Ø90xH.130 cm	8x E27	20,0 kg	brass finish, glass sphere iridescent
ERSAV130BRBUR-GLIRI	Ø90xH.130 cm	8x E27	20,0 kg	brass burnished finish, glass sphere iridescent
ERSAV130NA-GLIRI	Ø90xH.130 cm	8x E27	20,0 kg	nickel aged finish, glass sphere iridescent
ERSAV130COPBUR-GLIRI	Ø90xH.130 cm	8x E27	20,0 kg	copper burnished finish, glass sphere iridescent
ERSAV160BLM-GLIRI	Ø90xH.160 cm	9x E27	25,0 kg	black matt finish, glass sphere iridescent
ERSAV160B-GLIRI	Ø90xH.160 cm	9x E27	25,0 kg	bronze finish, glass sphere iridescent
ERSAV160N-GLIRI	Ø90xH.160 cm	9x E27	25,0 kg	nickel finish, glass sphere iridescent
ERSAV160BR-GLIRI	Ø90xH.160 cm	9x E27	25,0 kg	brass finish, glass sphere iridescent
ERSAV160BRBUR-GLIRI	Ø90xH.160 cm	9x E27	25,0 kg	brass burnished finish, glass sphere iridescent
ERSAV160NA-GLIRI	Ø90xH.160 cm	9x E27	25,0 kg	nickel aged finish, glass sphere iridescent
ERSAV160COPBUR-GLIRI	Ø90xH.160 cm	9x E27	25,0 kg	copper burnished finish, glass sphere iridescent
ERSAV180BLM-GLIRI	Ø90xH.180 cm	9x E27	35,0 kg	black matt finish, glass sphere iridescent
ERSAV180B-GLIRI	Ø90xH.180 cm	9x E27	35,0 kg	bronze finish, glass sphere iridescent
ERSAV180N-GLIRI	Ø90xH.180 cm	9x E27	35,0 kg	nickel finish, glass sphere iridescent
ERSAV180BR-GLIRI	Ø90xH.180 cm	9x E27	35,0 kg	brass finish, glass sphere iridescent
ERSAV180BRBUR-GLIRI	Ø90xH.180 cm	9x E27	35,0 kg	brass burnished finish, glass sphere iridescent
ERSAV180NA-GLIRI	Ø90xH.180 cm	9x E27	35,0 kg	nickel aged finish, glass sphere iridescent
ERSAV180COPBUR-GLIRI	Ø90xH.180 cm	9x E27	35,0 kg	copper burnished finish, glass sphere iridescent

Standard the ERSA will be delivered with iridescent glass spheres. Other options are bronze translucent or clear glass spheres.

Technical information

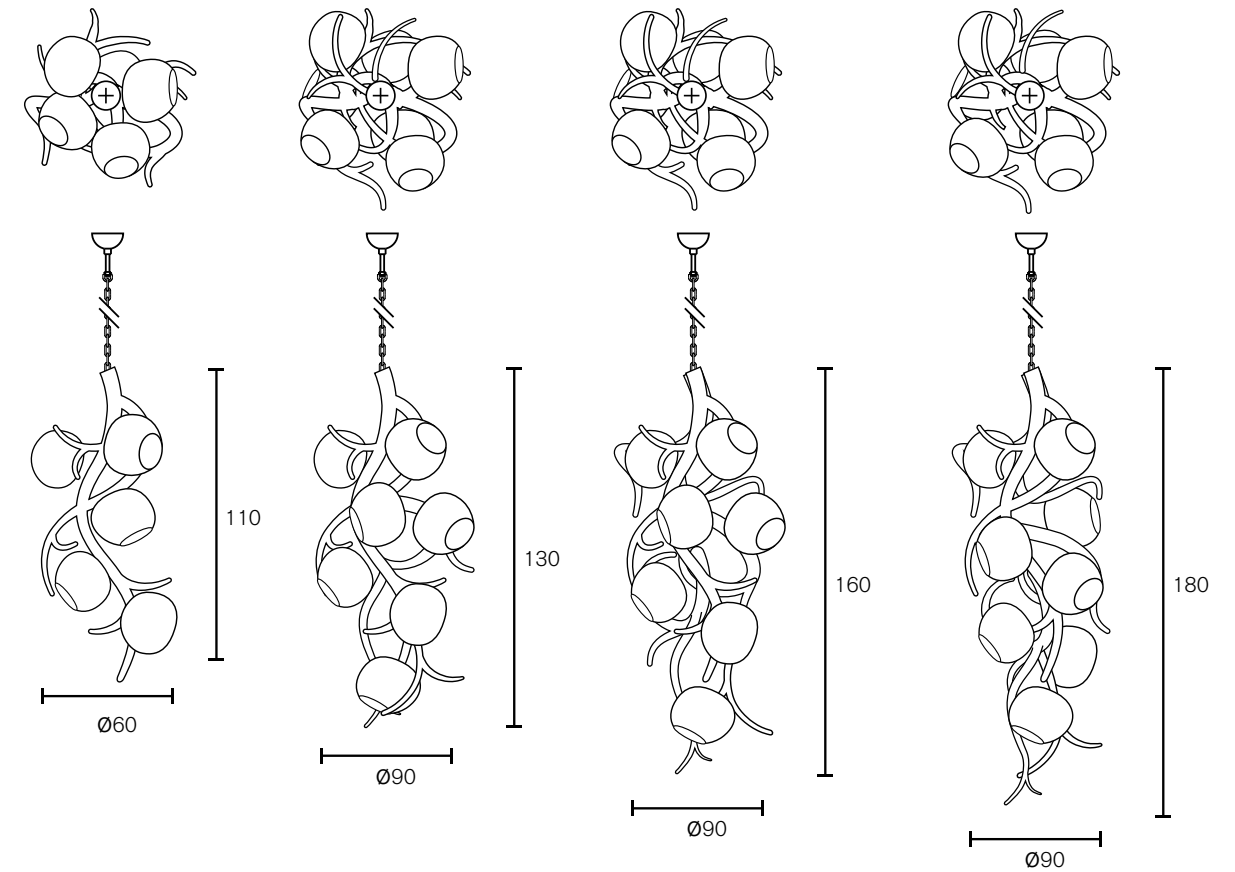

Standard the ERSA will be delivered with iridescent glass spheres. Other options are bronze translucent or clear glass spheres.

Technical information

Chandelier Oval

Art.nr.	Dimensions	Light bulb	Weight	Finish
ERSAOC120BLM-GLIRI	L.120xW.60xH.70 cm	5x E27	18,0 kg	black matt finish, glass sphere iridescent
ERSAOC120B-GLIRI	L.120xW.60xH.70 cm	5x E27	18,0 kg	bronze finish, glass sphere iridescent
ERSAOC120N-GLIRI	L.120xW.60xH.70 cm	5x E27	18,0 kg	nickel finish, glass sphere iridescent
ERSAOC120BR-GLIRI	L.120xW.60xH.70 cm	5x E27	18,0 kg	brass finish, glass sphere iridescent
ERSAOC120BRBUR-GLIRI	L.120xW.60xH.70 cm	5x E27	18,0 kg	brass burnished finish, glass sphere iridescent
ERSAOC120NA-GLIRI	L.120xW.60xH.70 cm	5x E27	18,0 kg	nickel aged finish, glass sphere iridescent
ERSAOC120COPBUR-GLIRI	L.120xW.60xH.70 cm	5x E27	18,0 kg	copper burnished finish, glass sphere iridescent
ERSAOC140BLM-GLIRI	L.140xW.60xH.70 cm	7x E27	20,0 kg	black matt finish, glass sphere iridescent
ERSAOC140B-GLIRI	L.140xW.60xH.70 cm	7x E27	20,0 kg	bronze finish, glass sphere iridescent
ERSAOC140N-GLIRI	L.140xW.60xH.70 cm	7x E27	20,0 kg	nickel finish, glass sphere iridescent
ERSAOC140BR-GLIRI	L.140xW.60xH.70 cm	7x E27	20,0 kg	brass finish, glass sphere iridescent
ERSAOC140BRBUR-GLIRI	L.140xW.60xH.70 cm	7x E27	20,0 kg	brass burnished finish, glass sphere iridescent
ERSAOC140NA-GLIRI	L.140xW.60xH.70 cm	7x E27	20,0 kg	nickel aged finish, glass sphere iridescent
ERSAOC140COPBUR-GLIRI	L.140xW.60xH.70 cm	7x E27	20,0 kg	copper burnished finish, glass sphere iridescent
ERSAOC160BLM-GLIRI	L.160xW.60xH.70 cm	8x E27	30,0 kg	black matt finish, glass sphere iridescent
ERSAOC160B-GLIRI	L.160xW.60xH.70 cm	8x E27	30,0 kg	bronze finish, glass sphere iridescent
ERSAOC160N-GLIRI	L.160xW.60xH.70 cm	8x E27	30,0 kg	nickel finish, glass sphere iridescent
ERSAOC160BR-GLIRI	L.160xW.60xH.70 cm	8x E27	30,0 kg	brass finish, glass sphere iridescent
ERSAOC160BRBUR-GLIRI	L.160xW.60xH.70 cm	8x E27	30,0 kg	brass burnished finish, glass sphere iridescent
ERSAOC160NA-GLIRI	L.160xW.60xH.70 cm	8x E27	30,0 kg	nickel aged finish, glass sphere iridescent
ERSAOC160COPBUR-GLIRI	L.160xW.60xH.70 cm	8x E27	30,0 kg	copper burnished finish, glass sphere iridescent
ERSAOC180BLM-GLIRI	L.180xW.60xH.70 cm	9x E27	40,0 kg	black matt finish, glass sphere iridescent
ERSAOC180B-GLIRI	L.180xW.60xH.70 cm	9x E27	40,0 kg	bronze finish, glass sphere iridescent
ERSAOC180N-GLIRI	L.180xW.60xH.70 cm	9x E27	40,0 kg	nickel finish, glass sphere iridescent
ERSAOC180BR-GLIRI	L.180xW.60xH.70 cm	9x E27	40,0 kg	brass finish, glass sphere iridescent
ERSAOC180BRBUR-GLIRI	L.180xW.60xH.70 cm	9x E27	40,0 kg	brass burnished finish, glass sphere iridescent
ERSAOC180NA-GLIRI	L.180xW.60xH.70 cm	9x E27	40,0 kg	nickel aged finish, glass sphere iridescent
ERSAOC180COPBUR-GLIRI	L.180xW.60xH.70 cm	9x E27	40,0 kg	copper burnished finish, glass sphere iridescent

Standard the ERSA will be delivered with iridescent glass spheres. Other options are bronze translucent or clear glass spheres.

Technical information

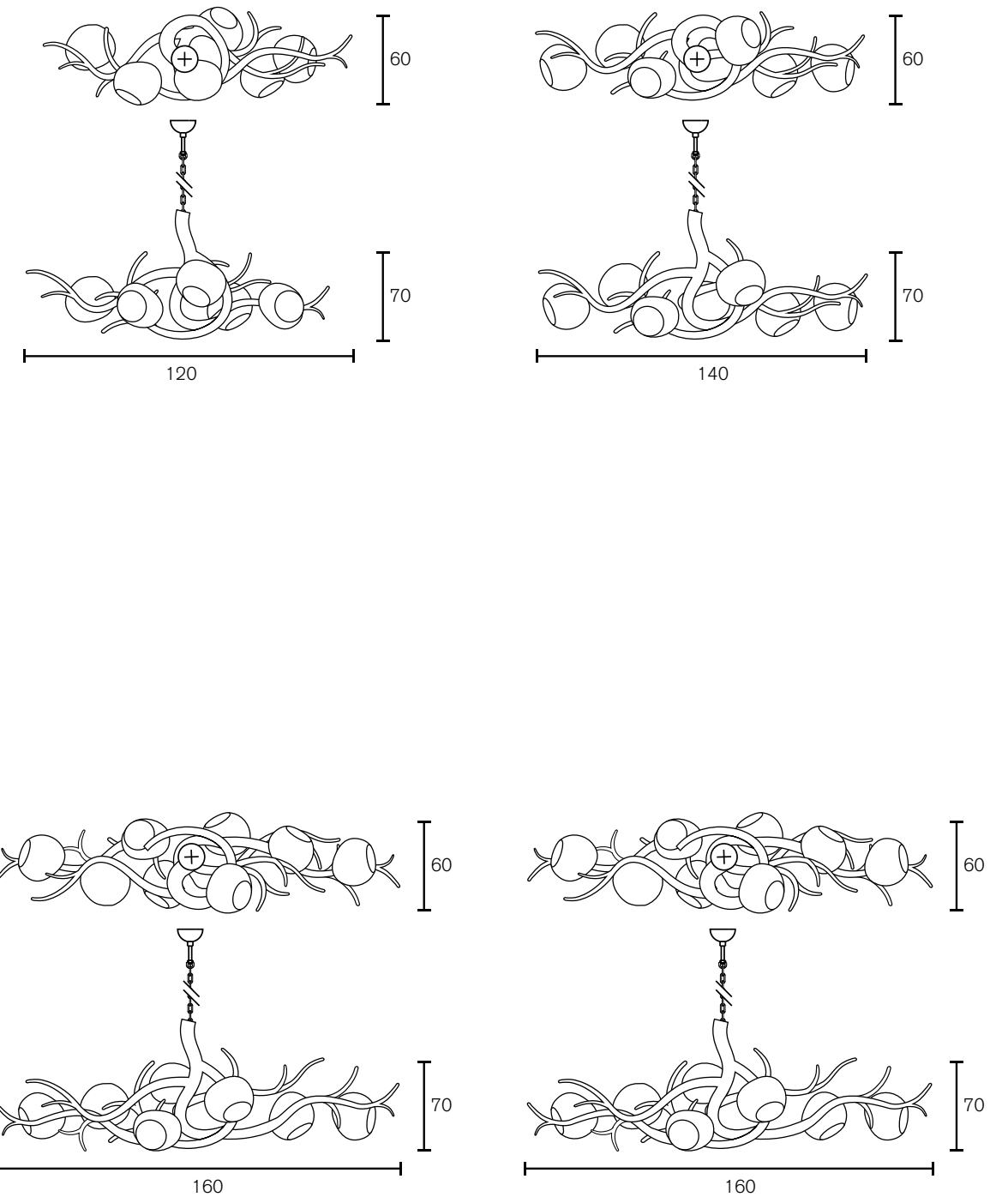

Standard the ERSA will be delivered with iridescent glass spheres. Other options are bronze translucent or clear glass spheres.

Technical information

Hanging Lamp Long

Art.nr.	Dimensions	Light bulb	Weight	Finish
ERSAHL150BLM-GLIRI	L.155xW.45xH.35 cm	5x E27	15.0 kg	black matt finish, glass sphere iridescent
ERSAHL150B-GLIRI	L.155xW.45xH.35 cm	5x E27	15.0 kg	bronze finish, glass sphere iridescent
ERSAHL150N-GLIRI	L.155xW.45xH.35 cm	5x E27	15.0 kg	nickel finish, glass sphere iridescent
ERSAHL150BR-GLIRI	L.155xW.45xH.35 cm	5x E27	15.0 kg	brass finish, glass sphere iridescent
ERSAHL150BRA-GLIRI	L.155xW.45xH.35 cm	5x E27	15.0 kg	brass aged finish, glass sphere iridescent
ERSAHL150BRBUR-GLIRI	L.155xW.45xH.35 cm	5x E27	15.0 kg	brass burnished finish, glass sphere iridescent
ERSAHL150COPBUR-GLIRI	L.155xW.45xH.35 cm	5x E27	15.0 kg	copper burnished finish, glass sphere iridescent

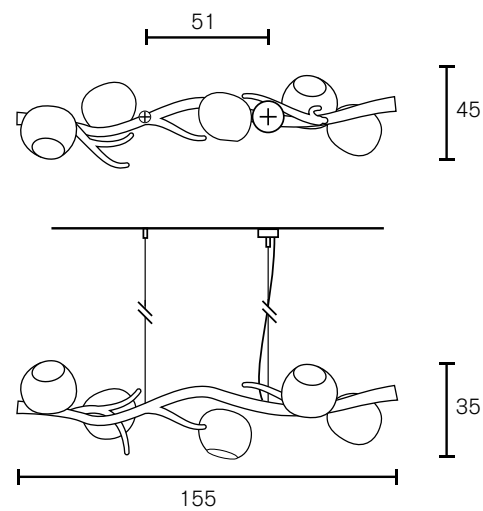

Ceiling Lamp Round

Art.nr.	Dimensions	Light bulb	Weight	Finish
ERSAP60BLM-GLIRI	Ø60xH.25 cm	3x E27	10,0 kg	black matt finish, glass sphere iridescent
ERSAP60B-GLIRI	Ø60xH.25 cm	3x E27	10,0 kg	bronze finish, glass sphere iridescent
ERSAP60N-GLIRI	Ø60xH.25 cm	3x E27	10,0 kg	nickel finish, glass sphere iridescent
ERSAP60BR-GLIRI	Ø60xH.25 cm	3x E27	10,0 kg	brass finish, glass sphere iridescent
ERSAP60BRA-GLIRI	Ø60xH.25 cm	3x E27	10,0 kg	brass aged finish, glass sphere iridescent
ERSAP60BRBUR-GLIRI	Ø60xH.25 cm	3x E27	10,0 kg	brass burnished finish, glass sphere iridescent
ERSAP60COPBUR-GLIRI	Ø60xH.25 cm	3x E27	10,0 kg	copper burnished finish, glass sphere iridescent

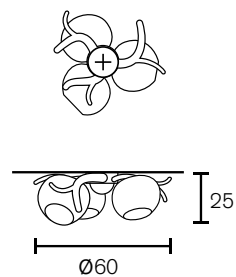

Standard the ERSA will be delivered with iridescent glass spheres. Other options are bronze translucent or clear glass spheres.

Technical information

Ceiling Chandelier

Art.nr.	Dimensions	Light bulb	Weight	Finish
ERSACP80BLM-GLIRI	Ø80xH.65 cm	5x E27	13.0 kg	black matt finish, glass sphere iridescent
ERSACP80B-GLIRI	Ø80xH.65 cm	5x E27	13.0 kg	bronze finish, glass sphere iridescent
ERSACP80N-GLIRI	Ø80xH.65 cm	5x E27	13.0 kg	nickel finish, glass sphere iridescent
ERSACP80BR-GLIRI	Ø80xH.65 cm	5x E27	13.0 kg	brass finish, glass sphere iridescent
ERSACP80BRA-GLIRI	Ø80xH.65 cm	5x E27	13.0 kg	brass aged finish, glass sphere iridescent
ERSACP80BRBUR-GLIRI	Ø80xH.65 cm	5x E27	13.0 kg	brass burnished finish, glass sphere iridescent
ERSACP80COPBUR-GLIRI	Ø80xH.65 cm	5x E27	13,0 kg	copper burnished finish, glass sphere iridescent

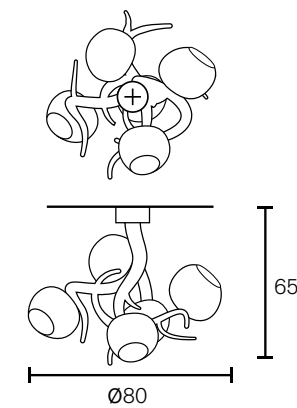

Standard the ERSA will be delivered with iridescent glass spheres. Other options are bronze translucent or clear glass spheres.

Technical information

Floor lamp

Art.nr.	Dimensions	Light bulb	Weight	Finish
ERSAF200BLM-GLIRI	Ø40xH.205 cm	3x E27	24.0 kg	black matt finish, glass sphere iridescent
ERSAF200B-GLIRI	Ø40xH.205 cm	3x E27	24.0 kg	bronze finish, glass sphere iridescent
ERSAF200N-GLIRI	Ø40xH.205 cm	3x E27	24.0 kg	nickel finish, glass sphere iridescent
ERSAF200BR-GLIRI	Ø40xH.205 cm	3x E27	24.0 kg	brass finish, glass sphere iridescent
ERSAF200BRA-GLIRI	Ø40xH.205 cm	3x E27	24.0 kg	brass aged finish, glass sphere iridescent
ERSAF200BRBUR-GLIRI	Ø40xH.205 cm	3x E27	24.0 kg	brass burnished finish, glass sphere iridescent
ERSAF200COPBUR-GLIRI	Ø40xH.205 cm	3x E27	24.0 kg	copper burnished finish, glass sphere iridescent

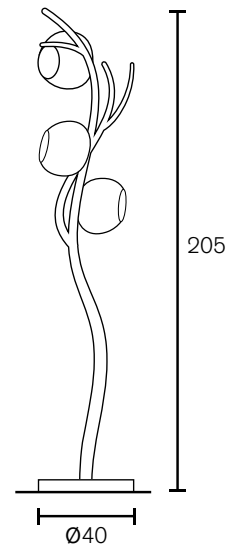

Wall lamp

Art.nr.	Dimensions	Light bulb	Weight	Finish
ERSAW30BLM-GLIRI	W.30xH.45xD.29 cm	1x E27	4,0 kg	black matt finish, glass sphere iridescent
ERSAW30B-GLIRI	W.30xH.45xD.29 cm	1x E27	4,0 kg	bronze finish, glass sphere iridescent
ERSAW30N-GLIRI	W.30xH.45xD.29 cm	1x E27	4,0 kg	nickel finish, glass sphere iridescent
ERSAW30BR-GLIRI	W.30xH.45xD.29 cm	1x E27	4,0 kg	brass finish, glass sphere iridescent
ERSAW30BRA-GLIRI	W.30xH.45xD.29 cm	1x E27	4,0 kg	brass aged finish, glass sphere iridescent
ERSAW30BRBUR-GLIRI	W.30xH.45xD.29 cm	1x E27	4,0 kg	brass burnished finish, glass sphere iridescent
ERSAW30COPBUR-GLIRI	W.30xH.45xD.29 cm	1x E27	4,0 kg	copper burnished finish, glass sphere iridescent

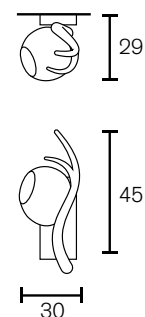

Standard the ERSA will be delivered with iridescent glass spheres. Other options are bronze translucent or clear glass spheres.

Technical information

Collection Edison's Tail 2017

Element

Art.nr.	Dimensions	Light bulb	Weight	Finish
ED1QBLM	L.30xH.45x D.30 cm	1x E27	2,5 kg	black matt finish
ED1QWM	L.30xH.45x D.30 cm	1x E27	2,5 kg	white matt finish
ED1QB	L.30xH.45x D.30 cm	1x E27	2,5 kg	bronze finish
ED1QN	L.30xH.45x D.30 cm	1x E27	2,5 kg	nickel finish
ED1QBR	L.30xH.45x D.30 cm	1x E27	2,5 kg	brass finish
ED1QBRA	L.30xH.45x D.30 cm	1x E27	2,5 kg	brass aged finish
ED1QBRBUR	L.30xH.45x D.30 cm	1x E27	2,5 kg	brass burnished finish
ED1XBLM	L.30xH.55x D.20 cm	1x E27	2,5 kg	black matt finish
ED1XWM	L.30xH.55x D.20 cm	1x E27	2,5 kg	white matt finish
ED1XB	L.30xH.55x D.20 cm	1x E27	2,5 kg	bronze finish
ED1XN	L.30xH.55x D.20 cm	1x E27	2,5 kg	nickel finish
ED1XBR	L.30xH.55x D.20 cm	1x E27	2,5 kg	brass finish
ED1XBRA	L.30xH.55x D.20 cm	1x E27	2,5 kg	brass aged finish
ED1XBRBUR	L.30xH.55x D.20 cm	1x E27	2,5 kg	brass burnished finish
ED1YBLM	L.35xH.45x D.20 cm	1x E27	2,5 kg	black matt finish
ED1YWM	L.35xH.45x D.20 cm	1x E27	2,5 kg	white matt finish
ED1YB	L.35xH.45x D.20 cm	1x E27	2,5 kg	bronze finish
ED1YN	L.35xH.45x D.20 cm	1x E27	2,5 kg	nickel finish
ED1YBR	L.35xH.45x D.20 cm	1x E27	2,5 kg	brass finish
ED1YBRA	L.35xH.45x D.20 cm	1x E27	2,5 kg	brass aged finish
ED1YBRBUR	L.35xH.45x D.20 cm	1x E27	2,5 kg	brass burnished finish
ED1ZBLM	L.45xH.45x D.20 cm	1x E27	2,5 kg	black matt finish
ED1ZWM	L.45xH.45x D.20 cm	1x E27	2,5 kg	white matt finish
ED1ZB	L.45xH.45x D.20 cm	1x E27	2,5 kg	bronze finish
ED1ZN	L.45xH.45x D.20 cm	1x E27	2,5 kg	nickel finish
ED1ZBR	L.45xH.45x D.20 cm	1x E27	2,5 kg	brass finish
ED1ZBRA	L.45xH.45x D.20 cm	1x E27	2,5 kg	brass aged finish
ED1ZBRBUR	L.45xH.45x D.20 cm	1x E27	2,5 kg	brass burnished finish

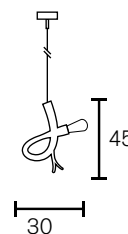

ED1Q

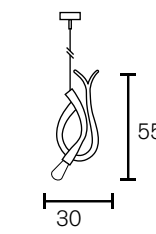

ED1X

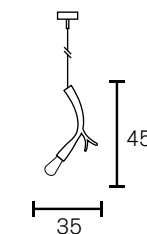

ED1Y

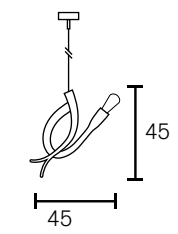

ED1Z

Technical information

Element

Art.nr.	Dimensions	Light bulb	Weight	Finish
ED2BLM	L.45xH.50x D.40 cm	2x E27	5,0 kg	black matt finish
ED2WM	L.45xH.50x D.40 cm	2x E27	5,0 kg	white matt finish
ED2B	L.45xH.50x D.40 cm	2x E27	5,0 kg	bronze finish
ED2N	L.45xH.50x D.40 cm	2x E27	5,0 kg	nickel finish
ED2BR	L.45xH.50x D.40 cm	2x E27	5,0 kg	brass finish
ED2BRA	L.45xH.50x D.40 cm	2x E27	5,0 kg	brass aged finish
ED2BRBUR	L.45xH.50x D.40 cm	2x E27	5,0 kg	brass burnished finish

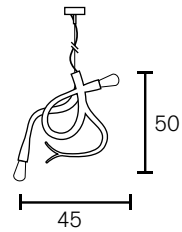

Element

Art.nr.	Dimensions	Light bulb	Weight	Finish
ED3BLM	L.55xH.63x D.35 cm	3x E27	8,0 kg	black matt finish
ED3WM	L.55xH.63x D.35 cm	3x E27	8,0 kg	white matt finish
ED3B	L.55xH.63x D.35 cm	3x E27	8,0 kg	bronze finish
ED3N	L.55xH.63x D.35 cm	3x E27	8,0 kg	nickel finish
ED3BR	L.55xH.63x D.35 cm	3x E27	8,0 kg	brass finish
ED3BRA	L.55xH.63x D.35 cm	3x E27	8,0 kg	brass aged finish
ED3BRBUR	L.55xH.63x D.35 cm	3x E27	8,0 kg	brass burnished finish

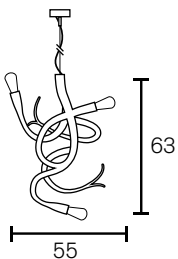

Technical information

Element

Art.nr.	Dimensions	Light bulb	Weight	Finish
ED5BLM	L.90xH.90x D.70 cm	5x E27	10,0 kg	black matt finish
ED5WM	L.90xH.90x D.70 cm	5x E27	10,0 kg	white matt finish
ED5B	L.90xH.90x D.70 cm	5x E27	10,0 kg	bronze finish
ED5N	L.90xH.90x D.70 cm	5x E27	10,0 kg	nickel finish
ED5BR	L.90xH.90x D.70 cm	5x E27	10,0 kg	brass finish
ED5BRA	L.90xH.90x D.70 cm	5x E27	10,0 kg	brass aged finish
ED5BRBUR	L.90xH.90x D.70 cm	5x E27	10,0 kg	brass burnished finish

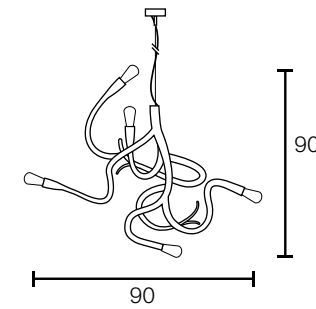
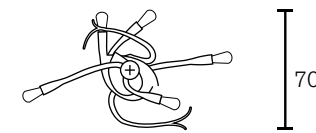

Technical information

Collection Shiro 2017

Suspension Ring

Art.nr.	Dimensions	Light bulb	Weight	Finish
SHSR100BLM	Ø115xH.33 cm	18x E14	23,0 kg	black matt finish
SHSR100BRBUR	Ø115xH.33 cm	18x E14	23,0 kg	brass burnished finish
SHSR120BLM	Ø135xH.33 cm	20x E14	28,0 kg	black matt finish
SHSR120BRBUR	Ø135xH.33 cm	20x E14	28,0 kg	brass burnished finish
SHSR140BLM	Ø155xH.33 cm	22x E14	35,0 kg	black matt finish
SHSR140BRBUR	Ø155xH.33 cm	22x E14	35,0 kg	brass burnished finish
SHSR160BLM	Ø175xH.33 cm	24x E14	50,0 kg	black matt finish
SHSR160BRBUR	Ø175xH.33 cm	24x E14	50,0 kg	brass burnished finish
SHSR180BLM	Ø195xH.33 cm	26x E14	75,0 kg	black matt finish
SHSR180BRBUR	Ø195xH.33 cm	26x E14	75,0 kg	brass burnished finish
SHSR200BLM	Ø215xH.33 cm	28x E14	100,0 kg	black matt finish
SHSR200BRBUR	Ø215xH.33 cm	28x E14	100,0 kg	brass burnished finish

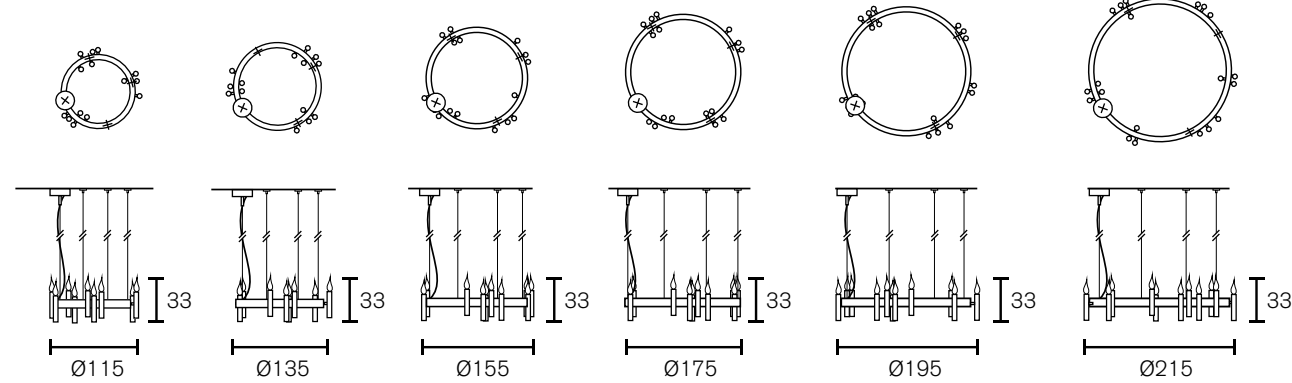

Suspension Horizontal

Art.nr.	Dimensions	Light bulb	Weight	Finish
SHSH100BLM	L.100xW.25xH.33 cm	8x E14	15,0 kg	2x MR11 spot downlight, 12Volt, black matt finish
SHSH100BRBUR	L.100xW.25xH.33 cm	8x E14	15,0 kg	2x MR11 spot downlight, 12Volt, brass burnished finish
SHSH120BLM	L.120xW.25xH.33 cm	12x E14	20,0 kg	3x MR11 spot downlight, 12Volt, black matt finish
SHSH120BRBUR	L.120xW.25xH.33 cm	12x E14	20,0 kg	3x MR11 spot downlight, 12Volt, brass burnished finish
SHSH150BLM	L.150xW.25xH.33 cm	14x E14	35,0 kg	3x MR11 spot downlight, 12Volt, black matt finish
SHSH150BRBUR	L.150xW.25xH.33 cm	14x E14	35,0 kg	3x MR11 spot downlight, 12Volt, brass burnished finish
SHSH200BLM	L.200xW.25xH.33 cm	16x E14	55,0 kg	4x MR11 spot downlight, 12Volt, black matt finish
SHSH200BRBUR	L.200xW.25xH.33 cm	16x E14	55,0 kg	4x MR11 spot downlight, 12Volt, brass burnished finish

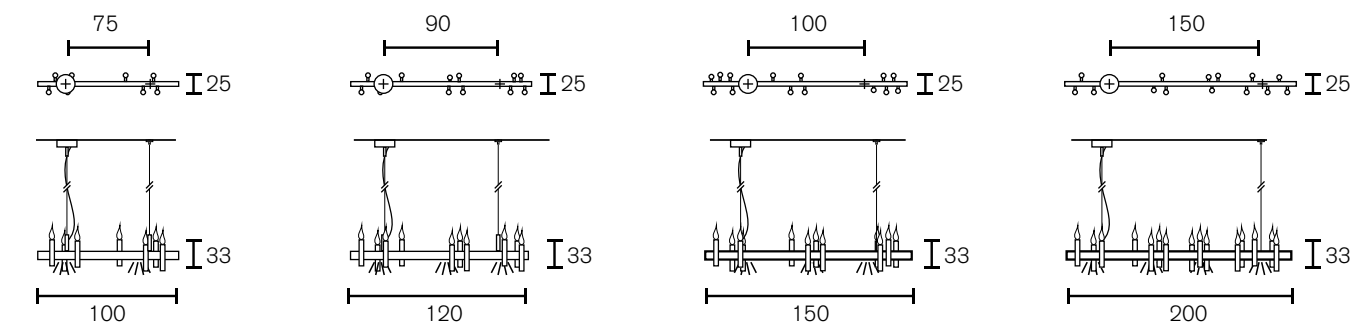

Technical information

Suspension Vertical

Art.nr.	Dimensions	Light bulb	Weight	Finish
SHSV70BLM	Ø22xH.80 cm	6x E14	8,0 kg	1x GU10 spot downlight, black matt finish
SHSV70BRBUR	Ø22xH.80 cm	6x E14	8,0 kg	1x GU10 spot downlight, brass burnished finish
SHSV150BLM	Ø22xH.160 cm	9x e14	18,0 kg	1x GU10 spot downlight, black matt finish
SHSV150BRBUR	Ø22xH.160 cm	9x e14	18,0 kg	1x GU10 spot downlight, brass burnished finish
SHSV200BLM	Ø22xH.210 cm	12x E14	30,0 kg	1x GU10 spot downlight, black matt finish
SHSV200BRBUR	Ø22xH.210 cm	12x E14	30,0 kg	1x GU10 spot downlight, brass burnished finish

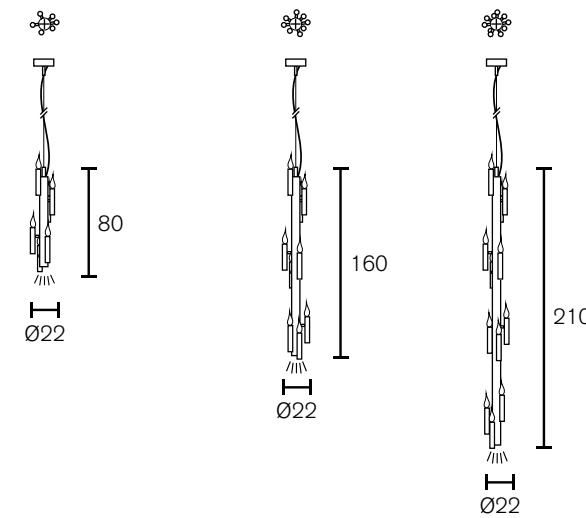

Wall lamp

Art.nr.	Dimensions	Light bulb	Weight	Finish
SHW34BLM	W.12xH.34xD.9 cm	1x E14	2,0 kg	black matt finish
SHW34BRBUR	W.12xH.34xD.9 cm	1x E14	2,0 kg	brass burnished finish

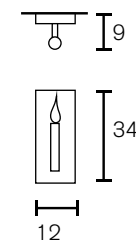

Technical information

Collection Kelp Fortuna 2017

Element

Art.nr.	Dimensions	Light bulb	Weight	Finish
KEF40BLM	Ø40xH.105 cm	1x E27	14,0 kg	black matt finish
KEF40WM	Ø40xH.105 cm	1x E27	14,0 kg	white matt finish
KEF40B	Ø40xH.105 cm	1x E27	14,0 kg	bronze finish
KEF40ST	Ø40xH.105 cm	1x E27	14,0 kg	stainless steel
KEF40BR	Ø40xH.105 cm	1x E27	14,0 kg	brass finish
KEF40BRA	Ø40xH.105 cm	1x E27	14,0 kg	brass aged finish
KEF40BRG	Ø40xH.105 cm	1x E27	14,0 kg	brass grinded finish
KEF40BRBUR	Ø40xH.105 cm	1x E27	14,0 kg	brass burnished finish
KEF40COP	Ø40xH.105 cm	1x E27	14,0 kg	copper finish

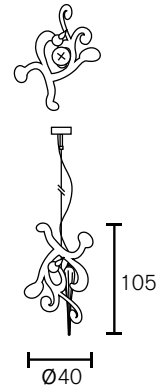

Element

Art.nr.	Dimensions	Light bulb	Weight	Finish
KEF60BLM	Ø60xH.120 cm	3x E27	25,0 kg	black matt finish
KEF60WM	Ø60xH.120 cm	3x E27	25,0 kg	white matt finish
KEF60B	Ø60xH.120 cm	3x E27	25,0 kg	bronze finish
KEF60ST	Ø60xH.120 cm	3x E27	25,0 kg	stainless steel
KEF60BR	Ø60xH.120 cm	3x E27	25,0 kg	brass finish
KEF60BRA	Ø60xH.120 cm	3x E27	25,0 kg	brass aged finish
KEF60BRG	Ø60xH.120 cm	3x E27	25,0 kg	brass grinded finish
KEF60BRBUR	Ø60xH.120 cm	3x E27	25,0 kg	brass burnished finish
KEF60COP	Ø60xH.120 cm	3x E27	25,0 kg	copper finish

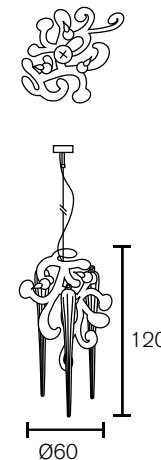

Technical information

Element

Art.nr.	Dimensions	Light bulb	Weight	Finish
KEF90BLM	Ø90xH.195 cm	3x E27	35,0 kg	black matt finish
KEF90WM	Ø90xH.195 cm	3x E27	35,0 kg	white matt finish
KEF90B	Ø90xH.195 cm	3x E27	35,0 kg	bronze finish
KEF90ST	Ø90xH.195 cm	3x E27	35,0 kg	stainless steel
KEF90BR	Ø90xH.195 cm	3x E27	35,0 kg	brass finish
KEF90BRA	Ø90xH.195 cm	3x E27	35,0 kg	brass aged finish
KEF90BRG	Ø90xH.195 cm	3x E27	35,0 kg	brass grinded finish
KEF90BRBUR	Ø90xH.195 cm	3x E27	35,0 kg	brass burnished finish
KEF90COP	Ø90xH.195 cm	3x E27	35,0 kg	copper finish

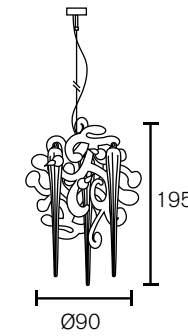

Technical information

Collection Fractal 2015

Chandelier Oval

Art.nr.	Dimensions	Light bulb	Weight	Finish
FRACOC120BLM	L.120xW.55xH.60 cm	10x E27	45,0 kg	3x GU10 spot downlight, black matt finish
FRACOC120WM	L.120xW.55xH.60 cm	10x E27	45,0 kg	3x GU10 spot downlight, white matt finish
FRACOC120ST	L.120xW.55xH.60 cm	10x E27	45,0 kg	3x GU10 spot downlight, stainless steel
FRACOC120BR	L.120xW.55xH.60 cm	10x E27	45,0 kg	3x GU10 spot downlight, brass finish
FRACOC120BRG	L.120xW.55xH.60 cm	10x E27	45,0 kg	3x GU10 spot downlight, brass grinded finish
FRACOC120BRBUR	L.120xW.55xH.60 cm	10x E27	45,0 kg	3x GU10 spot downlight, brass burnished finish
FRACOC140BLM	L.140xW.55xH.60 cm	12x E27	50,0 kg	3x GU10 spot downlight, black matt finish
FRACOC140WM	L.140xW.55xH.60 cm	12x E27	50,0 kg	3x GU10 spot downlight, white matt finish
FRACOC140ST	L.140xW.55xH.60 cm	12x E27	50,0 kg	3x GU10 spot downlight, stainless steel
FRACOC140BR	L.140xW.55xH.60 cm	12x E27	50,0 kg	3x GU10 spot downlight, brass finish
FRACOC140BRG	L.140xW.55xH.60 cm	12x E27	50,0 kg	3x GU10 spot downlight, brass grinded finish
FRACOC140BRBUR	L.140xW.55xH.60 cm	12x E27	50,0 kg	3x GU10 spot downlight, brass burnished finish
FRACOC160BLM	L.160xW.55xH.60 cm	14x E27	55,0 kg	3x GU10 spot downlight, black matt finish
FRACOC160WM	L.160xW.55xH.60 cm	14x E27	55,0 kg	3x GU10 spot downlight, white matt finish
FRACOC160ST	L.160xW.55xH.60 cm	14x E27	55,0 kg	3x GU10 spot downlight, stainless steel
FRACOC160BR	L.160xW.55xH.60 cm	14x E27	55,0 kg	3x GU10 spot downlight, brass finish
FRACOC160BRG	L.160xW.55xH.60 cm	14x E27	55,0 kg	3x GU10 spot downlight, brass grinded finish
FRACOC160BRBUR	L.160xW.55xH.60 cm	14x E27	55,0 kg	3x GU10 spot downlight, brass burnished finish
FRACOC180BLM	L.180xW.55xH.60 cm	16x E27	60,0 kg	3x GU10 spot downlight, black matt finish
FRACOC180WM	L.180xW.55xH.60 cm	16x E27	60,0 kg	3x GU10 spot downlight, white matt finish
FRACOC180ST	L.180xW.55xH.60 cm	16x E27	60,0 kg	3x GU10 spot downlight, stainless steel
FRACOC180BR	L.180xW.55xH.60 cm	16x E27	60,0 kg	3x GU10 spot downlight, brass finish
FRACOC180BRG	L.180xW.55xH.60 cm	16x E27	60,0 kg	3x GU10 spot downlight, brass grinded finish
FRACOC180BRBUR	L.180xW.55xH.60 cm	16x E27	60,0 kg	3x GU10 spot downlight, brass burnished finish

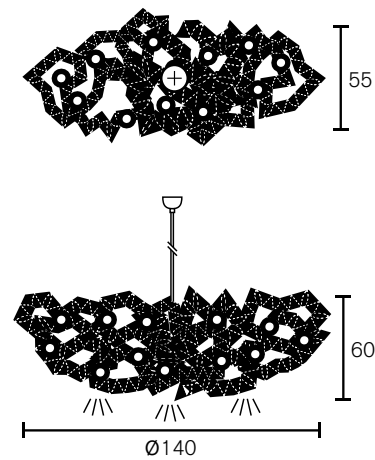
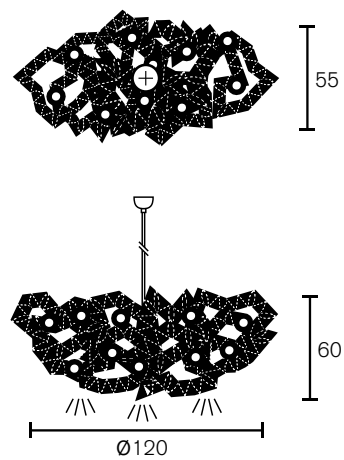

Technical information

Chandelier Round

Art.nr.	Dimensions	Light bulb	Weight	Finish
FRACC80BLM	Ø80xH.35 cm	10x E14	19,0 kg	black matt finish
FRACC80WM	Ø80xH.35 cm	10x E14	19,0 kg	white matt finish
FRACC80ST	Ø80xH.35 cm	10x E14	19,0 kg	stainless steel
FRACC80BR	Ø80xH.35 cm	10x E14	19,0 kg	brass finish
FRACC80BRG	Ø80xH.35 cm	10x E14	19,0 kg	brass grinded finish
FRACC80BRBUR	Ø80xH.35 cm	10x E14	19,0 kg	brass burnished finish
FRACC100BLM	Ø100xH.45 cm	12x E14	27,0 kg	black matt finish
FRACC100WM	Ø100xH.45 cm	12x E14	27,0 kg	white matt finish
FRACC100ST	Ø100xH.45 cm	12x E14	27,0 kg	stainless steel
FRACC100BR	Ø100xH.45 cm	12x E14	27,0 kg	brass finish
FRACC100BRG	Ø100xH.45 cm	12x E14	27,0 kg	brass grinded finish
FRACC100BRBUR	Ø100xH.45 cm	12x E14	27,0 kg	brass burnished finish

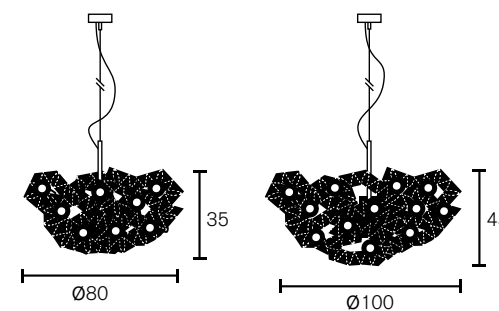
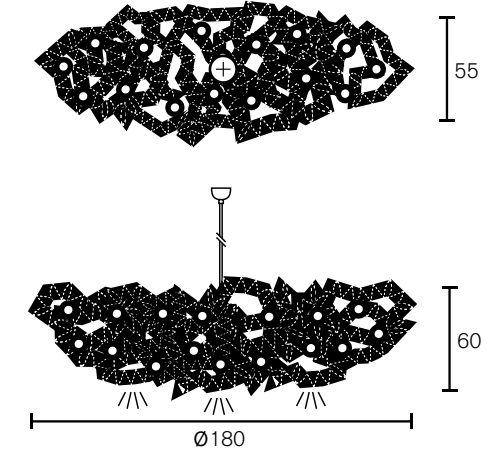
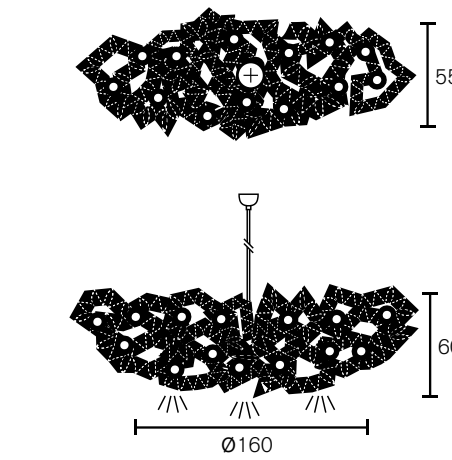

Technical information

Ceiling Lamp

Art.nr.	Dimensions	Light bulb	Weight	Finish
FRACP60BLM	Ø60xH.30 cm	8x E27	15,0 kg	black matt finish
FRACP60WM	Ø60xH.30 cm	8x E27	15,0 kg	white matt finish
FRACP60ST	Ø60xH.30 cm	8x E27	15,0 kg	stainless steel
FRACP60BR	Ø60xH.30 cm	8x E27	15,0 kg	brass finish
FRACP60BRG	Ø60xH.30 cm	8x E27	15,0 kg	brass grinded finish
FRACP60BRBUR	Ø60xH.30 cm	8x E27	15,0 kg	brass burnished finish
FRACP80BLM	Ø80xH.35 cm	10x E27	20,0 kg	black matt finish
FRACP80WM	Ø80xH.35 cm	10x E27	20,0 kg	white matt finish
FRACP80ST	Ø80xH.35 cm	10x E27	20,0 kg	stainless steel
FRACP80BR	Ø80xH.35 cm	10x E27	20,0 kg	brass finish
FRACP80BRG	Ø80xH.35 cm	10x E27	20,0 kg	brass grinded finish
FRACP80BRBUR	Ø80xH.35 cm	10x E27	20,0 kg	brass burnished finish
FRACP100BLM	Ø100xH.35 cm	10x E27	25,0 kg	black matt finish
FRACP100WM	Ø100xH.35 cm	10x E27	25,0 kg	white matt finish
FRACP100ST	Ø100xH.35 cm	10x E27	25,0 kg	stainless steel
FRACP100BR	Ø100xH.35 cm	10x E27	25,0 kg	brass finish
FRACP100BRG	Ø100xH.35 cm	10x E27	25,0 kg	brass grinded finish
FRACP100BRBUR	Ø100xH.35 cm	10x E27	25,0 kg	brass burnished finish

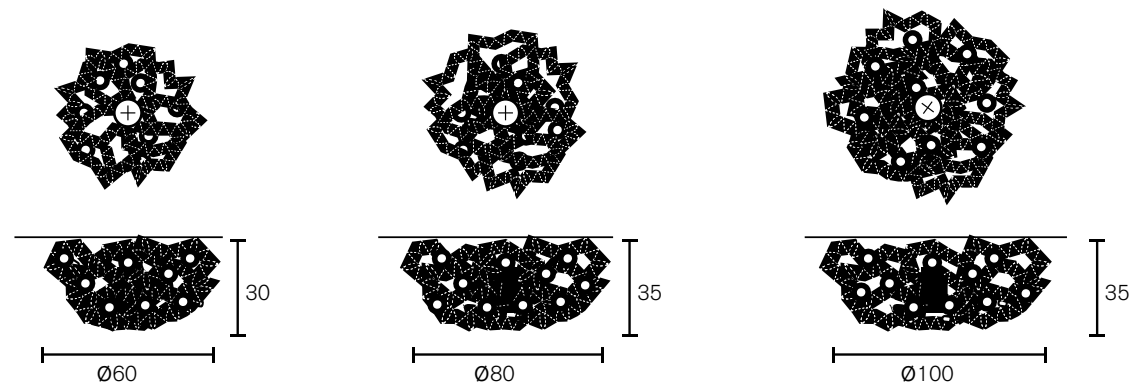

Technical information

Collection Fractal Cloud 2015

Element

Art.nr.	Dimensions	Light bulb	Weight	Finish
FRACHR55BLM	Ø55xH.60 cm	3x E27	13,0 kg	black matt finish
FRACHR55WM	Ø55xH.60 cm	3x E27	13,0 kg	white matt finish
FRACHR55ST	Ø55xH.60 cm	3x E27	13,0 kg	stainless steel
FRACHR55BR	Ø55xH.60 cm	3x E27	13,0 kg	brass finish
FRACHR55BRG	Ø55xH.60 cm	3x E27	13,0 kg	brass grinded finish
FRACHR55BRBUR	Ø55xH.60 cm	3x E27	13,0 kg	brass burnished finish
FRACHR70BLM	Ø70xH.75 cm	3x E27	18,0 kg	black matt finish
FRACHR70WM	Ø70xH.75 cm	3x E27	18,0 kg	white matt finish
FRACHR70ST	Ø70xH.75 cm	3x E27	18,0 kg	stainless steel
FRACHR70BR	Ø70xH.75 cm	3x E27	18,0 kg	brass finish
FRACHR70BRG	Ø70xH.75 cm	3x E27	18,0 kg	brass grinded finish
FRACHR70BRBUR	Ø70xH.75 cm	3x E27	18,0 kg	brass burnished finish

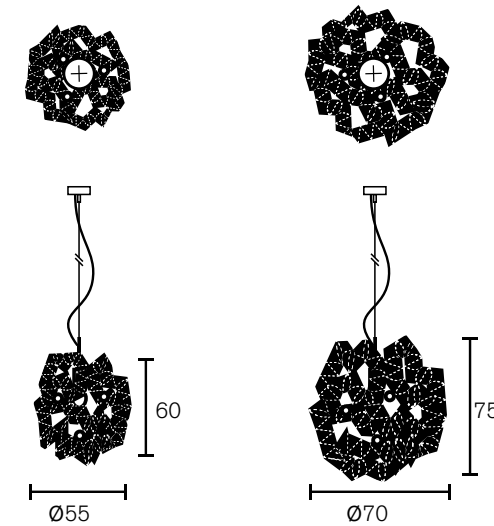

Technical information

Collection Galaxy 2019

Chandelier Round

Art.nr.	Dimensions	Light bulb	Weight	Finish
GALC80BLM	Ø80xH.70 cm	3x E27	12,0 kg	black matt finish
GALC80N	Ø80xH.70 cm	3x E27	12,0 kg	nickel finish
GALC80BR	Ø80xH.70 cm	3x E27	12,0 kg	brass finish
GALC80BRBUR	Ø80xH.70 cm	3x E27	12,0 kg	brass burnished finish
GALC80NA	Ø80xH.70 cm	3x E27	12,0 kg	nickel aged finish
GALC80COPBUR	Ø80xH.70 cm	3x E27	12,0 kg	copper burnished finish
GALC100BLM	Ø90xH.110 cm	5x E27	17,0 kg	black matt finish
GALC100N	Ø90xH.110 cm	5x E27	17,0 kg	nickel finish
GALC100BR	Ø90xH.110 cm	5x E27	17,0 kg	brass finish
GALC100BRBUR	Ø90xH.110 cm	5x E27	17,0 kg	brass burnished finish
GALC100NA	Ø90xH.110 cm	5x E27	17,0 kg	nickel aged finish
GALC100COPBUR	Ø90xH.110 cm	5x E27	17,0 kg	copper burnished finish

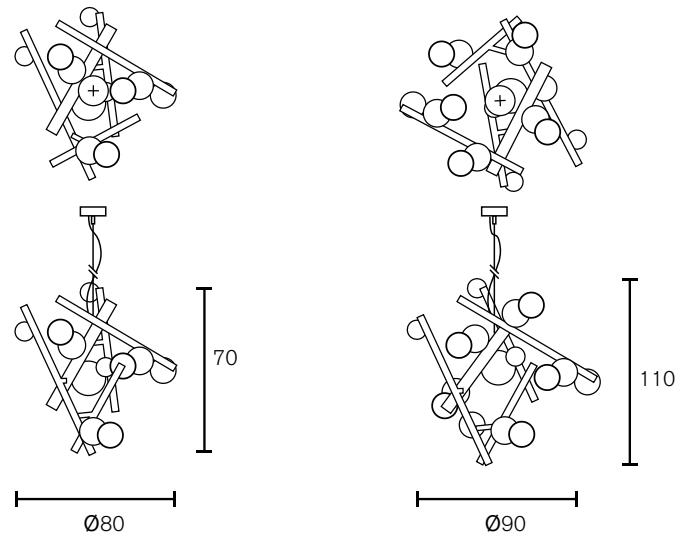

Element

Art.nr.	Dimensions	Light bulb	Weight	Finish
GALDL45BLM	L.40xW.45xH.50 cm	1x E27	5,0 kg	1x GU10 spot downlight, black matt finish
GALDL45N	L.40xW.45xH.50 cm	1x E27	5,0 kg	1x GU10 spot downlight, nickel finish
GALDL45BR	L.40xW.45xH.50 cm	1x E27	5,0 kg	1x GU10 spot downlight, brass finish
GALDL45BRBUR	L.40xW.45xH.50 cm	1x E27	5,0 kg	1x GU10 spot downlight, brass burnished finish
GALDL45NA	L.40xW.45xH.50 cm	1x E27	5,0 kg	1x GU10 spot downlight, nickel aged finish
GALDL45COPBUR	L.40xW.45xH.50 cm	1x E27	5,0 kg	1x GU10 spot downlight, copper burnished finish

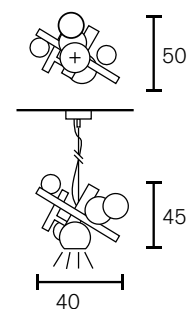

Technical information

Hanging Lamp Long

Art.nr.	Dimensions	Light bulb	Weight	Finish
GALHL140BLM	L.140xW.50xH.40 cm	3x E27	15,0 kg	3x GU10 spot downlight, black matt finish
GALHL140N	L.140xW.50xH.40 cm	3x E27	15,0 kg	3x GU10 spot downlight, nickel finish
GALHL140BR	L.140xW.50xH.40 cm	3x E27	15,0 kg	3x GU10 spot downlight, brass finish
GALHL140BRBUR	L.140xW.50xH.40 cm	3x E27	15,0 kg	3x GU10 spot downlight, brass burnished finish
GALHL140NA	L.140xW.50xH.40 cm	3x E27	15,0 kg	3x GU10 spot downlight, nickel aged finish
GALHL140COPBUR	L.140xW.50xH.40 cm	3x E27	15,0 kg	3x GU10 spot downlight, copper burnished finish

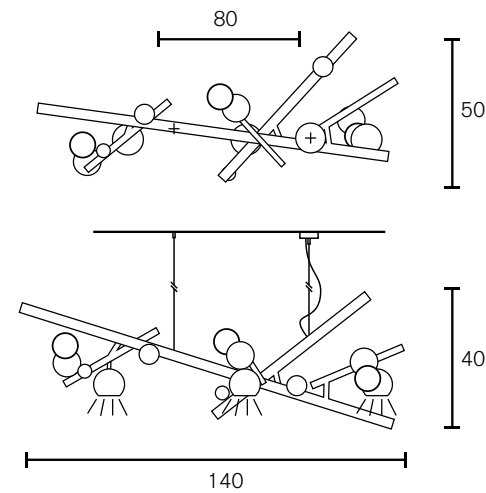

Chandelier Floor Lamp

Art.nr.	Dimensions	Light bulb	Weight	Finish
GALF180BLM	L.70xW.40xH.190 cm	3x E27	21,0 kg	black matt finish
GALF180N	L.70xW.40xH.190 cm	3x E31	21,0 kg	nickel finish
GALF180BR	L.70xW.40xH.190 cm	3x E28	21,0 kg	brass finish
GALF180BRBUR	L.70xW.40xH.190 cm	3x E29	21,0 kg	brass burnished finish
GALF180NA	L.70xW.40xH.190 cm	3x E32	21,0 kg	nickel aged finish
GALF180COPBUR	L.70xW.40xH.190 cm	3x E30	21,0 kg	copper burnished finish

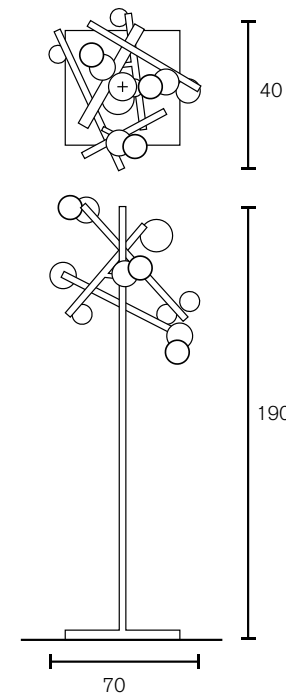

Technical information

Collection Linea 2019

Chandelier Round

Art.nr.	Dimensions	Light bulb	Weight	Finish
LINC60BLM	Ø60xH.50 cm	3x S14D	15,0 kg	black matt finish
LINC60N	Ø60xH.50 cm	3x S14D	15,0 kg	nickel finish
LINC60BR	Ø60xH.50 cm	3x S14D	15,0 kg	brass finish
LINC60BRBUR	Ø60xH.50 cm	3x S14D	15,0 kg	brass burnished finish
LINC60NA	Ø60xH.50 cm	3x S14D	15,0 kg	nickel aged finish
LINC60COPBUR	Ø60xH.50 cm	3x S14D	15,0 kg	copper burnished finish
LINC80BLM	Ø80xH.60 cm	6x S14D	20,0 kg	black matt finish
LINC80N	Ø80xH.60 cm	6x S14D	20,0 kg	nickel finish
LINC80BR	Ø80xH.60 cm	6x S14D	20,0 kg	brass finish
LINC80BRBUR	Ø80xH.60 cm	6x S14D	20,0 kg	brass burnished finish
LINC80NA	Ø80xH.60 cm	6x S14D	20,0 kg	nickel aged finish
LINC80COPBUR	Ø80xH.60 cm	6x S14D	20,0 kg	copper burnished finish
LINC100BLM	Ø100xH.70 cm	7x S14D	25,0 kg	black matt finish
LINC100N	Ø100xH.70 cm	7x S14D	25,0 kg	nickel finish
LINC100BR	Ø100xH.70 cm	7x S14D	25,0 kg	brass finish
LINC100BRBUR	Ø100xH.70 cm	7x S14D	25,0 kg	brass burnished finish
LINC100NA	Ø100xH.70 cm	7x S14D	25,0 kg	nickel aged finish
LINC100COPBUR	Ø100xH.70 cm	7x S14D	25,0 kg	copper burnished finish
LINC120BLM	Ø120xH.80 cm	8x S14D	30,0 kg	black matt finish
LINC120N	Ø120xH.80 cm	8x S14D	30,0 kg	nickel finish
LINC120BR	Ø120xH.80 cm	8x S14D	30,0 kg	brass finish
LINC120BRBUR	Ø120xH.80 cm	8x S14D	30,0 kg	brass burnished finish
LINC120NA	Ø120xH.80 cm	8x S14D	30,0 kg	nickel aged finish
LINC120COPBUR	Ø120xH.80 cm	8x S14D	30,0 kg	copper burnished finish

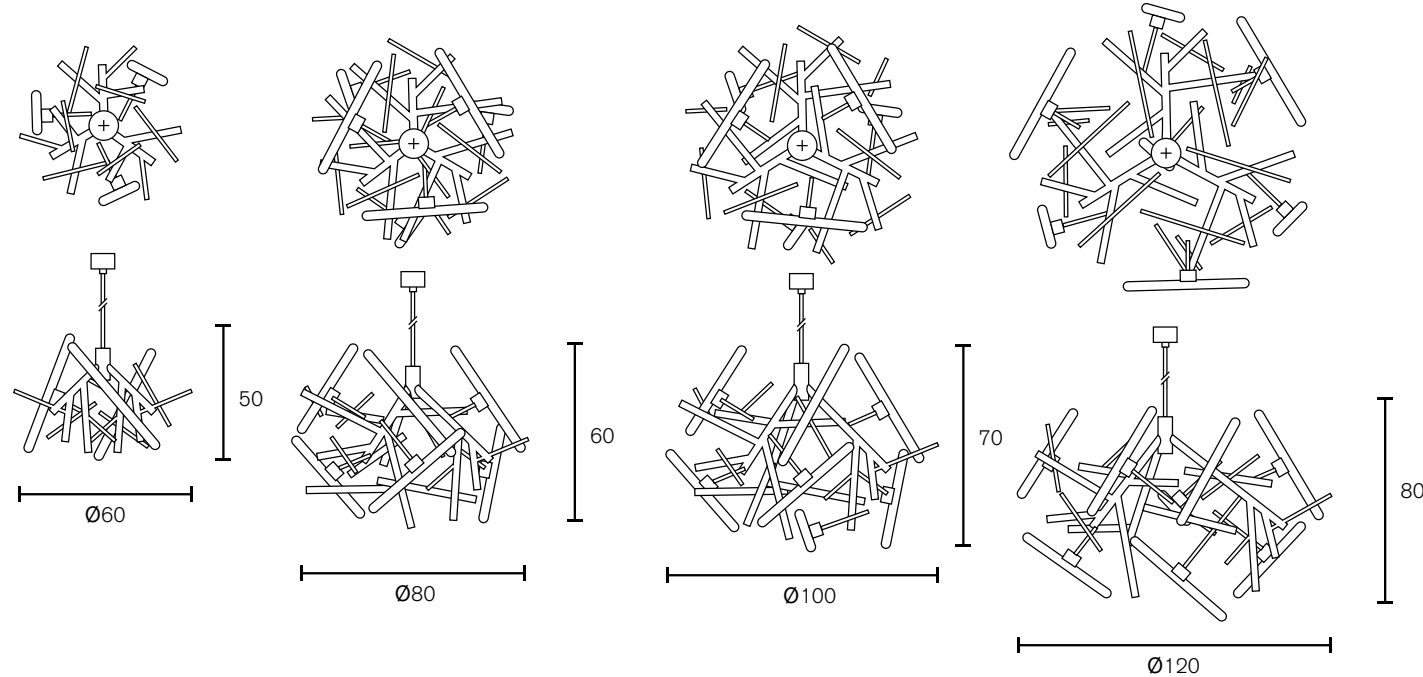

Standard the Linea will be delivered with reflector bars in finish of the lamp.

Technical information

Linea Element

Art.nr.	Dimensions	Light bulb	Weight	Finish
LINLT50/70BLM	Ø70xH.70 cm	5x S14D	6,0 kg	black matt finish
LINLT50/70N	Ø70xH.70 cm	5x S14D	6,0 kg	nickel finish
LINLT50/70BR	Ø70xH.70 cm	5x S14D	6,0 kg	brass finish
LINLT50/70BRBUR	Ø70xH.70 cm	5x S14D	6,0 kg	brass burnished finish
LINLT50/70NA	Ø70xH.70 cm	5x S14D	6,0 kg	nickel aged finish
LINLT50/70COPBUR	Ø70xH.70 cm	5x S14D	6,0 kg	copper burnished finish

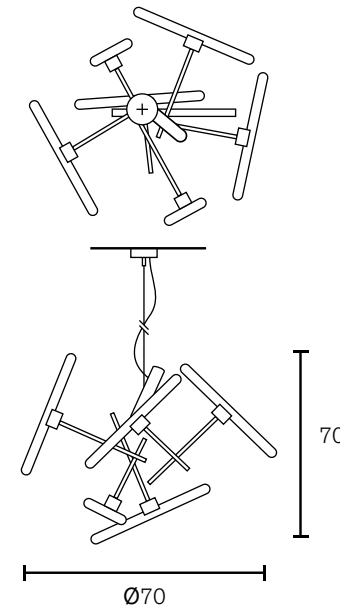

Wall lamp

Art.nr.	Dimensions	Light bulb	Weight	Finish
LINW60BLM	L.12xW.12xH.60 cm	1x S14D	4,0 kg	black matt finish
LINW60N	L.12xW.12xH.60 cm	1x S14D	4,0 kg	nickel finish
LINW60BR	L.12xW.12xH.60 cm	1x S14D	4,0 kg	brass finish
LINW60BRBUR	L.12xW.12xH.60 cm	1x S14D	4,0 kg	brass burnished finish
LINW60NA	L.12xW.12xH.60 cm	1x S14D	4,0 kg	nickel aged finish
LINW60COPBUR	L.12xW.12xH.60 cm	1x S14D	4,0 kg	copper burnished finish

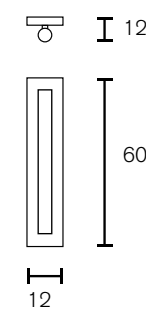

Technical information

Hanging Lamp Long

Art.nr.	Dimensions	Light bulb	Weight	Finish
LINHHL120BLM	L.120xW.60xH.50 cm	6x S14D	30,0 kg	3x GU10 spot downlight, black matt finish
LINHHL120N	L.120xW.60xH.50 cm	6x S14D	30,0 kg	3x GU10 spot downlight, nickel finish
LINHHL120BR	L.120xW.60xH.50 cm	6x S14D	30,0 kg	3x GU10 spot downlight, brass finish
LINHHL120BRBUR	L.120xW.60xH.50 cm	6x S14D	30,0 kg	3x GU10 spot downlight, brass burnished finish
LINHHL120NA	L.120xW.60xH.50 cm	6x S14D	30,0 kg	3x GU10 spot downlight, nickel aged finish
LINHHL120COPBUR	L.120xW.60xH.50 cm	6x S14D	30,0 kg	3x GU10 spot downlight, copper burnished finish
LINHHL140BLM	L.140xW.60xH.50 cm	6x S14D	40,0 kg	3x GU10 spot downlight, black matt finish
LINHHL140N	L.140xW.60xH.50 cm	6x S14D	40,0 kg	3x GU10 spot downlight, nickel finish
LINHHL140BR	L.140xW.60xH.50 cm	6x S14D	40,0 kg	3x GU10 spot downlight, brass finish
LINHHL140BRBUR	L.140xW.60xH.50 cm	6x S14D	40,0 kg	3x GU10 spot downlight, brass burnished finish
LINHHL140NA	L.140xW.60xH.50 cm	6x S14D	40,0 kg	3x GU10 spot downlight, nickel aged finish
LINHHL140COPBUR	L.140xW.60xH.50 cm	6x S14D	40,0 kg	3x GU10 spot downlight, copper burnished finish
LINHHL160BLM	L.160xW.60xH.50 cm	8x S14D	45,0 kg	4x GU10 spot downlight, black matt finish
LINHHL160N	L.160xW.60xH.50 cm	8x S14D	45,0 kg	4x GU10 spot downlight, nickel finish
LINHHL160BR	L.160xW.60xH.50 cm	8x S14D	45,0 kg	4x GU10 spot downlight, brass finish
LINHHL160BRBUR	L.160xW.60xH.50 cm	8x S14D	45,0 kg	4x GU10 spot downlight, brass burnished finish
LINHHL160NA	L.160xW.60xH.50 cm	8x S14D	45,0 kg	4x GU10 spot downlight, nickel aged finish
LINHHL160COPBUR	L.160xW.60xH.50 cm	8x S14D	45,0 kg	4x GU10 spot downlight, copper burnished finish
LINHHL180BLM	L.180xW.60xH.50 cm	8x S14D	50,0 kg	4x GU10 spot downlight, black matt finish
LINHHL180N	L.180xW.60xH.50 cm	8x S14D	50,0 kg	4x GU10 spot downlight, nickel finish
LINHHL180BR	L.180xW.60xH.50 cm	8x S14D	50,0 kg	4x GU10 spot downlight, brass finish
LINHHL180BRBUR	L.180xW.60xH.50 cm	8x S14D	50,0 kg	4x GU10 spot downlight, brass burnished finish
LINHHL180NA	L.180xW.60xH.50 cm	8x S14D	50,0 kg	4x GU10 spot downlight, nickel aged finish
LINHHL180COPBUR	L.180xW.60xH.50 cm	8x S14D	50,0 kg	4x GU10 spot downlight, copper burnished finish

Standard the Linea will be delivered with reflector bars in finish of the lamp.

Technical information

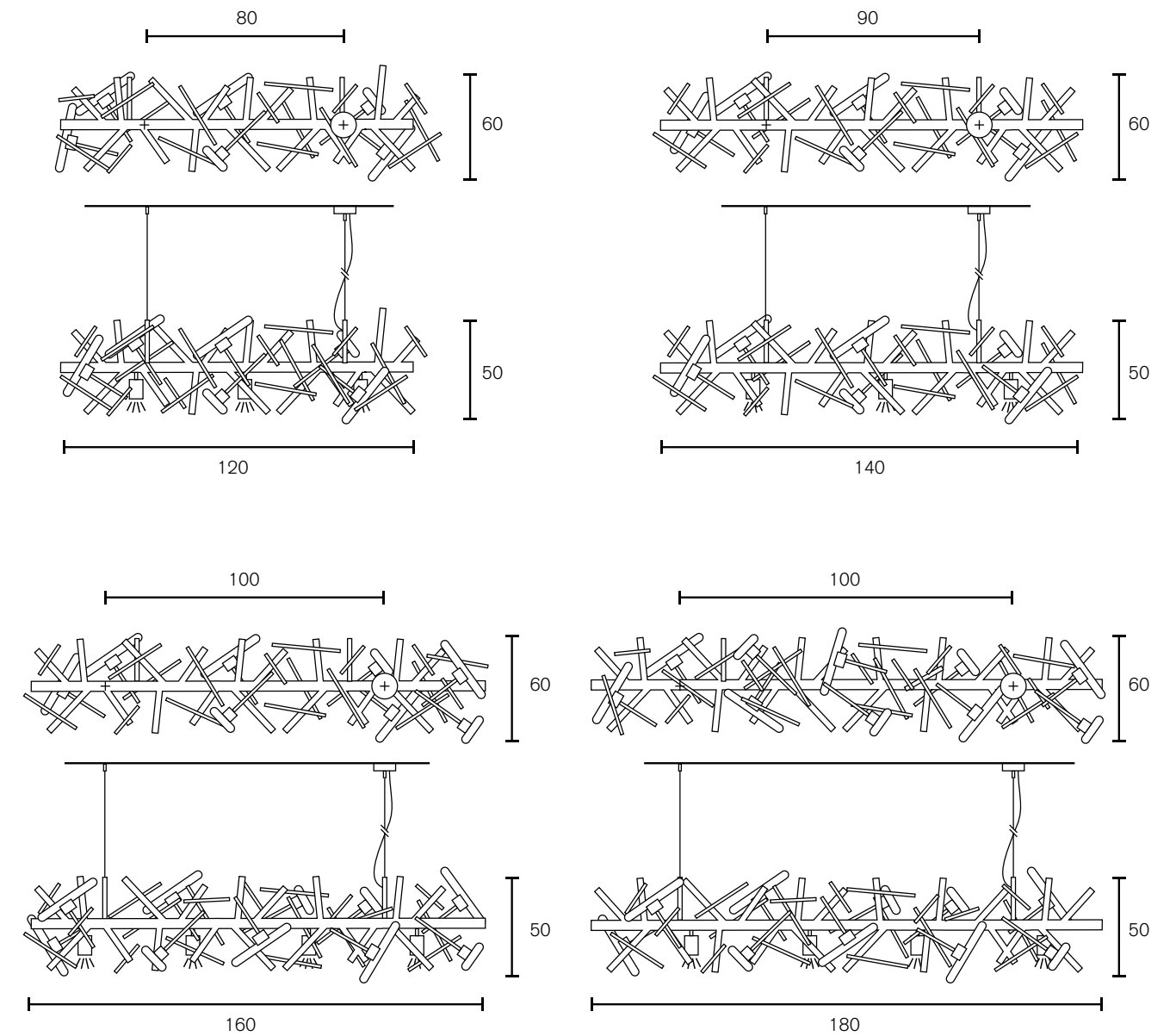

Standard the Linea will be delivered with reflector bars in finish of the lamp.

Technical information

Cieling Lamp Round

Art.nr.	Dimensions	Light bulb	Weight	Finish																																												
LINP60BLM	Ø60xW.45 cm	3x S14D	15,0 kg	black matt finish																																												
LINP60N	Ø60xW.45 cm	3x S14D	15,0 kg	nickel finish																																												
LINP60BR	Ø60xW.45 cm	3x S14D	15,0 kg	brass finish																																												
LINP60BRBUR	Ø60xW.45 cm	3x S14D	15,0 kg	brass burnished finish																																												
LINP60NA	Ø60xW.45 cm	3x S14D	15,0 kg	nickel aged finish																																												
LINP60COPBUR	Ø60xW.45 cm	3x S14D	15,0 kg	copper burnished finish																																												
LINP80BLM	Ø80xW.50 cm	6x S14D	20,0 kg	black matt finish																																												
LINP80N	Ø80xW.50 cm	6x S14D	20,0 kg	nickel finish																																												
LINP80BR	Ø80xW.50 cm	6x S14D	20,0 kg </tr <tr> <td>LINP80BRBUR</td> <td>Ø80xW.50 cm</td> <td>6x S14D</td> <td>20,0 kg</td> <td>brass burnished finish</td> </tr> <tr> <td>LINP80NA</td> <td>Ø80xW.50 cm</td> <td>6x S14D</td> <td>20,0 kg</td> <td>nickel aged finish</td> </tr> <tr> <td>LINP80COPBUR</td> <td>Ø80xW.50 cm</td> <td>6x S14D</td> <td>20,0 kg</td> <td>copper burnished finish</td> </tr> <tr> <td>LINP100BLM</td> <td>Ø100xW.50 cm</td> <td>6x S14D</td> <td>25,0 kg</td> <td>black matt finish</td> </tr> <tr> <td>LINP100N</td> <td>Ø100xW.50 cm</td> <td>6x S14D</td> <td>25,0 kg</td> <td>nickel finish</td> </tr> <tr> <td>LINP100BR</td> <td>Ø100xW.50 cm</td> <td>6x S14D</td> <td>25,0 kg</td> <td>brass finish</td> </tr> <tr> <td>LINP100BRBUR</td> <td>Ø100xW.50 cm</td> <td>6x S14D</td> <td>25,0 kg</td> <td>brass burnished finish</td> </tr> <tr> <td>LINP100NA</td> <td>Ø100xW.50 cm</td> <td>6x S14D</td> <td>25,0 kg</td> <td>nickel aged finish</td> </tr> <tr> <td>LINP100COPBUR</td> <td>Ø100xW.50 cm</td> <td>6x S14D</td> <td>25,0 kg</td> <td>copper burnished finish</td> </tr>	LINP80BRBUR	Ø80xW.50 cm	6x S14D	20,0 kg	brass burnished finish	LINP80NA	Ø80xW.50 cm	6x S14D	20,0 kg	nickel aged finish	LINP80COPBUR	Ø80xW.50 cm	6x S14D	20,0 kg	copper burnished finish	LINP100BLM	Ø100xW.50 cm	6x S14D	25,0 kg	black matt finish	LINP100N	Ø100xW.50 cm	6x S14D	25,0 kg	nickel finish	LINP100BR	Ø100xW.50 cm	6x S14D	25,0 kg	brass finish	LINP100BRBUR	Ø100xW.50 cm	6x S14D	25,0 kg	brass burnished finish	LINP100NA	Ø100xW.50 cm	6x S14D	25,0 kg	nickel aged finish	LINP100COPBUR	Ø100xW.50 cm	6x S14D	25,0 kg	copper burnished finish
LINP80BRBUR	Ø80xW.50 cm	6x S14D	20,0 kg	brass burnished finish																																												
LINP80NA	Ø80xW.50 cm	6x S14D	20,0 kg	nickel aged finish																																												
LINP80COPBUR	Ø80xW.50 cm	6x S14D	20,0 kg	copper burnished finish																																												
LINP100BLM	Ø100xW.50 cm	6x S14D	25,0 kg	black matt finish																																												
LINP100N	Ø100xW.50 cm	6x S14D	25,0 kg	nickel finish																																												
LINP100BR	Ø100xW.50 cm	6x S14D	25,0 kg	brass finish																																												
LINP100BRBUR	Ø100xW.50 cm	6x S14D	25,0 kg	brass burnished finish																																												
LINP100NA	Ø100xW.50 cm	6x S14D	25,0 kg	nickel aged finish																																												
LINP100COPBUR	Ø100xW.50 cm	6x S14D	25,0 kg	copper burnished finish																																												

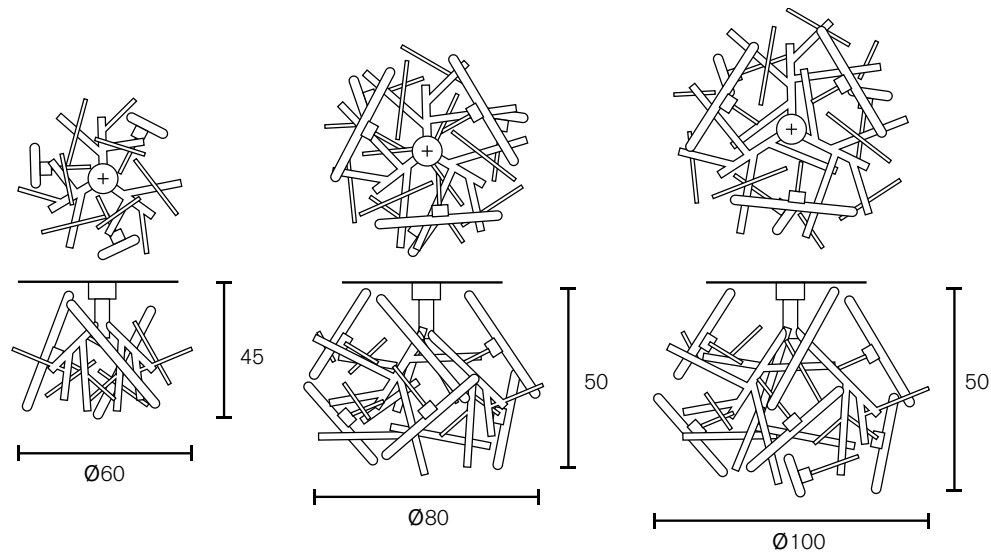

Standard the Linea will be delivered with reflector bars in finish of the lamp.

Technical information

Collection Orpheus 2019

Element

Art.nr.	Dimensions	Light bulb	Weight	Finish
OR30-CANDBRBUR	Ø30xH.57 cm	1x E14	3,0 kg	1x GU10 spot downlight, brass aged finish

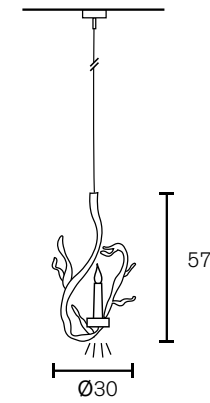

Art Element

Art.nr.	Dimensions	Light bulb	Weight	Finish
ORC35BDP-NYMR	Ø35xH.85 cm	1x GU10	4,0 kg	cast bronze dark patina with Nymphenburg rose
ORC35BDP-AM	Ø35xH.85 cm	1x GU10	4,0 kg	cast bronze dark patina with amethyst
ORC35BDP-PYR	Ø35xH.85 cm	1x GU10	4,0 kg	cast bronze dark patina with pyrite

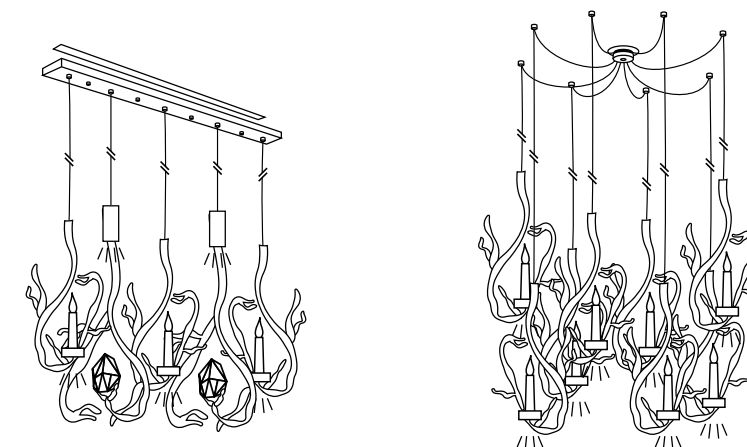
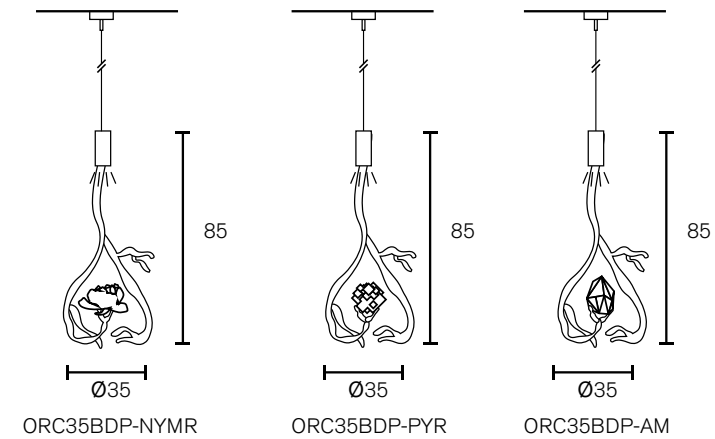

Technical information

Collection Kelp 2015

Element

Art.nr.	Dimensions	Light bulb	Weight	Finish
25KELPBLM	L.25xW.25xH.35 cm	1x E14	1,5 kg	black matt finish
25KELPWM	L.25xW.25xH.35 cm	1x E14	1,5 kg	white matt finish
25KELPB	L.25xW.25xH.35 cm	1x E14	1,5 kg	bronze finish
25KELPST	L.25xW.25xH.35 cm	1x E14	1,5 kg	stainless steel
25KELPBR	L.25xW.25xH.35 cm	1x E14	1,5 kg	brass finish
25KELPBRA	L.25xW.25xH.35 cm	1x E14	1,5 kg	brass aged finish
25KELPBRG	L.25xW.25xH.35 cm	1x E14	1,5 kg	brass grinded finish
25KELPBRBUR	L.25xW.25xH.35 cm	1x E14	1,5 kg	brass burnished finish
25KELPCOP	L.25xW.25xH.35 cm	1x E14	1,5 kg	copper finish
50KELPBLM	L.40xW.40xH.50 cm	1x E14	2,0 kg	black matt finish
50KELPWM	L.40xW.40xH.50 cm	1x E14	2,0 kg	white matt finish
50KELPB	L.40xW.40xH.50 cm	1x E14	2,0 kg	bronze finish
50KELPST	L.40xW.40xH.50 cm	1x E14	2,0 kg	stainless steel
50KELPBR	L.40xW.40xH.50 cm	1x E14	2,0 kg	brass finish
50KELPBRA	L.40xW.40xH.50 cm	1x E14	2,0 kg	brass aged finish
50KELPBRG	L.40xW.40xH.50 cm	1x E14	2,0 kg	brass grinded finish
50KELPBRBUR	L.40xW.40xH.50 cm	1x E14	2,0 kg	brass burnished finish
50KELPCOP	L.40xW.40xH.50 cm	1x E14	2,0 kg	copper finish
100KELPBLM	L.80xW.100xH.80 cm	5x E14	15,0 kg	black matt finish
100KELPWM	L.80xW.100xH.80 cm	5x E14	15,0 kg	white matt finish
100KELPB	L.80xW.100xH.80 cm	5x E14	15,0 kg	bronze finish
100KELPST	L.80xW.100xH.80 cm	5x E14	15,0 kg	stainless steel
100KELPBR	L.80xW.100xH.80 cm	5x E14	15,0 kg	brass finish
100KELPBRA	L.80xW.100xH.80 cm	5x E14	15,0 kg	brass aged finish
100KELPBRG	L.80xW.100xH.80 cm	5x E14	15,0 kg	brass grinded finish
100KELPBRBUR	L.80xW.100xH.80 cm	5x E14	15,0 kg	brass burnished finish
100KELPCOP	L.80xW.100xH.80 cm	5x E14	15,0 kg	copper finish
150KELPBLM	L.150xW.150xH.150 cm	10x E14	25,0 kg	black matt finish
150KELPWM	L.150xW.150xH.150 cm	10x E14	25,0 kg	white matt finish
150KELPB	L.150xW.150xH.150 cm	10x E14	25,0 kg	bronze finish
150KELPST	L.150xW.150xH.150 cm	10x E14	25,0 kg	stainless steel
150KELPBR	L.150xW.150xH.150 cm	10x E14	25,0 kg	brass finish
150KELPBRA	L.150xW.150xH.150 cm	10x E14	25,0 kg	brass aged finish
150KELPBRG	L.150xW.150xH.150 cm	10x E14	25,0 kg	brass grinded finish
150KELPBRBUR	L.150xW.150xH.150 cm	10x E14	25,0 kg	brass burnished finish
150KELPCOP	L.150xW.150xH.150 cm	10x E14	25,0 kg	copper finish

Technical information

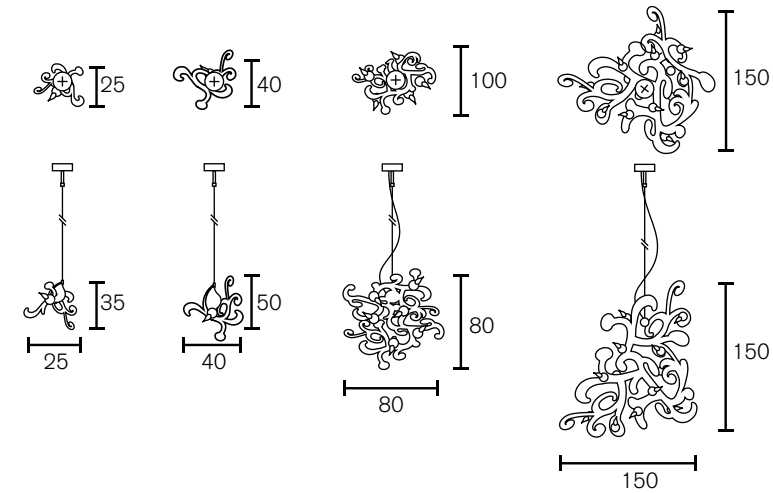

central ceiling cover (=standard)

Satellite (for special and slope roof etc)

Disc suspension with mounting frame

Beam for inline suspension

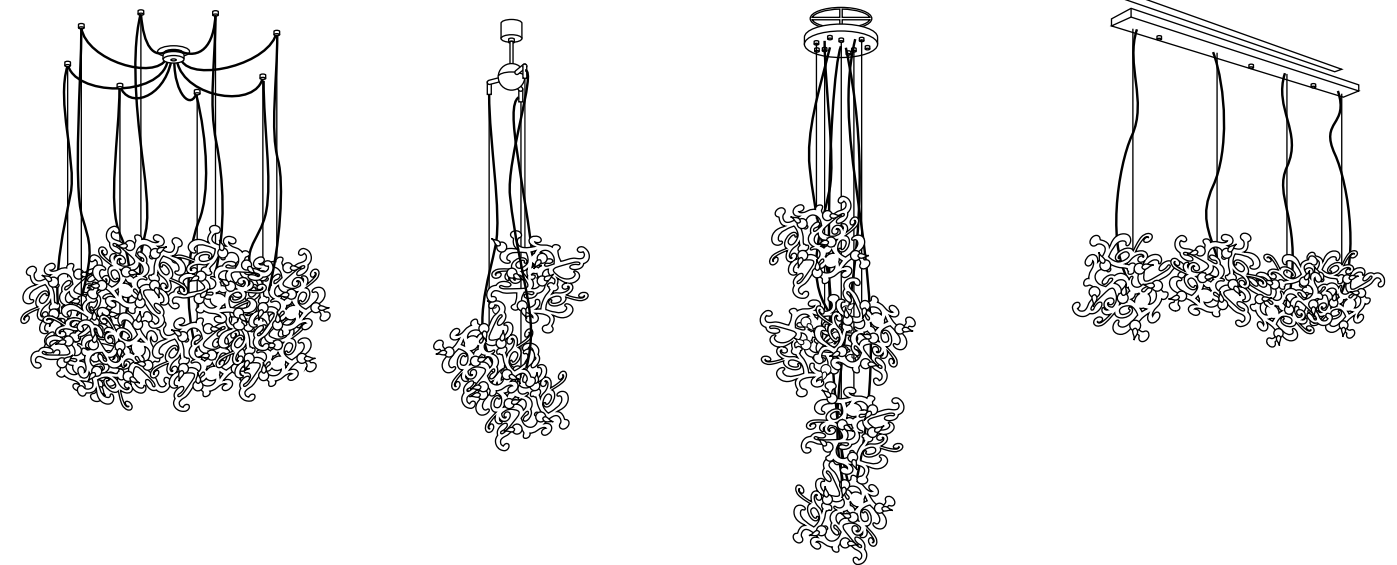

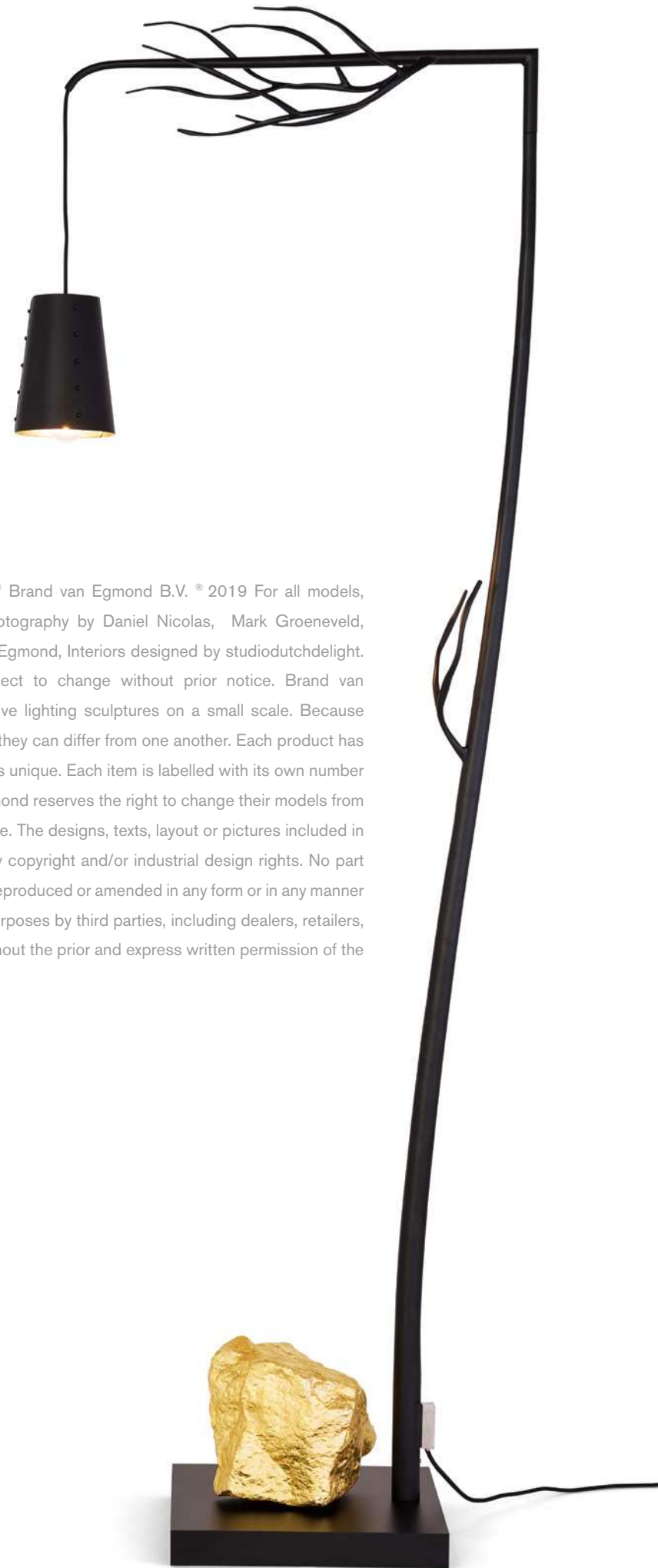

All rights reserved, copyright® Brand van Egmond B.V. © 2019 For all models, texts, layout and images. Photography by Daniel Nicolas, Mark Groeneveld, Fardid Khadem and BrandvanEgmond, Interiors designed by studiodutchdelight.com. Specifications are subject to change without prior notice. Brand van Egmond manufactures exclusive lighting sculptures on a small scale. Because their products are handmade, they can differ from one another. Each product has its own identity and therefore is unique. Each item is labelled with its own number and certificate. Brand van Egmond reserves the right to change their models from time to time without prior notice. The designs, texts, layout or pictures included in this brochure are protected by copyright and/or industrial design rights. No part there of may be made public, reproduced or amended in any form or in any manner whatsoever, for commercial purposes by third parties, including dealers, retailers, internet shops and others, without the prior and express written permission of the designer William Brand.



BRAND VAN EGMOND B.V. Nikkelstraat 41, 1411 AH Naarden, The Netherlands

T. +31 (0)35 692 12 59 F. +31 (0)35 691 17 25 info@brandvanegmond.com www.brandvanegmond.com