

BROKIS® CATALOGUE

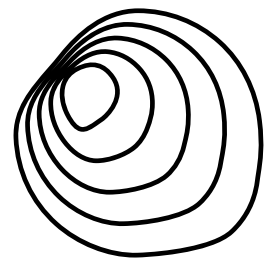

A TRADITIONALLY CRAFTED
CONTEMPORARY VISION OF LIGHT

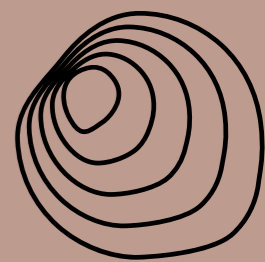

BROKIS®

BROKIS



BROKIS – a synthesis of exquisite design, superior quality, and the skill of master artisans continuing the centuries-old Bohemian glassmaking tradition. BROKIS lighting collections have achieved international acclaim by combining handblown glass with other refined materials, such as handcrafted wood and metal, in bold compositions that push

the boundaries not only of contemporary lighting design but of the technologies applied in production. The family-run premium brand works with select designers from around the world and operates its own historical glassworks southeast of Prague. Each BROKIS light is a genuine original, a functional work of art as captivating by day as it is by night.



BROKIS is the brainchild of successful Czech entrepreneur Jan Rabell. In 2006, he founded the brand as a platform to revitalize and elevate Bohemian glassmaking to new heights and preserve generations of knowledge and craftsmanship. Nearly ten years prior, in 1997, he acquired the ailing Janštejn Glassworks, which was established at the start of the 19th century approximately 140 kilometres southeast of Prague. Demand for traditional products had declined significantly, many of the glassmakers were growing old and leaving, and time-honoured technologies and techniques were at risk of being lost. Mr. Rabell's vision was to restore the factory to its former prestige and ensure that the ages-old Bohemian glassmaking tradition endured into the 21st century.

With BROKIS, Jan Rabell created a lighting brand offering entirely different products than those previously produced at Janštejn Glassworks. Several new Italian-style furnaces were built, and production techniques were refined. Some, such as grinding and glass painting, were discontinued, and others were revived, like glassblowing using optic moulds and traditional hotshop techniques. Original and nearly forgotten formulas for manufacturing coloured glass were reinstated and are now characteristic of the BROKIS brand.

BROKIS has firmly established itself as a leading innovator in glass lighting. For example, the complex technology applied in manufacturing the Night Birds collection, which consists of imposing yet elegant curved glass silhouettes of birds in various phases of flight, required two years of experimentation to perfect.

BROKIS is constantly developing new technologies for its lights in order to offer consistent industry-leading quality and innovation throughout its global product portfolio, such as with a special original connector, the sustainable material called BROKISGLASS, and TRIMLESS, a sleek new system for hanging pendant lights from lowered drywall ceilings.

BROKIS also maintains a strong online presence through a series of innovative initiatives, such as BROKIS VIRTUAL PROJECTS and the unique MyBrokis application. In January of 2022, BROKIS launched a website within Janštejn Glass Group (JGG).

Today, BROKIS and Janštejn Glassworks employ more than 100 people and enjoy a unique symbiosis that has allowed BROKIS to establish sales operations in 120 countries and regularly showcase its renowned lighting collections at the world's top design shows.

PRESERVING THE BOHEMIAN GLASSBLOWING TRADITION

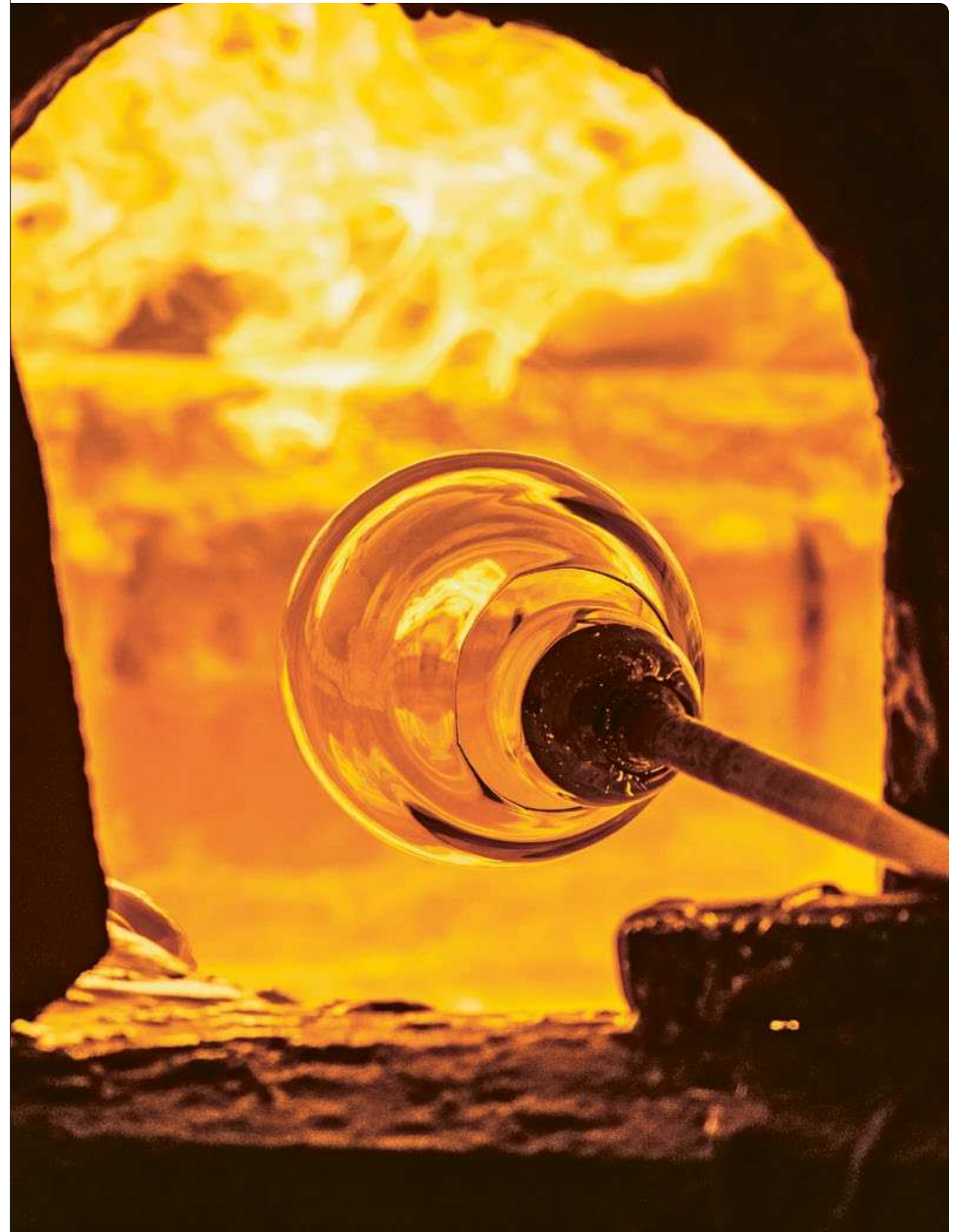

JANŠTEJN GLASSWORKS

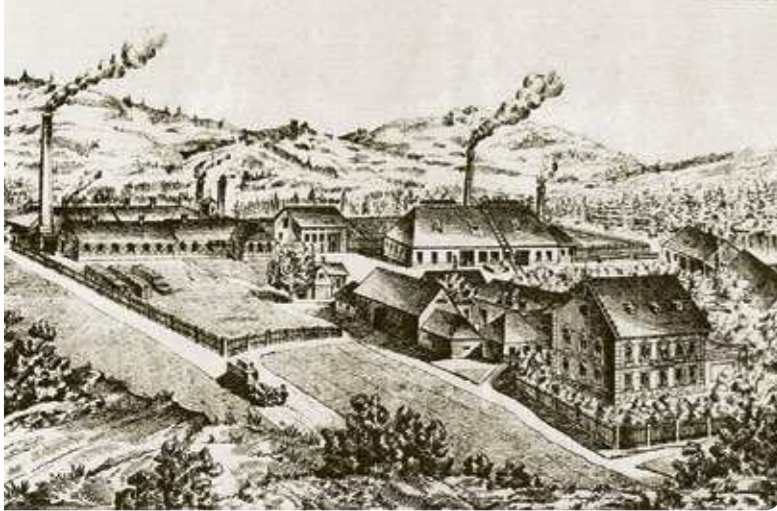

For more than 200 years, Janštejn Glassworks, situated in Bohemia's picturesque Vysočina Region, has upheld a glassblowing tradition that dates to the end of the 17th century. Founded in 1809 near the village of Horní Dubenky, the factory and generations of tenacious craftspeople employed by it

have enjoyed periods of prosperity yet have also endured much hardship, with three devastating fires, two world wars, and nationalization among their greatest challenges. Today, Janštejn Glassworks is the largest producer of specialty lighting glass in the Czech Republic.

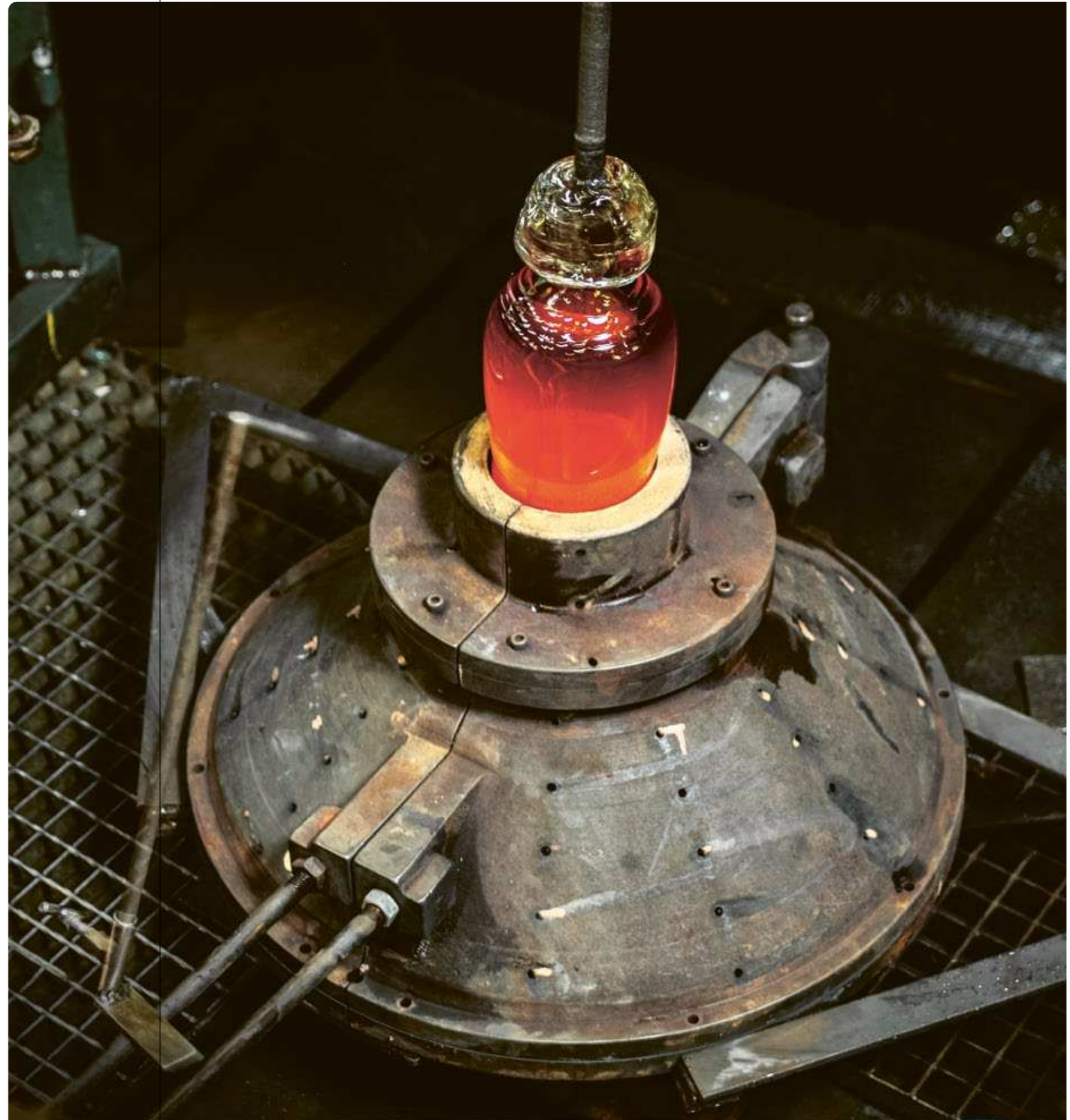

Entrepreneur Jan Rabell is one of the most dynamic figures in the Czech Republic's glassmaking industry. Born in Prague in 1965 to a Puerto Rican father and Czech mother, he grew up in his father's homeland, later returning to Prague to pursue a master's degree in economics. He went on to hold various managing director posts in the field of finance and banking. In 1997, he purchased the ailing Janštejn Glassworks and set about restoring its prestige

and competitiveness primarily by introducing unconventional glassblowing techniques and production technologies. In 2006, he founded the family-run premium glass lighting brand BROKIS, quickly developing it into one of the most important players in the market and exporting its products around the world. Mr Rabell's charisma, energy, and innovative vision continue to propel BROKIS and Janštejn Glassworks steadily forward.



**“NOTHING’S IMPOSSIBLE;
NEVER SAY IT CAN’T BE DONE.”**

PEOPLE: JAN RABELL

BROKIS art director Lucie Koldova is an acclaimed Czech product and furniture designer. Her collaboration with the lighting brand began in 2010 with the timeless Muffins and Balloons collections, which she designed while living and working in Paris. The voluminous glass lights embody her charismatic, elegant style and quickly established BROKIS as an innovative producer of handblown glass lighting. She is the creative force behind the brand and is instrumental in shaping its product portfolio and image.

Her creations, objects of desire, include glass sculptures, glass lighting, poetic gallery pieces, and limited-series works. Breathtaking colours, unusual proportions, and vibrant formal contrasts move her work seemingly beyond the realm of the possible, a trademark at once apparent in lighting collections such as Balloons, Macaron, Puro, and Ivy. In addition to developing ever-more novel and exciting motifs, Lucie Koldova has introduced important technological and formal solutions that have enabled BROKIS to push the limits of handblown glass production.

PEOPLE: LUCIE KOLDOVA



“I SEE A LIGHT AS A SCULPTURE – AN OBJECT RADIATING ENERGY. I SHAPE THE ENERGY OF LIGHT THROUGH THE RELATIONSHIP BETWEEN THE SOURCE AND THE GLASS.”

SUSTAINABILITY



In terms of ecology, BROKIS has come a long way since it was established in 2010. The BROKISGLASS project was established to reuse waste glass through recycling. Arising from the ecological manufacturing practices of Janštejn Glassworks and BROKIS, it resulted in the creation of an innovative material made of glass shards discarded in the manufacture of BROKIS glass lighting collections. The project currently produces ten tons of new flat glass each week.

BROKISGLASS has brought about a significant reduction in waste material. The transformation of these shards into a new decorative product represents an environmentally friendly and efficient upcycling of material, thanks to which the glassworks

is able to employ a strategic circular economy and thus contribute to the cultivation of a healthy relationship between nature and humans. The next step involves procedures for new glass blends that can be added to other materials, such as concrete, in order to achieve 100% reuse of waste glass shards. These materials are already being applied in the new Overlay collection.

BROKISGLASS makes use of discarded glass while reducing the brand's environmental impact and providing a highly distinctive aesthetic element with endless possibilities for lighting design and architecture.



To show you just how remarkable BROKIS lighting collections really are, we've created three amazing virtual projects. The year 2021 saw the launch of our acclaimed virtual villa, and at the beginning of 2022 we introduced our virtual boutique hotel. These were followed in the autumn of 2022 by a new project called virtual office.

The virtual villa offers architects, interior designers, and end customers a unique opportunity to view the majority of our collections under one roof, in a single villa featuring refined and timeless interiors. During the tour of the villa, which spans more than 900 virtual square metres across eight rooms and two outdoor terraces, you'll discover more than 15 perspectives, each providing a detailed view of the unique lighting compositions, including closeups of individual lights and possible combinations and colour options together with a summary of the most important information for each collection.

The virtual boutique hotel features not only the most popular collections in the BROKIS portfolio but also the latest ones. The grand scale of the virtual space makes it possible to combine conventional lights with our highly popular battery-powered lights. In the virtual boutique hotel, there are luxury suites,

a restaurant, a bar, and an outdoor terrace with swimming pool. The premises of the hotel are expansive, so there is plenty of room to let your imagination run free. Our lighting collections are showcased in 14 extraordinary scenes, each of which beckons visitors to dream big.

The latest virtual project features offices situated in New York in a Manhattan high-rise. The virtual space occupies an impressive 1,200 m². The BROKIS lighting collections lend a strong character to the space, helping to create a warm and friendly environment anchored firmly within a distinctive architectonic office setting. The lights combine with the colours of each room, creating contrasts and maintaining a ton sur ton palette that enhances and embraces the surrounding architecture while accentuating the beauty of the new BROKIS collections.

The intensity of the light of the individual collections is based on photometric measurements (LDT files) to ensure the virtual rendering is as realistic as possible. Walk around. Linger for a while at a spot that especially catches your imagination. Do a bit of day-dreaming. Light and art exist to evoke emotion in us. Indulge in the experience.



VIRTUAL PROJECTS



BROKIS DESIGN BY

LUCIE KOLDOVA

DAN YEFFET

BORIS KLIMEK

CHIARAMONTE MARIN

FUMIE SHIBATA

LENKA DAMOVÁ

VRTIŠKA & ŽÁK

LCM MARIN DESIGN STUDIO

FEDERICO PERI

FILIPPO MAMBRETTI

**INTERIOR
LIGHTS**

MUFFINS



The timeless Muffins collection represents an extraordinary lighting experience. Since its market debut, it has taken on an iconic status and become a symbol of the BROKIS brand. The sublimity of the design lies in the masterful combination of delicately contoured glass and solid wood. The lights, featuring a billowing glass shade set in a handcrafted wood

DESIGN

base together with a naked filament bulb, breathe new life into any space and elicit a festive ambience. The collection offers multiple shape and size variants as well as a broad palette of glass colours and woods. To celebrate ten years since the introduction of Muffins, a special anniversary edition was created in 2020 featuring marble and different colours of glass.

LUCIE KOLDOVA, DAN YEFFET









BALLOONS



Balloons, a collection of timeless lights embodying rudimentary forms that evoke images of hot-air balloons, captivates with the beauty of large-format handblown glass and an elegant metal reflector hovering within. The design's charm lies in the use of two independent glass sections to achieve the impression of an integral whole. Lavish proportions and an elegant hand-pressed metal reflector are the collection's

defining traits. The size of the largest shade pushes the very boundaries of glassblowing technology and illustrates the exceptional skill and craftsmanship of Bohemian glassmakers. The Balloons collection is one of the pillars of the BROKIS portfolio. The lights come in three sizes. Balloons also make an outstanding sculptural statement during the day when they are switched off.

DESIGN

LUCIE KOLDOVA, DAN YEFFET









The Shadows collection is a take on the famed, timeless lights found in French ateliers, and its typology pays tribute to that legacy. The combination of hand-blown glass, handcrafted wood, and classic shaping has given rise to a light of ageless elegance. The collection comprises four different suspension lights, as striking alone as they are in sets, characterized by a handblown glass shade set upon on a handcrafted wooden fixture. The clean contours and finish are accentuated by the concealed light source. The Shadows collection is special not only for its wide spectrum of glass colour options, surface finishes,

DESIGN

and types of wood but also because the lights can be combined in sets according to customer requirements. They are intended for interiors and, thanks to multiple combination possibilities, are well suited to a broad range of installations. The contours of the Shadows XL collection stay true to the original Shadows collection but are nearly 50% bolder in their proportions. There is also an outdoor version for installation in exterior settings. All the Shadows collections have special integrated connectors developed by BROKIS to facilitate installation and cleaning.

LUCIE KOLDOVA, DAN YEFFET



SHADOWS









MEMORY

The Memory collection awakens the imagination and beckons back to a carefree childhood. The wall and ceiling versions in different sizes, the wide range of colour options, and a selection of finishes give this lighting experience a large degree of versatility. The illusion of inflated balloons is flawless right down to the dangling string, which serves to switch

the light on and off. This is beauty in its simplest and most persuasive form. The Memory collection consists of ceiling and wall versions in three sizes. There are also sets that allow multiple lights to be combined on a single ceiling canopy. New colours and shapes are now available in celebration of the collection's ten-year anniversary.

DESIGN

BORIS KLIMEK









Capsula is a sophisticated and exhilarating light bearing resemblance to a plant cell or seed. The nucleus of the piece is a tubular triplex-glass LED light source, developed by BROKIS, that transects the inner shade and translucent external shell to form a notional axis. The layering and overlapping of these three distinct components give rise to dramatic 3D optical effects. The end caps fasten the components together and serve as anchor points for the creative

DESIGN

dual suspension straps, which also conceal the power cable and allow for variation in the final positioning of the light. The Capsula collection is offered in sets as well as individual lights that can be combined per customer requirements.

From spring 2018, Capsula is fitted with special integrated connectors developed by BROKIS to facilitate installation and cleaning.

LUCIE KOLDOVA



CAPSULA









The Mona collection is based on the concept of penetrating forms. The light source boldly traverses the ample volume of smooth handblown glass to reveal the thrilling tension inherent in the design. The collection's essence, however, lies in its unconventional construction and refined combination of materials. It also boasts dimmable tubular LED light sources, developed by BROKIS, each with a different colour temperature. The entire Mona family has been

DESIGN

technologically improved with innovative connectors and the replacement of the wood components with metal ones. These improvements make it easier to change out the light source and clean the lights. The wall variant is dimmable via an integrated dimmer in the lower part of the metal fixture, and the table variant offers touch dimming. The collection comprises several sizes (S, M, L, XL) and various types of lights (pendant, floor, table, wall).

LUCIE KOLDOVA



MONA













The Whistle collection is, quite literally, a living reference to the work of glassmakers, as inspiration for the design was taken from the blowpipe, which in Czech is known as a glassmaker's whistle. The lucid body of the piece traces the silhouette of a cone of light, and a distinct spotlight with hand-pressed metal shield constitutes its imaginary heart. The overall shape and the naked cable winding its way up

DESIGN

through the body of the light define the character of its simplistic technical form. The collection comprises a suspension light in two sizes as well as a set of three lights.

From March 2018, Whistle is fitted with special integrated connectors developed by BROKIS to facilitate installation and cleaning.

LUCIE KOLDOVA



WHISTLE













NIGHT BIRDS



Inspired by the abandon and freedom of bird flight, the innovative Night Birds suspension lights impart poetic enchantment and unparalleled dynamism to any interior. Night Birds differ from the other collections in the unique technology applied in production, which involves melting glass into a mould and then bending it. The process makes it possible to instil delicate nuances in the shape of the wings and achieve a coloration of the glass that is different and wholly unique each time. The collection's

restraint and directness are underscored by the minimalist LED light source set in a fixture of lacquered and polished aluminium. The Night Birds collection comprises three lights with different wing attitudes depicting the various phases of bird flight. The lights come in white or dark glass as well as in BROKISGLASS, and there is also an outdoor variant. Night Birds work best in large flocks. The metal components are also available in a black anodized finish.

DESIGN

BORIS KLIMEK





LIGHTLINE



In its every component, the Lightline collection is a celebration of glass as an artistic medium. The concept of a line of light is rooted in the varying characteristics of the material and its forms. The design employs the effect of light uniformly dispersed over a sandblasted surface, which in profile creates the impression of a luminous line.

DESIGN

The LED light source is embedded in the base beneath a metal and triplex opal glass shroud. The upper surface, sandblasted by hand, is treated with a special nano coating to prevent the accumulation of dust and smudges. The collection comprises four table lamps that cast a light of intimate character.

LUCIE KOLDOVA









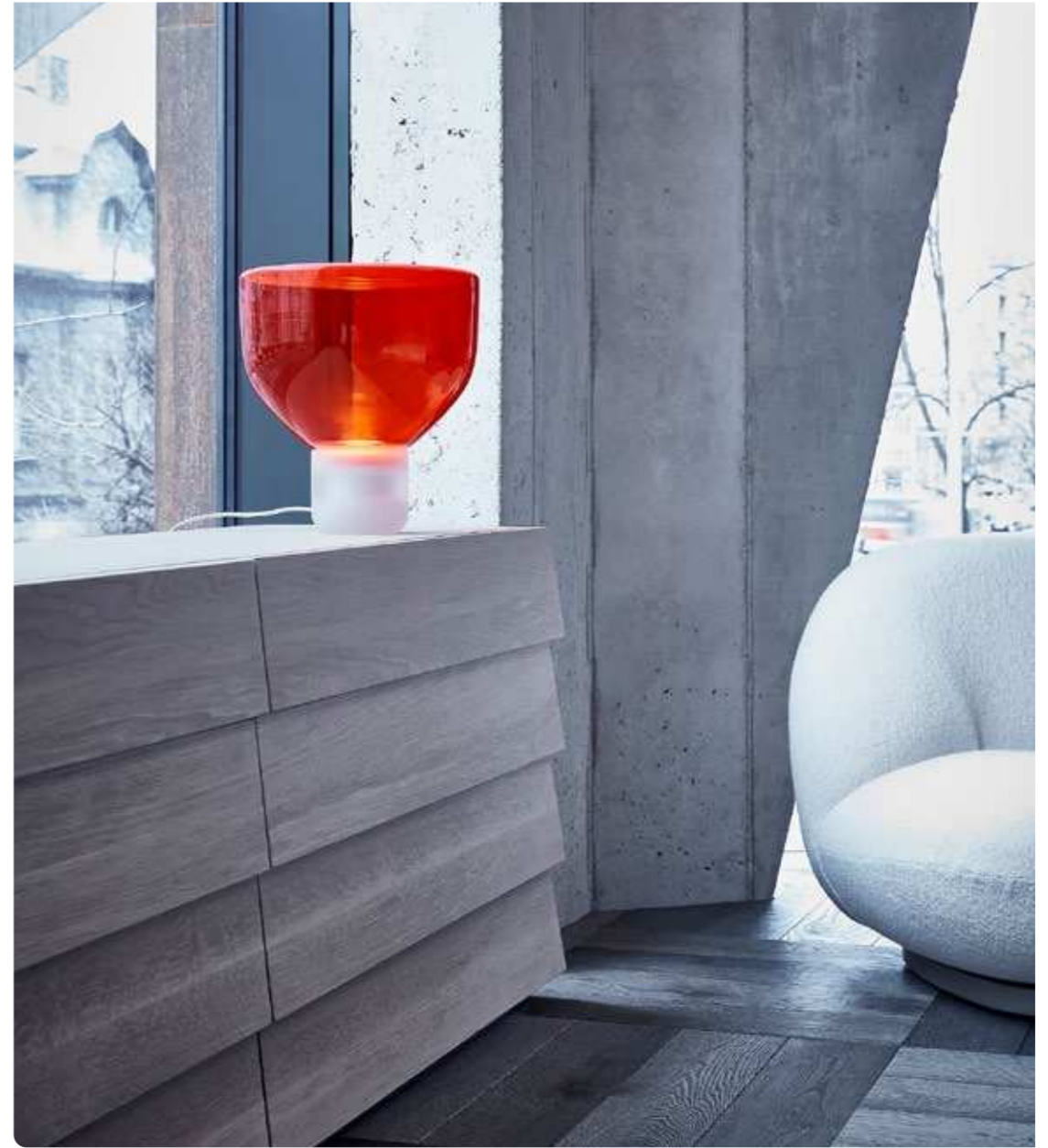

Knot, a collection of stately pendent lights, contrasts two dissimilar materials, two dissimilar notions: gentle curves in clear handblown glass against the austerity of coarse rope. The resulting design is striking, forthright, and dignified at the same time.

Full-bodied globes of varying shapes and sizes are penetrated by robust rope ending in the core design element of the collection – the knot – which seemingly pulls the bottom of the glass inward for a bemusing plastic effect. The LED light source is

mounted beneath an elegant hood made of stamped metal and protected from below by a handblown triplex opal diffuser. Another metal component serves to cap the end of the rope. The collection comprises lights of four different shapes in two sizes with a variety of colour options. There's also a romantic table light, which is now available in a version for exterior use as well. Now the metal components are available in an optional white powder finish.

DESIGN

CHIARAMONTE MARIN



KNOT











PURO



Puro is a boldly minimalistic variation on atmospheric pendent lights. Inspiration for the collection and its name come from the Spanish word for “cigar”, which also means “pure” and is a reference to the composition’s clean lines. The original design in the Puro collection creates an intriguing interplay between horizontal and vertical luminous cigar tubes levitating in space above simple bell lights. The diffused glow of the tubes combines with that of the bells to elicit a dynamic ambience, while the alternating gloss and matte finishes provide a degree of provocation. The first variations to appear were a bell light suspended beneath a single vertical tube and dual bell

lights suspended beneath a single horizontal tube. Multiple tubes can be combined to create amazing installations, such as a screen to divide space and evoke an intimate atmosphere bordering on scenography. The endless variability of the Puro collection gives rise to new lighting objects for any interior. The Puro family – Solo, Single, Spotlight, Eclectic, Contour, Sparkle, and Floor – is available in various sizes in either matte triplex opal or smoke grey glass. Puro have special integrated connectors developed by BROKIS for improved variability and ease of installation and cleaning.

DESIGN

LUCIE KOLDOVA











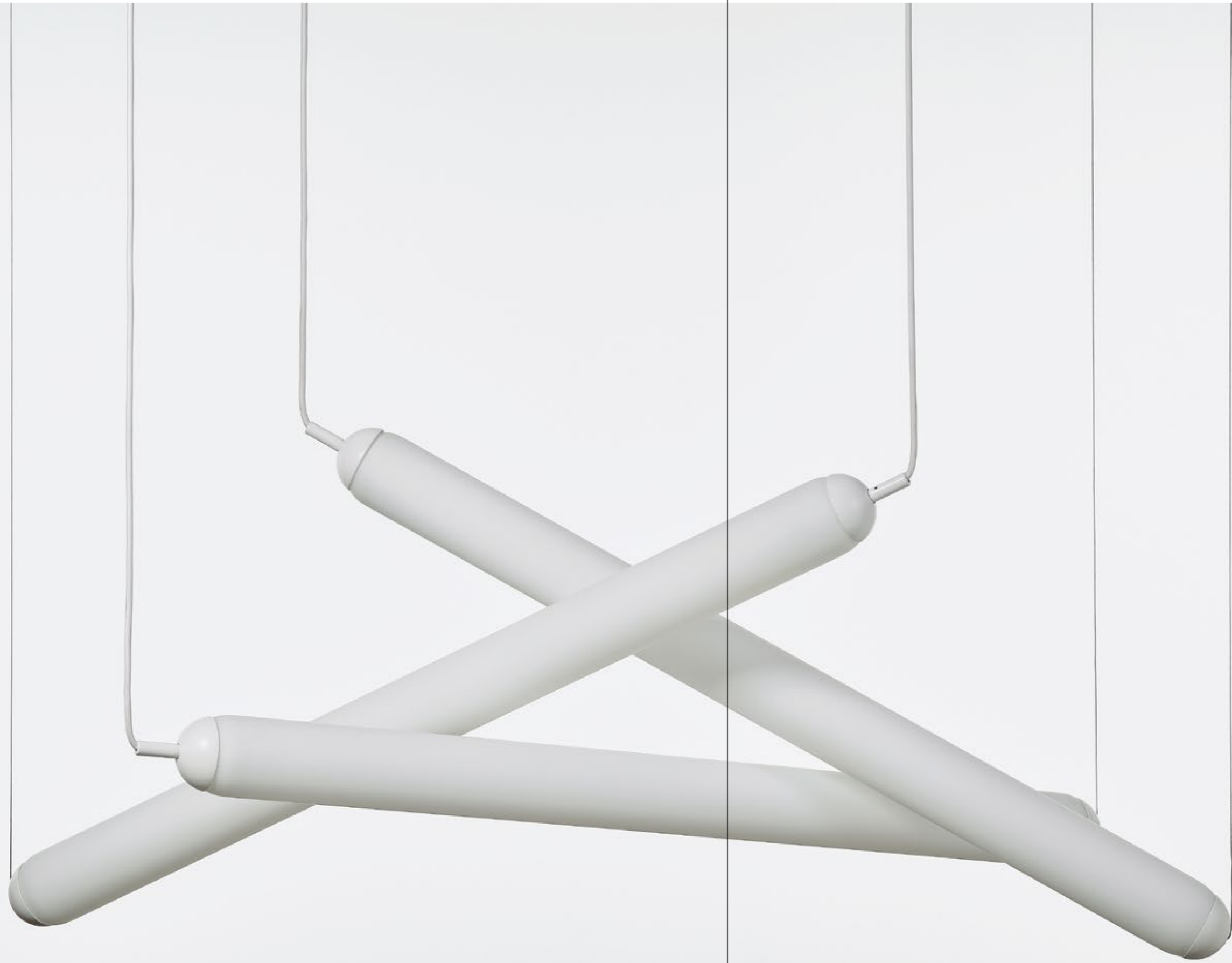





MACARON



The Macaron table light pays homage to the beauty and complex structures of crystalline stone. Enclosed in opposing domes of delicate handblown glass, the stone becomes a moonscape afloat in its own cosmos. The light source casts its glow upward from the onyx base to energize the meandering chalcedony veins in the centre onyx plate and create a subtle and mesmerizing lighting effect. The concept is based on the principle of illuminating stone, and the name refers to the light's similarity in shape to the famed French meringue confection. Natural imperfections in the glass and the diversity

of structures in the stone make each light a unique original. The purity of the natural materials and the artisanship applied in processing them have given rise to a light of extraordinary ambience. Produced using traditional techniques, Macaron is characteristic of the distinctive and enduring aesthetic of the BROKIS brand. Macaron comes in three sizes – the largest of which also makes an attractive floor light – and in several glass colour options with either white or honey onyx. The collection offers an alternate version featuring a centre plate made of BROKISGLASS in combination with a wooden base.

DESIGN

LUCIE KOLDOVA





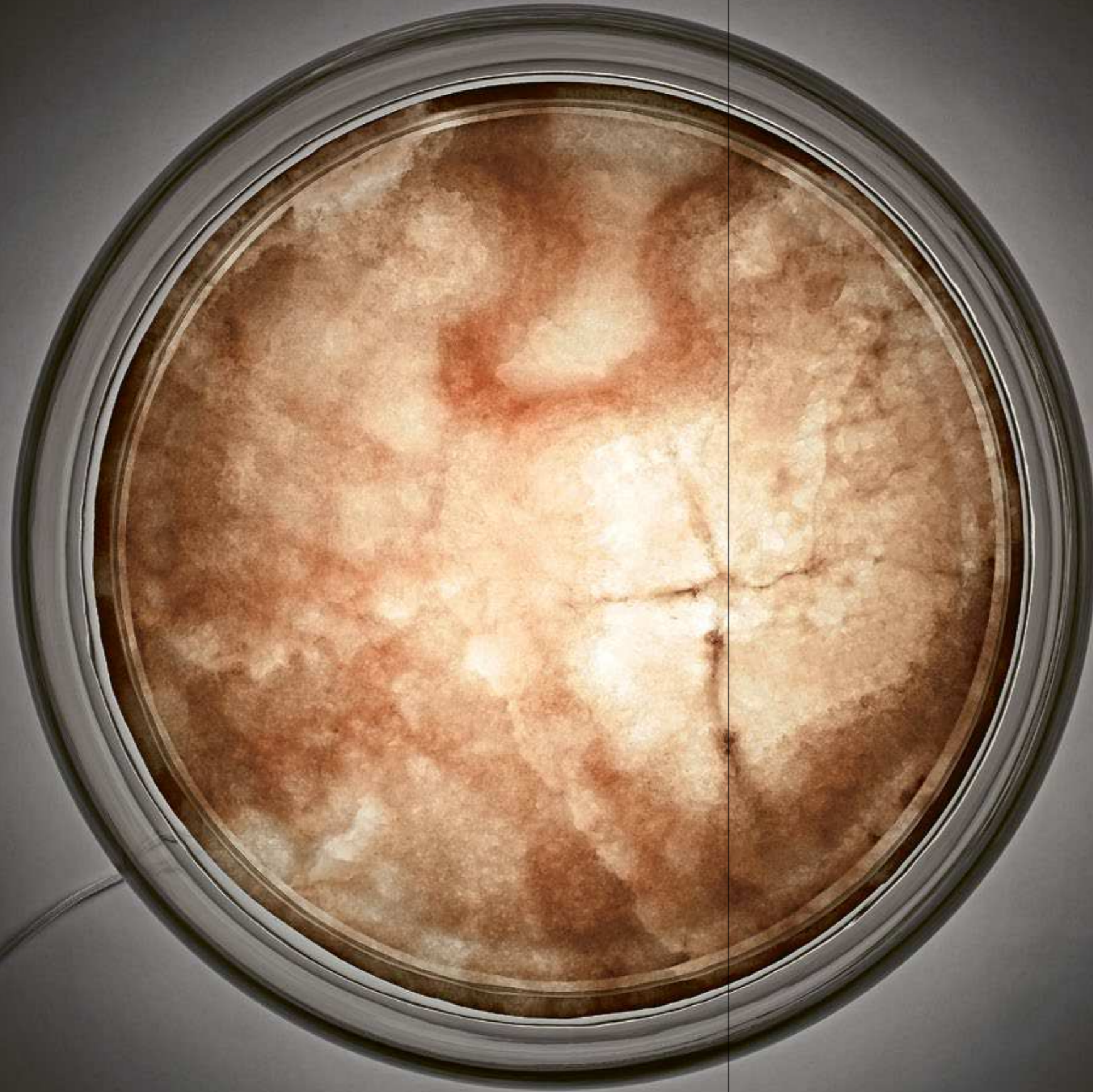



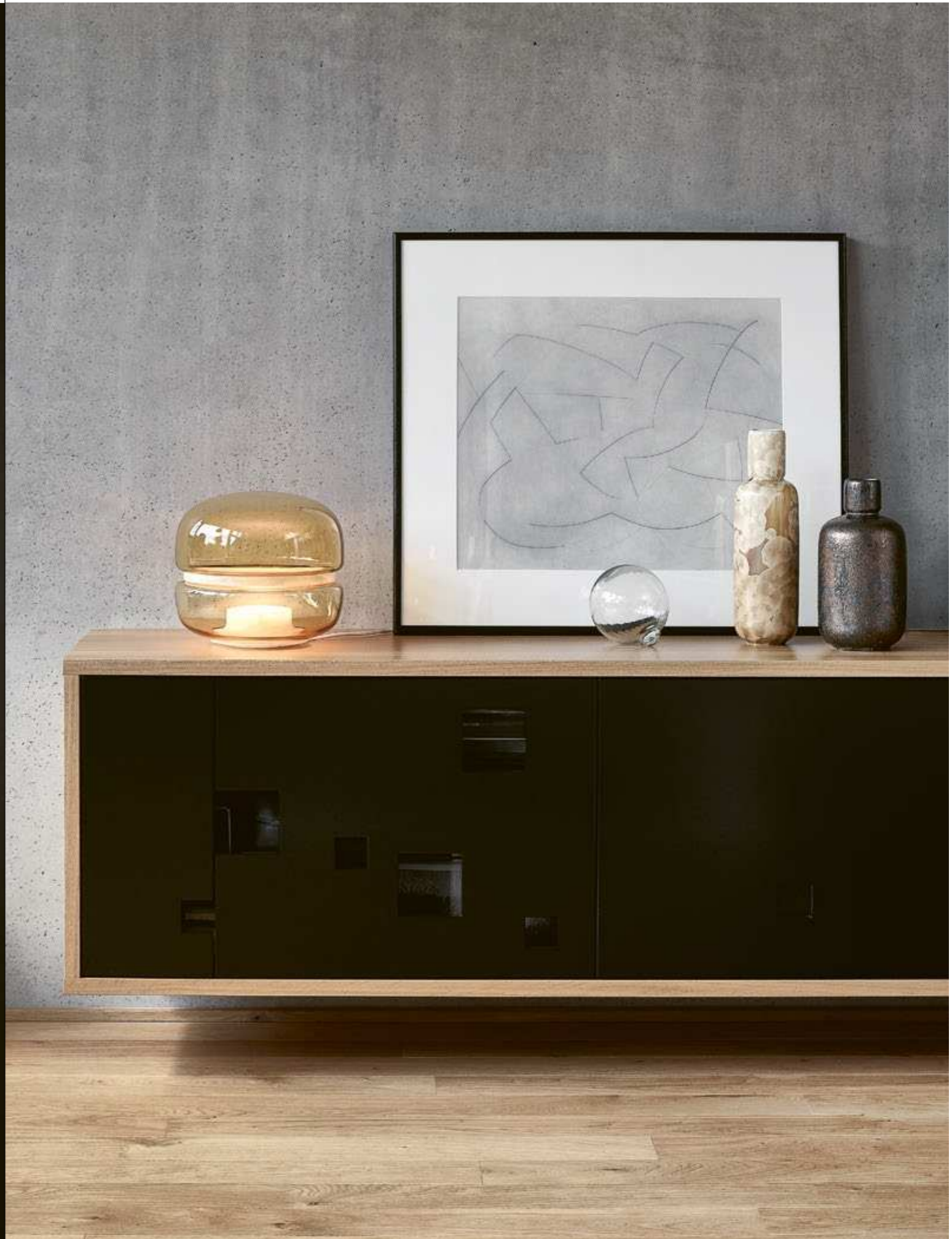



JACK O'LANtern

Light as a jewel of the home. A functional object in aesthetic elation, a sentinel of the evening and the night. The subtle levitating metal frame bears good tidings and a luminous pearl in the form of a handblown matte sphere. With inspiration taken from the carved pumpkin, Lucie Koldova's concept shows the way and becomes a building block in the house of light, beckoning passers-by to enter. This subtle and geometrically balanced light offers a wide variety of combinations. It can be hung

DESIGN

separately or in vertical lighting arrangements. In addition to the suspension variant, there is also a wall composition comprising five frames joined in a single module for up to five glass spheres, which rely on nothing more than gravity to stay in place. The table version combines the beauty of handblown acid-etched glass in smoke grey, light pink, or triplex opal with a metal frame and marble base. Sizes and versions: Wall (small), Pendant and Table (small and large).

LUCIE KOLDOVA











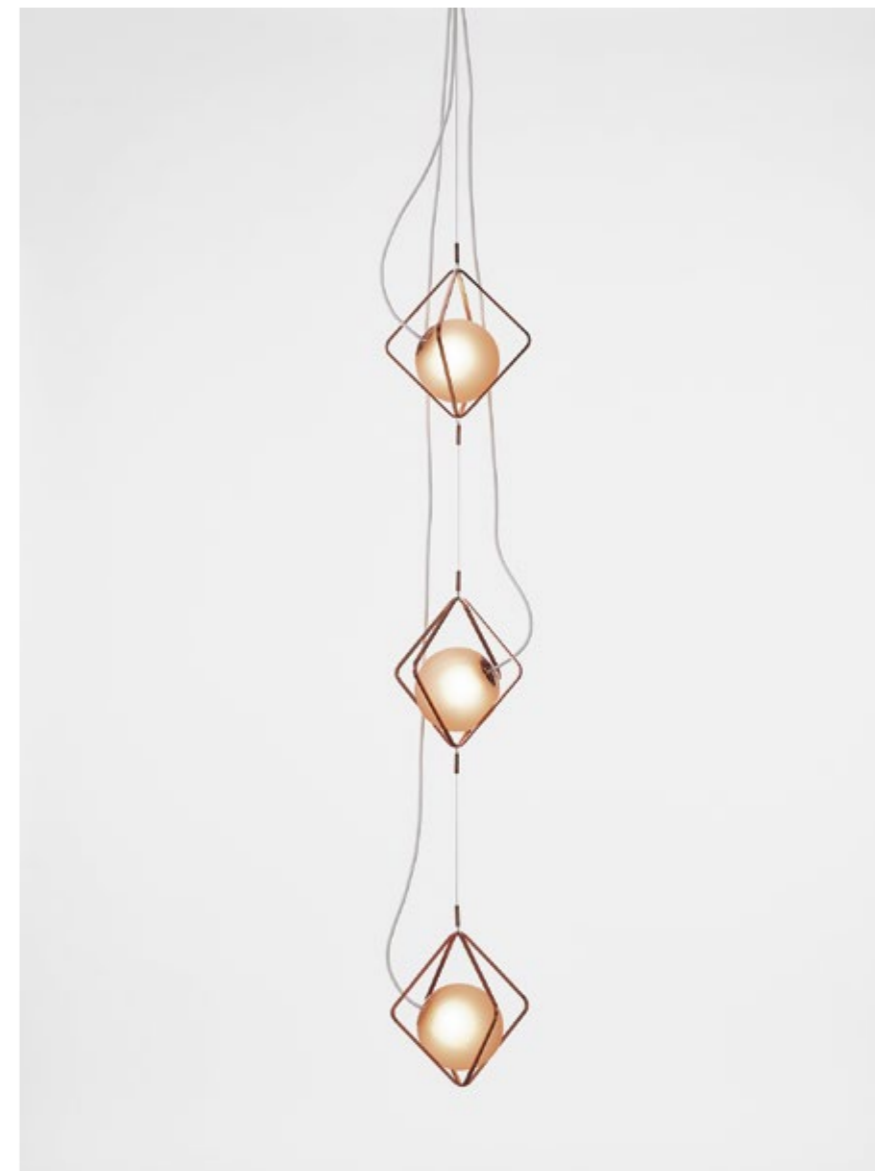
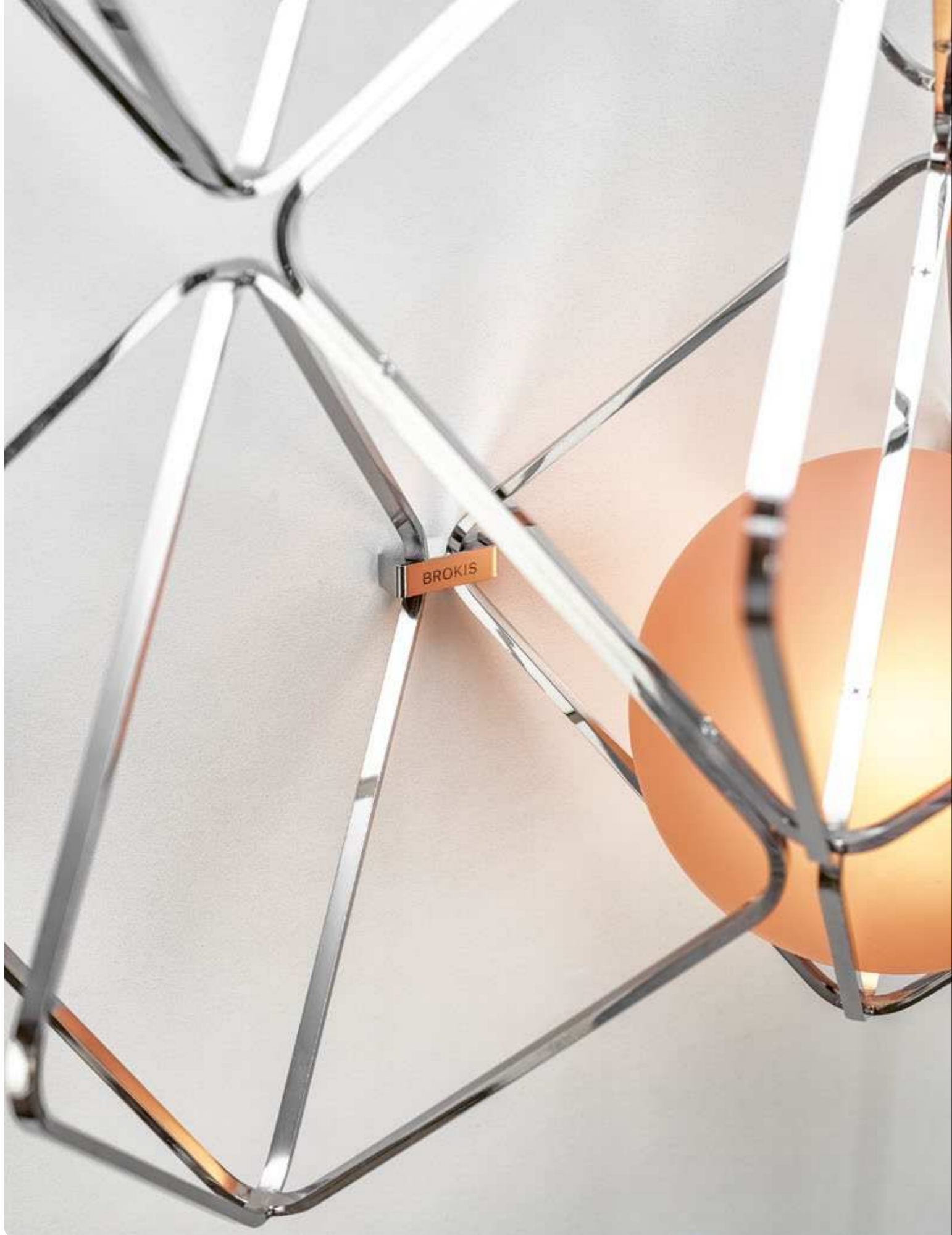

This large-format light with matte core by designer Lucie Koldova embodies a gentle poetry, simplicity, purity, and balanced proportions. A key role is played by the inoculation of luminous bodies and their mutual interaction in space – the light emitted from the smaller glass core flows freely through the atoms of air within the symbolic protective shell of the outer globe, while the sophisticated design of a bubble suspended in a large sphere evokes a sense of levitation. In keeping with the brand's ongoing development of new technologies at the highest levels of quality

DESIGN

and innovation, this year the Big One collection has received a technological upgrade in the form of a new LED panel that significantly increases the output of the lights. Enhanced metal components simplify handling. The outer glass features a gloss finish in the following colour options: transparent, smoke grey transparent, and a new smoke brown. The inner glass features a matte finish in the following colour options: triplex opal, smoke grey transparent, red transparent, light pink transparent, and a new smoke brown. The Big One collection is available in two sizes.

LUCIE KOLDOVA



BIG ONE









IWY



Nature and its life-giving beauty and strength are the inspiration behind the unique lighting concept called Ivy. Just as the plant grows and climbs up the wall of a house, so too can Ivy expand into a variety of compositions. The collection features a special system of modular components for a highly innovative take on decorative lighting in both vertical and horizontal installations.

The collection comprises metal components in combination with handblown glass. Branches come in five basic sizes, while there are three sizes of shades in matte light rose, triplex opal, or smoke

DESIGN

glass. The collection also offers an impressive floor light and intimate table lights. Elegant and precise in craftsmanship all the way down to the smallest detail, Ivy is a high-tech lighting concept ideally suited to project and residential applications.

In household settings, for example, a single graceful branch can be hung above a dining table, or multiple branches can be used to create a curtain of light.

The organic Ivy collection has many forms and rightfully holds its place in the realm of artistic, bespoke lighting solutions.

LUCIE KOLDOVA







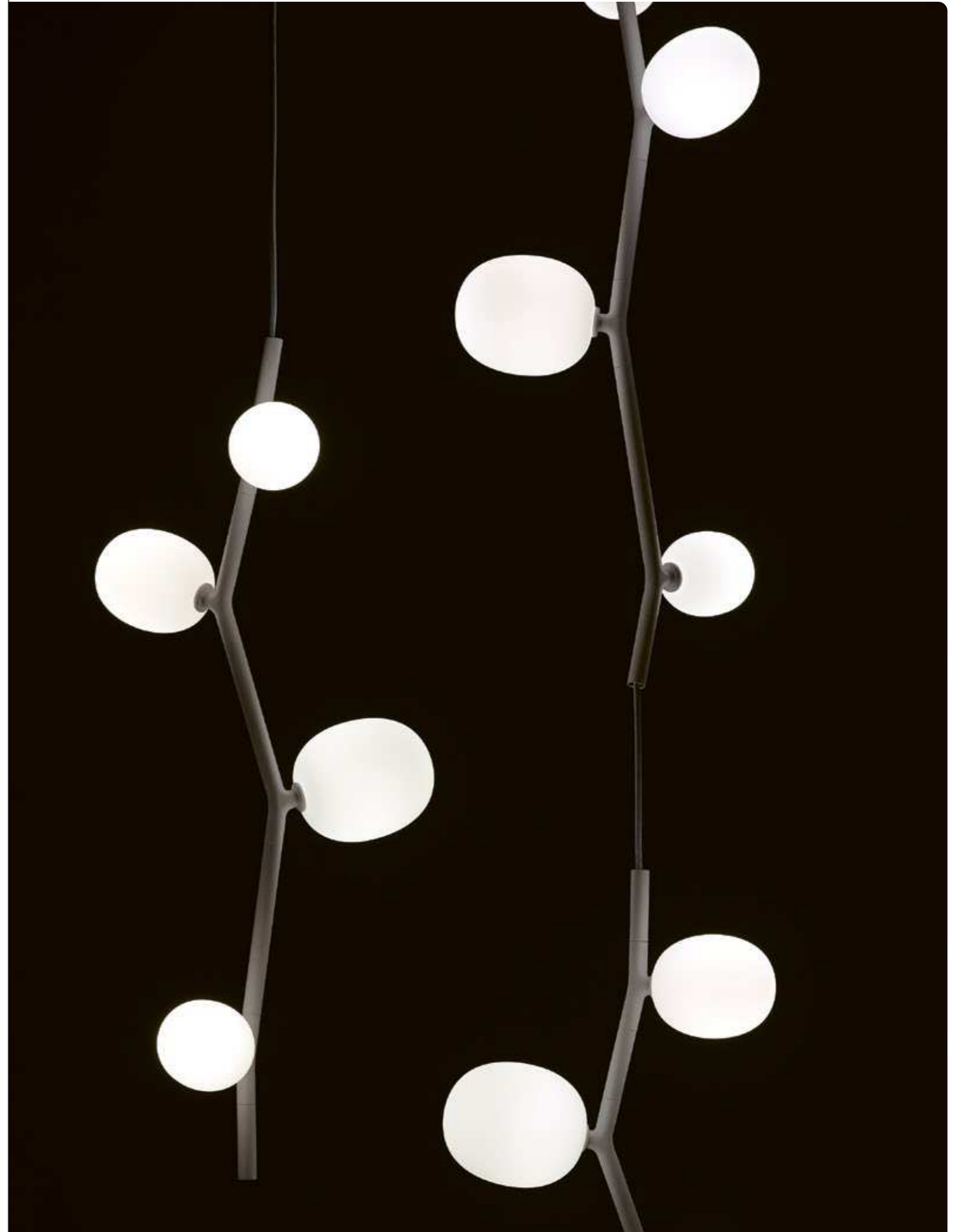





AWWA



In Japanese, the word 'awa' is used to describe a bubble of air trapped within a liquid. The design of this delicate light was inspired by the notion of soft glass that has retained its shape after being inflated. The aim is to give the impression of a luminous ball of air floating gently in space when viewed from

DESIGN

below. Another special characteristic of the design is that the wood and metal parts appear to be made of glass, as if they were stoppers keeping the air from escaping. A recent addition to the collection is a new version featuring frosted glass in the top half of the light.

FUMIE SHIBATA









BONBORI



The Bonbori collection, which was created by world-renowned Japanese designer Fumie Shibata, is available in indoor and outdoor variants. The light is inspired by the traditional paper lamps that line the paths to shrines and temples during the annual paddy harvest festivals in Japan. In Japanese, the word 'bonbori' not only denotes this traditional form of lighting, but it also describes the soft light coming from within a snowy cave. The gentle light

DESIGN

of Bonbori pays tribute to a traditional Japanese lantern. Its skilfully crafted handblown glass and soft luminescence create a magical and festive ambience to be enjoyed as thoroughly in solitude as with family and friends. The indoor light features special connectors developed by BROKIS that make it easy to unplug and move outside to a covered exterior space, for instance. Also available in a wall variant.

FUMIE SHIBATA









The Sfera collection, one of the mainstays of the BROKIS portfolio, comprises three shapes and several sizes. Sfera lights are designed to meet the needs of projects and the architects and other professionals behind them. The sphere as a universal shape is joined by an oval in two sizes also featuring a dramatically sheared top.

The prevailing characteristic of the Sfera project light is a clean cut across the top that serves as a platform for an elegant decagonal fixture. The timeless object casts a gentle light through handblown matte opal glass, which is attached to

a metal plate featuring a subtle multiangular detail. The original sphere comes in eight sizes ranging from 150 to 600 mm and thus offers a considerable degree of variability in interior installations, while a practical hexagonal BROKIS connector makes it easy to install, maintain, and clean large sets of lights as well as rearrange them without having to alter the interior. The universal beauty and simplicity of the Sfera collection mean it can be used in any space and in any number, from a single light as an elegant accent to large bespoke compositions containing various sizes and shapes.

DESIGN

LUCIE KOLDOVA



SFERA







Geometric accentuates the aesthetic expression and structure of BROKISGLASS, which itself is remarkably distinctive. The collection is defined by basic geometric shapes that characterize the overall contours of the lights and instil them with a singular graphic element to achieve a striking contrast with the animate, almost sculptural makeup of the glass. The suspension components comprise glass geometric shapes, their edges rendered in black profiles. The circular and oval lights work well as solitary pieces, and multiples can also be arranged in a sort of jigsaw puzzle, which in the hands of architects

DESIGN

results in an endless variety of lighting combinations. The concept surpasses its primary function as a lighting fixture and opens the door to large-format blocks of light and other uncommon compositions. For even more expressive freedom and a truly bespoke lighting experience, clients can specify a different colour of glass in each of the two sections of a light. Resting against a sturdy cylindrical base, the Geometric Table elicits a subtle aesthetic tension that amplifies the overall visual experience. The Geometric collection has received a technological upgrade in the form of precision-milled dural for the metal profiles.

BORIS KLIMEK, LENKA DAMOVÁ



GEOMETRIC











The Planets collection is based on period lights and reflects the daily needs not only of customers but of architects and designers too. Thanks to a simple physical principle, the lights can be variably positioned in diverse arrangements. The use of weights and pulleys makes it possible to quickly adjust the height of the lights, a unique system that allows for several groupings to serve as individual sources of light in an interior, or as multiples of three different (or same) shapes to illuminate larger spaces. The counterweight is precisely calibrated to the specific weight of the light, so adjusting it is safe and easy. A round LED panel is situated beneath

DESIGN

a shade of matte glass, which conceals the internal parts and thus preserves the silhouette of the light. The metal components also come in a matte finish and are combined with a textile cord for a uniform look. The colour scheme is always monochromatic to underline the graphic character of the lights, and the glass shades are rendered in elementary geometric shapes – sphere, cone, and capsule. The Planets collection stands out with its remarkable versatility, offering a broader dimension in interior lighting with installations ranging from a single light to vast clouds of up to twelve lights.

VRTIŠKA & ŽÁK



PLANETS









The Orbis collection is based on a universal shape rendered in handblown smoke glass that has been abruptly severed across the top to accommodate an elegant multiangular metal fixture. Rich in ambience yet enticingly minimalist, these atmospheric lights embody a sense of technicism. A diffuser conceals an LED panel within the fixture and softens the light as it radiates outwards from its source, while the multiangle serves to house a special BROKIS connector engineered for easy installation and arrangement of grand lighting compositions.

DESIGN

Additional variability is provided by a choice of subtle grey smoke glass, with the metal fixture finished in a black powder coating that underscores the gloss of the transparent glass. These refined components come together to create an unmistakable interior charm well suited to large restaurant and hotel spaces as well as intimate private interiors. Now available with glass in one of several colour options, each of which is paired with metal components in a predetermined corresponding colour.

LUCIE KOLDOVA

ORBIS







DOUBLE

Double, a collection of elegant pendent lights, is based on a shape comprising double elements crafted from different materials – glass and light-weight aluminium. These materials depend on one another to generate a unique and consonant form. The glass globe terminating in a metal ring provides a suggestive effect, with the handle on top alluding to the idea of portability. In the pendent variant, which is available in three different shapes, the upper metal section with wire rope seeks equilibrium

DESIGN

in the scattered light and shadows as they pass through the lower metal ring and globe, while the latter consists of multiple layers of molten glass that are carefully scrutinized by the master glass-maker prior to blowing. The luminance of the LED light source is softened by a diffuser. By virtue of its scope, the Double collection is ideal for private interiors and works very well in large compositions and colour combinations. The new collection has been expanded with table and floor variants.

LCM MARIN DESIGN STUDIO



archiproducts
DESIGN AWARDS
2022
WINNER

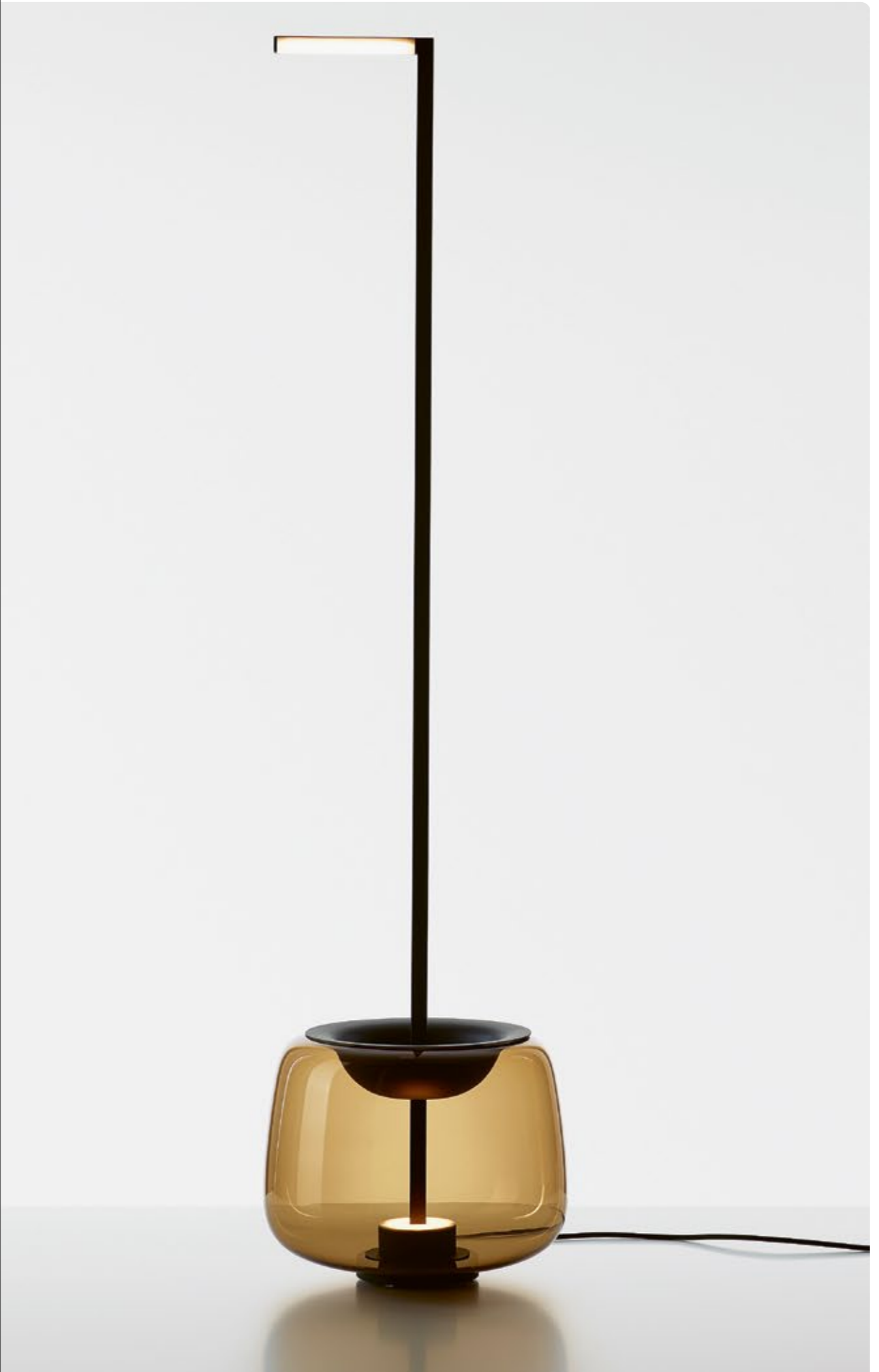
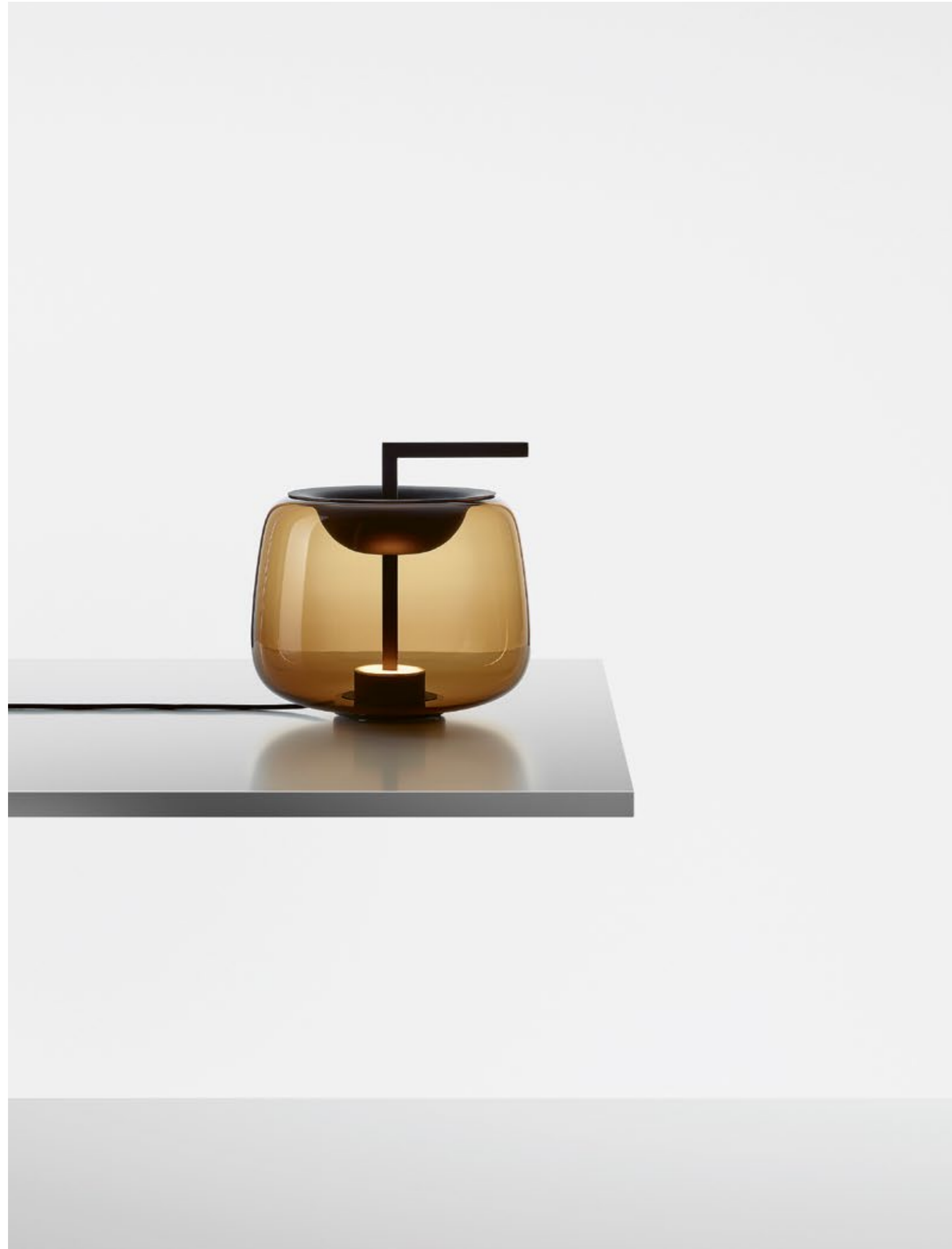







Modern yet timeless. Extravagant in its style and use of clean geometric forms. Inspired by architecture. The Overlay collection arose from a synthesis of various materials on mood boards during a creative process that involved seeking ideas and associations between art and design, overlaying different textures, and playing with volumes. The blown transparent glass tubes instil the Overlay collection with a distinctive character, as does the unique concrete fixture embedded with shards of upcycled glass from Janštejn Glassworks. The piece is cast in different

rectangular volumes specifically for each type of light capable of accommodating both simple and multiple assemblies for a remarkable degree of versatility. Cradled within the concrete fixture is a delicate sleeve of either frosted or clear glass, its centreline struck by a light tube that seemingly levitates within. The typology of the Overlay collection comprises horizontal pendant variants, table lights, and wall lights that open the door to a new realm of possibilities in lighting art. The collection has now been expanded with other variants.

DESIGN

LUCIE KOLDOVA



OVERLAY













PRISMA

The dominant feature of the Prisma collection is an extravagant metal fixture with a distinctive finish. Classic handblown glass spheres are anchored to either one or both ends of a robust decagonal metal prism that lends the collection its name. The shape in combination with the striking surface reflect light at different and unexpected angles, like a prism. With a choice of two different elegant finishes – brushed steel or yellow zinc lacquer – the light is a bold artistic object in the interior offering unique vertical, horizontal, and diagonal compositions with subtle colourful reflections. The collection

consists of a horizontal pendent light with dual glass spheres and a vertical pendent light with a single glass sphere, both of which hang from wire ropes. Another typological variant is an impressive floor light, a majestic light sculpture in the form of a robust upright decagon topped with a luminous glass sphere. The structured finish on the metal fixture is one of the defining traits of the collection, and together with transparent glass or grey smoke glass constitutes a jewel with which to adorn private interiors as well as hotels and restaurants.

DESIGN

LUCIE KOLDOVA











archiproducts
DESIGN AWARDS
2022

WINNER

Bamboo Forest draws inspiration from the vertical contours rising up in stands of bamboo. Conceived to evoke a unique atmospheric ambience, the handsculpted glass forms a bamboo stalk complete with the typical nodal ring, where the material thickens, creating a soft accent in the form of subtle shadows. With different sizes and varying positions of the node on the stalks, thanks to which the origins of the collection are at once recognizable, compositions of multiple

DESIGN

lights transform the interior into a sanctuary replete with the soothing tranquillity of a natural bamboo forest. The innovative BROKIS connector enhances the overall variability of the lights by simplifying not only installation of large sets but also maintenance and cleaning. Bamboo Forest is unique for the unusual shape of the lights, which come in six different variants, as well as for the possibilities the collection offers in creating both original combinations and single-point accent lighting in interior spaces.

FUMIE SHIBATA



BAMBOO FOREST











TROTTOLA



Trottola is a new collection of suspension and table lights whose shape elicit memories of a popular childhood toy – the spinning top. The aesthetics of the design are carried on an enchanting luminance that passes through an opal diffuser and opaline glass to reveal a playful contrast of shadows and light. The LED source, visible only from above, is housed in a base clad in pressed aluminium, which in turn

is finished in an attractive and durable black elox. Brightness can be adjusted with a simple turn of the elegant dimmer. Trottola offers two sizes of suspension and table lights in handblown opaline glass. The table variant is fitted with the innovative BROKIS connector, which makes it easy to disconnect the light and move it about the interior and also facilitates disassembly for maintenance.

DESIGN

FEDERICO PERI











ELO

Elo, an innovative new suspension light combining the distinctive textures of BROKISGLASS with elegant aluminium framing, comprises three articulated arches, the outer two of which can be locked in different attitudes. The unique solution offers a variety of striking scenographic compositions that can shape the interior and lend it a dominant design element. The name Elo means 'ring' or 'bond', words that adeptly express the grand decorative potential and remarkable variability

DESIGN

of the concept, a sculptural entity that can be modified and customized as the demands of the setting evolve. The glass is set in elegant metal frames crafted from aluminium, which ensures outstanding structural integrity. Illumination is provided by flexible LEDs that follow the curvature of the arches, underscoring the intrinsic aesthetic beauty of the BROKISGLASS and effecting a charming diffusion of light no matter what configuration the piece is installed in.

FILIPPO MAMBRETTI









**EXTERIOR
LIGHTS**

BONBORI OUTDOOR



**archiproducts**
DESIGN AWARDS
—
WINNER 2020

The very first outdoor lighting collection in the BROKIS portfolio, Bonbori was created by world-renowned Japanese designer Fumie Shibata, who took inspiration from the traditional paper lamps that line the paths to shrines and temples during the annual paddy harvest festivals in Japan. In Japanese, the word “bonbori” not only denotes this traditional form of lighting, it also describes the soft light coming from within a snowy cave. Manufactured in compliance with the IP44 rating for outdoor use, the light makes use of a simple stainless-steel base finished in an environmentally friendly weather-resistant powder coating. The easily

removable LED light source, which can withstand below-freezing temperatures, casts a gentle glow through a diffuser and laser-cut openings in the stainless steel. The likeness to the traditional bonbori lamp is achieved with an elegant handblown glass shade, an extraordinary piece crafted from multiple layers of carefully moulded glass. Whether in the garden, on the terrace, or in other outdoor settings, the soft, gentle light of Bonbori pays tribute to a Japanese tradition by creating a unique and festive ambience to be enjoyed as thoroughly in solitude as with family and friends.

DESIGN

FUMIE SHIBATA











BONBORI WALL

The very first outdoor lighting collection in the BROKIS portfolio, Bonbori was created by world-renowned Japanese designer Fumie Shibata. This successful collection has now been expanded with wall-mounted lights based on the original smaller Bonbori lamp. The Bonbori Wall comes in two variants, the first of which respects its traditional pedigree and is called Bonbori Wall Up. The second light is called Bonbori Wall Down and, as the name suggests, is a mirror image of the former. Both variants are well suited to interior and exterior installation. The Bonbori family

is inspired by the traditional paper lamps that line the paths to shrines and temples during the annual paddy harvest festivals in Japan. In Japanese, the word 'bonbori' not only denotes this traditional form of lighting, but it also describes the soft light coming from within a snowy cave. The gentle light of Bonbori pays tribute to a traditional Japanese lantern. Its skilfully crafted handblown glass and soft luminescence create a magical and festive ambience to be enjoyed as thoroughly in solitude as with family and friends.

DESIGN

FUMIE SHIBATA





Now the iconic Shadows collection by Lucie Koldova and Dan Yeffet is ready to illuminate exterior settings. Shadows is a take on the famed, timeless lights found in French ateliers, and its typology pays tribute to that legacy. Identical in appearance to the original Shadows, the collection complies with the IP54 rating for exterior use: the handmade wooden body used in the indoor lights has been replaced with a two-piece weatherproof dural body, its subtle form and finish

accentuated by a recessed LED light source. Special integrated connectors developed by BROKIS make it easy to install the lights in large sets as well as maintain and clean them. The lights can be arranged in diverse compositions based on the needs of the customer or used as solitary exterior lighting elements. The combination of handblown glass and classic shapes has given rise to lighting of unageing elegance whose singular ambience is no longer restricted to the interior.

DESIGN

LUCIE KOLDOVA, DAN YEFFET



SHADOWS EXTERIOR









NIGHT BIRDS EXTERIOR

The Night Birds collection by Boris Klimek is now available in a version suitable for exterior use. Night Birds Exterior are identical to the original indoor collection, which was inspired by the freedom and abandon of bird flight. In order to withstand the whims of the weather, the lights have been modified to comply with the IP54 rating for exterior use, namely by enlarging and weatherproofing the positionable hand-polished dural fixture, which conceals

a sophisticated balancing mechanism and the subtle LED light source. The bigger, more robust metal fixture also allows for a greater selection of light sources. Like the original Night Birds collection, Night Birds Exterior offers three different lights, each with a different wing position, which come in either white or dark (nearly black) variants. From now on, Night Birds are as at home in the elements or the dark of night as they are in the comfort of the indoors.

DESIGN

BORIS KLIMEK







**BATTERY-POWERED
LIGHTS**



KNOT BATTERY

Knot, a collection of stately pendent lights that appose two dramatically dissimilar materials, has been expanded with a portable outdoor variant. The original Knot collection features full-bodied globes of varying shapes and sizes penetrated by robust cords that seemingly pull the glass inward for a bemusing plastic effect. Knot Battery provides the perfect anchor for the lofty pendants in this collection typified by its use of strikingly disparate materials. The LED light source is cradled in a handsome bottom piece, which, like the cord end cap,

is fashioned from refined metal. Knot Battery is IP44 compliant for outdoor use, thus its charm is not confined to only the interior. Charging is by means of a convenient magnetic connector in the lower part of the light. Knot Battery is a sophisticated and flexible light that provides up to six hours of use on a single charge, which makes it ideal not only for lighting outdoor spaces but also enhancing existing lighting. Thanks to its portability, Knot Battery is well suited to daily use and for adding a special touch to social events. Also available in a smaller variant.

DESIGN

CHIARAMONTE MARIN





Ivy Battery by Lucie Koldova is the latest addition to the already substantial Ivy family, which is inspired by nature and its life-giving beauty. The battery-powered table version is somewhat smaller than the original Ivy Table, which makes it easy to move from one place to another and create unique lighting experiences anywhere, anytime. Although it is not protected from direct contact with water, its portability and robust build quality make it suitable for use in outdoor settings. Ivy Battery is touch operated and has three

brightness settings for just the right amount of light at a given moment. The lithium battery pack powers the light for up to six hours, and charging is by means of induction or a USB connector. The collection comprises a metal frame and handblown glass shades in matte light rose, triplex opal, or smoke grey. The Ivy Battery represents a graceful and flexible lighting object for restaurants and hotels, where it can be unrestrainedly combined in luminous landscapes that change in step with the space around them.

DESIGN

LUCIE KOLDOVA



IVY BATTERY







The outdoor collection called Dome Nomad takes inspiration from the domes of Venice. Dome Nomad is an outdoor lamp whose dome shape represents eternity and the vastness of the celestial vault. The dome shape of the handblown glass section comes in one of two variants: smooth clear glass or wavy clear glass. Dome Nomad is a portable rechargeable outdoor lamp, the lines of which are a nod towards Italian architecture. The gentle light passes through an opal diffuser and the namesake glass shade. The Dome Nomad collection complies with the IP44 safety and technological standards

DESIGN

for outdoor lighting. The simple design features refined stainless steel finished in an environmentally friendly powder coating for outstanding resistance to the elements. The LED source can withstand freezing temperatures. Multiple layers of molten glass are used to make the glass shade, and each one is subjected to the utmost scrutiny by the master glassmakers before being blown into the mould. Dome Nomad can be placed on a table or floor and is also suitable for hanging. It is a design experience that adds a special charm both to gardens and terraces as well as to interior spaces.

LCM MARIN DESIGN STUDIO

DOME NOMAD











SFERA PORTABLE

Sfera Portable is a rechargeable outdoor light that comes in two sizes. It is one of the latest additions to the BROKIS outdoor lighting portfolio. Sfera Portable is based on the idea of a small sphere of light set within a poured concrete base with the same subtle multiangular detail used throughout the Sfera family. The delicate sphere of handblown matte or gloss glass resides beneath a stainless-steel hoop, which serves as a handle for moving the light from one place to another. The concrete base houses not only the charging module but also a sensitive touch dimmer with which to adjust the brightness. Sfera Portable is fitted with an LED light source

DESIGN

with diffusor and meets the safety and technological standards of the IP44 rating for outdoor use. The sphere as a timeless and perfect shape whose allure never ceases to capture the imagination. Handblown glass anchored in a raw, almost brutalist concrete base is an excellent match for modern architecture, but it can also be used to great effect when set in contrast with historical architecture. Sfera Portable is a stylish atmospheric lighting object designed for both outdoor and indoor use. Thanks to its simple construction, the light can be easily picked up and moved to change the ambience of any space.

LUCIE KOLDOVA









ACCESSORIES



MUFFINS CANDLEHOLDER



Muffins Candleholder is a captivating experience. With its subtle lines in glass, solid wood base, and masterful craftsmanship, not only will the Muffins Candleholder reveal something of your sense for

DESIGN

detail and exquisite design, but it will also lend your room a festive air any time of the day or night. The Muffins Candleholder is part of the iconic Muffins lighting collection, an emblem of the BROKIS brand.

LUCIE KOLDOVA, DAN YEFFET





INDEX

Complete
specification
for each
photo/PH below:



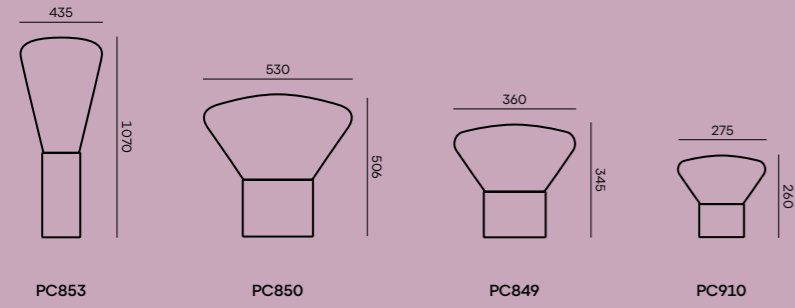
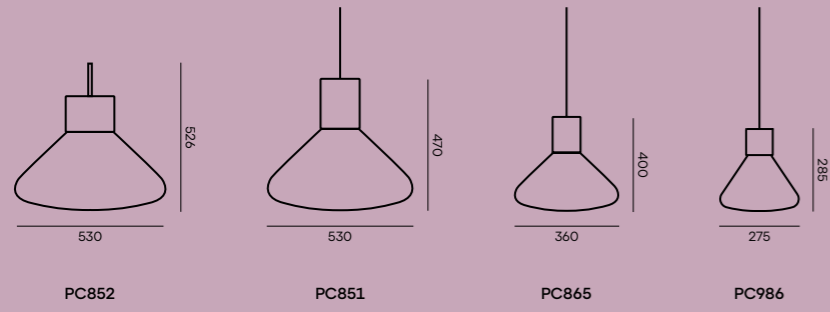

Canopy

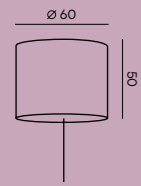

p. 21
PH1609

p. 25
PH943

p. 22—23
PH956

p. 26—27
PH946

p. 24
PH1361

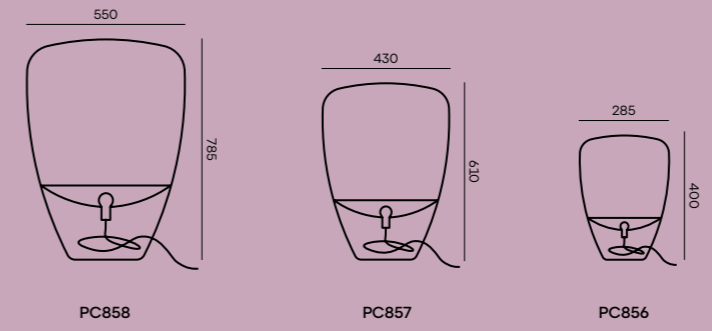

p. 29
PH21

p. 33
PH691

p. 30—31
PH680

p. 34—35
PH1179

p. 32
PH689

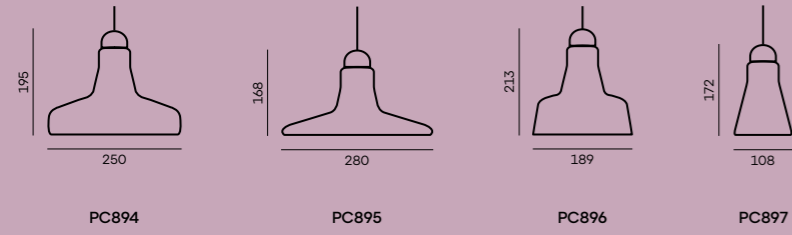

Set and Canopy

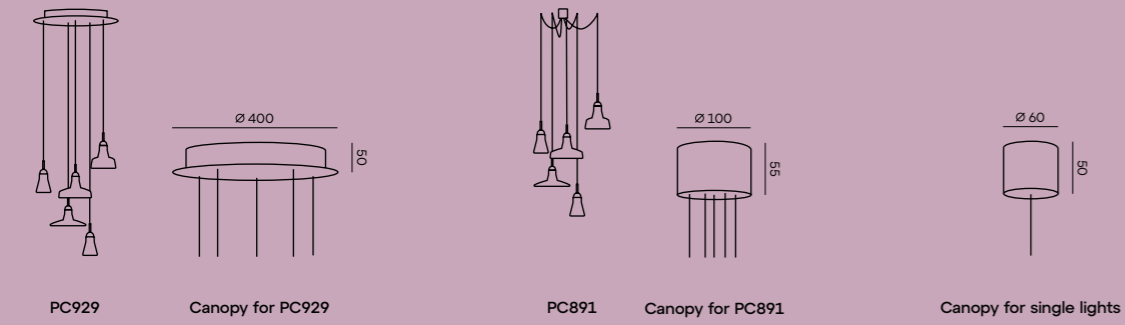
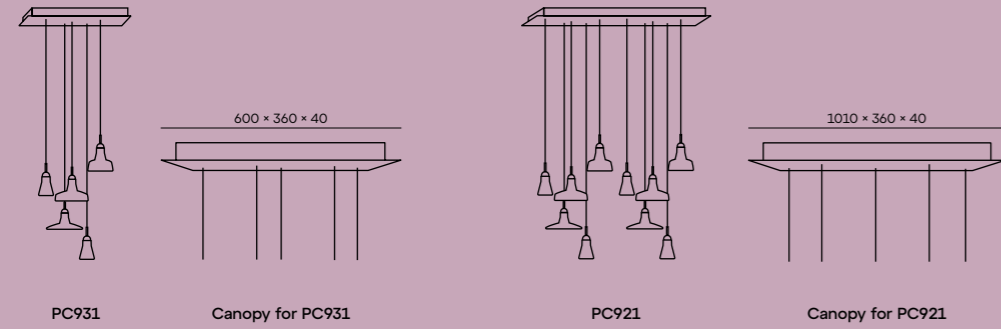

SHADOWS XL

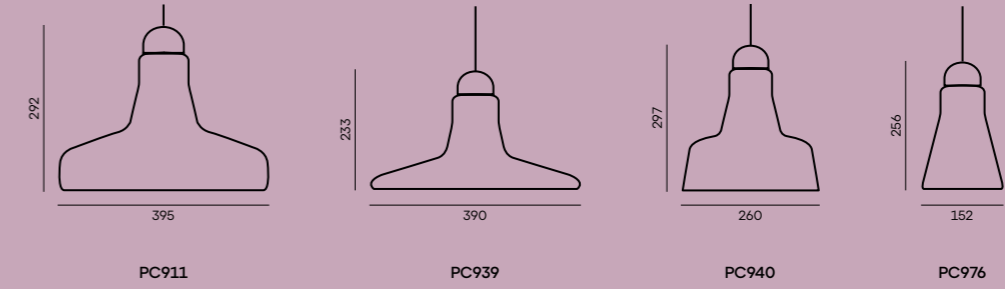

Set and Canopy

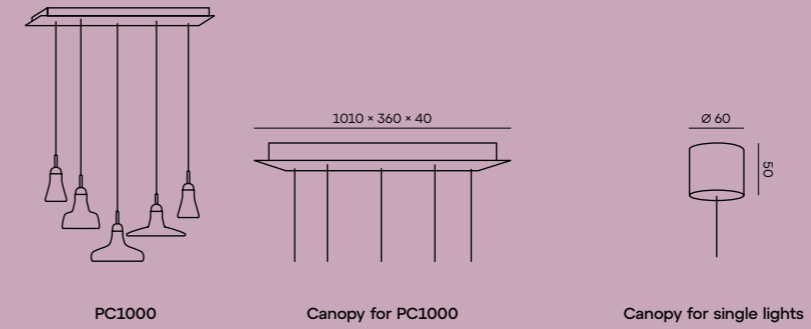

p. 37
PH1620

p. 40
PH1637

p. 38
PH1071

p. 41
PH1369

p. 39
PH6861

p. 42—43
PH1637

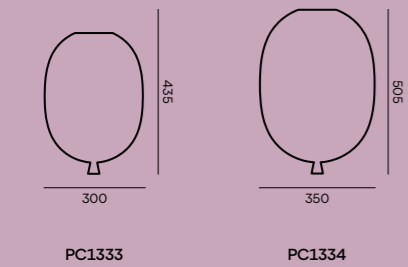
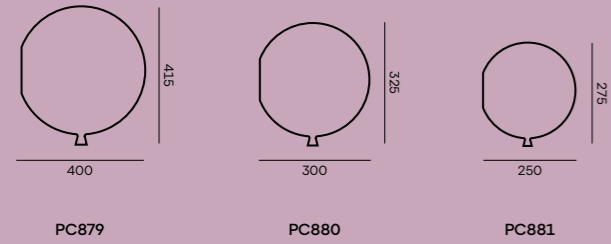
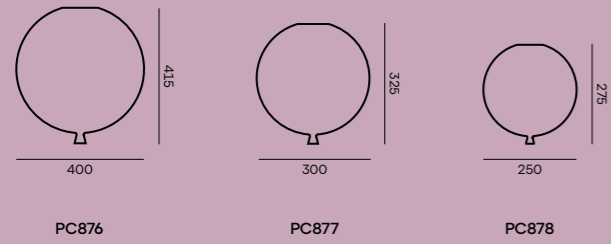

Set and Canopy

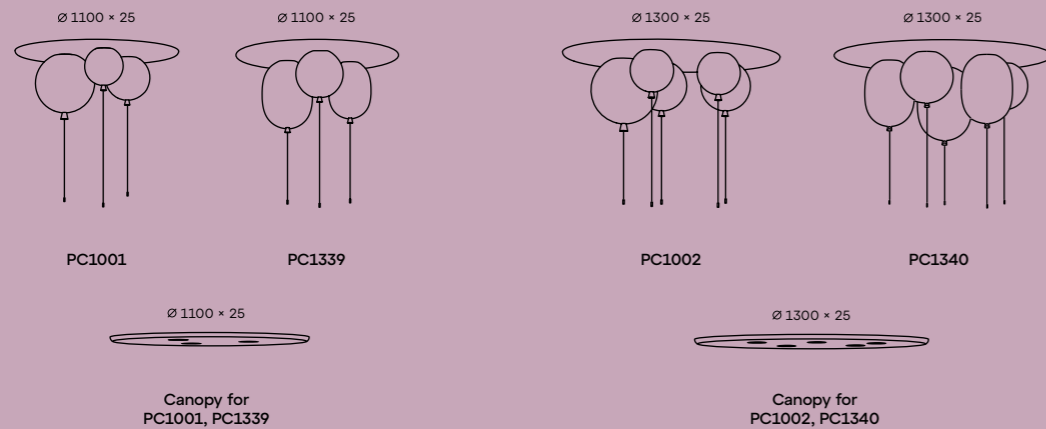

p. 45
PH896

p. 48—49
PH10227

p. 46
PH10235

p. 50
PH10894

p. 47
PH1349

p. 51
PH6553

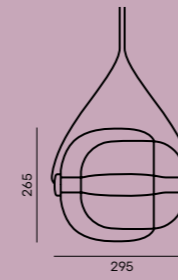

PC937

Set and Canopy

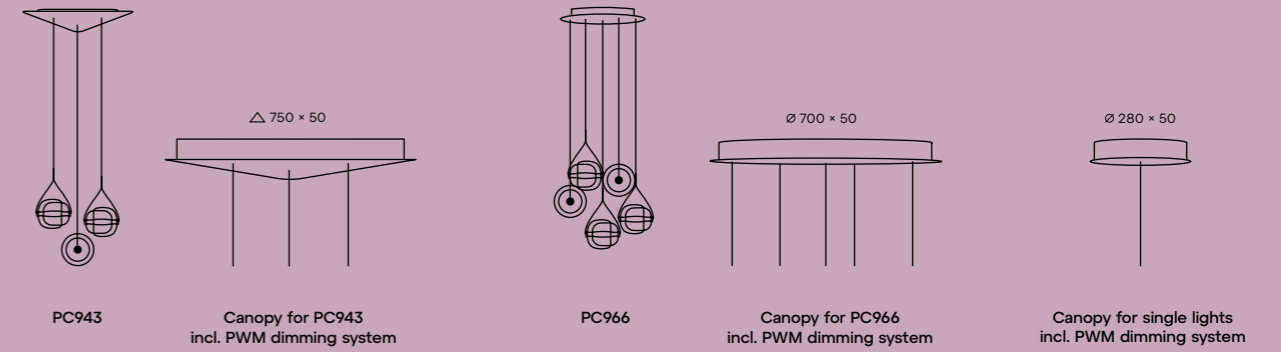

p. 53
PH1240

p. 56—57
PH6679

p. 54
PH1325

p. 58—59
PH1220

p. 55
PH1234

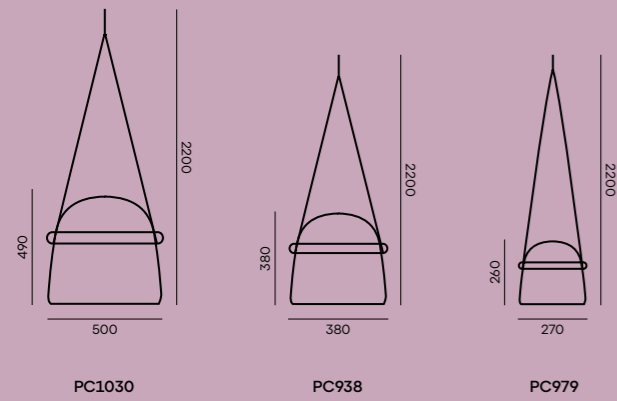
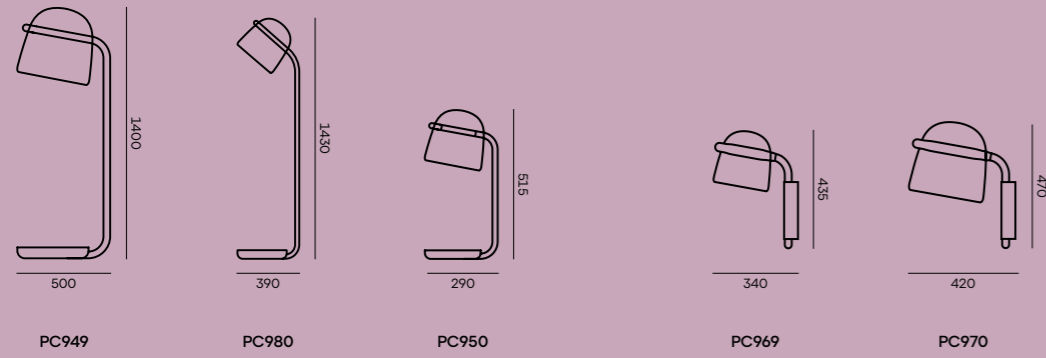

Canopy

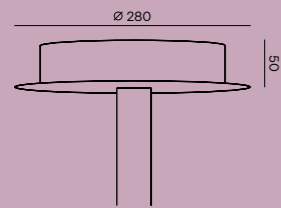

Canopy also for PWM dimming system

p. 61 PH10898	p. 64—65 PH9466	p. 69 PH903
p. 62 PH1356	p. 66—67 PH9465	p. 70 PH10889
p. 63 PH926	p. 68 PH9472	p. 71 PH10720

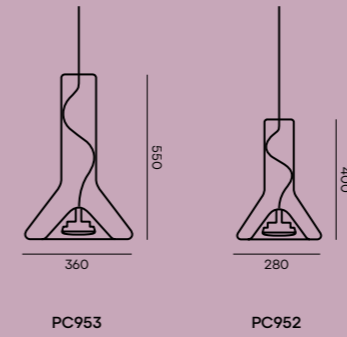

Set and Canopy

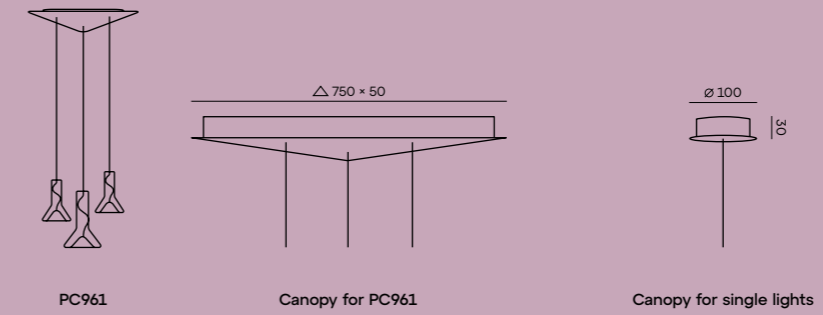

p. 73 PH4332	p. 76—77 PH6677	p. 81 PH1083
p. 74 PH6867	p. 78—79 PH1372	
p. 75 PH5356	p. 80 PH1078	

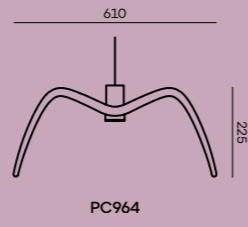
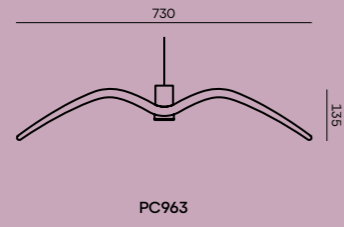
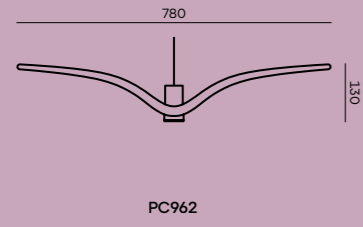

Canopy

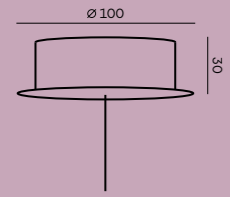

p. 82—83
PH997

p. 86—87
PH8099

p. 84
PH990

p. 85
PH1362

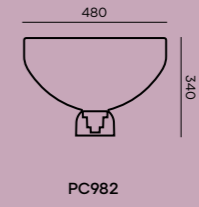
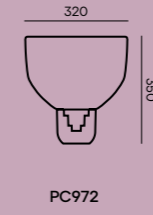
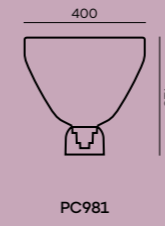
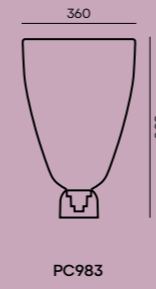

p. 89
PH1558

p. 92
PH855

p. 96
PH1344

p. 90
PH6694

p. 93
PH859

p. 97
PH6834

p. 91
PH850

p. 94—95
PH1556

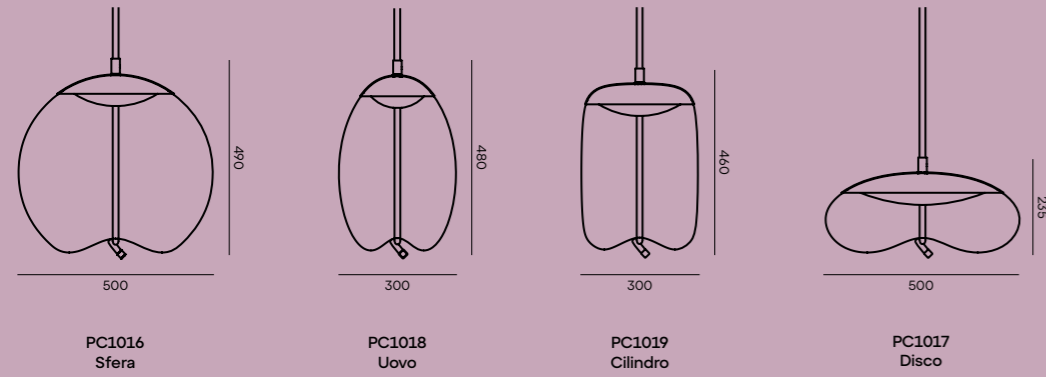

Canopy

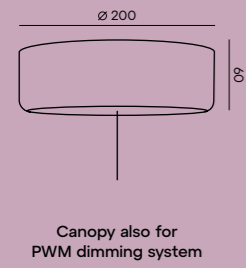

KNOT SMALL

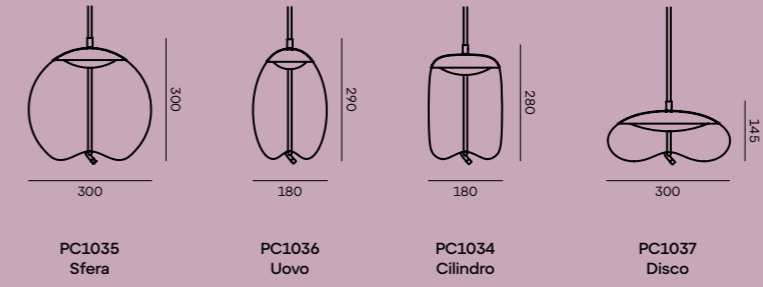

Canopy

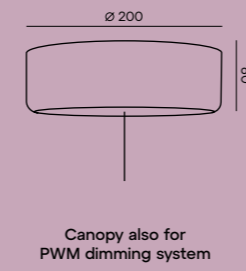

KNOT TABLE

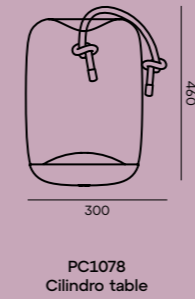

p. 99
PH1338

p. 103
PH825

p. 106—107
PH8092

p. 100—101
PH1335

p. 104
PH1337

p. 102
PH1341

p. 105
PH8094

PURO SOLO

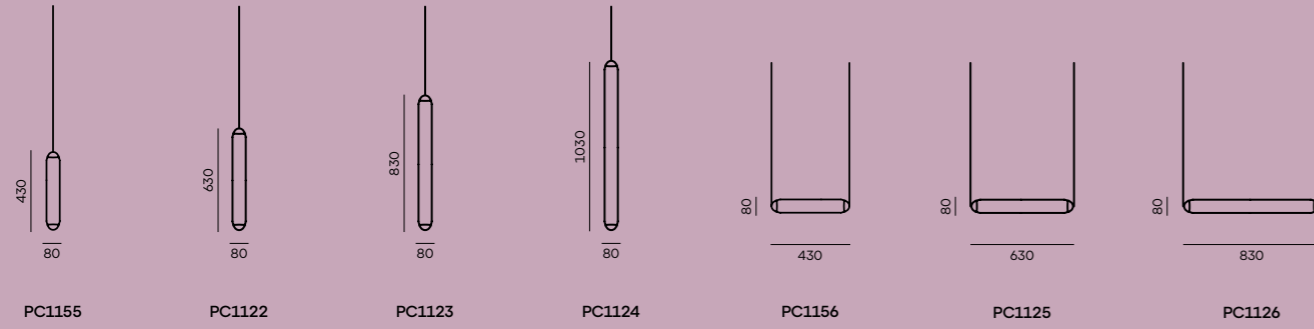

PURO SINGLE

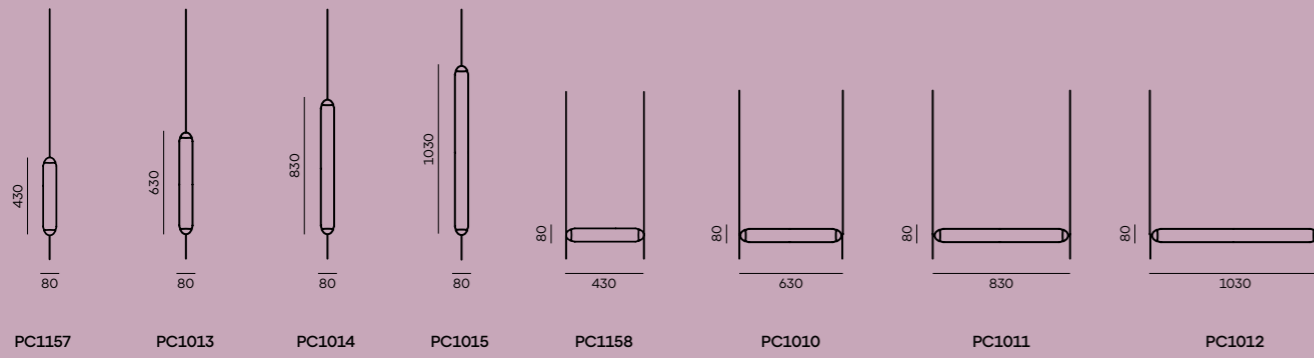

Canopy

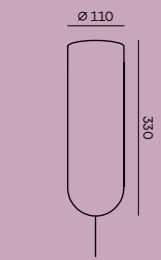

Canopy also for PWM dimming system

PURO SPOTLIGHT



PC1121

Canopy

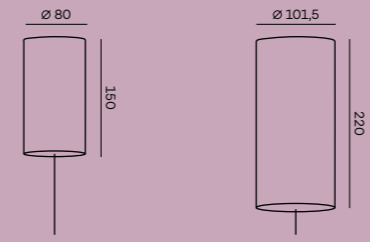

Non-dimmable version

Dimmable version also for PWM dimming system

PURO ECLECTIC

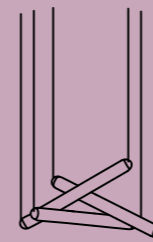

PC1114

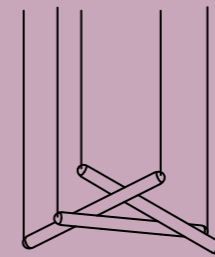

PC1115

Canopy

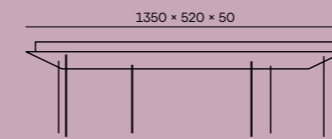
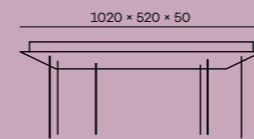

PURO CONTOUR

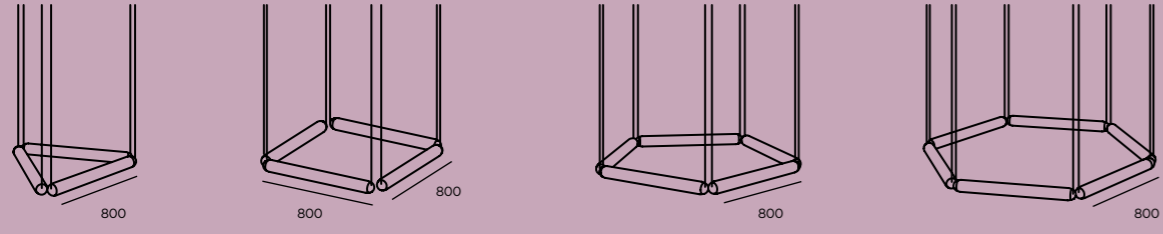

PC1118

PC1073

PC1119

PC1120

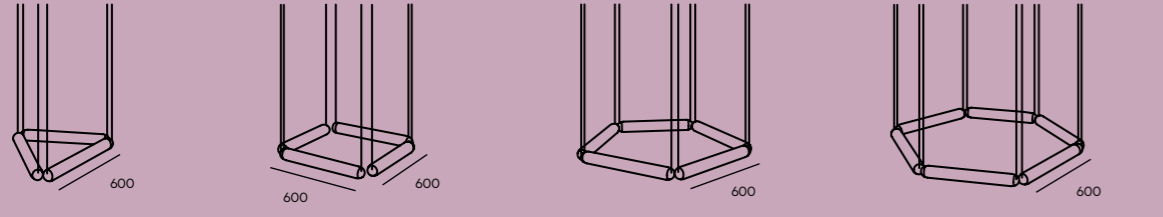

PC1133

PC1057

PC1135

PC1137

Canopy

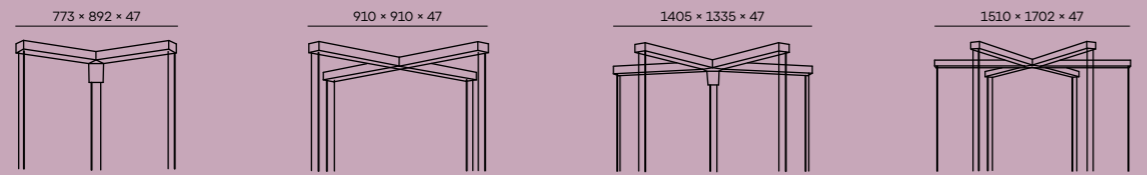

Canopy for PC1118
incl. PWM dimming system

Canopy for PC1073
incl. PWM dimming system

Canopy for PC1119
incl. PWM dimming system

Canopy for PC1120
incl. PWM dimming system

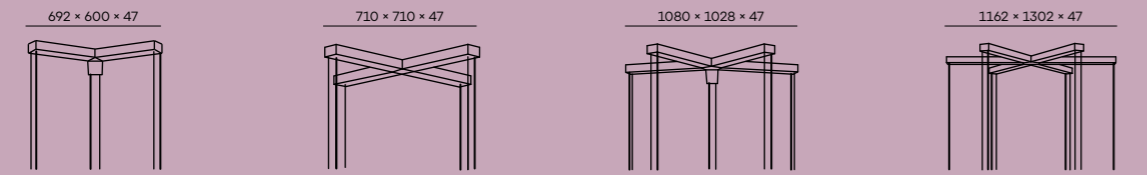

Canopy for PC1133
incl. PWM dimming system

Canopy for PC1057
incl. PWM dimming system

Canopy for PC1135
incl. PWM dimming system

Canopy for PC1137
incl. PWM dimming system

PURO SPARKLE

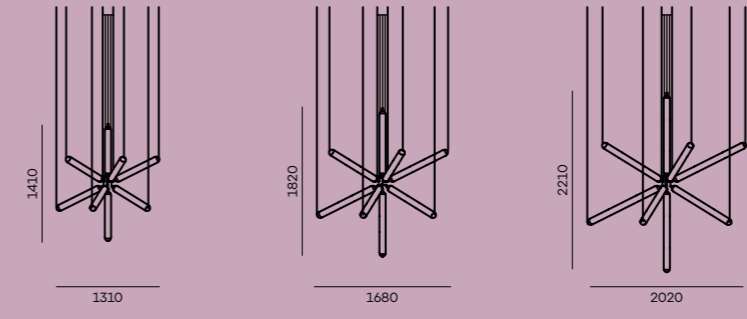

PC1053

PC1054

PC1055

Canopy

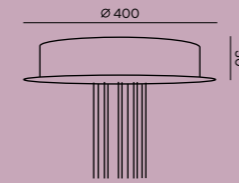

Canopy also for
PWM dimming system

PURO FLOOR

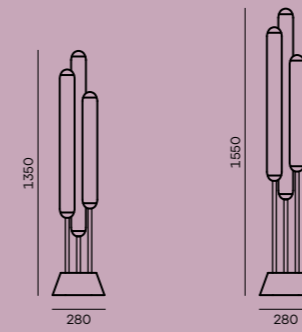

PC1252

PC1253

p. 109
PH1614

p. 112
PH1054

p. 116
PH1027

p. 120
PH6512

p. 110
PH407

p. 113
PH5773

p. 117
PH1043

p. 121
PH1042

p. 111
PH408

p. 114—115
PH6559

p. 118—119
PH1036

p. 122—123
PH1023

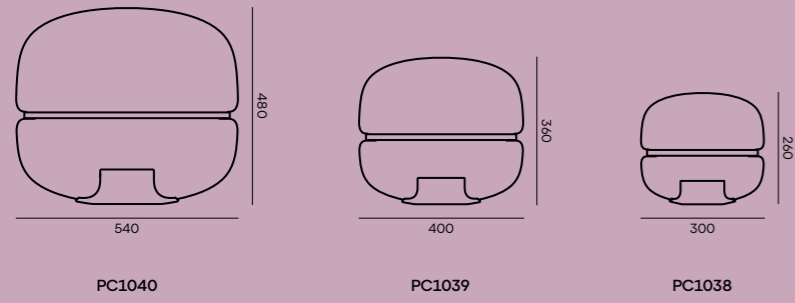

JACK O' LANTERN SMALL

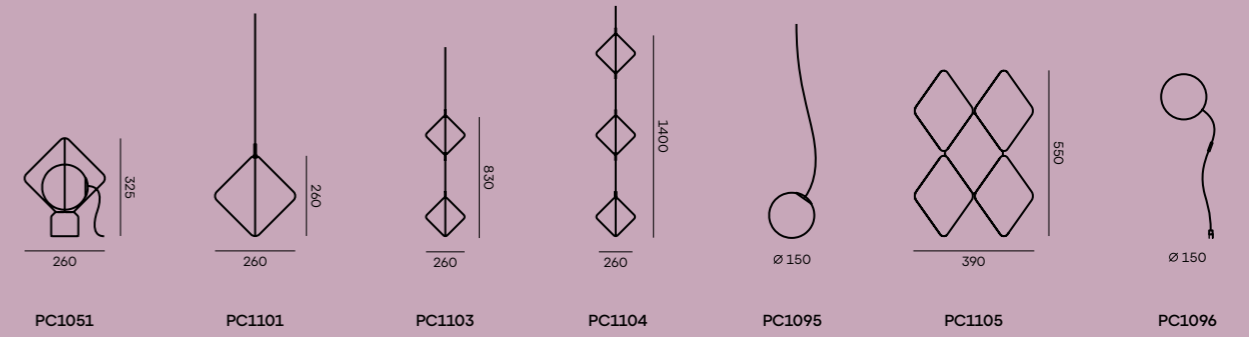

JACK O' LANTERN LARGE

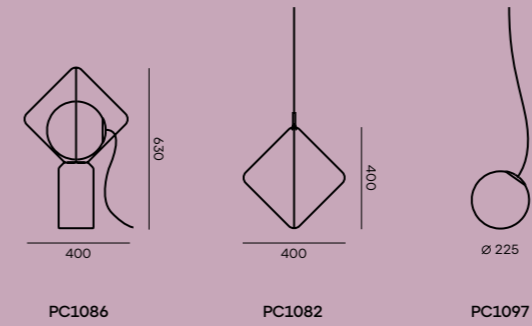

Canopy

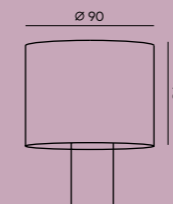

p. 125
PH1566

p. 128—129
PH881

p. 133
PH862

p. 126
PH870

p. 130—131
PH1574

p. 127
PH872

p. 132
PH880

p. 135
PH3420

p. 138
PH1520

p. 142
PH1399

p. 145
PH794

p. 136
PH1330

p. 139
PH1503

p. 143
PH1333

p. 307
PH6259

p. 137
PH1385

p. 140—141
PH3397

p. 144
PH813

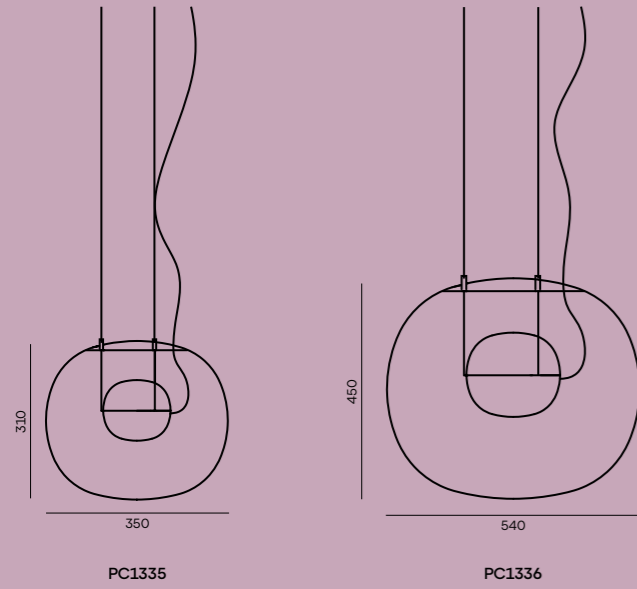

Canopy

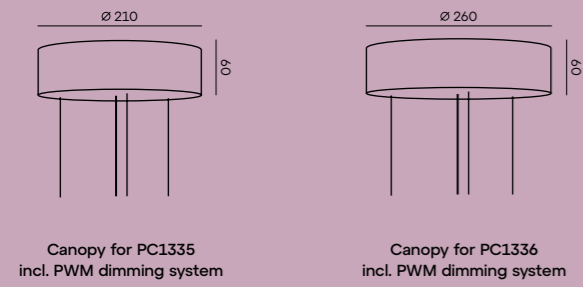

p. 147
PH10845

p. 150—151
PH1400

p. 148
PH11275

p. 152—153
PH10847

p. 149
PH1170

IVY SINGLE

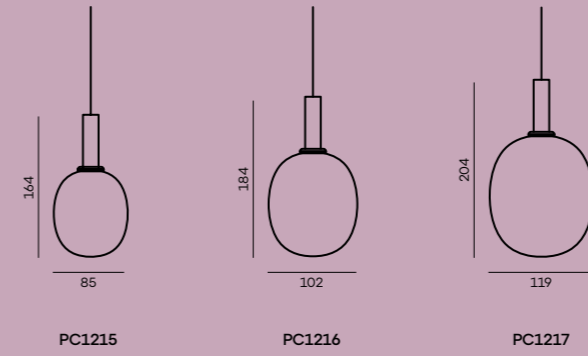

Canopy

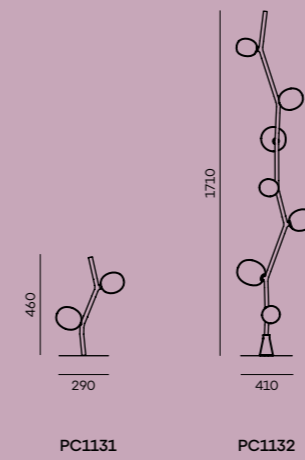
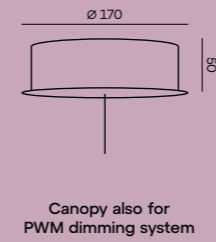

IVY HORIZONTAL

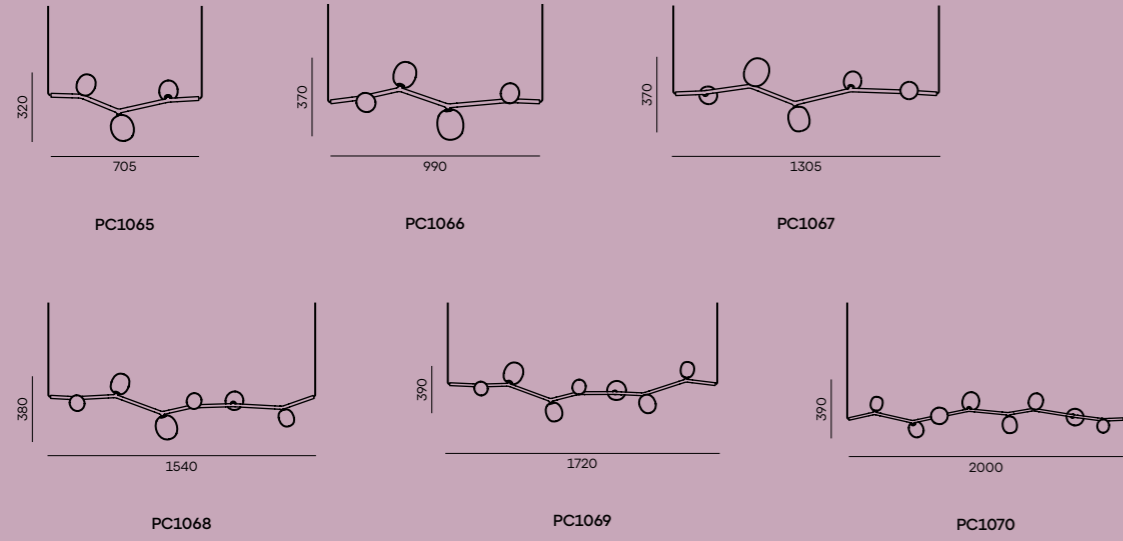

IVY VERTICAL

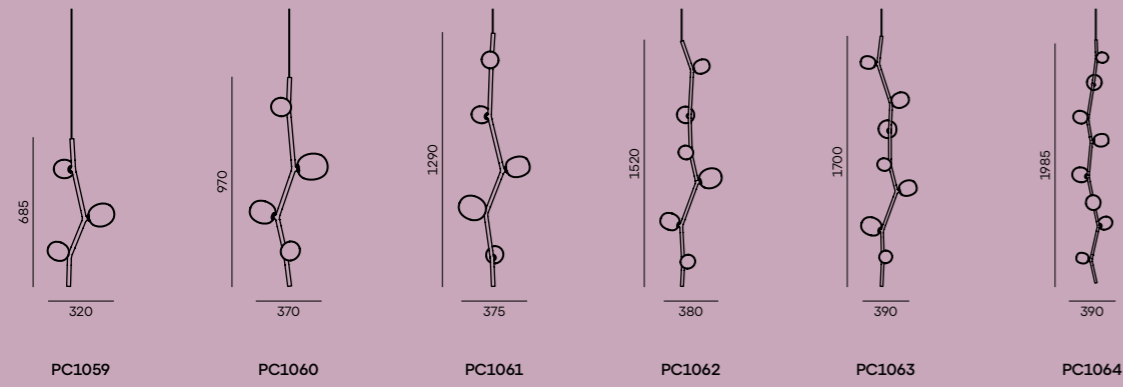

Canopy

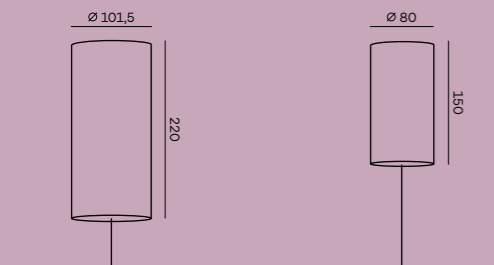

Canopy for dimmable version
incl. PWM dimming system

Canopy for non-dimmable version

IVY CEILING

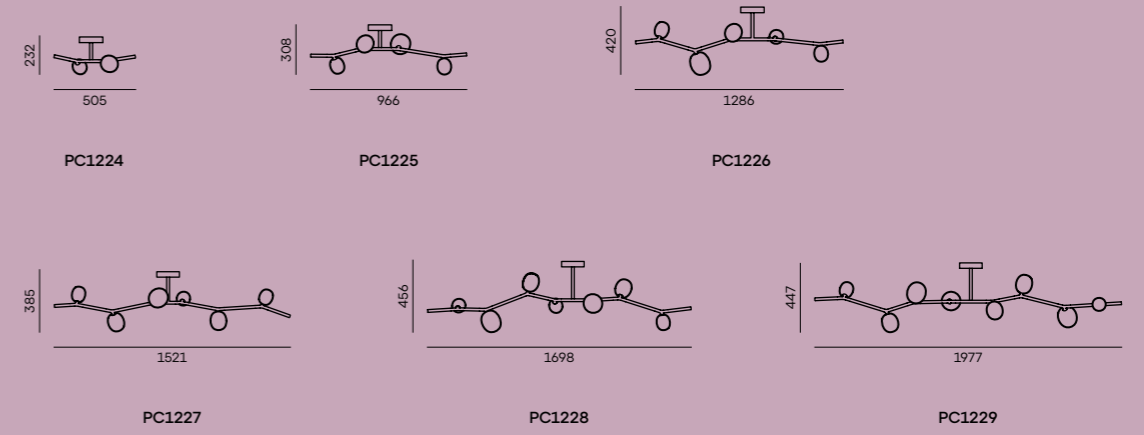

IVY WALL

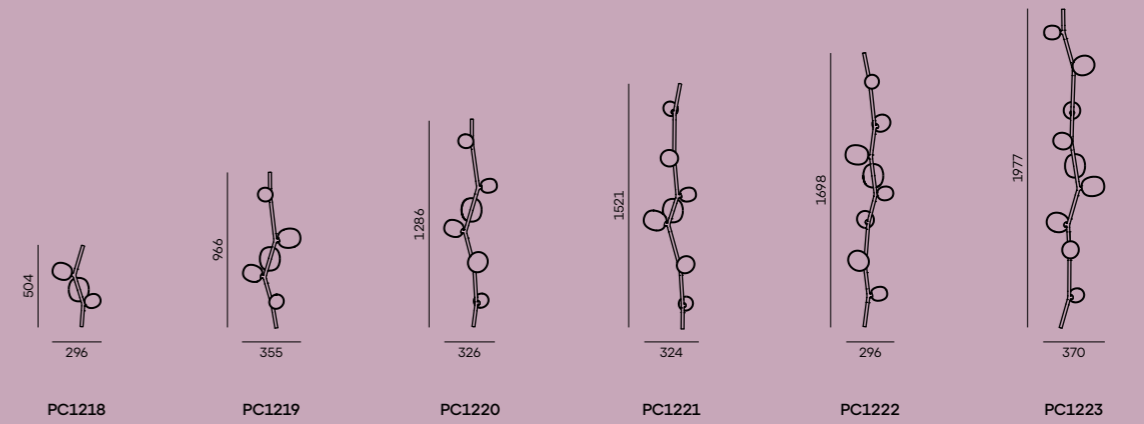

p. 155 PH753	p. 158—159 PH1397	p. 162 PH1396	p. 165 PH4815
p. 156 PH1394	p. 160 PH3797	p. 163 PH3871	p. 307 PH6259
p. 157 PH1395	p. 161 PH750	p. 164 PH3883	

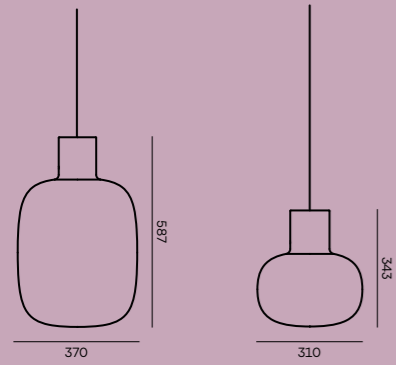

PC1130

PC1129

Canopy

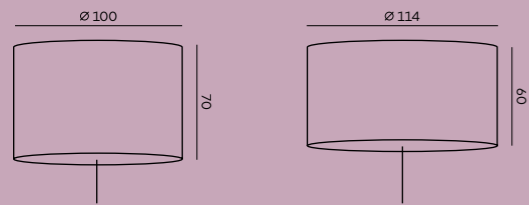

Metal canopy

Wooden canopy

p. 167
PH10854

p. 170—171
PH670

p. 168
PH1388

p. 172
PH10718

p. 169
PH668

p. 173
PH1392

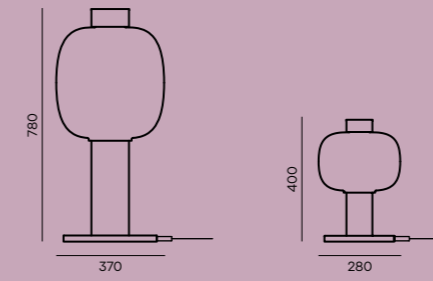

PC1165

PC1164

p. 175
PH2562

p. 180
PH3794

p. 176—177
PH3865

p. 181
PH2560

p. 178—179
PH3855

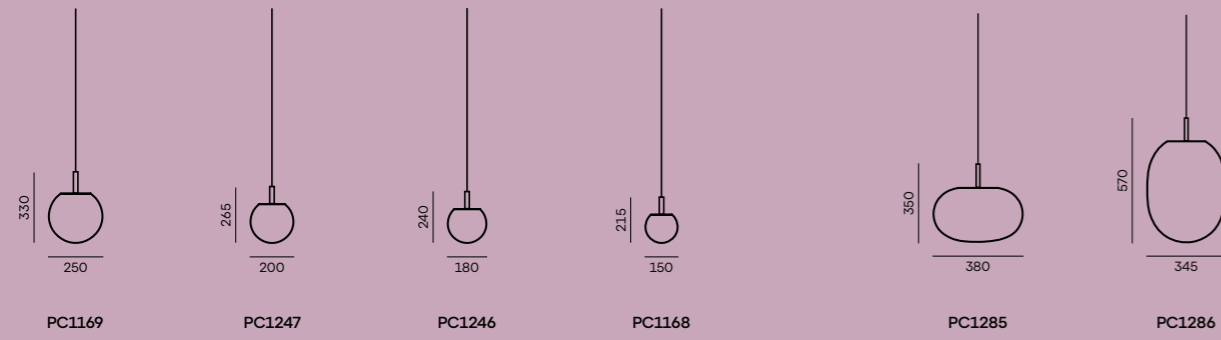
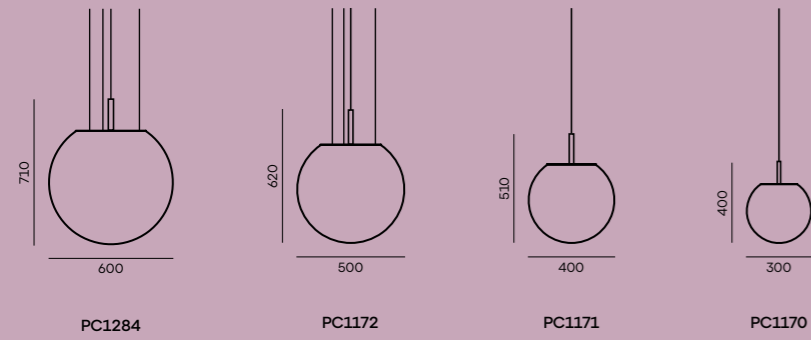

Canopy

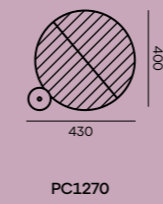
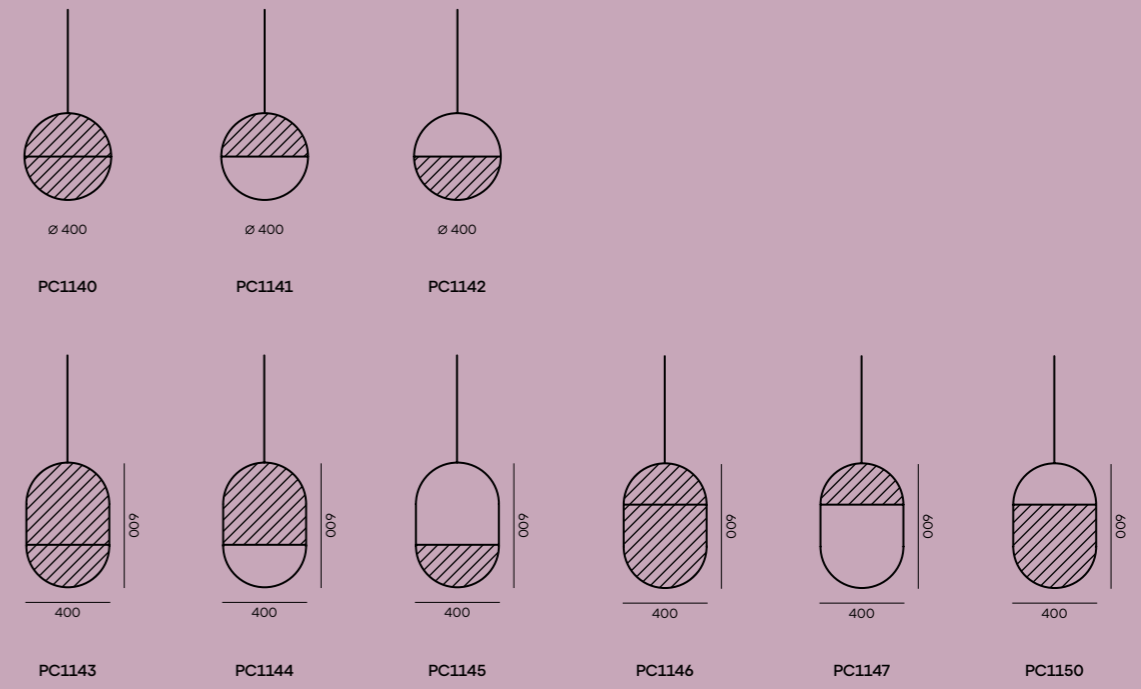
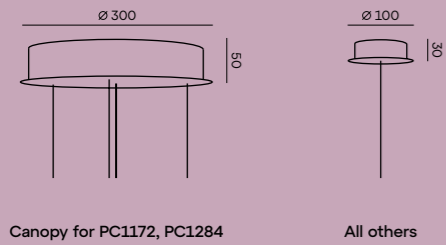

Canopy

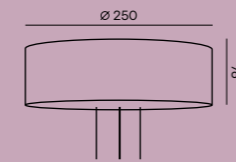

Incl. PWM dimming system

p. 183
PH7392

p. 187
PH3799

p. 184—185
PH3803

p. 186
PH7566

p. 189
PH7419

p. 194
PH1327

p. 190—191
PH6801

p. 195
PH1391

p. 192—193
PH5643

p. 196—197
PH5402

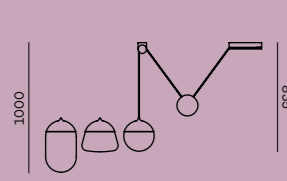

1060

PC1234

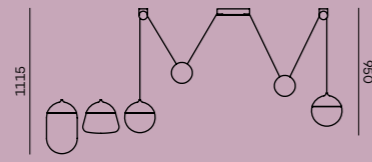

1670

PC1235

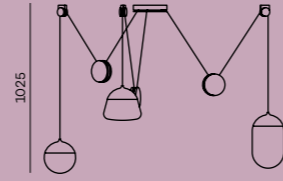

1825

PC1236

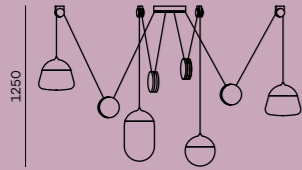

2050

PC1237

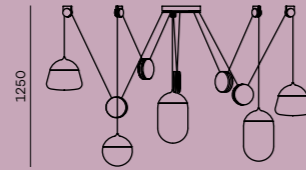

2070

PC1238

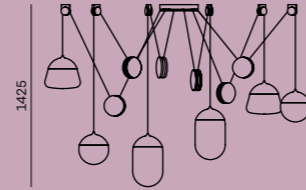

2080

PC1239

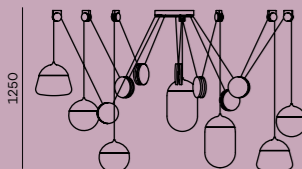

2090

PC1240

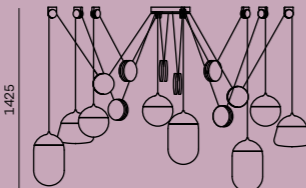

2134

PC1241

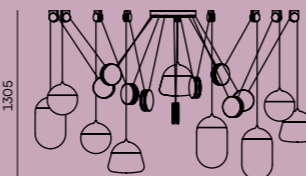

2165

PC1242

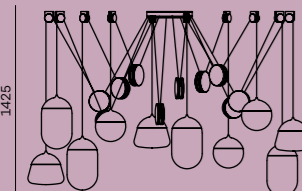

2185

PC1243

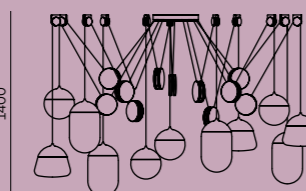

2195

PC1244

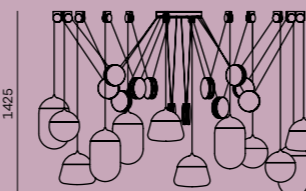

2185

PC1245

Canopy

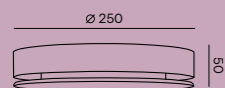

Canopy
for PC1234-PC1237

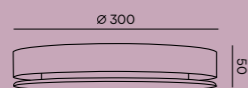

Canopy
for PC1238-PC1241

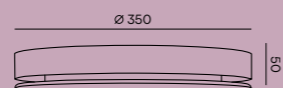

Canopy
for PC1242-PC1245

p. 199
PH5711

p. 203
PH3634

p. 200—201
PH5701

p. 204—205
PH5686

p. 202
PH5702

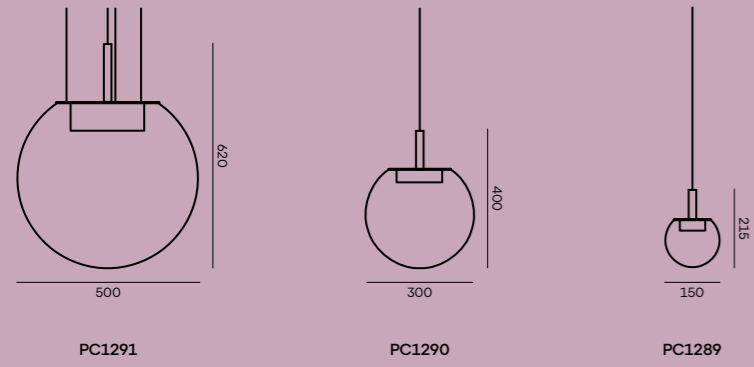

Canopy

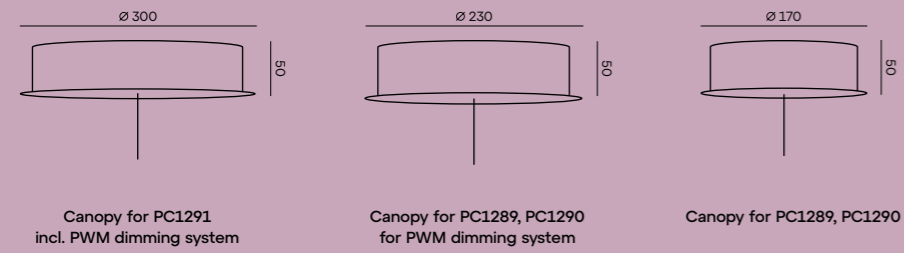

- p. 207
PH9514
- p. 208
PH8343
- p. 209
PH8748
- p. 210—211
PH9560

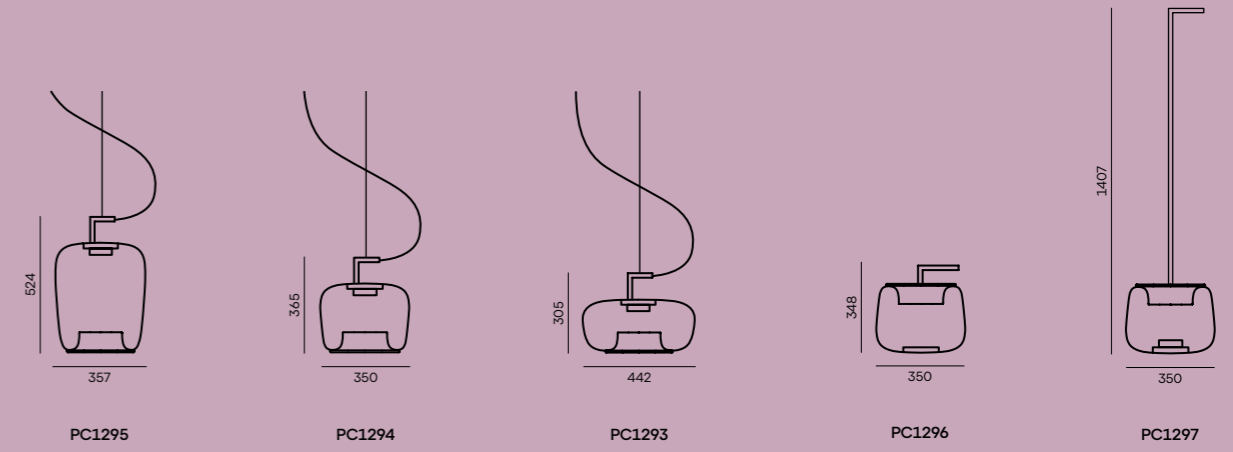

Canopy

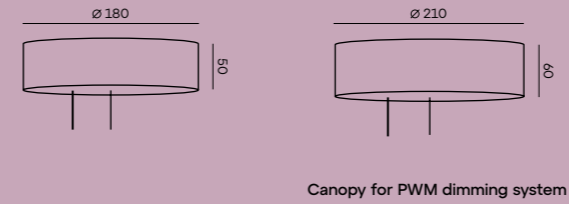

- p. 15
PH9614
- p. 213
PH8356
- p. 214—215
PH10086
- p. 216—217
PH10094
- p. 218
PH8207
- p. 219
PH10090
- p. 220—221
PH8179

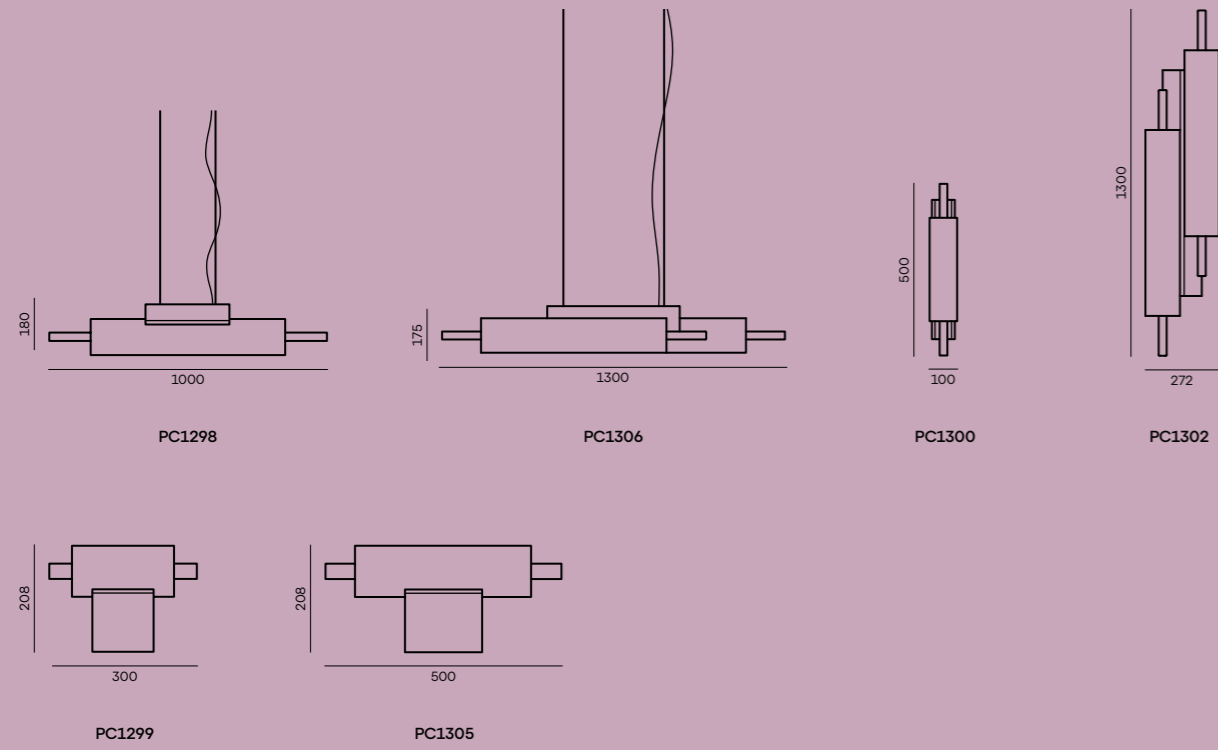

Canopy

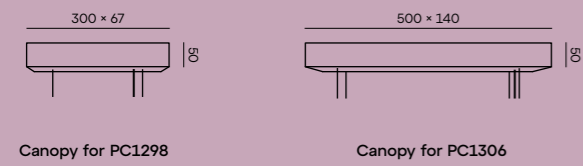

p. 13 PH10062	p. 225 PH9350	p. 230 PH8771
p. 222—223 PH10840	p. 226—227 PH11233	p. 231 PH8754
p. 224 PH10831	p. 228—229 PH9347	p. 232—233 PH9348

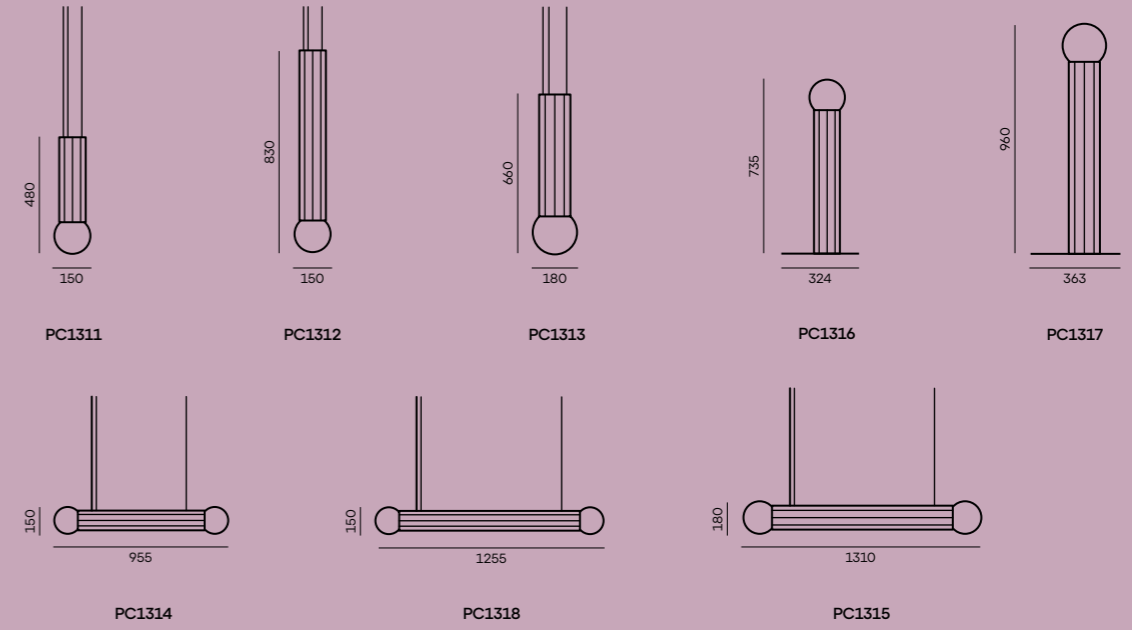

Canopy

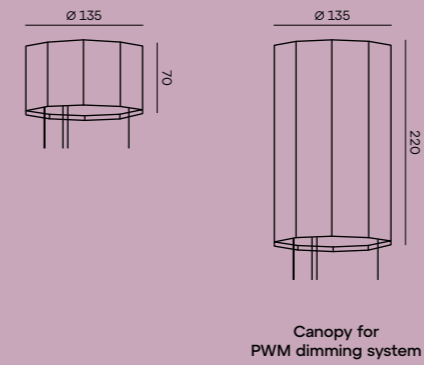

p. 235 PH9308	p. 239 PH11280	p. 243 PH9055
p. 236—237 PH11284	p. 241—241 PH9314	
p. 238 PH9315	p. 242 PH9352	

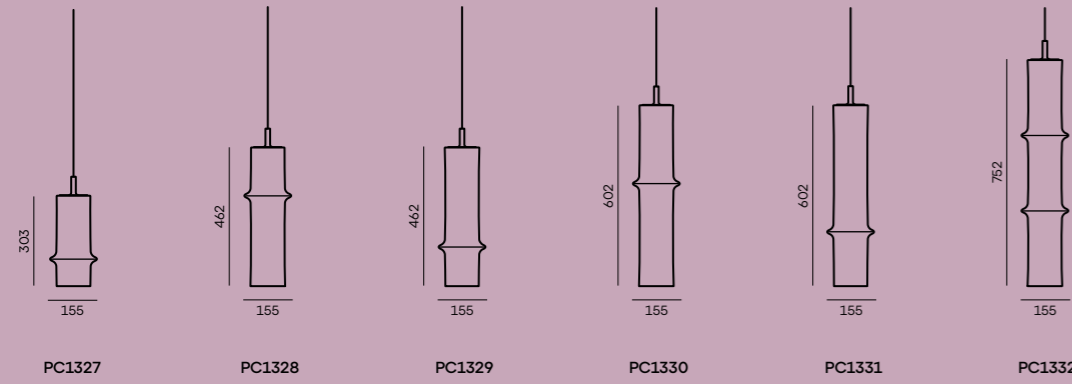

Canopy

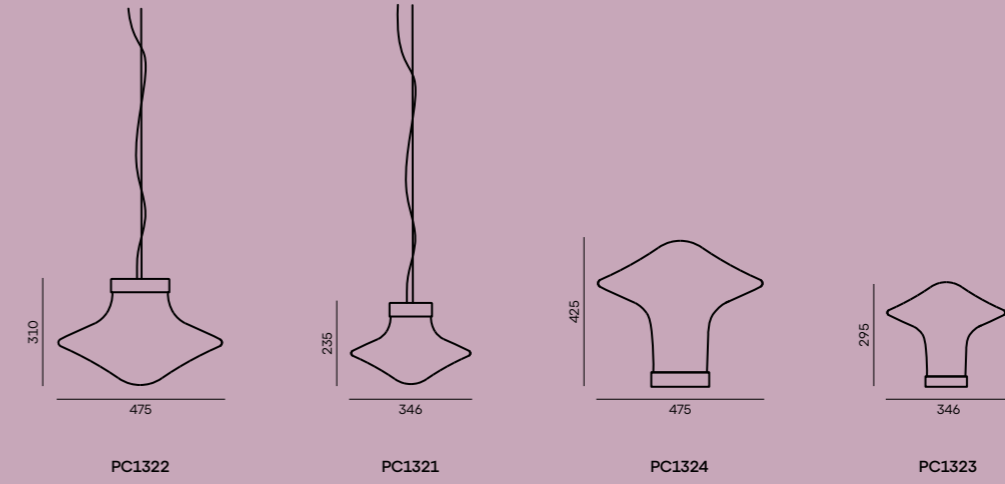
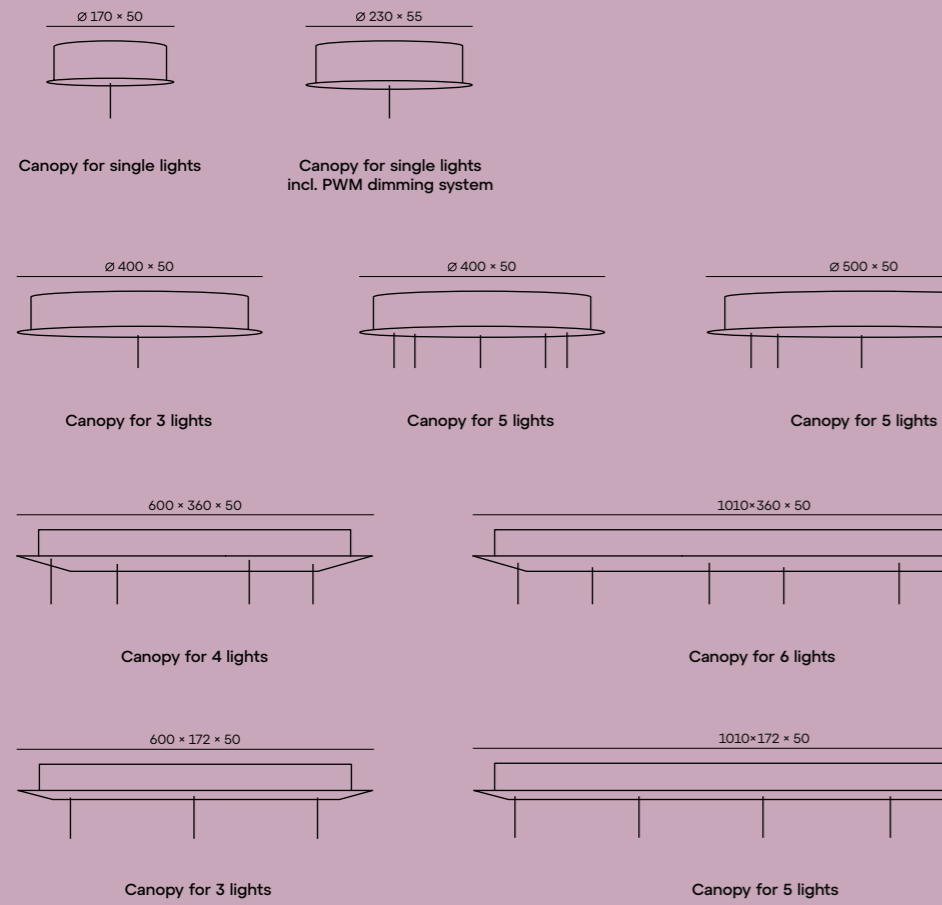

Canopy

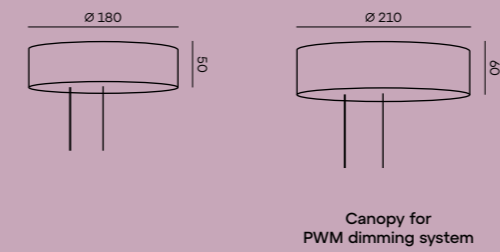

Cover PH10762	p. 247 PH10610	p. 252 PH10638
p. 245 PH10843	p. 248—249 PH10633	p. 253 PH10611
p. 246 PH10757	p. 250—251 PH10761	

p. 255 PH10015	p. 259 PH11247	p. 263 PH11242
p. 256—257 PH10969	p. 260—261 PH10309	
p. 258 PH10311	p. 262 PH10312	

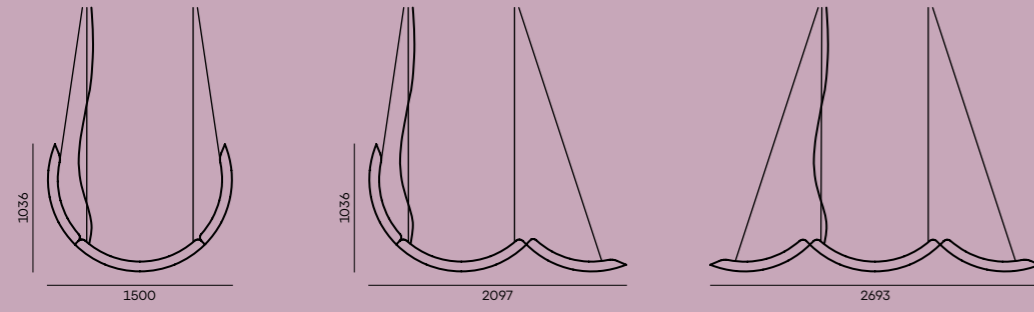

PC1326

Canopy

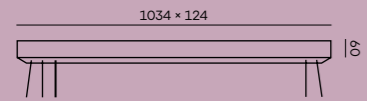

p. 265
PH10673

p. 270
PH10657

p. 266—267
PH10658

p. 271
PH10660

p. 268—269
PH10645

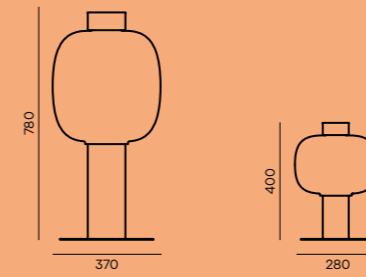

PC1167

PC1166

p. 275
PH2574

p. 278—279
PH2576

p. 276
PH2571

p. 280
PH3492

p. 277
PH3556

p. 281
PH3853

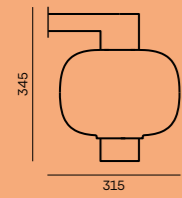

PC1280

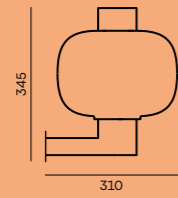

PC1251

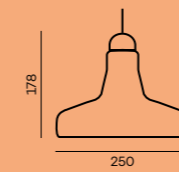

PC1160

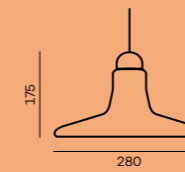

PC1161

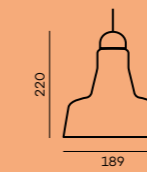

PC1162

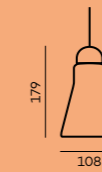

PC1163

Canopy

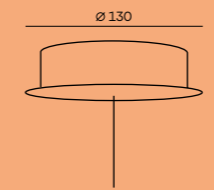

p. 283
PH7401

p. 284
PH7403

p. 285
PH7405

p. 287
PH2267

p. 288
PH2269

p. 289
PH2958

p. 290—291
PH2960

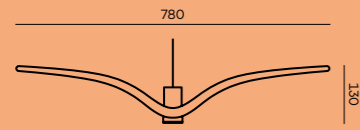

PC1111

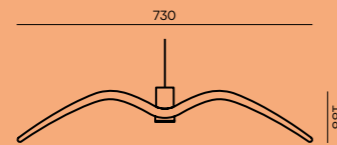

PC1112

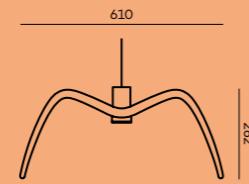

PC1113

Canopy

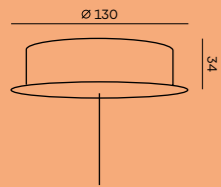

p. 293
PH2383

p. 297
PH2359

p. 294—295
PH3100

p. 296
PH2265

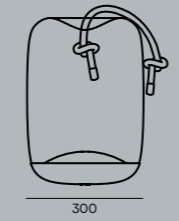

PC1249
Cilindro



PC1250
Small Cilindro

p. 301
PH8180

p. 302
PH6873

p. 303
PH6566

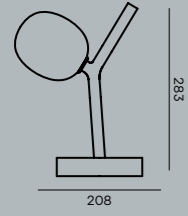

PC1233

p. 305
PH6260

p. 308—309
PH6261

p. 306
PH6565

p. 307
PH6259

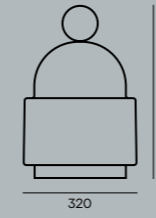

PC1265

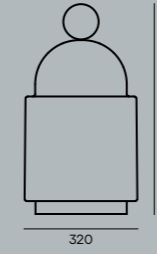

PC1266

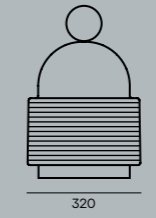

PC1287

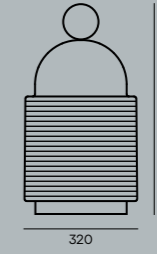

PC1288

p. 311
PH7476

p. 314—315
PH7490

p. 312
PH7644

p. 316
PH7648

p. 313
PH7474

p. 317
PH7647

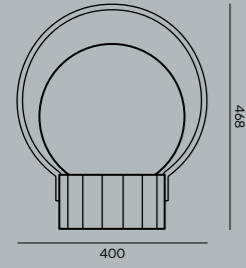

PC1273

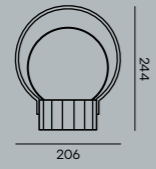

PC1271

p. 319
PH9299

p. 323
PH8109

p. 320—321
PH7606

p. 324—325
PH7558

p. 322
PH7459

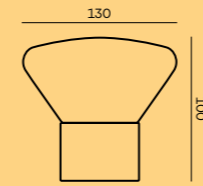

PC1008

p. 328—329
PH5811

p. 332—333
PH977

p. 330
PH5973

p. 331
PH5808

The lights are listed in the index in the same order as they appear from left in the photograph. For groups of more than five lights, only the codes of the lights are given without further specification of their number within the given photograph.

IMPORTANT INFORMATION

BROKIS products and services can be found on the latest version of our website – www.brokis.cz. Our sales partners are regularly informed of news and any changes to products and/or services. In order to streamline cooperation with our sales partners and promote sales of our products and services, we've created new marketing tools, which are available through the MY BROKIS partner platform at www.mybrokis.cz. These tools, which include ordering, informative documents, PR materials, and an overview of complementary services, support product sales growth and help us develop. BROKIS is also introducing optional product registration, which will allow customers to verify the authenticity of their lights. More information on product registration can be found in a special QR code at the end of the catalogue.

CLEANING INFORMATION

As with all products, BROKIS lights require periodic cleaning. Dust, grease, and film affect the visual quality of any item made of glass.

It is in the interest of the user to maintain the singular appearance of the lights. This can only be achieved through regular cleaning. When neglected, the cleaning process becomes unnecessarily time consuming. The cleaning interval depends on the environment the lights are installed in and is primarily influenced by humidity levels, temperature stability, and the amount of dust in the air.

BROKIS applies the highest possible quality standards in manufacturing its lights. Prior to shipping, each light undergoes several quality controls and stages of cleaning. Lights may require additional cleaning as a result of transportation, storage, and the amount of time that passes between packing and subsequent unpacking by the client. Therefore, we recommend cleaning the lights prior to installation.

RECOMMENDED CLEANING METHODS

When cleaning lights from any of our collections, we recommend first disassembling them according to the instructions in the installation manual and then securing the glass components against mechanical damage.

The glass must first be rinsed in hot water and a dilution of dish detergent to remove all foreign particles and dust. Repeat this process if necessary. The glass must then be cleaned a second time using hot water and a dilution of degreaser (such as ammonia or vinegar) and thoroughly rinsed under running hot water. Repeat this process if necessary. Next, dry the glass thoroughly with a paper or a soft cotton towel. Only reassemble the light once the glass has cooled completely.

Do not use mineral spirits, highly concentrated thinners, or other substances not intended for use on glass surfaces. Do not use products containing silicone, since they quickly attract more dust and grease.

BROKIS WEBSITE



BROKIS PROJECTS



MY BROKIS



PROMO VIDEO



BROKIS VIRTUAL PROJECTS



BROKISGLASS



BROKIS CATALOGUE



TECHNICAL INFORMATION ABOUT PRODUCTS



Cleaning information and unpacking the box



Technical information



Product registration



ARCHI TONIC



archiproducts



archilovers



Linktree*



Linktree is a platform that brings all important links together in one place.

BROKIS, s.r.o.

OFFICE

Španielova 1315/25
163 00 Prague 6
Czech Republic

SHOWROOM

Sídlíště Janštejn 39
588 52 Horní Dubenky
Czech Republic

www.brokis.cz
info@brokis.cz

DESIGNERS

Lucie Koldova
Dan Yeffet
Boris Klimek
Chiaromonte Marin
Fumie Shibata
Lenka Damová
Vrtiška&Žák
LCM MARIN design studio
Federico Peri
Filippo Mambretti

PHOTO

Martin Chum
Adéla Havelková
Kristina Hrabětová
Lukáš Pelech
Jan Voharčík
Denise Keus
Zbyněk Krulich
Polygoniq
Studio Salaris
SUPREMA
Artur de Menezes

GRAPHIC DESIGN

Studio Marvil

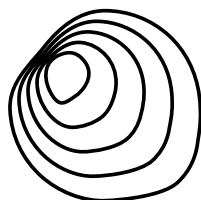

BROKIS®

CM16538

