

THE LIGHTING BIBLE® 14

 **DELTA LIGHT®**



WELCOME

TO OUR WORLD.



IMAGINE

The Lighting Bible 14 – IMAGINE, invites you on a journey of inspiration.

A world of wonder to explore new ideas and an escape into enlightenment.

Abundantly illustrated with breathtaking photography of architectural realisations from across the globe, **The Lighting Bible 14 – Imagine**, represents our craft, where we dream up a world of light.

You will find plenty of information about our collection of architectural lighting solutions throughout these pages. Are you looking for in-depth technical product details?

Extensive product information can be found throughout our website.

deltalight.com offers you complete, up to date product information at your fingertips.

The Lighting Bible 14 is available in two editions.

Imagine invites you to enter a world of imagination, whilst **The Lighting Bible 14 – CREATE**, celebrates the products that make up the Delta Light collection. With detailed product photography and comprehensive product information, the focus is on application and creation.

Would you like to order a copy of **The Lighting Bible 14 – Create**?

Head over to deltalight.com/14 to request your copy today.

**PURE
LIGHTING
PLEASURE.**

 DELTALIGHT®

Purity is key in our latest edition of
The Lighting Bible. Deep in the core of our
DNA is the mission for Pure Lighting Pleasure.

The Lighting Bible 14 brings you a collection
of pure lighting experiences with a language
of its own to enhance the human experience
of architecture and nature. Our luminaires offer
the building blocks for unique creations of
brightness, atmosphere, and emotion.

Sophistication in technology and purity in
design unite in our collection. We offer
lighting that pushes the boundaries of
technology and engineering whilst bringing
a feeling of comfort, elegance, excitement
and purity. Explore our complete collection
of lighting solutions and experience pure
lighting pleasure.

WE MAKE LIGHT

that makes you see.
Light that makes you look.
Light that animates the world,
around you.

PAUL AMELOOT



Jan, Paul & Peter Ameloot



WE MAKE LIGHT

We develop lighting solutions to improve people's quality of life. We offer our lighting expertise to architects, interior designers and lighting designers, to help them realise their vision and create a lighting scenography that integrates into the architecture. Using the right lighting, in the right way, enhances and complements architectural concepts.

We strive to be the very best in everything we do. With our extensive experience in product development, manufacturing, and design since 1989, we approach the future with ambition and confidence. We continuously invest in people, new markets, production technologies and our infrastructure - to improve our service capabilities, expand our R&D department, test facilities and laboratory, increase the level of warehouse automation and expand the House of Light training centre. As a family business, we are happy to share our passion, creativity, and dedication. Our aim is to inspire people all over the world. As a family, we have a personal stake in making your project a success.

PAUL AMELOOT

Entrepreneur Visionary Designer

Paul Ameloot created Delta Light in 1989 in the Belgian city of Roeselare, realising his dream to design and manufacture architectural lighting. The local success story soon went global, with the participation in international events from the get-go. Today Delta Light is active on all continents, while still honouring our local roots. "I started out designing and developing all products myself. Even though today we have a team of 35 engineers, I still contribute my vision and ideas. Because once a player, it's hard to become a fan, sitting on the bench and watching the game. My dream really came true, not to forget, together with my wife Katrien. Our sons, Peter and Jan, continue to make that dream grow."



**WE
ARE
DELTA
LIGHT**



IN-HOUSE DESIGN

The lighting industry is constantly evolving, providing both challenge and opportunity. It fascinates us to keep on bringing **new designs and lighting solutions** to the market. You could consider it a passion to continuously surprise and inspire people with new lighting languages.

An essential attribute in Delta Light's creative process is the extensive in-house design, development, testing, engineering, and manufacturing of all products. This enables us to achieve our short idea-to-market philosophy, resulting in extensive new collections being launched on a regular basis.

Our **in-house design team** crafts cutting-edge lighting solutions, that combine an architectural design language, a minimalist approach, and a boldness that challenges the boundaries of technology. In-house design is the foundation of our product portfolio, but we also love to collaborate with **architects and designers**, from different industries to create and innovate.

Delta Light's extensive design and R&D teams are constantly discovering future trends, both in terms of design and use of materials, whilst remaining focused on **the power of imagination**. Its creative statement is supported by the opinion of expert panels, resulting in prestigious awards for our collection of products, including IF Design Award, Good Design Award, Red Dot Design Award plus many more..

We are focused on the detail. The looks, how a fixture moves, how it can be specified and installed, the ease of enjoying the light and so much more. With a surprising visual simplicity, our products are the result of extensive research and testing, fusing advanced technology with timeless design and sustainable materials.

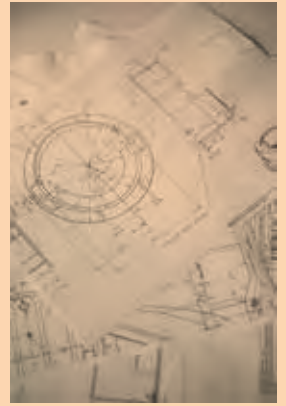



CONTINUOUS RESEARCH & INNOVATION

Delta Light has been at the forefront of lighting technology for over 30 years now, and we continue to push boundaries, both in interior and exterior lighting. Our investment in R&D, production and innovation aims to deliver outstanding luminaires, blending contemporary design with high-quality materials, advanced engineering, the very best performance and a long lifespan.

RESEARCH & DEVELOPMENT

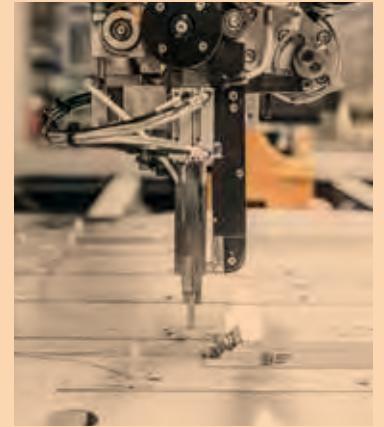

CUTTING-EDGE LED TECHNOLOGY

As luminaire designers and manufacturers, we always strive to create the best possible thermal conditions in the luminaire, to ensure the LEDs operate at their optimum. From the design of the LED circuit boards and heat sink, to the selection of materials, to the assembly process and installation techniques... everything is engineered to reach optimal life expectancy and maximum efficiency.

By partnering with the best LED suppliers in the world, we ensure a consistent LED selection with colour uniformity across all product ranges. A minimum of MacAdam Step 2 is standard throughout our collection, whilst many of our new collection LEDs offer MacAdam Step 1.

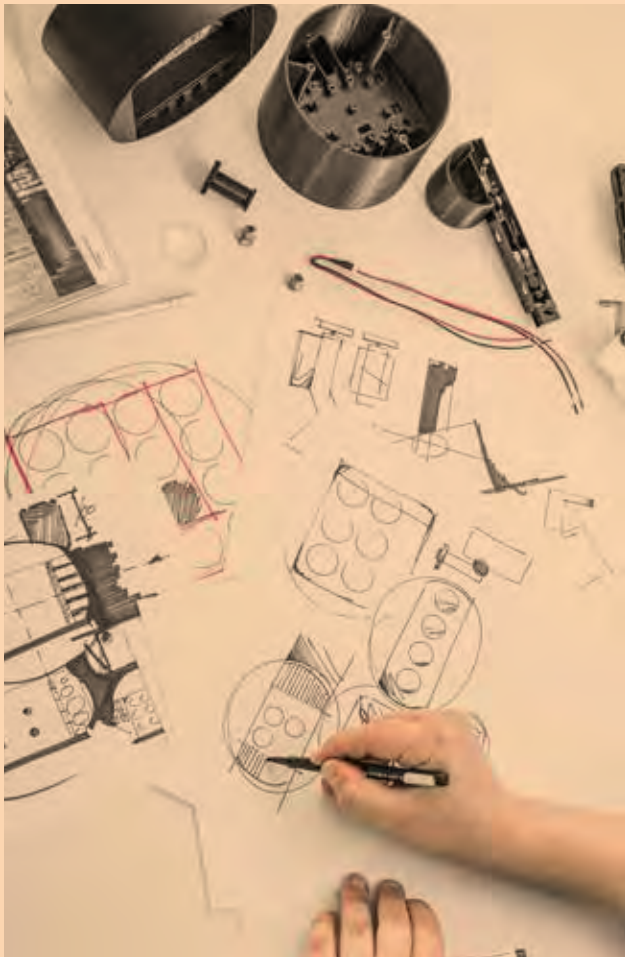



CERTIFIED LABORATORY TESTING

Product quality and safety testing within our Delta Light laboratory conform to the International Electrotechnical Commission standards. The close cooperation and CTF stage 3 acceptance with our certifying partners SGS-CEBEC and INTERTEK leads to CE, ENEC and CB certifications for European and IEC member countries www.members.iecee.org/

Our laboratory also covers the certification of products for the North American market by being certified as a level 4 satellite laboratory for INTERTEK.

This allows us to efficiently obtain the cETLus listing for our standard North American product range and provide exceptional service for even the most demanding customer specific solutions. www.intertek.com/directories/etl-listed-mark/

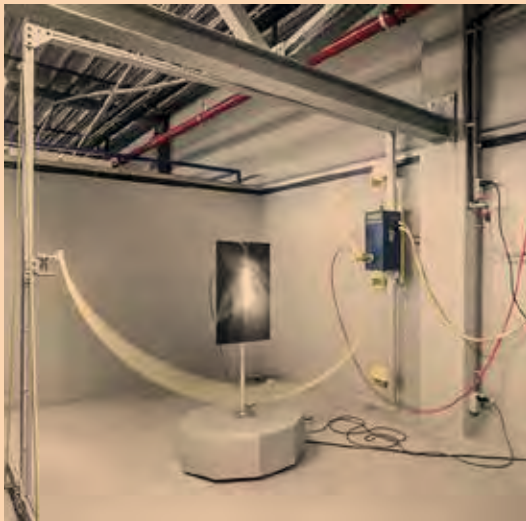



ADVANCED OPTICS

Delta Light's team of engineers and optic experts are on a continuous quest to match the company's credo for design with energy-efficiency and optimal quality of light. Delta Light's collection is ready to meet the needs of today's architecture, interior and landscape design, and to illuminate with impact.

We offer different precision light distributions to fulfil various requirements, with high uniformity, for demanding applications. CAD-engineered and precision manufactured lenses deliver a tightly controlled light distribution. The variety of optics, beams and other features enable designers to meet the various illumination needs.

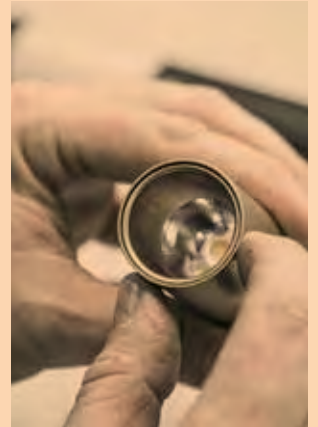

STATE OF THE ART DEVELOPMENT TECHNIQUES

An important feature in Delta Light's creative process is the use of state-of-the-art development techniques. The intensive use of 3D printing, early stage FMEA (Failure Mode and Effect analysis), goniophotometer measurement and an in-house third party recognised lab (SMT/CTF/satellite data acceptance) result in a fast, efficient and 'first time right' development process. As such, it is an essential attribute in the company's short idea-to-market philosophy.

Throughout the entire production process Delta Light distinguishes itself by handling **the strictest quality parameters**, to ensure products and services are designed and produced to exceed customer requirements. Every step in the production process has a routine quality procedure, covering both product quality and testing. Every single product that leaves Delta Light, has been inspected and tested thoroughly, resulting in minimal returns and maximum efficiency.





HIGH-QUALITY

Delta Light maintains the highest standards in everything we do – including in the choice of materials, the technology and the coating process. Many of our product ranges feature special coating on critical parts (e.g. screws, bolts, latches etc), combined with high-quality alloy and specialist paint.

To avoid the problem of oxidation and corrosion of outdoor products, Delta Light uses a prime selection of aluminium alloys with a low content in copper. The protection by anodizing treatment, on all suitable components including die-cast aluminium ones, improves the resistance against corrosion. The titanium-based conversion layer offers a further protective layer for protection prior to the final polyester painting.

We apply extensive pre-painting surface treatments for maximum protection against corrosion, such as acid washing to clean the surface, rinsing with demineralized water to remove residue, and the application of a chemical conversion treatment to protect against rusting.

Our polyester powder colour coating is based on saturated polyester resins, electrostatically applied and oven cured at 200°, guaranteeing high resistance to atmospheric ageing and UV light exposure. Extra resistant surface paint is guaranteed by filiform corrosion testing with an exposition of over 1500h.

All coating procedures are followed by daily careful testing. Strict controls are constantly maintained over the parameters of every step in the process, such as purity, pH, chemical concentrations, temperature, etc. This ensures the best achievable substrate penetration and uniformity of the conversion coat, thereby ensuring optimum corrosion resistance and powder-coat adhesion.





Architect warchitekten

Architect ANARCHITECT



Interior Design Omar Abdelghafour - Light Space Design / Concept Black For Green Scape



Architect Mallol Arquitectos / Lighting By Led Life Panama



Architect Studio2 Architects

Architectural Project Dino Krizmanić, Leonid Zuban (Urbis) / Lighting Design Dean Skira (Skira)

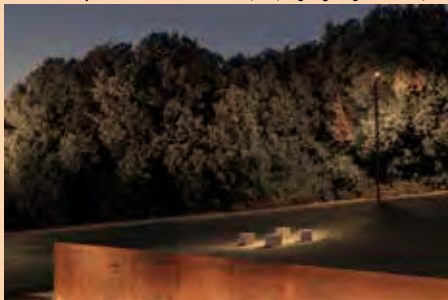

Architect VK Architects & Engineers



GLOBAL

Since our foundation in 1989 we have developed from a small Belgian company to become a global business, offering lighting solutions and services in 120 countries worldwide.

In addition to the Belgian headquarters we have Delta Light branch offices and partners on all continents and in key design capitals, from Miami to Bogota, Amsterdam to Dubai, Saint-Petersburg to Hong Kong, New York to Milan, Toronto to London and many more. Our goal is to support the international projects personally and locally.

Delta Light caters for some of the world's most well-known brands and architects, providing sophisticated and value add lighting solutions to **residential, office, hospitality, retail, landscaping, showroom, and public projects**. From small to super large scale, Delta Light has the product range, experience, and knowledge to meet the functional and aesthetic needs of your projects.

Each project requires a customised approach, and as such Delta Light recognises this with an exceptional package of services and design tools. Our global team works with all stakeholders involved to achieve the best possible results.

Starting with initial concept lighting support to the installation process and project follow-up, and everything in between. Be it for technical or application questions, performance and energy saving studies, custom designs, and made-to-measure solutions, rendering or graphics, or any other lighting support needs... Delta Light provides a one-stop-shopping solution for your projects.

Architect Arias Serna Saravia



SUSTAINABILITY

We recognise that our business activities are associated with responsibility for ecological awareness and health and sustainability, and as such we treat these issues as a priority.

Our quest for sustainability at Delta Light is translated in continuously striving to make our products and operations more efficient, durable and environmentally friendly. With each new collection, come new technological developments, evolutions in recyclability, and in efficiency of material use, production and transportation. These efforts have seen us win awards such as Lighting For Good Awards in 2019 and 2020.

Today we can say our production operates on a self-powered renewable energy model. Our headquarters in Belgium are equipped with solar panels that provide enough solar energy to cover the energy need of our entire production line and of the office site.

Recycling and production waste management is a key theme that is reflected in our production processes, such as our handling of aluminium scrap. Many of our luminaires are created from aluminium profiles. We optimise the usage of these profiles; however, waste is inevitable. As aluminium is 100% recyclable, all aluminium waste is collected for recycling.

At our Belgian headquarters and at our global offices we take pride in providing a healthy, safe, and balanced environment for all employees. Our efforts in sustainability and wellbeing as an employer and manufacturer have earned us a 2019 Silver Medal by the independent monitor Ecovadis.



**THINGS
TO SEE.**



**MULTINOVA
MULTI-APPLICABLE**

Multinova has something familiar and something fresh at the same time. As a disc of light, Nova refers to the Supernova range, as both families share similarities in looks and ways of installation. But Multinova is slimmer and has some additional features to make it multi-applicable, hence Multi in the name.



**CUSTOMISE
YOUR SUPERLOOP PLUS**

Meet the newest member of our Superloop collection. Superloop Plus features an integrated decorative panel, for you to customise. Our proposed options are light and dark grey felt in recycled PET. However, you can tailor the panel to the design of your project, in felt, leather, wood, textiles and more. Discover the unlimited possibilities.



**ARTUUR,
SOPHISTICATED DETAILS**

Everything about Artuur catches the eye, be it its design, its optical compartment or its small protrusion when installed into the ceiling. Artuur adds depth into the room owing to its gentle protruding ring. Small enough to be noticed, big enough to make a difference.

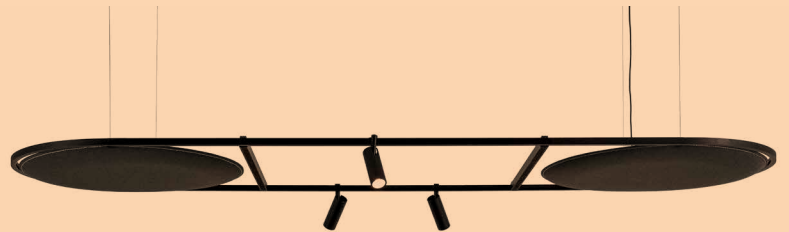

SOLISCAPE

An extremely versatile and flexible system, specifically designed to create human-centric environments. Developed together with **UNStudio**, Soliscape combines lighting, acoustics and IOT into an aesthetically appealing solution. Soliscape presents a toolbox with flexible components to architects and designers, to create unique constellations in human-centric environments.

**HALOSCAN,
DESIGN FOLLOWS OPTICS**

Designed around its flat optics, Haloscan combines ultra-minimalistic looks with a pleasurable light effect. With its different finishing colours, multiple beam angles and various installation options, Haloscan is perfect for creative compositions throughout an entire project.



ZOOVER, GENTLE TEXTURES

Zoover adds volume, depth and texture to the room. Designed as a shallow dome, Zoover has different looks depending on the point of view. Looking at it from aside, the thermoformed shell has a very neutral appearance. Only when lowering the viewpoint, more and more details catch the eye: a performant light grazing the inner dome.



A NEW TAKE ON SPY

In our continuous search for better user comfort with more precise optics and better light control, the complete Spy range has been upgraded. The result? Fresh shapes and additional finishing colours, better light comfort through hybrid optics, improved LED colour consistency and new perspectives with Tunable White and Soft Dim.



NEXT GENERATION

This Bible is not only filled with novelties, some longstanding Delta Light classics got upgraded too. Fresh designs, a more modern look, better CRI, new or improved optics, ... ready to shine on in the coming years. Have a look at the redesigned Kix, our upgraded Spy family, Minigrid and Deep Ringo extensions, the rebirth of Backspace and Walker, and more.



VISUAL COMFORT FOR OFFICES

The Lighting Bible 14 offers a whopping new array of technical architectural office lighting. Each with its own set of technological advantages and unique design language. While Inform focuses on Melanopic Light Technology (MLT), Conform by Dean Skira is equipped with Natural Light Technology (NLT). Both technologies are developed in-house and are focused on human wellbeing, to boost and support the human circadian rhythm.

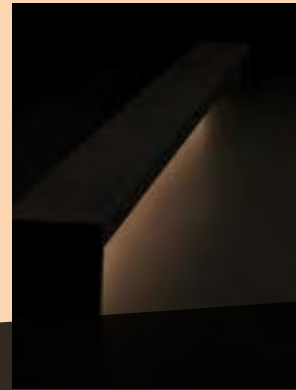

LIGHT QUALITY OUTDOOR

Delta Light's team of engineers and optic experts is on a continuous quest to match the company's credo for design with an optimal quality of light.

With the new Frax we have taken our fascination for the perfect beam outside. Clean-cut light distribution to boost your outdoor experience. Outliner and Skov perfectly shield the light, offering an unobtrusive solution to guide you the way.



CONNECTED SURFACES

First introduced in 2003, Connect was based on 2 fluorescent tubes facing opposite directions to graze light on 2 right-angled surfaces. Today, Connect balances on the edge between wall and ceiling or wall and wall, as you like.



INVISIBLE YET TANGIBLE

Impressed by his extensive expertise and passion during the design of the Polesano, we decided to go on our next adventure with lighting designer Dean Skira. Together with Dean we take you on a journey to the ultimate minimalism, introducing Nime.



REFLECTIONS

A new set of experiences has joined our decorative Reflections range. The playful pendant lamp Mantello challenges the classic shape of a lamp shade, playing with dimensions and textures. While the aluminium edition is opaque with a matte finish, its counterpart is transparent and glossy, crafted from mouth blown glass.

The pendant lamp Still is created by the Belgian designer Nathalie Dewez. The lamp plays with balance and movement. With its light source off centre from its point of suspension, it creates an ever-changing elegant dynamic. Poetic and playful, Still truly represents the spirit of Reflections.



STRETCH CEILING

Our collection of luminaires offers a wide range of lighting possibilities and styles for stretch ceilings, from surface-mounted to recessed luminaires - and even recessed magnetic profiles.

New in The Lighting Bible 14 is a range of mounting kits to be used for our trimless luminaires, an easy trimless installation into stretch ceilings!

5 YEAR WARRANTY

At Delta Light we have full confidence in the quality of our products. All of our products are designed and manufactured according to the highest standards, using nothing but the best parts and technology. As a proof of our commitment we offer a 5-year LED warranty, starting as from the date of delivery of the product to the authorised distributor of Delta Light NV. Read about the details and conditions on the Delta Light website.

TECHNOLOGY EMBRACED

Colour consistency has always been a point of attention within the Delta Light product range. Up till now we have been using SDCM 2 - the best available - but in this Lighting Bible we introduce COB LEDs with SDCM 1, together with COB LEDs in Tunable White or Soft Dim. Lots of new solutions within both existing and new families.

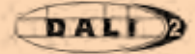

New installation facilities are available in our exterior products by offering 24V-DC solutions. Beloved families like Kix and Logic now come with a 24V-DC convertor included, making it possible to put a save 24V-DC line throughout the garden and connect the luminaires in parallel.



DALI is one of the most frequently used dimming systems for projects no matter what scale. As leading company in lighting and member of DiA, we embrace new technologies and a transition to DALI-2 is a logical next step. As such, all DALI dimmable luminaires and remote drivers in this edition of the Lighting Bible are DALI-2 compliant.

Last in line is the new design of the suspension and connection components. To keep the focus on the luminaire instead of its suspension we introduce a nearly invisible suspension with Small Trim (ST), next to the existing trimless suspension sets. A quick and easy way for a neat suspended light setting.

**DESIGN
COLLABS**

Throughout our history we've focused on creating lighting solutions that can enhance any building or setting. For some of these collections we have collaborated with external designers, opening up new exciting adventures in lighting.

Merging the vision and concepts of these leading architects and designers with our in-house R&D and production expertise, exemplifies how Delta Light, hand-in-hand with them, continues to step into the future.

UNStudio

SOLISCAPE

UNStudio, founded in 1988 by Ben van Berkel and Caroline Bos, specialises in creating ground-breaking architecture and design at all scales, from bridges to public buildings, offices, residences, exhibitions, products and urban masterplans. With over 120 completed projects in Asia, Europe and North America, the studio continues to expand its global presence with recent commissions in the United Arab Emirates, China, South Korea, Italy, Germany and the United States, amongst other countries. The name UNStudio stands for United Network Studio and refers to the collaborative nature of the practice.

"As what we design today is normally built in three to five years' time, we're used to working with the future in mind. However, the future is changing faster than ever before. Even the most accurate predictions can be made redundant by a sudden advance in technology. To ensure we don't contribute to a waste of materials and investment that is no longer sustainable or appropriate in today's world, we develop strategies that not only anticipate the future, but possible changes to that future as well."

UNStudio and Delta Light have joined forces to endeavour to improve the wellbeing of people in our rapidly changing work environments, where human health and the war on talent have become a primary focus of employers. Together we developed SOLISCAPE, a lighting system that facilitates, responds, and contributes to solving these complex challenges. An extremely versatile and flexible lighting toolbox specifically designed to create human-centric environments.



BEN VAN BERKEL

Professor AA Dipl. (Hons), (F)RIBA, Hon. FAIA
Founder / Principal Architect UNStudio
Founder UNSense

In 2018 Ben van Berkel founded UNSense, an Arch Tech company that designs and integrates human-centric tech solutions for the built environment. Ben van Berkel has lectured and taught at many architectural schools around the world. From 2011 to 2018 he held the Kenzo Tange Visiting Professor's Chair at Harvard University Graduate School of Design, where he led a studio on health and architecture. In 2017, Ben van Berkel also gave a TEDx presentation about health and architecture. In addition, he is a member of the Taskforce Team/Advisory Board Construction Industry for the Dutch Ministry of Economic Affairs.



DEAN SKIRA

NIME - POLESANO - CONFORM

Dean Skira is the founder of Skira, an award-winning practice based in Pula (Croatia) with projects also in the EU, Middle East, Russia, Canada, and the United Kingdom. For the past 30 years, he is building and creating mostly with intangible forms while working with investors, architects, and designers to create meaningful lighting experiences.

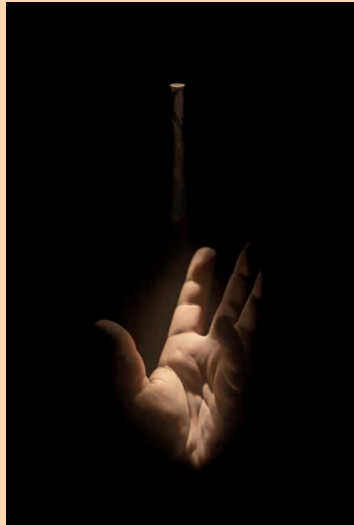

NIME

The absence in its presence
The presence in its absence

With a miniature aperture of only 10mm, Nime focuses on what is important and puts it in the spotlight. It is not about Nime, it is about what Nime can do. The combination of its focusable beam angle together with its adjustability allows for a multitude of application possibilities, while maintaining a uniform, minimalistic look and feel throughout the project.

POLESANO

Modularity and flexibility to illuminate the urban fabric Polesano is a new concept in lighting instruments, designed specifically for urban settings, be that a pedestrian pathway, roadway, park, square, façade, or landscape. Polesano provides maximum flexibility for the designer to combine different optical characteristics, whilst keeping the same aesthetic for the entire system, regardless of the area.

CONFORM

Comforting for the human eye, showing vibrant colours, and boosting human activity.

Its elegant design with multiple colour combinations, its specific sun mimicking spectrum, its low UGR, its well-balanced down-up ratio... Conform is designed around the light. It not only perfectly embraces the light source, but it reinforces it in multiple aspects. Conform uses Delta Light's Natural Light Technology (NLT), state of the art LEDs with a spectrum that very closely matches that of the sun.

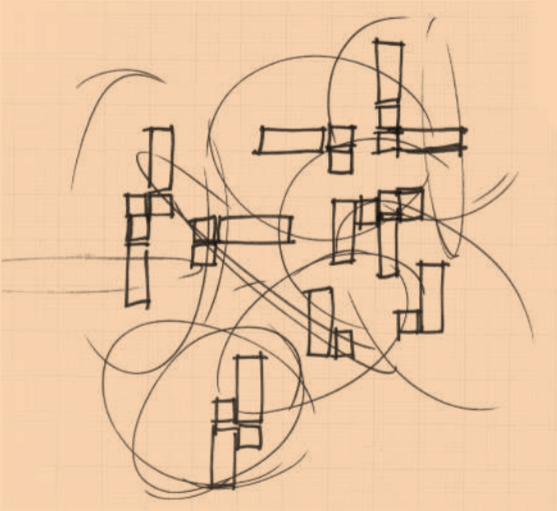
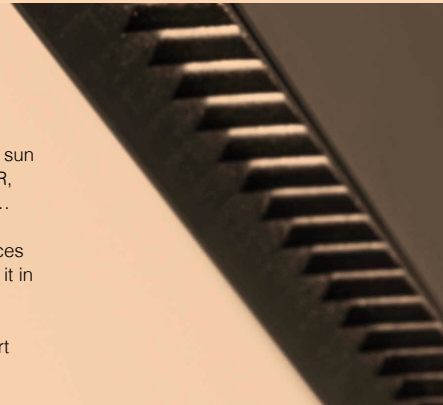

NITEO LIGHTING

NEEDLE

Niteo is a premiere lighting design studio with offices in Seattle, San Francisco, and Singapore. With a portfolio ranging from museums to personal art collections, corporate offices to retail, and landscapes to art displays, their intimate engagement through design attention to detail is evident. Niteo delivers elegant lighting solutions via leveraging decades of experience in a collaborative and technically savvy way.



Delta Light collaborated with Niteo's Seattle office to develop the Needle. This bespoke luminaire was devised to provide a playful solution in an elegant form. As a single or grouping of multiple fixtures, the slender and flexible design permits it to blend into ceilings, peek around corners, or demurely clamor attention.

OMA

XY180

OMA is an international practice founded by Rem Koolhaas, operating within the traditional boundaries of architecture and urbanism. AMO, a research and design studio, applies architectural thinking to domains beyond. XY180 is a 3-piece collection of luminaires designed by OMA. The collection was born from a fascination with point, line and surface, key characters in the discourse of architecture. The collection uses precise geometric proportions. The base elements, which include a tube light and a spotlight, can be combined with a hinge, to generate countless light conditions, both essential and complex.



STILL

The work of Nathalie Dewez extends from small objects to monumental installations, from unique pieces to industrial products. Her designs reveal the passion for sculptural shapes and superior craftsmanship. Some of her iconic pieces have been awarded several times. Nathalie is a designer whose main medium is light and whose materials vary between metal, glass and other long-lasting medium, whether designing light fixtures, objects, furnishings, or large-scale sculptures. The Still lamp works as a mobile. This pendant lamp has the particularity of having the light source off-centre from its point of suspension, creating an ever-changing elegant dynamic. Due to its big length it dresses and emphasises a space, without the clutter.

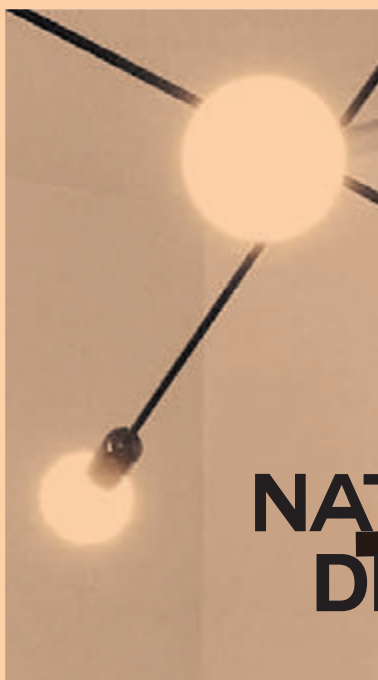

**NATHALIE
DEWEZ**



CHAPTER INDEX

2 – 335

INTERIOR CEILING

NIME / IMAX / ENTERO / SNEAK-R / HOLE-IN-ONE / SPLITBOX / CARREE / EN-SUITE / REO / ARTUUR / DEEP RINGO / GYN / PARTOU / KADET / TWENTY-7 / DIRO SBL / GRID / MULTINOVA / SUPERNOVA XS / SUPERNOVA FLAT / SUPERNOVA / SUPERDOME / XY180 / PUNK / HEDRA / VIZIR / NEEDLE / LINK S / BOXY / DOT.COM / DOT.COM WALLWASH / HALOSCAN / TWEETER / ODRON / BOWIE / PION / UHO / SPY / RAND / SUPER-OH! SLIM / SUPER-OH! / SUPER-OH! XS / SUPERLOOP SBL / SUPERLOOP PLUS / SUPERLOOP MDL / SOLISCAPE / LASS-OH! / INFORM SQ / INFORM R / CONFORM / ONE-AND-ONLY / STREAMLINER / GIBBO / STILL / MILES / MANTELLO / SOIREE / ZOOVER

464 – 581

PROFILES

SPLITLINE M20 / SPLITLINE M52 / SHIFTLINE M26L / MATRIX / SHIFTLINE M26H / SHIFTLINE M35R / SHIFTLINE M44 / SPLITLINE 14 / SHIFTLINE 19 / SPLIT-IT / TAGLINE / CONNECT / DOT.COM WALLWASH / FEMTOLINE 25 / FEMTOLINE 35 WG / FEMTOLINE 35 / FEMTOLINE 45 / FEMTOLINE W / ONE-AND-ONLY / BORDERLINE / OUTLINER / MICROLINE TR / MICROLINE 40/60 / STREAMLINER / SHELFLINE

337

582 – 619

EXTERIOR CEILING

REO X / DEEP RINGO X / CARREE X / BOXY / DOX / SUPERNOVA XS X / B-LINER IP

338 – 429

INTERIOR WALL

GYN W / LOGIC W / TAGLINE / INLET / LEDS C / HELI / MONTUR / FORTY-5 / BREESS / GALA / ORBIT / HEDRA W / WANT-IT / WA-T / TOPIX / VISION / TIGA / BACKSPACE II / WALKER II / FEMTOLINE W / FEMTOLINE TP

620 – 701

EXTERIOR WALL

LOGIC W / LEDS C / LEDS GO / HELI X / STIP / SKOV / TOPIX / BACKSPACE II / WALKER II / VISION OUT / TIGA / MOMBA / MONO II / WANT-IT X / MONTUR / SPY 39 W / DOX / ULTRA X / SOIREE W

430 – 463

TRACK

SPY / FRAGMA / MULTINOVA / SUPER-OH! XS / SUPERNOVA XS

702 – 809

EXTERIOR FLOOR

LOGIC / LOGIC F / LEDS C / LEDS GO / KIX / FRAX / STIG / OUTLINER / STIEVIE / ELBO / MONTUR / OBLIX / ASTRIX / WALKER II / STRIPER / MONOPOL / SPYKER / BAZIL / POLESANO





INTERIOR

CEILING

RECESSED

NEW
NIME
P 14



IMAX II
P 22

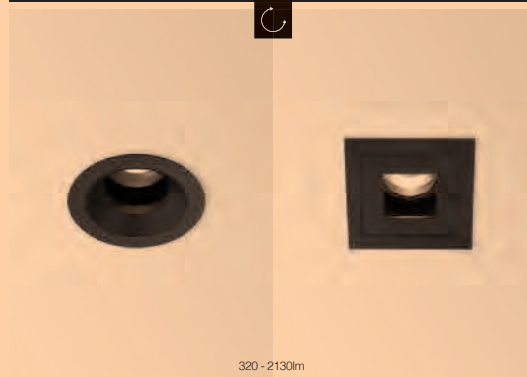

320 - 2130lm

SNEAK-R
P 34



1630lm

HOLE IN ONE
P 40

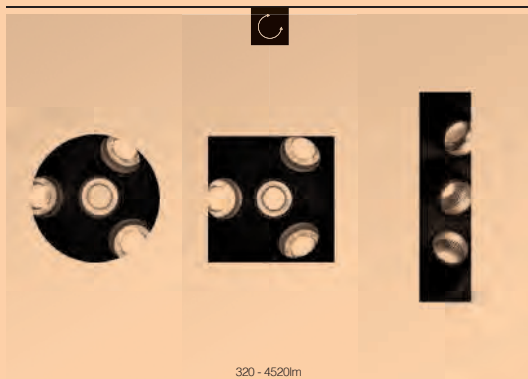

320 - 4520lm

SPLITBOX
P 44



780 - 4410lm

CARREE
P 50



810 - 1130lm

NEW
EN-SUITE
P 58

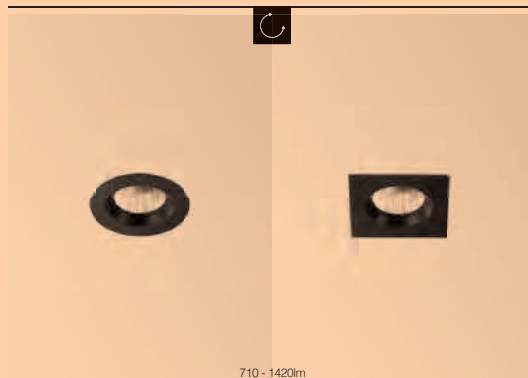

710 - 1420lm

NEW
REO
P 62

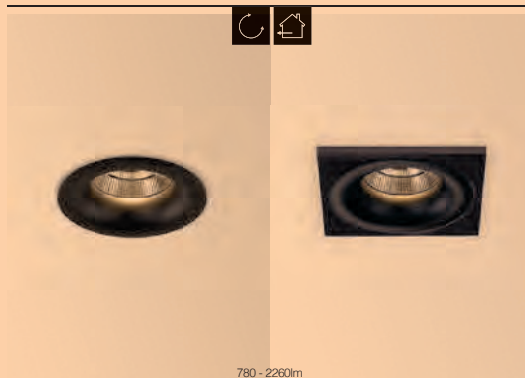

780 - 2260lm



3 SIZES



NEW
ARTUUR
P 72

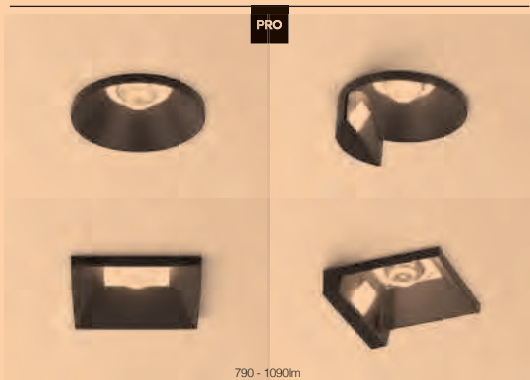

NEW
DEEP RINGO
P 80



NEW
GYN
P 88

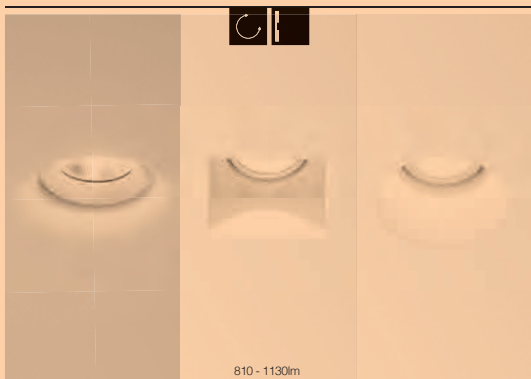

NEW
PARTOU
P 94



NEW
KADET
P 98



TWENTY-7
P 102



SUPERDOME
P 144



NEW
ENTERO
P 32



RECESSED & SURFACE

DIRO SBL

P 106

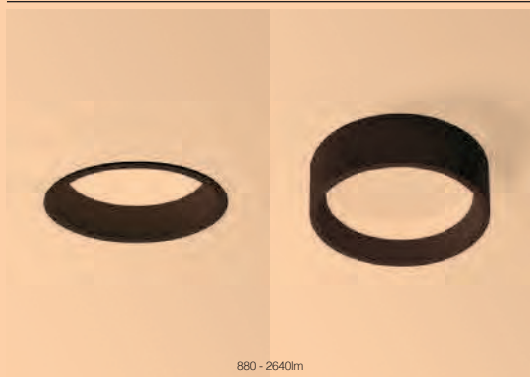

880 - 2640lm



3 SIZES



2 SIZES

GRID

P 112

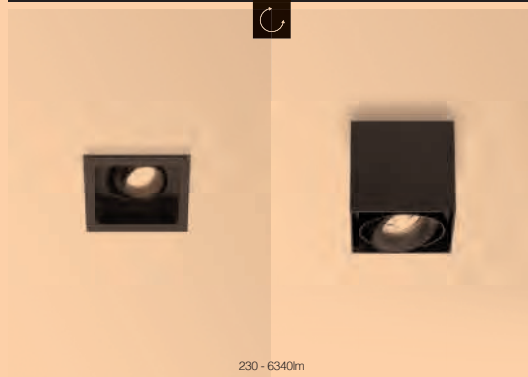

230 - 6340lm



4 SIZES



2 SIZES

NEW

MULTINOVA

P 122



1370 - 5590lm



2 SIZES

SUPERNOVA XS

P 132



1580 - 2600lm



2 SIZES

SUPERNOVA / FLAT

P 134



5250 - 43700lm



4 SIZES

DOT.COM

P 186

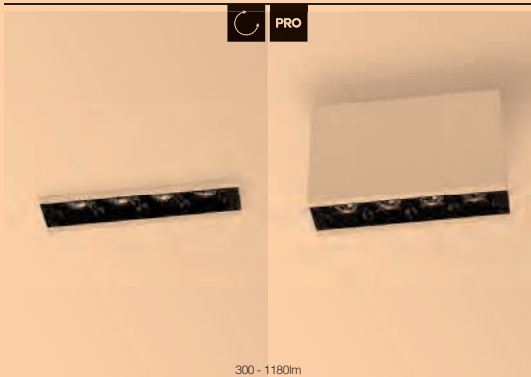

300 - 1180mm
3 SIZES

DOT.COM WALLWASH

P 188

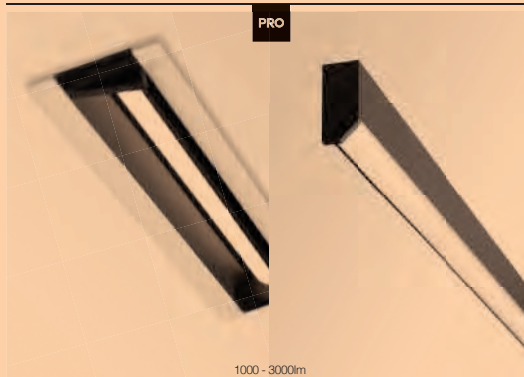

1000 - 3000mm
4 LENGTHS

NEW

HALOSCAN

P 196



1090 - 2180mm
2

TWEETER M

P 204

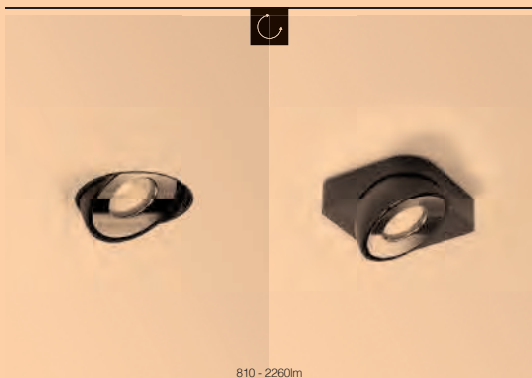

810 - 2260mm
2

TWEETER

P 204



810 - 2260mm
2

RECESSED & SURFACE

NEW

ODRON
P 212



780 - 2160lm



NEW

BOWIE
P 216



780 - 2160lm



NEW

PION
P 220



780 - 3240lm



NEW

UHO
P 224



260 - 780lm

NEW

SPY
P 228



390 - 3170lm



3 SIZES



4 SIZES



4 SIZES



3 SIZES



2 SIZES

SPY FOCUS

P 228

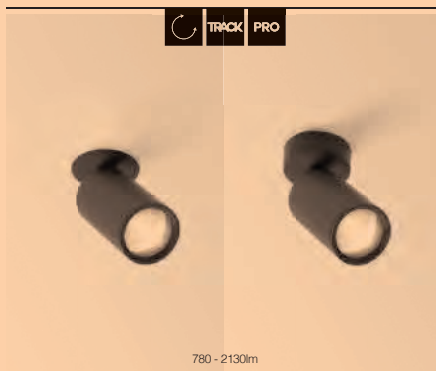

SUPER-OH! XS

P 249

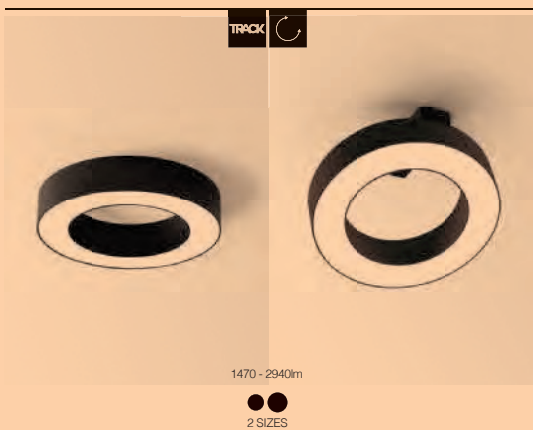

NEW SUPER-OH!

P 248



SURFACE

NEW
MULTINOVA
 P 122



XY180
 P 148



420 - 1050lm

PUNK
 P 156



590 - 810lm

HEDRA \ VIZIR
 P 162

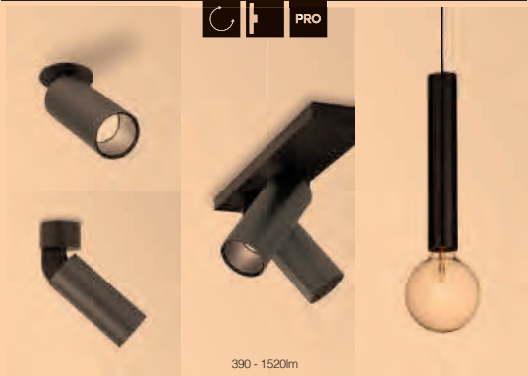

390 - 1520lm



NEEDLE
 P 170



390 - 1360lm



LINK S
 P 174



810 - 2430lm



BOXY
 P 178



810 - 3170lm



RAND
 P 242



730 - 2190lm



NEW
SUPERLOOP
P 254



NEW
SOLISCAPE
P 266



LASS-OH!
P 280



NEW
INFORM
P 288

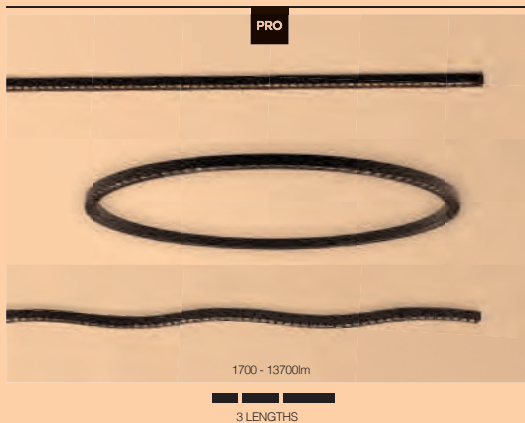

NEW
CONFORM
P 294



ONE-AND-ONLY
P 298

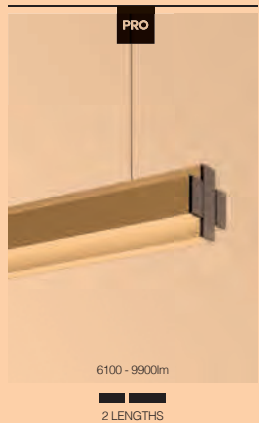

STREAMLINER
P 302

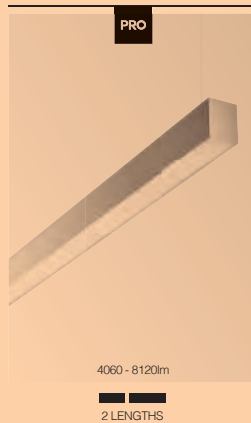

GIBBO
P 306



SURFACE

NEW

STILL

P 310

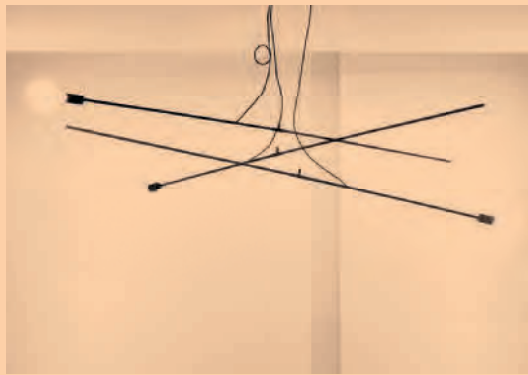

MILES

P 314



780lm

NEW

MANTELLLO

P 318



780lm

SOIREE

P 326



NEW

ZOOVER

P 332



4820lm

● ●
2 SIZES

NEW

PAGE337

P 337





NIME

PATENTED

**THE ABSCENCE IN ITS PRESENCE,
THE PRESENCE IN ITS ABSCENCE.**

The black hole reflects no light, but the light of Nime finds its way out.
The tangible part disappears inside its heart, and the intangible part
illuminates the object.

THE FIFTH FORM OF LIGHT

The first form of light is
in the source.

The second is
the invisible form of light itself.

The third is the form of the object revealed
by light before it touches it,
the fourth is the form of the shadow.

And the fifth is the form of the consequence
that comprises all the previous four forms, as
well as the way we feel and experience the
space considering the four forms.

Design by **DEAN SKIRA** & Delta Light

www.deltalight.com/nime





Better not underestimate Nime, as the aperture of only 10mm is only the façade that hides away a host of possibilities to control your beam. Within the same opening and thanks to an ingenious set of custom optics, Nime allows you to focus the beam from 20° up to 40° and offers rotation up to 355° and tilting up to 30°, without changing its looks. With this magic trick, Nime lets you:

Emphasize objects on vertical and horizontal surfaces, without visual appearance of the fitting or its source

Light up small to large objects, even when they are not aligned with the luminaire.

Perfectly address the light where it is needed, even in slope ceilings.

Create equal circles of light from both low and higher ceilings.



DEAN SKIRA

is the founder of **SKIRA**, an award-winning practice based in Pula (Croatia).

Dean is travelling in light and walking through shadows. What started as design work with tangible forms, over the past 30 years, developed into building and creating with the intangible and the ephemeral.

“At **SKIRA** we refer to light as to an intangible but powerful building material. We create architectural lighting and product design to suit our projects. By

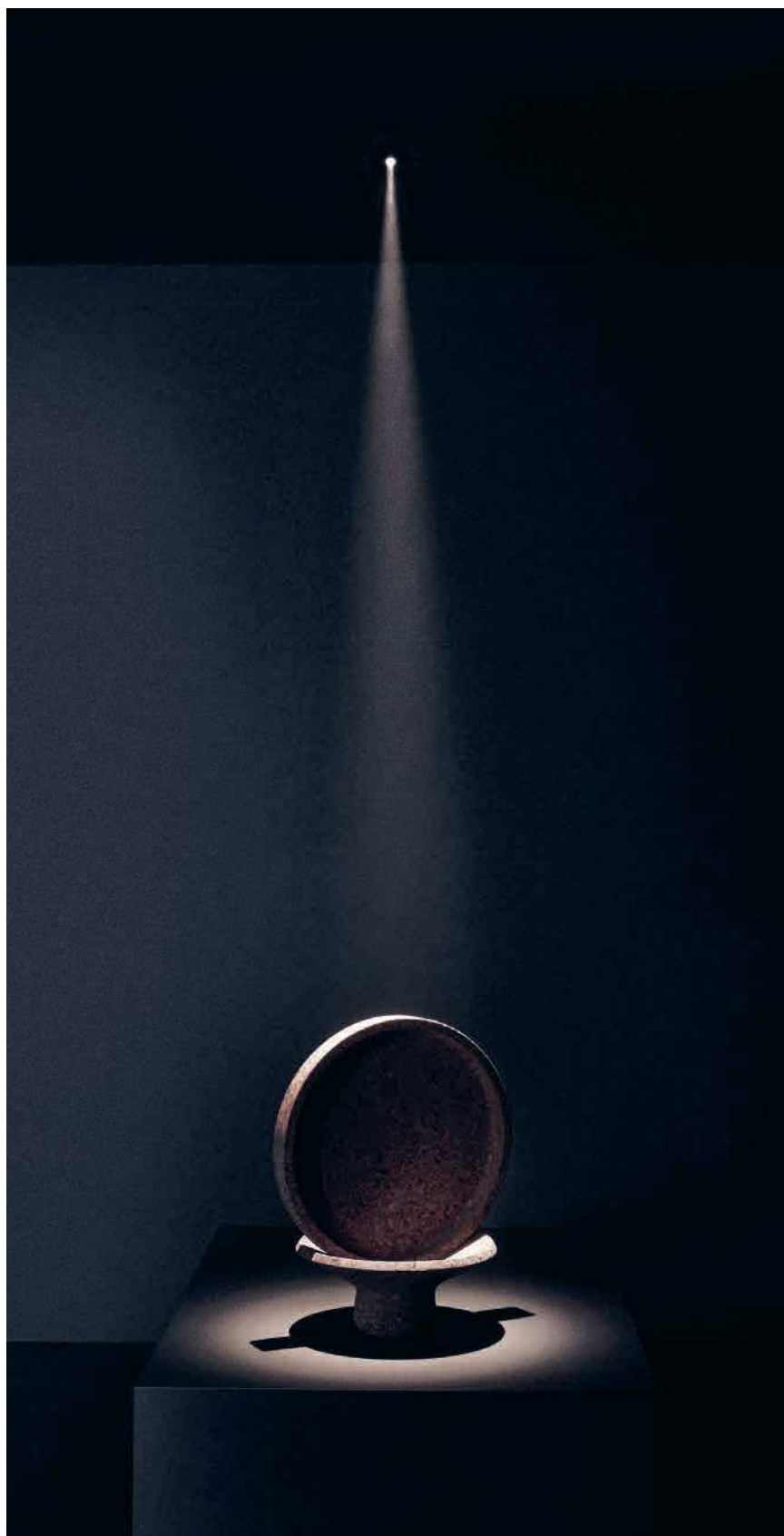

INVISIBLE, YET TANGIBLE.

The effect is there, but where does it come from? With a miniature aperture of only 10mm, Nime focuses on what is important and puts it in the spotlight. It's not about Nime, it's about what Nime can do.

The combination of its focusable beam angle together with its adjustability allows for a multitude of application possibilities, while maintaining a uniform look and feel throughout the project.













iMAX

Where the initial evolution in LED and optics focused on better output, smaller chips and longer lifetime, the second evolution is again shifting to user comfort with more precise optics and better light control.

As the purpose of the iMax II family is to provide the best visual comfort to the user - thanks to its recessed LED engine - this range is perfect to build further on this evolution: improved efficiency, improved beam angles and the possibility to combine all versions as they use uniform LED engines.

The iMax II range combines premium LED engines with precise optics, delivering high performance, maximum efficacy and high quality illumination. iMax II is using lenses out of plexiglass HW55, a material able to withstand high temperatures and allowing lumen packages up to 2000lm. Next to the high output, the lenses allow for a perfect control of the beam angle and a high uniformity on the light emitting surface, which results in reduced glare. Furthermore, if a different beam angle is required, the lenses can easily be interchanged.

The round versions with trim within the range are available with a clear glass, offering IP54. This enables you to continue minimalism and uniformity throughout bathrooms, wellness areas and other indoor damp locations.

iMax II fits in The Soft Ceiling concept from Delta Light, as it focuses on minimal appearance, giving focus to the light instead of the fixture. As such, the collection fuses Delta Light's aspirations for design sophistication and attention to detail, with precise engineering and premium materials, resulting in minimal fixtures with maximum impact. The interchangeable tubes and colour finishes allow you to apply luminaires that disappear into the background.

www.deltalight.com/imax



FAMILY OVERVIEW

CHOOSE YOUR COLOUR



Black / White

Coloured tube in Black / Gold Matt / White

CHOOSE YOUR INSTALLATION

Trim / Trimless

CHOOSE YOUR SHAPE



Round / Square

CHOOSE YOUR POWER

Superspot 3,2W – 320lm
 Low Power 6,1W – 780lm / 6,9W – 1080lm
 Mid Power 11,7W – 1520lm / 17,1W – 2130lm
 (UGR<19)

CHOOSE YOUR LED COLOUR

2700K / 3000K / Soft Dim

CHOOSE YOUR OPTICS

Superspot 6°
 Low Power 12° / 20° / 33°
 Mid Power 18° / 26° / 39°

CHOOSE YOUR ACCESSORY

Honeycomb / Glass SBL / Linear Spread Lens /
 Softening Lens / Spread Lens

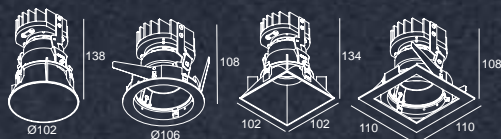

iMax II makes use of hw55 acrylic polymer lenses to obtain its optical characteristics. The lenses not only allow to control the light in the desired way, the specific copolymer material is high heat resistant and therefore higher lumen packages can be reached.

HIGH EFFICIENCY

Apart from the high light transmission of the lens for optimum efficiency, its specific construction creates a focal point that is not inside the luminaire, but at the height of the opening in the ceiling. In this way, every single ray of light produced by the LED engine is being directed through the lens towards the opening of the iMax II luminaire. This reduces the spill light inside the luminaire and increases its efficiency.

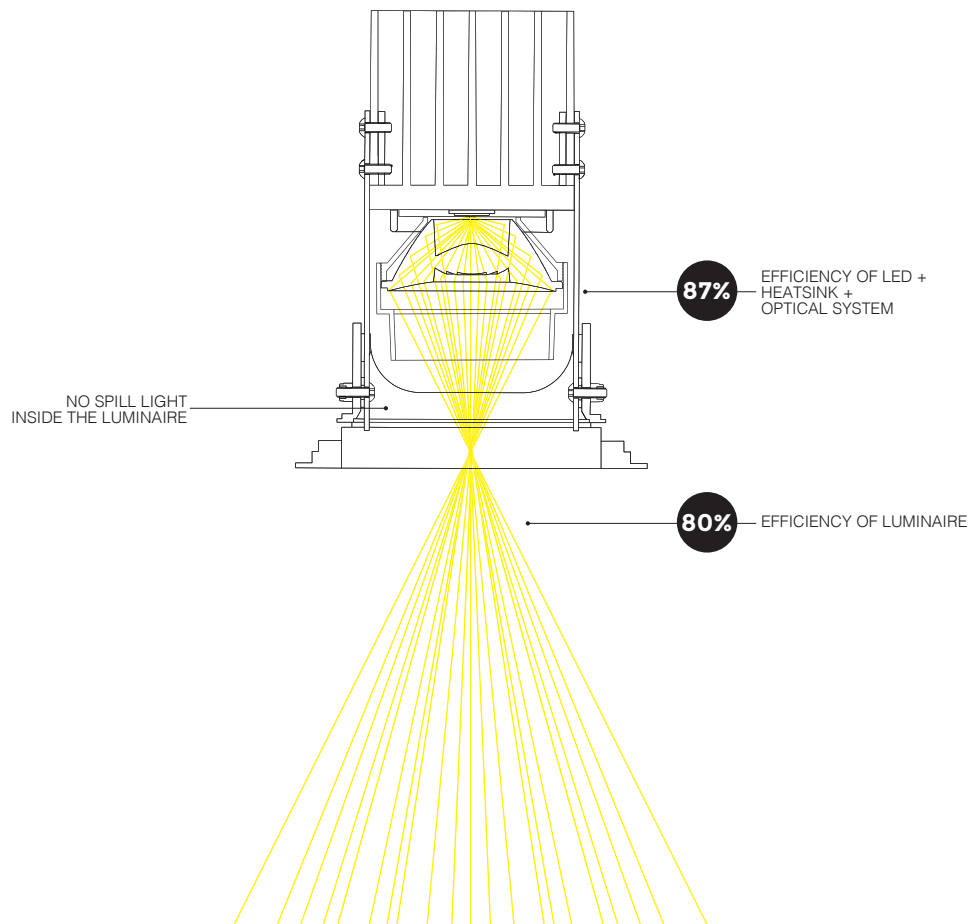

To offer even more flexibility and design freedom to the lighting designer, a range of light refining accessories is available to alter the light effect to the specific needs of the setting. A honeycomb to further minimize the direct glare from the light source, a sandblasted glass to create a diffuse general light effect and 3 specific lenses to either create a more oval or a wider light distribution or to smoothen the edges and create a softer transition.

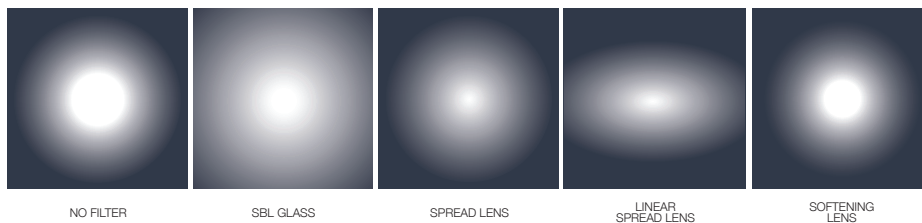



ADJUSTABLE WITH TRIM

A versatile accent lighting solution to emphasize individual objects or architectural elements. The tilt mechanism allows the luminaire to be angled with precision up to 30°, allowing for optimum beam alignment. As a result, the light is emitted exactly where you want it. With iMax II Adjustable, the hole in the ceiling is being covered by the trim on the luminaire. It comes as a round or square solution with finishing in white or black and topped off with a colourful tube in white, black or gold.



ADJUSTABLE FLUSH

To further reduce the visual impact on the ceiling, a mounting kit is available to install the standard luminaires flush with the ceiling. This results in a clean ceiling sight, without the repetitiveness of the luminaire trim coming out of the ceiling.



ADJUSTABLE TRIMLESS

A super smooth finish combines ultimate minimalism with maximum eye comfort. This version comes with a trimless mounting kit enabling quick and precise installation and finishing. The interchangeable black, white or gold insert allows you to match the fixture with its surroundings. iMax II Adjustable Trimless is available in a round and square finish.

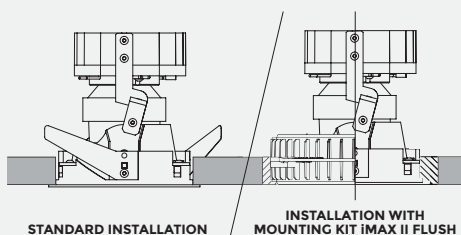
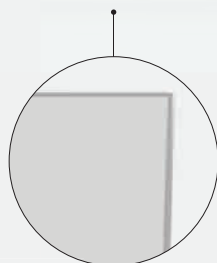
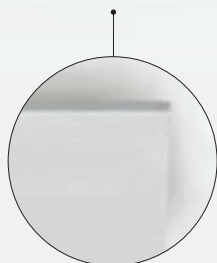

Additional mounting kits allow for multiple installation options. In this way iMax II Trimless can easily be installed in different ceiling types thanks to the versatility of the mounting kits. For the installation of the iMax II with trim, an additional mounting kit can be used to install the luminaire flush into the ceiling without the trim coming out.



ARCHITECTS DTR STUDIO / LIGHTING DESIGN BIG ARCHITECTURAL LIGHTING / PHOTOGRAPHY CRIS BELTRÁN



ARCHITECT PAOLO COSSU ARCHITECTS / LOCAL ARCHITECT GIULIANA BARILLI



ARCHITECTS DTR STUDIO / LIGHTING DESIGN BIG ARCHITECTURAL LIGHTING / PHOTOGRAPHY CRIS BELTRÁN



ARCHITECT ESTUDIO MORFO / PHOTO LUIS FERNANDO RAMOS



ARCHITECTS KIBA BRAZ ARCHITECTS AND URBAN PLANNERS / LIGHTING DESIGN RAMA MENDELSON



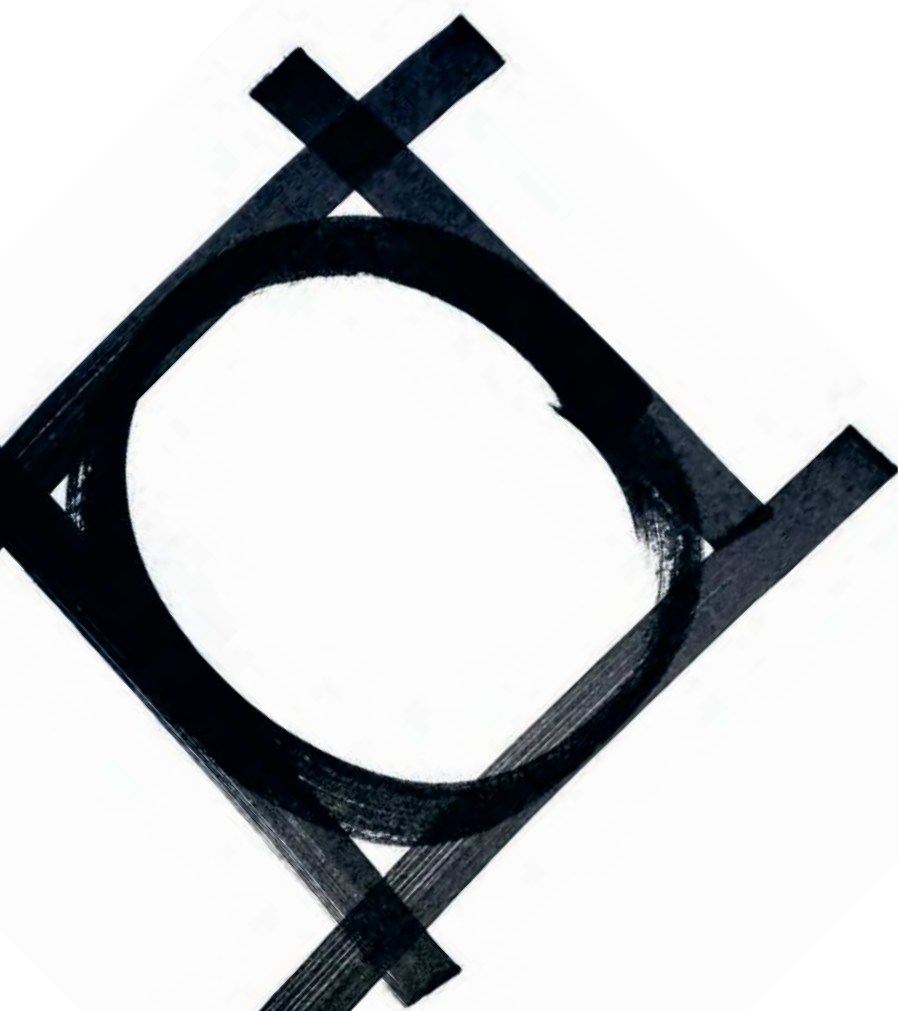

ENTERO

Available September 2021

Entero is derived from the Spanish language and means "complete". A perfect summary described in 1 word, as Entero is a complete family of recessed downlights providing a solution for diverse lighting dilemmas.

The bases of Entero are 3 light units, each composed of a high-quality LED and a hybrid optical compartment. The different LEDs have a uniform colour consistency and the hybrid optics provide a comfortable light with perfectly outlined beams, making Entero easily combinable throughout an entire project.

Starting from the different light units, Entero offers a series of options in a round or square design. Available in different power levels with a multitude of beam angles, Entero comes as adjustable luminaires - with or without trim - to be use indoors, outdoors and in damp locations.

Options as Soft Dim, Tunable White and wallwash lightings make the Entero family complete.

www.deltalight.com/entero



FAMILY OVERVIEW

CHOOSE YOUR COLOUR



Black / Gold Coloured / White

CHOOSE YOUR INSTALLATION

Trim / Trimless
Adjustable

CHOOSE YOUR SHAPE



Round / Square
Small / Medium / Large

CHOOSE YOUR POWER

Small 5,7W up to 12,4W – 520 up to 1470lm
Medium 8,2W up to 24,6W – 680 up to 2900lm
Large 10,7W up to 36W – 810 up to 4600lm

CHOOSE YOUR OPTICS

Small 10° / 20° / 45° / Wallwash
Medium 6° / 18° / 30° / 45° / Wallwash
Large 6° / 18° / 30° / 45°

CHOOSE YOUR LED COLOUR

2700K / 3000K / Soft Dim / Tunable White

CHOOSE YOUR ACCESSORY

Honeycomb / Glass SBL / Linear Spread Lens /
Softening Lens / Spread Lens

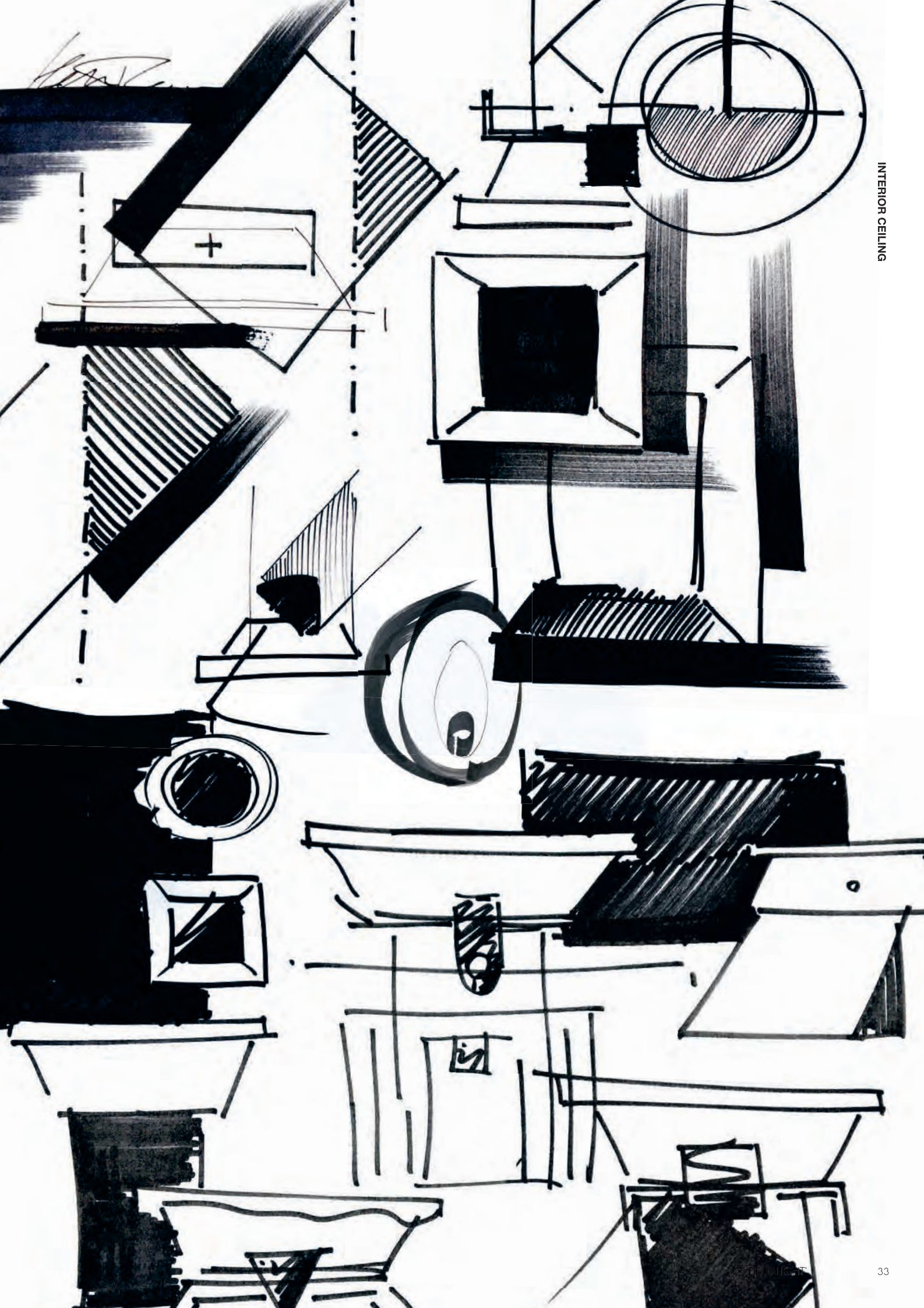

INTERIOR CEILING



SNEAK-R

A wallwash light effect can upgrade any project, adding sophistication and emphasizing detail in interior design. Sneak-R is a top-notch wallwash range in Delta Light's collection, allowing the user to create depth in a room via an evenly illuminated wall. With Sneak-R you can reduce the contrast between a well-lit workspace and its environment, or it gives your artwork the perfect light it deserves.

Engineered to perfection, the Sneak-R combines a slightly curved cover with a lens, resulting in an evenly lit wall, from floor to ceiling. Thanks to the design harmony between led and lens, Sneak-R can be kept very compact and does not attract any attention to the luminaire. The cover design reduces the angle of the mechanical cut-off, resulting in a minimum of glare and a maximum of visual comfort.

www.deltalight.com/sneak-r



FAMILY OVERVIEW

CHOOSE YOUR COLOUR



Silver Grey / White

CHOOSE YOUR INSTALLATION

Trimless / Trim

POWER

11,3W – 1630lm

CHOOSE YOUR LED COLOUR

2700K / 3000K

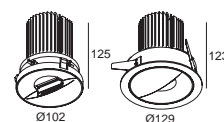



ARCHITECTS DTR STUDIO - LIGHTING DESIGN - BIG ARCHITECTURAL LIGHTING - PHOTO CRIS BELTRÁN

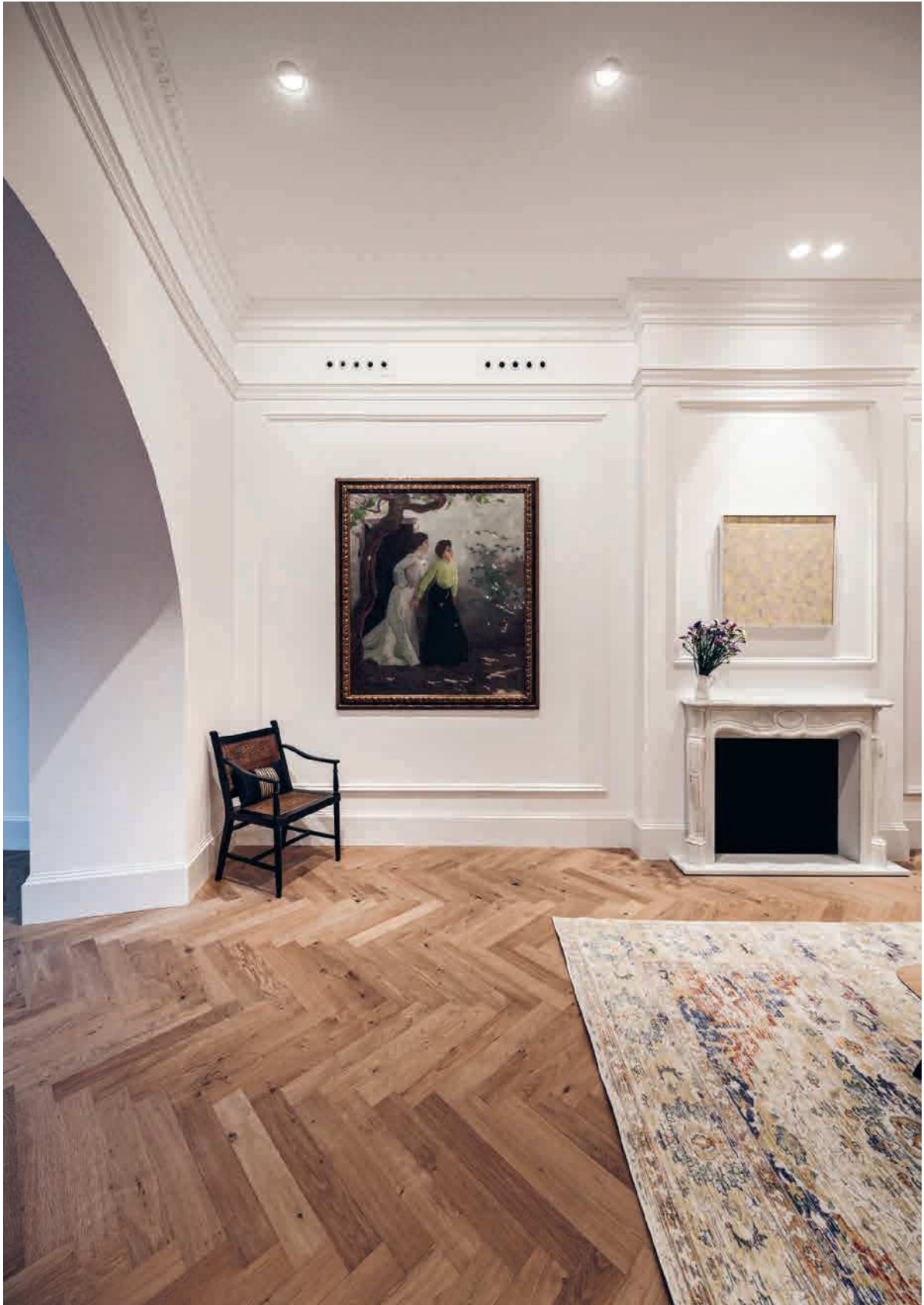





The name of this product says it all. The Hole In One - available in both rectangular, square and circular shape - lets you see a hole in the ceiling and nothing else. That is as long as you don't stand underneath this lighting fixture. This fitting offers enough space for different modules being able to point at different directions, all from within the same hole in your ceiling, making it very discreet.

Light and space are inextricably linked with one another, something that the Hole In One plays on so ingeniously. Intended in the first place to be functional lighting, this contemporary design pokes a little fun at its surroundings at the same time. The black background in the fitting creates the illusion of an unfathomable unendingness around the light source. The magnetic mounting of the modules makes it easy to quickly adapt the lighting to a new setting.



HOLE IN ONE

www.deltalight.com/hole-in-one





FAMILY OVERVIEW

CHOOSE YOUR SHAPE



Round, Square or Rectangular

CHOOSE YOUR POWER

Superspot
3,2W – 320lm

7,1W up to 10,4W – 810 up to 1130lm

CHOOSE YOUR LED COLOUR

2700K / 3000K

CHOOSE YOUR OPTICS

Round & Square 6° / 20°

Rectangular Small 24° / 40°

Rectangular large 15° / 25° / 35°

CHOOSE YOUR ACCESSORY

Honeycomb / Softening Lens

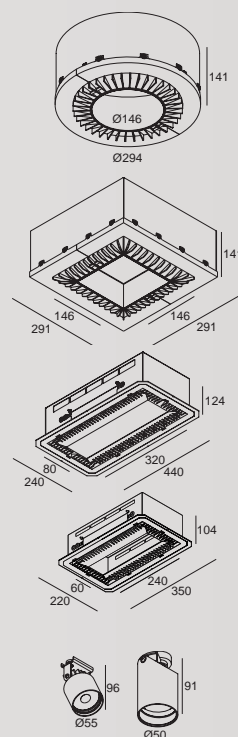



I-COR (INTERIOR CONCEPT STORE ROESELARE) WWW.I-COR.BE





SPLITBOX

Splitbox is a trimless integrated lighting system, with the full flexibility of surface mounted lighting. A black minimalistic cove of 80mm wide and 225mm or 315mm long can be equipped with one, two or three highly flexible spot modules. These Spy modules can remain encapsulated in the ceiling or emerge in its entirety and be tilted 90° while rotate 355°, allowing focused illumination in one swift move.

The black background inside the cove creates an illusion of unendingness around the light spots, enforcing the fully integrated architectural lighting concept. A range of light refining accessories is available to guarantee optimal optic performance and maximum eye comfort. The outside of the Spy modules is available either black or white, which can be combined with exchangeable inserts in multiple colour finishes.

www.deltalight.com/splitbox



FAMILY OVERVIEW

CHOOSE YOUR SIZE



2 or 3 modules

CHOOSE YOUR COLOUR



Modules in Black / White



Front Tube in Black / Flemish Bronze / Flemish Gold / Gold Coloured/ White

CHOOSE YOUR POWER

8,6W up to 12,4W – 1090 up to 1470lm

Focus

6,1W up to 9W – 780 up to 1080lm

CHOOSE YOUR LED COLOUR

2700K / 3000K / Soft Dim / Tunable White

CHOOSE YOUR OPTICS

20° / 45°

Focus 8° to 43°

CHOOSE YOUR ACCESSORY

Honeycomb / Lenses

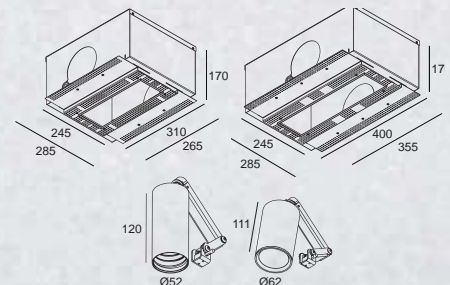





INTERIOR DESIGN PIETER VANRENTERGHEM







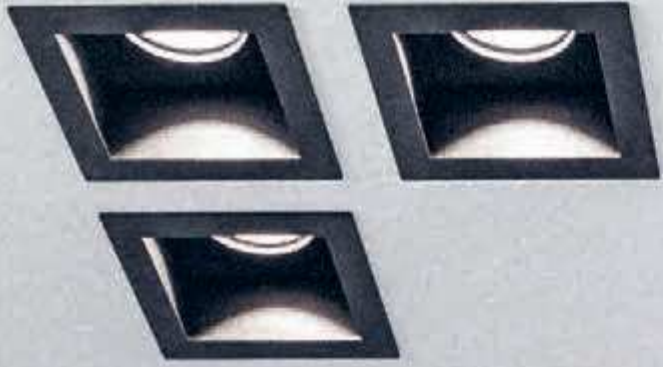

CARREE

FAMILY

The Carree range is Delta Light's answer for easy-to-install, timeless and functional recessed spots, as it has been a Delta Light classic for many years. This family of square recessed luminaires offers refined solutions for LED or halogen, either with or without trim. The straight lines in the design make a contemporary spot out of Carree, not only useful in modern architecture but also in many other applications.

Carree can be used throughout the entire project, as it also includes IP44 solutions for bathrooms and even IP65 luminaires for outdoor use.

www.deltalight.com/carree





FAMILY OVERVIEW

CHOOSE YOUR COLOUR



Alu Grey / Black / White



Black-Gold Matt / White-Black combination

CHOOSE YOUR INSTALLATION

Trimless / Trim

Indoor / Outdoor

CHOOSE YOUR POWER

7,1W up to 10,4 – 810 up to 1130lm

GU10

OPTICS

33°

CHOOSE YOUR LED COLOUR

2700K / 3000K / Soft Dim

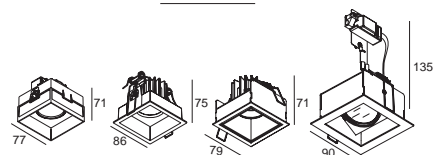







ARCHITECT ALFREDO SARAVIA - AS ARQUITECTURA



ARCHITECTS GOVAERT & VANHOUTTE







EN-SUITE

With an impressive delivered output of 130 lumens per watt, in a 54 x 50 mm fitting, En-Suite represents the next generation of downlights.

The super energy-efficient En-Suite has the wellbeing of its users and the planet in mind. Reduced glare technology offers comfort to all who experience it. En-Suite is made from minimal components and is for 80% recyclable.

En-Suite is available in IP20 and IP44, which allows a uniform look throughout all spaces of your project, be it a hotel, restaurant or home, even in damp locations such as bathrooms. En-Suite comes fix, adjustable, round, square, single and double, spot and flood, offering solutions for all needs in your project.

En-Suite presents an answer when facing limited installation height in ceilings. When using a fixed fitting and remote driver, En-Suite requires a 50 mm installation height. With its diameter of 54 mm, a circular cut-out of 48 mm suffices for a quick installation, no kit needed. For a smooth and virtually trimless result.

www.deltalight.com/en-suite



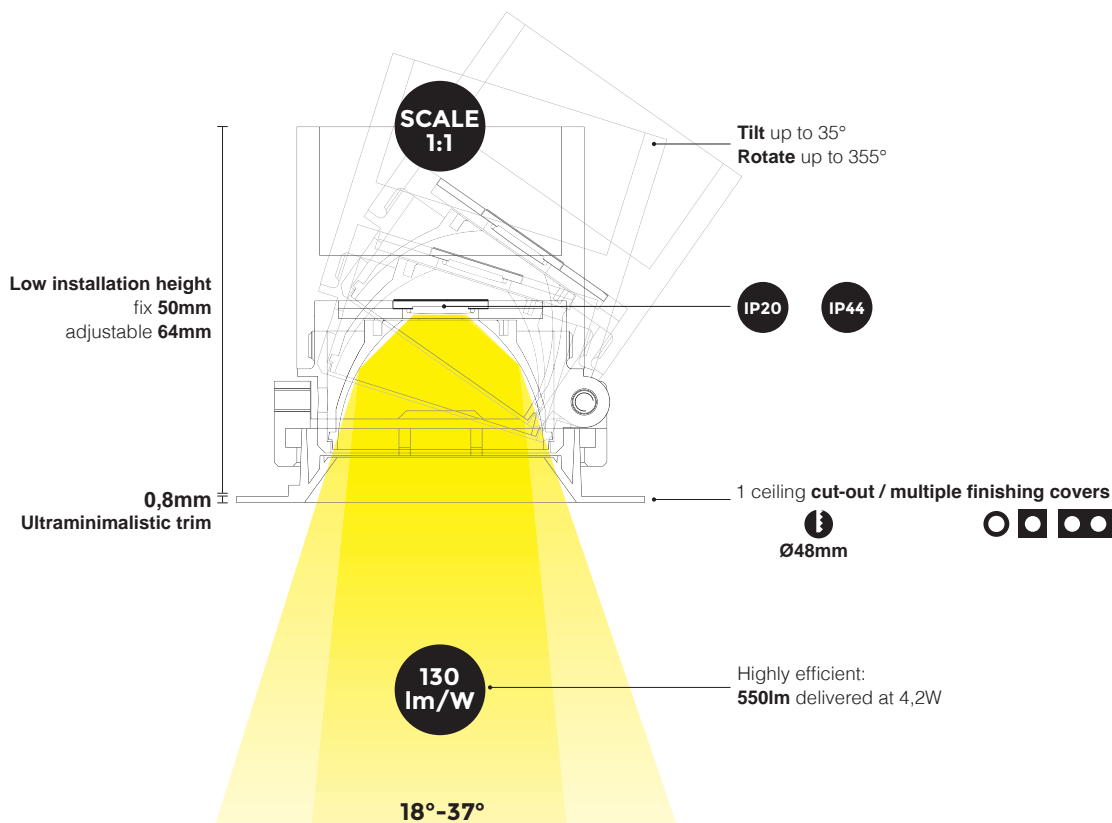

FAMILY OVERVIEW

CHOOSE YOUR COLOUR



CHOOSE YOUR SHAPE



Round / Fix or adjustable
Square / Fix or adjustable
Square Double / Fix

POWER

4,1W - 710lm

CHOOSE YOUR LED COLOUR

2700K / 3000K

CHOOSE YOUR OPTICS

18° / 37°

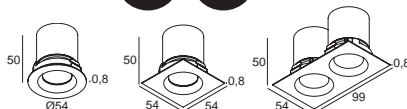





REO FAMILY

The Reo collection is more than one product, it is a family which offers a solution for many lighting demands, from residential to hotel, restaurant to retail and much more. In line with this philosophy, Reo comes in single and double fixtures, round or square, orientable or fixed, in multiple finishing colours, for both indoor and outdoor use.

The design of these recessed conical spots delivers a hardly visible transition from the intense light to the ceiling, resulting in a halo-like effect, ideal to give the space an extra dimension.

MICRO REO

Being the smallest member of the family, Micro Reo excels in minimalism in design and excellence in performance as it offers a 7,1W LED solution. It comes as an IP20 version and as a luminaire with higher IP-rating that can be used in bathrooms and other wet areas.

MINI REO

Mini Reo offers a multitude of lighting solutions, as it combines multiple beam angles in both non- adjustable and adjustable luminaires. Spot, Medium or Flood can be combined to fit the specific needs of the project.

REO

Similar to Mini Reo, Reo offers adjustable and non-adjustable downlights in multiple beam angles. With an output up to 10,4W, Reo can easily be integrated into hospitality and residential projects, especially when using the Soft Dim version which creates a warm and cosy atmosphere when dimming down the luminaire. Reo comes in a round and square design. Within the round design one can opt for a smooth finishing of the inner cone or choose the ribbed version that reduces the glare thanks to its cascading transition from light source to ceiling.

www.deltalight.com/reo



INTERIOR CEILING

Find the other members of this family **EXTERIOR CEILING**



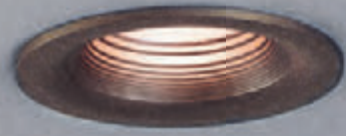

FAMILY OVERVIEW

CHOOSE YOUR COLOUR



Black / Flemish Bronze / Flemish Gold / White

CHOOSE YOUR SHAPE & SIZE



Micro Reo / Fix

Mini Reo / Fix or adjustable

Reo / Fix or adjustable

Reo Square / Adjustable / Single or double

CHOOSE YOUR POWER

Micro

7,1W – 820lm

Mini

6,1W up to 9W - 780 up to 1080lm

Reo

7,1W up to 10,4W - 810 up to 1130lm

CHOOSE YOUR LED COLOUR

2700K / 3000K / Soft Dim

CHOOSE YOUR IP-RATING

IP20 / IP44

CHOOSE YOUR OPTICS

Micro

35°

Mini

18° / 25° / 37°

Reo

33° / 50°

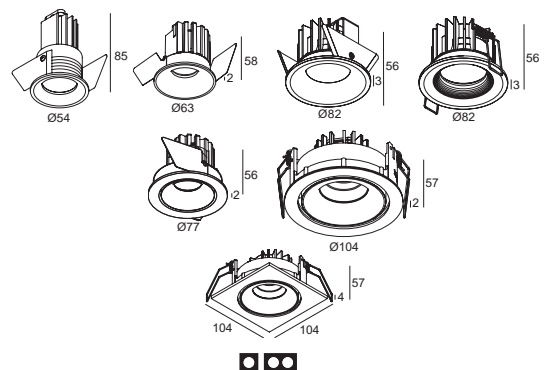

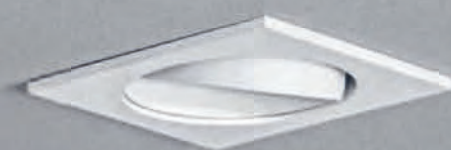













ARTUUR

Everything about Artuur catches the eye, be it its design, its optical compartment or its small protrusion when installed into the ceiling. Artuur comes as a downlight with sloping edges towards the center, both round and square. The design twist is in the asymmetrical square version, easily deceiving the eye but inspiring you to present creative layouts.

Another design element is the sophisticated lens on top of the deeply placed LED. While offering an outstanding quality of light, its remarkable aesthetics wow you, even when Artuur is not turned on.

Additionally, Artuur can combine pleasant general lighting with uniform wall washing, as a secondary LED module softly throws its light on vertical surfaces.

When installed into the ceiling, Artuur adds depth into the room owing to its gentle protruding ring. Small enough to be noticed, big enough to make a difference. Put the complete luminaire into a recessing kit and Artuur goes from protruding to trimless, refinement at best!

www.deltalight.com/artuur



FAMILY OVERVIEW

CHOOSE YOUR COLOUR



Black / Gold Coloured / White

CHOOSE YOUR INSTALLATION

With trim / Trimless

CHOOSE YOUR SHAPE

Round / Square

CHOOSE YOUR LIGHT EFFECT

General light
General & Wallwash light

CHOOSE YOUR POWER

5,8W up to 8,6W – 810 up to 1090lm

CHOOSE YOUR LED COLOUR

2700K / 3000K / Soft Dim

CHOOSE YOUR OPTICS

30° / 60° / Linear spread

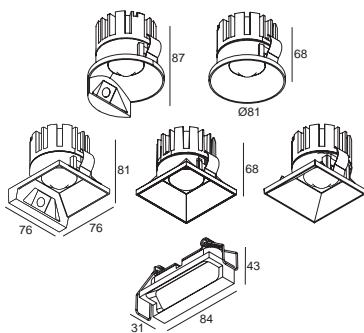



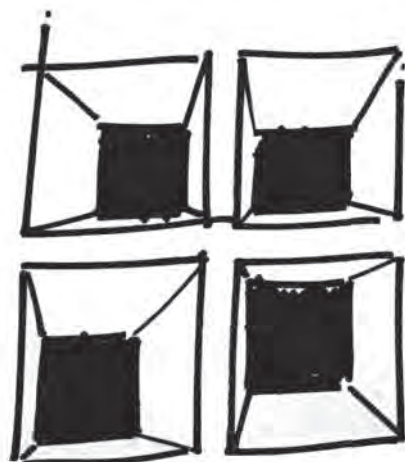
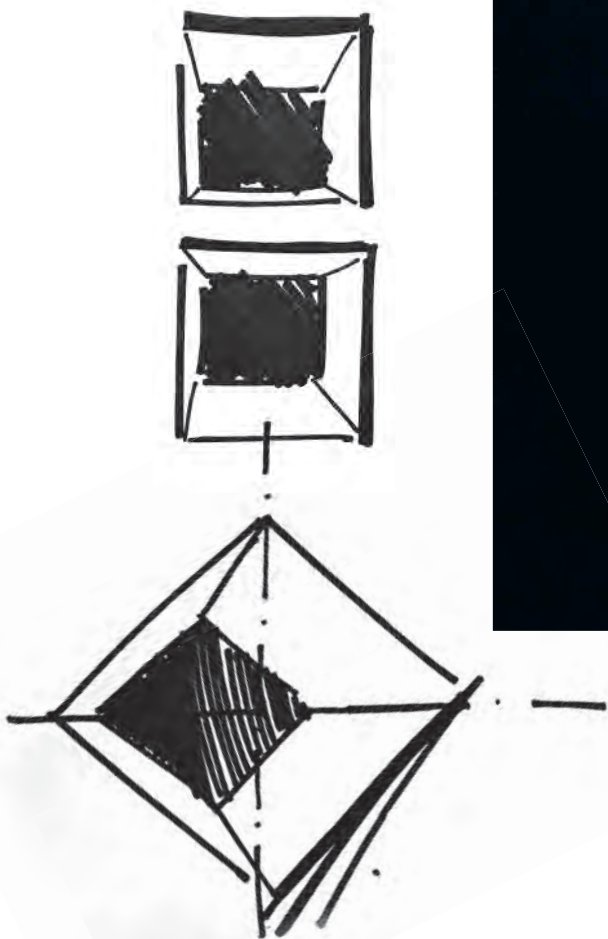
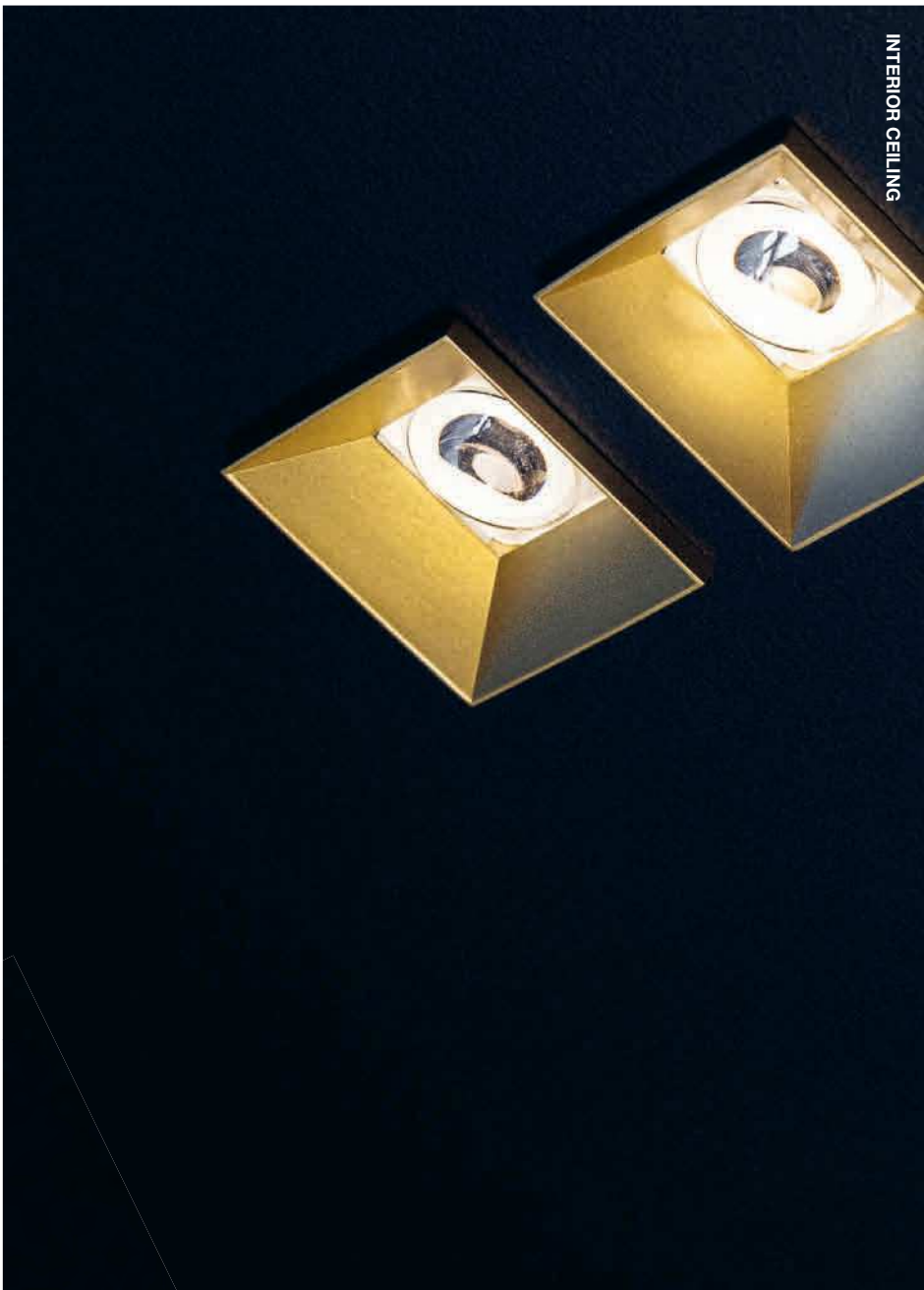









DEEP RINGO FAMILY

The conical shaped design of the Deep Ringo fixtures and its deeper placed LED source make sure that glare is reduced to a minimum when Deep Ringo is installed in the ceiling. The small trim gives a refined touch to this elegant luminaire.

Available in 3 sizes, with trim or trimless, fix or adjustable, a range of beam angles and multiple finishing colours, Deep Ringo is an easy-to-use downlight throughout the project. Its golden or bronze finish is perfect to add a sniff of luxury to the room.

MINI DEEP RINGO

Mini Deep Ringo is playful, as it comes in a multitude of finishing colours, has 3 different beam angles to choose from and can be fix or adjustable. A range of possibilities in a slender design.

DEEP RINGO

Deep Ringo is the most elaborate of the family, offering LED and halogen solutions, for use in both dry and wet areas. Similar as the Reo family, Deep Ringo also offers a ribbed version that reduces the glare thanks to its cascading transition from light source to ceiling.

www.deltalight.com/deep-ringo



INTERIOR CEILING

Find the other members of this family **EXTERIOR CEILING**





FAMILY OVERVIEW

CHOOSE YOUR COLOUR



Black / Flemish Bronze /
Flemish Gold / Gold Coloured / White

CHOOSE YOUR SIZE & FINISH

Mini Deep Ringo / Fix & Adjustable

Deep Ringo / Fix & Adjustable
/ Trim & Trimless

CHOOSE YOUR LIGHT SOURCE

LED / GU10

CHOOSE YOUR POWER

Mini Deep Ringo

6,1W up to 9W - 780 up to 1080lm

Deep Ringo

7,1W up to 10,4W - 810lm up to 1130lm

CHOOSE YOUR LED COLOUR

2700K / 3000K / Soft Dim

CHOOSE YOUR OPTICS

Mini Deep Ringo / 18° / 25° / 37°

Deep Ringo / 33°

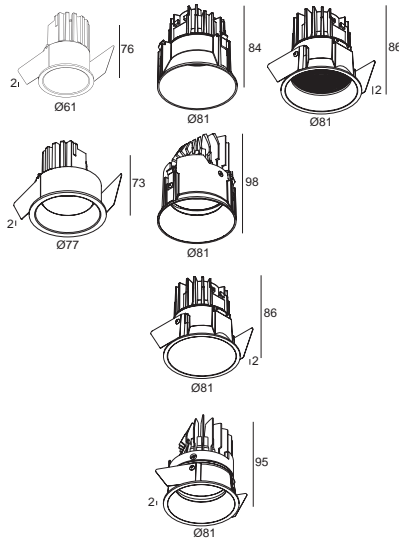





INTERIOR DESIGN MAISTER / PHOTOGRAPHY BERT DEMASURE



INTERIOR DESIGN LICUA DESIGN - LIGHTING DESIGN BIG ARCHITECTURAL LIGHTING - PHOTO JUANAN BARROS





GYN FAMILY

The Gyn family is a range of gypsum luminaires that complete Delta Light's elaborate range of downlights. The possibility of finishing these products on site in any desired colour makes them suitable for many applications.

The curved shape of the Gyn frame provides a smooth transition from ceiling to luminaire. When Gyn is turned on, the curve provides a soft glow on the ceiling, similar to Reo fixtures.

As a round or square gypsum luminaire, Gyn D steps away from the curved edges and goes straight into the ceiling. With a deeply recessed LED module, Gyn D offers additional visual comfort as it shields off the light source from directly being looked into.

www.deltalight.com/gyn



INTERIOR CEILING

Find the other members of this family **INTERIOR WALL**.





FAMILY OVERVIEW

CHOOSE YOUR COLOUR
Paintable in any desired colour

CHOOSE YOUR SHAPE
○ □

CHOOSE YOUR POWER
7,1W up to 10,4W - 810 up to 1130lm

CHOOSE YOUR LED COLOUR
2700K / 3000K / Soft Dim

CHOOSE YOUR OPTICS
18° / 33°

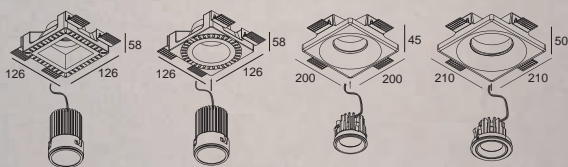





OBUMEX



Partou fits in everywhere.

PARTOU

Partou? Oui oui! The Partou family has countless application possibilities, as it combines round and square shapes, fix and adjustable luminaires and offers an IP44 protection rate from below. Easy to fit in everywhere – partout in French -, from residential to hospitality, from dining room to bathroom.

www.deltalight.com/partou



ADAPTIVE DESIGN

The clever design of Partou offers a multitude of finishing options on 1 and the same LED module. Complete your LED module with the cover you want: round or square, small or bigger, white, black or a black-dark chrome combination for an optimal visual comfort, the choice is up to you!



FAMILY OVERVIEW

CHOOSE YOUR COLOUR



Black / White

Black-Dark Chrome combination for improved visual comfort



CHOOSE YOUR SHAPE & SIZE



Mini Partou

Partou

Fix or adjustable

Partou Square

CHOOSE YOUR POWER

6,1W up to 9W - 780 up to 1080lm

CHOOSE YOUR LED COLOUR

2700K / 3000K

CHOOSE YOUR OPTICS

18° / 25° / 37°

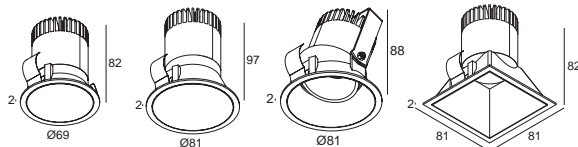







KADET

With an installation height of only 60mm for Kadet S and 70mm for Kadet M, the Kadet range is an ideal solution for applications where recessing depths are very limited.

Nevertheless, Kadet succeeds in offering a low glare trimless solution within this small height, thanks to the clever design combination of LED engine and optics: optimized visual comfort thanks to the recessed LED engine, optimized heat dissipation and optimized beam control.

The smaller Kadet S is ideal for installation in hollow ceilings, while the bigger Kadet M can also be installed into concrete, thanks to its multifunctional recessing kit.

www.deltalight.com/kadet





FAMILY OVERVIEW

CHOOSE YOUR COLOUR



Black / Gold Coloured / White

CHOOSE YOUR SIZE

Small or Medium

CHOOSE YOUR POWER

6,1W up to 9W - 780 up to 1080lm

CHOOSE YOUR LED COLOUR

2700K / 3000K

CHOOSE YOUR OPTICS

25° / 37°

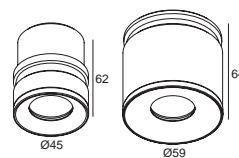









TWENTY-7

Despite the many advantages of LED as a lighting solution, the incandescence light bulb still recalls characteristics as warmth and cosiness to many people. As a flashback on how it used to be, Twenty-7 brings these characteristics back to live.

As a recessed luminaire where only the light bulb is coming out of the ceiling, Twenty-7 throws light throughout the room, enlighting the space from ceiling to floor.

By using a LED filament lighting bulb, Twenty-7 gives you not only warmth and cosiness, but at the same time adds the advantages of LED.

www.deltalight.com/twenty-7

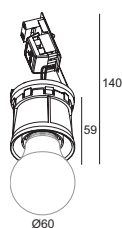



ARCHITECT T. ZED ARCHITECTS / PHOTOGRAPHY JULIET DUNNE



DIRO SBL

NOT YOUR REGULAR DOWNLIGHTER

Diro SBL is a range of recessed and surface mounted luminaires, designed with an eye for visual comfort, as it has a multi layered optic finished with a prismatic plexi at the front.

It has a driver included and its reduced height allows you to install it anywhere, either built in or built on. With finishes in black and white and IP44 versions available, Diro SBL is also suitable for use in damp locations like bathrooms.

www.deltalight.com/diro-sbl



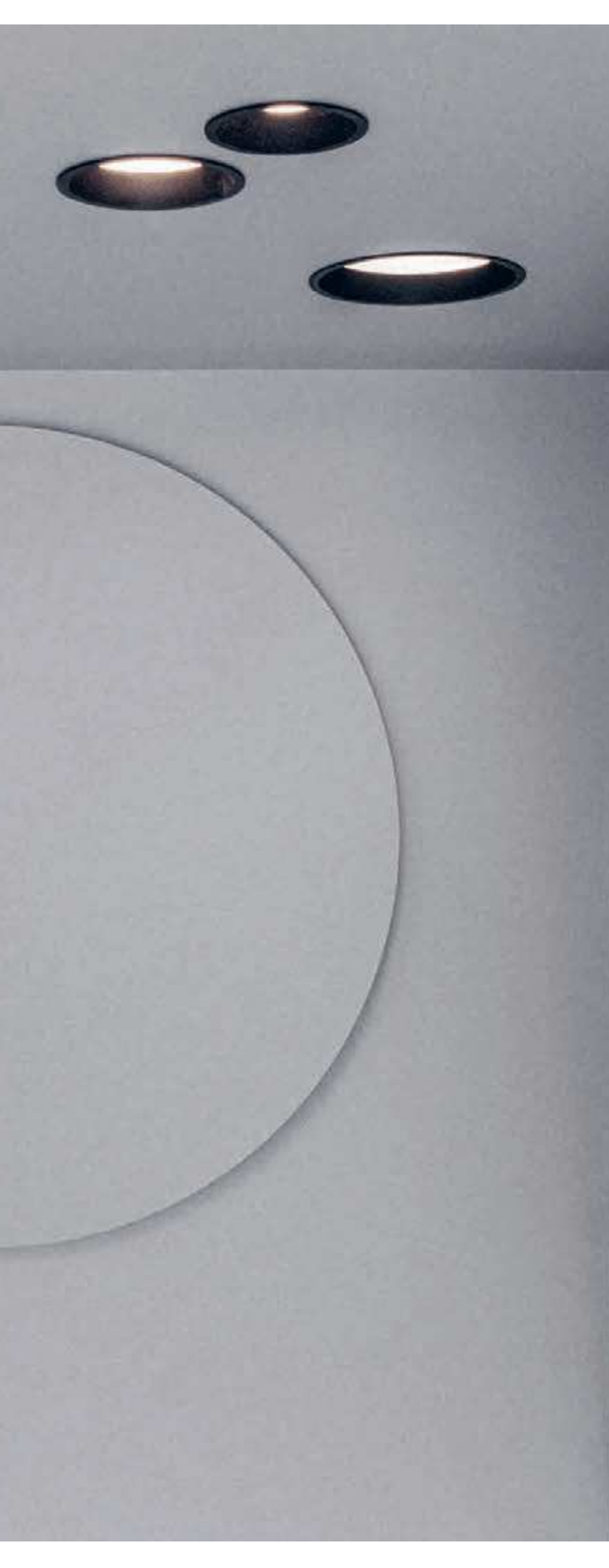

FAMILY OVERVIEW

CHOOSE YOUR COLOUR



Black / White

CHOOSE YOUR INSTALLATION

Recessed / Surface mounted

CHOOSE YOUR SIZE

Small / Medium / Large

CHOOSE YOUR POWER

5,9W – 880lm

9,8W – 1500lm

17,5W – 2640lm

CHOOSE YOUR LED COLOUR

2700K / 3000K

IP20

IP44

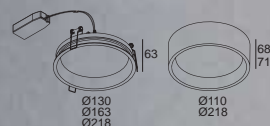



ARCHITECT TOM LIERMAN / GOLFLUB DE KLUIZEN







GRID

The Grid product family is a longstanding classic in the collection. First as halogen and discharge solutions, later as LED downlight and afterwards updated to the Snap-In principle, a smart and easy way of separating the mounting frame from the LED module, with comfortable installation as a result. This grid range is all about flexibility, as the single or double light units can be directed any way you want.

MICROGRID IN

Microgrid In completes the Snap-In range as it uses a similar principle of dividing the light unit into a mounting frame and a light module that can be snapped into the frame after installation. Microgrid comes in single, double and triple set-ups with trim.

A visor is available to further reduce the impact of the intense light coming from the miniature light source, shielding the light source from directly looking into.

MINIGRID IN ZB

The ZB principle stands for clean lines and minimalist design. These luminaires can be built into a cove in the ceiling or an optional box can be used as easy installation frame.

SNAP IN

The Snap-In principle equals modularity and flexibility at its best, it grants the opportunity to the lighting designer to use his creativity: combine single and double units, use multiple beam angles or play with colour. All to use as surface mounted luminaire or as recessed spotlights, both with or without trim.

Dividing a luminaire into multiple modular parts not only creates uniformity within one family, it also facilitates the installation by giving the opportunity to the installer to place the frame in advance. No need to worry for the lighting modules in further finishing of the room, as the modules can be clicked into the frame afterwards.

GRID IN

The classic from the range, offering XR111 solutions for halogen or LED retrofit.





INTERIOR CEILING



FAMILY OVERVIEW

MICROGRID SNAP-IN

CHOOSE YOUR COLOUR



Black / White

CHOOSE YOUR SHAPE

Single / Double / Triple



INSTALLATION

Recessed
With trim

CHOOSE YOUR POWER

3,9W up to 5,7 –
380 up to 520lm

CHOOSE YOUR LED COLOUR

2700K / 3000K

CHOOSE YOUR OPTICS

15° / 30°

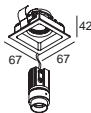

**MINIGRID SNAP-IN
MINIGRID 67 SNAP-IN**

CHOOSE YOUR COLOUR



Black / White

CHOOSE YOUR SHAPE

Single / Double / Triple



CHOOSE YOUR INSTALLATION

Recessed
With trim / Trimless
Surface mounted

CHOOSE YOUR POWER

2W up to 23,2W -
230lm up to 3170lm

CHOOSE YOUR LED COLOUR

2700K / 3000K / Soft Dim

CHOOSE YOUR OPTICS

Minigrid
6° / 18° / 25° / 33° / 37° / 50°
Minigrid HP
20° / 37° / 50°

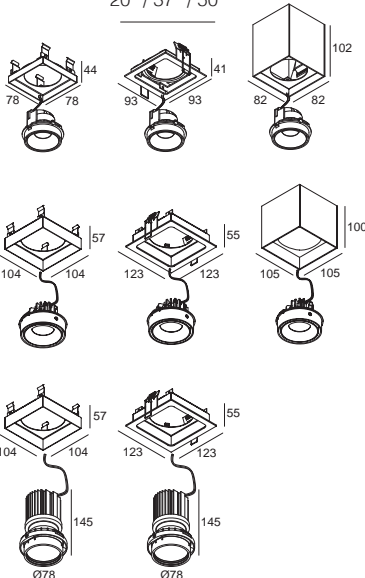

MINIGRID ZB

CHOOSE YOUR COLOUR



Alu / White

CHOOSE YOUR SHAPE

Single / Double



INSTALLATION

Recessed
Trimless

CHOOSE YOUR POWER

7,1W up to 10,4W –
810lm up to 1130lm

CHOOSE YOUR LED COLOUR

2700K / 3000K / Soft Dim

OPTICS

33°

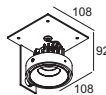

GRID

CHOOSE YOUR COLOUR



Black / White

CHOOSE YOUR SHAPE

Single / Double



INSTALLATION

Recessed
Trimless

LIGHT SOURCE

G53

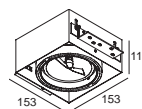

www.deltalight.com/microgrid



www.deltalight.com/minigrid



www.deltalight.com/minigrid



www.deltalight.com/grid









ERIBO / INTERIEURBURO PEDRO VERHUE





WWW.ABCPROJECTS.BE



ARCHITECTS GOVAERT & VANHOUTTE



MULTINOVA

FAMILY

Multinova has something familiar and something fresh at the same time. As a disc of light, Nova refers to the Supernova range, as both families share similarities in looks and ways of installation. But Multinova has some additional features to make it multi-applicable, hence Multi in the name.

With 2 different diameters, a down and down-up version and a limited height of only 69mm, Multinova is perfect to use in different ways. Its small dimensions fit in any residential or hospitality project, as a track mounted luminaire it suits any retail environment and with a prismatic sheet for reduced glare it even adapts in office settings. Moreover, Multinova can be used on our Magnetic profiles for general lighting.

Multinova comes in our standard black or white and can also be finished in the warmer Gold Coloured to enrich its surroundings. To top it off – next to a sandblasted or prismatic optic – one can opt for a smoked sheet at the front for a more decorative touch. When turned on the disc is fully lit, when turned off a deep dark arises, ideal in combination with a Gold Coloured Multinova.

www.deltalight.com/multinova



TWO OR THREE?

Go for the ultimate statement by opting for these clustered Multinova suspensions, coupled together in pairs or as a trio of enlightened discs. Use them in bigger spaces like lobbies, above reception desks or in open plan offices and combine beauty with functionality in one.

FAMILY OVERVIEW

CHOOSE YOUR COLOUR



Black / Gold Coloured / White

CHOOSE YOUR VERSION

Ø550mm
Double / Triple

CHOOSE YOUR POWER

2 x 33,2W – 4820lm
3 x 33,2W – 4820lm

CHOOSE YOUR LED COLOUR

3000K / Soft Dim / Tunable White

CHOOSE YOUR OPTICS

Sandblasted / Prismatic (UGR<19) / Smoke

CHOOSE YOUR CONTROL

Non Dim / DALI Dim

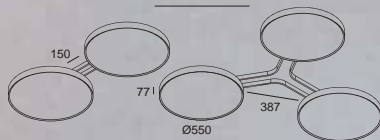



FAMILY OVERVIEW

CHOOSE YOUR COLOUR



Black / Gold Coloured / White

CHOOSE YOUR INSTALLATION

Recessed

Surface mounted

Fix / Pivot

Suspended

Fix / Pivot

Cable / Rod

CHOOSE YOUR LIGHT EFFECT

Down / Down-Up

CHOOSE YOUR SIZE & POWER

Ø 300mm

Down 9,4W up to 14,8W – 1370 up to 2150lm
Down-Up 12,1W up to 18,8W – 1760 up to 2730lm

Ø 550mm

Down 33,2W – 4820lm
Down-Up 38,5W – 5590lm

CHOOSE YOUR LED COLOUR

3000K / Soft Dim / Tunable White

CHOOSE YOUR OPTICS

Sandblasted / Prismatic (UGR<19) / Smoke

CHOOSE YOUR CONTROL

Non Dim / DALI Dim

Ø300

Ø550





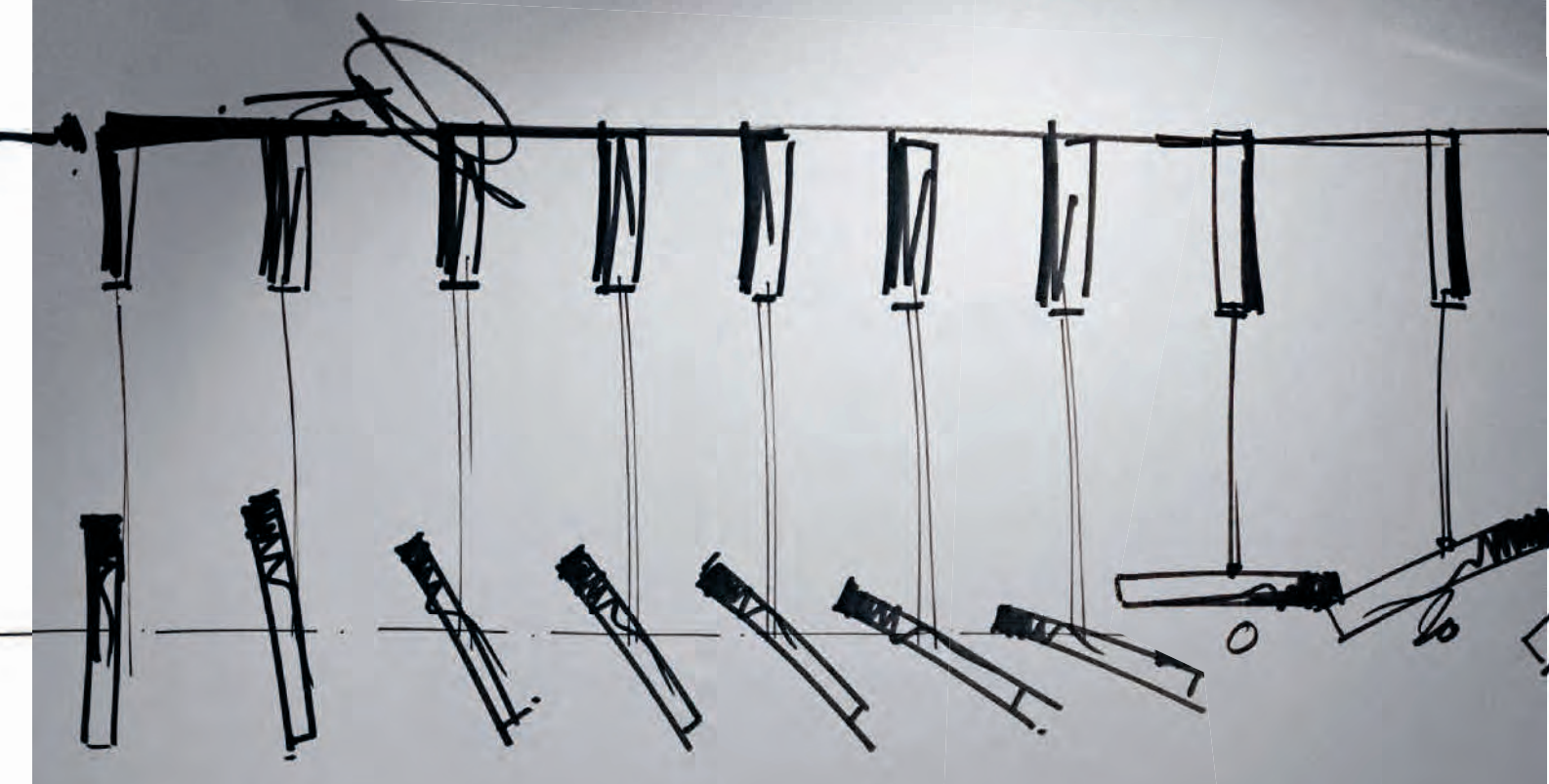

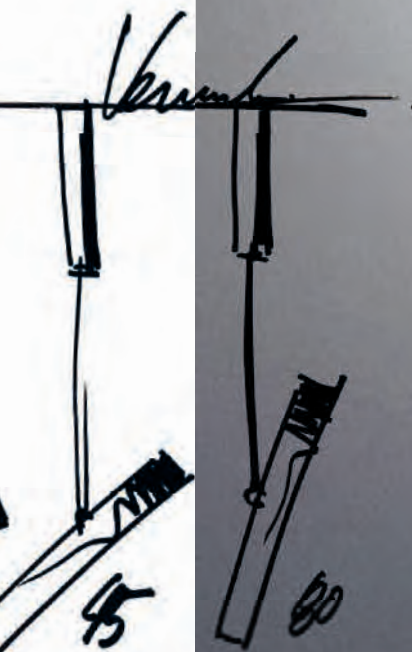

FLIP ME, I'M MADE FOR IT

Apart from the recessed, surface mounted and track version, there are two ways to suspend Multinova. Suspended by cables Multinova faces straight downwards, but as a rod suspension Multinova can be tilted up to 90° to face vertical surfaces as well. As such, one single suspension can dress up any room while a cluster of these serve to create frisky light settings.









STUDIO DIDEA

interior
innovation
award
Winner



reddot design award
winner

GOOD
DESIGN
award

—AWARD—
DESIGN PLUS
light+building



SUPERNOVA

FAMILY

Supernova is an extensive range of pure geometrically formed lighting fixtures that guarantee powerful illumination and atmosphere. The range comes in different diameters and application possibilities.

Supernova features in-house developed printed circuit boards specifically engineered to provide a uniform illumination of the polycarbonate. Small to large, recessed to suspended, for general lighting to office applications, the Supernova range features all you need.

As a plus, presence control and daylight simulation can be done thanks to the optional presence detection and the tunable white versions of the Supernova.



SUPERNOVA XS

With its 26 cm or 33 cm diameter, the Supernova XS (Extra Small) can be considered to be the baby in the range when it comes to size, but not when it comes to performance and skills. It only needs 6 cm of height to hide away an intense cluster of powerleds in its perfectly curved aluminium body. Following its big brother, the recessed Supernova XS is distinguished thanks to its remarkable tilted application when installed into the ceiling, a particular way of changing a simple round downlight into a playful eye-catcher.

www.deltalight.com/supernova-xs



SUPERNOVA XS

CHOOSE YOUR COLOUR



Black / White

CHOOSE YOUR INSTALLATION

Recessed
Surface mounted

CHOOSE YOUR SIZE & POWER

Diam. 260mm / 330mm
15W up to 22W – 1580 up to 2600lm

CHOOSE YOUR CONTROL

Non Dim / 1-10V Dim / DALI Dim

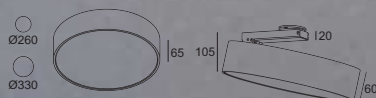

SUPERNOVA FLAT

The evolution in LED allowed for a more minimalistic design, visible within Supernova Flat. It combines the Supernova characteristics with a more subtle housing, creating a neat and modern look. Combined with a prismatic cover, Supernova Flat offers a lighting solution suitable for office and school application as its UGR remains below 19. Available for direct or direct-indirect lighting or with a soft uplight accent in Supernova Flat Smooth Up.

www.deltalight.com/supernova-flat





SUPERNOVA FLAT

CHOOSE YOUR COLOUR



Black / White

CHOOSE YOUR INSTALLATION

Surface mounted
Suspended

CHOOSE YOUR SIZE & POWER

Ø650mm / 950mm

Down – 40W up to 132W – 5250 up to 16230lm
Down-Up – 61W up to 153W – 8450 up to 18430lm

CHOOSE YOUR LIGHT EFFECT

Down / Down-Up
Sandblasted / Prismatic (UGR<19)

CHOOSE YOUR CONTROL

Non Dim / 1-10V Dim / DALI Dim

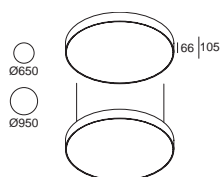

SUPERNOVA

Supernova comes as recessed, surface mounted or suspended luminaire, a wide range of possibilities.

Thanks to its trimless recessed finishing this Supernova Trimless discretely fits into the architecture of the room, with the emphasis on the light rather than the luminaire.

The seamless transition of light to ceiling makes this elegant eye-catcher float above the room, providing a perfectly uniform field of light.

The recessed version is a particularly eye-catching option in the Supernova range, thanks to its tilted application. A recessed kit facilitates installation, allows you to customize the depth and angle of the Supernova, and ensures the inner workings of the fitting are concealed within the ceiling.

Surface mounted, Supernova is a timeless lighting solution that guarantees powerful illumination and striking atmosphere, blending harmonically into its space. Its uninterrupted circular form and neutral character enhance any room, from hotel lobbies to corridors to shops, or any other type of project.

A suspended Supernova uses four delicate steel cords to enable an easy suspension.

The down-up version features a polycarbonate on top to avoid dust entering the fixture and guaranteeing a pleasant and an immaculate indirect light effect.

Thanks to the transparent supply cable and the trimless suspension kit you can opt for a very clean and minimalistic ceiling suspension.

www.deltalight.com/supernova



SUPERNOVA

CHOOSE YOUR COLOUR



Black / White

CHOOSE YOUR INSTALLATION

- Recessed
- Surface mounted
- Suspended

CHOOSE YOUR SIZE & POWER

Ø450mm / 650mm / 950mm / 1250mm

Down – 32W up to 239W – 5400 up to 36800lm
 Down-Up – 71W up to 282W – 11500 up to 43700lm

CHOOSE YOUR LIGHT EFFECT

Down / Down-Up

CHOOSE YOUR LED COLOUR

3000K / Tunable White

CHOOSE YOUR CONTROL

Non Dim / 1-10V Dim /
 DALI Dim / Wireless Dim

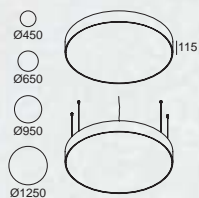



INTERIOR DESIGN PIETER SCHOOAERT







HUBERTY BREYNE GALLERY

INTERIOR CEILING



ARCHITECT ASHLEIGH HALLIDAY ARCHITECTS / PHOTOGRAPHY SAM NOONAN



UNDEFEATED



SUPERDOME

Cosiness is large and round; of that the Superdome is proof. This luminaire was initially created as an XXL version of Tweeter, one of the award winners in the collection. The Superdome is perfectly at home in double ceiling heights, or just as an atmospheric dome over the dining table or as an eye-catcher in the hall at home or the office.

The body made from polyester is available with a black or white exterior, the interior is white for optimal light diffusion. At first glance the Superdome looks very simple, but it is well thought-out. The light source is concealed behind a large diffuser, recessed into the dome obscured direct from view and preventing glare.

www.deltalight.com/superdome





FAMILY OVERVIEW

CHOOSE YOUR COLOUR



Black-White / White-White

CHOOSE YOUR POWER

105W – 17000lm

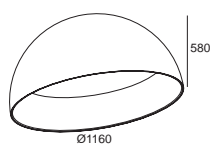



LEVEL 3 INTERIEURARCHITECTEN



ARCHITECT NICOLAS DERVICHIAN / PROJECT GHELAMCO

XY180

XY180 is a 3-piece lighting collection designed by OMA. The collection was inspired by a fascination with point, line and surface; key architectural elements. The floor, wall and ceiling lights are meant for individual and shared workspaces, but can also be applied to domestic and public interior spaces.

The line uses precise geometric dimensions while the base elements - which include tube lights and a spotlight in either a discreet 3,9W or a powerful 7,1W - can be combined with a hinge to generate countless lighting conditions. As individual components, each part is familiar. When assembled however, they can take on unpredictable and asymmetrical positions.

The tube lights create diffuse ambient lighting, while the spotlights provide focused lighting. By exposing the light and allowing it to pivot, the fixture becomes the main feature as it shifts into multiple configurations; a product that contributes to the creation of space, not only by the light it emits, but also by its physical presence.

Design by **OMA** & Delta Light

www.deltalight.com/xy180



FAMILY OVERVIEW

CHOOSE YOUR COLOUR

Black / Black with Punk Finish

CHOOSE YOUR VERSION

Single or double

Small or large

Tubes for general light /
Spots for accent light

CHOOSE YOUR POWER

Tube

8,9W – 1050lm

Spot

3,9W up to 7,1W – 420lm up to 810lm

OPTICS

33°

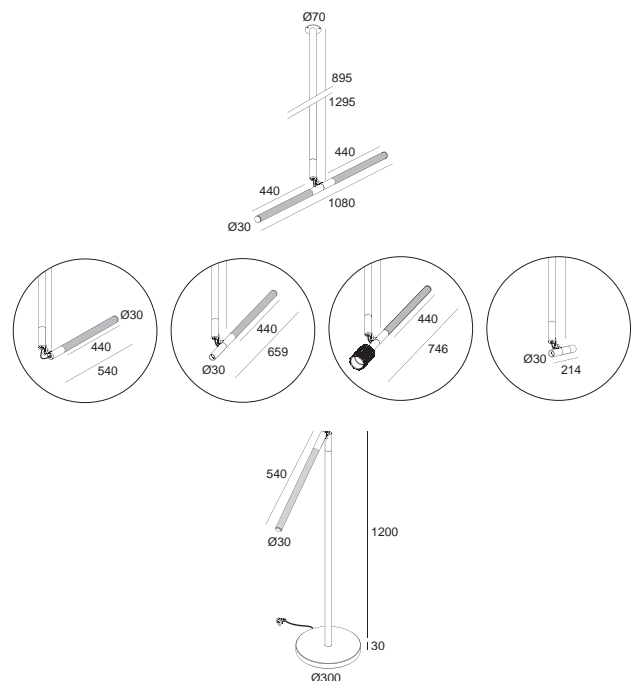

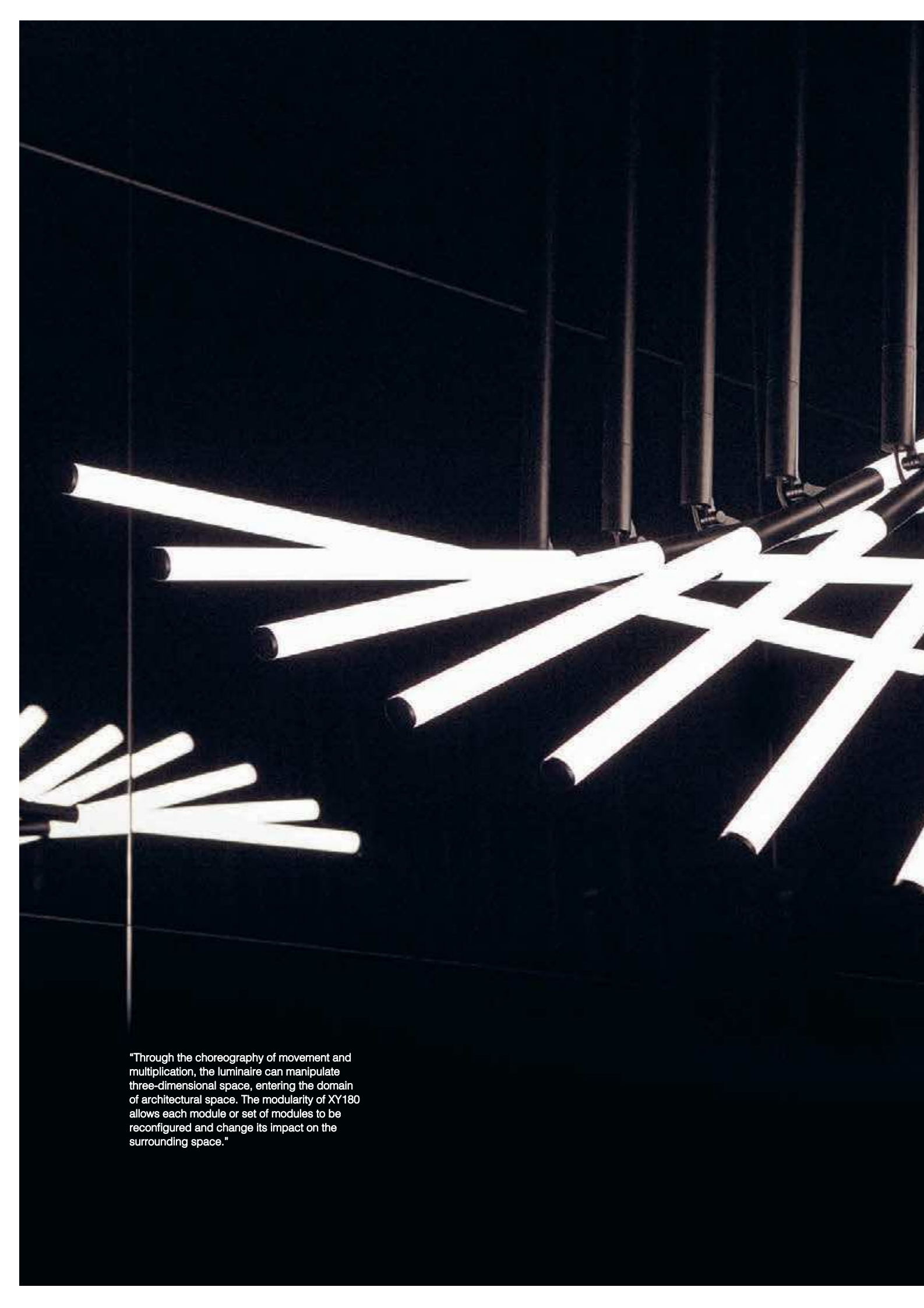

A photograph of a modern lighting fixture. The fixture consists of numerous white, cylindrical tubes arranged in a grid pattern. The tubes are illuminated from within, creating a bright, glowing effect. The background is dark, making the white tubes stand out. The tubes are arranged in a way that they appear to be part of a larger, modular structure. The overall aesthetic is clean and minimalist.

"Through the choreography of movement and multiplication, the luminaire can manipulate three-dimensional space, entering the domain of architectural space. The modularity of XY180 allows each module or set of modules to be reconfigured and change its impact on the surrounding space."

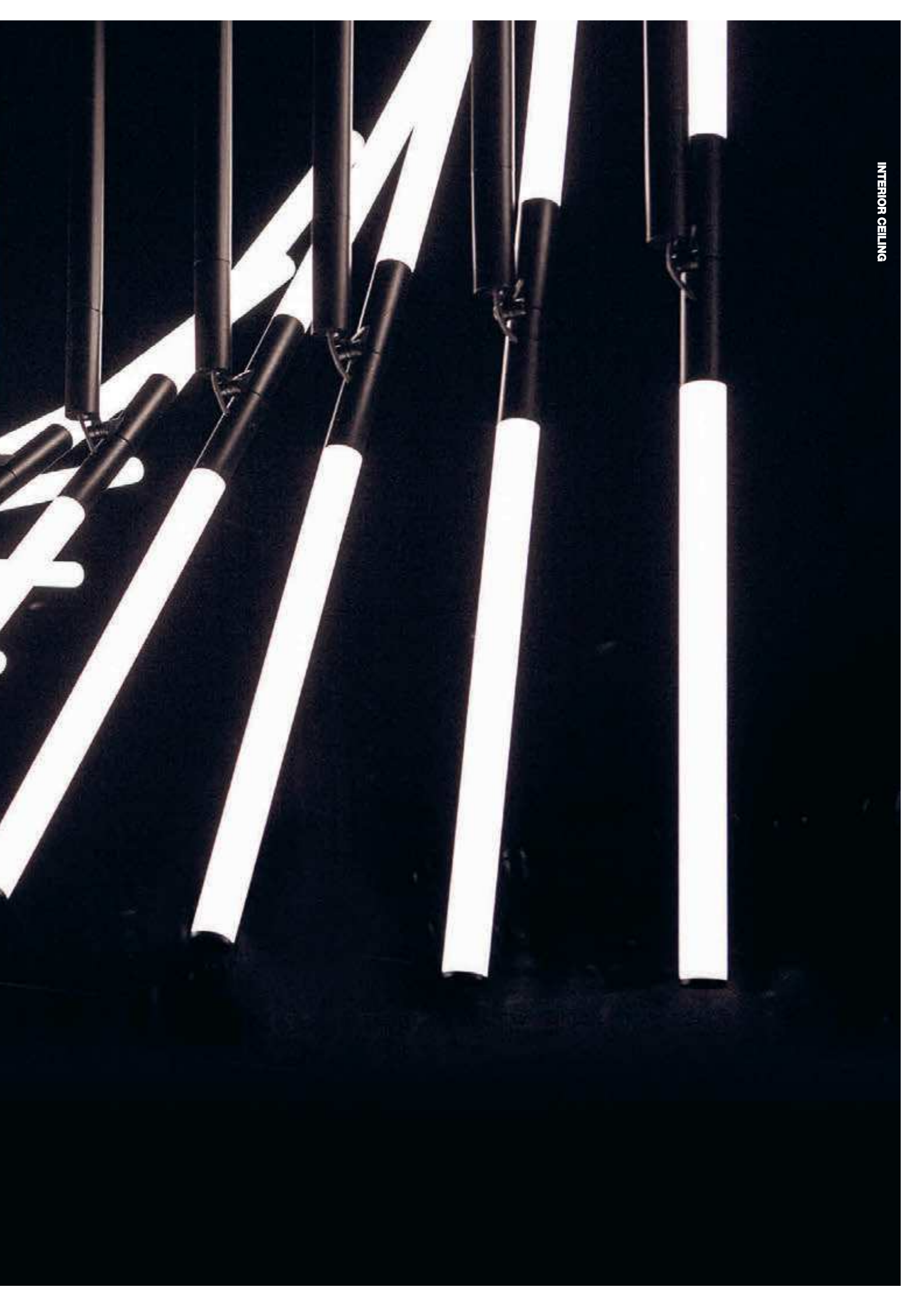

INTERIOR CEILING









BULHAUP / PHOTOGRAPHY CAFEINE

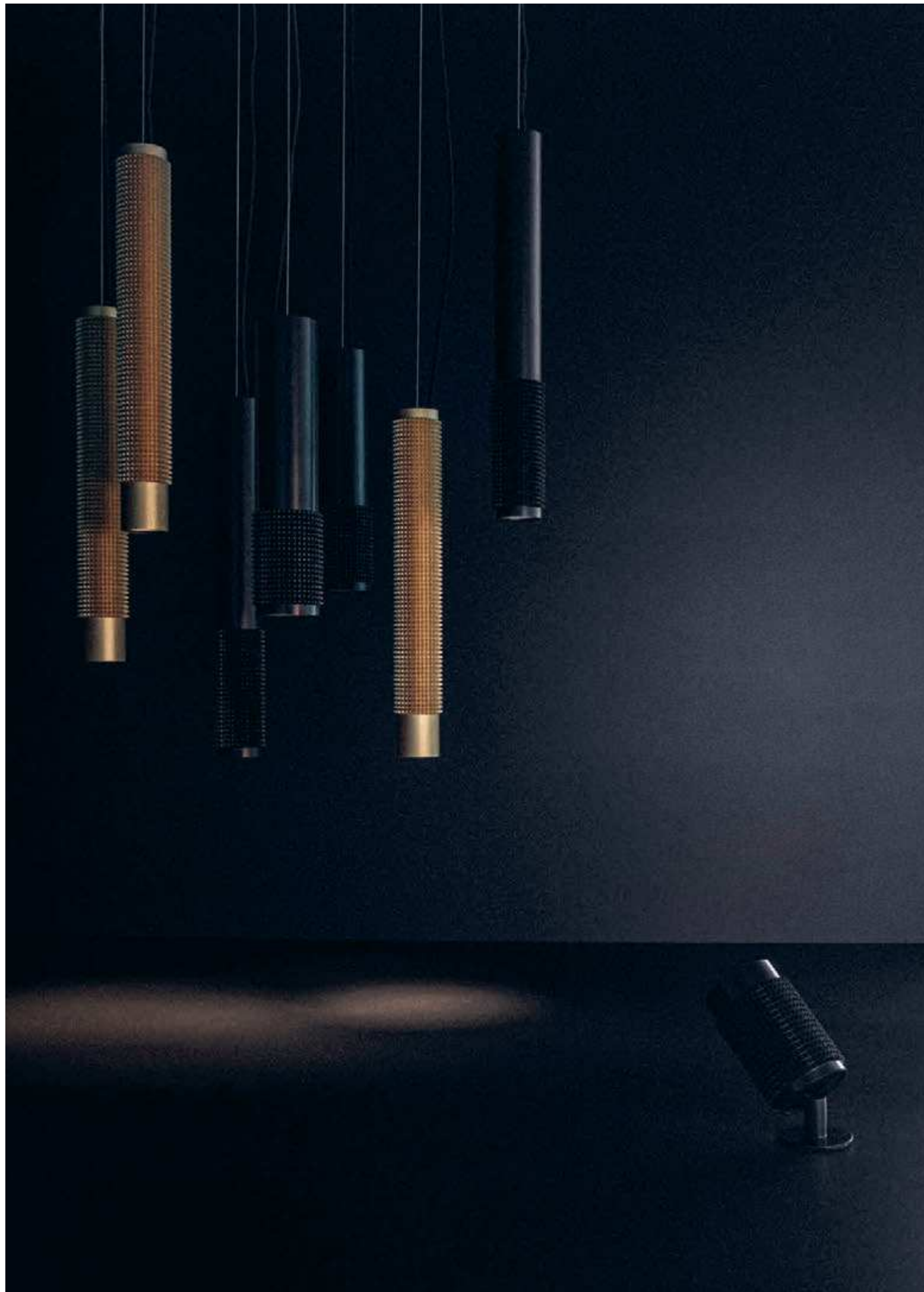

PUNK FAMILY

Step away from brave, alter yourself and dare to dare. This spiked design family breathes creativity and allows you to play with light and texture. To integrate the Punk experience throughout your project, the Punk design is available as a Clip version, as pendants, wall luminaires and in the XY180 range.

Available in Black, Gold Coloured and Black Pure, a Black coloured finish with pure aluminum topped spikes.

PUNK CLIP

Don't be deceived: Punk Clip may look small with its diameter of only 39mm, its performance is big! The Clip system lets you install Punk as a semi-recessed light, only letting the luminaire head peeking out of the ceiling.

PUNK C

With its particular design, the pendant versions of Punk make a statement on their own, but hanging them in a cluster make them look like a real eye-catcher. Combining different Punk lengths and different finishing colours makes a unique setting out of every Punk cluster.

Design by **OMA** & Delta Light

www.deltalight.com/punk



FAMILY OVERVIEW

CHOOSE YOUR COLOUR

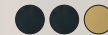

Black / Black Pure / Gold Coloured

CHOOSE YOUR INSTALLATION

Clip / Suspended

CHOOSE YOUR POWER

Clip

7,1W - 810lm

Suspended

6,4W up to 7,1W - 590 up to 810lm

CHOOSE YOUR LED COLOUR

2700K / 3000K

CHOOSE YOUR OPTICS

GU10

LED

24° / 33° / 40°

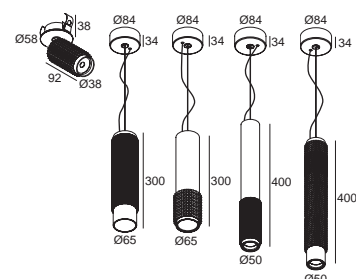









HEDRA VIZIR

FAMILY

Vizir and Hedra add refinement, finesse and colour to the range. They are characterized by an atypical hinge, a design element that not only catches the eye, but also serves as storage for technical parts inside the luminaire.

Next to black and white, the Vizir and Hedra are available in Gold Coloured and Black Bronze finishes, either polished or in faceted texture. The faceted design of the Hedra captures and reflects the ambient light with an ever-changing look a result. It is also the typical design element of the Hedra family, a series of pendant, spotlight and wall mounted luminaires, available as full LED solution or for retrofit bulbs.

www.deltalight.com/vizir-hedra



VIZIR - HEDRA CLIP / ON

The high-quality finishing on Hedra and Vizir instantly adds a touch of class to the room. The two installation possibilities - surface mounted or semi-recessed - allow to use these directable spotlights in any kind of application. Furthermore, the very slender base with integrated power supply of Vizir and Hedra 2 On bring extra flair and elegance.

VIZIR - HEDRA C

The pendants within Vizir and Hedra make you play with light and design. By combining decorative E27 bulbs with integrated LED, short with longer tubes, Vizir and Hedra or Black Bronze finish with Gold Coloured, every set-up will be different and unique.



FAMILY OVERVIEW

CHOOSE YOUR COLOUR



Black / Black Bronze / Gold Coloured / White

CHOOSE YOUR INSTALLATION

Clip

Surface mounted / Single or double

Suspended

CHOOSE YOUR LIGHT SOURCE & POWER

LED

3,9W up to 15W - 390 up to 1520lm

E27

CHOOSE YOUR LED COLOUR

2700K / 3000K

CHOOSE YOUR OPTICS

Surface 8° / 33°

Suspended 24° / 40°

CHOOSE YOUR ACCESSORY

Honeycomb / Lenses

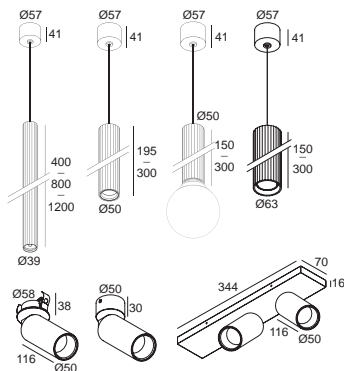





INTERIOR ARCHITECTURE BY @AFC-COLLECTION





ARCHITECT WALL ARCHITECTS / PHOTOGRAPHY ILYA IANOV



ION





NEEDLE

The slender shape of the Needle family brings a touch of elegance into any project.

Slim tubes, just carelessly hanging down from the ceiling or cleverly peeking around to throw a highlight wherever needed.

Combine multiple fixtures to create playful clusters or use it as a single luminaire in all its simplicity.

Design by **NITEO LIGHTING** & Delta Light

www.deltalight.com/needle





FAMILY OVERVIEW

CHOOSE YOUR COLOUR



Flemish Gold / Black Bronze

CHOOSE YOUR INSTALLATION

Trimless – Single
Fix or Adjustable

Surface mounted – Single / Double
Fix or Adjustable

CHOOSE YOUR POWER

3,9W up to 8,2W - 390 up to 680lm

CHOOSE YOUR LED COLOUR

2700K / 3000K

CHOOSE YOUR OPTICS

13° / 33°

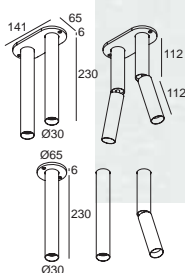



INTERIOR DESIGN PIETER SCHOOAERT



LINK S

Link S is synonymous for ultimate flexibility in architectural lighting. Play and adjust the round shapes to your preferences to create a custom lighting composition. Link starts at one connecting point, unfolding a web of creative solutions thanks to its single, double or triple modules.

www.deltalight.com/link



FAMILY OVERVIEW

CHOOSE YOUR COLOUR



Black / Flemish Gold / White

CHOOSE YOUR CONFIGURATION

Single / Double / Triple

POWER

7,1W – 810lm

CHOOSE YOUR LED COLOUR

2700K / 3000K

OPTICS

33°

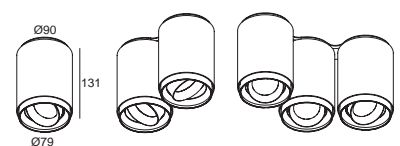



INTERIOR CEILING



CASTEELKEN





BOXY

FAMILY

What once began as a cubic luminaire is now an elaborate family of surface mounted luminaires, both cubic and cylindrical shaped.

Though different in shape they are still uniform in look, as both shapes have a deeper recessed LED module with a conical, coloured insert in front. While the deeper recessed LED module reduces the glare, the choice in colour creates possibilities for playful and attractive lighting solutions.

Alongside the different shapes, this family offers indoor and outdoor luminaires, a perfect solution when recessing is not an option. Furthermore, the WDL versions of Boxy are standalone luminaires for an easy wireless CTRL Delta lighting set-up.

www.deltalight.com/boxy





FAMILY OVERVIEW

CHOOSE YOUR COLOUR



Black / White
 Black-Flemish Bronze / Black-Flemish Gold /
 Black-Gold Matt / White-Black

CHOOSE YOUR SHAPE & SIZE



Round – Boxy & Boxy XL
 Square – Boxy & Boxy XL – Single / Double

CHOOSE YOUR INSTALLATION

Surface Mounted / Suspended

CHOOSE YOUR LIGHT SOURCE & POWER

Boxy
 7,1W up to 10,4W - 810 up to 1130lm

Boxy XL
 16,3W up to 23,2W - 2310 up to 3170lm

GU10

CHOOSE YOUR LED COLOUR

2700K / 3000K / Soft Dim

CHOOSE YOUR OPTICS

Boxy 33°
 Boxy XL 20° / 37°

CHOOSE YOUR CONTROL

Non Dim / 1-10V Dim / Mains Dim / Wireless Dim / DALI Dim

CHOOSE YOUR ACCESSORY

Honeycomb / Softening Lens / Glass SBL

IP20 IP53

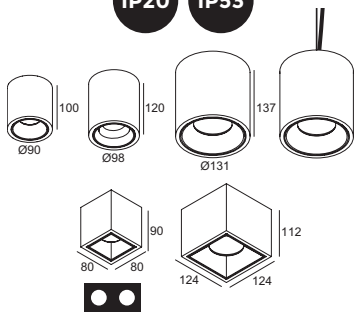



ARCHITECTS O'DONNELL + TUOMEY





ARCHITECT MEGÈVE DESIGN & AGENCE DAMIEN CARRERES



ARCHITECT MSM MEYERSCHMITZMORKRAMER, KÖLN / INTERIOR ARCHITECT LEPEL & LEPEL, KÖLN / PHOTOGRAPHER: HG ESCH / LIGHTING DESIGN AG LICHT, BONN

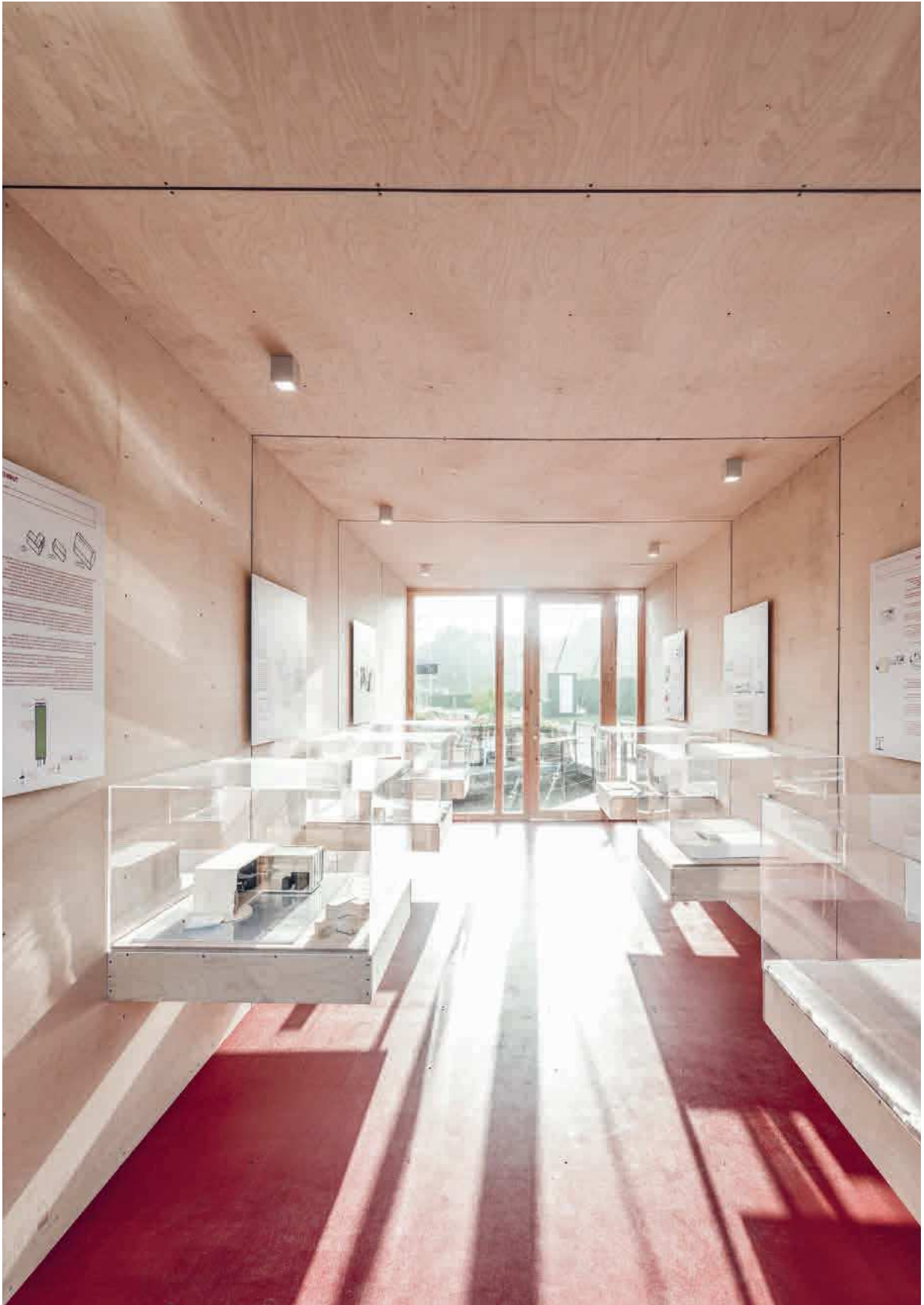





DOT.COM

FAMILY

First introduced in 2004 as a single LED luminaire, upscaled in 2008 as a multiple LED luminaire with 4 or 6 LED dots, implemented in the profile section in 2010 as a module with 4 or 6 LEDs, the history of Dot.Com within the Delta Light range goes way back. With LEDs being utterly functional and performant nowadays, Dot.Com is up to its second revival, coming as a complete family of luminaires with multiple LED dots to create the most discreet, yet highly functional light settings.

www.deltalight.com/dot-com



DOT.COM S

The Small version only needs 25mm of width, a nearly invisible appearance yet with visible impact.

DOT.COM M

The Medium range includes an adjustable version with trim and a trimless solution. The adjustable Dot.Com M – with tilting possibility up to 30° - is ideal for instance to emphasize an artwork on the wall. The specific design of the trimless luminaire grants the opportunity to install it either completely into the ceiling or semi-recessed, to evoke more expression into the room.

DOT.COM L

With an output up to 12W per luminaire, the Large range is the most powerful within the Dot.Com series. The Large version is the only version within the Dot.Com range that also offers surface mounted alternatives. Similar as for recessed installation, Dot.Com L brings a 2 LED and a 4 LED version within a compact design. With its low glare - thanks to the combination of individual reflectors per LED - Dot.Com L is perfectly applicable for office use.

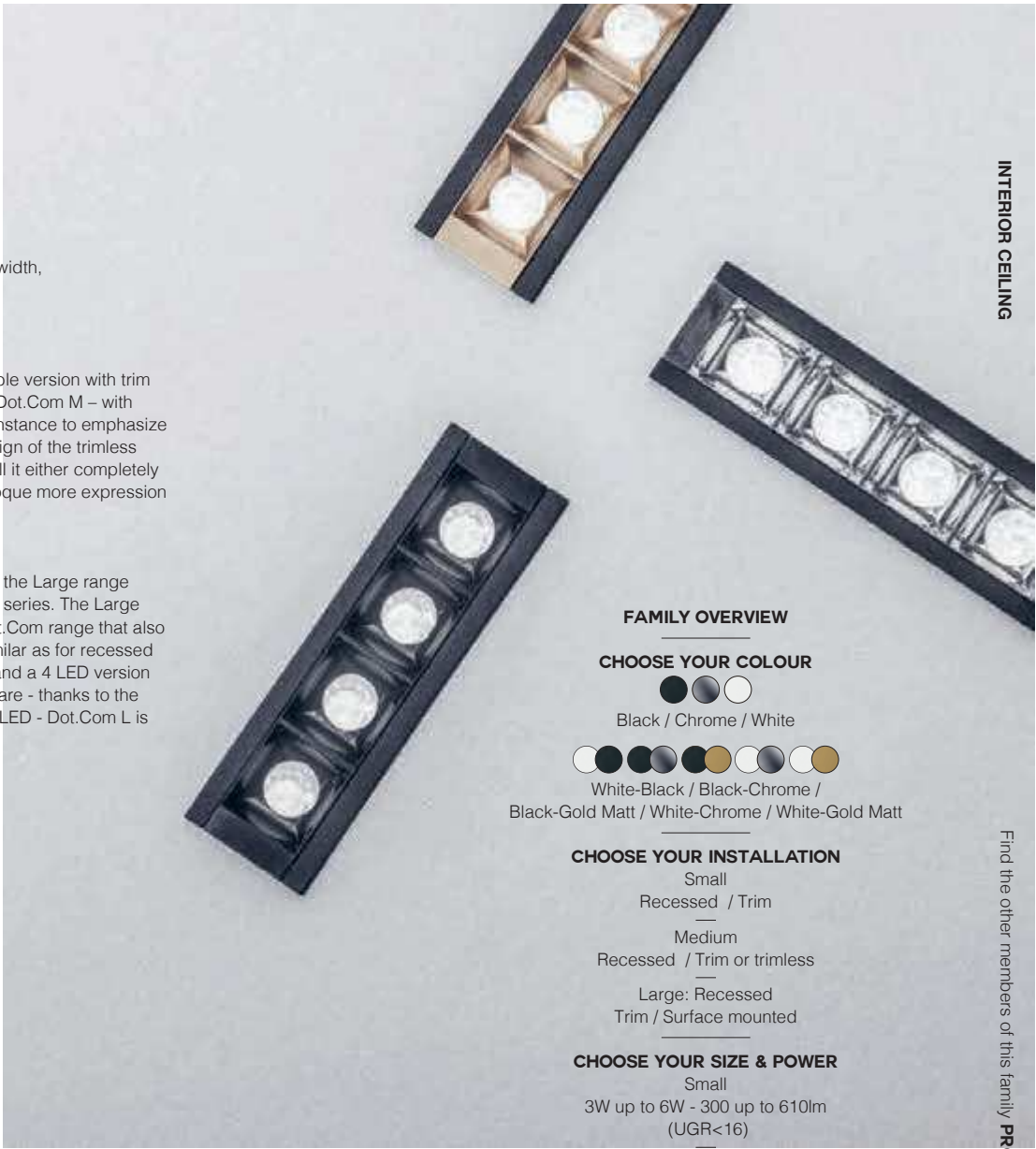

FAMILY OVERVIEW

CHOOSE YOUR COLOUR

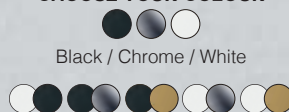

Black / Chrome / White

White-Black / Black-Chrome / Black-Gold Matt / White-Chrome / White-Gold Matt

CHOOSE YOUR INSTALLATION

- Small
- Recessed / Trim
- Medium
- Recessed / Trim or trimless
- Large: Recessed
- Trim / Surface mounted

CHOOSE YOUR SIZE & POWER

- Small
- 3W up to 6W - 300 up to 610lm (UGR<16)
- Medium
- 5,6W - 630lm (UGR<16)
- Large
- 4W up to 12,4W - 420 up to 1180lm (UGR<16)

CHOOSE YOUR LED COLOUR

2700K / 3000K

CHOOSE YOUR OPTICS

- Small
- 34° / 59°
- Medium
- 14° / 33° / 49°
- Large
- 16° / 32° / 46°

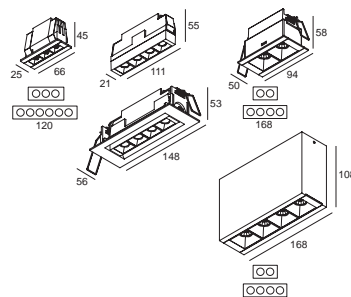



DOT.COM
WALLWASH
FAMILY

DOT.COM WALLWASH

Dot.Com is not only limited to spotlight beam angles, it also has linear wallwashers in its range for a soft, even light effect on vertical surfaces. These come as single luminaires both recessed as surface mounted, as modules to fit in the magnetic profiles and as a bespoke trimless profile solution, perfect to adapt the light to your specific desires.

www.deltalight.com/dot-com



FAMILY OVERVIEW

CHOOSE YOUR COLOUR



Black / White

CHOOSE YOUR INSTALLATION

Recessed / Surface mounted / Suspended

CHOOSE YOUR POWER

10W up to 25,2W - 1000 up to 3000lm

CHOOSE YOUR LED COLOUR

2700K / 3000K

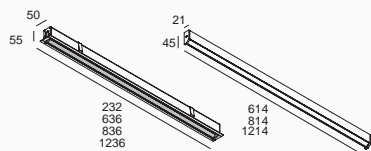



INTERIOR DESIGN OMAR ABDELGHAFOUR - LIGHT SPACE DESIGN / CONCEPT BLACK FOR GREEN SCAPE













HALOSCAN

PATENTED EX-CENTRIC ROTATION SYSTEM

FAMILY

Haloscan is a family of accent lights that come semi-recessed, surface mounted or as modules on the magnetic profiles. Designed around its flat optics, Haloscan combines ultra-minimalistic looks with a pleasurable light effect. The light is softly spread by the plane lens, creating up to 4 different beam angles, from spot to floodlight and even linear light.

To smoothly turn and tilt, Haloscan uses the Ex-Centric Rotation System, an asymmetrical hinge that combines rotating and tilting abilities in one swift move.

www.deltalight.com/haloscan





FAMILY OVERVIEW

CHOOSE YOUR COLOUR



Black / Gold Coloured / White

CHOOSE YOUR INSTALLATION

Semi recessed – With trim or as Clip version
Surface mounted – Single / Double

CHOOSE YOUR POWER

8,6W up to 11,7W – 1090 up to 1520lm

CHOOSE YOUR LED COLOUR

2700K / 3000K / Soft Dim

CHOOSE YOUR OPTICS

14° / 21° / 35°

CHOOSE YOUR ACCESSORY

Honeycomb / Linear Spread Lens

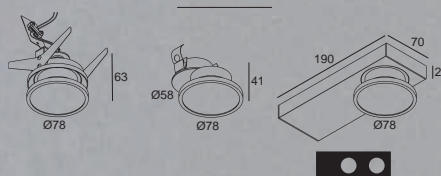



PLAY WITH LIGHT, SHAPE AND TEXTURE

With its different finishing colours, multiple beam angles and single or double versions, Haloscan On is perfect for creative compositions throughout an entire project. Play around with Black, White or Gold colour combinations, put together single or double units and use different optics to generate a synergy between light and dark.













reddot design award
winner



AWARD
DESIGN PLUS
light+building

Winner

GOOD
DESIGN
award

TWEETER

PATENTED EX-CENTRIC ROTATION SYSTEM

FAMILY

Tweeter has been one of the most remarkable families in the Delta Light collection for many years. Available as ceiling recessed and ceiling surface mounted, Tweeter introduces new levels in flexibility, both in movement as in lighting application. Tweeter is based on Delta Light's Ex-centric Rotation System, characterized by an asymmetrical hinge joint, combining extreme rotation and tilting abilities, all in one swift whirling motion.

The recessed Tweeter versions enable a maximum fuse of light and architecture. The spotlight heads are identical to the surface mounted installation and handling is simple and convenient. The double shell design prevents ceiling exposure, while the flexible inner shell tailors for any lighting need. Ultimate refinement is reached with a subtle aureole of light circling around the central led, offering improved lighting aesthetics. The application of the Ex-centric Rotation System not only upgrades movement of the fixture, but more importantly also provides advanced lighting abilities. The rotation mechanism was designed so that the light beam is not cut off, resulting in maximum efficiency.

www.deltalight.com/tweeter





The Tweeter On strikes a perfect balance between lighting quality and energy efficiency, adding value to the design statement of its environment. This striking yet elegant fitting suits every interior environment, pleasing the user with its supreme suppleness and intriguing appearance. Tweeter excels thanks to its ingenious design, refined to the last detail.

Constant evolution in LED has allowed for Tweeter M to be designed: minimal in dimensions, but using the same Ex-centric Rotation System for utmost flexibility. Finishing can be done in either full white or a remarkable Black-Chrome combination.



INTERIOR CEILING

FAMILY OVERVIEW

CHOOSE YOUR COLOUR



Black-Chromed / Black-White / White

CHOOSE YOUR INSTALLATION

Recessed – Trim / Trimless
Surface mounted

CHOOSE YOUR SIZE

Medium / Large

CHOOSE YOUR POWER

7,1W up to 10,4W - 810 up to 1130lm

CHOOSE YOUR LED COLOUR

2700K / 3000K / Soft Dim

CHOOSE YOUR OPTICS

33° / 50°

CHOOSE YOUR CONTROL

Mains Dim / Wireless Dim

CHOOSE YOUR ACCESSORY

Honeycomb / Glass SBL / Linear Spread Lens /
Softening Lens / Spread Lens

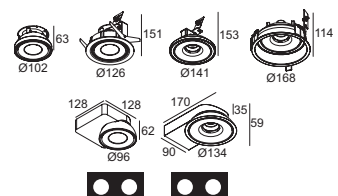



NINA MAYA INTERIORS / PHOTO: NICOLE ENGLAND









REID-SENEPART ARCHITECTEN



INTERIEURBURO PEDRO VERHUE



ODRON

FAMILY

HAVE ANOTHER LOOK

Don't be fooled: Odron may look peculiar at first sight, nevertheless its specific design is intended to create a compact yet powerful lighting solution. A second look puts everything in perspective: the flat design of the disc in combination with the shallow base results in a highly functional luminaire within a limited height of 45mm.

As from now, any additional look on it makes you appreciate Odron more and more: its possibility to serve both as a straightforward downlight or as an omnidirectional spotlight, the shiny details of the cover in contrast with the structured lacquer of the body or the touch of colour it adds thanks to the additional golden cover, it is clear that Odron enriches the space in more than one way.

The elegant Odron is available as a clip version and as a single or double spot to be mounted onto the ceiling or as module for our Magnetic profile range.

www.deltalight.com/odron





FAMILY OVERVIEW

CHOOSE YOUR COLOUR



Black / White
Finish off with a golden cover

CHOOSE YOUR INSTALLATION

Semi-recessed
Surface mounted – Single / Double

CHOOSE YOUR POWER

6, 1W up to 9W - 780 up to 1080lm

CHOOSE YOUR LED COLOUR

2700K / 3000K

CHOOSE YOUR OPTICS

28° / 41°

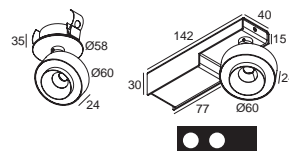





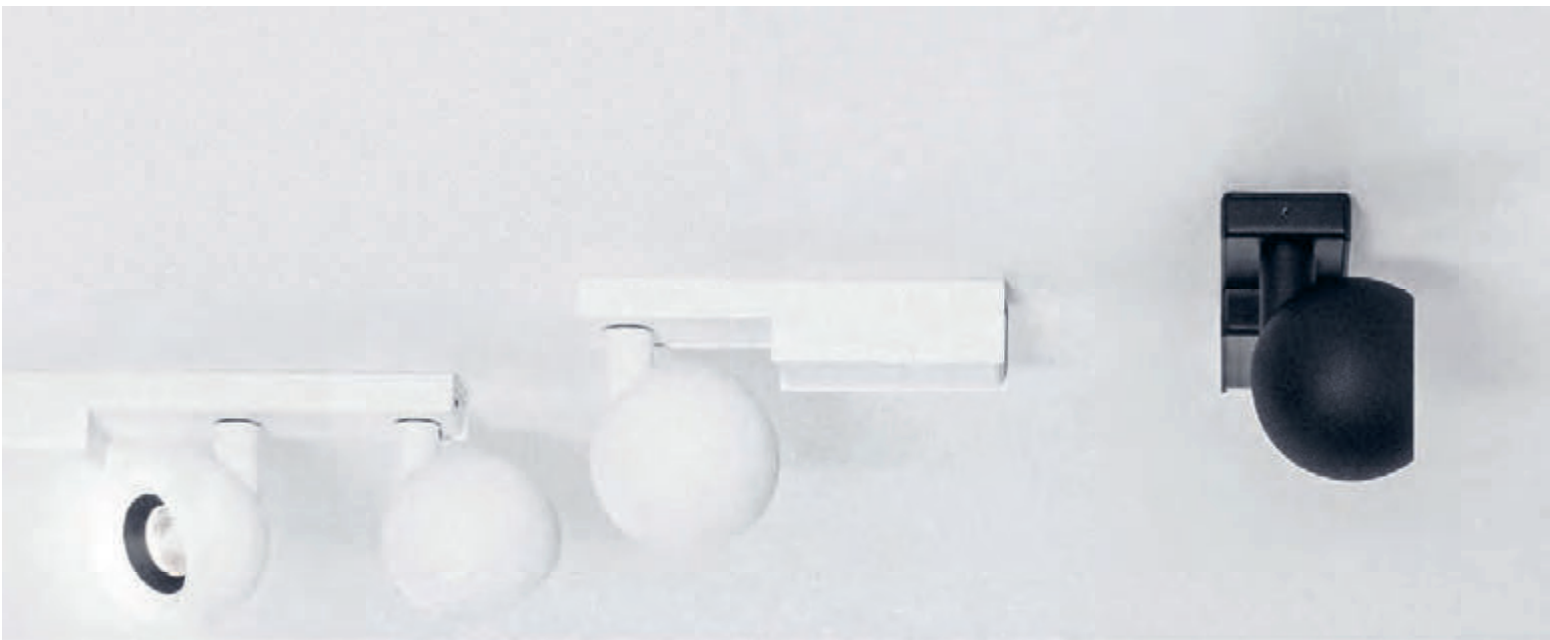

BOWIE

FAMILY

KEEP YOUR EYE ON THE BALL

Add some body to the room with Bowie, it impresses through its spherical shape. Twist and turn, tilt and aim, Bowie will always look the same, whatever its direction and no matter the angle you look at it. Bowie in pure white or black easily fits in any interior and adds a touch of richness to the room.

Within its range, Bowie comes as a semi-recessed Clip version, as a single or double spotlight to be surface mounted or as module to fit into our Magnetic profile offer.

www.deltalight.com/bowie



FAMILY OVERVIEW

CHOOSE YOUR COLOUR



White or Black

CHOOSE YOUR INSTALLATION

Semi-recessed

Surface mounted – Single / Double

CHOOSE YOUR POWER

6,1W up to 9W - 780 up to 1080lm

CHOOSE YOUR LED COLOUR

2700K / 3000K

CHOOSE YOUR OPTICS

25° / 37°

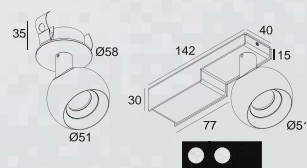



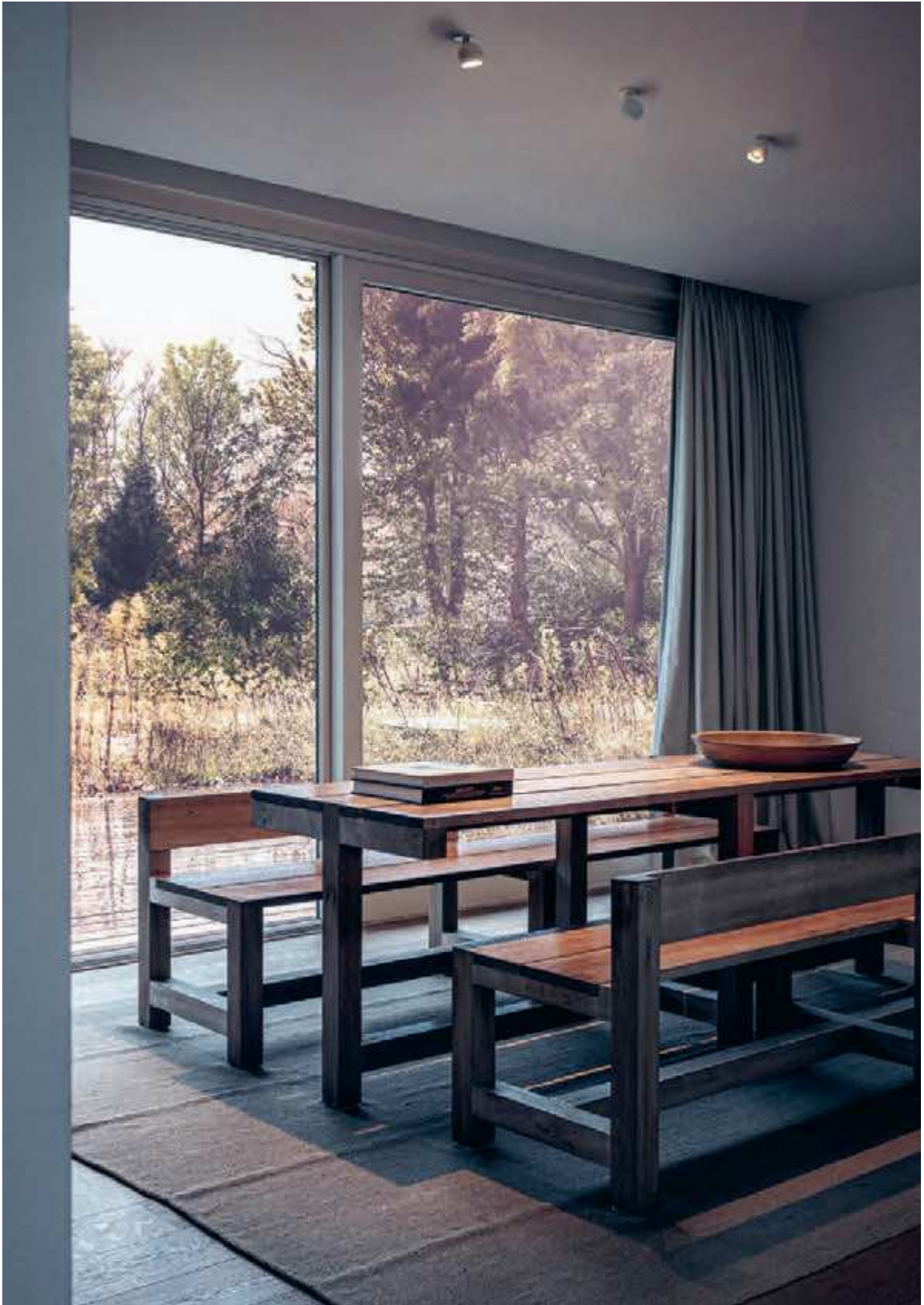



reddot design award
winner



PION

FAMILY

PATENTED EX-CENTRIC ROTATION SYSTEM

THE QUEEN, NOT THE PAWN

The shape of Pion resembles a lot the one of a pawn in a game of chess, but that is also the only resemblance. Opposite to a pawn, Pion is able to move around freely thanks to its unique Ex-centric Rotation System (ERS). Starting as a fix downlight, Pion can easily be turned into a periscope overlooking the room, simply by rotating its head.

The Ex-centric Rotation System then enables Pion to tilt its head, allowing it to spy around over 355° and tilt up to 90°, so aiming possibilities are unlimited.

Its elegant design in combination with the frisky colour combinations transform Pion immediately into the queen of the room, overlooking the scenery. Like any jewel, the colourful tubes serve as an accessory to top off its feminine shape in style.

www.deltalight.com/pion





BALANCED IN FORM AND FUNCTION

Pion is available as semi-recessed version, as surface mounted spotlight or as a plug-in module for our Magnetic profile range. As a recessed variant, the Ex-centric Rotation System is semi-recessed into the ceiling, hiding away the more technical part of the luminaire. As a ceiling mounted solution - with up to 3 modules per luminaire - Pion is not only about the looks, it is a textbook example of form meets function.

In this way, the triple surface mounted version of Pion completes 4 functions. 3 of them are lighting up the room in 3 different ways from only 1 feeding point, the 4th is doing it without compromising on style. The clean lines of the driverbox perfectly complement the organic shape of the luminaire's body.



Find the other members of this family **PROFILES**

FAMILY OVERVIEW

CHOOSE YOUR COLOUR



Black / Gold Coloured / White
Finish off with a
Golden or Black inner tube

CHOOSE YOUR INSTALLATION

Semi-recessed

Surface mounted
(single, double or triple)

CHOOSE YOUR POWER

6,1W up to 9W - 780 up to 1080lm

CHOOSE YOUR LED COLOUR

2700K / 3000K

CHOOSE YOUR OPTICS

25° / 37°

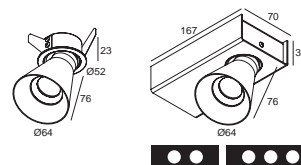







UHO

FAMILY

At first sight Uho appears to be simple. In close-up, the workmanship is being revealed in the little details. The refined ratio of the body compared to its diameter, the small joints that create a sophisticated look, the softly curved hinge that perfectly matches the contours of its body. With Uho, elegance is in the details.

Uho is available as accent light on our small profiles Splitline 14 and Shiftline 19 and as a spotlight it comes as a single or double Clip version and as a triple unit for surface mounting.

www.deltalight.com/uho





FAMILY OVERVIEW

CHOOSE YOUR COLOUR



Black / Flemish Bronze / Flemish Gold /
Gold Coloured / White

CHOOSE YOUR INSTALLATION

Semi-recessed as Clip version
Single / Double
Short / Long
—
Surface mounted
Triple - Long

POWER

3W – 300lm

CHOOSE YOUR LED COLOUR

2700K / 3000K

OPTICS

30°

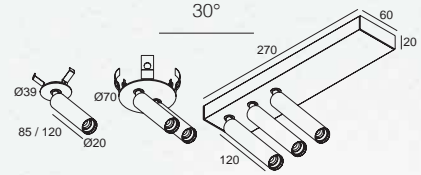



SPY FAMILY

Minimalism, functionality and versatility are the key terms to describe this extensive collection. The Spy was designed to meet multiple lighting requirements, an ideal solution for accent lighting in residential, hospitality or commercial spaces. The range features low to high lumen packages, narrow to wide beam options, standard or specific LED colours, recessed to surface mounted and track applications, different colour finishes and combinations, and can be equipped with multiple light refining accessories.

Following the constant changes in the world of LEDs and optics and the evolution to better user comfort with more precise optics and better light control, the complete Spy range has been upgraded. The result? Fresh shapes and additional finishing colours, better light comfort through hybrid optics, improved LED colour consistency and new perspectives with Tunable White and Soft Dim.

The renewed Spy family comes in diameters of 27, 39, 52, 66 and 90 millimeters, a range of spotlights to fit any purpose. While the smaller versions come in the lively colours Flemish Bronze, Flemish Gold and Gold Coloured, the bigger Spy's offer Tunable White and Soft Dim solutions in multiple beam angles.

PATENTED EX-CENTRIC ROTATION SYSTEM



**SPY 52**

The most extensive member within the Spy family: different installation methods, multiple light refining accessories to be added, mid- and high-power LEDs and even the possibility to opt for Soft Dim or Tunable White.

Containing a more powerful LED engine than Spy 39, Spy 52 has the same elegant ratio of diameter versus length. Combined with the Ex-centric Rotation System to swivel around, Spy presents itself like a curious object peeking from the ceiling, able to spy up to 350° around the room.

Requiring only 35mm of recessed depth, the Clip version of the Spy 52 combines easy installation together with a clean ceiling appearance and lots of functionality.

Similar as for Spy 39 On, single, double and even triple luminaire heads can be combined in a surface mounted solution.

To complete the family Spy 52 is available with a Soft Dim or Tunable White LED inside. A Soft Dim version offers the cosy feeling of halogen when dimming down, changing the colour temperature into a warm glow of light. Tunable White allows you to change the type of white to your preference, from warm up to very cold white.

www.deltalight.com/spy-52





SPY 66 / 90

Spy 66 offers a range of optics to create multiple beam angles within different output levels. Ranging up to 24,6W, Spy 66 is available as Clip and On version, allowing an easy installation. With 3 beam angles in standard white LED colours and Tunable White, Spy 66 is perfect to apply in retail and public environments.

Spy 90 On is the surface mounted Spy solution for high output and ultimate performance, as it has an integrated dimmable driver inside. In line with the complete Spy range, the tubular design can be finished with the coloured insert of your choice, but Maxispy On especially wows you with its output up to 3200lm and its choice of 3 different beam angles.

www.deltalight.com/spy-66

www.deltalight.com/spy-90



**SPY 39**

Compact in design, complete in functionality. Spy 39 is one of the most elaborate members of the family thanks to its multiple lumen packages, beam angles and ways of installation.

As a recessed solution, Spy 39 comes in many appearances. The Trimless version can serve both as a downlight or as an adjustable spotlight, as the body can either be completely hidden into the ceiling or fully visible to aim it wherever you want.

As surface mounted version, Spy 39 On comes with single and double head combinations, with a short or longer cylinder on top. Similar to the On version, but without the visible surface mounted box, Spy 39 Cip hides away the installation part into the ceiling. The result is a single spotlight with a minimalistic yet sophisticated look.

Powering up to 8,6W and available in multiple finishing colours, Spy 39 is suitable for a range of applications.

www.deltalight.com/spy-39





MICROSPY

This miniature range offers fix and adjustable recessed luminaires, with and without trim, in a spot or flood beam angle. The trimless versions of Microspy make use of the Snap-In principle, facilitating installation as the frame can be placed in advance and light modules can be added in a finishing stage. As a pendant module its slenderness allows you to create playful or humble set-ups by grouping multiple luminaires or choosing just one single pendant.

SPY – SPY FOCUS

As a straightforward downlight, Spy is available for direct ceiling fixation or as a pendant, ideal to create a powerful and striking light effect. With Spy Focus one can opt for different beam angles out of only 1 luminaire, as the circle of light can be widened or narrowed by rotating the front of the fittings' body. As such, every beam angle between 8° and 43° is possible.

www.deltalight.com/spy



**SPY 27**

Spy 27 is the smallest of the range and comes as a Clip version or as surface mounted spotlight with 1, 2 or 4 cylinders on top. Don't be fooled by its size, with a power of 5,8W it perfectly serves for general lighting in residential environments. For optimized visual comfort, a visor is available to reduce the glare when looking into the luminaire.

www.deltalight.com/spy-27

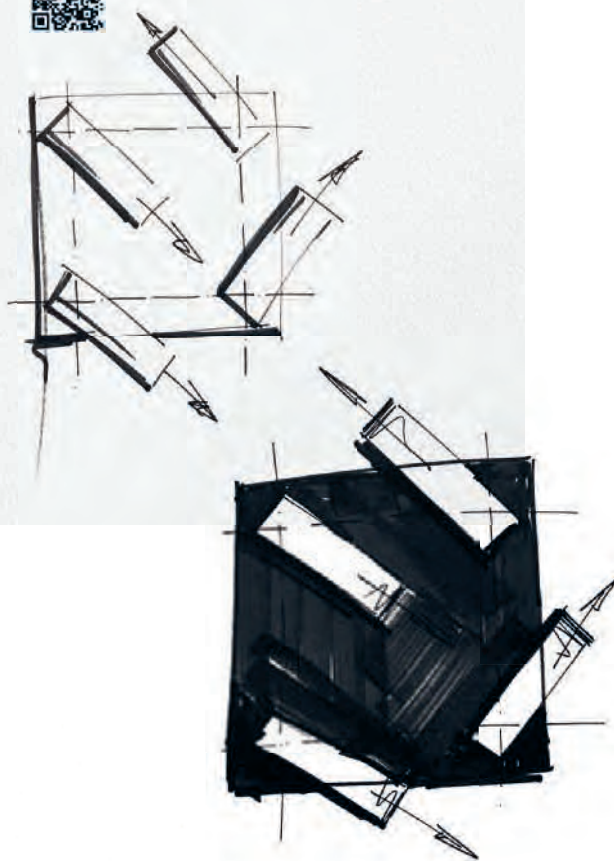



FAMILY OVERVIEW

MICROSPY

CHOOSE YOUR COLOUR



Black / White

CHOOSE YOUR INSTALLATION

Recessed
With trim / Trimless
Suspended

CHOOSE YOUR POWER

3,9W up to 7,1W – 390 up to 810lm

CHOOSE YOUR LED COLOUR

2700K / 3000K

CHOOSE YOUR OPTICS

15° / 24° / 30°

SPY / SPY FOCUS

CHOOSE YOUR COLOUR



Black / Flemish Bronze / Flemish Gold / White



Front tube in
Black / Flemish Bronze / Flemish Gold / Gold Matt / Silver Grey / White

CHOOSE YOUR INSTALLATION

Semi-recessed
Surface mounted
Suspended

CHOOSE YOUR LIGHT SOURCE & POWER

LED
6,1W up to 10,4W – 780 up to 1130lm
GU10

CHOOSE YOUR LED COLOUR

2700K / 3000K

CHOOSE YOUR OPTICS

33° / Focus 8° to 43°

SPY 27

CHOOSE YOUR COLOUR



Black / Flemish Bronze / Flemish Gold / Gold Coloured / White

CHOOSE YOUR INSTALLATION

Semi-Recessed
Short / Long
Surface mounted
Single / Double / Quadruple

POWER

5,8W – 790lm

CHOOSE YOUR LED COLOUR

2700K / 3000K

OPTICS

30°

ACCESSORY

Visor

SPY 39

CHOOSE YOUR COLOUR



Black / Flemish Bronze / Flemish Gold / Gold Coloured / White



Front tube in
Black / Flemish Bronze / Flemish Gold / Gold Coloured / White

CHOOSE YOUR INSTALLATION

Recessed
With trim / Trimless
Semi-recessed
Short / Long
Surface mounted
Single / Double
Short / Long

CHOOSE YOUR POWER

5,8W up to 8,6W – 790 up to 1090lm

CHOOSE YOUR LED COLOUR

2700K / 3000K

CHOOSE YOUR OPTICS

20° / 40°

ACCESSORY

Visor

SPY 52

CHOOSE YOUR COLOUR



Black / Flemish Bronze / Flemish Gold / Gold Coloured / White



Front tube in
Black / Flemish Bronze / Flemish Gold / Gold Coloured / White

CHOOSE YOUR INSTALLATION

Recessed
With trim / Trimless
Semi-recessed
Surface mounted
Single / Double / Triple

CHOOSE YOUR POWER

8,6W up to 12,4W – 1090 up to 1470lm

CHOOSE YOUR LED COLOUR

2700K / 3000K / Soft Dim / Tunable White

CHOOSE YOUR OPTICS

20° / 45°

CHOOSE YOUR ACCESSORY

Honeycomb / Glass SBL / Linear Spread Lens / Softening Lens / Spread Lens

SPY 66

CHOOSE YOUR COLOUR



Black / White



Front tube in
Black / Flemish Bronze / Flemish Gold / Gold Coloured / White

CHOOSE YOUR INSTALLATION

Semi-recessed
Surface mounted

CHOOSE YOUR POWER

17,1W up to 24,6W – 2130 up to 2910lm

CHOOSE YOUR LED COLOUR

2700K / 3000K / Tunable White

CHOOSE YOUR OPTICS

18° / 30° / 45°

CHOOSE YOUR ACCESSORY

Honeycomb / Glass SBL / Linear Spread Lens / Softening Lens / Spread Lens

SPY 90

CHOOSE YOUR COLOUR



Black / White



Front tube in
Black / Flemish Bronze / Flemish Gold / Gold Coloured / White

INSTALLATION

Surface mounted

POWER

23,2W – 3170lm

CHOOSE YOUR LED COLOUR

2700K / 3000K

CHOOSE YOUR OPTICS

18° / 30° / 45°

CHOOSE YOUR ACCESSORY

Honeycomb / Glass SBL / Linear Spread Lens / Softening Lens / Spread Lens

CONTROL

1-10V Dim



MICROSPY
SPY 39
SPY 52



MICROSPY
SPY 39
SPY 52



SPY
SPY 27
SPY 39
SPY 52
SPY 66
SPY 90
FOCUS



SPY
SPY 39
SPY 52
SPY 66
SPY 90
FOCUS

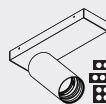

SPY 27
SPY 39
SPY 52

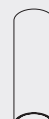

SPY



MICROSPY
SPY











INTERIOR DESIGN MAISTER / PHOTOGRAPHY BERT DEMASURE



INTERIOR DESIGN MAISTER



RAND

Rand is a longstanding classic in the Delta Light collection, confirming the company's philosophy for timeless design. Avoiding visible screws, Rand offers you a stylish and highly flexible lighting solution for both residential and non-residential projects. As a full LED version, Rand combines ecology and esthetics, and guarantees a perfect balance between lighting quality and energy efficiency.

www.deltalight.com/rand



FAMILY OVERVIEW

CHOOSE YOUR COLOUR



Alu Grey / Black / White

CHOOSE YOUR SIZE

Single / Double / Triple

POWER

13W – 730lm

OPTICS

24°

CONTROL

Mains Dim









SUPER-OH!
FAMILY



SUPER-OH! TRIMLESS

To keep a consistent design code throughout your project you can also integrate a trimless Super-Oh. The result is a fully recessed, slim aureole. A symbol of infinity, without beginning or end, perfect, the ultimate geometric symbol seamlessly integrated into architecture.

SUPER-OH! SLIM

Evolving from our existing Super-Oh! family, Super-Oh! Slim stands out in design and efficiency. With a width of only 44mm and a luminous efficacy up to 119lm/W, this family of halo's combines slender elegance with big performance. Super-Oh! Slim comes in 2 diameters - 800mm and 1200mm - and is available with only direct light or a combination of direct and indirect light.

Two different designs allow you to either opt for clean lines in a soothing setting or either go for a design statement by choosing Super-Oh! Slim with an integrated powerbox. Apart from its functionality, the integrated powerbox acts as a rebel element, disrupting the perfect geometrical circle of light and adding a peculiar touch to the project.

www.deltalight.com/super-oh-slim



SUPER-OH! SLIM

CHOOSE YOUR COLOUR



Black / White

CHOOSE YOUR DESIGN

With ceiling base / Integrated powerbox

CHOOSE YOUR SIZE & POWER

Ø 800mm

Down / 31W up to 48W - 5000 up to 7200lm

Down-Up / 55W up to 71W - 8800 up to 11000lm

Ø 1200mm

Down / 48W up to 71W - 7700 up to 10800lm

Down-Up / 84W up to 107W - 13500 up to 16500lm

CHOOSE YOUR INSTALLATION

Recessed Trimless

Surface mounted (Down)

Suspended (Down or Down-Up)

CHOOSE YOUR CONTROL

Non Dim / 1-10V Dim / DALI - DSI Dim

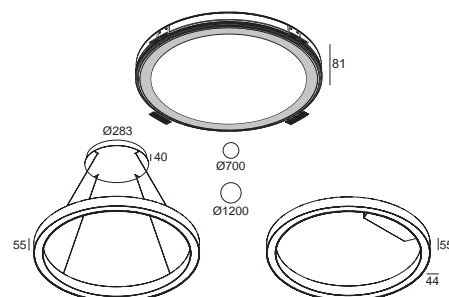



SUPER-OH!

CHOOSE YOUR COLOUR

●
Black

CHOOSE YOUR LIGHT & LIGHT EFFECT

LED (Down or Down-Up)
—
E27

CHOOSE YOUR SIZE & POWER

Ø700mm
3 x 6W – 560lm (Down) /
3 x 3,2W – 370lm (Up)
—
Ø1200mm
6 x 6W – 560lm (Down) /
6 x 3,2W – 370lm (Up)
—
Ø1700mm
8 x 6W – 560lm (Down) /
8 x 3,2W – 370lm (Up)

CONTROL
Mains Dim

SUPER-OH!

A series of slim black rings floating through space, finished either with integrated powerleds or the more retro-look version with classic light bulbs. The Super-Oh can also be combined with Delta Light's Wireless Control Dimming module, allowing you to manage your Super-Oh from your mobile device.

www.deltalight.com/super-oh

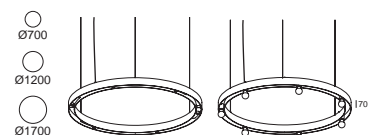

SUPER-OH! XS

With its 25cm or 39cm diameter, the Super-Oh XS (Extra Small) can be considered to be the "little one" of the family. With only 5cm height, this perfectly curved circle holds a polycarbonate, hiding an intense clustered inner circle of the latest powerleds. This circle of leds is specially designed to guarantee a uniform and perfectly balanced light output, resulting in a very enjoyable diffuse lighting effect. The Super-Oh XS is available either for direct mounting, as a suspension or with a pivot, a flexible ceiling bracket enabling the user to tilt the disc up to 45°, and rotate 360°.

www.deltalight.com/super-oh-xs

SUPER-OH! XS

CHOOSE YOUR COLOUR

● ●
Black / White

CHOOSE YOUR DESIGN
With ceiling base / Integrated powerbox

CHOOSE YOUR SIZE & POWER

Ø250mm
13,5W - 1470lm

Ø390mm
25W - 2940lm

CHOOSE YOUR INSTALLATION
Surface mounted (fix or adjustable)
Suspended (single or as cluster)

CONTROL
Mains Dim

CLUSTER SUSPENSION



W. ARCHITEKTEN / PHOTOGRAPHY HG ESH





INTERIOR ARCHITECTURE BY @AFC-COLLECTION



ROOMIN.BE



reddot design award
winner



GOOD
DESIGN
AWARD

SUPERLOOP

A luminaire can be more than light alone. It can be functional, it can be decorative, it can be an eye catcher. This family not only exists out of circles of light, it also brings circular and squared low voltage solutions for track lighting, so general and accent lighting can be combined within one family. In this way, Superloop allows you to choose 'functional', by mounting adjustable Spy modules on the round or square shaped base. It allows you to choose 'decorative', by mounting the light emitting circle in a horizontal way, or it allows you to choose 'eye catcher', by carelessly hanging the circle of light vertical, as a statement.

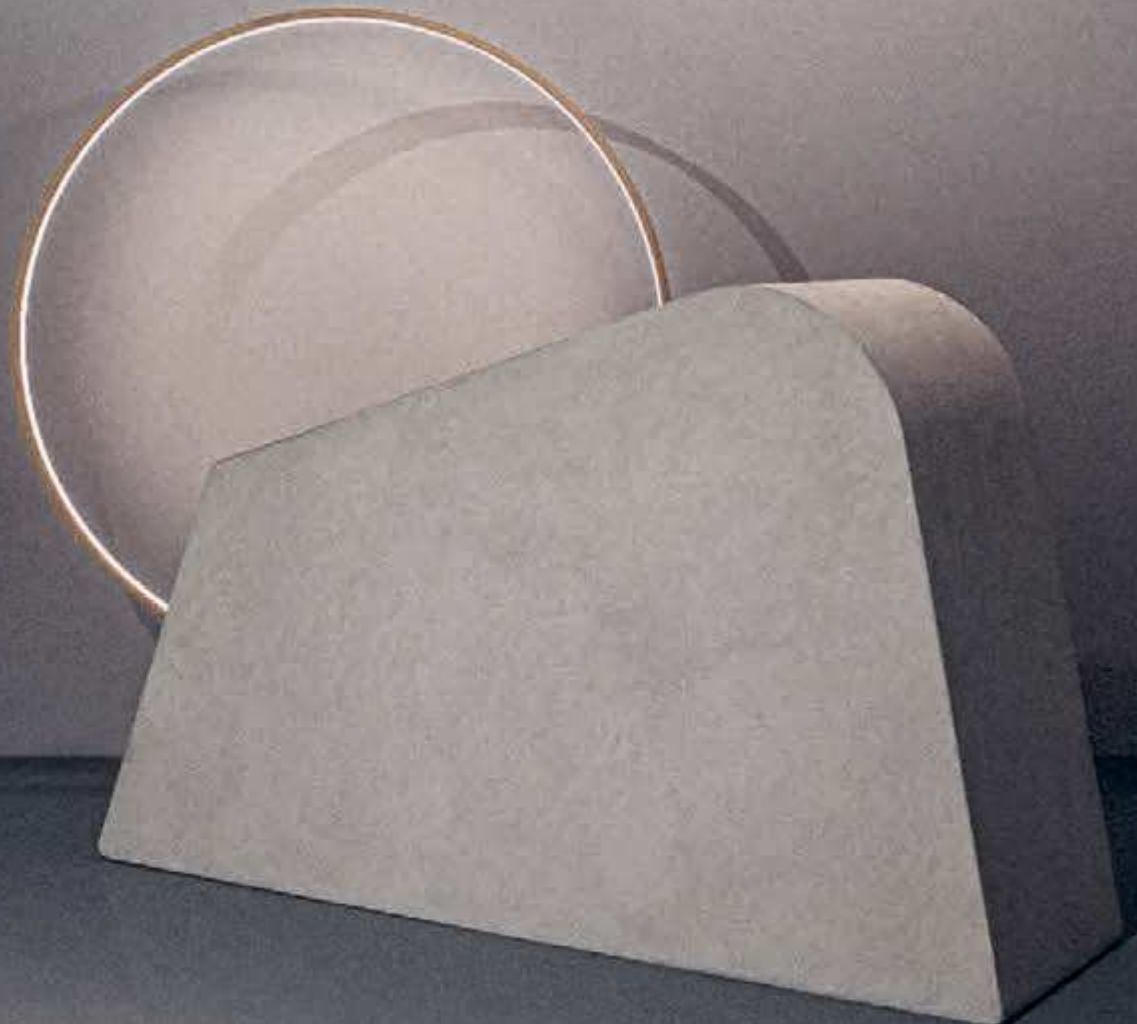

SUPERLOOP SBL

Superloop HC with circular light has the ability to diffuse light all around. It represents a universal symbol with extensive options, a perfect circle of light, rolled out of 1 aluminium profile and seamlessly welded together. The specially designed current controlled LEDflex inside Superloop SBL allows it to be dimmed in various ways. Diameters up to 1700mm and finishes in different colours let you create the setting you want.

Similar to Superloop SBL HC, but more dramatic in expression, Superloop SBL VC grants the opportunity to use light in a different way. The vertical circle of light draws the attention and stimulates creativity.

For a more bold and expressive application you can opt for the Superloop VR, mounting the circle of light with a steel rod. Sculptural in presence, resonating with symbolism and respecting pure minimalism, the Superloop VR offers a very airy and remarkable element to your interior concept.

Either as a single version or in a sequence to create striking vertical effects.

www.deltalight.com/superloop-sbl



SUPERLOOP SBL

CHOOSE YOUR COLOUR



Black, Flemish Bronze, Flemish Gold, White

CHOOSE YOUR SIZE & POWER

Round

Ø700 / 900 / 1200 / 1700mm

2800 up to 6700lm

Round XL

Ø2000 / 2500 / 3000 / 3500 / 4000 / 5000mm

13200 up to 33000

CHOOSE YOUR INSTALLATION

Horizontal / vertical

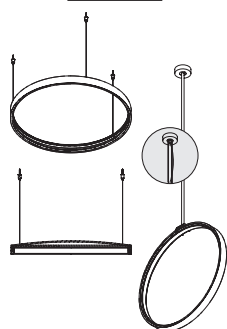

SUPERLOOP PLUS

New within the favorite series of Superloop are the horizontal versions with integrated decorative panel on top. The profile has an additional compartment on the upper part which serves to hold a decorative element, be it to add a personal touch, improve acoustics or make a decorative element out of the minimalistic circle. Superloop Plus is available for all Superloop HC versions with a diameter up to 1200mm.

As so you can combine both Superloop SBL as MDL with an additional touch of style, one to offer general lighting and light up the panel, the other one to create accent lighting thanks to the additional spot modules that can be fixed onto the Superloop MDL.

www.deltalight.com/superloop-plus

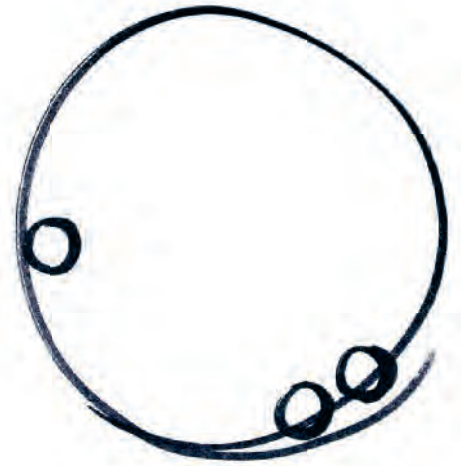

SUPERLOOP PLUS

CHOOSE YOUR COLOUR



Black, Flemish Bronze, Flemish Gold, White

CHOOSE YOUR SIZE

ROUND

Ø700 / 900 / 1200mm

2800 up to 6000lm

CHOOSE YOUR TYPE

SBL / MDL

CHOOSE YOUR PANEL

PET-felt Light Grey or Dark Grey

Personalize your Superloop Plus to your taste

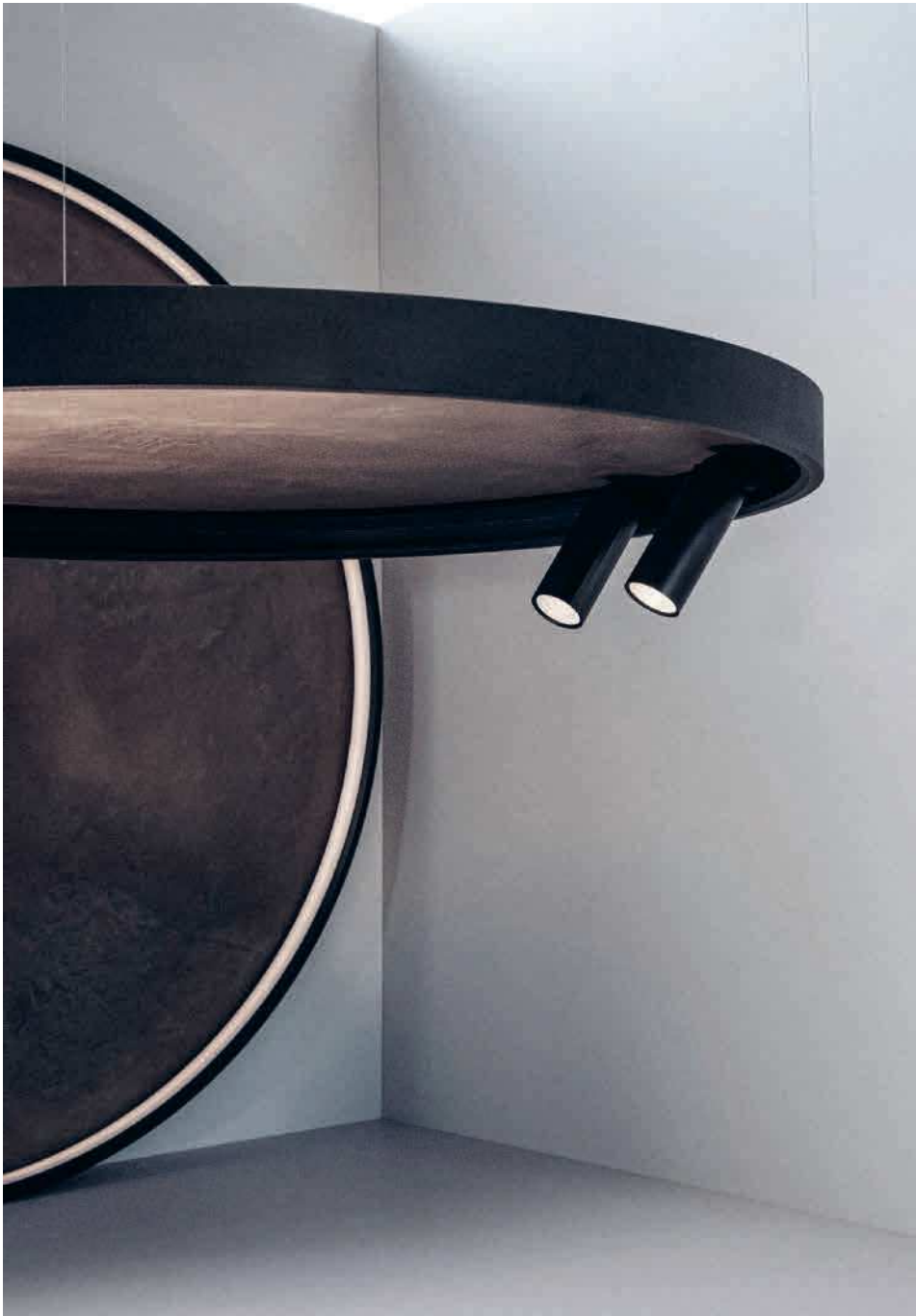
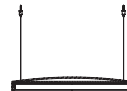



SUPERLOOP MDL PATENTED

Superloop is also available in a round or square shape with a Delta Light custom engineered 48V low voltage track on the inside. This allows you to position and move light modules all around, offering maximum flexibility and allowing you to meet any need of the project.

The modules enable you to move from subtle functionality to very expressive or timeless elegance. The Flemish Gold and Flemish Bronze finishes or the Spot modules Vizir and Hedra offer you a way to upgrade the minimal appearance of the loop. By adding the Fix modules with down- or down-up light, combined with a clear or frosted glass, you can transform your Superloop into a modern chandelier. Looking for a more expressive and unique statement? Just plug and play with the ledtubes of the XY180 collection.

www.deltalight.com/superloop-mdl





SUPERLOOP MDL

CHOOSE YOUR COLOUR



Black, Flemish Bronze, Flemish Gold

CHOOSE YOUR SIZE

ROUND

Ø700 / 900 / 1200 / 1700mm

ROUND XL

Ø2000 / 2500 / 3000 / 3500 / 4000 / 5000mm

SQUARE

600x600 / 900x900mm

RECTANGULAR

250x1100 / 250x1700mm

CHOOSE YOUR LIGHT EFFECT

Accent lighting: Spy / Vizir / Hedra

General light: Fix / XY180

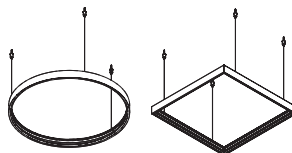





INTERIOR DESIGN WEWANTMORE



ARCHITECT WALL ARCHITECTS / PHOTOGRAPHY ILYA IANOV



INTERIEURBURO PEDRO VERHUE





ADOMO / PHOTOGRAPHY GAVRIIL PAPADIOTIS WWW.GAVRIILUX.COM



ARCHITECT MILENA VUKMIROVIĆ DARCH



SOLISCAPE

PATENT PENDING



UNStudio and Delta Light have joined forces to endeavour to improve the wellbeing of people in our rapidly changing work environments, where human health and the war on talent have become a primary focus of employers.

Together we are developing a system that facilitates, responds and contributes to solving these complex challenges.

An extremely versatile and flexible system, specifically designed to create human-centric environments.

www.deltalight.com/soliscap



Design by **UNStudio** & Delta Light

UNStudio

FRANKFURT • SHANGHAI • HONG KONG
AMSTERDAM

UNStudio, founded in 1988 by Ben van Berkel and Caroline Bos, is a Dutch architectural design studio specialising in architecture, interior architecture, product design, urban development and infrastructural projects. The name, UNStudio, stands for United Network Studio, referring to the collaborative nature of the practice.

Throughout over 30 years of international project experience, UNStudio has continually expanded its capabilities through prolonged collaboration with an extended network of international consultants, partners, and advisors across the globe. This network, combined with the centrally located offices in Amsterdam, Shanghai, Hong Kong and Frankfurt, enables UNStudio to work efficiently anywhere in the world. With already 120 built projects in Asia, Europe, and North America, the studio continues to expand its global presence with recent commissions in among others China, South-Korea, Australia, Germany and the UK.

As a network practice, a highly flexible methodological approach has been developed which incorporates parametric designing and collaborations with leading specialists in other disciplines.

The office has worked internationally since its inception and has produced a wide range of work ranging from public buildings, infrastructure, offices, residential, products, to urban masterplans.

Current projects include the mixed-use FOUR development in Frankfurt, the wasl Tower in Dubai and the Southbank by Beulah development in Melbourne. Pivotal realised projects include the Mercedes-Benz Museum in Stuttgart, Arnhem Central Station, Raffles City Hangzhou in China, the Mobius House in the Netherlands and the Erasmus Bridge in Rotterdam.



"From architecture to product design and from research to innovation; we always aim to find new ways to design for a better reality, with the user constantly at the center of everything we conceive."



BEN VAN BERKEL

Professor AA Dipl. (Hons), (F)RIBA, Hon. FAIA
 Founder / Principal Architect UNStudio
 Founder UNSense

Ben van Berkel studied architecture at the Rietveld Academy in Amsterdam and at the Architectural Association in London, receiving the AA Diploma with Honours in 1987.

In 2018 Ben van Berkel founded UNSense, an Arch Tech company that designs and integrates human-centric tech solutions for the built environment. Ben van Berkel has lectured and taught at many architectural schools around the world. From 2011 to 2018 he held the Kenzo Tange Visiting Professor's Chair at Harvard University Graduate School of Design, where he led a studio on health and architecture. In 2017, Ben van Berkel also gave a TEDx presentation about health and architecture. In addition, he is a member of the Taskforce Team / Advisory Board Construction Industry for the Dutch Ministry of Economic Affairs.

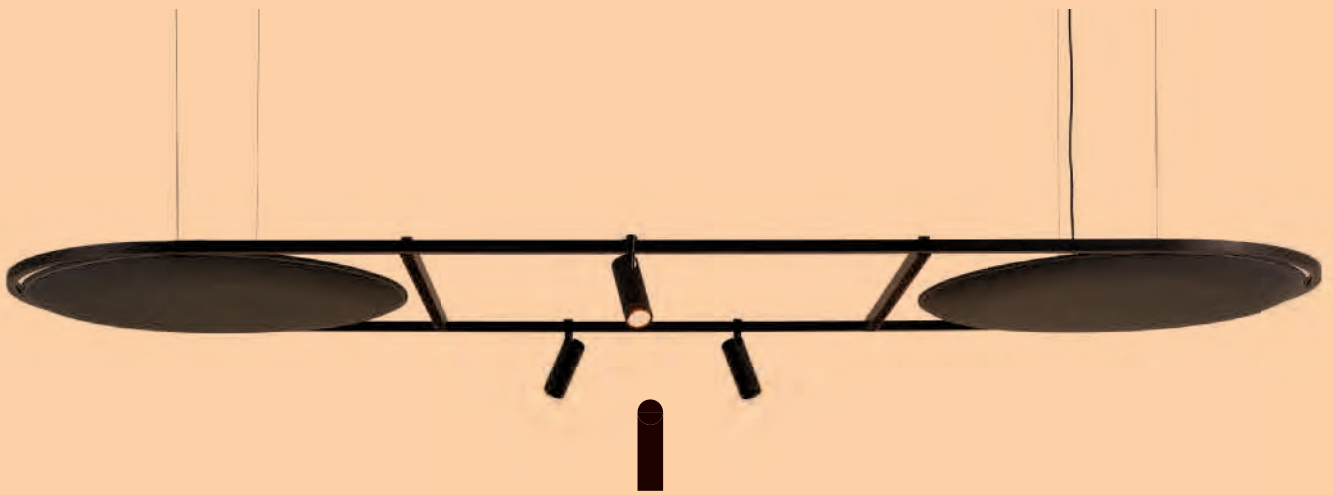

TOOLBOX

The system is a toolbox of flexible components for architects and designers, that will enable them to create workable and liveable solutions for their projects;

a system that combines lighting with acoustics and IOT, into an aesthetically appealing solution that can easily connect to any building management system. The system is also flexible and future-proof, as it allows for new materials and functions to be added in the future.

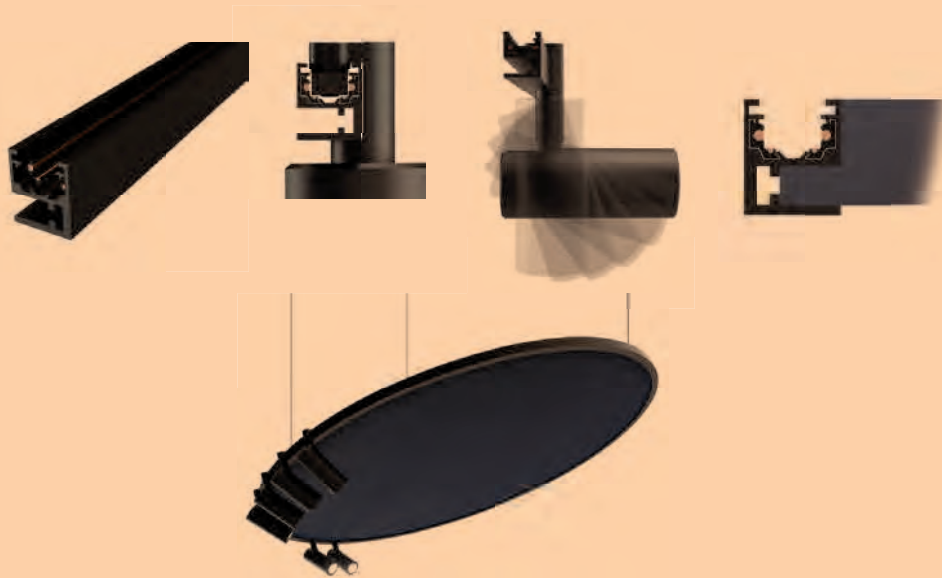



ADAPTIVE DESIGN

The intention is to create flexible lightscapes that are responsive to the user's ever-changing needs and activities, where design is no longer imposed by the designers, but guided by the user, resulting in responsive and adaptive design. The system combines miniaturization and personalization, in a unique design language.

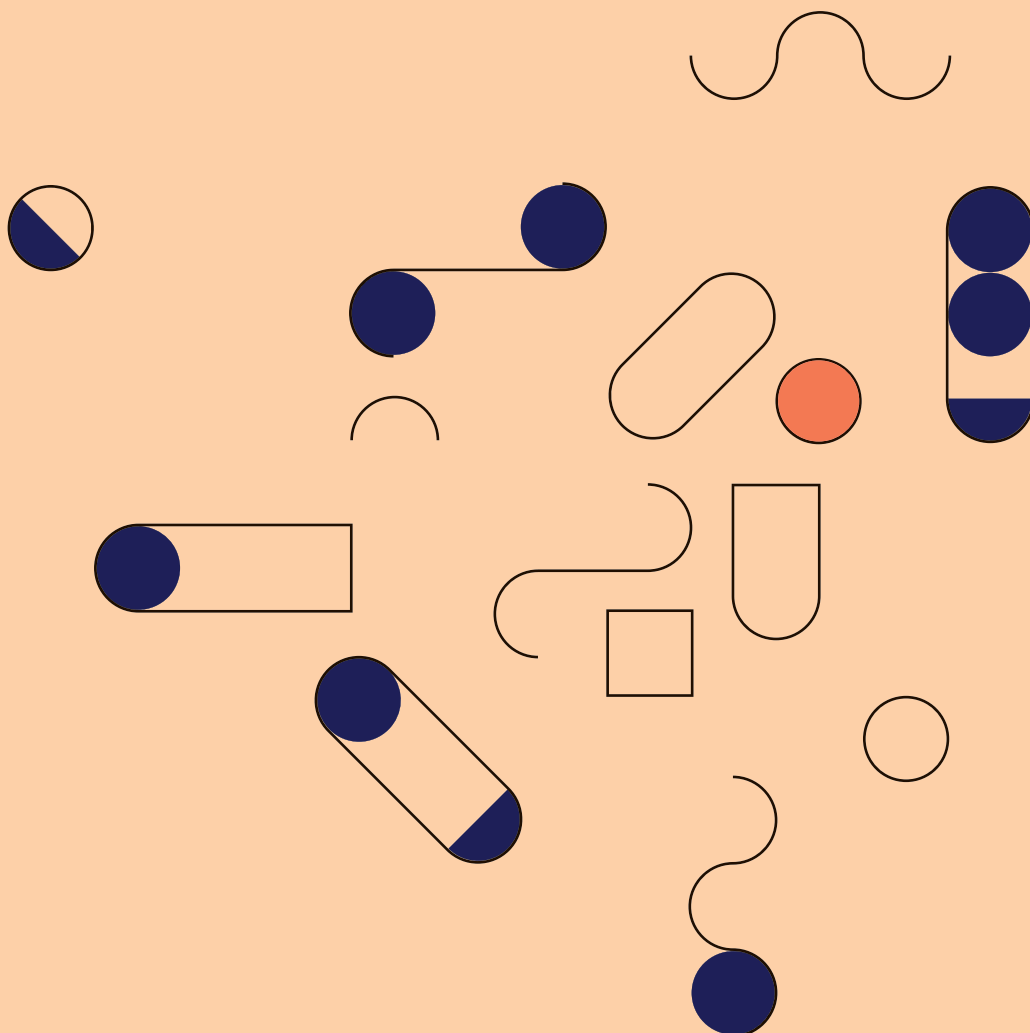



SENSORIAL RESPONSIVE

UNStudio and Delta Light aim to create sensor-based environments that respond, learn and adjust to people's daily activities, taking smart buildings towards responsive architecture through a system that allows people intuitive control and personalisation of space. Soliscape offers different sensing options enabling you to create human-centric spaces. Light in function of wellbeing.



IV

HUMANIZING
SPACES

Humanizing spaces involves investigating their behavioural science. We influence the productivity and the wellbeing of users, by allowing a more intuitive control of the space in a scenario based development. The system is about optimizing visual performance with visual comfort and the quality of the environment, responding to multiple contextual variables and activity based actions, upgrading the overall sense of space.





COMPREHENSIVE

A combination of individual functions in one all-encompassing system, offers a more affordable and efficient tool to work with. Alongside the affordability of the single components, in the service economy, further affordability is created with the scalability of the system, where products tango with services.





SUSTAINABLE

With its basic framing, the system allows for a variety of complementary circular materials to expand its aesthetics, and for its language to morph, whilst retaining a clear and strong aesthetic. Different materials can be used within the system to facilitate for specific functionalities, from acoustic to decorative and illuminous atmospheric scenes.











Don't be a pawn in someone else's game



LASS-OH!

Lass-Oh! glides through the room as a snake sliding through the greensward, showing off its slim cylindrical contour in combination with the miniature LED clusters hidden inside its body. The variety in shape - straight lines or curved squares and rectangles - in combination with the optional shades make of Lass-Oh! a very decorative lighting solution. Nevertheless, Lass-Oh! can easily be hung in every residential, retail or office project thanks to its low-glare LED dots that are hidden away into the profile.

www.deltalight.com/lass-oh



INTERIOR CEILING

FAMILY OVERVIEW

CHOOSE YOUR COLOUR



Black / Gold Coloured

CHOOSE YOUR SHAPE

Rectangular / Linear

CHOOSE YOUR POWER

Rectangular

4 x 6W – 610lm up to 6 x 6W – 610lm

Linear

2 x 6W – 610lm up to 6 x 6W – 610lm

CHOOSE YOUR LED COLOUR

2700K / 3000K

OPTICS

34°

CHOOSE YOUR CONTROL

Non Dim / 1-10V Dim / DALI Dim

CHOOSE YOUR ACCESSORY

Add Jiha! flaps for an extra decorative touch

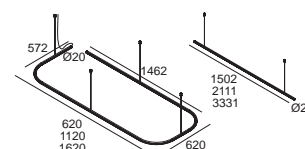









CASTEELKEN

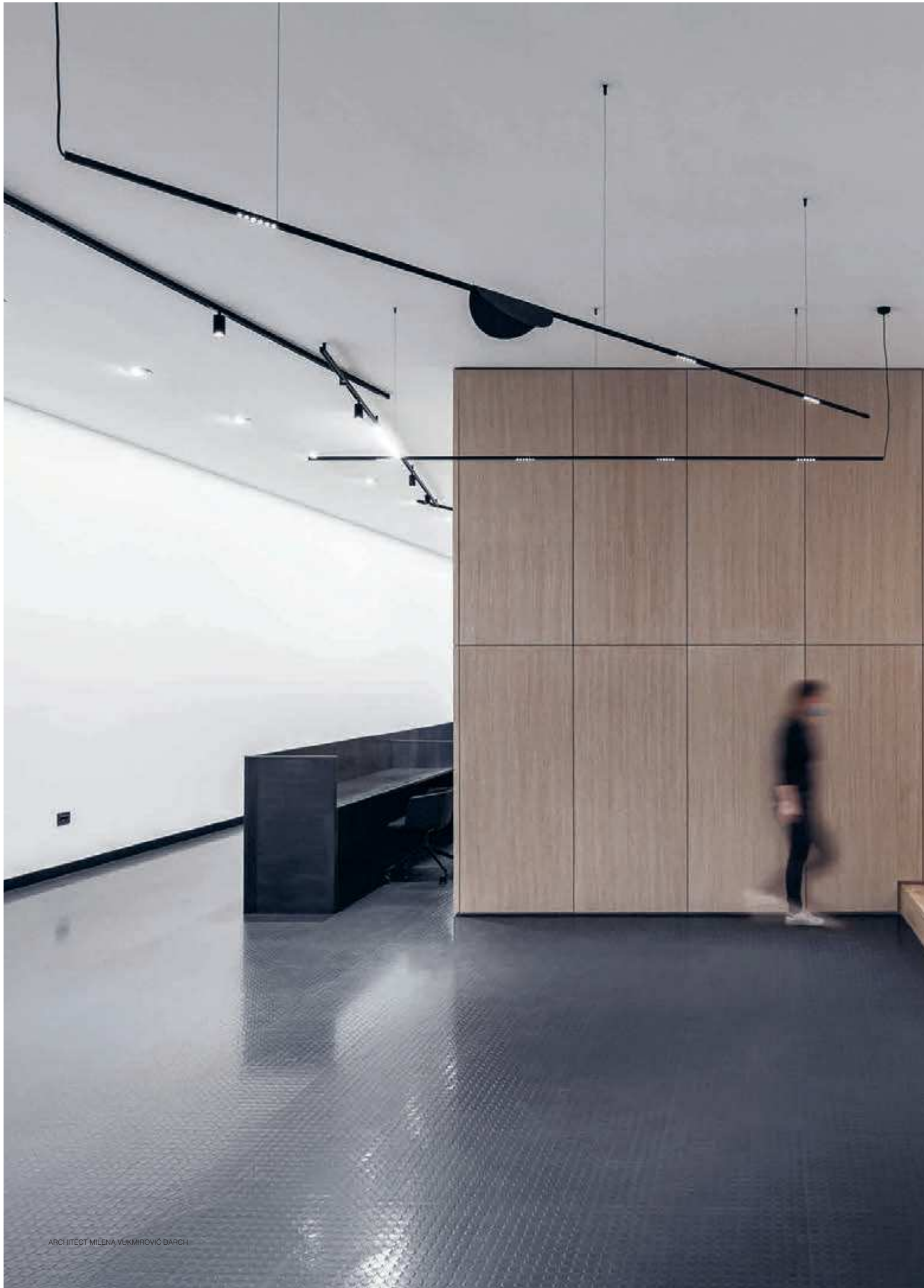

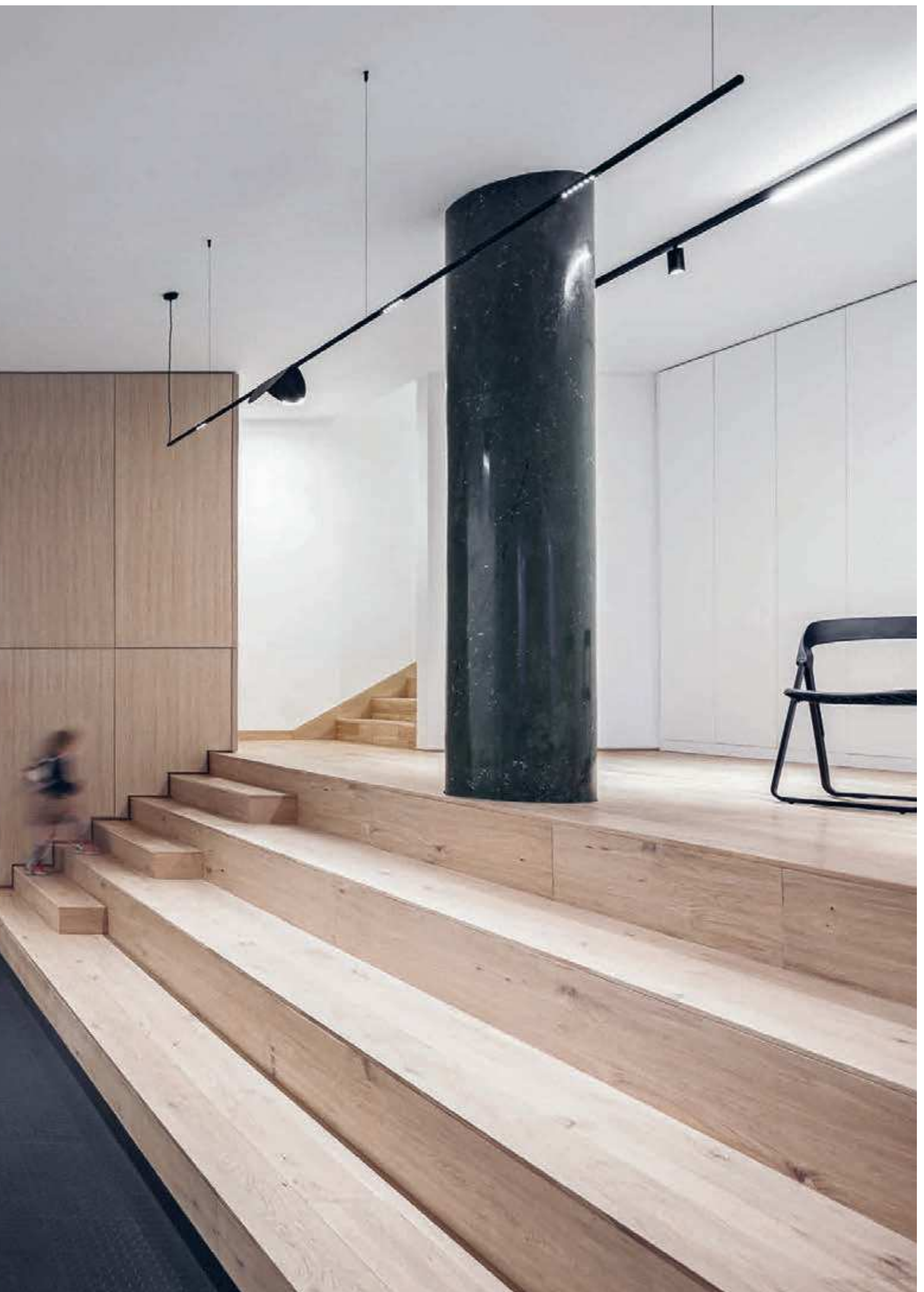



INFORM FAMILY

A WORKING TOOL

The Inform family is an extensive range of linear and curved lighting solutions, designed to be used in applications that include task areas, like landscape offices, meeting rooms, reception desks, home office, ... Areas which need technical architectural lighting at its best: eye for design, eye for the user and eye for performance.

The base of this family is a combination of Delta Light's Melanopic Light Technology (MLT) with high efficient louvre optics.

ULTIMATE VISUAL COMFORT

Different from the fluorescent tubes, a LED array is build up out of multiple LEDs. Therefore, the reflector is designed to perfectly embrace every individual LED module in a way to boost the efficiency of the complete luminaire while maintaining a high level of visual comfort as every LED dot is shielded from being looked into.

INFORM SQ

PURE MINIMALISM

Inform SQ breaths refinement in all its aspects. Its slender dimensions of 28 by 28mm weld in seamlessly in any architecture.

By letting the power run over the suspension cables, there is no need for additional supply cables, emphasizing the minimalistic looks of the profile.

The subtle details empower its sublime design: the recessed endcaps with integrated logo, the multiple colour combinations, the design of the powerbox in line with the profile design, all of them adding to the pure minimalism where Inform SQ stands for.

HIGH PERFORMER

Despite its minimalistic design, Inform SQ does not compromise on performance.

With a delivered lumen package downwards of up to 3045lm per meter, Inform SQ is perfect for illuminating task areas like office desks or reception counters.

Within the same dimensions one can also opt for a down-up version of Inform SQ, enhancing the sense of space and creating a uniform glow on both vertical as horizontal surfaces, which leads to a reduced contrast and relaxes the eye.

HUMAN IN THE CENTER

The human aspect is the central topic for Inform SQ. It offers state of the art LEDs that help control the human circadian rhythm via a unique spectrum meant to stimulate activity. The high quality LEDs provide a very natural white colour with a higher amount of energy in the cyan region, helping you to be active during the day and encourage sleep at night.

www.deltalight.com/inform-sq



INFORM SQ

CHOOSE YOUR COLOUR



Black-Black, Black - Matt Gold, White-Black or White-White

CHOOSE YOUR INSTALLATION

Surface mounted (down)
Suspended (down or down-up)

CHOOSE YOUR LENGTH

Length 1400 / 1500 / 2000 / 2300 / 2800mm

Down

10W up to 51W - 1700lm up to 8800lm

Up

14W up to 27W - 2400 up to 4900lm

Melanopic Light Technology

UGR <19

CHOOSE YOUR LED COLOUR

3000K / 4000K

CHOOSE YOUR CONTROL

Non Dim / DALI Dim

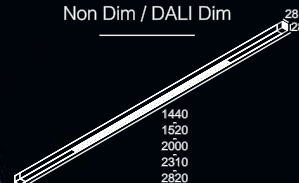

INFORM R

PATENTED

CREATIVE FREEDOM

Who says light for the workplace needs to be boring? Inform R enables you to bring a touch of creativity into the clean and straight lines of the contemporary office environment.

Inform R is a family of atypical shapes which are still compliant with the EN 12464, the standard for office lighting.

Different geometric shapes - based on 1 curved segment - to feed your expressiveness and imagination: combine different forms, use quirky colour combinations, diversify different application areas by alternating Inform SQ with Inform R, feel free to play!

www.deltalight.com/inform-r





INFORM R

CHOOSE YOUR COLOUR

-
- Black-Black, Black - Matt Gold,
- Flemish Gold - Black
- White-Black or White-White

CHOOSE YOUR INSTALLATION

- Surface mounted (down)
- Suspended (down or down-up)

DIFFERENT ORGANIC SHAPES

- Down
- 24W up to 36W - 3500lm up to 5400lm
- Up
- 12W up to 18W - 1800lm up to 2700lm
- UGR <19

CHOOSE YOUR LED COLOUR

- 2700K / 3000K

CHOOSE YOUR CONTROL

- Non Dim / 1-10V Dim / DALI Dim

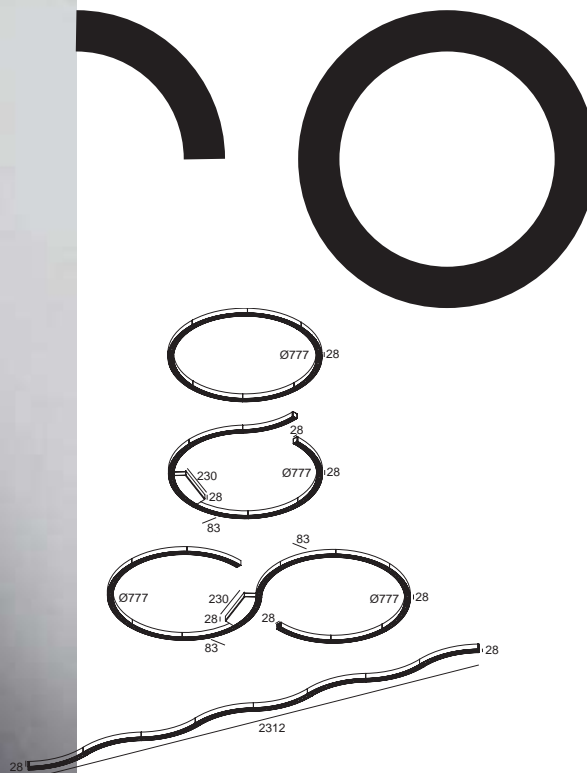





CONFORM

Its elegant design with multiple colour combinations, its specific sun-mimicking spectrum, its low UGR, its well balanced down-up ratio...we do not exaggerate: Conform is the goddess of office lighting!

Conform is designed around the light. It not only perfectly embraces the light source, it reinforces it in multiple aspects. Conform uses Delta Light's Natural Light Technology (NLT), state of the art LEDs with a spectrum that very closely matches that of the sun. That includes a broader spectrum, which is preferable for the human eye and brings out the vibrant colours, and an enhanced cyan energy, boosting the human activity.

Design by **DEAN SKIRA** & Delta Light

www.deltalight.com/conform



As so, the LEDs used in Conform help control the human circadian rhythm. To further stimulate the human well-being, Conform uses a down-up ratio of 55% to 45%, as a combination of direct and indirect light is recommended against eye strain. Every downwards facing LED is perfectly embraced by specially designed reflectors, resulting in a beam angle of 67° that enlightens the task area but has no direct impact on the eye.

Additionally, the uplight is being spread over the room to enhance the spacial effect and to create a uniform lighting scheme, thanks to the inhouse designed lens extrusion to create a wide batwing beam angle without an intense peak in the centre.

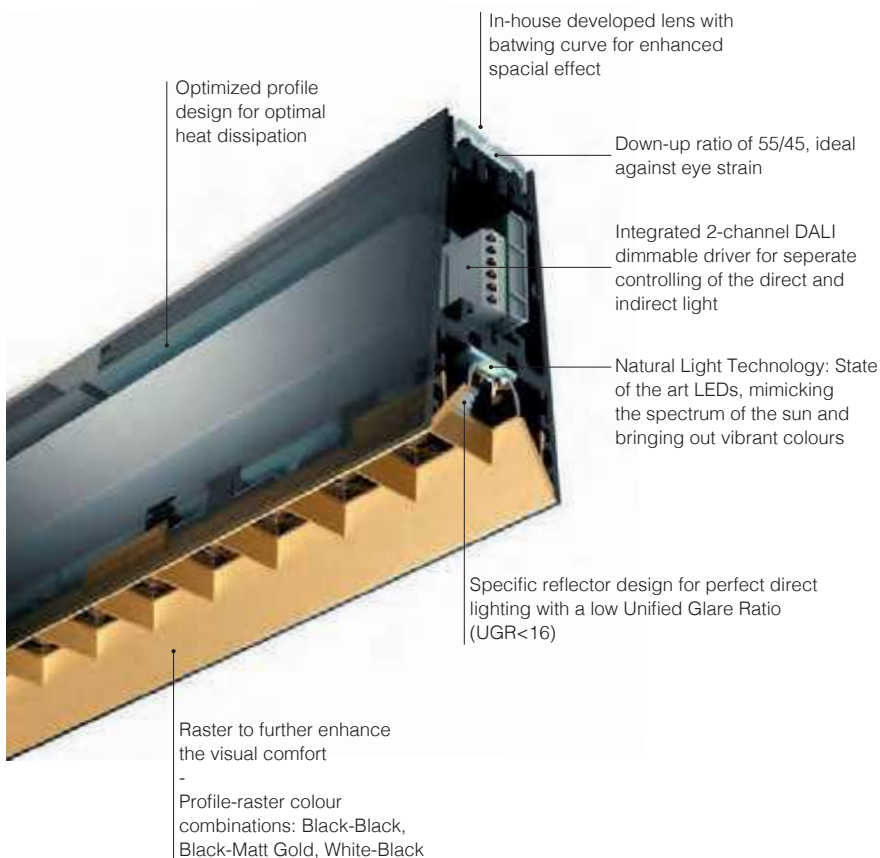

FAMILY OVERVIEW

CHOOSE YOUR COLOUR



Black-Black,
Black-Matt Gold or White-Black

CHOOSE YOUR LENGTH & POWER

1400mm

Down 22W - 2400lm

Up 17W - 1500lm

2000mm

Down 31W - 3300lm

Up 24W - 2100lm

2800mm

Down 44W - 4700lm

Up 34W - 3000lm

Natural Light Technology

UGR <16

CHOOSE YOUR LED COLOUR

3000K / 4000K

CHOOSE YOUR CONTROL

DALI / DALI with integrated sensor

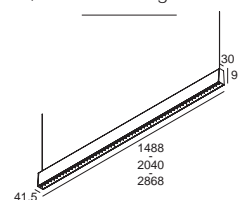









ONE AND ONLY

A peculiar profile, both functional as decorative. The design of the body allows you to have up to 5 lines of light out of 1 profile, 3 for direct and 2 for indirect lighting. The soft glow of the light along the sides of the profile makes the One-And-Only float through the air, a powerful blend of light for an eye-catching look.

www.deltalight.com/one-and-only



FAMILY OVERVIEW

CHOOSE YOUR COLOUR



Black / Gold Coloured / White

CHOOSE YOUR LENGTH & POWER

1200mm

3700lm / 35W down - 2400lm / 23W up

1900mm

5900lm / 56W down - 4000lm / 37W up

CHOOSE YOUR CONTROL

Non Dim / 1-10V Dim / DALI Dim

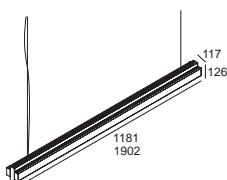

Find the other members of this family **PROFILES**





I-COR (INTERIOR CONCEPT STORE ROESELARE) WWW.I-COR.BE

STREAMLINER

Streamliner is a very versatile profile family with a focus on LED. As a made-to-measure profile Streamliner can be finished with an opal or a prismatic cover and the LED array has two lumen outputs per meter to choose from.

A more easy choice is to opt for the ready-made Streamliner profile which comes in 2 fixed lengths, a perfect solution to install above desks, tables or as general lighting in big hallways or entrance rooms. This ready-made line of light can be surface mounted or suspended and comes in 2 colour finishes.

www.deltalight.com/streamliner



FAMILY OVERVIEW

CHOOSE YOUR COLOUR



Anodized Aluminium / White

CHOOSE YOUR LENGTH & POWER

1100mm
24W – 4060lm
—
2200mm
48W – 8120lm

CHOOSE YOUR INSTALLATION

Surface mounted / Suspended

CHOOSE YOUR CONTROL

Non Dim / 1-10V Dim

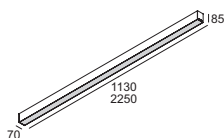



INTERIOR CEILING

Find the other members of this family **PROFILES**









FAMILY OVERVIEW

CHOOSE YOUR COLOUR



Black / White

Finish off with a

Clear, Amber or Opal White bowl glass

POWER

7,1W - 810lm

CHOOSE YOUR LED COLOUR

2700K / 3000K

CONTROL

Mains Dim



GIBBO

FAMILY

Gibbo is a decorative pendant with a base positioned under a predefined angle, as such the globe appears to be rolling away. The glass is handblown and is available in transparent, opal or amber shades. The golden brown colour gives the Gibbo a warm presence, which makes it attractive in compositions above tables and in interiors with warm accents and materials. The base of Gibbo is available in black or white.

www.deltalight.com/gibbo





ARCHITECT TOM LIERMAN / GOLFLUB DE KLUZEN



ARCHITECT LIEVEN MUSSCHOOT



The work of **NATHALIE DEWEZ** extends from small objects to monumental installations, from unique pieces to industrial products. Her presence at numerous international shows and exhibitions has led to collaborations with a number of architecture practices as well as international producers such as Hermès (FR), Habitat (UK), Ligne Roset (FR), De Castelli (IT) & Vervloet (BE).

Nathalie is a designer whose main medium is light and whose materials vary between metal, glass and other long-lasting medium, whether designing light fixtures, objects, furnishings or large-scale sculptures. Her designs reveal the passion for sculptural shapes and superior craftsmanship. Some of her iconic pieces have been awarded several times. In 2011 she received the 'Design Pierre Bergé Foundation' award and the same year she was nominated Belgian Designer of the Year.

Design by **NATHALIE DEWEZ** & Delta Light

www.deltalight.com/still



FAMILY OVERVIEW

CHOOSE YOUR COLOUR



Raw White
Black Bronze
Barrier Blue

CHOOSE YOUR INSTALLATION

Single or Triple suspension

LIGHT SOURCE

E27

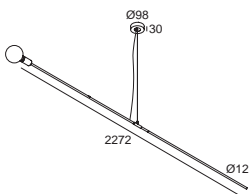

STILL

The Still lamp works as a mobile. This pendant lamp has the particularity of having the light source off-center from its point of suspension, creating an ever-changing elegant dynamic. Due to its big length it dresses and emphasizes a space, without the clutter.



"I always liked to play with counterweights to create movement and tension in my products. With the Still lamp, the rod of metal that creates the balance has the same diameter as the tube welcoming the cable. Screwed together, they create a perfect line and allow easy packing when separated."





MILES

Miles is pure eye-candy.

A collection of 4 purely handcrafted glass shapes, each in 4 different colours (pink, amber, smoke or mist), each recognizable yet unique in all respects.

A family of suspensions that play on the visual contrast between the coloured and white blown glass, combined with different shapes and colours, also ideal for multiple compositions.

All shapes and finishes are inspired by the interplay of opacity, translucency and transparency. Its translucent or milky forms and dynamic light offer a countless number of scenarios.

When switched off its transparency makes MILES almost disappear.

When switched on they provide a cozy and stylish luminous presence, stimulating senses and perceptions.

www.deltalight.com/miles





Miles is a family of figures differing in form, size and colour, spreading a calm, intimate atmosphere. The 4 Miles shapes each come in 2 different versions, either with an invisible LED source, or with E27 enabling you to opt for a classic or more expressive bulb.

The Miles shapes are designed to glow in clusters. Hung at various lengths, they create a majestic and sensual centerpiece wherever they are applied. A luxurious installation of clear and colourful glass shades.

A set of decorative tubes in black and gold finishing is available to further upgrade your presentation. These elegant casings add sophistication and style, at the same time distinguishing the magical sphere of the glass from the technical components on top.

All Miles suspensions start from the same ribbed top, with a smooth transition to its four shapes. Each shape has its own unique character, yet every time starting from the same angle, ensuring a harmonious whole when used in a configuration.

FAMILY OVERVIEW

CHOOSE YOUR COLOUR



Amber / Mist / Pink / Smoke

CHOOSE YOUR SHAPE

From long tubular to flat disc

CHOOSE YOUR LIGHT SOURCE

LED

7,1W – 780lm

E27

CHOOSE YOUR INSTALLATION

Single or Triple suspension

Straight down or out of center

CHOOSE YOUR ACCESSORY

Finish of with a Black or Messing tube

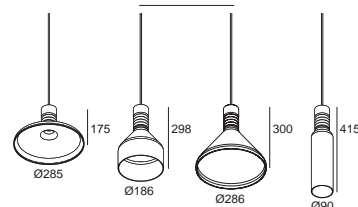







reddot design award
winner

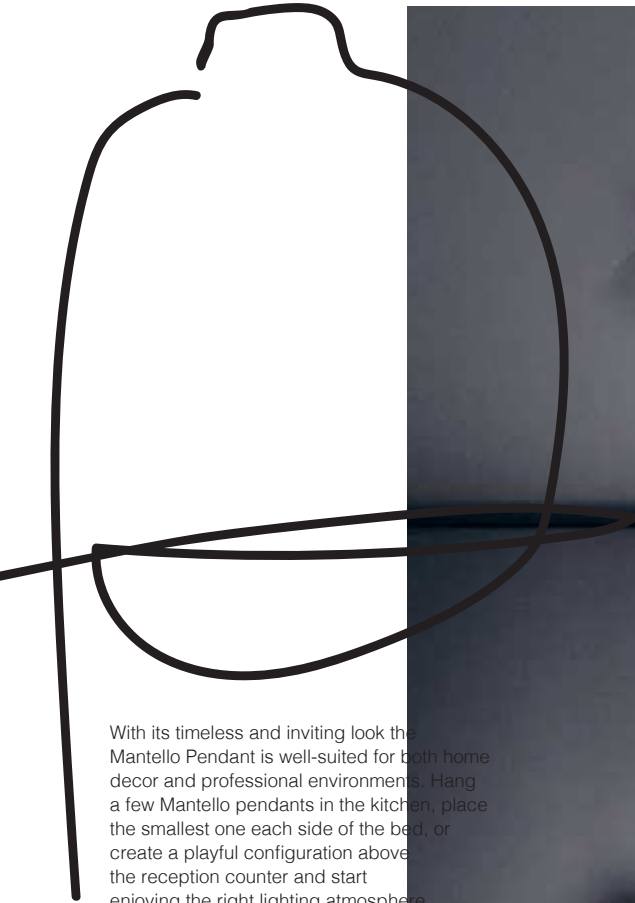

With its timeless and inviting look the Mantello Pendant is well-suited for both home decor and professional environments. Hang a few Mantello pendants in the kitchen, place the smallest one each side of the bed, or create a playful configuration above the reception counter and start enjoying the right lighting atmosphere.

Starting from a circle, the bell-shaped design of the Mantello was inspired by both 80's Memphis shapes and early industrial characteristics. A modern interpretation of recognizable and traditional forms, available in two sizes and two diameters.

www.deltalight.com/mantello



MANTELLO



Just hanging around



MANTELLO

Suspended from the ceiling the lamp brings a modernistic style and classic elegance to any décor. You can opt either for a matt lacquered aluminium shade, or the version in mouthblown, soft rounded glass. The variety in sizes, colours and led or E27 versions, allows you to tailor the Mantello to communicate with the style and needs of the room.

A particularly unique version in the Mantello family is the combination of the aluminium housing with the opaque sphere semi-hidden inside the shade. A very stylish combination ensuring a perfectly diffused and warm light effect.

FAMILY OVERVIEW

CHOOSE YOUR MATERIAL & COLOUR



Aluminium housing in Raw White or Black Bronze



Glass housing in Smoke or Amber

CHOOSE YOUR LIGHT SOURCE

LED

10,4W – 1080lm

E27

CHOOSE YOUR INSTALLATION

Single or Triple Suspension
Straight down or out of center

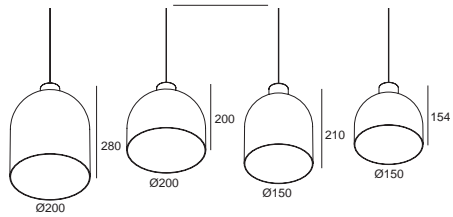

INTERIOR CEILING

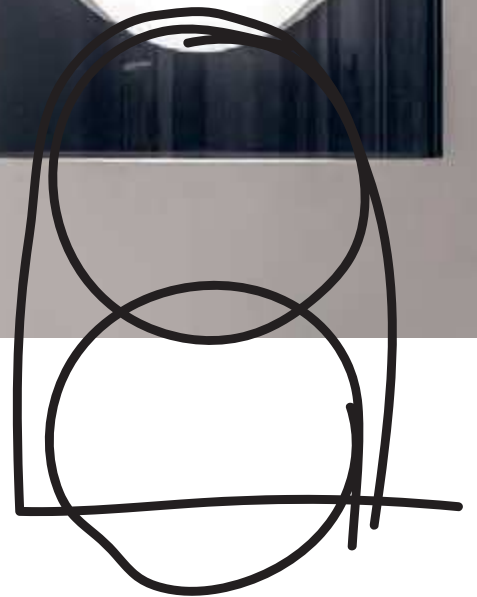









A modern, abstract hanging light fixture is the central focus. It features a glowing white sphere at its core, surrounded by a complex, dark, wireframe structure that resembles a stylized, elongated, teardrop shape. The structure is composed of numerous thin, curved lines that create a sense of depth and movement. The fixture is suspended from the top by a thin wire. The background is a dark, textured wall, and the overall lighting is dramatic, highlighting the intricate details of the light fixture. The word "SOIREE" is overlaid in the center of the image in a clean, white, sans-serif font.

SOIREE

The Soiree range was designed to be voluminous, lightweight and transparent. Its sophisticated form creates a dense and decorative effect, filled with a warm light. The interaction between the pure circular and rectangular forms, with the warm light sources and the symmetric configurations, triggers a dynamic tension. The Soiree takes its inspiration from many angles. From the play of light and shadow in architecture, to natural light effects, the shape of everyday objects and sculptural art. The result is a nest of light, made of circles or rectangles, both structural and decorative, generating a seductive luminous effect. Even when not turned on, they bring texture and character to rooms, defining different areas with small and large contemporary pendants.

The cluster of black circles are in contrast to the classic spherical mood of the inside light source, making the round Soiree a unique object. Either with a bulb or milky-glass light at its centre, the Soiree presents itself like a luminous star wrapped by concentric overlapping orbits. The light adds a warm glow to its sculptural cage, resulting in a unique dégradé effect, peeping through the circles to spread softly into space.

The Soiree is an entire family of versatile suspensions for large or small spaces. Both the round and rectangular versions come in multiple sizes and 2 colours – black or the unique Delta Light Flemish Gold. In both shapes you have the flexibility to choose for a milky-glass sphere at its center, or to opt for an E27 bulb of your preference. The blown glass diffuser in the centre offers subtle nuances thanks to its satin-like finish, in contrast with its more expressive outer cage.

www.deltalight.com/soiree



FAMILY OVERVIEW

CHOOSE YOUR COLOUR



Black / Flemish Gold

LIGHT SOURCE

E27

CHOOSE YOUR LIGHT EFFECT

Open / Opal glass

CHOOSE YOUR SHAPE

Round / Rectangular

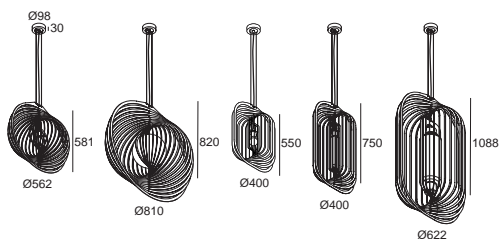

The rectangular Soiree suspensions embody flexibility, clarity and strength, resulting into a powerful object with a vivid personality. When viewed from different sides, the circular or rectangular pattern changes at every angle.

The Soiree lighting object succeeds effortlessly in putting the observer on the wrong foot with its surprising volume. Everywhere this eye-catcher is given space, it opens up a game of stylised forms and warm light. No matter how you look at it, stylish added value is guaranteed.





One Soiree suspension makes a bold statement by itself, when combined to form a cluster of pendants it can create a more monumental installation. In any application, the Soiree is ready for different combinations thanks to its multitude in shapes, colours and sizes. Either as a rhythmical counterpoint against a more minimalistic backdrop, or in a repetitive set-up above a long counter or room of tables... The Soiree enhances rooms with its unique character, making both residential and commercial settings a bit more magical.







ZOOVER

Zoover pretends to be heavy seen its size, nevertheless it looks very lightweight when hung into the room. Designed as a shallow dome, Zoover hides away a circle of light, giving it different looks depending on the point of view. Looking at it from aside, the thermoformed shell has a very neutral appearance. Only when lowering the viewpoint, more and more details catch the eye, as the diffuse light illuminates the inner textures of the scallop. Available in two sizes and two colours for the shade, Zoover adds volume, depth and texture to the room.

www.deltalight.com/zoover





FAMILY OVERVIEW

CHOOSE YOUR MATERIAL & COLOUR



Black

PET-felt Light Grey or Dark Grey Dome

CHOOSE YOUR SIZE

Ø1200 / Ø1400mm

POWER

33,2W - 4820lm

LED COLOUR

3000K

OPTICS

Sandblasted

CHOOSE YOUR CONTROL

Non Dim / DALI Dim

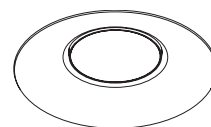

Ø1200 / Ø1400



167





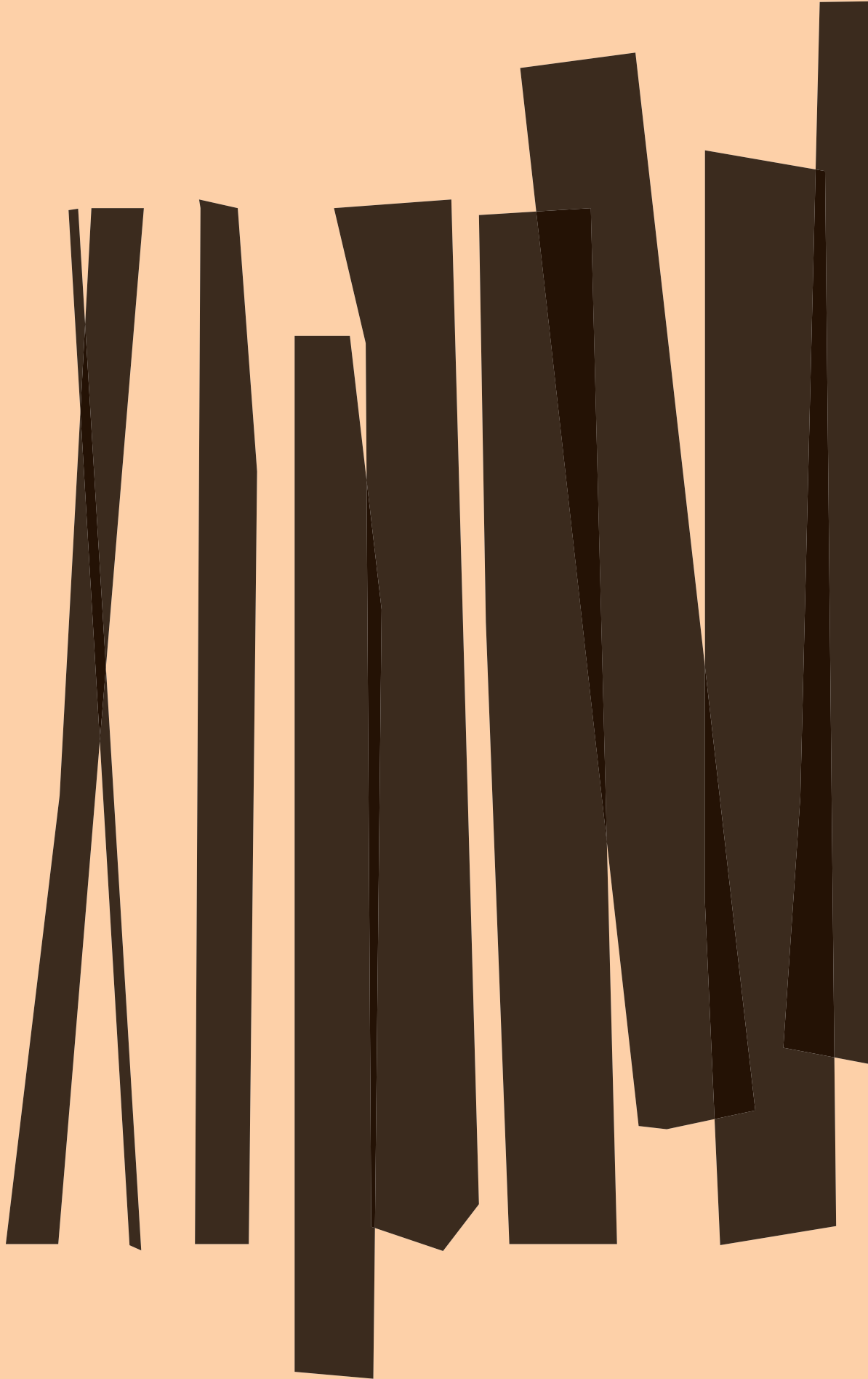



WWW.PAGE337.COM



INTERIOR

WALL



RECESSED

GYN

P 344



2 SIZES

LOGIC W

P 348

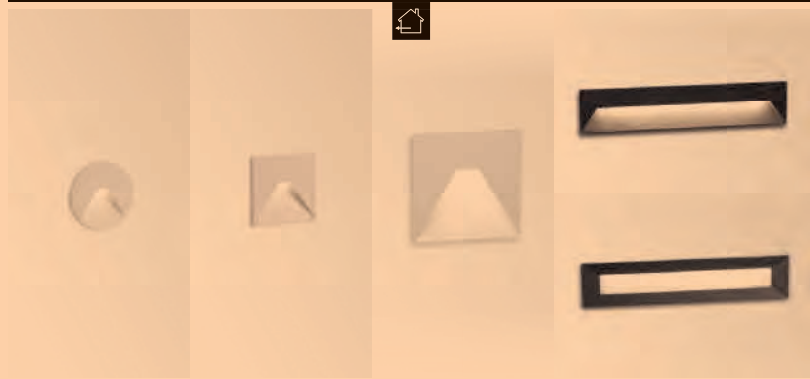

TAGLINE

P 352

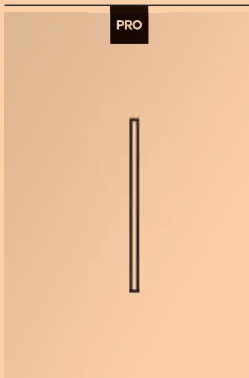

INLET

P 356



LEDS C

P 360



HELI

P 362



SURFACE

MONTUR

P 366

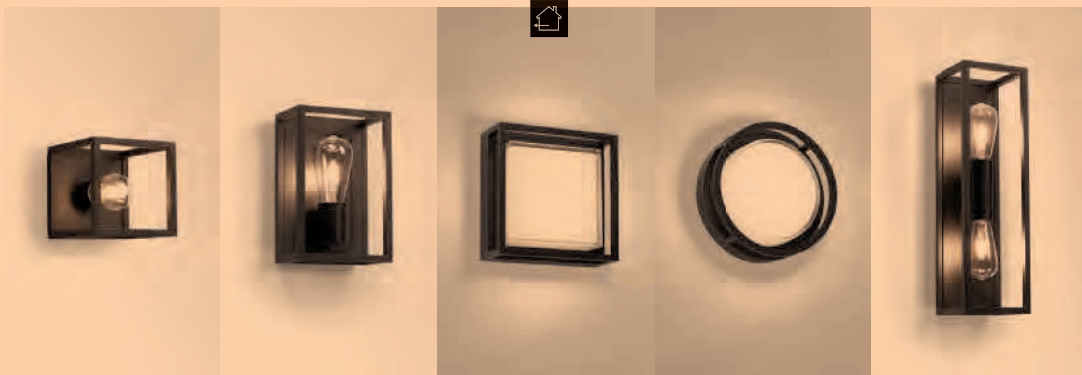

FORTY-5

P 370



BREES

P 374



GALA

P 378

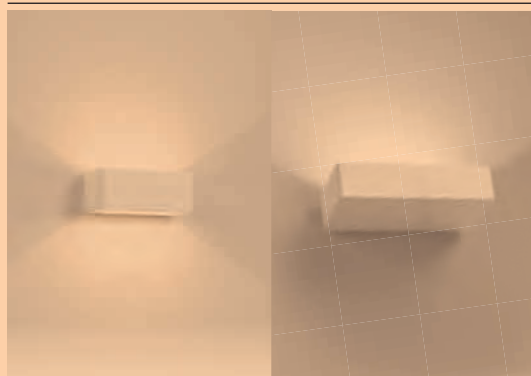

ORBIT

P 384



2 SIZES

HEDRA W

P 390



3 SIZES

WANT-IT

P 394



2 SIZES

WA-T

P 398



TOPIX

P 402



VISION

P 406

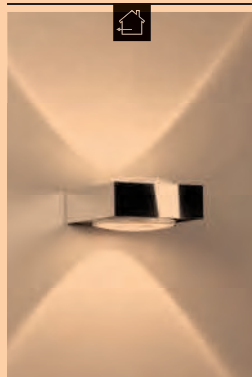

TIGA

P 412

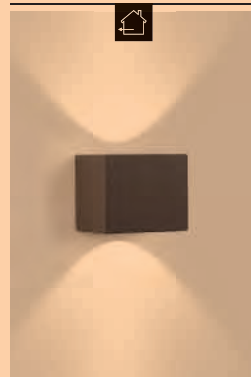

NEW

BACKSPACE II

P 416

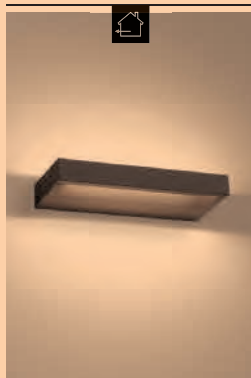

NEW

WALKER II

P 420

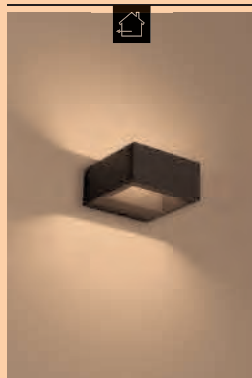

FEMTOLINE W

P 424

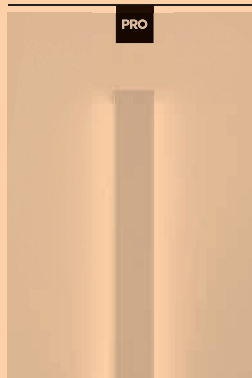

FEMTOLINE TP

P 426



NEW

PAGE337

P 337

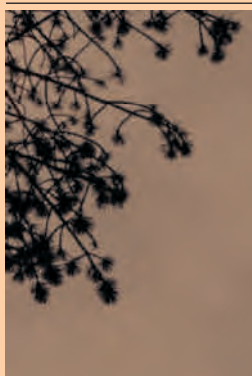

GYN W

Gyn W serves as pure lighting pleasure. An invisible luminaire, as the gypsum body integrates completely into the wall. By finishing off this gypsum luminaire with any desired colour you want, Gyn disappears in its surroundings with an atmospheric indirect light effect as result. All you see ... is light!

www.deltalight.com/gyn



FAMILY OVERVIEW

CHOOSE YOUR COLOUR
Paintable in any desired colour

CHOOSE YOUR SIZE
Small / Medium

CHOOSE YOUR POWER
Small
2,2W - 260lm
Medium
8,6W - 1080lm

CHOOSE YOUR LED COLOUR
2700K / 3000K

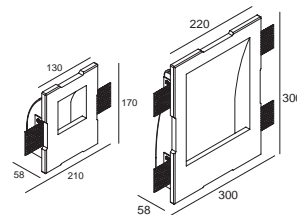







CASTEELKEN

LOGIC W

As a family of guidance lights, Logic W exists out of small and large wall luminaires to be installed slightly above ground level. As such, they provide a soft glow on the floor to guide you along pathways or in corridors, both in- and outdoors.

www.deltalight.com/logic-w

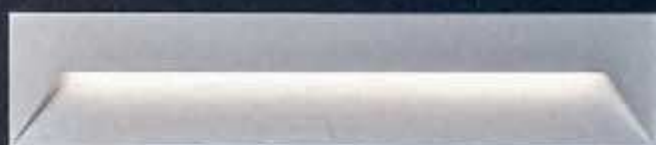

FAMILY OVERVIEW

CHOOSE YOUR COLOUR



Alu Grey / Dark Grey / White

CHOOSE YOUR SHAPE & SIZE



Round / Square / Rectangular

Small / Large

CHOOSE YOUR POWER

Small

0,6W - 40lm

Large

7,1W up to 9W - 800 up to 1480lm

IP54

IP65

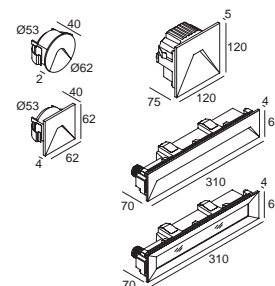

INTERIOR WALL

Find the other members of this family **EXTERIOR WALL**





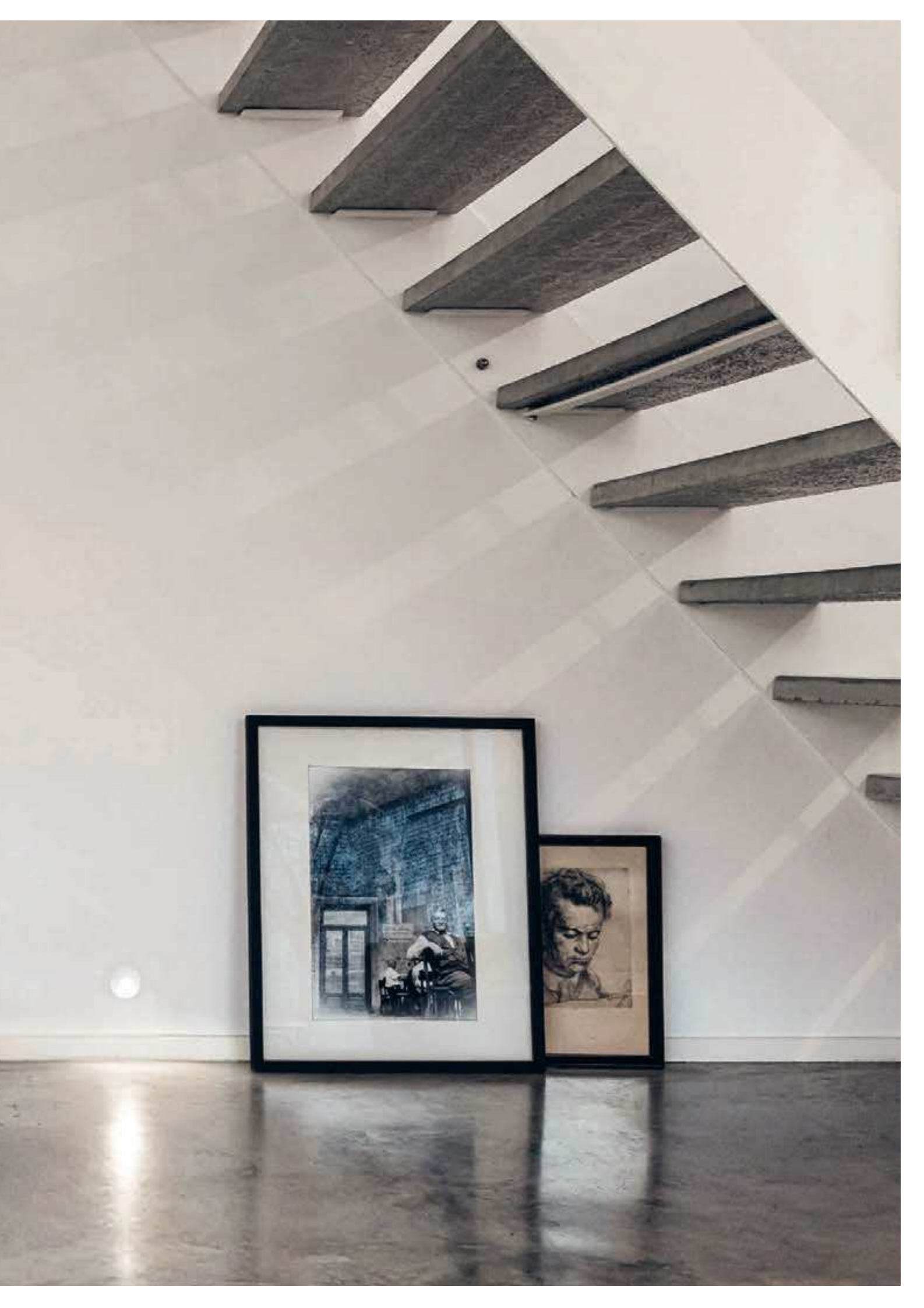

TAGLINE

Tagline provides an ultra-minimalistic line of light that integrates seamlessly with the architectural lines of your project. Limited to only 7mm the Tagline seems almost invisible, a slender slot of light that cuts through space.

The clever design of the Tagline mounting kit allows you to install Tagline either flush into the wall or either slightly protruding, a design twist that catches the eye.

www.deltalight.com/tagline





FAMILY OVERVIEW

CHOOSE YOUR COLOUR



Black

POWER

1,3W – 120lm

CHOOSE YOUR LED COLOUR

2700K / 3000K

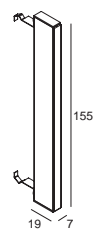





INLET

Our Inlet is a very popular wall recessed fixture for guidance light in hallways and staircases. A narrow beam of light produces a triangular shaped light effect on the floor. Available with trim or mounted flush in the wall, perfect for usage in residential applications.

www.deltalight.com/inlet



FAMILY OVERVIEW

CHOOSE YOUR COLOUR



Alu Grey / White

CHOOSE YOUR POWER

1,1W – 130lm

CHOOSE YOUR LED COLOUR

2700K / 3000K

CHOOSE YOUR INSTALLATION

Protruding or flush with the wall









LEDS C

This family offers some miniature fixtures that serve as orientation and atmosphere lighting. Available in round and square, these little dots of light are perfect as guidance lights. While Leds C II can be used indoors - for example as safety light in corridors and hallways -, Leds C R ST and Leds Go will guide the way outdoors - along paths and driveways.

www.deltalight.com/leds-c



FAMILY OVERVIEW

CHOOSE YOUR COLOUR



White

CHOOSE YOUR SHAPE



POWER

1W - 150lm

CHOOSE YOUR LED COLOUR

2700K / 3000K

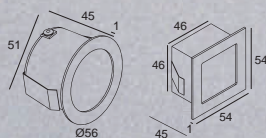



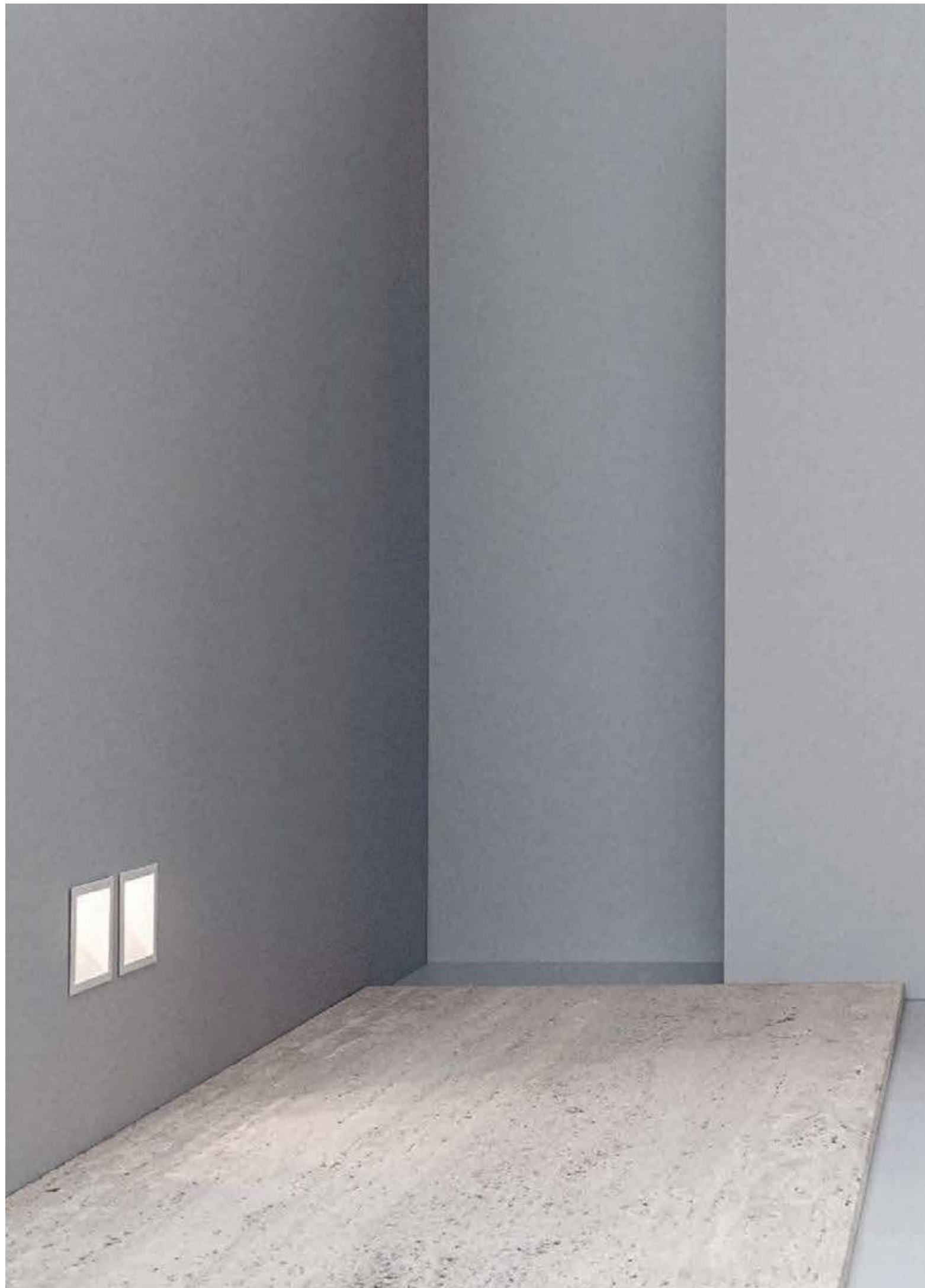

HELI

As a small wall recessed luminaire, Heli is perfect as a guidance light. Be it in a corridor or as a safety light for the steps of your stairs at night, Heli does the trick. Also outside, Heli X will guide you the way.

www.deltalight.com/heli



FAMILY OVERVIEW

CHOOSE YOUR COLOUR



Alu Grey / Dark Grey / White

POWER

1,1W - 130lm

CHOOSE YOUR LED COLOUR

3000K / 4000K

CHOOSE YOUR VERSION

With or without plexi

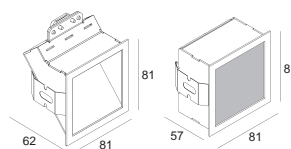







MONTUR

With Montur we offer a highly original interpretation of an archetypical concept: a light source that is contained within the framing of a 3D square or rectangular shape. The Montur is available in indoor and outdoor versions, as a ground, wall or ceiling fixture, with LED clusters or filament-LED lamps with a rustic look. The series integrates beautifully in both country-classic and contemporary homes, and is suitable for hotels and public buildings as well.

The Montur not only breathes new life into a classic concept, it also adds a detailed element of refinement. The sharply profiled framing in aluminium is utterly devoid of welding seams. For both the indoor and outdoor versions, there is a choice of finishing with either hand pressed transparent or opal glass. The opal glass version contains a milky, cone shaped core, with a transparent glass surface, creating a pleasantly diffused light that gives the lamp extra cachet. The indoor version of the Montur is also available as an open cube, with one or two bulbs, or in a rectangular shape with a powerful LED cluster concealed behind a protective cover in polycarbonate. By using them as outdoor fixtures, you can extend your lighting style into the garden or parking area. The outdoor versions are available in the same models as the indoor ones, but always feature a protective cover in glass or polycarbonate. There is also a bollard version, with a choice of various heights.

www.deltalight.com/montur



FAMILY OVERVIEW

CHOOSE YOUR COLOUR



Black / Flemish Bronze / Flemish Gold

CHOOSE YOUR SHAPE & SIZE



Round / Square / Rectangular
Small / Medium / Large

CHOOSE YOUR LIGHT SOURCE

Integrated LED / E27

CHOOSE YOUR POWER

6,3W up to 14W – 960 up to 2300lm

CHOOSE YOUR LED COLOUR

2700K / 3000K

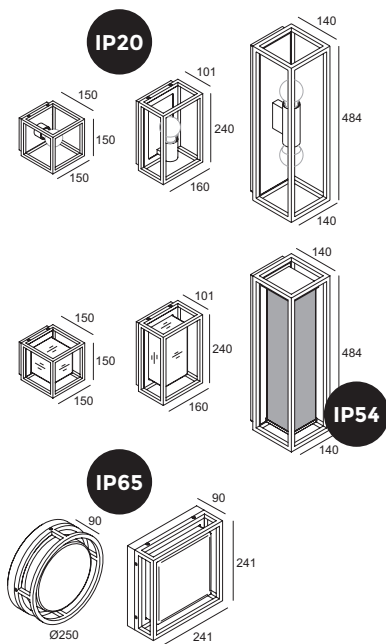

Find the other members of this family **EXTERIOR WALL / FLOOR**



ARCHITECTS: THONE ARCHITECTUUR
INTERIOR DESIGN: TIM VAN STEENBERGEN







FORTY-5

Forty-5 is a wall-mounted architectural eye-catcher. It is hard to describe this light fitting either in words or in images. Call it the three dimensional development of a cube on paper: from reality to abstraction and back. A cube on paper consists of two overlapping squares, with the corners joined by four lines at 45 degrees; hence the name.

Forty-5 puts the observer to the test and gives a playful touch to the wall. Ideal in the home or as a background for receptions and entrance halls. The fitting is available in two versions each forming the mirror image of the other. Add an extra dimension with installations that play with a downlighter and an uplighter.

Available in white finish, both LED light source and driver are integrated and hidden inside the fitting.

www.deltalight.com/forty-5



FAMILY OVERVIEW

CHOOSE YOUR COLOUR



White

POWER

3W – 520lm

CHOOSE YOUR VERSION

Left / Right

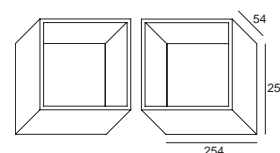







BREESS

Breess is a stylized and decorative indirect wall mounted luminaire, inspired on the poetic movement from sheets of paper, twirling in the wind. The luminaires can be used as an individual, playful lighting accent or mounted in a symmetric or asymmetric set-up. By mounting multiple Breess luminaires in a composition, a dynamic play of light is created on the wall. Breess comes in two versions, either "portrait" or "landscape", referring to the orientation of a printed sheet of paper, both curled up from 1 corner. Either version can be mounted on the wall in 2 directions, by combining different models and multiple ways of mounting an infinite amount of unique set-ups can be created.

The thin curled front panel uses a similar length-to-width ratio as regular A4 paper sheets and has a matt white finishing, referring to a standard sheet of paper and its most common colour.

By adding a hidden wall fixation to the thin sheet, the luminaires seem to float against the wall, enhancing the sense of space around the luminaire, perfectly applicable in residential and hospitality projects, bars and restaurants.

Design by **LUC RAMAEL** & Delta Light

www.deltalight.com/breess





FAMILY OVERVIEW

CHOOSE YOUR COLOUR



White

POWER

7,1W – 810lm

CHOOSE YOUR LED COLOUR

2700K / 3000K

CHOOSE YOUR VERSION

Portrait / Landscape

CONTROL

Mains Dim

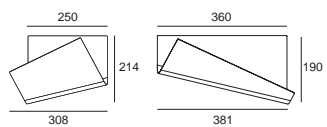





FAMILY OVERVIEW

CHOOSE YOUR COLOUR



White

CHOOSE YOUR LIGHT EFFECT

Down-Up / Up

CHOOSE YOUR POWER

Down-Up
9,4W - 1480lm

Up

7,1W up to 32,6W – 810 up to 3340 lm

CHOOSE YOUR LED COLOUR

2700K / 3000K

CHOOSE YOUR CONTROL

Non Dim / 1-10V Dim / Mains Dim

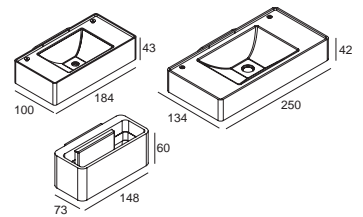

GALA

Gala has been a classic within Delta Light's range of wall mounted fixtures. Recognizable by its rectangular shape with rounded corners, Gala comes as a down-up luminaire or as an uplighter, creating a flood of indirect light for a pleasant and intimate setting.

www.deltalight.com/gala







INTERIOR DESIGN ELEUVE INTERIORISMO / LIGHTING DESIGN BIG ARCHITECTURAL LIGHTING / PHOTOGRAPHY JUANAN BARROS



CASTEELKEN





— AWARD —
DESIGN PLUS
light+building



ORBIT

As a Design Plus Award winner in 2000, the Orbit has been a favorite in the wall mounted range of Delta Light for many years. This wall mounted family comes in two versions, Orbit, and Orbit T. Orbit combines a couple of LEDs with a lens for up- and downlight, which results in a distinctive light pattern on the wall. Finished in either standard lacquered finish or with the typical Punk look. Orbit T is a unique, see-through luminaire. The flexible LED around the hollows inside of the luminaire also results in a pleasant down-up light effect.

www.deltalight.com/orbit





FAMILY OVERVIEW

CHOOSE YOUR COLOUR



Black-Gold Matt / Black Pure /
Black Pure-Gold Matt / Gold Coloured / Gold
Coloured-Black / White

CHOOSE YOUR FINISH

Smooth / Punked spikes

CHOOSE YOUR LIGHT & POWER

LED
3W up to 6,4W – 480 up to 620lm

GU10

CHOOSE YOUR LED COLOUR

2700K / 3000K

CHOOSE YOUR CONTROL

Non Dim / Mains Dim











HEDRA W

Hedra adds refinement, finesse and colour to the range. Next to black and white, Hedra W is available in a Gold Coloured and Black Bronze finish. The faceted design of the Hedra captures and reflects the ambient light with an ever-changing look as result. It is the typical design element of the Hedra family, which also includes a series of pendant and spotlight luminaires.

www.deltalight.com/vizir-hedra



FAMILY OVERVIEW

CHOOSE YOUR COLOUR



Black / Black-Bronze / Gold Coloured / White

CHOOSE YOUR LIGHT EFFECT

Down / Down-Up

CHOOSE YOUR SIZE

220mm / 300mm / 400mm / 600mm

CHOOSE YOUR LIGHTSOURCE

LED

Down 3,9W – 390lm

Down-Up 2 x 3,9W – 390lm

GU10

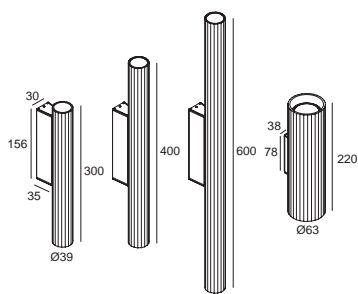





WANT-IT

Want-it is a vivid range of wall luminaires, available for both interior and exterior use. The streamlined and timeless design of the Want-it gives it a very flat and low-impact appearance, with no visible screws. The slightly curved edges provide a subtle twist to the design, while also creating a nicely delineated light pattern on the wall.

The Want-it comes in a square and rectangular shape. While the exterior version comes in a dark grey finish, the interior version is available in all white or a more decorative black and matt gold combination.

www.deltalight.com/want-it



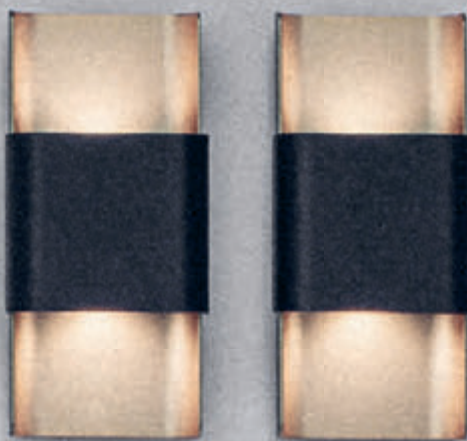

FAMILY OVERVIEW

CHOOSE YOUR COLOUR



Black-Gold Matt / Dark Grey / White

CHOOSE YOUR POWER

2 x 3,2W up to 2 x 4,7W

2 x 310lm up to 2 x 540lm

CHOOSE YOUR LED COLOUR

2700K / 3000K

CHOOSE YOUR CONTROL

Non Dim / Mains Dim

IP20

IP55

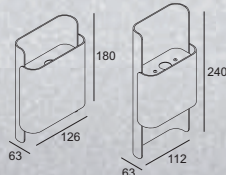





MANA-K

WA-T

The visual perception of our Wa-T luminaire is that a part of the surface of the wall floats away from the wall itself. The indirect light created by Wa-T enforces this visual perception. When choosing black as finishing option, the inner finishing in Matt Gold creates a soft and warm glow onto the wall.

www.deltalight.com/wa-t





FAMILY OVERVIEW

CHOOSE YOUR COLOUR



Black-Gold Matt / White

POWER

7,5W – 700lm

CHOOSE YOUR LED COLOUR

3000K / Soft Dim

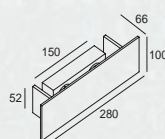







TOPIX

This multi award-winning luminaire ensures a playful effect and offers a lot of freedom.

On its own, Topix wows you with its peculiar yet attractive design, when put together, you can create artistic clusters of light.

Topix comes for in- and outdoors, giving you the opportunity to make your façade stand out.

www.deltalight.com/topix



FAMILY OVERVIEW

CHOOSE YOUR COLOUR



Alu Grey / White

POWER

2 x 1,1W - 130lm

CHOOSE YOUR LED COLOUR

3000K / 4000K

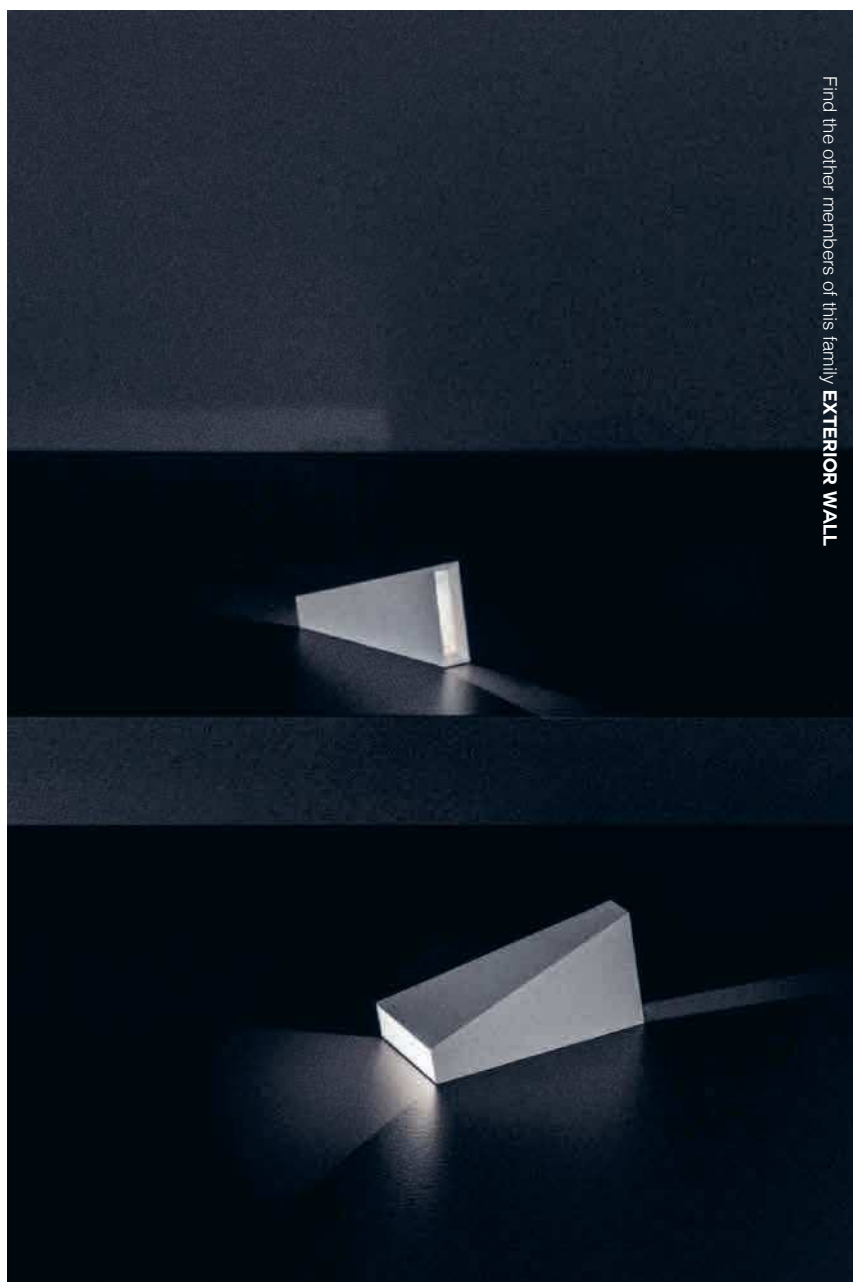
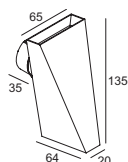

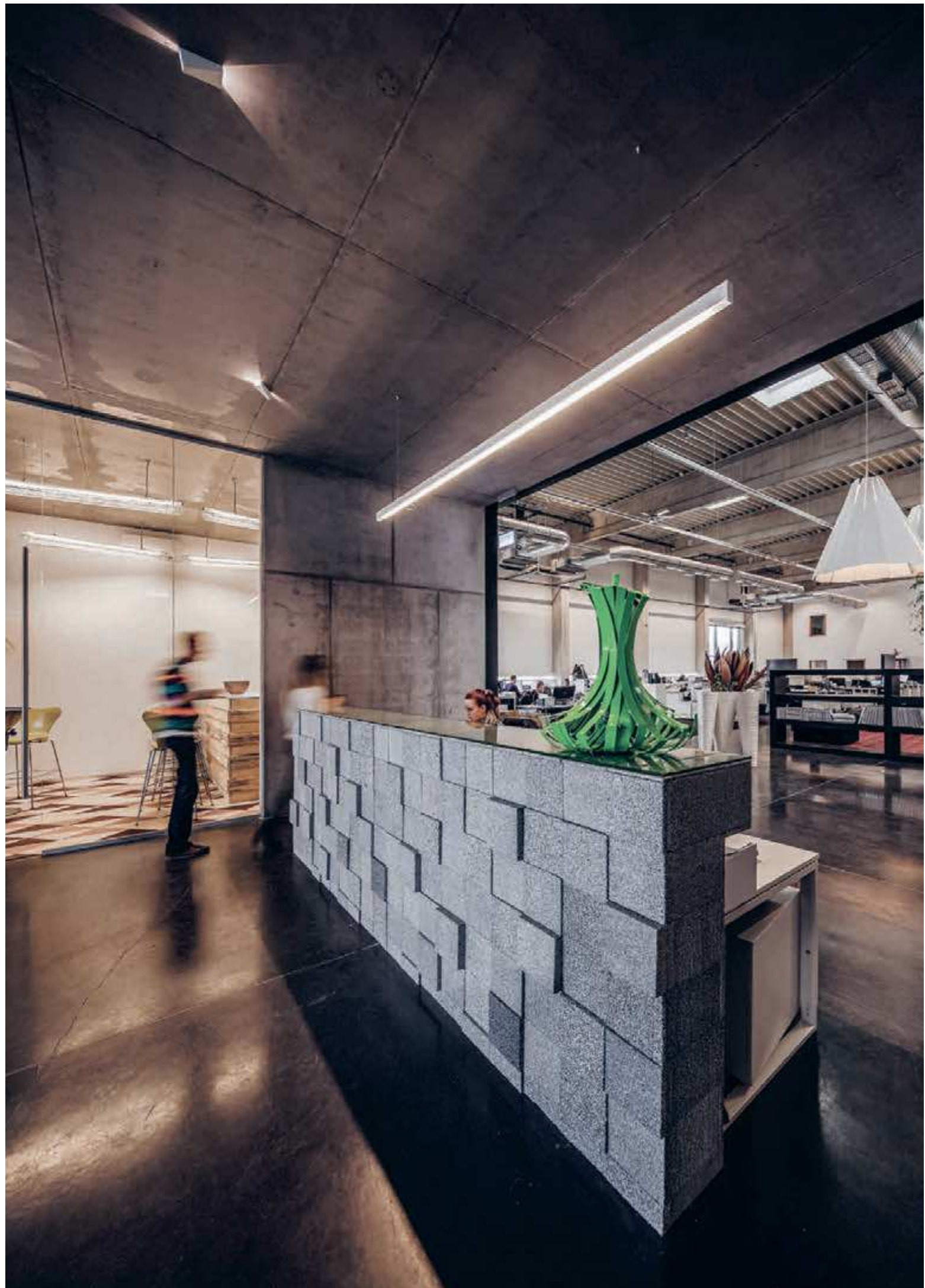





VISION

Since its launch Vision has already won multiple awards, thanks to its impressive and nicely delineated parabolic light pattern on the wall. This classic is available both for indoor and outdoor use. Vision thanks its powerful light effect to the combination of LED technology in combination with a lens, giving its unique design and playful light effect.

www.deltalight.com/vision





INTERIOR WALL

Find the other members of this family **EXTERIOR WALL**

FAMILY OVERVIEW

CHOOSE YOUR COLOUR



White / White-Chrome

POWER

2 x 1,4W - 180lm

CHOOSE YOUR LED COLOUR

2700K / 3000K

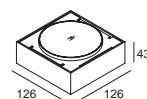



DESIGN STUDIO KES MARCELIS / PHOTOGRAPHY HANS DE ROOIJ







TIGA

A medium sized rectangular lighting fixture, delivering a pleasant up and downward light effect on your wall. As a wall mounted luminaire, Tiga is perfect for both residential use or to apply in hotels and restaurants.

Tiga comes as an indoor and outdoor version, perfect to merge your exterior and interior in a similar design language.

www.deltalight.com/tiga



FAMILY OVERVIEW

CHOOSE YOUR COLOUR



Alu Grey / Black-Gold Matt /
Grey Brown / White

CHOOSE YOUR LIGHT EFFECT

Wide or small beam for both down & up
Wide + Small beam combination

POWER

7,1W - 810lm

CHOOSE YOUR LED COLOUR

2700K / 3000K

CHOOSE YOUR CONTROL

Non Dim / Mains Dim

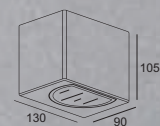



ARCHITECT SALGADA RESTREPO / INTERIOR DESIGN CAMILO SALGADO - HECHIZOO





In many ways, Backspace II is a joy for the eye, be it by its slender design, by its pleasant light effect or by its playful colour combinations. Backspace II is designed to create a 2-way light effect on the wall, the choice to install it in a horizontal or vertical way is up to you.

By mounting the light source in the front part of the luminaire, it is perfectly shielded from looking directly into the source.

Backspace II can be used for interior lighting in a white, grey or dark grey finish or for outdoor settings in grey or dark grey. An additional touch of colour can be added to the luminaires by opting for an extra golden reflector.

BACKSPACE II

www.deltalight.com/backspace-ii



FAMILY OVERVIEW

CHOOSE YOUR COLOUR



Alu Grey / Dark Grey / White



Finish off with a golden reflector

POWER

10,4W - 1260lm

CHOOSE YOUR LED COLOUR

2700K / 3000K

CHOOSE YOUR CONTROL

Non Dim / Mains Dim

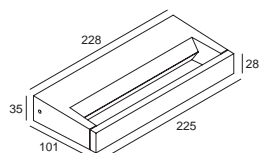



CHAMPAGNE
IN THE
MORNING
JELWYN'S SENATORI ©





WALKER II

SPLIT THE LIGHT

Walker splits the light open. Starting from 1 light source, Walker II is designed to guide the light into two directions to provide a double light effect on the surface below. The light falls on the V-shaped inner part of the luminaire, breaking it open and throwing it to the front- and backside of the luminaire.

Walker II can serve as a guiding light on your wall or pathway, as it comes as a wall luminaire and as a bollard. Different sizes, different heights and multiple colour combinations can be combined to your preference to create the perfect setting.

www.deltalight.com/walker-ii



FAMILY OVERVIEW

CHOOSE YOUR COLOUR



White / White-Gold coloured

CHOOSE YOUR POWER

3,7W - 480lm / 6,2W - 790lm

CHOOSE YOUR LED COLOUR

2700K / 3000K

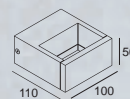



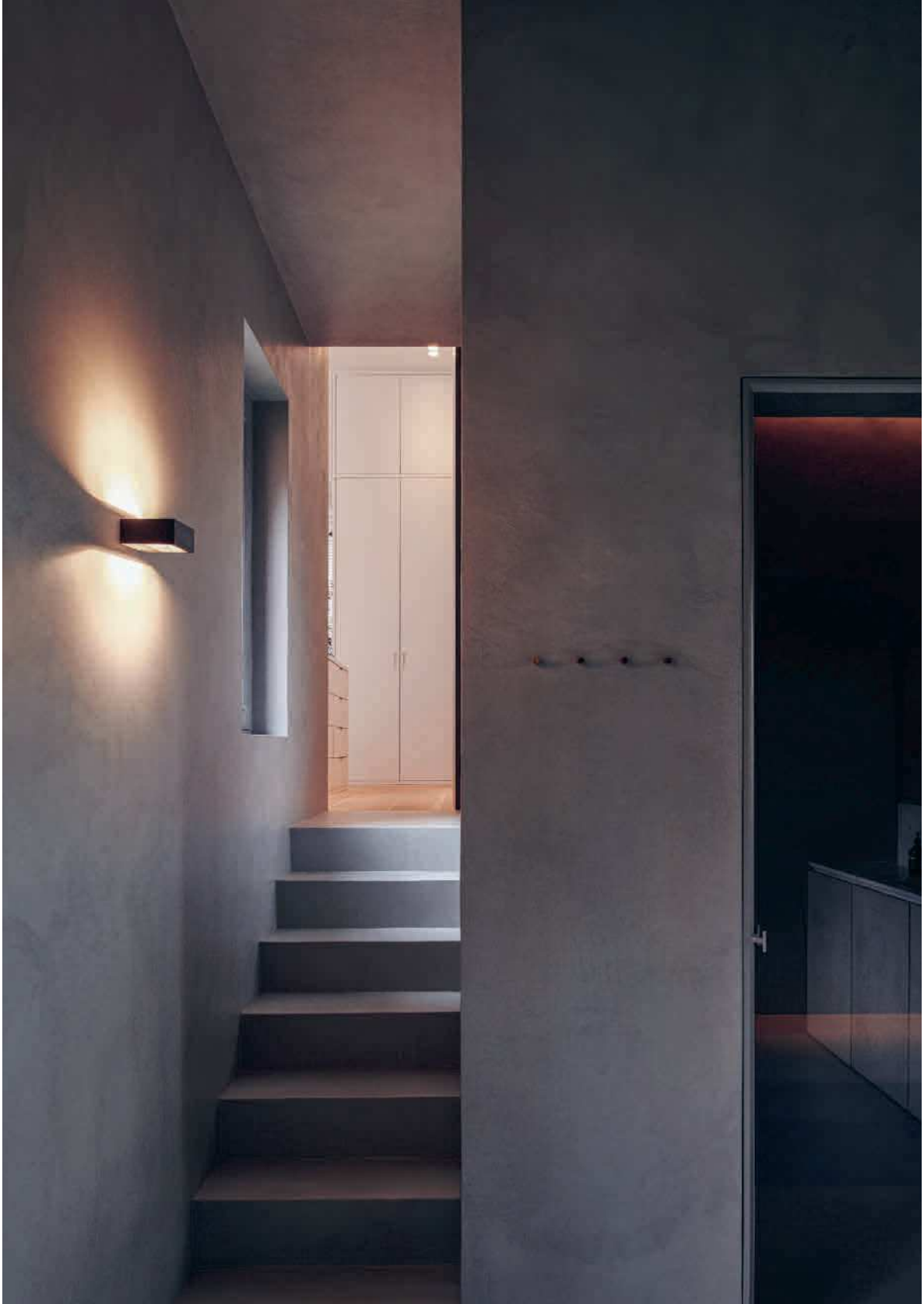

FAMILY OVERVIEW

CHOOSE YOUR COLOUR



Black / White

CHOOSE YOUR SIZE & POWER

600mm / 2 x 9W - 840lm

1200mm / 2 x 18,2W - 1680lm

LED COLOR

3000K

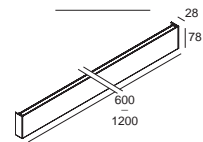

FEMTOLINE WALL

This slim and multi-functional wall mounted profile creates a cosy effect on the wall. It comes as fixed lengths of 600 and 1200mm and is also available as bespoke wall mounted profile for direct-indirect lighting on vertical surfaces.

www.deltalight.com/femtoline





INTERIOR WALL

Find the other members of this family **PROFILES**

FEMTOLINE TP

Femtoline TP is designed as a mirror light for bathrooms. The specific linear optics allow for a diffused spread of light to 2 sides of the profile, perfect to light up both the mirror and the person in front of it. Available in 2 finishes and 2 sizes for easy integration into the design of the bathroom.

www.deltalight.com/femtoline



FAMILY OVERVIEW

CHOOSE YOUR COLOUR



Chromed / White

CHOOSE YOUR SIZE & POWER

560mm / 11,9W - 1160lm

1060mm / 22,6W - 2210lm

LED COLOR

3000K

IP44

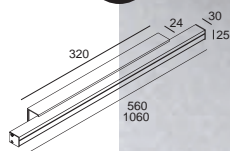











TRACK

TRACK

TRACK

NEW

SPY
P 434



1470 - 4600lm

●●●
3 SIZES

SPY FOCUS
P 434



1080 - 2130lm

●●
2 SIZES

NEW

FRAGMA
P 444



1100 - 4600lm

●●●
3 SIZES

NEW

MULTINOVA
P 450



2150 - 4820lm

●●
2 SIZES

SUPER-OH! XS
P 454



1470 - 2940lm

●●
2 SIZES

SUPERNOVA XS
P 458



1580 - 2600lm

●●
2 SIZES

NEW

PAGE337
P 337

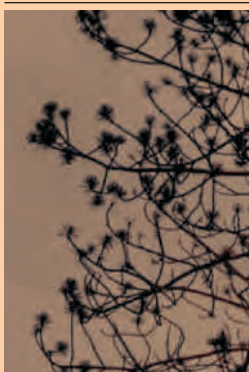

LUMEN OUTPUT mentioned as indicative reach.

SPY FAMILY

Minimalism, functionality and versatility are the key terms to describe this extensive collection. The Spy was designed to meet multiple lighting requirements, an ideal solution for accent lighting in residential, hospitality or commercial spaces. The range features low to high lumen packages, narrow to wide beam options, standard or specific LED colours, recessed to surface mounted and track applications, different colour finishes and combinations, and can be equipped with multiple light refining accessories.

Following the constant changes in the world of LEDs and optics and the evolution to better user comfort with more precise optics and better light control, the complete Spy range has been upgraded. The result? Fresh shapes and additional finishing colours, better light comfort through hybrid optics, improved LED colour consistency and new perspectives with Tunable White and Soft Dim.

The renewed Spy family comes in diameters of 27, 39, 52, 66 and 90 millimeters, a range of spotlights to fit any purpose. While the smaller versions come in the lively colours Flemish Bronze, Flemish Gold and Gold Coloured, the bigger Spy's offer Tunable White and Soft Dim solutions in multiple beam angles.

On track, Spy is available in diameters of 52, 66 or 90 millimeters, ranging from 1500 up to 4600lm for several lighting purposes. For specific project demands, Spy offers Soft Dim and Tunable White solutions in different beam angles, ideal to create a particular mood or cosy atmospheres.

With Spy Focus one can opt for different beam angles out of only 1 luminaire, as the circle of light can be widened or narrowed by rotating the front of the fittings' body. As such, every beam angle between 8° and 43° is possible.

For Spy 90 on track, the possibility of an adjustable beam angle within 1 luminaire is taken to a higher level. The technology inside LensVector's dynamic beam shaping lenses allow for a wireless adjustment of the beam angle. One can easily adjust the beam angle and the light intensity of these luminaires using CTRL Delta, as dimming of the luminaire and controlling of the beam angle can be done with all smart devices.

www.deltalight.com/spy-track



FAMILY OVERVIEW

CHOOSE YOUR COLOUR



Black / White



Front tube in

Black / Flemish Bronze / Flemish Gold / Gold Coloured / White

CHOOSE YOUR INSTALLATION

Adapter on Track

Adapter in Track

CHOOSE YOUR SIZE & POWER

Spy 52

12,4W – 1460lm

Spy 66

9W up to 24,6W – 1076 up to 2910lm

Spy 90

23,2W up to 36W – 3170 up to 4600lm

Spy Focus

9W up to 17,1W – 1080 up to 2130lm

CHOOSE YOUR LED COLOUR

2700K / 3000K / Soft Dim / Tunable White

CHOOSE YOUR OPTICS

Spy 52

20° / 45°

Spy 66

12° / 18° / 26° / 30° / 33° / 39° / 45°

Spy 90

18° / 30° / 45°

Spy Focus

8 to 43° / 15 to 50°

CHOOSE YOUR CONTROL

Non Dim / DALI Dim

CHOOSE YOUR FAVORITE TRACK

Recessed

Surface mounted

Suspended

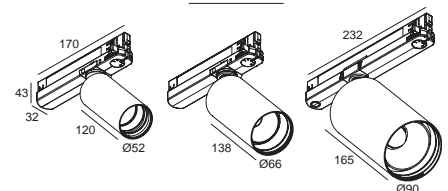

TRACK



Find the other members of this family **INTERIOR CEILING / PROFILES**

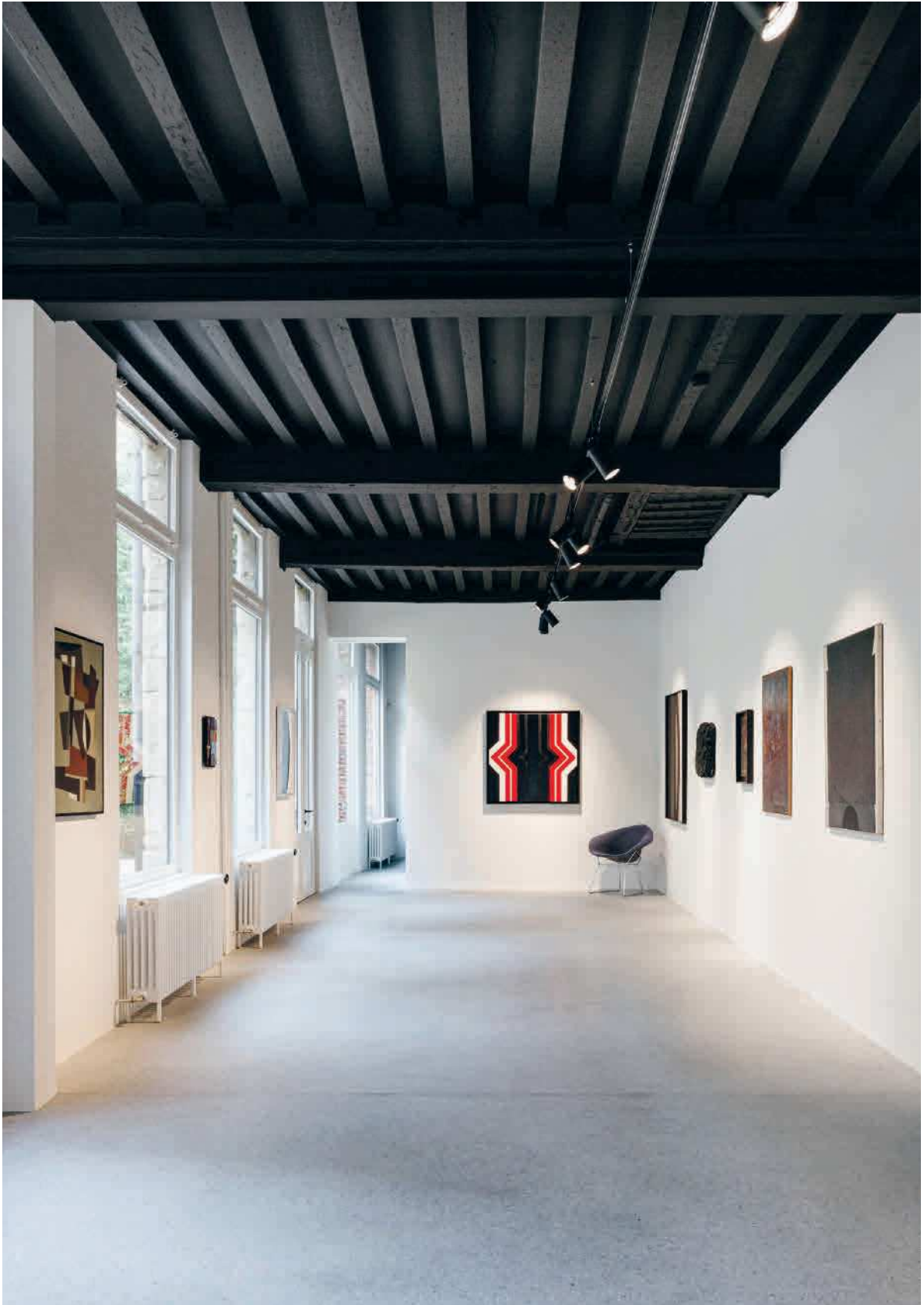

CALLEWAERT VANLANGENDONCK GALLERY / PHOTOGRAPHY DOROTHEE DUBOIS









HUBERTY BREYNE GALLERY

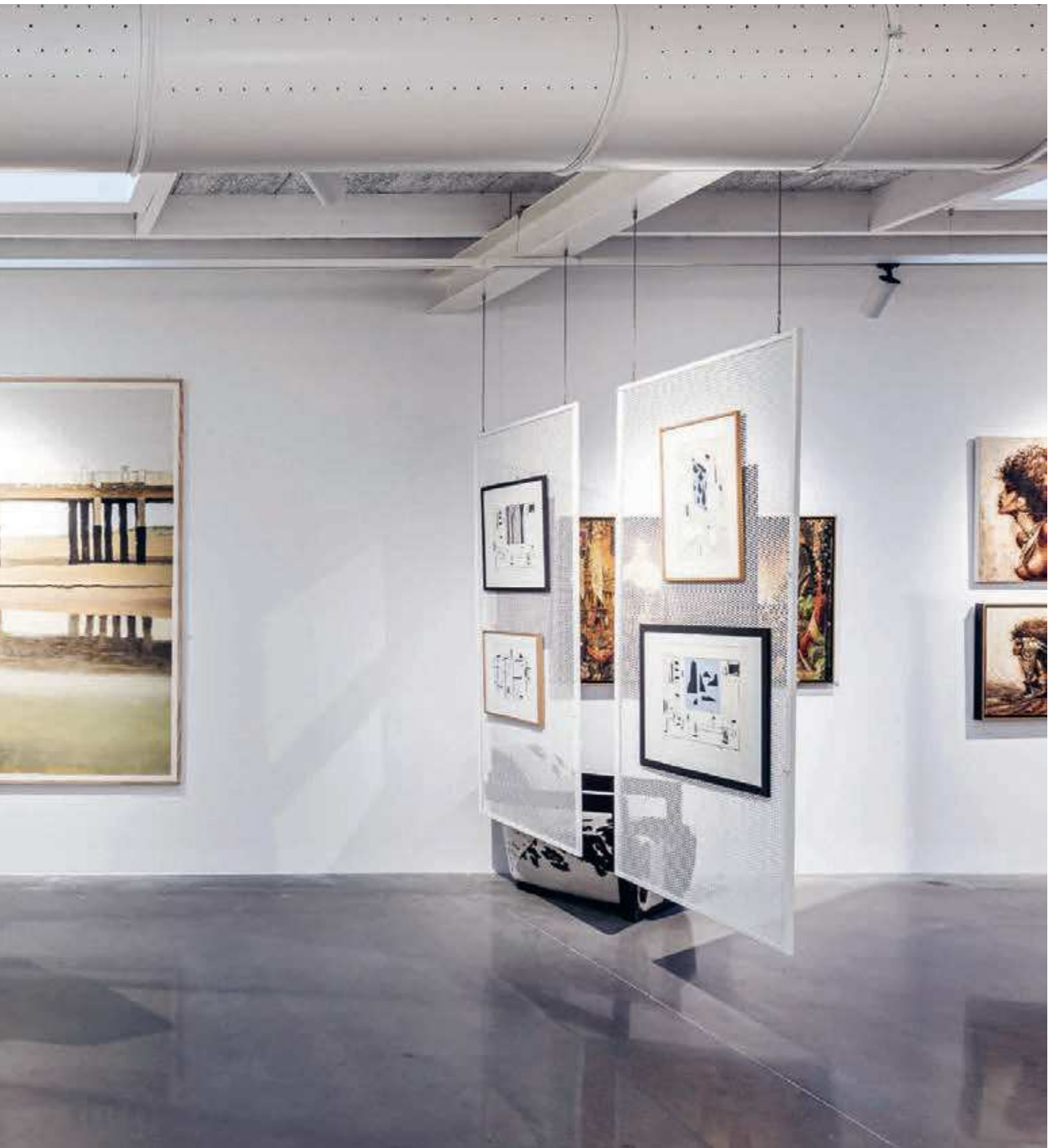



ARCHITECT SMLXL



FRAGMA

No two lighting schemes are identical. Different geometries, different heights, different needs, there is more than only one factor that impacts a lighting set-up. The Fragma range easily adapts to any variable influencing the project, thanks to a multitude in optics, lumen packages and dimming possibilities. Its simple design and its circular shape let you use Fragma throughout the project, as it blends in perfectly in any architectural environment, combining clean cut optical performance, light quality and visual comfort.

www.deltalight.com/fragma-track



LED CASSET TECHNOLOGY

Fragma is based on Delta Light's LED Caset technology, which combines multiple LEDs with individual collimator lenses per LED to generate a clean-cut light distribution.

The individual lenses create a multi-layered light distribution to generate a 8° superspot or 14° beam angle as standard. Be it for the smaller version or the high-power Fragma, by concentrating the lenses together, the light distribution will be the same thanks to the multi-layering process.

DIMMING

Our Fragma luminaires can be used for simple switch on-switch off settings, but also come in different dimmable versions, be it 1-10V, DALI, with on-board potentiometer or even wireless.

1-10V dimmable Fragma spots allow for simple group dimming on track level, while our other dimmable versions can be used for individual dimming per spot. This going from individual handset dimming with the on-board potentiometer version, over the DALI addressable version controlled by a DALI master, till the wireless version based on CTRL Delta, offering solutions for both small and big installations. All Fragma versions require a 3 phase track.

However our wireless and on-board dimmable Fragma spots do not need additional dimming wiring within the 3 phase track and in this way offer an easier approach on flexible and individual dimming.

VISUAL WELLBEING

Light is not only about light effects, it also affects the well-being of the passer-by. Good light quality is of main importance, as it influences the passer-by in an indirect way. CRI 90, good Colour Over Angle uniformity and uniform luminance on the emitting surface are some of the characteristics that let Fragma excel in light quality.

In a direct way, the passer-by is influenced by the light when directly looking into the light source. To reduce the direct impact on the passer-by, Fragma offers multiple accessories to further improve its visual comfort.

FAMILY OVERVIEW

CHOOSE YOUR COLOUR



Black / White

CHOOSE YOUR POWER

Ø120mm / up to 1100lm

Ø140mm / up to 2600lm

Ø190mm / up to 4600lm

CHOOSE YOUR LED COLOUR

3000K / 4000K

CHOOSE YOUR OPTICS

Standard 8° or 14°

Interchangeable micro lenses to alter the 14° beam angle to 26° or 47°

Add a light refining accessory: softening lens, linear spread lens, wallwash lens

CHOOSE YOUR CONTROL

Non Dim / 1-10V Dim / Potentio Dim /

DALI Dim / Wireless Dim

CHOOSE YOUR ACCESSORY

Honeycomb / Raster / Flaps

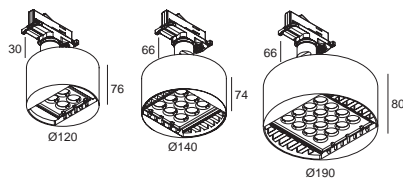





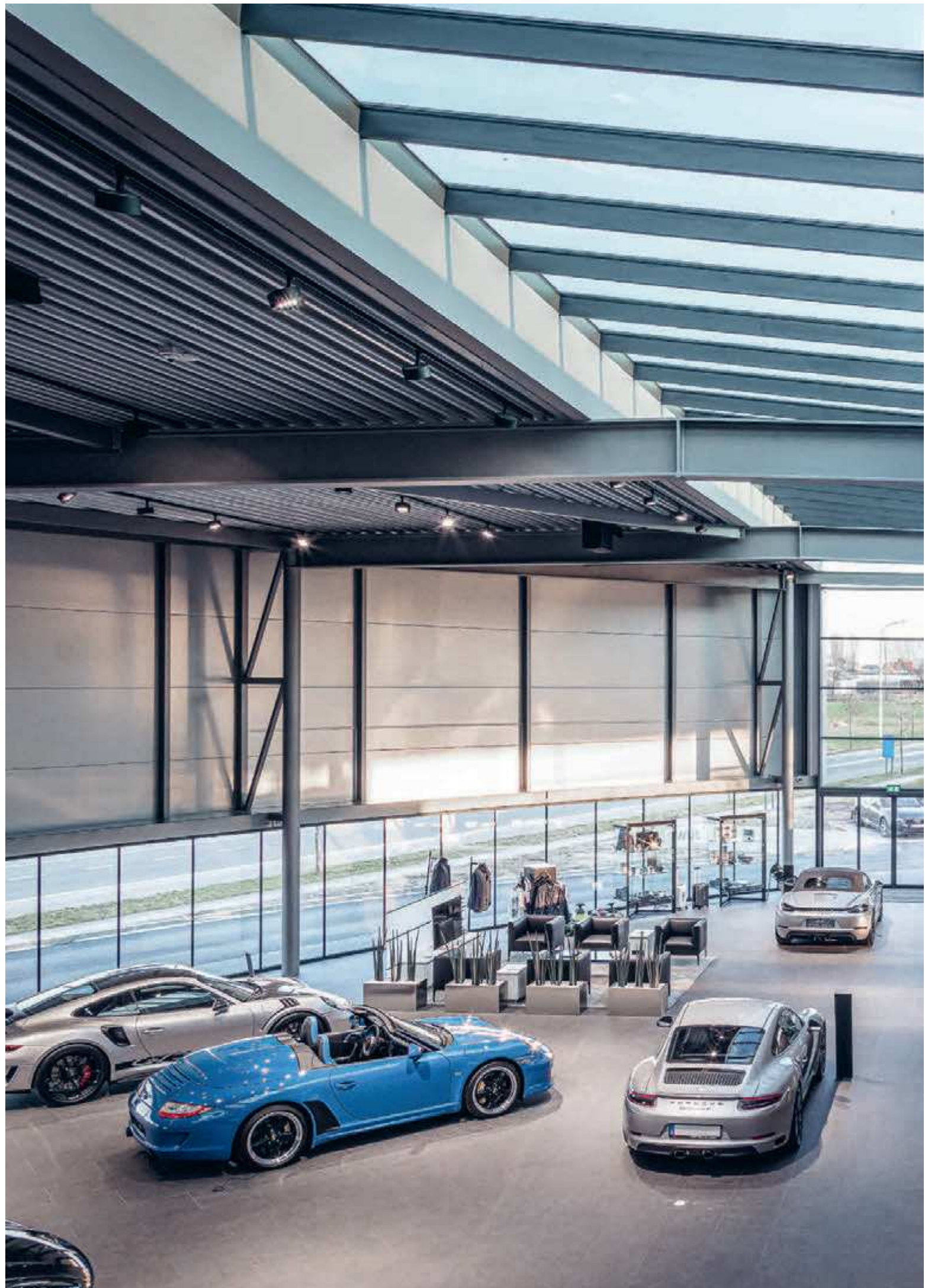





MULTINOVA

FAMILY

Multinova has something familiar and something fresh at the same time. As a disc of light, Nova refers to the Supernova range, as both families share similarities in looks and ways of installation. But Multinova has some additional features to make it multi-applicable, hence Multi in the name.

With 2 different diameters, a down and down-up version and a limited height of only 69mm, Multinova is perfect to use in different ways. Its small dimensions fit in any residential or hospitality project, as a track mounted luminaire it suits any retail environment and with a prismatic sheet for reduced glare it even adapts in office settings. Moreover, Multinova can be used on our Magnetic profiles for general lighting.

Multinova comes in our standard black or white and can also be finished in the warmer Gold Coloured to enrich its surroundings. To top it off – next to a sandblasted or prismatic optic – one can opt for a smoked sheet at the front for a more decorative touch. When turned on the disc is fully lit, when turned off a deep dark arises, ideal in combination with a Gold Coloured Multinova.

www.deltalight.com/multinova-track



STRAIGHTFORWARD OR PLAYFUL

On track, Multinova comes as a fix luminaire or as a pivoting disc. Like this, a straightforward light setting can easily be turned into a sparkling play between light and design.

**FAMILY OVERVIEW****CHOOSE YOUR COLOUR**

Black / Gold Coloured / White

CHOOSE YOUR INSTALLATION

Fix / Pivot

CHOOSE YOUR SIZE & POWER

Ø 300mm

Down 14,8W – 2150lm

Ø 550mm

Down 33,2W – 4820lm

CHOOSE YOUR LED COLOUR

3000K / Tunable White

CHOOSE YOUR OPTICS

Sandblasted / Prismatic (UGR<19) / Smoke

CHOOSE YOUR CONTROL

Non Dim / DALI Dim

CHOOSE YOUR FAVORITE TRACK

Recessed

Surface mounted

Suspended





SUPER-OH! XS

FAMILY

With its 25cm or 39cm diameter, the Super-Oh XS can be considered as the "little one" of the Super-Oh! family. With only 5cm height, this perfectly curved circle holds a polycarbonate, hiding a cluster of powerleds, specially designed to guarantee a uniform and perfectly balanced light output resulting in a very enjoyable diffuse lighting effect.

Its flexible pivot bracket enables the user to tilt the disc up to 45° and rotate 360°. Super-Oh XS is also available for direct mounting or as a pendant.

www.deltalight.com/super-oh-xs-track



FAMILY OVERVIEW

CHOOSE YOUR COLOUR



Black / White

CHOOSE YOUR SIZE & POWER

Ø250mm – 13,5W – 1470lm

Ø390mm – 25W – 2940lm

CONTROL

Mains Dim

CHOOSE YOUR FAVORITE TRACK

Recessed / Surface mounted / Suspended

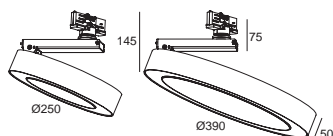

TRACK

Find the other members of this family **INTERIOR CEILING**







I-COR (INTERIOR CONCEPT STORE ROESELARE) WWW.I-COR.BE

interior
innovation
award



red dot design award
winner

Winner

GOOD
DESIGN
award

— AWARD —
DESIGN PLUS
light+building



SUPERNOVA XS

FAMILY

With its 26 cm or 33 cm diameter, Supernova XS is small when it comes to size, but not when it comes to performance and skills. Apart from its design, Supernova has lots of similarities with Super-Oh! XS. Both have a cluster of powerleds embedded behind a sandblasted optic to create a diffused light effect for general lighting and both are able to peek around the room thanks to their clever pivoting installation bracket.

www.deltalight.com/supernova-xs-track





FAMILY OVERVIEW

CHOOSE YOUR COLOUR



Black / White

CHOOSE YOUR SIZE & POWER

Ø260mm / 15W - 1580lm
Ø330mm / 22W - 2600lm

CHOOSE YOUR CONTROL

Non Dim / 1-10V Dim / DALI Dim

CHOOSE YOUR FAVORITE TRACK

Recessed / Surface mounted / Suspended





ARCHITECT LHOAS & LHOAS











INTERIOR & EXTERIOR
PROFILES

MAGNETIC PROFILES

SPLITLINE M20

P 472

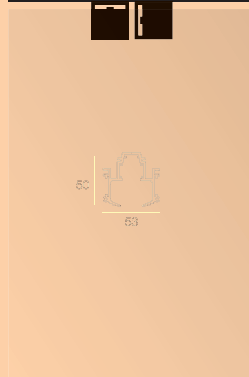

SPLITLINE M52

P 478

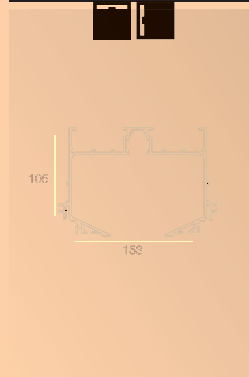

SHIFTLINE M26L

P 484

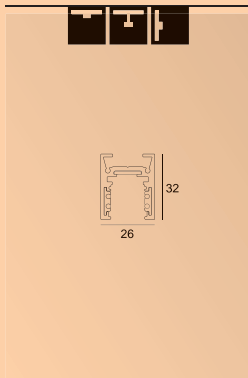

SHIFTLINE M26H

P 488

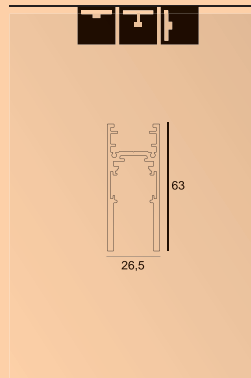

SHIFTLINE M35R

P 496

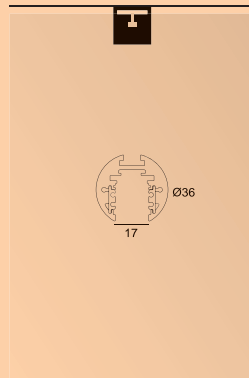

SHIFTLINE M44

P 500

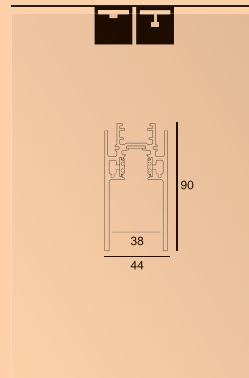

MODULE PROFILES

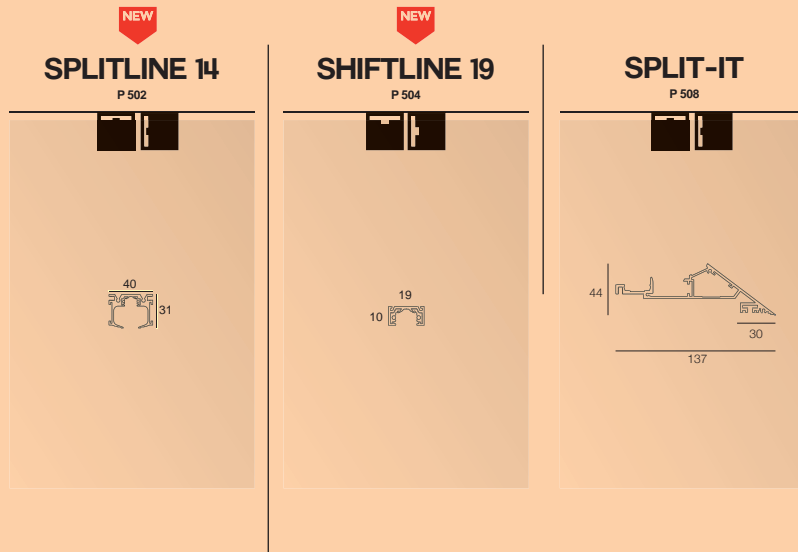

LED FLEX PROFILES

NEW

TAGLINE

P 514

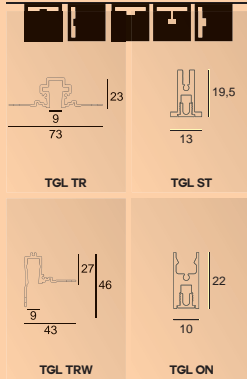

CONNECT

P 520

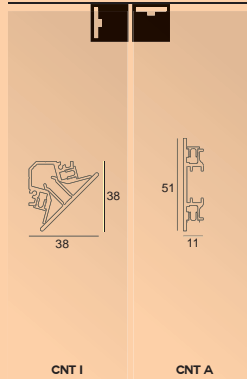

DOT.COM WW

P 522

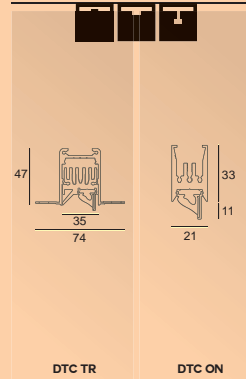

FEMTOLINE 25

P 526



FEMTOLINE 35

P 532

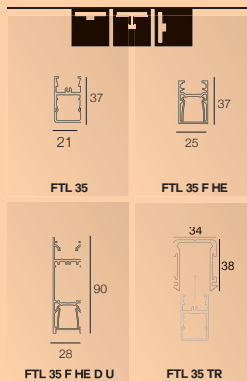

FEMTOLINE 45

P 534

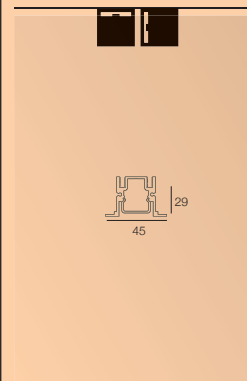

NEW

FEMTOLINE 35 WG

P 538

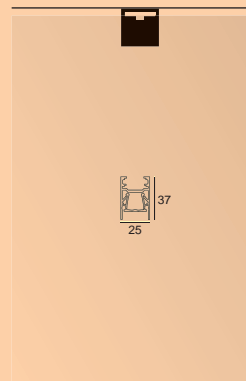

FEMTOLINE W

P 544

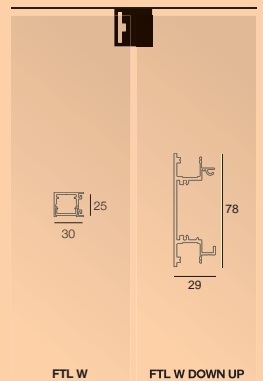

ONE AND ONLY

P 548

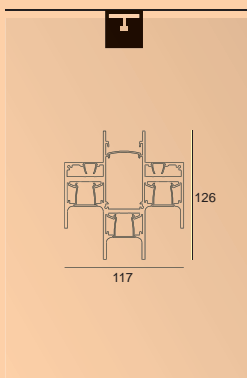

BORDERLINE

P 554

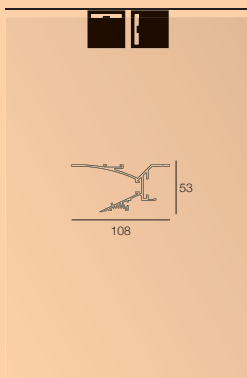

OUTLINER

P 560

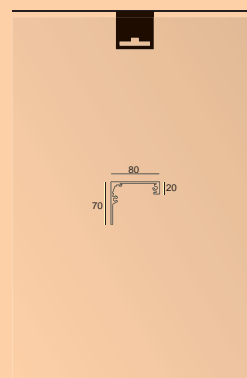

MICROLINE TR

P 562

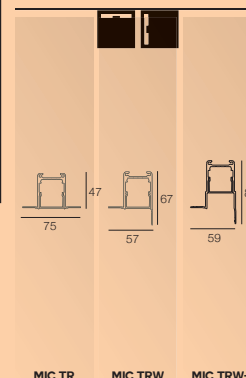

SHELFLINE

P 580

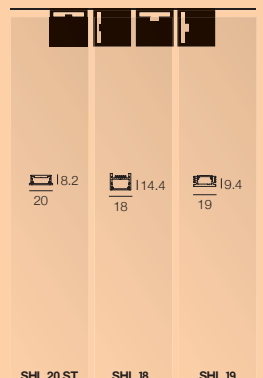

LED ARRAY PROFILES

PROFILES

PROFILE BUILDER
A practical easy-to-use web based tool to calculate your continuous profiles like Streamliner, Microline 40 / 60, Femline and Microline TR. Keep an eye on our website.

MICROLINE 40/60

P 562

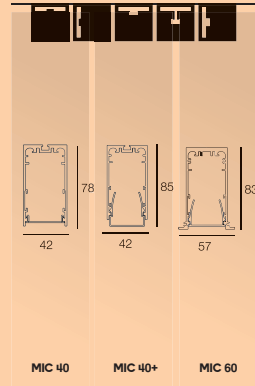

STREAMLINER

P 572



NEW

PAGE337

P 337

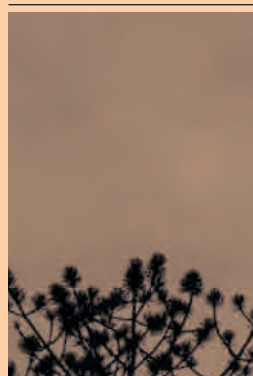



MAGNETIC

With the magnetic profiles, Delta Light takes it to the next level in the profile section. These profiles offer the highest degree of freedom and flexibility, as all modules have a magnetic fixation. Splitline M20 and M52 allow for a neat, trimless installation, while Shiftline M26, M35 and M44 can be used for projects where surface or suspended mounting is required. To create the optimal light setting, multiple light modules are available: spot modules with different beams and lumen packages going up to 2000lm for accent lighting, linear LED lines for general or wallwash lighting and pendant modules for an elegant finish of the room.

All modules can be placed toolfree into the profile and repositioned afterwards thanks to their magnetic fixation.

Simply click the module into the profile and both mechanical and electrical connection are ensured. As this family of profiles is powered by 48V, Smart 48 can be used for an easy 2-wire dimming/power solution, or even wireless.

For individual control of luminaires, one can opt for a DALI controlled system.

ACCENT



SPY 27



ODRON



SPY 39



PION



SPY 52



BOWIE



SPY 66

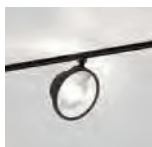

HALOSCAN



SPY FOCUS



TWEETER



VIZIR



PUNK



HEDRA

DECORATIVE



TWEETER BL



GIBBO



MICROSPY C

GENERAL



LED LINE HE



LED LINE UP



DOT.COM M



DOT.COM L



LED OK



LED D



MULTINOVA



INFORM

WALLWASH



DOT.COM



ARTUR

SPLITLINE M20

Splitline M20 combines the refinement and the cleanness of Splitline 16 with a boost of flexibility thanks to the magnetic mounting of the light modules. Together with the mechanical connection, the magnetic fixation of the modules ensures the electrical connection with the two 48V conductors in the profile.

In this way all light modules – spots, linear LED lines and pendants – can easily be placed or replaced into the profile according to the project's requirements, without the need of any tools.

www.deltalight.com/splitline-m20-profile



FAMILY OVERVIEW

COLOUR



Black

CHOOSE YOUR SETTING

Straight lines,
with 90° corners or bended curves

CHOOSE YOUR LIGHT MODULES

Accent

Spy / Vizir / Hedra / Punk / Tweeter /
Pion / Odron / Bowie / Haloscan

Decorative

Tweeter BL / Gibbo / Spy

General

Inform / LED Line / Dot.Com / Multinova

Wallwash

Dot.Com / Artuur

CHOOSE YOUR CONTROL

Modulator Dim / Wireless Dim / DALI Dim

CHOOSE YOUR EXTRA'S

Sensors

Presence - Daylight



53





PROJECT INSTORE / PHOTOGRAPHY MICHEL FIGUET







SPLITLINE M52

One catchphrase could best describe the Splitline M52: Flexibility at its best! Apart from protruding spots and pendant modules, this wider profile also allows for adjustable spot modules to be hidden inside the black line in the ceiling, resulting in a serene setting of the room. Similar to Splitline M20, all modules can be toolfree installed and repositioned into the profile thanks to their magnetic fixation, allowing the end user to adapt the light according to the setting of the room.

www.deltalight.com/splitline-m52-profile



FAMILY OVERVIEW

COLOUR



Black

CHOOSE YOUR SETTING

Straight lines or with 90° corners

CHOOSE YOUR LIGHT MODULES

Accent
1 LED / 2 LED / Spy

Decorative
Gibbo / Spy

CHOOSE YOUR CONTROL

Modulator Dim / Wireless Dim / DALI Dim

CHOOSE YOUR EXTRA'S

Sensors
Presence - Daylight

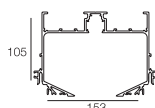





INTERIOR DESIGN MANUEL GARCÍA ASOCIADOS



STUDIO DIDEA





STUDIO DIDEA



SHIFTLINE M26L / MATRIX

Shiftline M26 L is the surface mounted variant of Splitline M20, ideal when recessed mounting is not an option.

Spy, Vizir and Hedra modules - in different sizes and lumen packages - can be combined with Tweeter modules, linear LED lighting or pendant modules as Microspy 39 C or Gibbo, giving you loads of possibilities to create your own ideal lighting scene. Do not worry if you overlooked something in this ideal lighting scene, as all modules can be easily switched from position thanks to their magnetic fixation.

www.deltalight.com/shiftline-m26-l-profile

www.deltalight.com/shiftline-m26-l-matrix



FAMILY OVERVIEW

CHOOSE YOUR COLOUR



Black / Brushed Bronze / Polished Alu / White

CHOOSE YOUR SETTING

Straight lines or with 90° corners

Create a Matrix structure with several layers of light in any desired direction.

CHOOSE YOUR INSTALLATION

Surface mounted / Suspended

CHOOSE YOUR LIGHT MODULES

Accent

Spy / Vizir / Hedra / Punk / Tweeter / Pion / Odrón / Bowie / Haloscan

Decorative

Tweeter BL / Gibbo / Spy

General

Inform / LED Line / Dot.Com / Multinova

CHOOSE YOUR CONTROL

Modulator Dim / Wireless Dim / DALI Dim

CHOOSE YOUR EXTRA'S

Sensors

Presence - Daylight



**MATRIX** PATENTED

Unlimited flexibility is what the Shiftline M26 L Matrix system stands for. These clever add-ons to the Shiftline M26 L profiles allow you to couple multiple profiles to each other and create any structure you want. Our 2P Connector not only assures the electrical connection between two profiles, it also serves as a decorative element as its cylindrical shape is perfectly in contrast with the straight lines of the profile. Moreover, this contrast can be enhanced by choosing the Gold Coloured finish for these nodes, a bold statement where design meets functionality.

To complete the Matrix system, an additional ceiling fixation and a non electrical connector allow for unlimited creativity as one is free to connect multiple profiles any way they want. Moreover, the new Side Supply finishes it off in style as it is designed according to the looks of the 2P Connector.







SHIFTLINE M26H

The higher version of our Shiftline M26 creates extra possibilities in terms of functionality, as the profile allows to combine modules for direct lighting with linear modules for indirect lighting, a perfect way to enhance the spacial feeling of the room.

To break the linearity of the Shiftline M26 H, 2 curved corners are available to go from a straight lighting pattern to a free-form lighting set-up. The bends of 90° and 135° allow you to create the set-up of your desires.

www.deltalight.com/shiftline-m26-h-profile



FAMILY OVERVIEW

CHOOSE YOUR COLOUR



Black / Brushed Bronze / Polished Alu / White

CHOOSE YOUR SETTING

Straight lines, with corners or bended curves

CHOOSE YOUR INSTALLATION

Surface mounted / Suspended

CHOOSE YOUR LIGHT MODULES

Accent

Spy / Vizir / Hedra / Punk / Tweeter / Pion / Odron /
Bowie / Haloscan

Decorative

Tweeter BL / Gibbo / Spy

General

Inform / LED Line / LED Line Up / Dot.Com / Multinova

CHOOSE YOUR CONTROL

Modulator Dim / Wireless Dim / DALI Dim

CHOOSE YOUR EXTRA'S

Sensors

Presence - Daylight

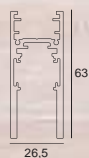





ARCHITECTENBUREAU WOUTER NAERT / INTERIOR DESIGN CHARLOTTE VAN BRUWAENE





INTERIOR DESIGN MAILSTER

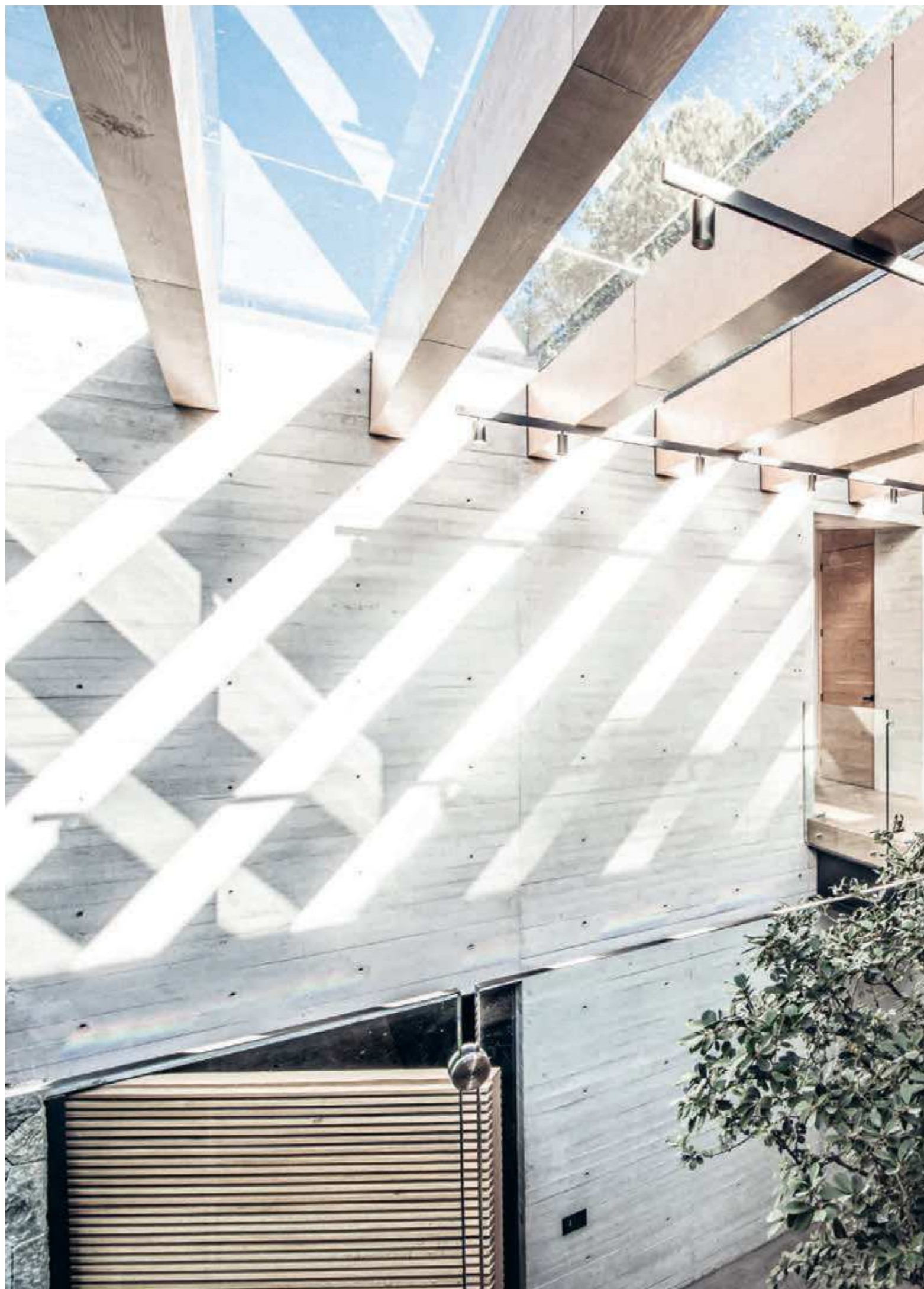

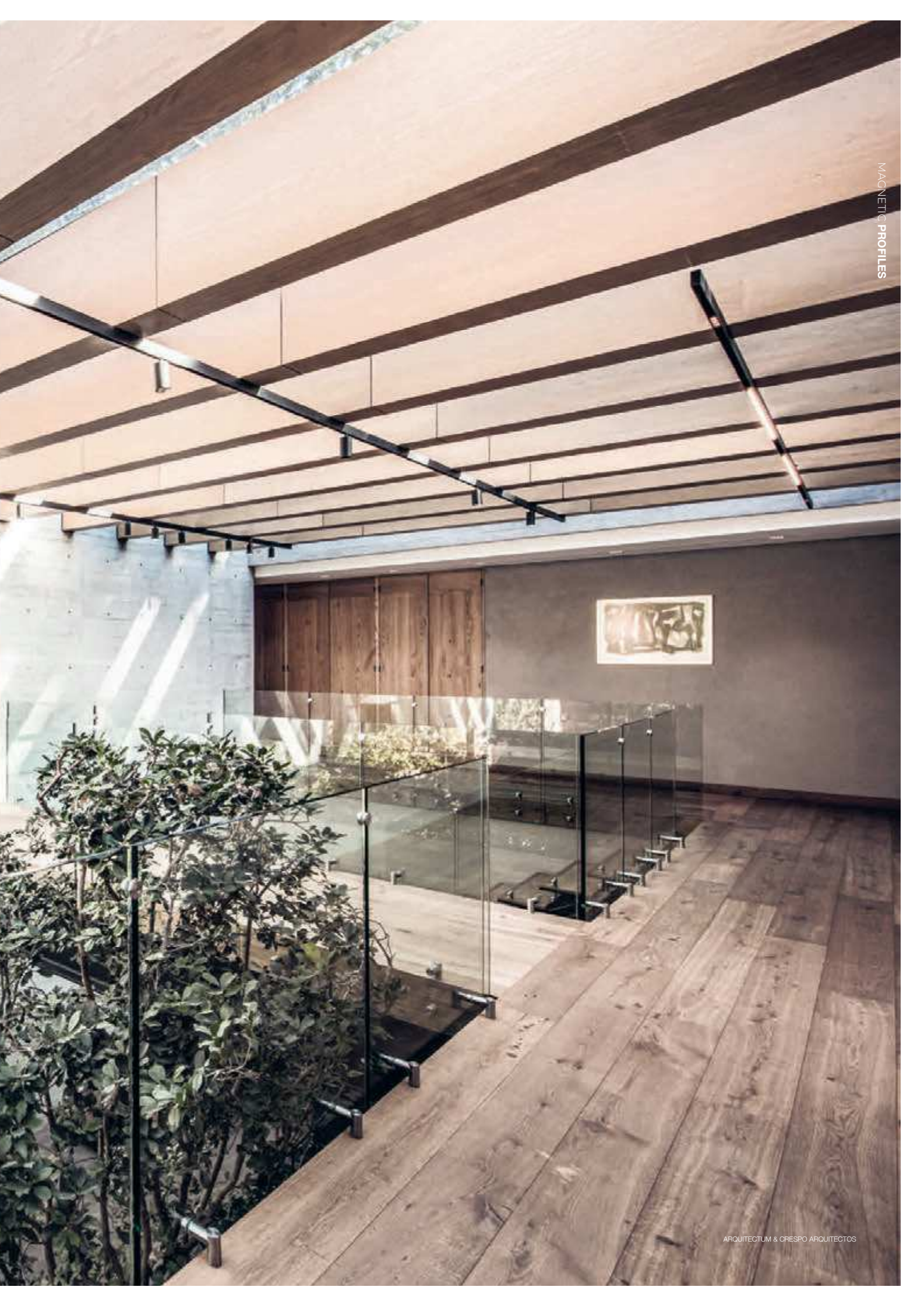



SHIFTLINE M35R

With its cylindrical shape, Shiftline M35R is a decorative element on its own. Combined with the suspended Microspy 39 C or Gibbo it can easily upscale any project. By adding magnetic spot modules or linear lighting, Shiftline M35R gives a sophisticated touch to functional lighting.

www.deltalight.com/shiftline-m35-r-profile



FAMILY OVERVIEW

CHOOSE YOUR COLOUR



Black / White

CHOOSE YOUR SETTING

Straight lines, with corners or bended curves

CHOOSE YOUR INSTALLATION

Surface mounted / Suspended

CHOOSE YOUR LIGHT MODULES

Accent

Spy / Vizir / Hedra / Punk / Tweeter / Pion / Odrón /
Bowie / Haloscan

Decorative

Tweeter BL / Gibbo / Spy

General

Inform / LED Line / Dot.Com / Multinova

CHOOSE YOUR CONTROL

Modulator Dim / Wireless Dim / DALI Dim

CHOOSE YOUR EXTRA'S

Sensors

Presence - Daylight

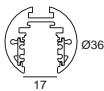





INTERIOR DESIGN INHABIT / LIGHTING DESIGN BIG ARCHITECTURAL LIGHTING / PHOTOGRAPHY ELIN RODESTRAND @ELINRPHOTOGRAPHY





SHIFTLINE M44

The broader Shiftline M44 is a surface or suspended magnetic profile that combines different types of lighting without the light modules being visible outside the profile. Linear modules or individual downlights for general lighting and Dot.Com for office lighting can easily be combined with uplight to enhance the volume of the room.

www.deltalight.com/shiftline-m44-profile



FAMILY OVERVIEW

CHOOSE YOUR COLOUR



Black / White

CHOOSE YOUR SETTING

Straight lines or with 90° corners

CHOOSE YOUR INSTALLATION

Surface mounted / Suspended

CHOOSE YOUR LIGHT MODULES

Accent

1 LED / 2 LED

Decorative

Gibbo / Spy

General

Inform / LED Line / LED Line Up / Dot.Com

CHOOSE YOUR CONTROL

Modulator Dim / Wireless Dim / DALI Dim

CHOOSE YOUR EXTRA'S

Sensors

Presence - Daylight

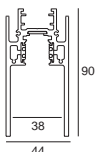



SPLITLINE 14

Narrow streets draw black lines through space and literally form a 'lighting path' that dialogues with the architecture of the surroundings. The Splitline 14 profile can be combined with several accent lights, depending on what the space needs, both functionally and in terms of design. Splitline 14 effortlessly integrates with architecture, upgrading the uniqueness of the room.

www.deltalight.com/splitline-14-profile



FAMILY OVERVIEW

COLOUR



Black

CHOOSE YOUR SETTING

Any desired length

Go around the corner

Go from horizontal to vertical

CHOOSE YOUR LIGHT MODULES

Uho / Spy 27 / Spy 39

CHOOSE YOUR CONTROL

MDL Dim (Smart 48) / DALI Dim

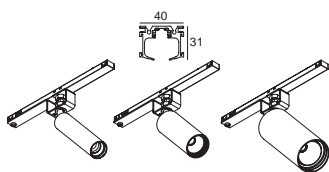



SHIFTLINE 19

Building on the flexibility of our Superloop, adding the refinement of our 2F track and shrinking down the design to the level of our Shelfline. The result? Shiftline 19! This miniature profile lets you combine accent lighting and decorative lighting in the shape of Uho, Spy 27 and Spy 39.

Containing 2 48V and 2 Dim conductors for individual DALI Dimming, the slender profile can easily be combined with Smart 48 and CTRL Delta to offer a quick and easy, minimalistic, wireless lighting set-up.

Shiftline 19 has many application possibilities, as its Dimensions are reduced to a minimum which allow a surface mounted installation that only requires a minimum of space. Be it in residential, hospitality or in retail, the different modules to apply on the Shiftline 19 track can be used for accent lighting or decorative lighting, offering multiple ways of flexibility.

www.deltalight.com/shiftline-19-profile



FAMILY OVERVIEW

CHOOSE YOUR COLOUR



Black / White

CHOOSE YOUR SETTING

Any desired length

Go around the corner

Go from horizontal to vertical

CHOOSE YOUR LIGHT MODULES

Uho / Spy 27 / Spy 39

CHOOSE YOUR CONTROL

MDL Dim (Smart 48) / DALI Dim

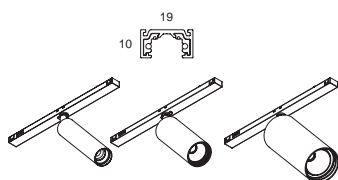









SPLIT-IT

The Split-it made-to-measure lighting system integrates seamlessly with architecture and demonstrates that form and functionality of lighting have definitely gone down a new path, opening new ways to integrate "lighting paths" with architecture.

The Split-it Pro is a single profile which can be used on its own, or in combination of two. When used as a single profile the Split-it concept can be used parallel with the wall. In a double set-up the Split-It Pro enables you to create a linear setting with Dimensions of your choice. The Pro version enables integration of edgeless lighting paths, either vertically or horizontally. Its 37° degree sharp edge gives walls and ceilings a 'paper-thin' appearance, with no visible wires and no shadow gaps, upgrading the level of architectural detail. It offers not only new ways to give shape to any lighting need, it also gives the possibility to integrate other engineering and technological necessities.

With its linear geometry the Split-it Pro enables you to define spaces and create volumes, to show direction, frame the room and add sharp edged detail to your architecture. It can be combined with a multitude of spots available for specific and demanding lighting needs, ranging up to 2000lm and offering multiple beam optics. All tools are available to meet the specific needs of your project.

www.deltalight.com/split-it-profile



FAMILY OVERVIEW

CHOOSE YOUR COLOUR



Black / White

CHOOSE YOUR SETTING

Straight lines or with corners

CHOOSE YOUR LIGHT EFFECT

Indirect light

5W up to 21W per meter

Accent light
with Spy modules

CHOOSE YOUR LED COLOUR

2700K / 3000K / 4000K

Soft Dim / RGB / RGB TW - Tunable White

CHOOSE YOUR CONTROL

Non Dim / Mains Dim / 1-10V Dim / DALI Dim

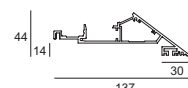







INTERIOR DESIGN VJAD - VIKTOR UDZENIJA / PHOTOGRAPHY LUCA CIOCI





TAGLINE

The Tagline made-to-measure profile provides an ultra-minimalistic light line that integrates seamlessly with the architectural lines of your project. Limited to only 7mm the Tagline seems almost invisible, a slender line of light that cuts through space.

Available in different application versions - from trimless recessed to surface mounted, as a pendant solution or as perimeter lighting - Tagline is offered as a creative tool for architects and designers to accentuate architectural detail or characterise environments. Any space becomes distinctively elegant when the Tagline is used in a simple linear way, or can become very magical and unique when used in a composition.

TAGLINE TR / TRW

The ultra-minimalistic solution within the Tagline range, as these profiles are seamlessly installed into the ceiling, without any visible trim. While Tagline TR can be used to combine general linear lighting with Spy 27 spot modules for accent lighting, Tagline TRW is ideal to contour the perimeter of the room, as it integrates perfect in between corners where ceiling and wall interact.

TAGLINE ST / ON

Tagline ST and Tagline On have a little bit more body to it, as these will always have a visible trim. Different from Tagline TR, these versions only offer continuous lines of light for general lighting, be it recessed, surface mounted or suspended.

www.deltalight.com/tagline-profile



FAMILY OVERVIEW

CHOOSE YOUR COLOUR



Black / Gold Coloured / White

CHOOSE YOUR INSTALLATION

Recessed
with trim / trimless

Surface mounted

Suspended

POWER

820 lm/m

CHOOSE YOUR CONTROL

Non Dim / Mains Dim / 1-10V Dim / DALI Dim

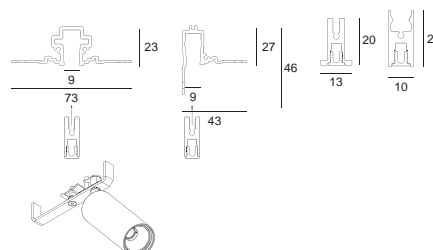



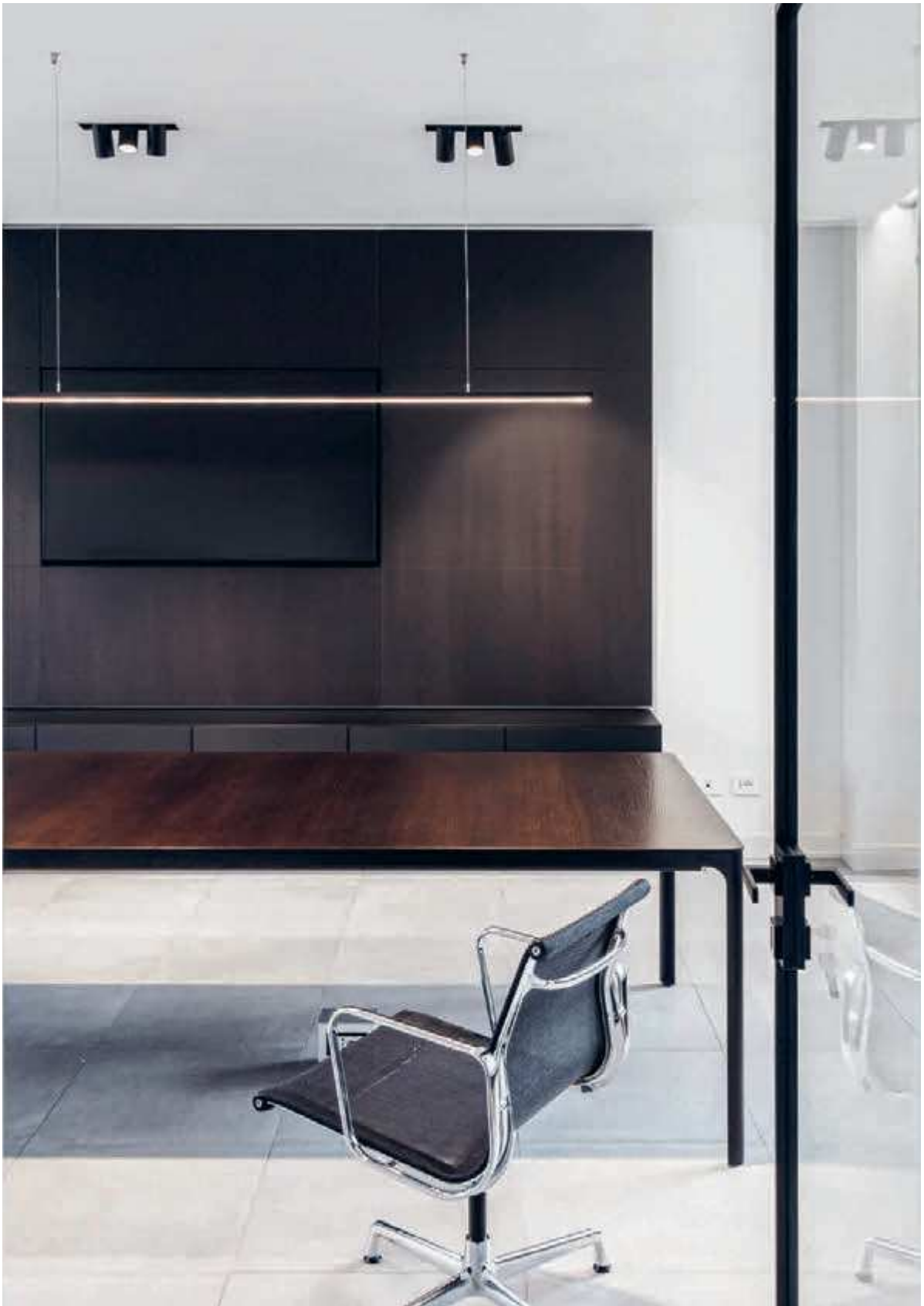

STUDIO DIDEA







CONNECT

CONNECT I

Connect I balances on the edge between wall and ceiling or wall and wall, as you like. Mounted directly into the corner, this minimalistic profile generates a soft line of light on one or both sides, transforming bare corners into decorative perimeters.

CONNECT A

The delicate Connect A is designed to add subtle accents onto vertical surfaces. Emitted from a profile of only 11 by 51mm, Connect A can be applied as a linear down-up light.

www.deltalight.com/connect-profile



FAMILY OVERVIEW

CHOOSE YOUR COLOUR



Black / White

CHOOSE YOUR INSTALLATION

Surface mounted
ceiling / wall

POWER

820 lm/m

CHOOSE YOUR CONTROL

Non Dim / 1-10V Dim / DALI Dim

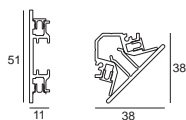



DOT.COM WALLWASH

Our Dot.Com family is not only limited to spotlight beam angles, it also has linear wallwashers in its range for a soft, even light effect on vertical surfaces. These come as single luminaires, as modules to fit in the magnetic profiles and as a bespoke trimless or surface mounted profile solution, perfect to adapt the light to your specific desires.

www.deltalight.com/dot-com-profile



FAMILY OVERVIEW

CHOOSE YOUR COLOUR



Black / White

CHOOSE YOUR INSTALLATION

Recessed - Trimless /
Surface mounted / Suspended

CHOOSE YOUR SETTING

Straight lines or with 90° corners

CHOOSE YOUR POWER

5W up to 20W/m – 550 up to 2470lm/m

CHOOSE YOUR LED COLOUR

2700K / 3000K / 4000K
Soft Dim / RGB / RGB TW - Tunable White

CHOOSE YOUR CONTROL

Non Dim / Mains Dim / 1-10V Dim / DALI Dim

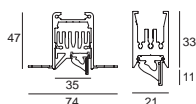

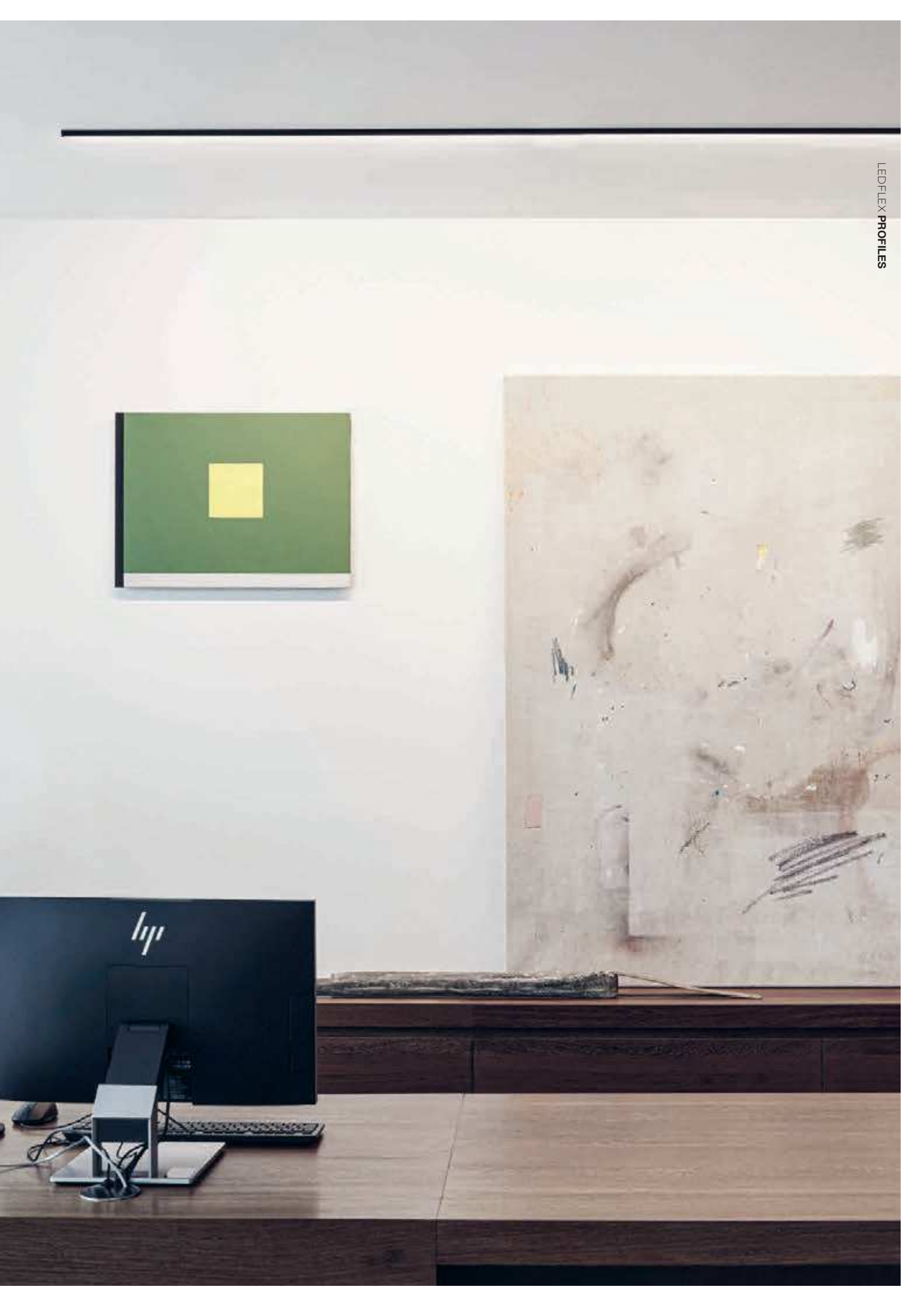

FEMTOLINE

FAMILY

The range of Femtoline profiles is very extensive, with each family member having its own specific design and application area. Small or wider profile design, down or down-up lighting, wall, ceiling or floor mounted, flush or tilted plexi ... the Femtoline family offers a solution to any lighting problem.

www.deltalight.com/femtoline-profile





FEMTOLINE 25

The smallest of the range for surface mounted lighting solutions. Femtoline 25 offers 3 ways of general lighting: standard with a semi-recessed plexi that creates both direct and indirect lighting, Femtoline 25 F with a flush plexi for direct lighting and Femtoline 25 T with a tilted plexi to create an asymmetric light effect.

www.deltalight.com/femtoline-profile



FAMILY OVERVIEW

CHOOSE YOUR COLOUR



Anodized / Black / White

CHOOSE YOUR VERSION

25 & 25F – General downlight
25T & 25TP – Asymmetric light

CHOOSE YOUR SETTING

Straight lines or with 90° corners

CHOOSE YOUR LOCATION

Interior / Exterior

CHOOSE YOUR POWER

5W up to 20W/m – 550 up to 2470lm/m

CHOOSE YOUR LED COLOUR

2700K / 3000K / 4000K
Soft Dim / RGB / RGB TW - Tunable White

CHOOSE YOUR CONTROL

Non Dim / Mains Dim / 1-10V Dim / DALI Dim

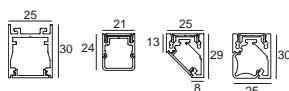









STUDIO2 ARCHITECTS / PHOTOGRAPHY SIMON DEVITT



INTERIOR DESIGN OMAR ABDELGHAFOUR - LIGHT SPACE DESIGN / CONCEPT BLACK FOR GREEN SCAPE

A play of light and shadow

FEMTOLINE 35 WALLGRAZER



The in-house developed lens extrusion is designed to fulfill multiple functionalities to create the optimal grazing effect. First of all, its specific shape generates a double light effect: in one direction it produces a small light beam to graze along the surface, even for higher walls, in the other direction the purpose is to widen the beam to obtain the same effect as wide as possible. Its second task is to do all of this without losing sight of the visual perception. Thanks to a special treatment of the lens, the LED dots of the LEDflex are being transformed into a uniform line of light without any obtrusive effect to the eye.

www.deltalight.com/femto-line-profile



FAMILY OVERVIEW

CHOOSE YOUR COLOUR



Anodized / Black / White

CHOOSE YOUR POWER

5W up to 20W/m – 550 up to 2470lm/m

CHOOSE YOUR LED COLOUR

2700K / 3000K / 4000K

CHOOSE YOUR CONTROL

Non Dim / Mains Dim / 1-10V Dim / DALI Dim

CHOOSE YOUR ACCESSORY

Add a tilting set for a perfect alignment of the beam

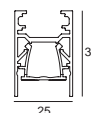

FEMTOLINE 35

The most versatile of the range. Similar as with Femtoline 25, one can opt for direct lighting with Femtoline 35 or a more indirect general lighting with Femtoline 35 F. Furthermore, Femtoline 35 can be used within the trimless Femtoline 35 TR profile, creating a black cove filled with strokes of light. As a pendant for down or down-up lighting, one can opt for the straightforward Femtoline 35 F HE D-U with its H-shaped design that hides away the plexi from below.

www.deltalight.com/femtoline-profile



FAMILY OVERVIEW

CHOOSE YOUR COLOUR



Anodized / Black / White

CHOOSE YOUR INSTALLATION

Recessed - Trimless /
Surface mounted / Suspended

CHOOSE YOUR VERSION

35TR / 35 / 35F HE – General downlight
35F HE D-U – General down- & uplight

CHOOSE YOUR SETTING

Straight lines or with 90° corners

CHOOSE YOUR LOCATION

Interior / Exterior

CHOOSE YOUR POWER

5W up to 20W/m – 550 up to 2470lm/m

CHOOSE YOUR LED COLOUR

2700K / 3000K / 4000K
Soft Dim / RGB / RGB TW - Tunable White

CHOOSE YOUR CONTROL

Non Dim / Mains Dim / 1-10V Dim / DALI

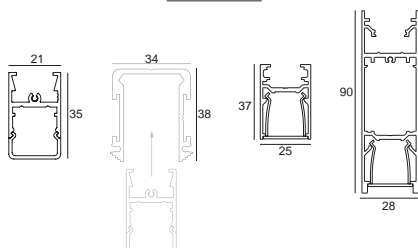

ARCHITECT TETRIS





ARCHITECT ATELIER SILHOUETTE URBAINE



FEMTOLINE 45

The recessed solution. Femtoline 45 complements the Femtoline 25 range in applications that allow recessed installation.

www.deltalight.com/femtoline-profile



FAMILY OVERVIEW

CHOOSE YOUR COLOUR



Anodized / Black / White

CHOOSE YOUR SETTING

Straight lines or with 90° corners

CHOOSE YOUR LOCATION

Interior / Exterior

CHOOSE YOUR POWER

5W up to 20W/m – 550 up to 2470lm/m

CHOOSE YOUR LED COLOUR

2700K / 3000K / 4000K

Soft Dim / RGB / RGB TW - Tunable White

CHOOSE YOUR CONTROL

Non Dim / Mains Dim / 1-10V Dim / DALI

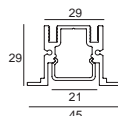







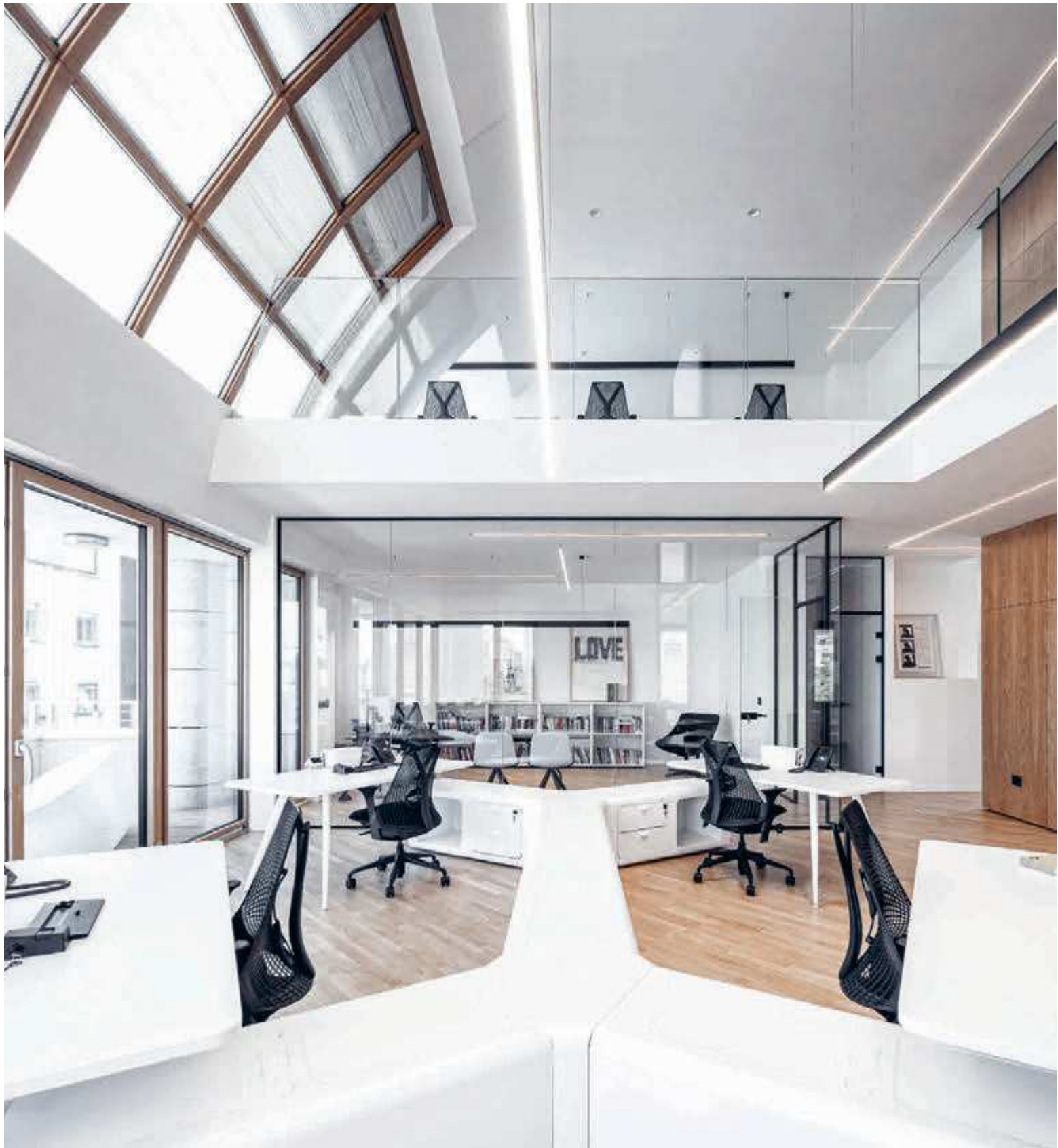

ARCHITECT MILENA VUKMIROVIĆ DARCH



FEMTOLINE WALL

The wall mounted solution. Femtoline W is a very slim and multifunctional LED profile, which can be used in both interior and exterior lighting concepts. This wall mounted profile can be used for either up- or downlight, creating a cosy wall grazing effect. Femtoline W Down-Up is a bespoke wall mounted profile for direct-indirect illuminance on vertical surfaces. It also comes in fixed lengths of 600 and 1200mm.

www.deltalight.com/femtoline-profile



FAMILY OVERVIEW

CHOOSE YOUR COLOUR



Anodized / Black / White

CHOOSE YOUR LOCATION & LIGHT EFFECT

Interior – Down / Down-Up

Exterior – Down

CHOOSE YOUR SETTING

Straight lines or with 90° corners

CHOOSE YOUR POWER

5W up to 20W/m – 550 up to 2470lm/m

CHOOSE YOUR LED COLOUR

2700K / 3000K / 4000K

Soft Dim / RGB / RGB TW - Tunable White

CHOOSE YOUR CONTROL

Non Dim / Mains Dim / 1-10V Dim / DALI

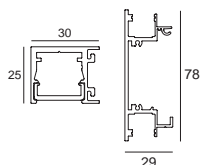

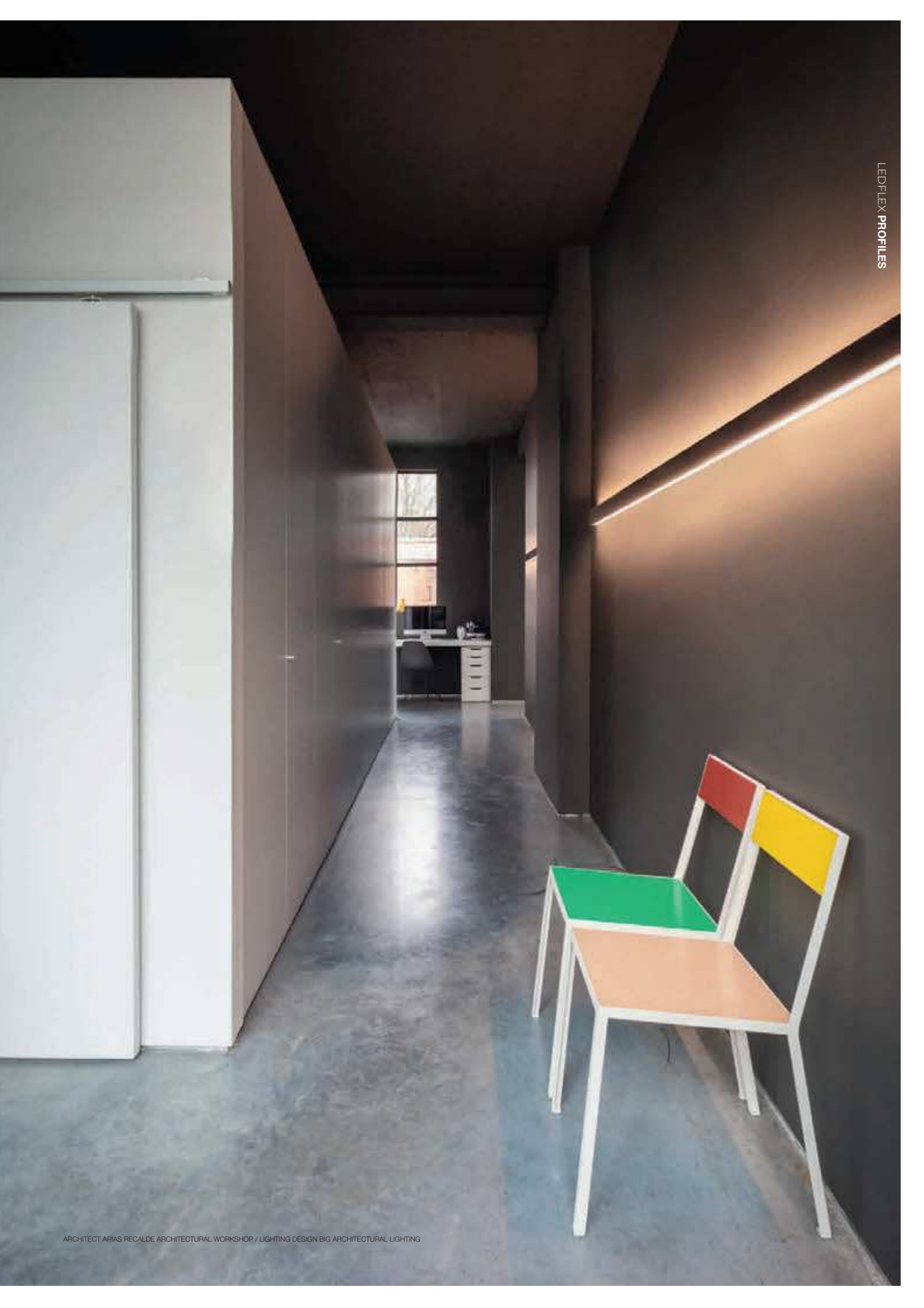



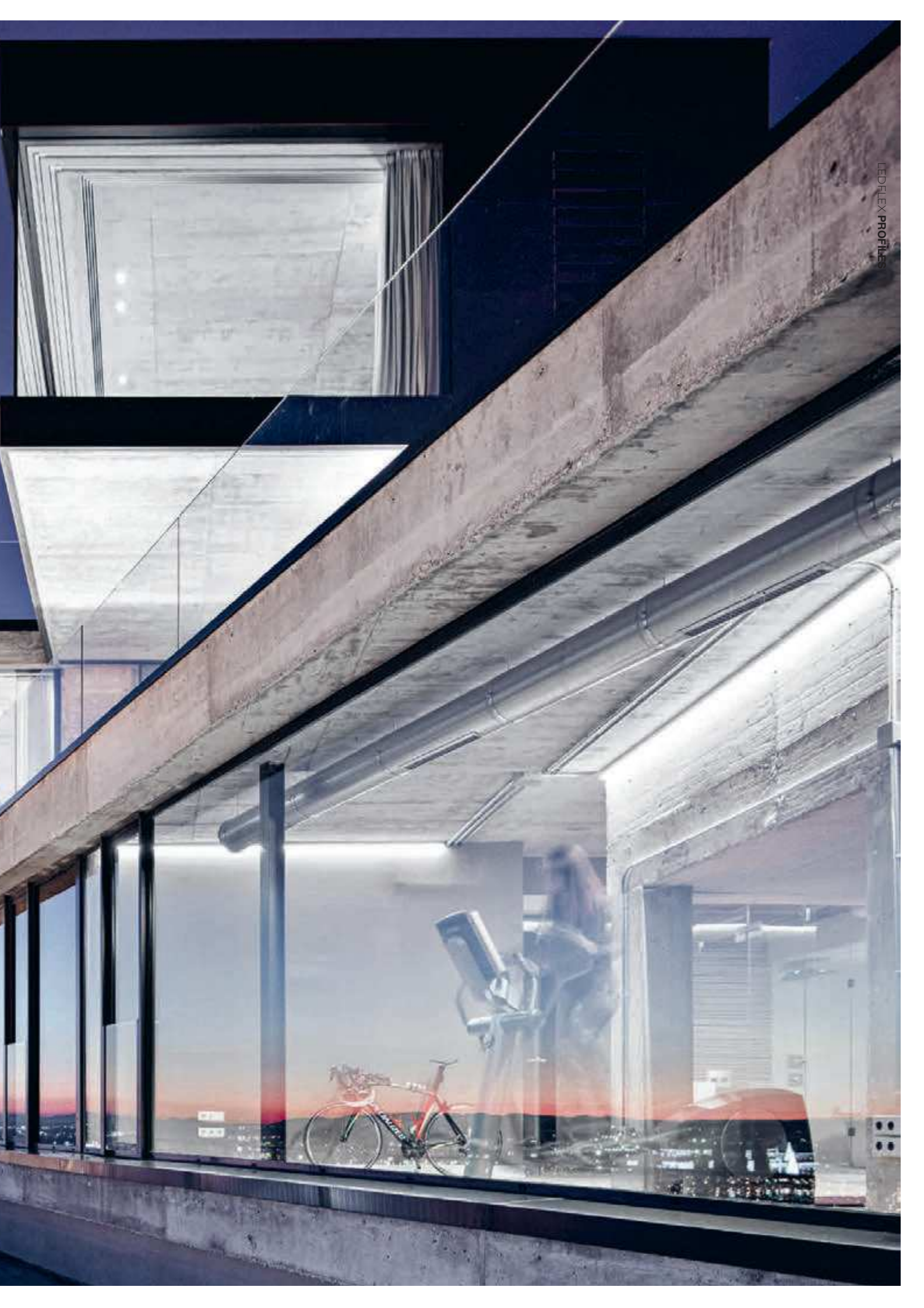



ONE AND ONLY

A peculiar profile, both functional as decorative. The design of the body allows you to have up to 5 lines of light out of 1 profile, 3 for direct and 2 for indirect lighting. The soft glow of the light along the sides of the profile makes the One-And-Only float through the air, a powerful blend of light for an eye-catching look.

www.deltalight.com/one-and-only-profile



FAMILY OVERVIEW

CHOOSE YOUR COLOUR



Black / Gold Coloured / White

POWER

Down

3 x 1045lm/m

Up

2 x 1045lm/m

CHOOSE YOUR LED COLOUR

2700K / 3000K / 4000K

CHOOSE YOUR CONTROL

Non Dim / Mains Dim / 1-10V Dim / DALI Dim

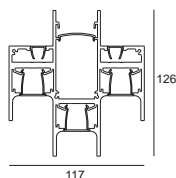



INTERIOR ARCHITECTURE BY @AFC-COLLECTION



I-COR (INTERIOR CONCEPT STORE ROESELARE) WWW.I-COR.BE





BNP ARCHITECTEN / INTERIOR DESIGN CRENEAU INTERNATIONAL

BORDERLINE

With the Borderline profile Delta Light introduces a generation of recessed led profiles, setting standards in the indirect lighting segment. It features a remarkable trimless finishing, although easy to install and finish.

The Borderline can be used for both wall and ceiling application, enabling you to frame the room with light. Available with RGB, tunable white, warm or cold white LEDs, offering a contemporary indirect lighting solution with exceptional eye for architectural detail.

www.deltalight.com/borderline-profile



FAMILY OVERVIEW

COLOUR



White

CHOOSE YOUR SETTING

Straight lines or with 90° corners

CHOOSE YOUR POWER

5W up to 20W/m – 550 up to 2470lm/m

CHOOSE YOUR LED COLOUR

2700K / 3000K / 4000K

Soft Dim / RGB / RGB TW - Tunable White

CHOOSE YOUR CONTROL

Non Dim / Mains Dim / 1-10V Dim / DALI Dim

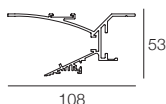





NINA MAYA INTERIORS - PHOTOGRAPHY NICOLE ENGLAND







ARCHITECT NIKOLAS DEBRAUWER

OUTLINER

Outliner defines the perimeter. It comes as single luminaire or as a bespoke profile, perfectly optimizable to any desired length. Designed as an unobtrusive linear solution, Outliner shields off the light source and gently casts its light towards the surface. As such, Outliner is ideal to serve as perimeter lighting across paths, terraces or parking lots, areas that function as passageway.

www.deltalight.com/outliner-profile



FAMILY OVERVIEW

COLOUR



Dark Grey

CHOOSE YOUR POWER

5W up to 15W/m – 550 up to 1850lm/m

CHOOSE YOUR LED COLOUR

2700K / 3000K / 4000K
Soft Dim / RGB / Tunable White

CHOOSE YOUR CONTROL

Non Dim / Mains Dim / 1-10V Dim / DALI Dim

IP54





MICROLINE

A series of slim, made-to-measure LED profiles which stand out for their versatility and clean-cut design. The Microline profiles are designed to create uninterrupted lines of light, ideal to accentuate architectural lines or be used as general lighting.

MICROLINE TR

The Microline Trimless profiles are the perfect solution for cove lighting. The ability to create lines, internal and external corners allows the designer to draw all perimeters of the room, even those with the most expressive geometrics. An invisible light effect, all without interruption.

MICROLINE 40/60

The Microline 40/60 profile was created as a high efficiency replacement for the original 30/50 profile. The high-output led array is available with a dimmable power supply with 151lm/W and as a non-dimmable version delivering 167lm/W. In addition, the 40+ features a protruding polycarbonate for extra wide light output.

www.deltalight.com/microline-profile



MICROLINE TR

CHOOSE YOUR COLOUR



Anodized

CHOOSE YOUR SETTING

Straight lines or with 90° corners

CHOOSE YOUR POWER

5W up to 20W/m – 550 up to 2470lm/m

CHOOSE YOUR LED COLOUR

2700K / 3000K / 4000K
Soft Dim / RGB / RGB TW - Tunable White

CHOOSE YOUR CONTROL

Non Dim / Mains Dim / 1-10V Dim / DALI Dim

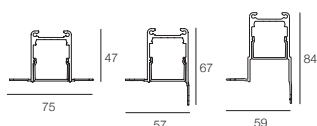

MICROLINE 40/60

CHOOSE YOUR COLOUR



Anodized / Black / White

CHOOSE YOUR INSTALLATION

Recessed / Surface mounted / Suspended

CHOOSE YOUR SETTING

Straight lines or with 90° corners

CHOOSE YOUR POWER

1900 lm/m / 3600 lm/m

CHOOSE YOUR CONTROL

Non Dim / 1-10V Dim / DALI Dim – Switch Dim

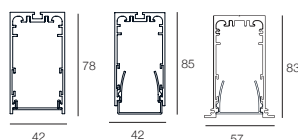

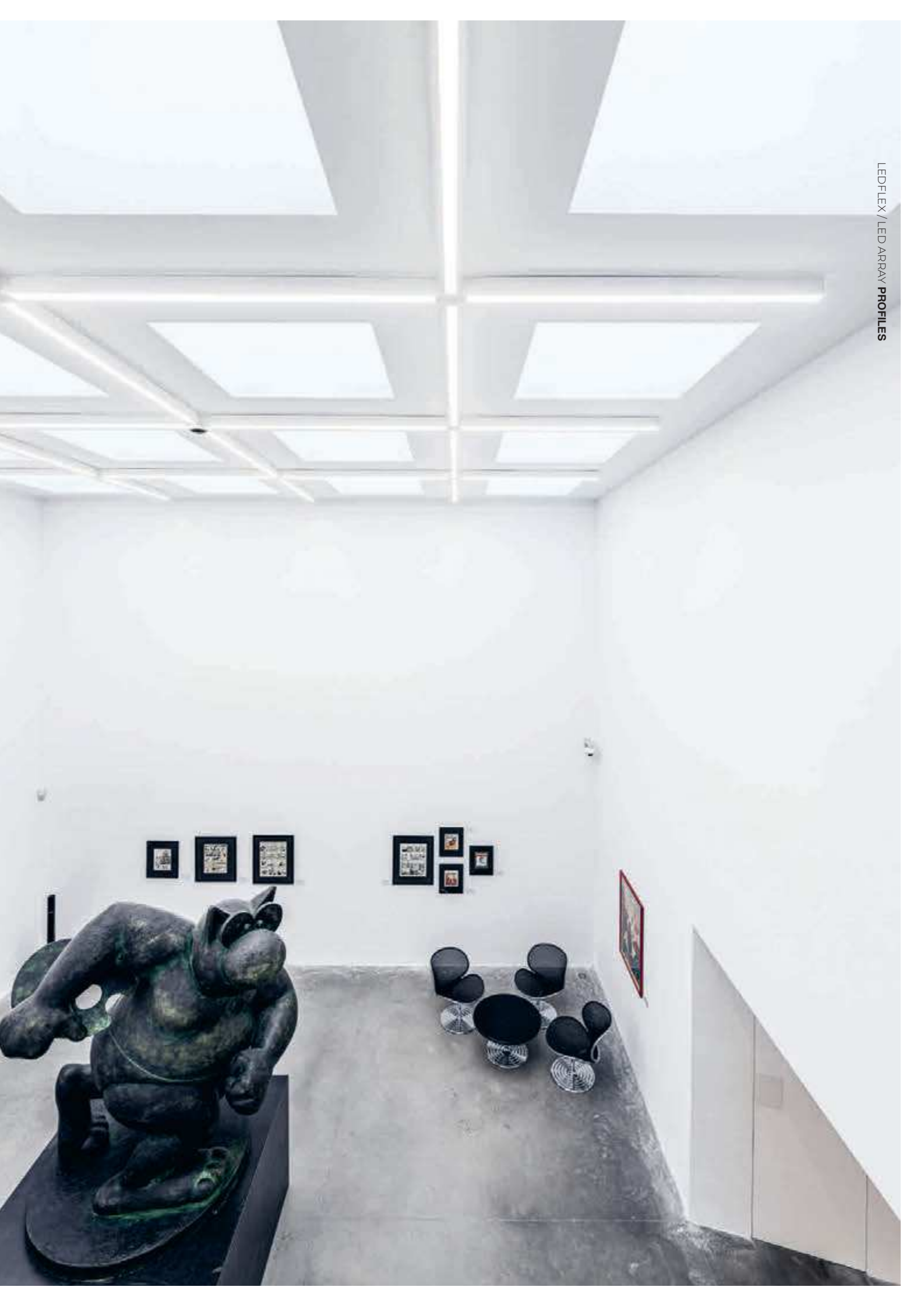



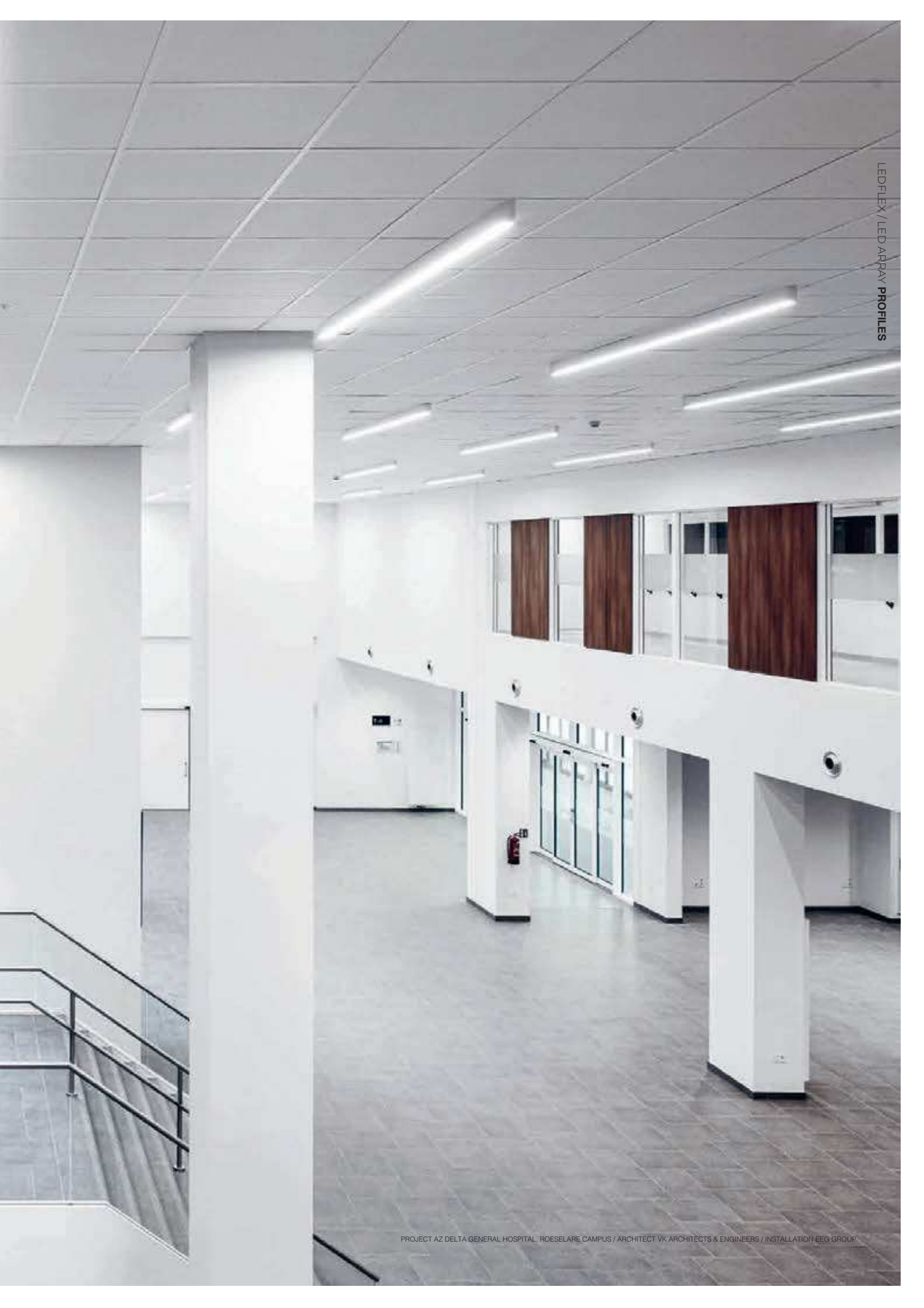

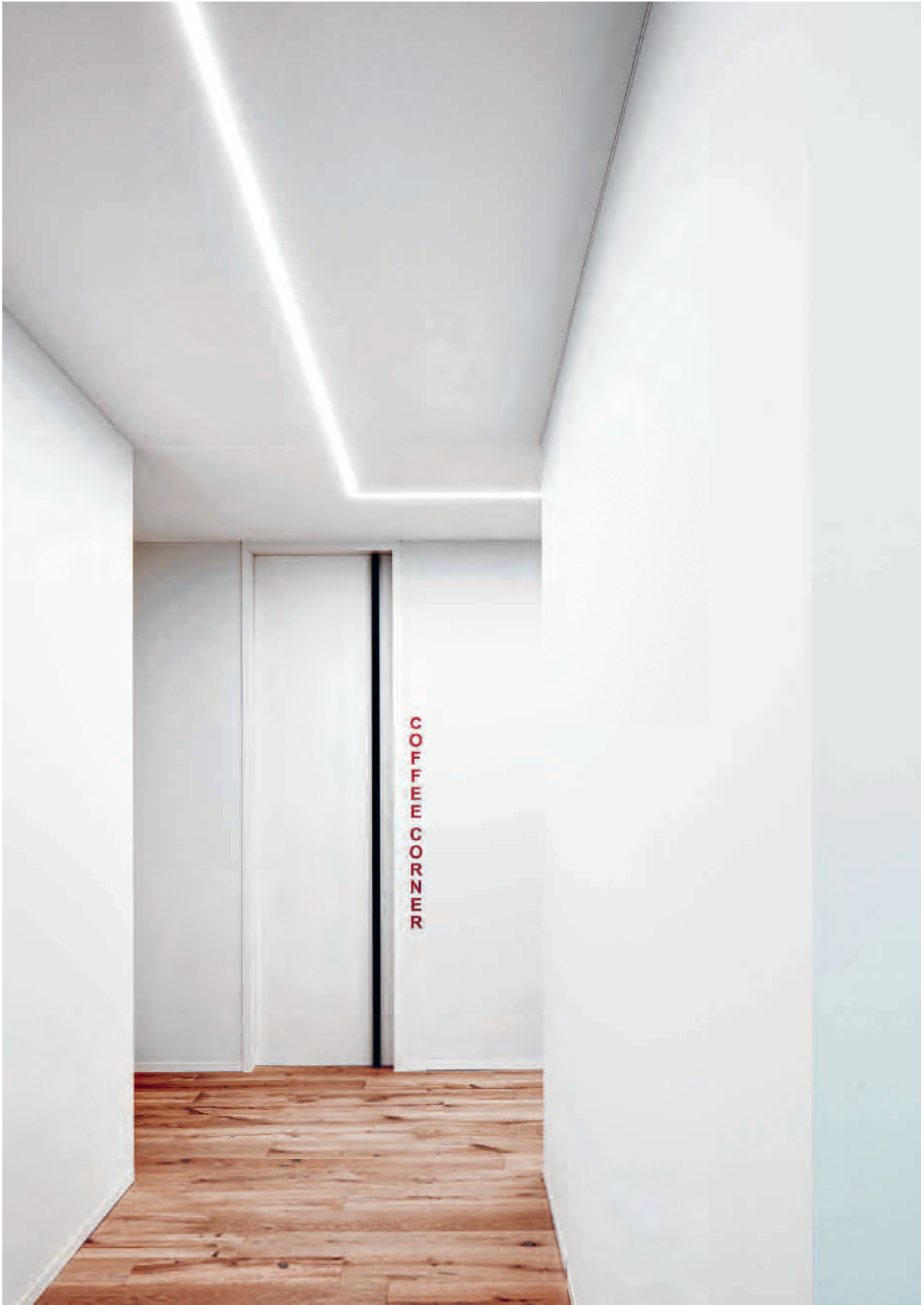













The made-to-measure Streamliner is a very versatile LED-focused profile family. Its multiple installation options combined with the possibility to add spots and downlights, allow Streamliner to be used in various applications. Inside, the LED array is available in 2 different output levels and can be finished with an opal or prismatic cover. The possibility to use Tunable White, emergency modules and sensors further add to the flexibility of Streamliner

Streamliner can be recessed mounted, with (Streamliner 85) or without trim (Streamliner TR), surface or pendant mounted. As a pendant version, the profile can be used with only direct light or there is also the opportunity to have it direct-indirect. To give the profile even more flexibility, also integrated downlighters and additional spots are available.

STREAMLINER TR / STREAMLINER 85

Streamliner TR and Streamliner 85 are the recessed solutions within the Streamliner range. Streamliner TR can be finished without any visible trim, while Streamliner 85 has a small trim covering the hole in the ceiling. In both cases a homogenous line of light is all you see, as the profile completely disappears into the ceiling.

Fully lit corners allow you to play around with lines of light, creating unique patterns that strengthen the architecture of the building.

STREAMLINER 70S / 70L

Streamliner 70S and 70L can be used for surface mounted or suspended applications, both offering the possibility to be used as a direct-indirect or purely direct line of light. With its Dimensions of 70 by 85mm, Streamliner 70S has a more minimalistic look, while Streamliner 70L (70 by 108mm) enables to hide away an emergency unit inside its body.

STREAMLINER

www.deltalight.com/streamliner-profile



FAMILY OVERVIEW

CHOOSE YOUR COLOUR



Alu / Black / White

CHOOSE YOUR SETTING

Straight lines or with 90° corners

CHOOSE YOUR INSTALLATION

Recessed: with trim / trimless
Surface mounted
Suspended

CHOOSE YOUR LIGHT DISTRIBUTION

Down / Down-Up

CHOOSE YOUR OPTICS

Sandblasted / Prismatic

CHOOSE YOUR POWER

1900 lm/m / 3600 lm/m

CHOOSE YOUR CONTROL

Non Dim / 1-10V Dim / DALI Dim – Switch Dim

CHOOSE YOUR EXTRA'S

Tunable white
Accent modules: Downlight / Spot
Sensors: Presence / Daylight
Emergency unit

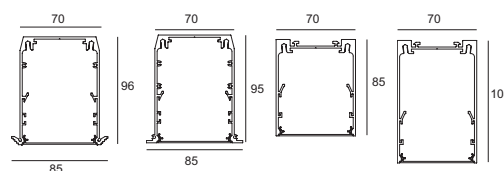







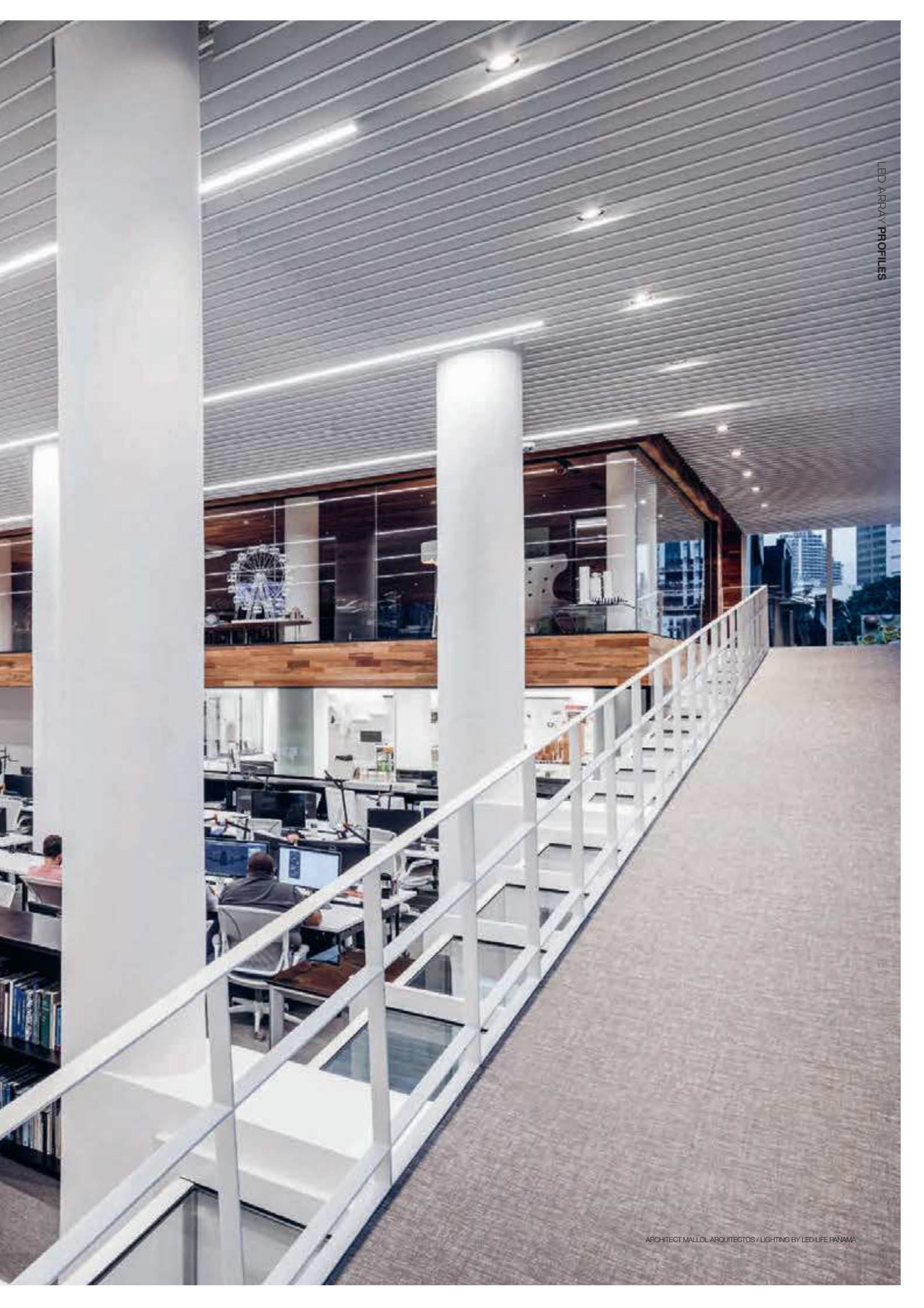

LED ARRAY PROFILES



ARCHITECT ATELIER LEYMARIE GOURDON / PHOTOGRAPHY BERTRAND FOMPEYRINE



ARCHITECT WALL ARCHITECTS / PHOTOGRAPHY ILVA IVANOV



SHELFLINE

A series of miniature profiles, to be finished with the ledflex of your choice. Ideal to softly enlighten shelves, cupboards, wardrobes or for other indirect lighting applications.

www.deltalight.com/shelfline-profile



FAMILY OVERVIEW

CHOOSE YOUR COLOUR



Anodized

CHOOSE YOUR INSTALLATION

Recessed / Surface mounted

POWER

9W/m – 610lm/m

CHOOSE YOUR LED COLOUR

2700K / 3000K / 4000K

CHOOSE YOUR CONTROL

Non Dim / Mains Dim / 1-10V Dim / DALI Dim









EXTERIOR

CEILING

RECESSED

NEW

REO X

P 586



780 - 1130lm



3 SIZES

NEW

DEEP RINGO X

P 592



780 - 1130lm



2 SIZES

CARREE X

P 598



810lm

SURFACE

EXTERIOR CEILING

BOXY

P 602



810 - 1620lm

DOX

P 608



960lm

SUPERNOVA XS X

P 612



900lm



2 SIZES

B-LINER IP

P 616



2300 - 4600lm



3 LENGTHS

LUMEN OUTPUT mentioned as indicative reach.

NEW

PAGE337

P 337

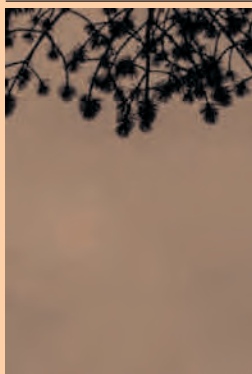



REO X

The Reo collection is more than one product, it is a family which offers a solution for many lighting demands, from residential to hotel, restaurant to retail and much more. In line with this philosophy, Reo comes in single and double fixtures, round or square, orientable or fixed, in multiple finishing colours, for both indoor and outdoor use. The design of these recessed conical spots delivers a hardly visible transition from the intense light to the ceiling, resulting in a halo-like effect, ideal to give the space an extra dimension.

www.deltalight.com/reo



FAMILY OVERVIEW

CHOOSE YOUR COLOUR



Alu Grey / Black / White

CHOOSE YOUR SIZE & POWER

Micro

7,1W – 810lm

Mini

6,1W up to 9W – 780 up to 1080lm

Reo

7,1W up to 10,4W – 810 up to 1130lm

CHOOSE YOUR OPTICS

Micro

35°

Mini

37°

Reo

33°

IP43

IP65

IP44

IP65

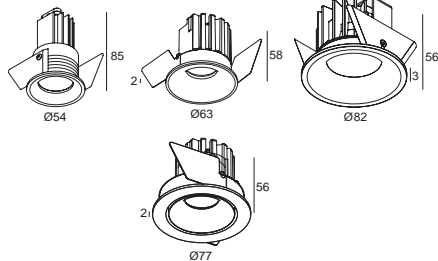









DEEP RINGO X

The conical shaped design of the Deep Ringo fixtures and the deeper placed LED source make sure that glare is reduced to a minimum when Deep Ringo is installed in the ceiling. The small trim gives a refined touch to this elegant luminaire.

www.deltalight.com/deep-ringo



FAMILY OVERVIEW

CHOOSE YOUR COLOUR



Black / White

CHOOSE YOUR SIZE

Mini Deep Ringo II X

Deep Ringo X

CHOOSE YOUR POWER

Mini

6,1W up to 9W – 780 up to 1080lm

Deep Ringo

7,1W up to 10,4W – 810 up to 1130lm

CHOOSE YOUR LED COLOUR

2700K / 3000K

CHOOSE YOUR OPTICS

Mini

37°

Deep Ringo

33°

IP65

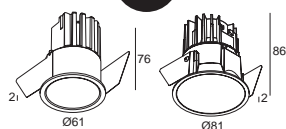



EXTERIOR CEILING

Find the other members of this family **INTERIOR CEILING.**

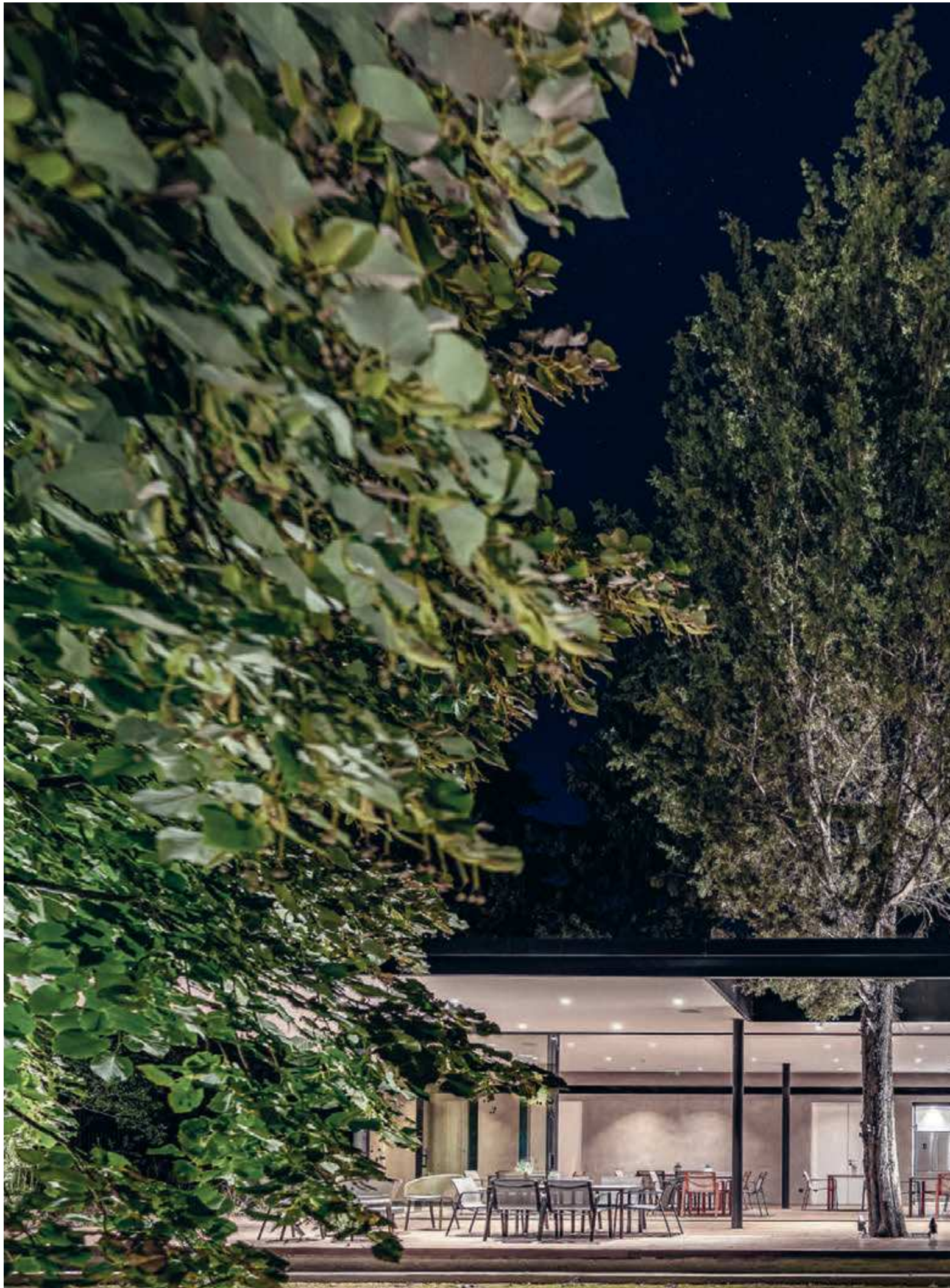





ARCHITECT GEORGE MORENO & PARTNERS / LIGHTING DESIGN LED LIFE PANAMA



CARREE X

The Carree range is Delta Light's answer for easy-to-install, timeless and functional recessed spots, as it has been a Delta Light classic for many years.

This family of square recessed luminaires offers refined solutions for LED or halogen, either with or without trim. The straight lines in the design make a contemporary spot out of Carree, not only useful in modern architecture but also in many other applications.

Carree can be used throughout the entire project, as it also includes IP44 solutions for bathrooms and IP65 luminaires for outdoor use.

www.deltalight.com/carree



FAMILY OVERVIEW

CHOOSE YOUR COLOUR

Alu Grey / Dark Grey / White

POWER

7,1W - 810lm

OPTICS

33°

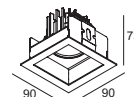

EXTERIOR CEILING



Find the other members of this family **INTERIOR CEILING.**







BOXY

What once began as a cubic luminaire is now an elaborate family of surface mounted luminaires, both cubic and cylindrical shaped.

Though different in shape, still uniform in look, as both shapes have a deeper recessed LED module with a conical, coloured insert in front. While the deeper recessed LED module reduces the glare, the choice in colour creates possibilities for playful and attractive lighting solutions.

Alongside the different shapes, this family offers indoor and outdoor luminaires, a perfect solution when recessing is not an option.

www.deltalight.com/boxy





FAMILY OVERVIEW

CHOOSE YOUR COLOUR



Black / White / White-Black

CHOOSE YOUR SHAPE & SIZE



Round - Square / Single or Double

CHOOSE YOUR POWER

Round
10,4W - 1120lm

Square
Single 7,1W - 810lm
Double 2 x 7,1W - 810lm

OPTICS

33°

CONTROL

Mains Dim

IP53

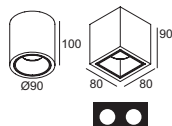



ARCHITECTS DARIO STUDIO - ARQ. HENNY DIAZ



ARQUITECTUM & CRESPO ARQUITECTOS

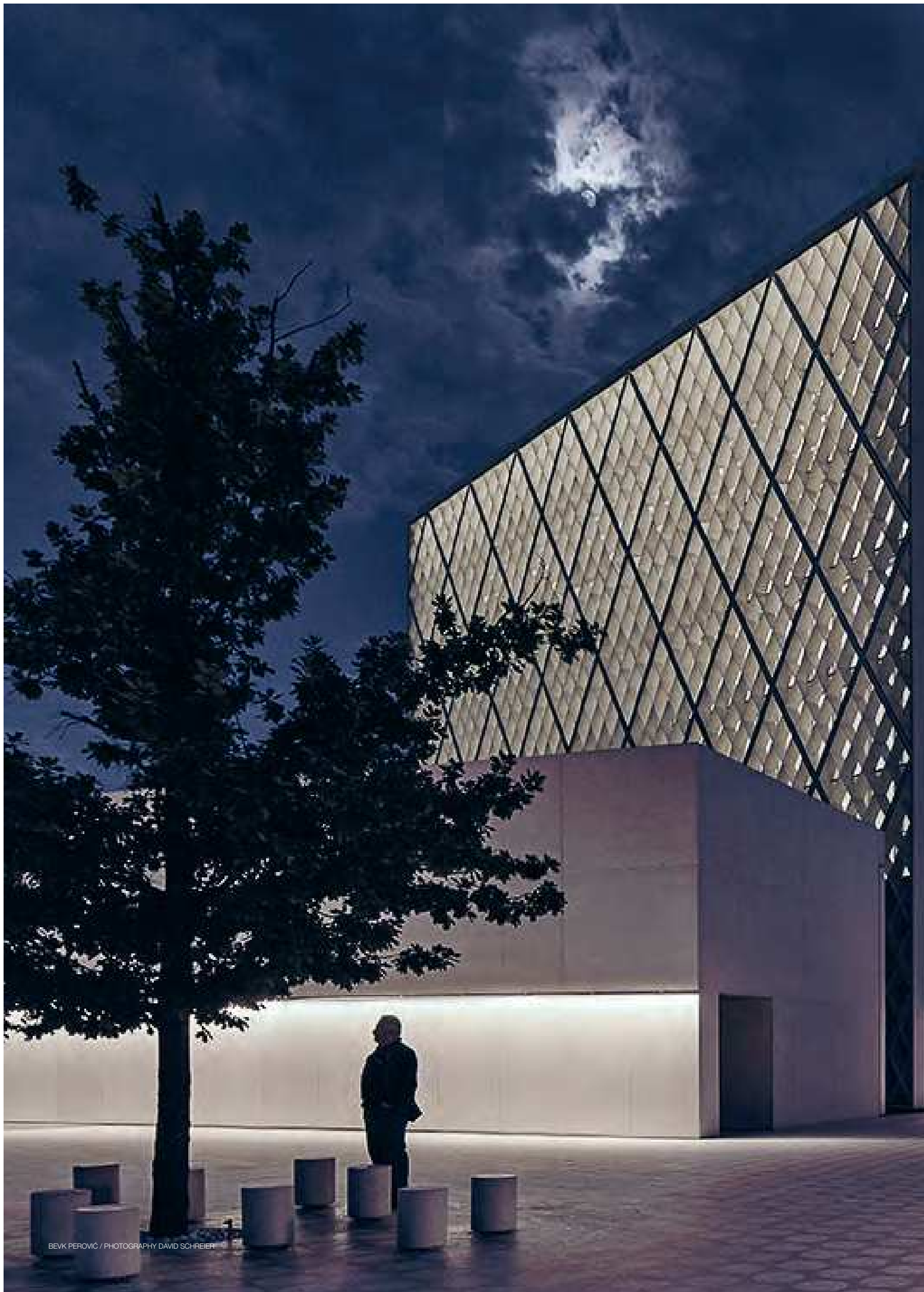



DOX

Dox is a well-known member of the Delta Light outdoor range. Initially designed as a halogen solution, Dox now is a set of IP65 LED luminaires perfect for exterior use. The Dox range consists of a fixed downlight or the elegant wall version with a powerful direct-indirect light effect.

www.deltalight.com/dox



FAMILY OVERVIEW

COLOUR



Dark Grey

POWER

8W – 960lm

OPTICS

35°

IP65

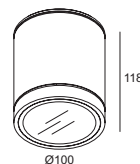

EXTERIOR CEILING

Find the other members of this family **EXTERIOR WALL**







interior
innovation
award



reddot design award
winner

Winner

— AWARD —
GOOD DESIGN PLUS
light+building



SUPERNOVA XS X

Supernova is an extensive range of pure geometrically formed lighting fixtures that guarantee powerful illumination and atmosphere. The range comes in different diameters and application possibilities.

With its 26 cm or 33 cm diameter, the Supernova XS (Extra Small) can be considered to be the baby in the range when it comes to size, but not when it comes to performance and skills. It only needs 6 cm of height to hide away an intense cluster of powerleds in its perfectly curved aluminium body.

www.deltalight.com/supernova-xs



FAMILY OVERVIEW

CHOOSE YOUR COLOUR

Dark Grey / White

CHOOSE YOUR VERSION

Fix or Adjustable

POWER

10W - 900lm

IP64

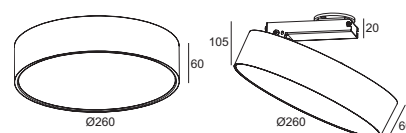



ARCHITECT BERT MASSELUS

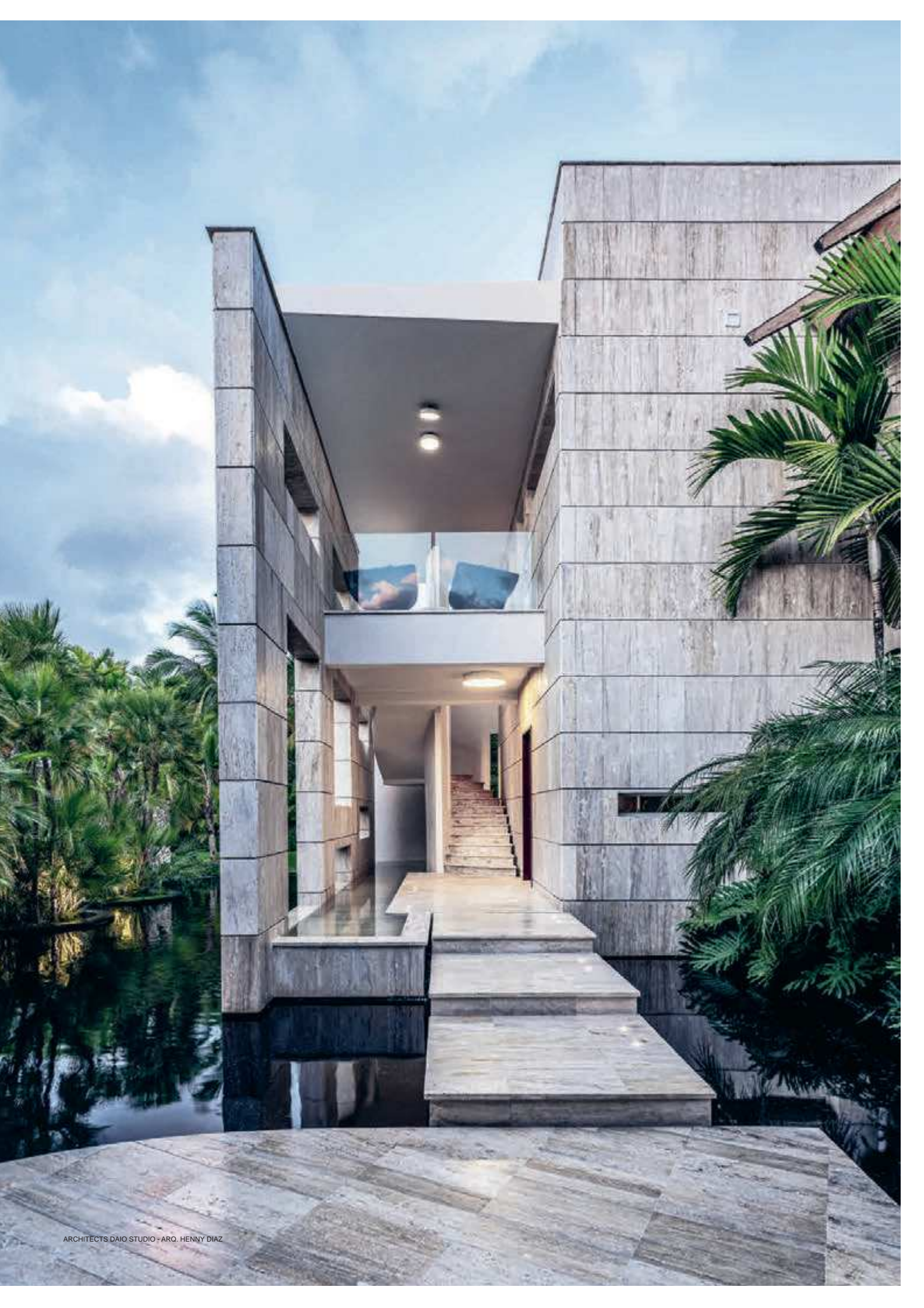



B-LINER IP

With its IP65 rating - to avoid water ingress inside the profile - and its robust looks, B-Liner is your go-to linear lighting solution for outdoors. Available in 3 sizes and 3 finishing colours, B-Liner offers an answer for multiple exterior applications: create a long line of light or opt for a playful setting with different lengths, B-Liner will perform!

www.deltalight.com/b-liner



FAMILY OVERVIEW

CHOOSE YOUR COLOUR



Alu Grey / Dark Grey / White

CHOOSE YOUR LENGTH & POWER

580 mm / 14W - 2300lm

860 mm / 22W - 3450lm

1140 mm / 29W - 4600lm

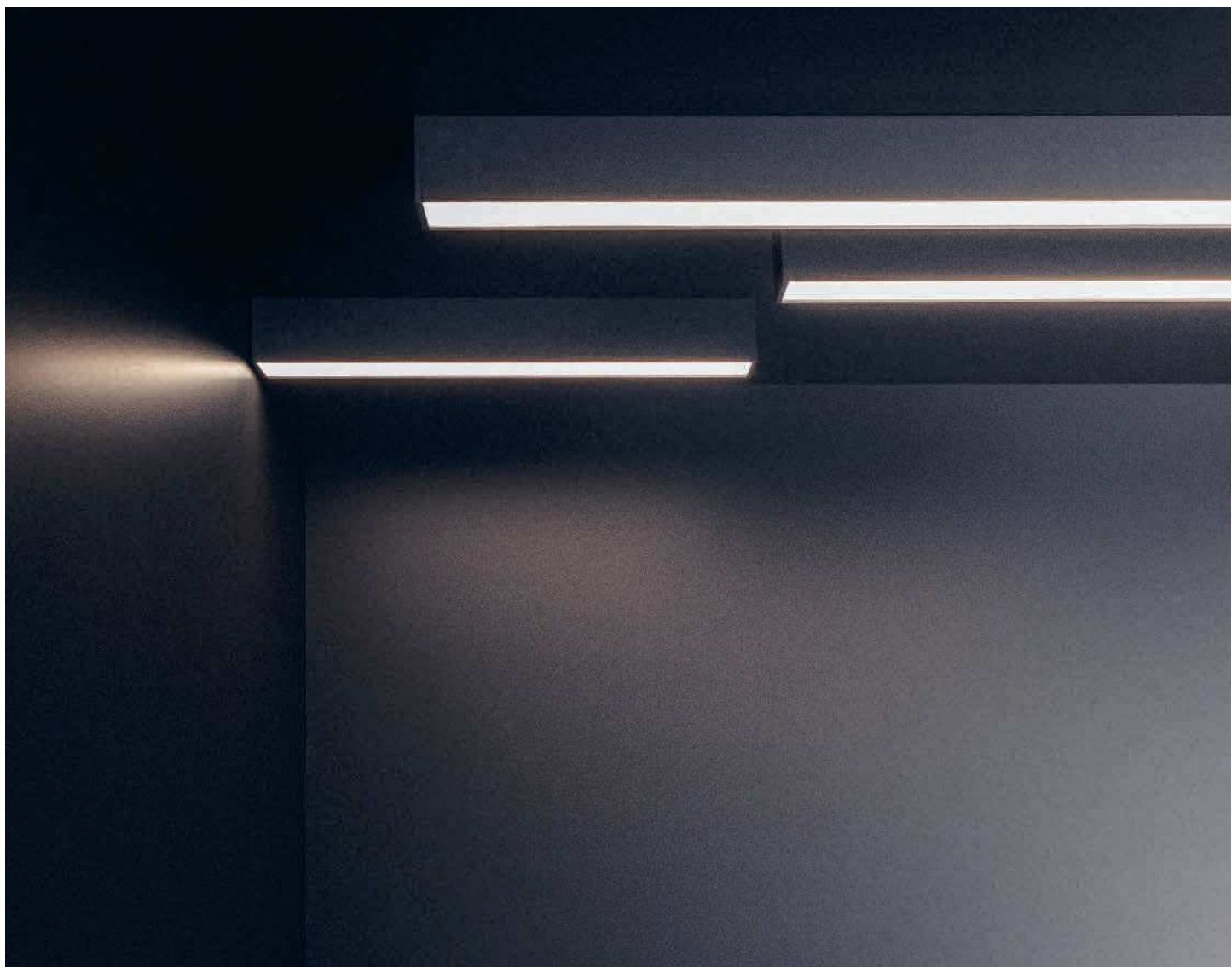
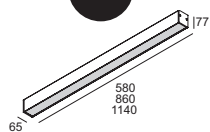







EXTERIOR

WALL

RECESSED

LOGIC W

P 626



LEDS C / GO

P 630

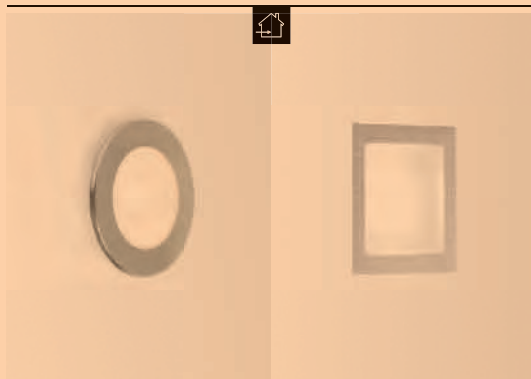

HELI

P 634



SURFACE

STIP

P 640

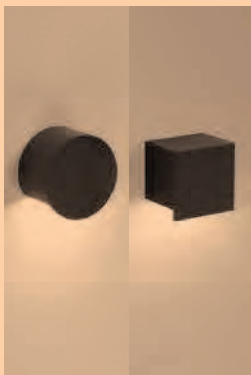

NEW

SKOV

P 644



2 SIZES

TOPIX

P 648



NEW

BACKSPACE II

P 652

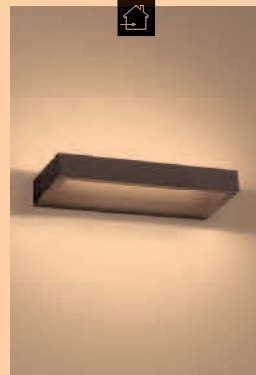

NEW

WALKER II

P 656



2 SIZES

VISION OUT

P 660



TIGA

P 664



MOMBA

P 668



MONO II

P 672



WANT-IT X

P 676



MONTUR

P 680



NEW

SPY 39 W

P 686



DOX

P 690



ULTRA X

P 692



SOIREE W

P 698

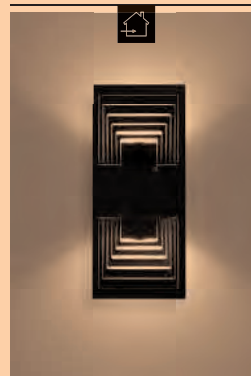

NEW

PAGE337

P 337



LOGIC W

As a family of guidance lights, Logic W exists out of small and large wall luminaires to be installed slightly above ground level. As such, they provide a soft glow on the floor to guide you along pathways or in corridors, both in- and outdoors.

www.deltalight.com/logic-w



FAMILY OVERVIEW

CHOOSE YOUR COLOUR



Alu Grey / Dark Grey / White

CHOOSE YOUR SHAPE & SIZE



Round / Square / Rectangular

Small / Large

CHOOSE YOUR POWER

Small

0,6W - 40lm

Large

7,1W up to 9W - 800 up to 1480lm

IP54

IP65

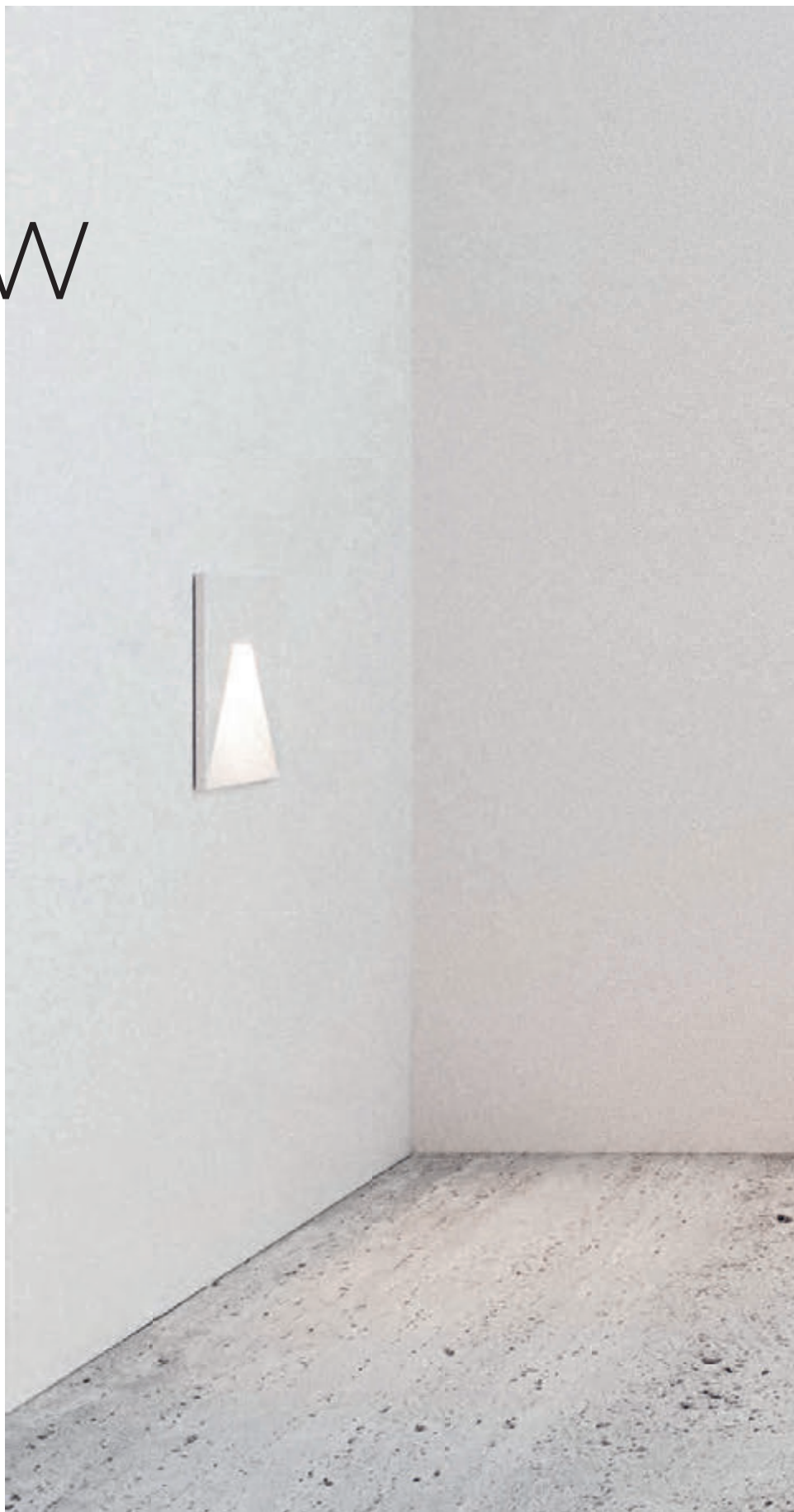
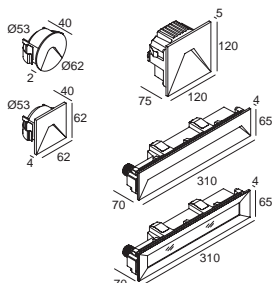





DEHULLU ARCHITECTEN



LEDS C / GO

This family offers some miniature fixtures that serve as orientation and atmosphere lighting. Available in round and square, these little dots of light are perfect as guidance lights. While Leds C II can be used indoors - for example as safety light in corridors and hallways -, Leds C R ST and Leds Go will guide the way outdoors - along paths and driveways.

www.deltalight.com/leds-c
www.deltalight.com/leds-go



FAMILY OVERVIEW

CHOOSE YOUR COLOUR



Anodized aluminium

POWER

1,1W – 130lm

CHOOSE YOUR LED COLOUR

3000K / 4000K

IP67

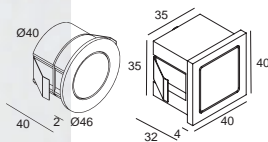



EXTERIOR WALL

Find the other members of this family **INTERIOR WALL / EXTERIOR FLOOR**





HELI X

As a small wall recessed luminaire, Heli is perfect as a guidance light. Be it in a corridor or as a safety light for the steps of your stairs at night, Heli does the trick. Also outside, Heli X will guide you the way.

www.deltalight.com/heli



FAMILY OVERVIEW

CHOOSE YOUR COLOUR



Alu Grey / Dark Grey

POWER

1,1W - 130lm

CHOOSE YOUR LED COLOUR

3000K / 4000K

IP54

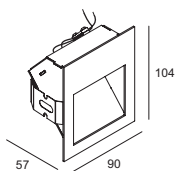





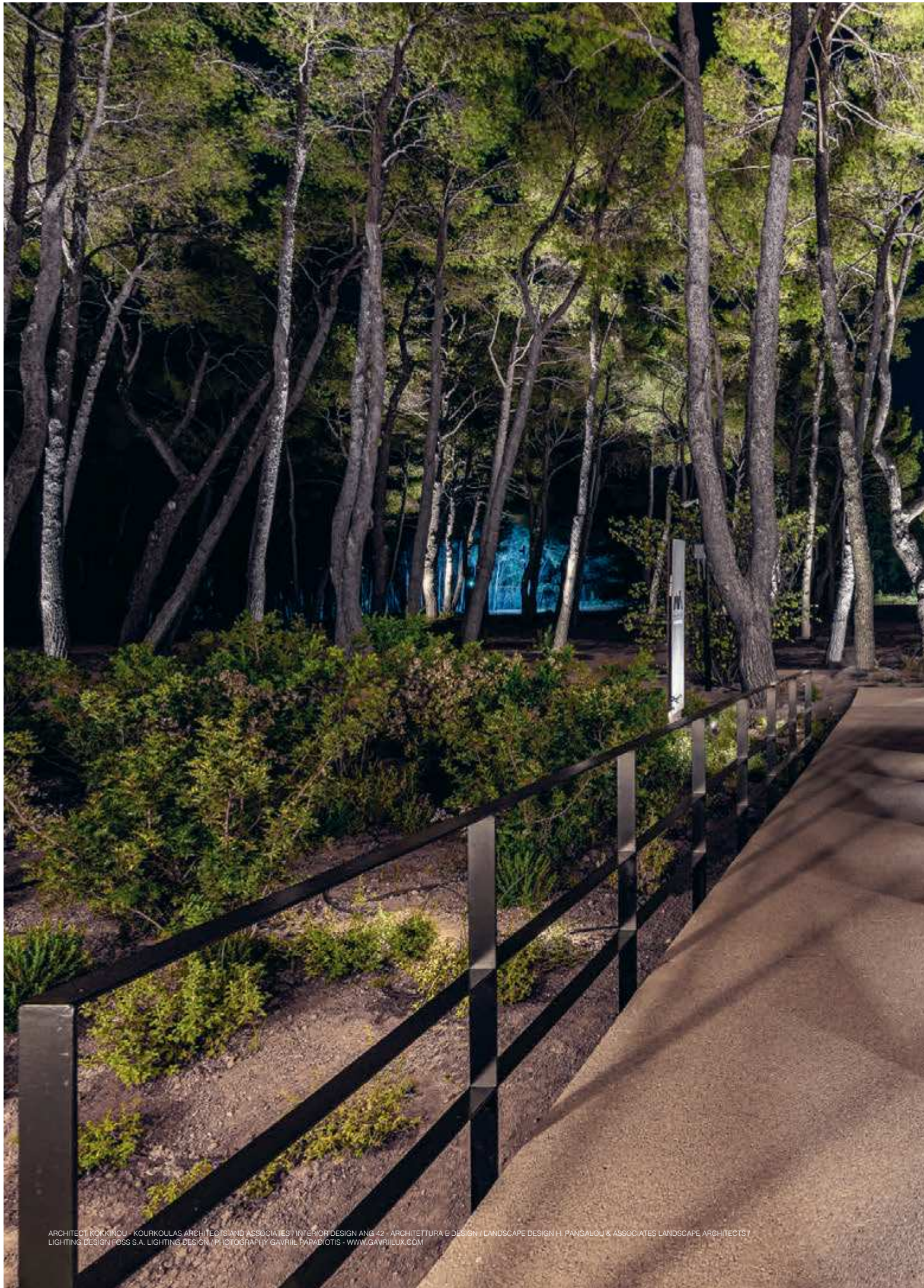





STIP

With Stip, you choose for either a round or square surface mounted wall luminaire for outdoor use. The round one can be used for general lighting, while the square version has an inhouse developed lens that throws the light to both sides, generating a line of light that is ideal to enlighten a pathway.

www.deltalight.com/stip





FAMILY OVERVIEW

CHOOSE YOUR COLOUR



Alu Grey / Dark Grey

CHOOSE YOUR SHAPE

Round / Square

POWER

3,9W - 420lm

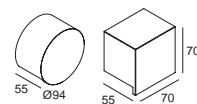





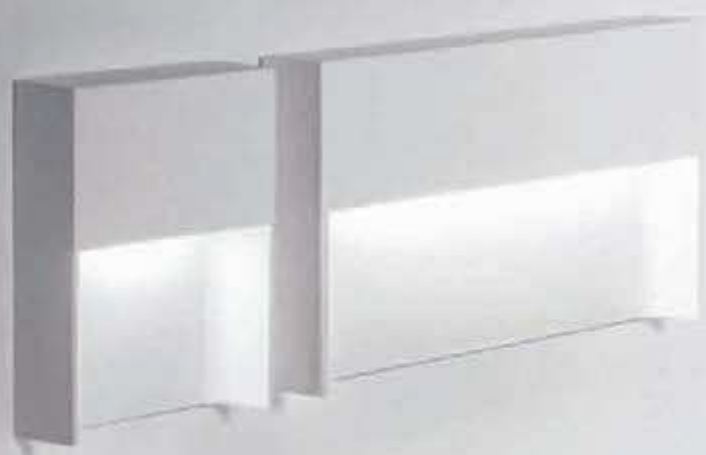

SKOV

LIGHT AS A GUIDE

Skov is perfect as a guidance light, both for in- and outdoors.

The luminaire stands out in slenderness, with only 32mm of thickness for a surface mounted wall application with integrated power supply.

The combination of a recessed LED array with the specific design of Skov generates visibility along the path without being obtrusive for the passer-by.

The light leaving the luminaire gently falls onto the veil of Skov, revealing a soft light effect to guide you wherever the path may take you.

www.deltalight.com/skov



FAMILY OVERVIEW

CHOOSE YOUR COLOUR



Alu Grey / Dark Grey / White

CHOOSE YOUR SIZE & POWER

Small

3,7W - 480lm

Medium

10,4W - 1260lm

CHOOSE YOUR LED COLOUR

2700K / 3000K

IP54

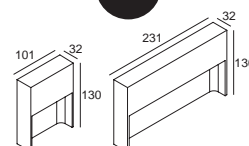









EXTERIOR WALL

Find the other members of this family **INTERIOR WALL**.

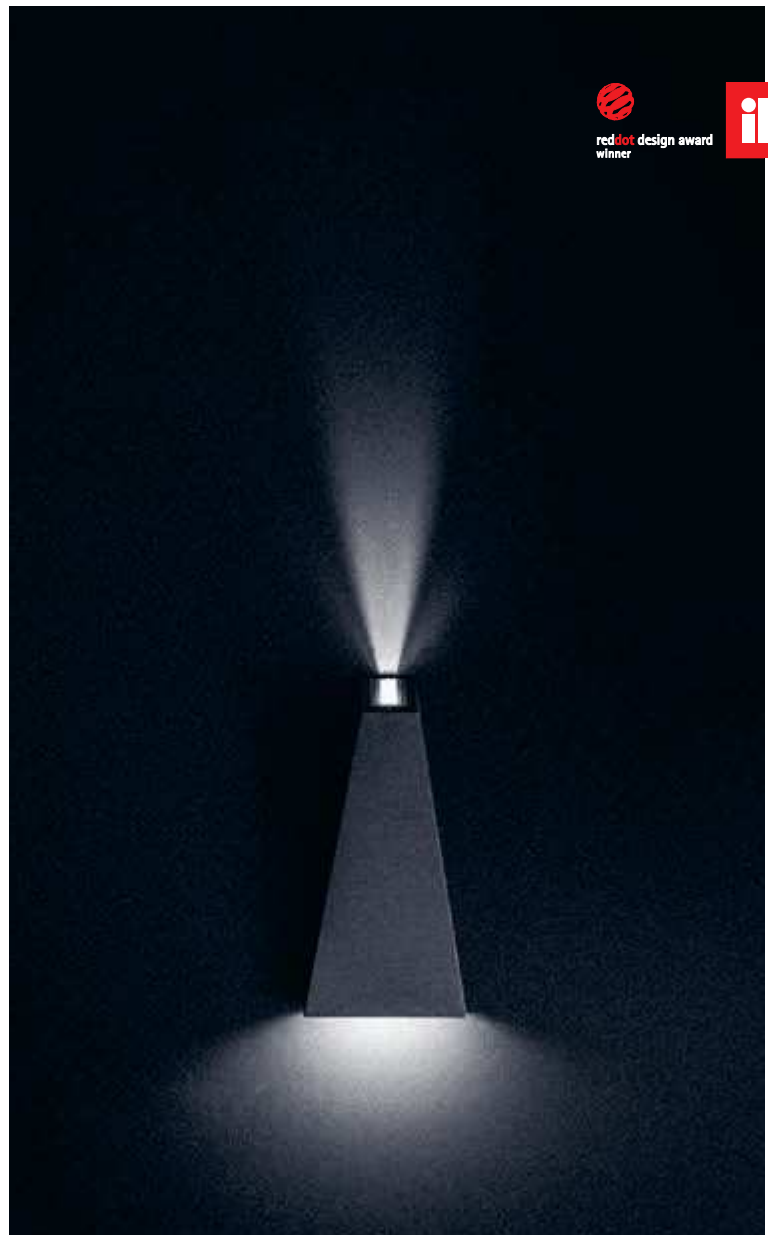

TOPIX

This multi award-winning luminaire ensures a playful effect and offers a lot of freedom. On its own, Topix wows you with its peculiar yet attractive design, when put together, you can create artistic clusters of light. Topix comes for in- and outdoors, giving you the opportunity to make your façade stand out.

www.deltalight.com/topix



FAMILY OVERVIEW

CHOOSE YOUR COLOUR



Alu Grey / Grey Brown

POWER

2 x 3,5W - 270lm

IP55

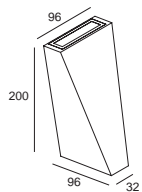



M2 ARCHITECTURAL GROUP, ALEXANDER ZHIDKOV





In many ways, Backspace II is a joy for the eye, be it by its slender design, by its pleasant light effect or by its playful colour combinations. Backspace II is designed to create a 2-way light effect on the wall, the choice to install it in a horizontal or vertical way is up to you.

By mounting the light source in the front part of the luminaire, it is perfectly shielded from looking directly into the source.

Backspace II can be used for interior lighting in a white, grey or dark grey finish or for outdoor settings in grey or dark grey.

www.deltalight.com/backspace-ii



FAMILY OVERVIEW

CHOOSE YOUR COLOUR



POWER

10,4W - 1260lm

CHOOSE YOUR LED COLOUR

2700K / 3000K

IP54

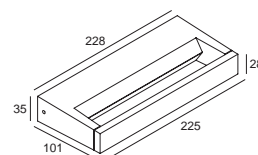

BACKSPACE II



And now we're back, from outer space

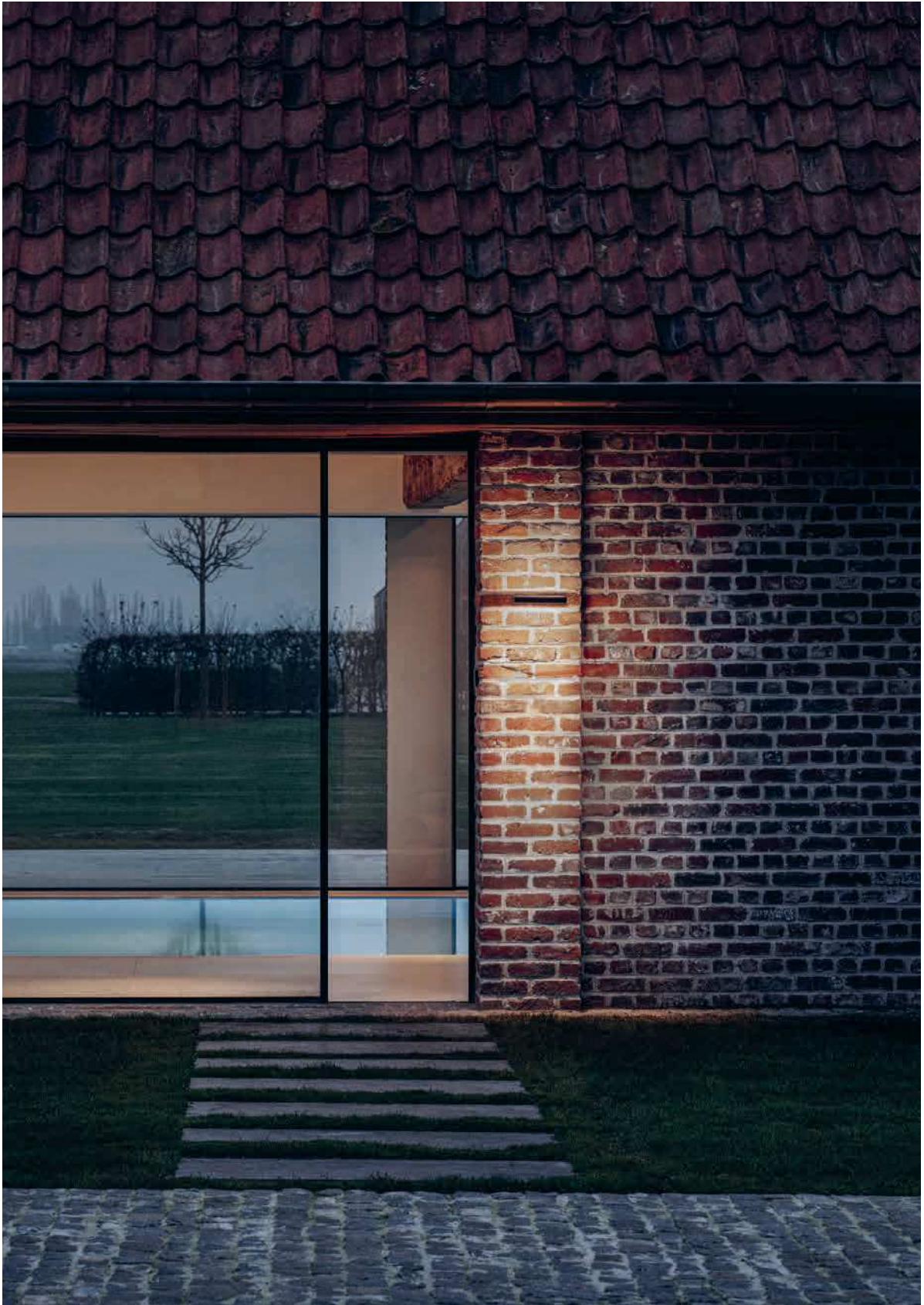



WALKER II

SPLIT THE LIGHT

Walker II splits the light open. Starting from 1 light source, Walker II is designed to guide the light into two directions to provide a double light effect on the surface below.

The light falls on the V-shaped inner part of the luminaire, breaking it open and throwing it to the front- and backside of the luminaire.

Walker II can serve as a guiding light on your wall or pathway, as it comes as a wall luminaire and as a bollard.

Different sizes, different heights and multiple colour combinations can be combined to your preference to create the perfect setting.

www.deltalight.com/walker-ii



FAMILY OVERVIEW

CHOOSE YOUR COLOUR



Alu Grey / Dark Grey

Alu Grey-Dark Grey / Dark Grey-Gold Coloured

CHOOSE YOUR POWER

3,7W - 480lm / 6,2W - 790lm

CHOOSE YOUR LED COLOUR

2700K / 3000K

IP54









VISION OUT

Since its launch, Vision has already won multiple awards, thanks to its impressive and nicely delineated parabolic light pattern on the wall. This classic is available both for indoor and outdoor use. Vision thanks its powerful light effect to the combination of LED technology in combination with a lens, giving its unique design and playful light effect.

www.deltalight.com/vision



FAMILY OVERVIEW

CHOOSE YOUR COLOUR



Alu Grey / Dark Grey

CHOOSE YOUR LIGHT EFFECT

Down / Down-Up

POWER

2 x 1,4W - 180lm

IP55

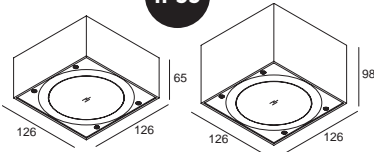

EXTERIOR WALL

Find the other members of this family **INTERIOR WALL**.





ERGINOĞLU & ÇALIŞLAR ARCHITECTS



TIGA

A medium sized rectangular lighting fixture, delivering a pleasant up and downward light effect on your wall. As a surface mounted wall unit,

Tiga is perfect for both residential use or for hospitality usage in hotels and restaurants.

Standard, Tiga creates a wide beam effect for both down- and uplight, while Tiga BS allow you to play with a combination of a wide and small beam effect within 1 luminaire.

Despite its IP65 rating for outdoor use, this unit also feels very comfortable when used indoors.

www.deltalight.com/tiga



FAMILY OVERVIEW

CHOOSE YOUR COLOUR



Alu Grey / Grey Brown / White

CHOOSE YOUR LIGHT EFFECT

Wide beam for both down & up

Wide + Small beam combination

POWER

7,1W - 810lm

CHOOSE YOUR LED COLOUR

2700K / 3000K

CHOOSE YOUR CONTROL

Mains Dim

IP65

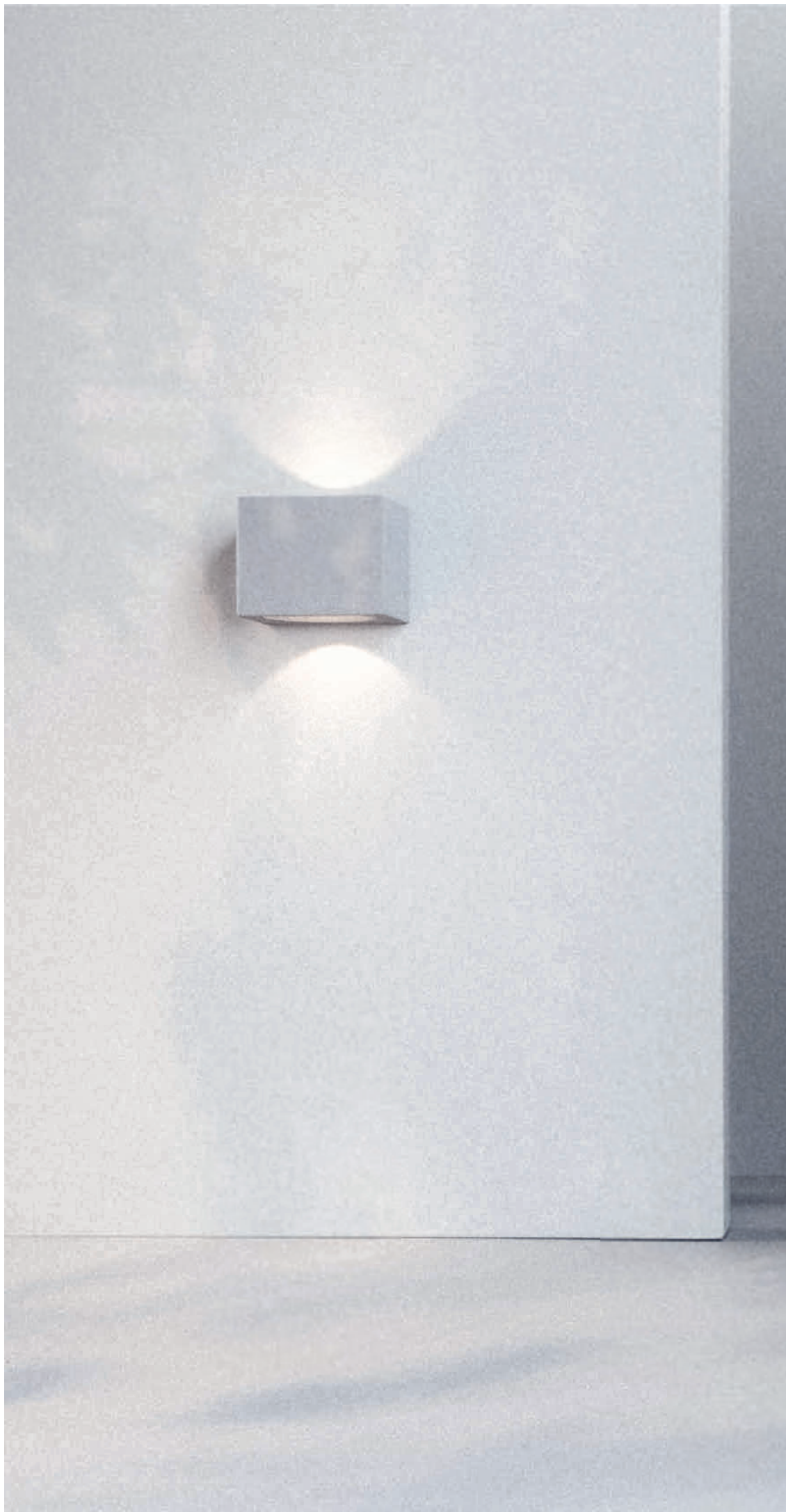
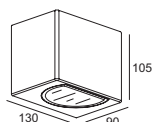



EXTERIOR WALL

Find the other members of this family **INTERIOR WALL.**





MOMBA

At first sight, Momba looks very straightforward. But despite its simple looks, Momba offers more than meets the eye. Its outer shell shows some sophisticated detailing, visible in the rounded corners and its optical compartment. The convex lenses create a small line of light or a general wide beam, as downlight only or down-up light.

www.deltalight.com/momba

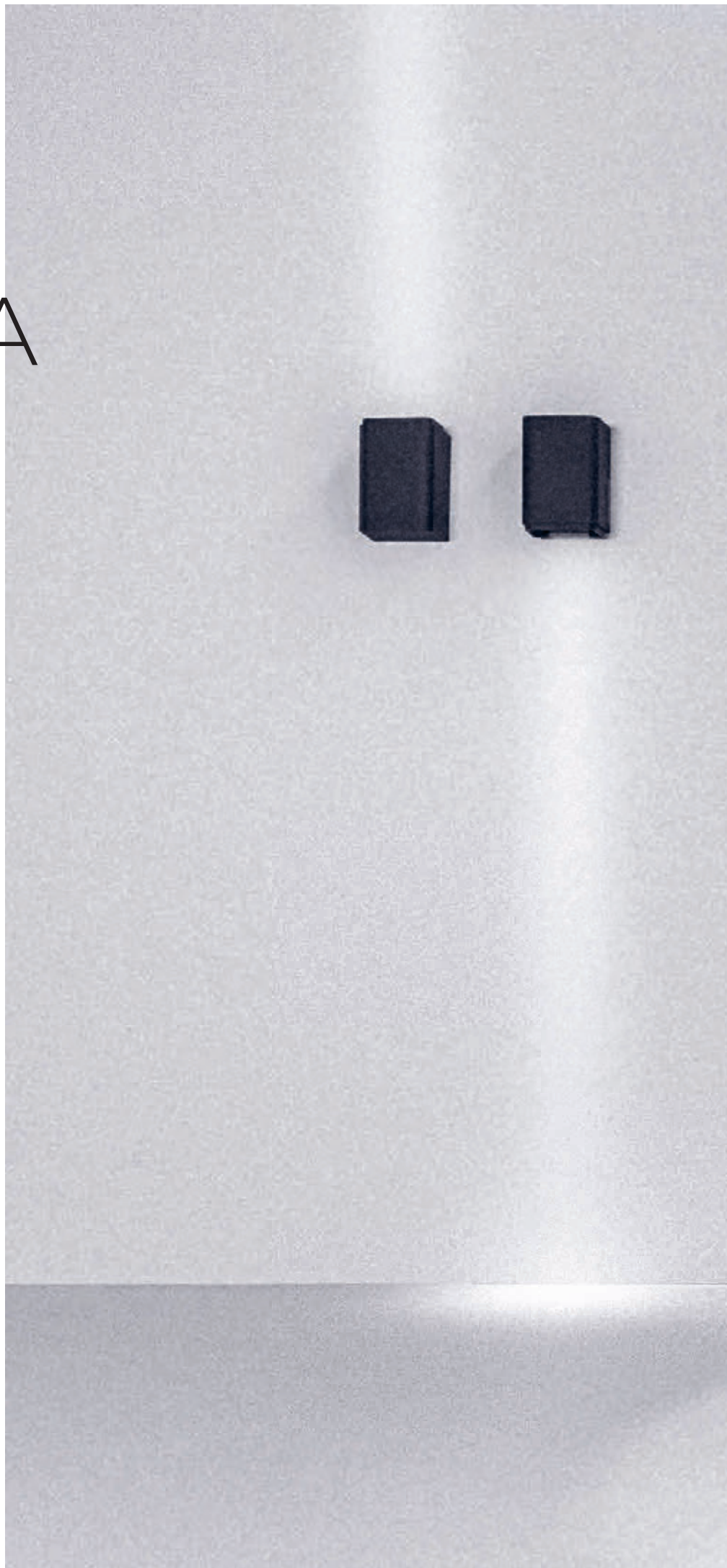

FAMILY OVERVIEW

COLOUR



Dark Grey

CHOOSE YOUR LIGHT EFFECT

Down / Down-Up

Wide beam / Small beam

POWER

Down

2W up to 7,1W – 245 up to 810lm

Down-Up

2 x 2W up to 7,1W – 245 up to 810lm

IP65

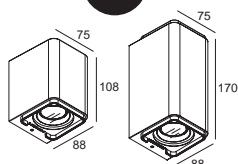







MONO II

Mono is a well-known member of the Delta Light outdoor range. It was the first outdoor wall fixture within the range that combines a LED module with a lens, resulting in a far-reaching and strongly delineated lighting effect. The Mono's timeless and sharp contoured design adds a contemporary touch to any façade.

www.deltalight.com/mono-ii



FAMILY OVERVIEW

COLOUR



Alu Grey / Dark Grey

CHOOSE YOUR LIGHT EFFECT

Down / Down-Up

POWER

Down

7,1W – 810lm

Down-Up

2 x 7,1W – 810lm

IP54

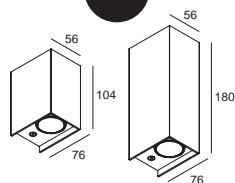







WANT-IT X

Want-it is a vivid range of wall luminaires, available for both interior and exterior use. The streamlined and timeless design gives it a very flat and low-impact appearance, with no visible screws. The slightly curved edges provide a subtle twist to the design, while also creating a nicely delineated light pattern on the wall.

The Want-it comes in a square and rectangular shape. While the exterior version comes in a dark grey finish, the interior version is available in all white or a more decorative black and matt gold combination.

www.deltalight.com/want-it



FAMILY OVERVIEW

COLOUR

Dark Grey

POWER

2 x 4,7W – 540lm

CHOOSE YOUR LED COLOUR

2700K / 3000K

IP55

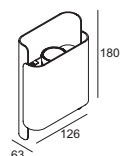

EXTERIOR WALL

Find the other members of this family **INTERIOR WALL**.

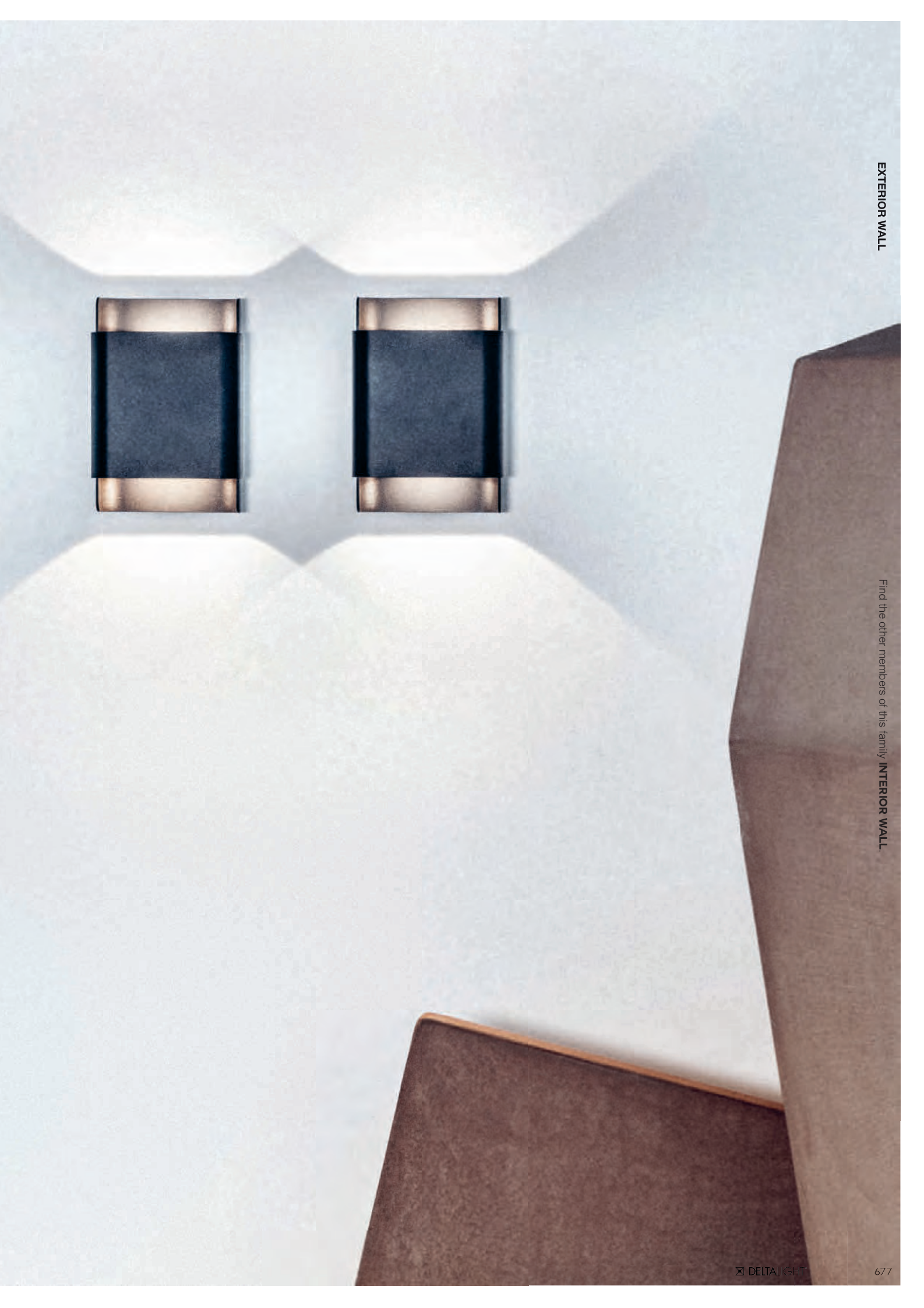



ARCHTECT BADR 5

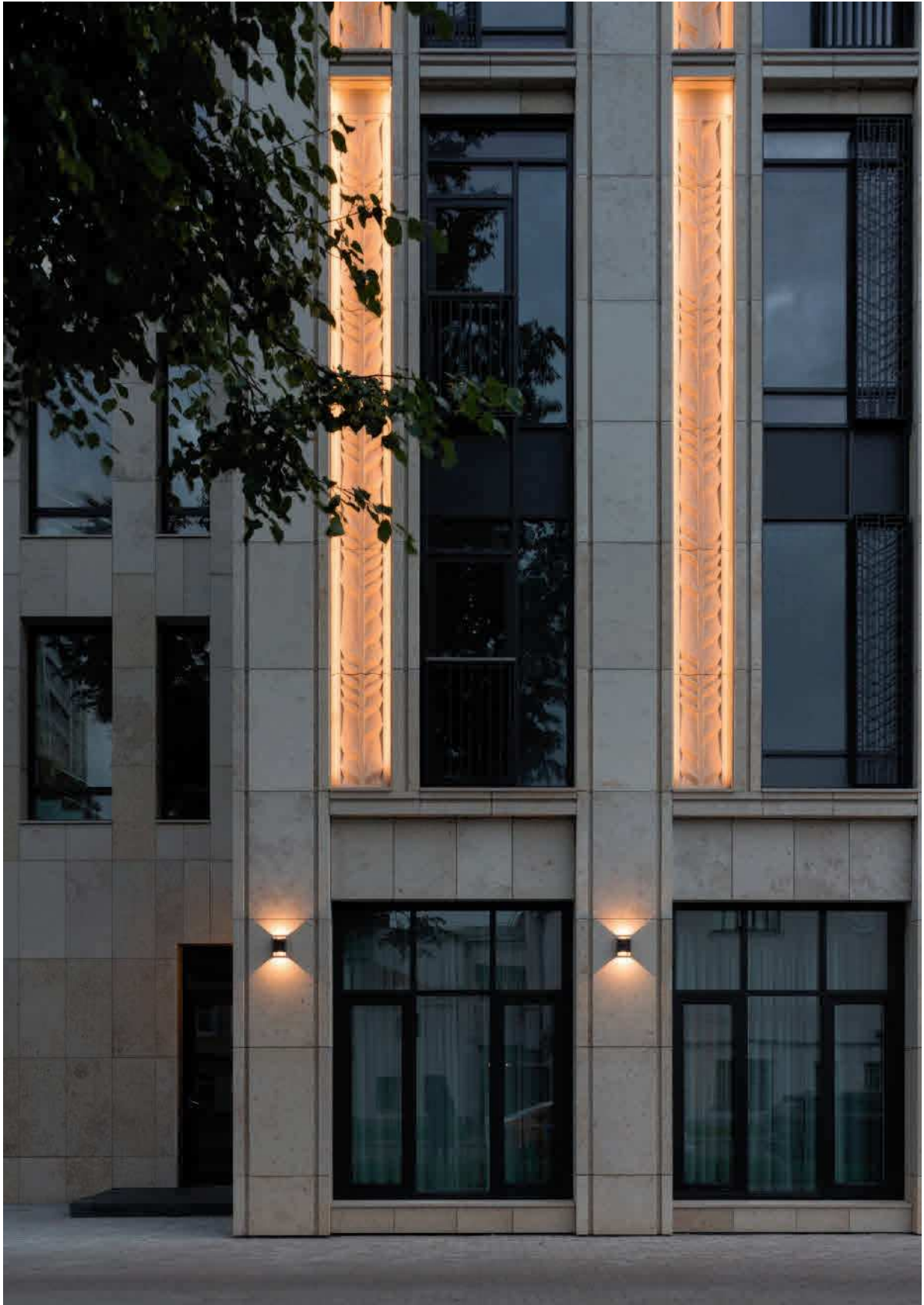



MONTUR

With Montur we offer a highly original interpretation of an archetypical concept: a light source that is contained within the framing of a 3D square or rectangular shape. The Montur is available in indoor and outdoor versions, as a ground, wall or ceiling fixture, with LED clusters or filament-LED lamps with a rustic look.

The series integrates beautifully in both country-classic and contemporary homes, and is suitable for hotels and public buildings as well.

www.deltalight.com/montur



FAMILY OVERVIEW

COLOUR



Black

CHOOSE YOUR SHAPE & SIZE



Round / Square / Rectangular
Small / Medium / Large

CHOOSE YOUR LIGHT SOURCE

Integrated LED / E27

CHOOSE YOUR POWER

4,2W up to 14W – 590 up to 2300lm

CHOOSE YOUR LED COLOUR

2700K / 3000K

IP65

IK07

IP54

IK08

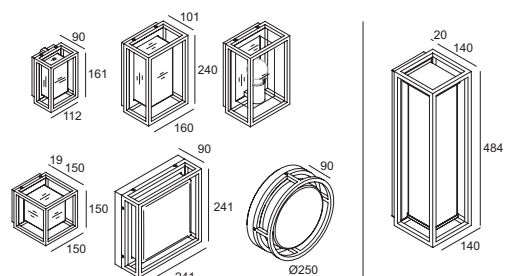



The Montur not only breathes new life into a classic concept, it also adds a detailed element of refinement. The sharply profiled framing in aluminium is utterly devoid of welding seams. For both the indoor and outdoor versions, there is a choice of finishing with either hand pressed transparent or opal glass.

The opal glass version contains a milky, cone shaped core, with a transparent glass surface, creating a pleasantly diffused light that gives the lamp extra cachet.

The indoor version of the Montur is also available as an open cube, with one or two bulbs, or in a rectangular shape with a powerful LED cluster concealed behind a protective cover in polycarbonate.

By using them as outdoor fixtures, you can extend your lighting style into the garden or parking area. The outdoor versions are available in the same models as the indoor ones, but always feature a protective cover in glass or polycarbonate. There is also a bollard version, with a choice of various heights.



ARCHITECT ANARCHITECT / PHOTOGRAPHY LUCA CIOCI







SPY 39 W

Spy 39 W translates elegance and finesse into an outdoor wall light. Composed as a slender cylinder, Spy 39 W is available as a minimalistic down- or down-up luminaire. Despite its refined design, Spy 39 W succeeds in adding body to your exterior with its prolonged tubes and distinctive light effect.

www.deltalight.com/spy-39



FAMILY OVERVIEW

CHOOSE YOUR COLOUR



Black

CHOOSE YOUR LIGHT EFFECT

Down / Down-Up

POWER

Down or Up
3,9W – 390lm

Down-Up
2 x 3,9W – 390lm

CHOOSE YOUR LED COLOUR

2700K / 3000K

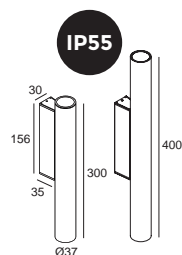







DOX

Dox is a well-known member of the Delta Light outdoor range. Initially designed as a halogen solution, Dox now is a set of IP65 LED luminaires perfect for exterior use. The Dox range consists of a fixed downlight or the elegant wall version with a powerful direct-indirect light effect.

www.deltalight.com/dox



FAMILY OVERVIEW

COLOUR



Dark Grey

CHOOSE YOUR LIGHT EFFECT

Down / Down-Up

POWER

Down

9W - 1070lm

Down-Up

2 x 9W - 1070lm

CONTROL

Mains Dim

IP65

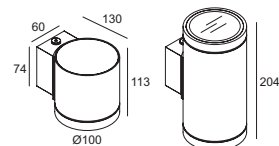



EXTERIOR WALL

Find the other members of this family **EXTERIOR CEILING**

ULTRA X

The looks of Ultra are very straightforward: its small mounting bracket is perfectly hidden away behind the compact tubular shape of the luminaire. Mounted on the wall, it creates a comfortable down or down-up effect onto the façade.

www.deltalight.com/ultra



FAMILY OVERVIEW

CHOOSE YOUR COLOUR



Alu Grey / Dark Grey / White

CHOOSE YOUR LIGHT EFFECT

Down / Down-Up

POWER

Down

7,1W – 810lm

Down-Up

2 x 7,1W – 810lm

IP55

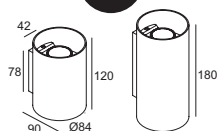



EXTERIOR WALL





ARCHITECT MCKIMM / PHOTOGRAPHYDEREK SWALWELL





SOIREE W

The Soiree range was designed to be voluminous, lightweight and transparent. Its sophisticated form creates a dense and decorative effect, filled with a warm light.

The interaction between the pure circular and rectangular forms, with the warm light sources and the symmetric configurations, triggers a dynamic tension. The Soiree takes its inspiration from many angles. From the play of light and shadow in architecture, to natural light effects, the shape of everyday objects and sculptural art.

The result is a nest of light, made of circles or rectangles, both structural and decorative, generating a seductive luminous effect.

www.deltalight.com/soiree





FAMILY OVERVIEW

COLOUR



Black

CHOOSE YOUR SHAPE & LIGHT EFFECT

Round

Square

Up or Down-Up

POWER

Up: 3W – 280lm

Down-Up: 2 x 3W – 280lm

CHOOSE YOUR LED COLOUR

2700K / 3000K

IP54

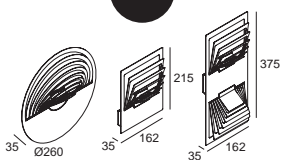

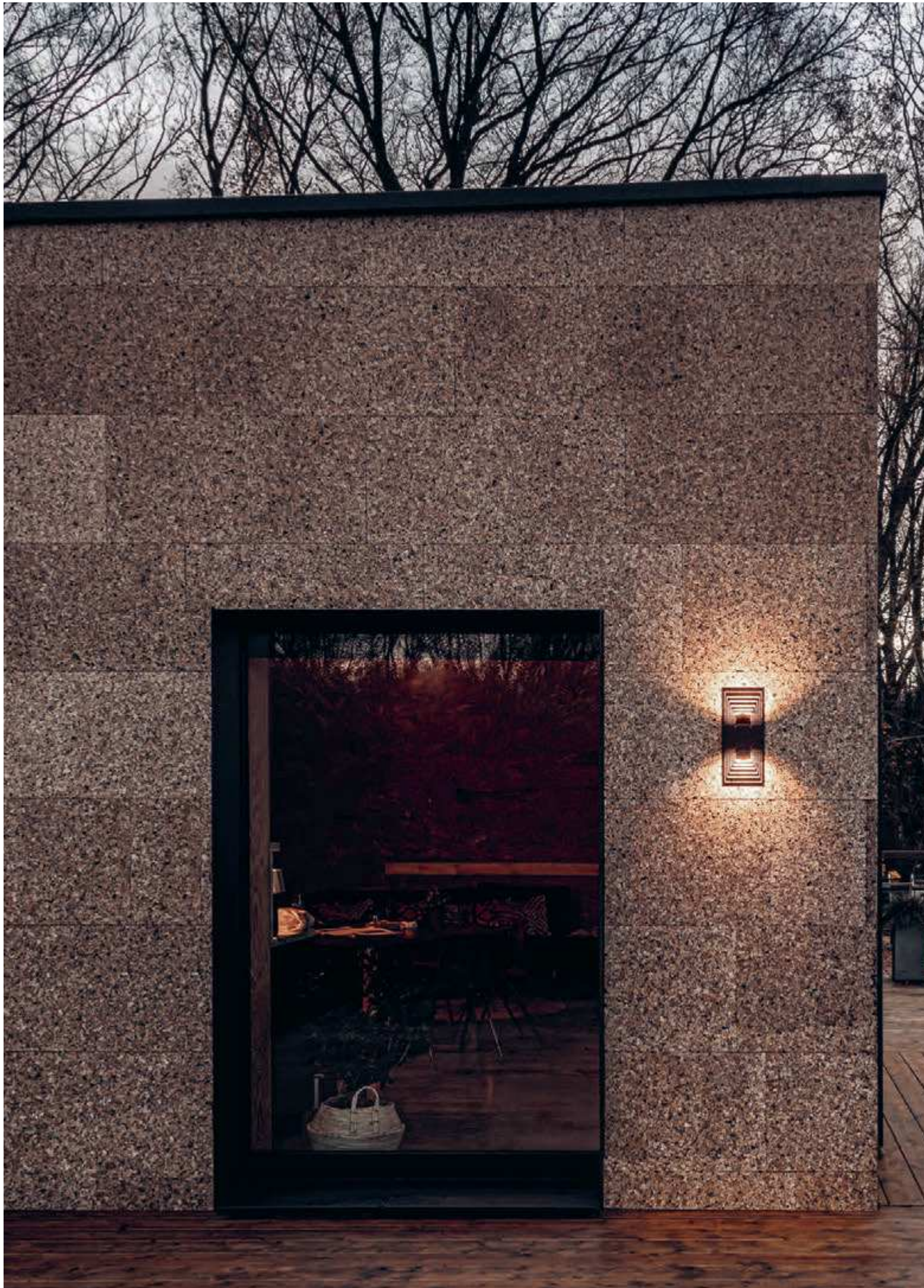





The image features several large, angular, light-brown geometric blocks on a white surface against a light blue background. One block is a large triangle on the left, another is a trapezoid in the center, and a third is a rectangular block on the right. The lighting is soft, creating subtle shadows and highlights on the surfaces of the blocks.

EXTERIOR

FLOOR

RECESSED

EXTERIOR FLOOR

NEW
LOGIC
P 708

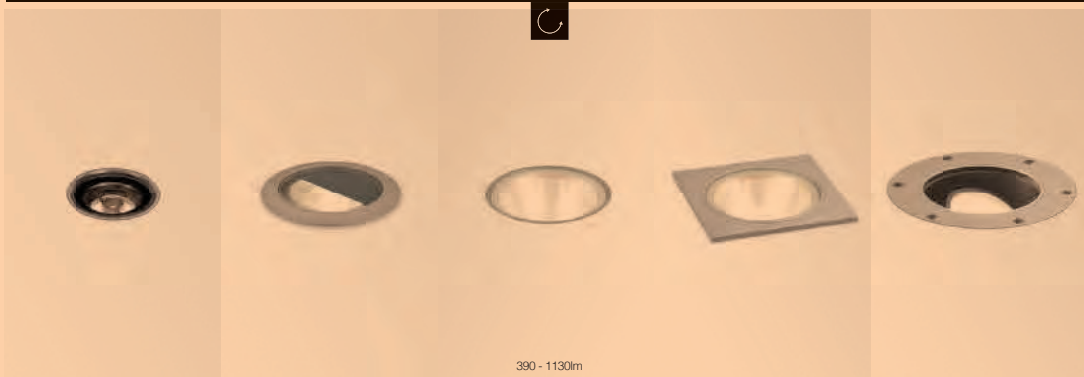

LOGIC F
P 710



LEDS C / GO
P 718

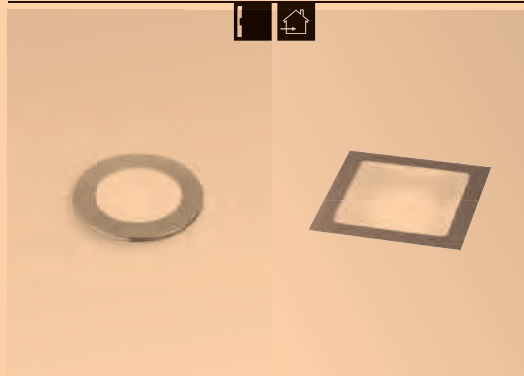

LUMEN OUTPUT mentioned as indicative reach.

NEW
PAGE337
P 337

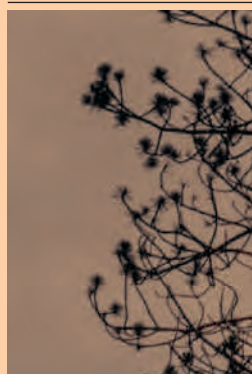

SURFACE

KIX
P 722



130 - 2310m

NEW
FRAX
P 732



650 - 2400m

STIG
P 740



NEW
OUTLINER
P 744



STIEVE
P 748



ELBO
P 752



ELBO BRIDGE
P 752



MONTUR
P 758



OBLIX
P 766



ASTRIX
P 772



NEW
WALKER II
P 776



STRIPER
P 780



MONOPOL
P 786



SPYKER
P 790



BAZIL
P 794



POLESANO
P 798



4500lm - 18000m

LOGIC



Thanks to its multiple reflector options, Logic can be used to accentuate trees or sculptures, to light up facades or large garden features, to create a sense of depth or indicate the right direction along paths and driveways. The choice of installation – trimless or with trim – and its round or square shape allow you to match look & feel with the design of the building.

Within the same family, Logic W can be used as guidance light, built into the wall.

www.deltalight.com/logic



LOGIC 40

The Logic range stands for a complete family of water and shock resistant lighting fixtures. Logic 40 is the smallest of the family, a minimalistic recessed uplight with a diameter of only 40mm. With its small beam angle of 15°, it perfectly serves as an accent light to highlight any architectural aspect you want. Available with trim or as a trimless installation for an even more minimalistic look. To take care of the visual well-being, Logic 40 either comes with a micro vizor inside or as a Moon version, shielding off the light that is thrown backwards. The perfect addition to accentuate green or sculptures, to highlight façade or small garden features, to create a sense of depth or indicate the right direction along paths and driveways.

LOGIC 60

With a diameter of only 60mm, Logic 60 can easily be integrated in any landscape design, without disturbing the visual perception of it. Its smallest beam angle is ideal for highlighting, while the wallwash versions emphasize façades and bring depth into the architecture. The specific Moon version cuts of the light spill going backwards, ideal to accentuate trees or reduce the glare for passers-by.

LOGIC 90

The bigger version of Logic allows for more choice in beam angles, letting the designer be creative and play with light effect and light intensity. Similar to Logic 60 also wallwash versions are available within the bigger range to offer multiple light effects within the same design language.

LOGIC R OK

For optimal beam control, the LED module in Logic R OK can be easily tilted up to 30° and rotated over 350°, while keeping its IP65 label.



FAMILY OVERVIEW

CHOOSE YOUR COLOUR



Anodized aluminium / Black / Inox

CHOOSE YOUR POWER

Ø40

3,9W - 390lm

Ø60

2W up to 7,1W - 230 up to 810lm

Ø90

2W up to 10,4W - 230 up to 1130lm

CHOOSE YOUR OPTICS

Ø40

15° / moon version

Ø60

6° / 20° / wallwash / moon version

Ø90

6° / 11° / 30° / 55° / wallwash

IP67

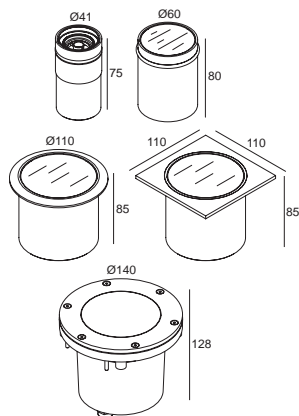

LOGIC F

Logic F creates a playful effect on your path or driveway, perfect to enhance the architectural character of your project and landscape.

www.deltalight.com/logic





FAMILY OVERVIEW

CHOOSE YOUR COLOUR

●
Alu Grey

CHOOSE YOUR TYPE & POWER

Single
0,6W - 40lm

Double
2 x 0,6W - 40lm

IP67

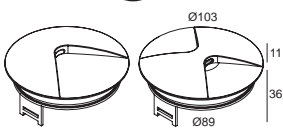







GOVAERT & VANHOUTTE ARCHITECTS







LEDS C / GO

This family offers some miniature fixtures that serve as orientation and atmosphere lighting. Available in round and square, these little dots of light are perfect as guidance lights.

While Leds C II can be used indoors - for example as safety light in corridors and hallways -, Leds C R ST and Leds Go will guide the way outdoors – along paths and driveways.

www.deltalight.com/leds-c
www.deltalight.com/leds-go

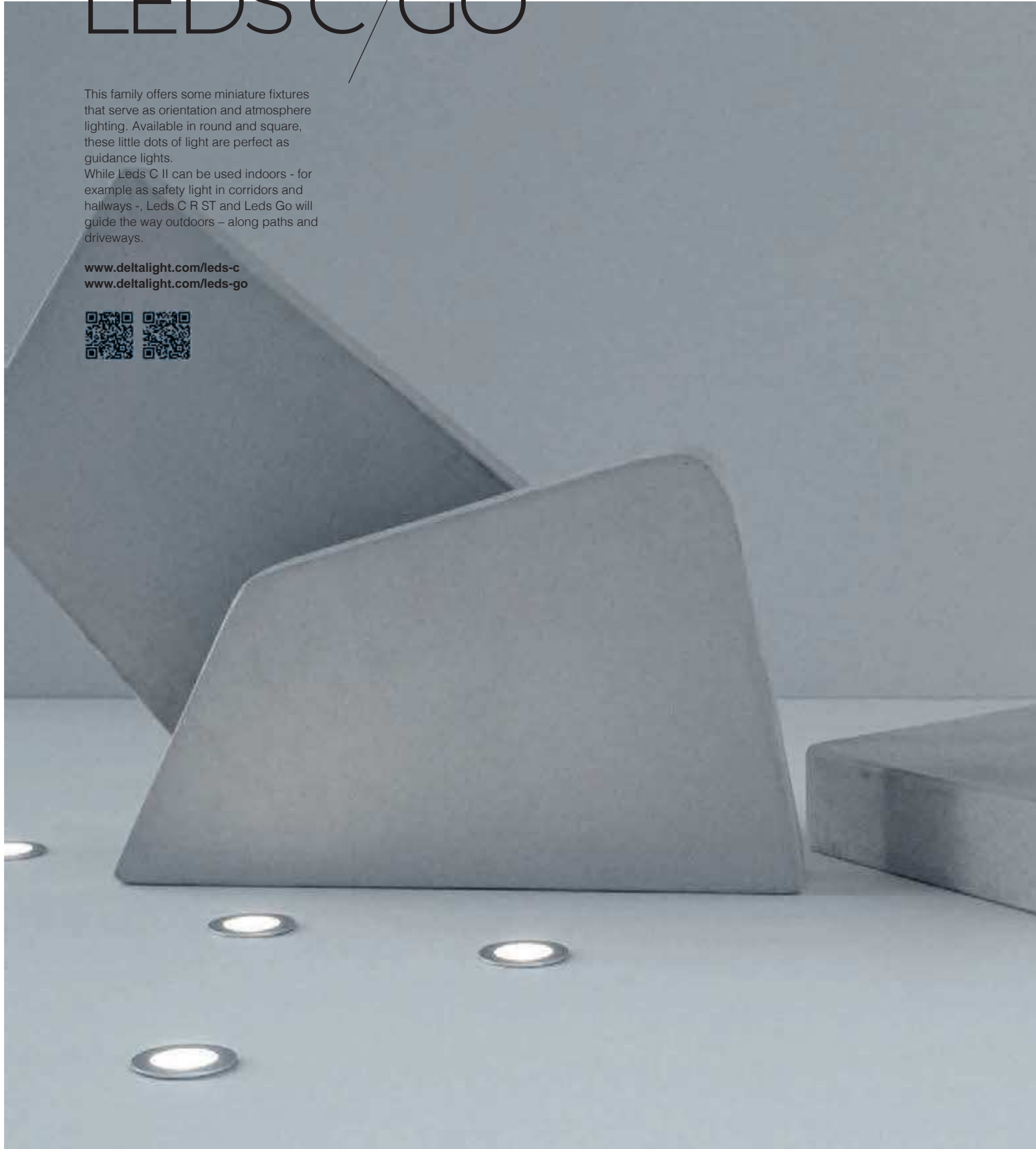



FAMILY OVERVIEW

COLOUR



Anodized aluminium

POWER

1,1W – 130lm

CHOOSE YOUR LED COLOUR

3000K / 4000K

IP67

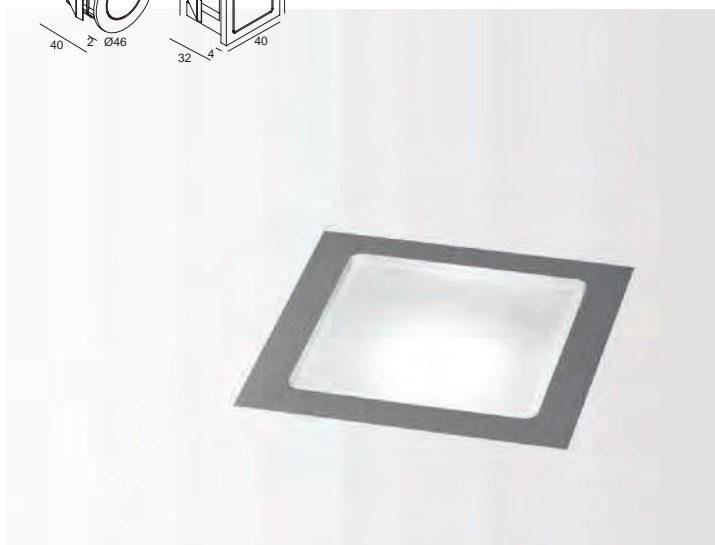
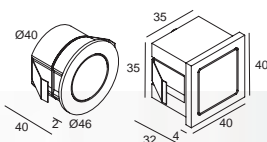





KIX

Flexible, subtle, elegant and powerful: these are the keywords that describe the Kix perfectly. Despite its low-profile appearance, Kix excels in light output and quality, ideal for walkway lighting or other landscape applications. Kix is easy and flexible to use thanks to the adjustable head, designed to provide optimal cooling and eliminate glare.

Kix is available for installation on wall or floor, to strap around a tree or to mount in soft green areas with a pin. In addition to the more robust version of Kix, there is also a S(mall) and M(edium) version available. Kix S combines a powered lens, resulting in a nice 10° light beam. All models have an IP65 rating and are available in alu grey or dark grey.

www.deltalight.com/kix



FAMILY OVERVIEW

CHOOSE YOUR COLOUR



Alu Grey / Dark Grey

CHOOSE YOUR POWER

Small
1W up to 2W - 130 up to 250lm

Medium
6,4W - 590lm

Large
7,1W up to 16,3W - 810 up to 2310lm

CHOOSE YOUR OPTICS

Small
10°

Medium
30°

Large
11° / 30° / 55° / 120°

CHOOSE YOUR ACCESSORY

Honeycomb / Kap

CHOOSE YOUR INSTALLATION

Surface mounted on paved surfaces

On a pin between the green

Strapped around a tree

IP65

IK07

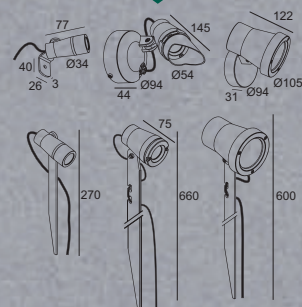







ARCHITECT ANARCHITECT - PHOTO LUCA CIOCI

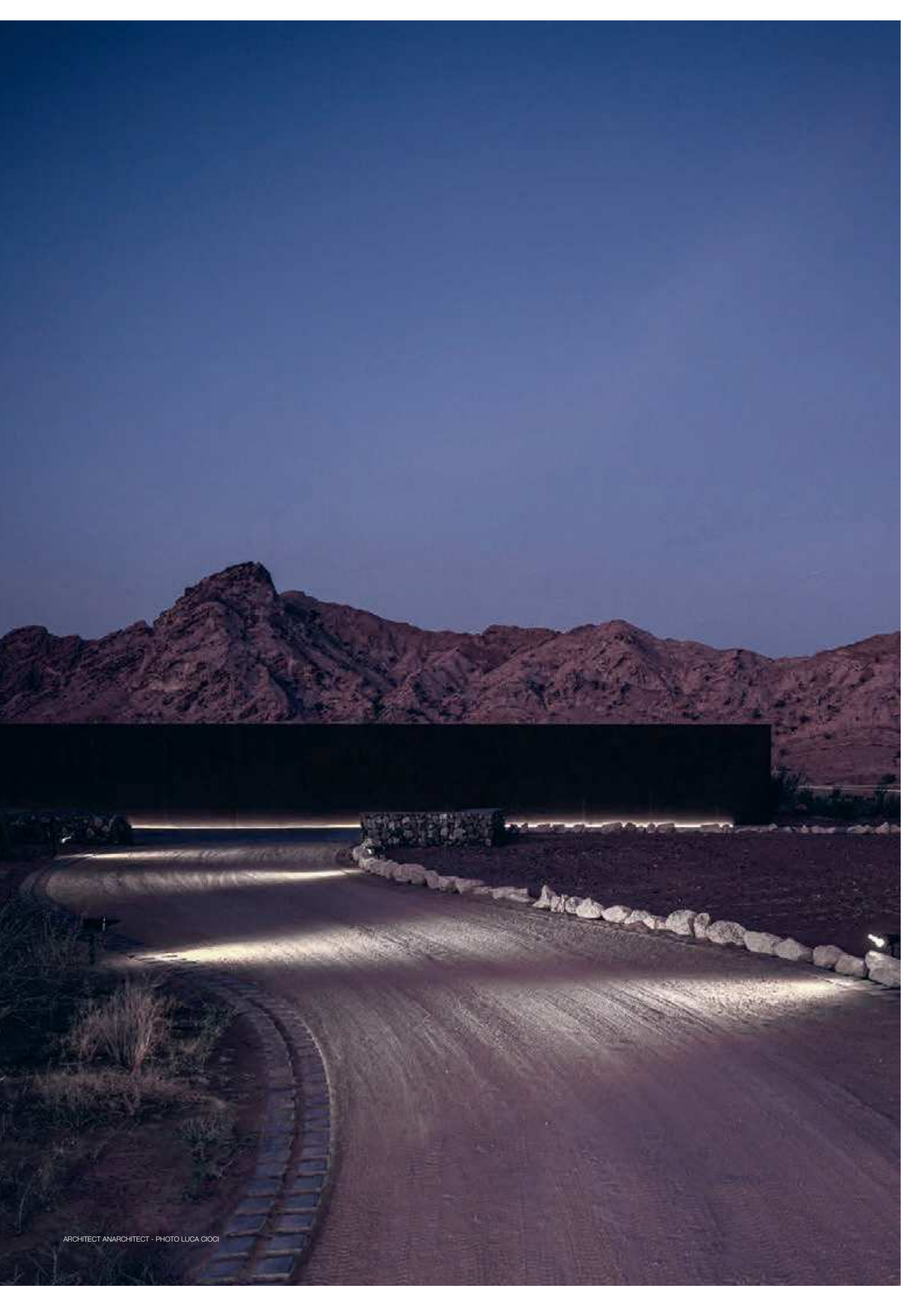



PHOTOGRAPHY GAVRIIL PAPADIOTIS - GAVRIILLUX









Light and ambiance is not only for indoors, by combining light and architecture in outdoor settings, the city also remains vibrant at night. With its 7 different light effects and its multiple installation options, Frax has been designed for every aspect of the urban architecture: any form, any material or any composition.

FRAX

www.deltalight.com/frax



OPTICAL PRECISION
LED Caset Technology

Frax is based on Delta Light's LED Caset technology, which combines multiple LEDs with individual collimator lenses per LED to generate a clean-cut light distribution.

The individual lenses create a multi-layered light distribution to generate a clean 8° or 14° beam angle.

Other beam angles or other light effects are being obtained by adding microlenses in front, sculpting the light into a 26° or 47° beam angle or into a linear or wallwash effect.



VISUAL WELL-BEING

Frax not only cares about the perfect light effect, it takes care about the passer-by as well.

Frax can be provided with an additional honeycomb or a snoot to reduce the possibility from directly looking into the light source.

Both of them reduce any undesired lighteffect and the glare associated with it.



MADE FOR HARSH ENVIRONMENTS
IP65

IK06 thanks to 5mm thick glass for Frax S
IK08 thanks to 8mm thick glass for Frax M

UV-resistant components for extended lifespan

Thermal protector inside to prevent the luminaire from overheating

D-Lock: in-house designed moisture lock to prevent humidity entering the luminaire

FAMILY OVERVIEW

CHOOSE YOUR COLOUR



Dark Grey / Grey

CHOOSE YOUR POWER

Small: 5,9 up to 7,9W - 650 up to 870lm
 Medium: 17,9W up to 23W - 1800 up to 2400lm

CHOOSE YOUR OPTICS

8° / 14° / 26° / 47°

Other effects:
 linear spread / wallwash

CHOOSE YOUR ACCESSORY

Honeycomb
 Snoot

CHOOSE YOUR INSTALLATION

Surface mounted on paved surfaces
 On a pin between the greenery
 Strapped around a tree
 Mounted on a pole

IP65

IK06 IK08

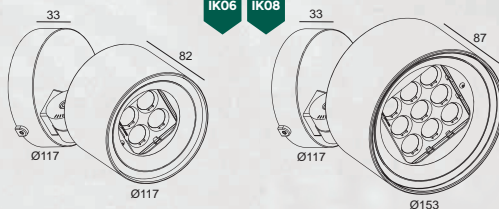

INSTALLATION MADE EASY

Apart from the extensive optical possibilities, Frax also offers a range of different mounting options. Standard, the luminaire comes on a round base, but one can also opt to install the luminaire head on a pin, on a strap or on a simplified bracket. In this way, Frax can easily be transformed to install in between the greenery, around a tree, a pole or any other surface. To facilitate the installation of multiple Frax luminaires, a degree scale is integrated on the hinge, perfect for precise aiming and a proper repetitive light effect.









STIG

Playful design combined with a remarkable light effect. The Stig presents itself as a mini robot and distinguishes itself with a narrow line of light. This small helmet hides a 6W to 8W LED, combined with a lens, behind an opal diffuser. The line created with the Stig allows you to accentuate contours, illuminate paths, indicate lanes, or to apply decorative light effects.

The Stig consists of several variants, for direct mounting on ceiling or wall, combined with a pin to put it into the garden, or with a strap for installation around trees, columns or other elements of a building or garden. Small, simple, modern and with a special touch.

www.deltalight.com/stig



FAMILY OVERVIEW

COLOUR



Dark Grey

CHOOSE YOUR POWER

3,9W up to 8,2W - 420 up to 720lm

CHOOSE YOUR INSTALLATION

Surface mounted on the wall or ceiling

On a pin in soft areas

Strapped around a tree

IP65

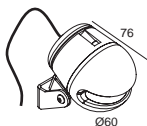







OUTLINER

Outliner defines the perimeter. It comes as single luminaire or as a bespoke profile, perfectly optimizable to any desired length. Designed as an unobtrusive linear solution, Outliner shields off the light source and gently casts its light towards the surface. As such, Outliner is ideal to serve as perimeter lighting across paths, terraces or parking lots, areas that function as passageway.

www.deltalight.com/outliner





FAMILY OVERVIEW

COLOUR



Dark Grey

POWER

5,1W - 650lm

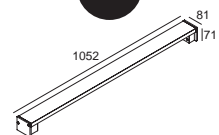





STIEVIE

Stieve is not your typical lighting bollard. The sharp pin underneath the luminaire allows you to install it in many different ways, like a spear has been thrown into the lawn. Its linear light generates a pleasant and warm light effect, ideal to light up a sculpture or to guide a way along the light.

www.deltalight.com/stieve





FAMILY OVERVIEW

COLOUR



Dark Grey

CHOOSE YOUR POWER

6W up to 10W - 510 up to 870lm

CHOOSE YOUR HEIGHT

750 / 1300 mm





ATRIO INTERIORES





ELBO

Elbo can be used as functional path lighting thanks to the in-house developed optics. The lens solution creates a double effect with a wide general soft glow combined with a narrow delineated beam in the middle. According to the position in the luminaire, it can create a long line of light along a pathway or it can create a linear pattern as the light is thrown forward.

www.deltalight.com/elbo



FAMILY OVERVIEW

CHOOSE YOUR COLOUR



Alu Grey / Black

CHOOSE YOUR VERSION

Single / Bridge

POWER

3,9W – 420lm

CHOOSE YOUR HEIGHT

200 / 400 / 600 mm

IP55

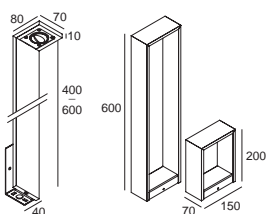







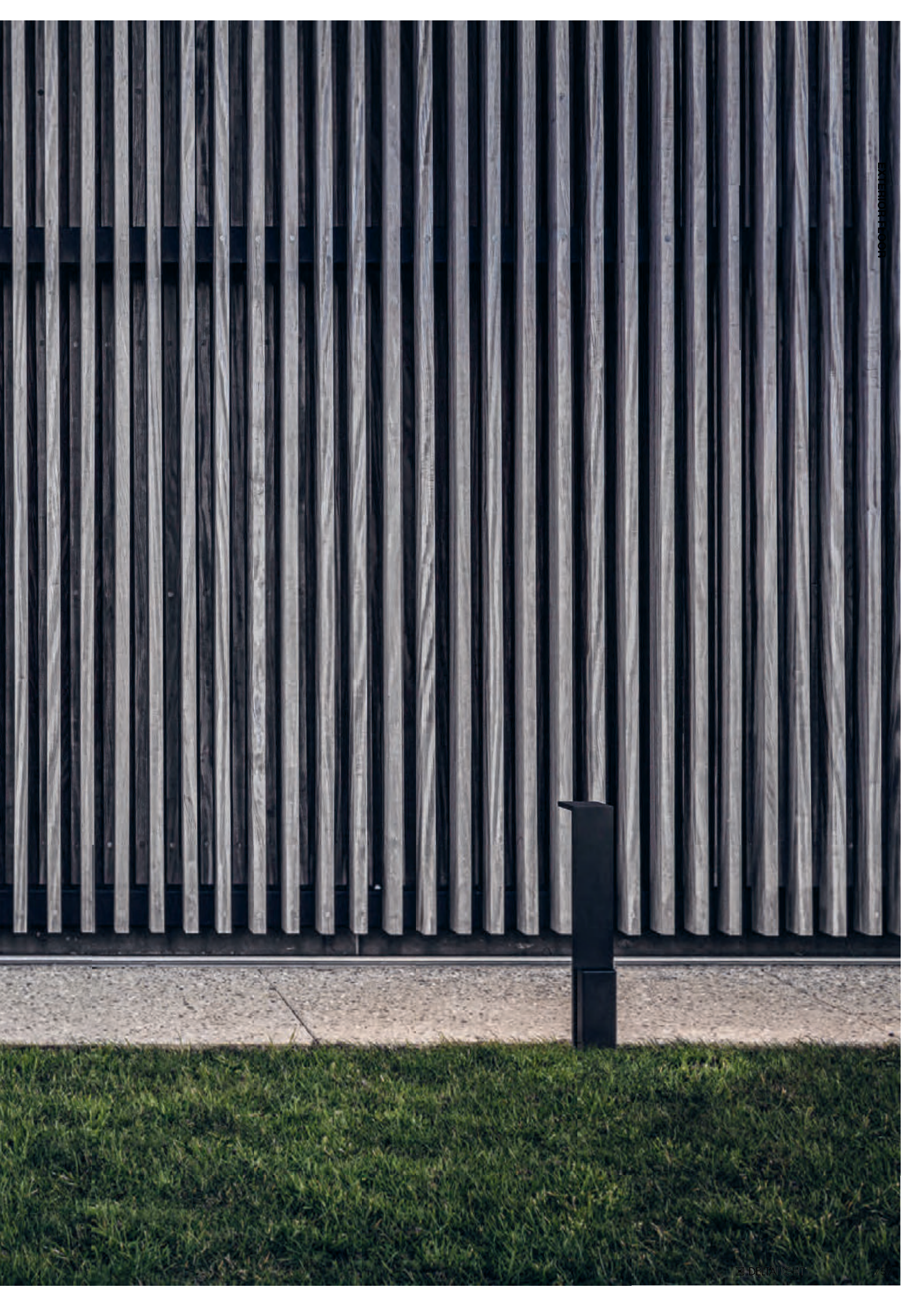



With Montur we offer a highly original interpretation of an archetypical concept: a light source that is contained within the framing of a 3D square or rectangular shape. The Montur is available in indoor and outdoor versions, as a ground, wall or ceiling fixture, with LED clusters or filament-LED lamps with a rustic look. The series integrates beautifully in both country-classic and contemporary homes, and is suitable for hotels and public buildings as well.

The Montur not only breathes new life into a classic concept, it also adds a detailed element of refinement. The sharply profiled framing in aluminium is utterly devoid of welding seams. For both the indoor and outdoor versions, there is a choice of finishing with either hand pressed transparent or opal glass. The opal glass version contains a milky, cone shaped core, with a transparent glass surface, creating a pleasantly diffused light that gives the lamp extra cachet. The indoor version of the Montur is also available as an open cube, with one or two bulbs, or in a rectangular shape with a powerful LED cluster concealed behind a protective cover in polycarbonate. By using them as outdoor fixtures, you can extend your lighting style into the garden or parking area. The outdoor versions are available in the same models as the indoor ones, but always feature a protective cover in glass or polycarbonate. There is also a bollard version, with a choice of various heights.

www.deltalight.com/montur



MONTUR



FAMILY OVERVIEW

COLOUR



Black

CHOOSE YOUR VERSION

Milky glass / Without glass
Round / Square

CHOOSE YOUR POWER

6W up to 13,3W - 1000 up to 1250lm

CHOOSE YOUR HEIGHT

200 / 400 / 600 / 700 / 900 mm

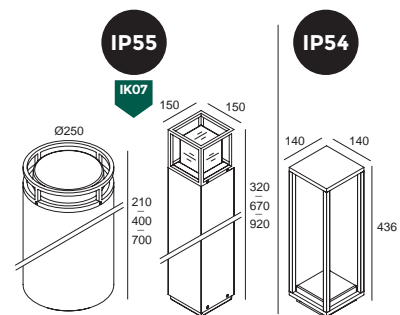

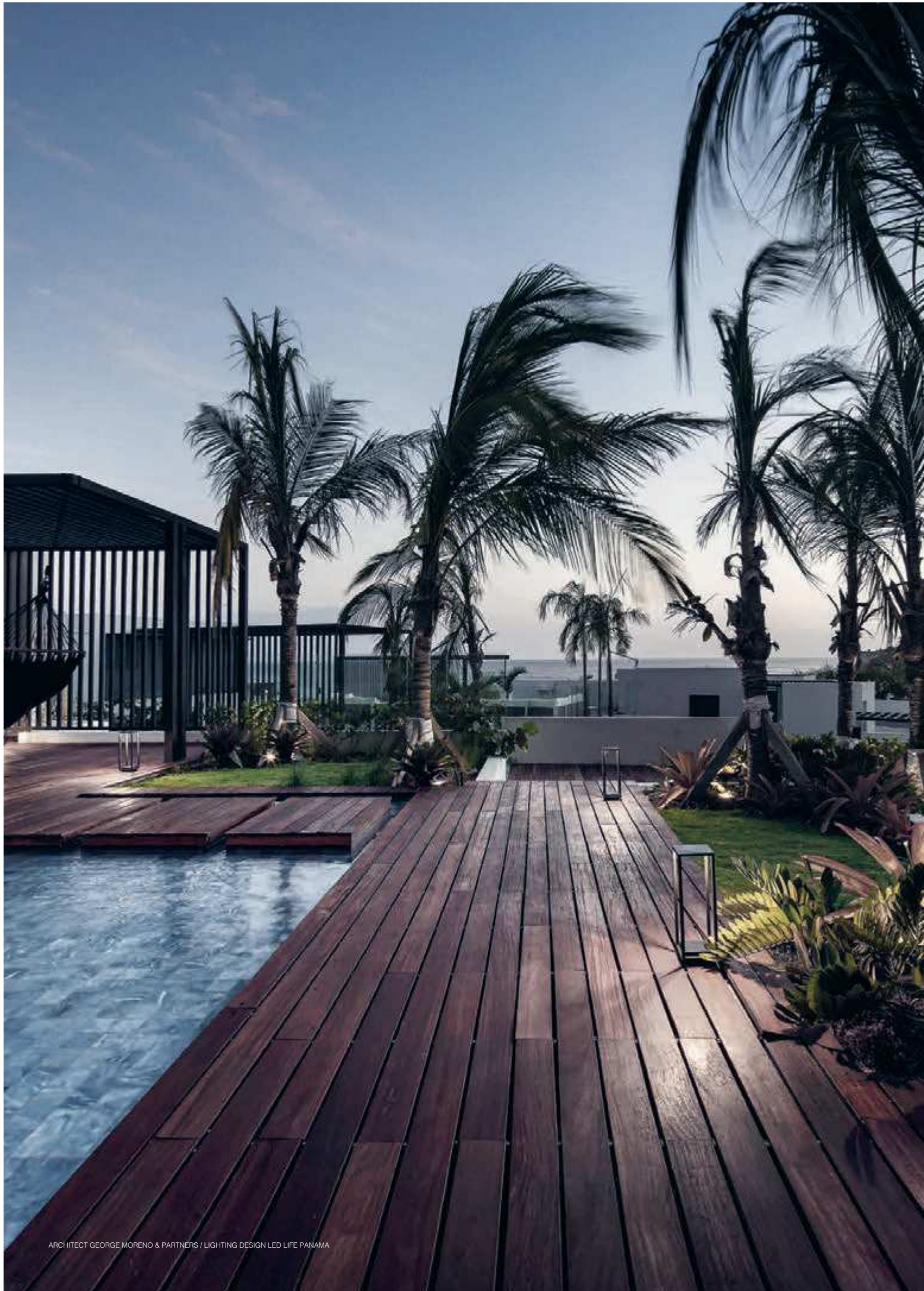



GOVAERT & VANHOUTTE









ARCHITECTS THONE ARCHITECTUUR / INTERIOR DESIGN TIM VAN STEENBERGEN

OBLIX

The Oblix light effect tops any expectation. The unique design of this bollard and the positioning of its light unit results in maximum beam spread and a powerful play of light, providing an expressive and architectural touch to your project.

Oblix has a standard width of 150mm, while Oblix S is its smaller version of only 100mm wide.

With its additional floor base, Oblix F increases the contact area between the bollard and its mounting surface for a more robust installation. Oblix R is the round version of the family, using the same optical features but adding more volume to its surroundings. As such, one can opt for Oblix F or Oblix R for higher impact resistant bollards as they have an IK08 rating.

By shielding of the LED from sight, Oblix avoids direct exposure and dazzle, without compromising on light output. Oblix can be directly installed on any hard surface or - when combined with a pin - be planted in any green surrounding. Available in multiple heights from 150mm up to 1000mm, in both alu grey and dark grey finish.

www.deltalight.com/oblix



FAMILY OVERVIEW

CHOOSE YOUR COLOUR



Alu Grey / Dark Grey

CHOOSE YOUR SHAPE

Rectangular / Round

CHOOSE YOUR POWER

7,1W - 810lm
10,4W - 1130lm

CHOOSE YOUR INSTALLATION

With or without base

CHOOSE YOUR HEIGHT

200 / 400 / 700 / 1000 mm

IP55

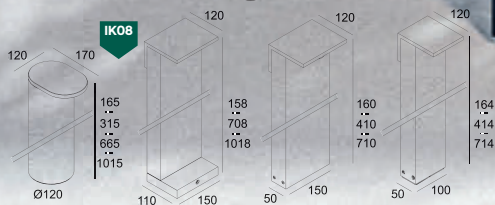





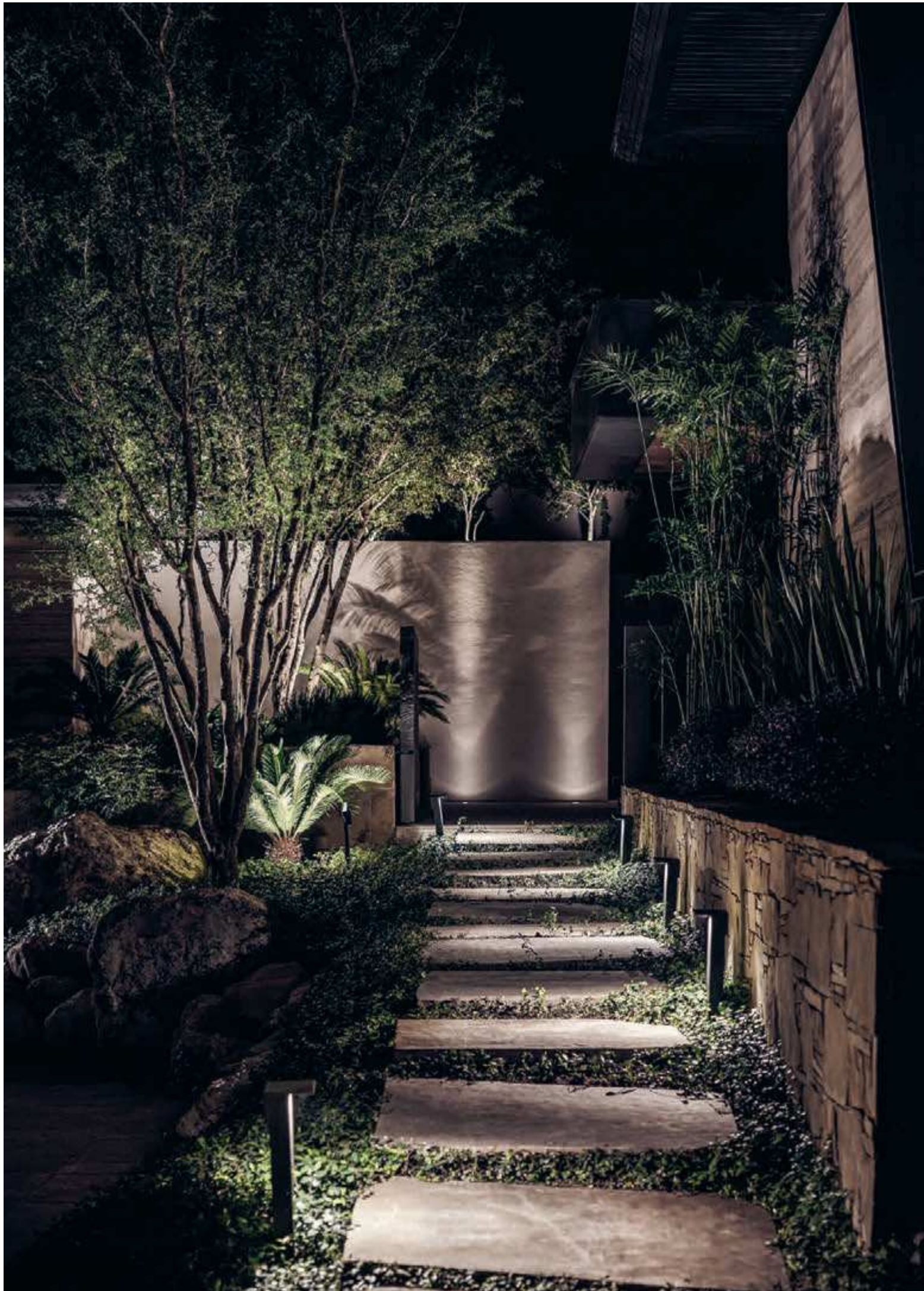



INTERIOR DESIGN ATRIO INTERIORES

ASTRIX

Astrix is a more robust version of our Oblix range. It has IK07, comes in 3 different heights and with a single or double light unit. Ideal to be used as path lighting as the indirect position of the led avoids direct exposure and dazzle, resulting in a Dark Sky Friendly lighting solution.

www.deltalight.com/astrix





FAMILY OVERVIEW

COLOUR

●
Black

CHOOSE YOUR VERSION

Single / Double

CHOOSE YOUR POWER

7,1W - 810lm
2 x 3,2W - 310lm

CHOOSE YOUR HEIGHT

300 / 500 / 750 mm

IP55

IK07

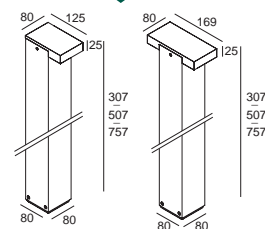





WALKER II

SPLIT THE LIGHT

Walker II splits the light open. Starting from 1 light source, Walker II is designed to guide the light into two directions to provide a double light effect on the surface below.

The light falls on the V-shaped inner part of the luminaire, breaking it open and throwing it to the front- and backside of the luminaire.

Walker II can serve as a guiding light on your wall or pathway, as it comes as a wall luminaire and as a bollard. Different sizes, different heights and multiple colour combinations can be combined to your preference to create the perfect setting.

www.deltalight.com/walker-ii



FAMILY OVERVIEW

CHOOSE YOUR COLOUR



Dark Grey / Alu Grey

Dark Grey-Gold Coloured / Alu Grey-Dark Grey

CHOOSE YOUR POWER

3,7W - 480lm

6,2W - 790lm

CHOOSE YOUR LED COLOUR

2700K / 3000K

CHOOSE YOUR HEIGHT

200 / 400 / 700 mm

IP54

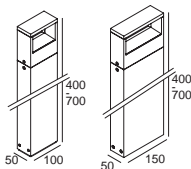

EXTERIOR FLOOR

Find the other members of this family **INTERIOR / EXTERIOR WALL**







If you are looking for a subtle floor surface light for outdoor use, the Striper might just be what you need. Due to its rather small size it is the perfect solution to light a path or driveway without disturbing the surrounding architecture or view of the nature around you. The rectangular shape of this product gives it a modern and sleek look. The combination of the powered lens with a 4° LENS, results in a very long and narrow beam.

STRIPER

www.deltalight.com/stripers



FAMILY OVERVIEW

CHOOSE YOUR COLOUR



Alu Grey / Dark Grey

POWER

2W - 245lm

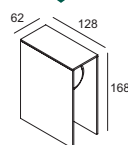





ARCHITECT AABE - ATELIER D'ARCHITECTURE BRUNO ERPICUM & PARTNERS / PHOTOGRAPHY JEAN-LUC LALOIX





CASTEL MIMI / TRANTI DESIGN





MONOPOL

Monopol is a bollard taking on the shape of a slender girder, rising from the ground up. Minimalistic in design, straightforward in functionality as it produces a very focused spread of light through its narrow opening at the front. Available in 2 sizes, 2 colors and perfect to create a play of light on paths or driveways.

www.deltalight.com/monopol



FAMILY OVERVIEW

CHOOSE YOUR COLOUR



Alu Grey / Dark Grey

POWER

7,1W – 810lm

CHOOSE YOUR HEIGHT

300 / 700 mm

IP55

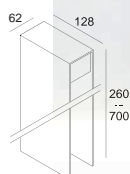







SPYKER

The Spyker is characterized by a circular base and a wider aluminium disc on top, holding a circular cluster of LEDs. This outdoor lighting solution is available in 2 heights and comes in alu grey or dark grey. Thanks to 2 different optics, Spyker offers 2 different light effects: the first optic creates a general light, uniform around the luminaire, while the second optic results in a circular line of light embracing the luminaire like a halo.

www.deltalight.com/spyker



FAMILY OVERVIEW

CHOOSE YOUR COLOUR



Alu Grey / Dark Grey

CHOOSE YOUR OPTICS

General light effect
Centric light effect

POWER

7,1W – 810lm

CHOOSE YOUR HEIGHT

400 / 700 mm

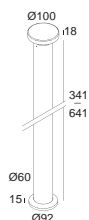







BAZIL

Bazil is characterized by an aluminum disc which holds a ring of leds, supported by a softly curved body that serves as a reflector, combining design and functionality. The result is a pleasant, soft light that poses no risk of dazzling. The large and more robust model fits perfectly around office buildings, public buildings, hotels and grand houses. Bazil comes in different colour combinations, including Delta Light's unique dark grey.

www.deltalight.com/bazil



FAMILY OVERVIEW

CHOOSE YOUR COLOUR



Alu Grey-Anodized / Dark Grey-Anodized

CHOOSE YOUR POWER

11W - 730lm
15W - 1020lm

CHOOSE YOUR HEIGHT

200 / 400 / 700mm



IK08

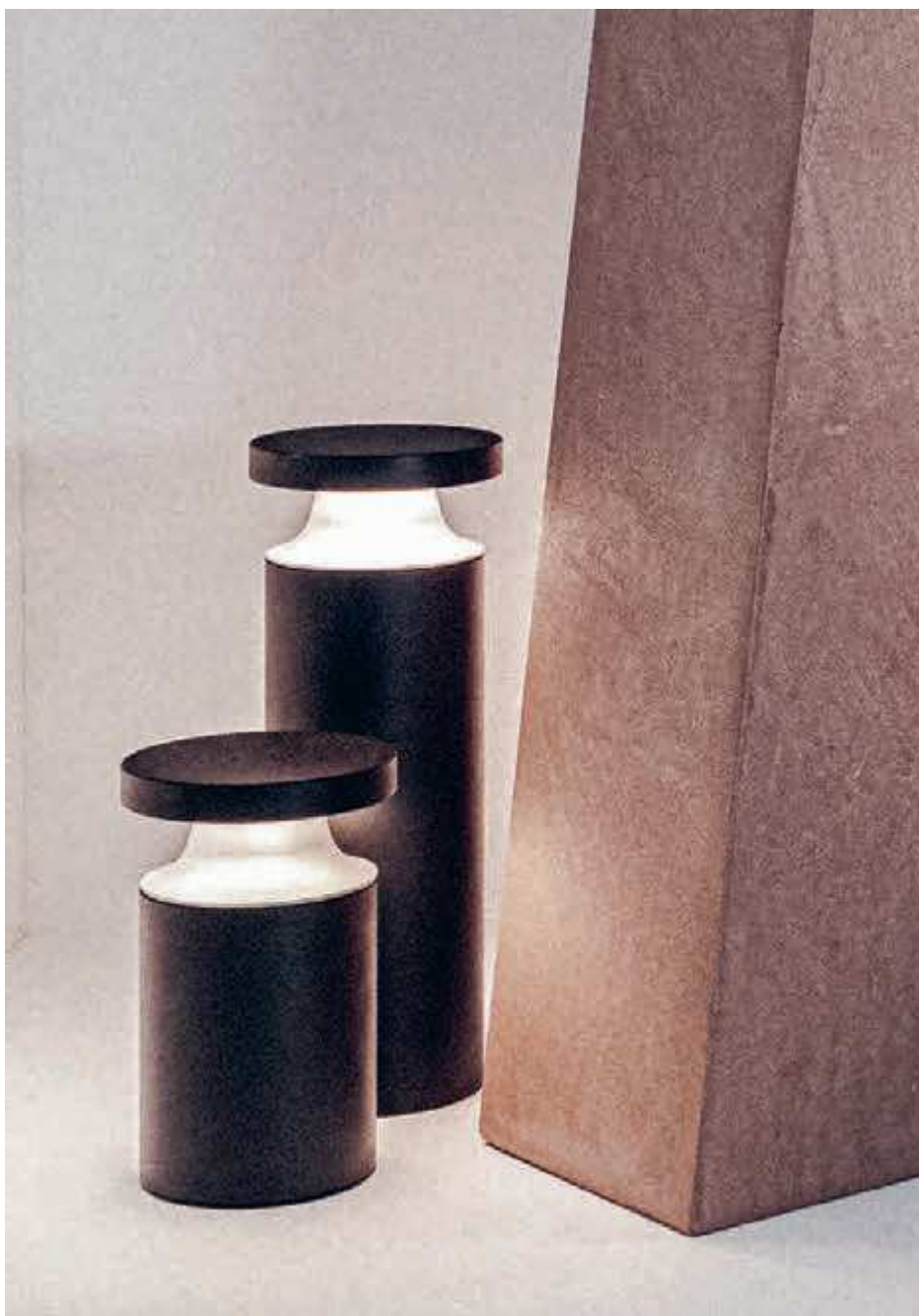
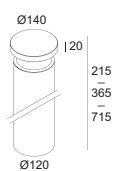





ATRIO INTERIORES



POLESANO

Polesano, a collaboration in product design between Dean Skira and Delta Light. The goal was to develop a new concept in lighting instruments, designed specifically for urban settings, be that a pedestrian pathway, roadway, park, square, façade or landscape. It needed to provide maximum flexibility for the designer to combine different optical characteristics, whilst keeping the same aesthetic for the entire system, regardless of the area.

The result is Polesano, offering modularity and flexibility, and providing personal involvement for the designer to meet specific functional and aesthetical needs of the project. Future developments can be integrating video surveillance, Wi-Fi, speakers or other IoT units.

Design by **DEAN SKIRA** & Delta Light

www.deltalight.com/piresano





FAMILY OVERVIEW

CHOOSE YOUR COLOUR



Alu Grey-Anodized / Dark Grey-Anodized

CHOOSE YOUR INSTALLATION

Wall mounted

Pole mounted

Anchored / With base

4m / 6m

CHOOSE YOUR SETTING

Up to 4 Polesano heads per pole

POWER

42W – 4500lm

CHOOSE YOUR LED COLOUR

3000K / 4000K

CHOOSE YOUR LIGHT EFFECT

Spot 15° / Medium 43° / Flood 70° / Streetlight

CONTROL

DALI dim

CHOOSE YOUR EXTRA'S

Camera / Wifi Hub



STANDARD CONFIGURATIONS

Within the Polesano Range, some standard configurations are offered, both for the pole and the luminaire. A pole height of 4m or 6m can be chosen, either with anchor or base as installation possibilities. Both heights allow you to have up to 4 luminaires to be mounted in standard combinations, as shown below.

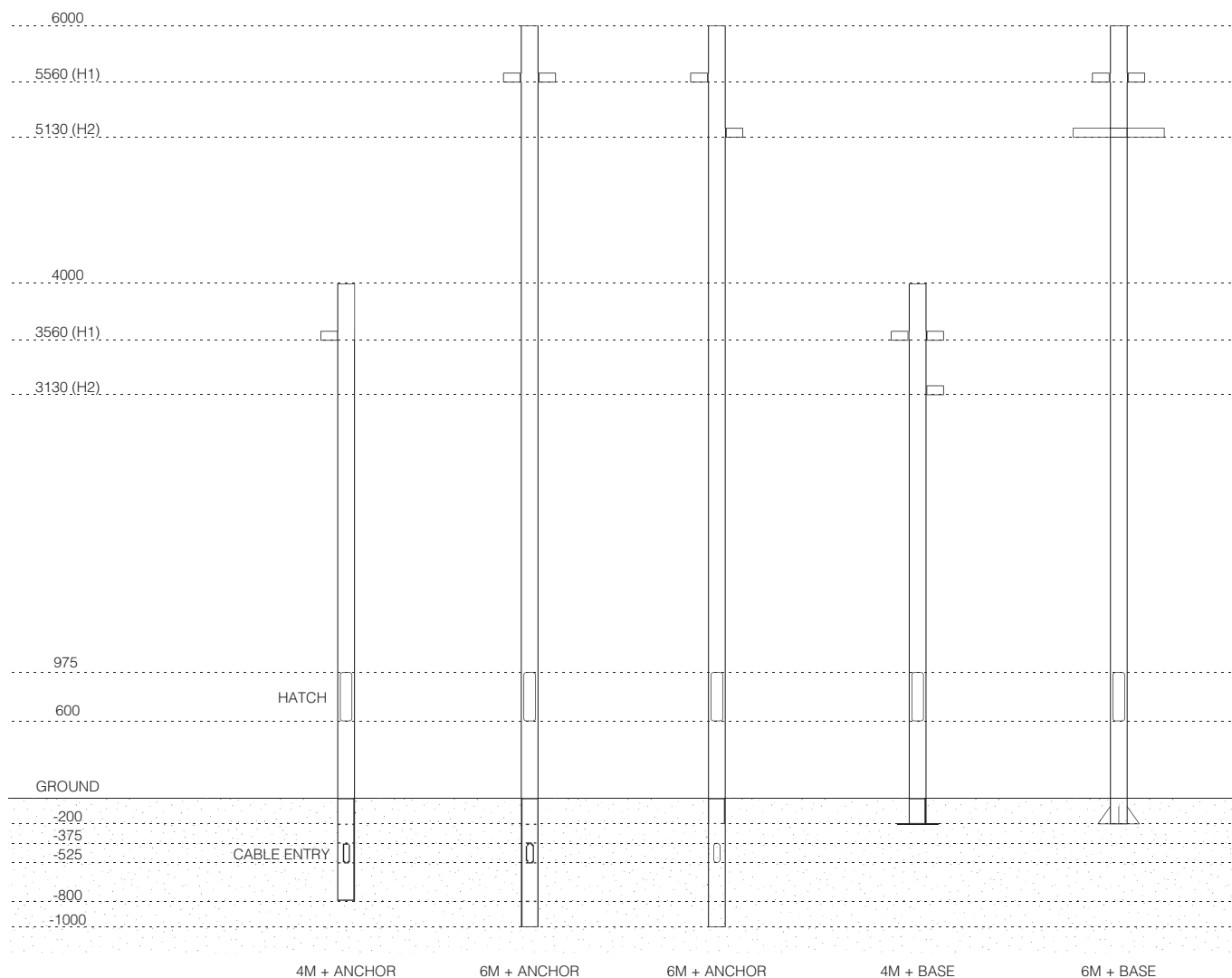

HEAD COMBINATIONS (TOPVIEW) :
(POSSIBLE WITH ALL TYPES OF POLE)

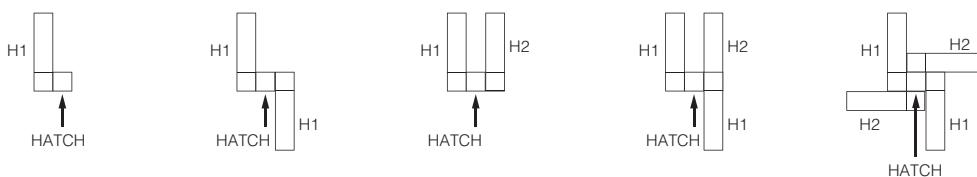



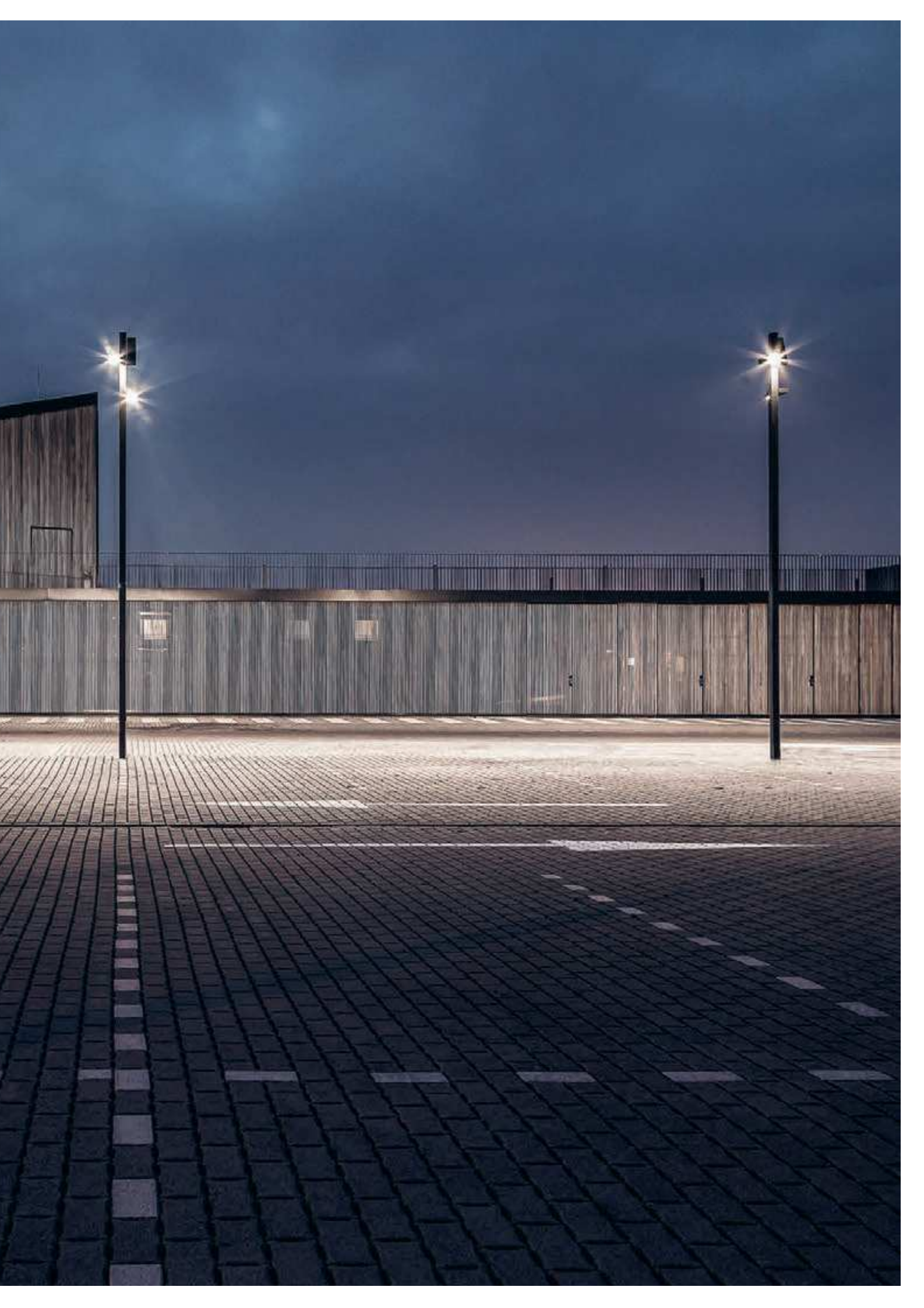











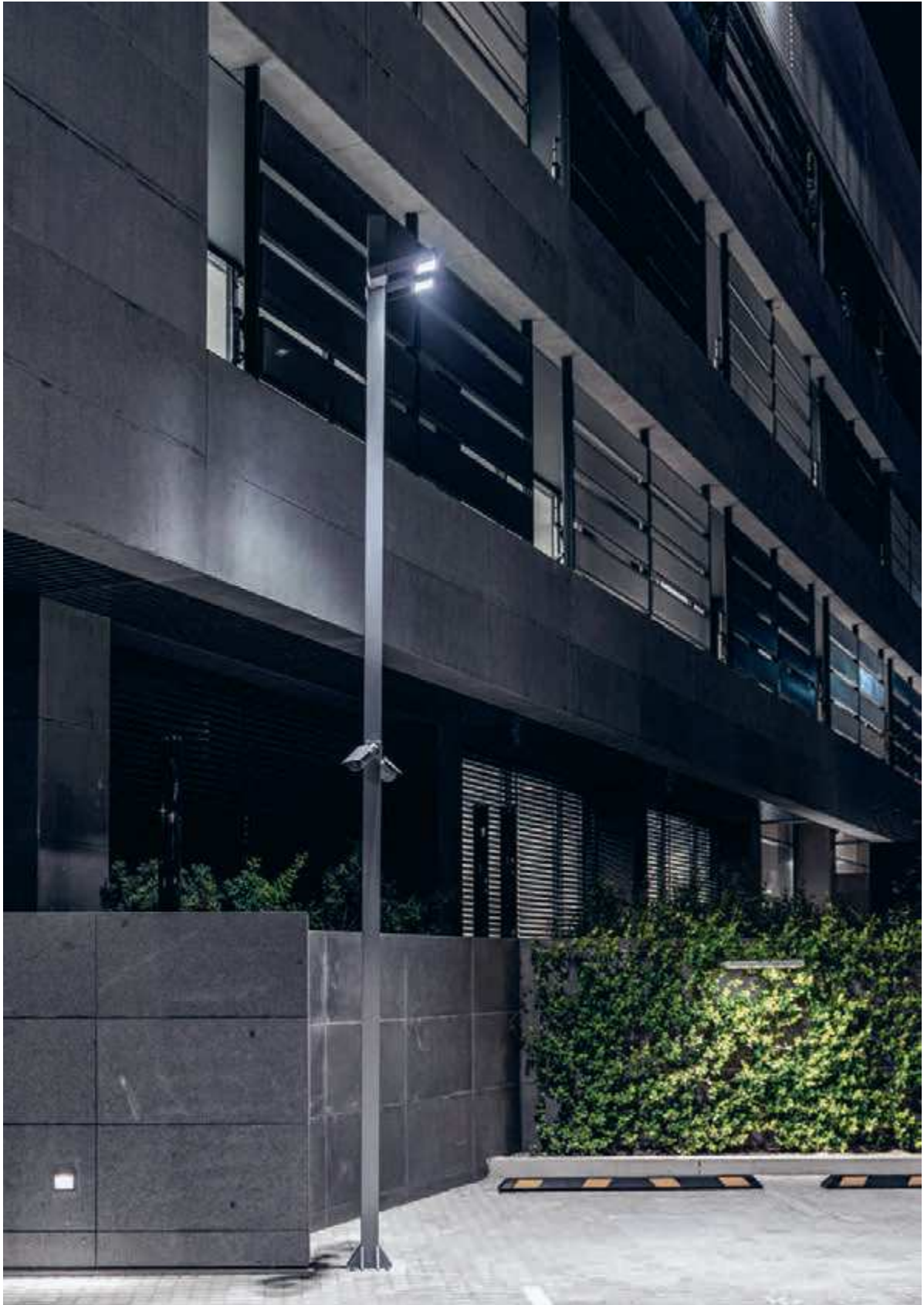

ARCHITECT ISV ARCHITECTS / INTERIOR DESIGNER NELLY SFAKIANAKI ARCHITECTURE & INTERIOR DESIGN /
LANDSCAPE DESIGN H. PANGALOU & ASSOCIATES LANDSCAPE ARCHITECTS / LIGHTING DESIGN FOSS S.A. LIGHTING DESIGN /
PHOTOGRAPHY GAVRIIL PAPADIOTIS (WWW.GAVRIILUX.COM)

A FAMILY BUSINESS

Delta Light's success is built on the determination, passion, and talent of our global team. We hereby thank all of our colleagues and partners for their invaluable work.

The lighting industry is evolving and growing at very high speed.

As a family run business, we have a personal stake in keeping our clients happy. As such we are committed in making a difference through original designs, outstanding service levels, an eye for detail and personal contact and striving to be the best in all we do.

Our product development process is based on a combination of creativity and technological innovation. It is our mission to present to the world a portfolio of lighting solutions that satisfy people's desires and needs, realise peoples visions, whilst creating a perfect symbiosis between architecture, function and atmosphere.



THE MAKING OF THE LIGHTING BIBLE

THE LIGHTING BIBLE 14 is entirely created in-house, by a dedicated team, supported by colleagues from all departments. Are you wondering how it all went down? We lift a tip of the veil with this behind-the-scenes footage.

No photographers were harmed during this period.

A special thank you to our coffee machine,
who was always there for us.

We were instructed by our Art Director
to write a kind thank you note towards him...
So here it comes:

Lorem ipsum dolor sit amet, consectetur adipiscing elit. Donec in justo eu quam ultrices commodo. Vivamus posuere orci congue tortor pellentesque viverra. Pellentesque pharetra, mauris ut consectetur placerat, purus ex feugiat nibh, a commodo velit nibh a lacus. Hebban olla vogala nestas hagunnan hinase hic enda thu hoe mehr vogala hoe betera. Quisque in volutpat nisi, sed tristique mi. Integer ultrices massa nec sapien tristique suscipit. In pellentesque, leo Frituur Magalie fermentum, magna Sammie blandit nulla, a malesuada justo mauris ut tellus.

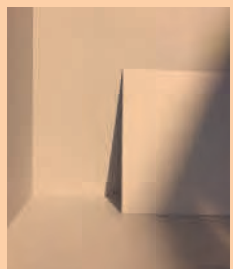
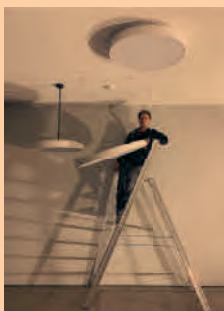
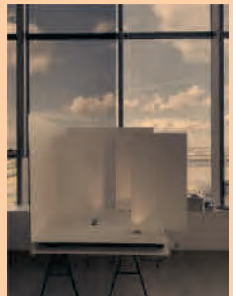
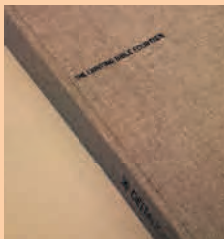
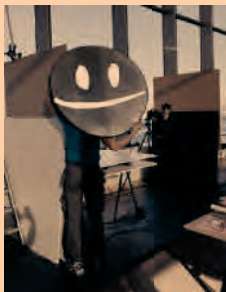
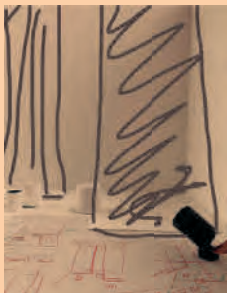
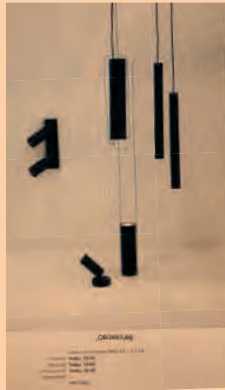
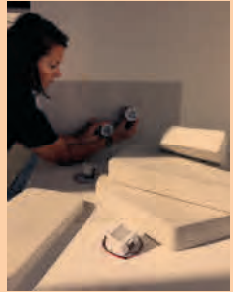
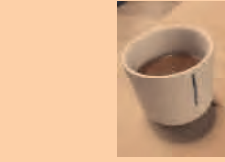



WORLDWIDE

For additional product information,
technical downloads, project inspiration,
contact details and much more... please go to
www.deltalight.com

Whether you access the site via your desktop computer or mobile device, an inspiring platform opens up with up-to-date content, exciting images, extensive product information, upgraded user experience... all in a fresh look & feel.

The **product search engine** will quickly guide you to the right product page, where you can download 3D files, Revit files, product data sheets, manual, IES files and drawings.

The **My Delta Light Toolbox** helps you to quickly collect, save, download and share images and product information. Start creating your personal shortlists and share them with your partner, client, architect, electrical installer or other people involved in your project. You are free to use this feature without login, or you can register to save and edit multiple pinlists.

If you are looking for a contact person in your region or country please go to
www.deltalight.com/contact

#wearedeltalight

HQ

Headquarters
Delta Light nv
Muizelstraat 2
B-8560 Wevelgem (Moorsele)
Belgium
T +32 (0)56 435 735
F +32 (0)56 435 736
info@deltalight.com
www.deltalight.com

OFFICES

ASIA

Delta Light Asia
asia@deltalight.com
www.deltalight.asia

South East Asia
T +65 9832 3753

North East Asia
T +852 9293 0096

CHINA

Delta Light China
china@deltalight.com
www.deltalight.com

Beijing
T +86 138 1070 8782

Shanghai
T +86 135 8578 5451

LATIN AMERICA

Delta Light Latin America
M +32 492 724 070
latin@deltalight.com
www.deltalight.com

Colombia
T +57 1 749 5307
M +57 321 202 5501
M +57 312 301 3823
Colombia@deltalight.com

Mexico
Mexico@deltalight.com

Mexico City
M +52 556 204 1203

Monterrey
M +52 181 3081 4196

RUSSIA / EASTERN EUROPE / MIDDLE ASIA

Delta Light REEMA
reema@deltalight.com
www.deltalight.ru

Moscow
T +7 926 167 76 98

Saint-Petersburg
T +7 921 79 183 88

UNITED KINGDOM

Delta Light UK LTD
T +44 (0)20 7960 5030
uk@deltalight.com
www.deltalight.co.uk

BELGIUM / LUXEMBOURG

Delta Light nv
T +32 (0)56 435 735
F +32 (0)56 435 736
belux@deltalight.com
www.deltalight.be

FRANCE

Delta Light SAS
T +33 (0)9 70 73 52 42
T +33 (0)9 70 73 52 43
france@deltalight.com
www.deltalight.fr

SLOVAKIA

Delta Light Slovakia s.r.o.
T +421 2 6353 0180
F +421 2 6353 0181
slovakia@deltalight.com
www.deltalight.sk

USA

Delta Light USA, LLC.
T +1 (954) 677 9800
F +1 (954) 677 1007
usa@deltalight.us
www.deltalight.us

New York
T +1 (646) 973-3284
nyc@deltalight.us

Los Angeles
T +1 (213) 289-3048
la@deltalight.us

Miami
T +1 (954) 677-9800
miami@deltalight.us

CANADA

Delta Light Canada Inc.
T +1 905 813 6130
F +1 289 805 7388
canada@deltalight.com
www.deltalight.ca

GERMANY / AUSTRIA

Delta Light GmbH
T +49 (0)2451 4090-0
F +49 (0)2451 4090-200
germany@deltalight.com
www.deltalight.de

MIDDLE EAST / NORTH AFRICA

Delta Light Mena
T +961 1 491 175
mena@deltalight.com
www.deltalight-mena.com

Dubai
Delta Light EMEA
T +971 52 530 35 90
uae@deltalight.com

SPAIN

Iluminación Delta Light España S.A.
T +34 (0)93 586 19 00
F +34 (0)93 697 95 00
spain@deltalight.com
www.deltalight.es

CZECH REPUBLIC

Delta Light Czech s.r.o.
T⁽⁰⁾ +420 241 740 775
T⁽⁰⁾ +420 241 740 776
czech@deltalight.com
www.deltalight.cz

INDIA

Delta Light India
T +9111 4056 2720
india@deltalight.com
www.deltalight.com

THE NETHERLANDS

Delta Light Nederland B.V.
T +31 (0)88 80 40 600
F +31 (0)88 80 40 699
netherlands@deltalight.com
www.deltalight.nl

SWITZERLAND

Delta Light AG
T +41 (0)61 485 99 10
F +41 (0)61 485 99 11
switzerland@deltalight.com
www.deltalight.ch

ITALY

Delta Light Italia S.r.l.
T +39 02 2305 6210
F +39 02 2316 6064
italy@deltalight.com
www.deltalight.it

POLAND

Delta Light Poland
T +48 698 33 00 03
poland@deltalight.com
www.deltalight.pl

Manufacturer Delta Light nv

Product Design - Research - Development: Delta Light Team & Nice 2C

Coordination - Concept: Delta Light Team & Nice 2C

Graphic Design - Realisation: Delta Light Team & Nice 2C

Finally, to everyone who contributed in some way
to the realisation of this Lighting Bible...

Thanks.

Copyright © Delta Light nv
DOC 100 00001
Made in Belgium

For the latest edition of the Lighting Bible, please visit
www.deltalight.com

All information in this catalogue is provided for information purposes only and Delta Light NV makes no representations about the accuracy or completeness of the information in this catalogue.

Delta Light NV may, in its sole discretion, revise the information and technical data contained herein at any time without notice. The catalogue does not contain any guarantee on the Delta Light NV products nor any warranty of merchantability or fitness for a particular purpose or use

All Delta Light products are supplied without lamps and any lamp data is given as a mere example.

The general terms & conditions of Delta Light NV shall be applicable on each sale of a Delta Light product.

Any trademarks, texts, images, graphics, designs and other information in this catalogue are the sole property and subject to the intellectual property rights of Delta Light NV and may not be copied, modified or used for any purpose without Delta Light's prior written consent.



