



tobias grau

DE Wir wollen mit Licht die Lebensqualität von Menschen erhöhen. Licht bestimmt unsere Erfahrungen mit dem Leben, indem es unser Sehen, unsere Gefühle und unseren biologischen Rhythmus beeinflusst. Uns treibt es an, Leuchten zu entwickeln die inspirieren, das Wohlbefinden erhöhen und Menschen helfen sich weiterzuentwickeln.

EN We want to improve people's quality of life with light. Light determines our experience of the world – shaping our vision, our feelings and our biological rhythm. Our mission is to develop lamps that inspire, increase wellbeing and help people live out their potential.

Home Collection

Tisch / Table
15

Steh / Floor
37

Pendel / Suspension
53

Strahler / Spot
103

Decke / Ceiling
123

Wand / Wall
143

Office Collection

TEAM Series
155

XT-A Series
185

XT-S Series
209

Lichtplanung / Light Planning

CHOICE Konfigurator / CHOICE Configurator
228

Dimmtechnologien / Dimming Technologies
238

Planungstools / Planning Tools
240

Home Collection

Tisch / Table

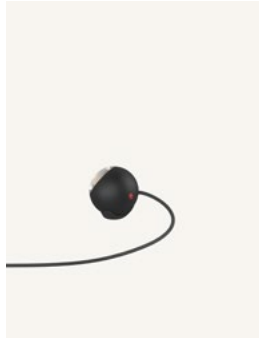

FALLING IN LOVE
16

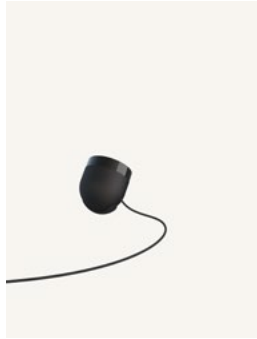

LOVE FOCUS
20



SALT&PEPPER
24



JOHN
30



TEAM HOME
164

Steh / Floor

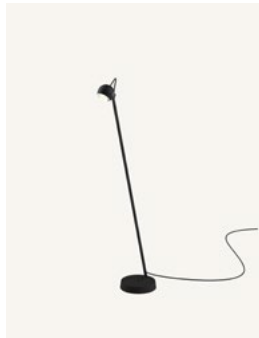

FALLING STAR FLOOR
38



PARROT
42

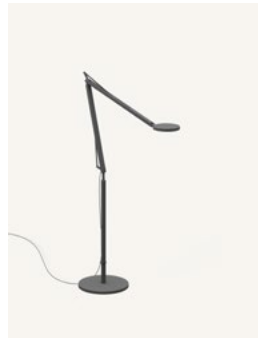

JOHN FLOOR
48

Home Collection

Pendel / Suspension



NICEONE
54

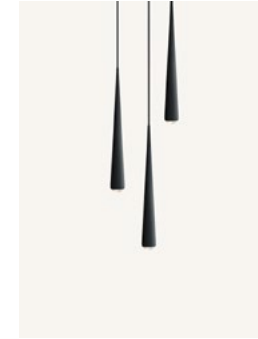

NICEONE RAIN
58

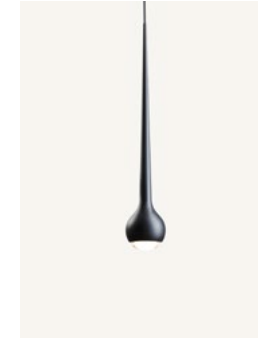

FALLING
60

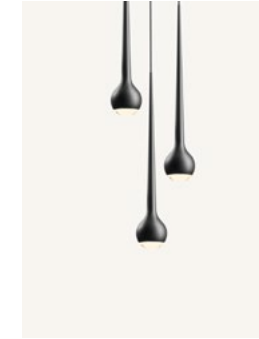

FALLING WATER
66

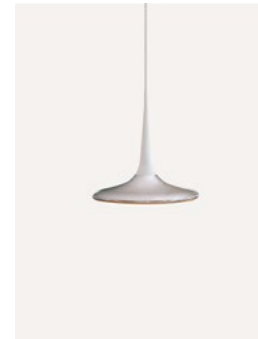

FALLING LEAF
68



OH
72

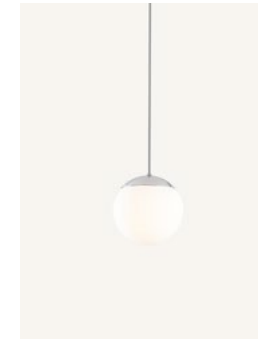

PALLA
78



FLYING
84



MOVE AROUND
90

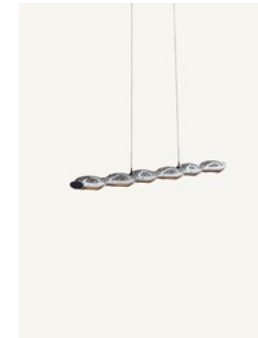

MOVE ALONG
94



DANCE
98



TEAM SUSPENSION
184

Home Collection

Home / Office Collection

Strahler / Spot

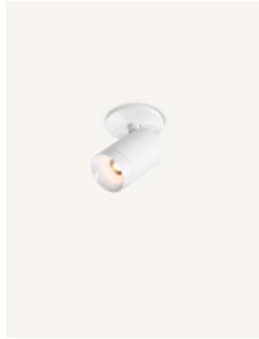

SET
104

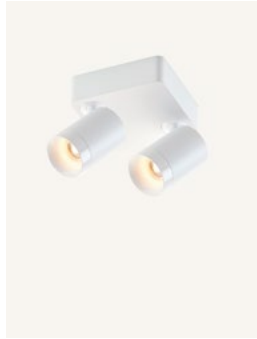

SET DUO
106



SET TRACE
106

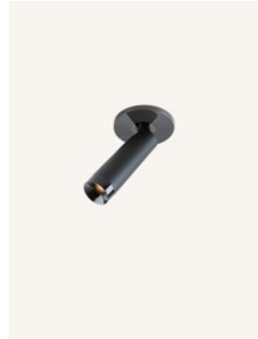

CLEAR
108

Wand / Wall



GLOBE WALL
144



SIMPLE
148



SET FOCUS
112

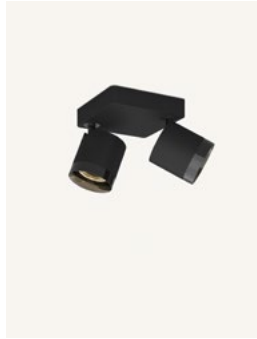

SET FOCUS DUO
116

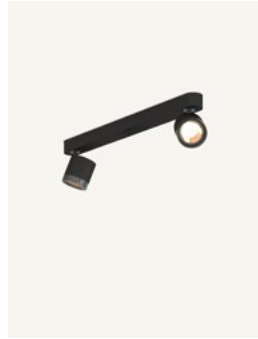

SET FOCUS TRACE
116



STUDIO
118

TEAM Series



TEAM HOME
160



TEAM ONE
168



TEAM TWO
172



TEAM FOUR
176

Decke / Ceiling



GLOBE
124

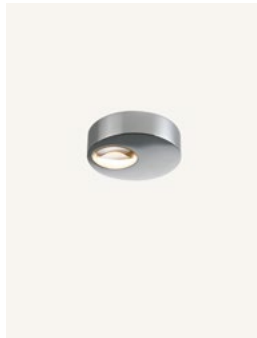

GLOBE BOX
128

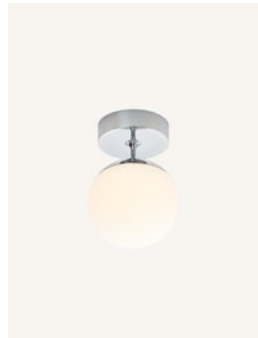

PALLA CEILING
134

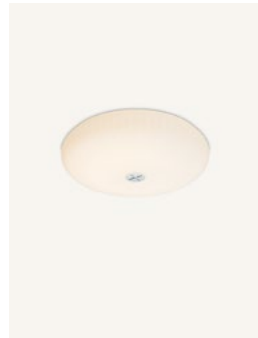

OCEAN
138

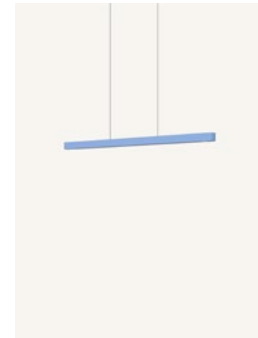

TEAM SUSPENSION
180

Office Collection

XT-A Series



XT-A SINGLE
188



XT-A PLUS
194



XT-A PLUS T
198



XT-A DIRECT
202



XT-A CEILING
202

XT-S Series



XT-S ONE
212



XT-S TWO
216



XT-S SUSPENSION
222

Home Collection

DE Gutes Licht schafft ein Zuhause, indem es Wärme, Komfort und Atmosphäre in jede Umgebung bringt. Die Leuchten unserer Home Collection beleben Wohnräume. Sie verbinden brillantes Licht mit markant skulpturalen Formen und individueller Steuerung. Unsere Designs liefern ein aktives und kreatives Lichtelebnis – zum Beispiel mit Hilfe von dynamischen Dimm- und Höhenverstellungssystemen oder als kabellose Lichtobjekte.

EN Good light is the making of a home, bringing warmth, comfort, and atmosphere to each room. Our Home Collection luminaires both illuminate and animate a living space, combining brilliant light with striking sculptural forms and adaptive settings. Designs are tailored towards an active and creative experience of light, from our cable-free lamps to dynamic dimming and height-adjustment systems.

Tisch / Table

FALLING IN LOVE

DE Die kompakte und charakterstarke FALLING IN LOVE ist eine hinreißende Begleiterin. Mit ihrer niedlichen, runden Form und optischer Linse kreiert sie einen brillanten Lichtschein — ideal um Objekte, Oberflächen oder ein Lieblingsbild zu beleuchten.

EN Compact in design, big on character, FALLING IN LOVE is an irresistible companion of a lamp. With its neat spherical form, the lamp seamlessly integrates into any chosen setting and creates an ideal spotlight for objects, surfaces, or artworks.

Designpreise / Awards

- 2009 Good Design Award
- 2010 Design Plus Award
- 2011 Diners Club Magazin Award – Silber



Varianten / Variants

FALLING IN LOVE

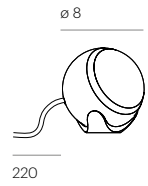

Features / Features

 Warm Dim 2700 – 2200 K



 Dimmer integriert /
Dimmer integrated



Eigenschaften / Specifications

LED / LED
DIMMUNG / DIMMING
ENERGIEEFFIZIENZ / ENERGY EFFICIENCY
NENNSPANNUNG / VOLTAGE
MATERIAL / MATERIAL

350 lm, 6 W, 2700 – 2200 K, CRI > 90
Dimmer integriert / Dimmer integrated
A++ – A
220 – 240 V
Aluminium, Santoprene / Aluminium, santoprene

Farben / Colors

 Black, Black
 Chrome, Black

 White, White
 Chrome, White

Alle Abmessungen in cm /
All dimensions in cm

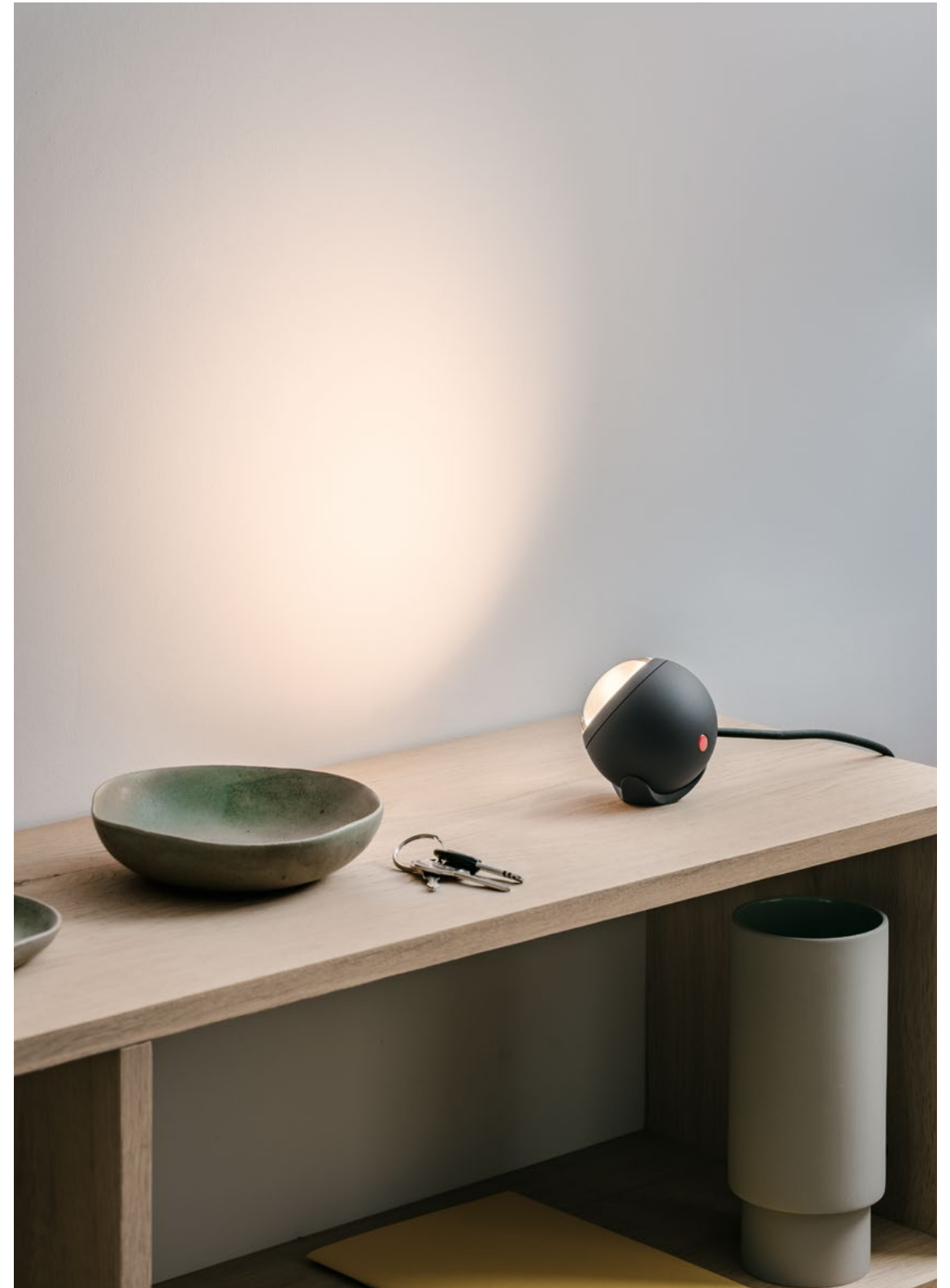

Leuchte, Sockel /
Lamp, base

LOVE FOCUS

DE Der leistungsstarke Strahler mit veränderbarem Abstrahlwinkel ist ein verspieltes Lichtwerkzeug. Beleuchte mit LOVE FOCUS Objekte, Bilder und Räume. Mit einer einfachen Drehung am Leuchtenkopf, kann der Lichtkegel fokussiert werden.

EN Set in its own nest, LOVE FOCUS is a powerful spotlight with adjustable beam to illuminate objects and surfaces with precision. Expand and focus the beam angle with a simple rotation of the lamp head.

Designpreise / Awards
2020 German Design Award



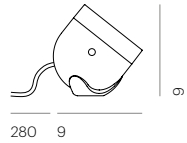

Varianten / Variants

LOVE FOCUS



Features / Features

 Warm Dim
2700 – 2200 K

 Fokussierbarer Abstrahlwinkel 35° – 80° / Focusable beam angle 35° – 80°

 Dimmer integriert / Dimmer integrated

Eigenschaften / Specifications

LED / LED
DIMMUNG / DIMMING
ENERGIEEFFIZIENZ / ENERGY EFFICIENCY
NENNSPANNUNG / VOLTAGE
MATERIAL / MATERIAL

420 – 470 lm, 11,5 W, 2700 – 2200 K, CRI > 90
Dimmer integriert / Dimmer integrated
A++ – A
220 – 240 V
Aluminium, Santoprene /
Aluminium, santoprene

Farben / Colors

 Black

 White

Alle Abmessungen in cm /
All dimensions in cm



SALT&PEPPER

DE Unsere Kerze des 21. Jahrhunderts.
Mit bis zu 100 Stunden Akkulaufzeit, versprüht
SALT&PEPPER viel Licht und Geborgenheit
auf dem Esstisch, am Bett und beim Picknick
unter den Sternen. Der Leuchtenkopf dient
als großer Touchdimmer und ermöglicht eine
besonders intuitive Dimmung.

EN A fully portable lamp, beaming
bright light like a contemporary candle.
Smooth to hold and intuitive to use,
SALT&PEPPER offers up to 100 hours
of battery life and effortless dimming
through its touch-sensitive lamp head.

Designpreise / Awards

2018 Focus Open - Gold
2019 German Design Award
2019 iF Design Award - Gold









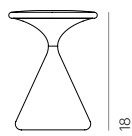

Varianten / Variants

SALT&PEPPER

ø 13



Features / Features

-  Akku 8 – 100 h /
Battery 8 – 100 h
-  Warm Dim
2700 – 2200 K
-  USB-C
(Inkl. Ladegerät /
Charger included)
-  Touch Dimmung /
Touch Dim
-  Tropfwassergeschützt /
Dripping proof – IP21

Eigenschaften / Specifications

- LED / LED
 - DIMMUNG / DIMMING
 - ENERGIEEFFIZIENZ / ENERGY EFFICIENCY
 - NENNSPANNUNG / VOLTAGE
 - GEWICHT / WEIGHT
 - HINWEIS / NOTES
 - MATERIAL / MATERIAL
- 450 lm, 5 W, 2700 – 2200 K, CRI > 90
Berührungssensitive Dimmung /
Touch-sensitive dimming
A++ – A
USB-C 120 – 240 V
0,9 kg
Batteriestatus am Boden der Leuchte ablesbar /
Battery status displayed on bottom of luminaire
Aluminium / Aluminium

Farben / Colors

-  Dark
-  Light

Alle Abmessungen in cm /
All dimensions in cm



JOHN

DE Für klares Denken. Die minimalistische und ultraflexible Tischleuchte JOHN ist ein technisches Meisterwerk. Leistungsstarke Beleuchtung wird mit überragender Beweglichkeit kombiniert. Das Licht wird über eine Linse perfekt entblendet und ist ideal zum Lesen und Arbeiten.

EN Meet the ultimate desk lamp. A masterpiece of Tobias Grau engineering, JOHN combines powerful LED lighting with outstanding mobility. The lamp's optical lens provides top glare reduction for reading and working.

Designpreise / Awards

- 2013 iF Design Award
- 2013 Red Dot Design Award
- 2016 Deutscher Designer Club
- 2016 Good Design Award
- 2018 German Design Award





Varianten / Variants

JOHN

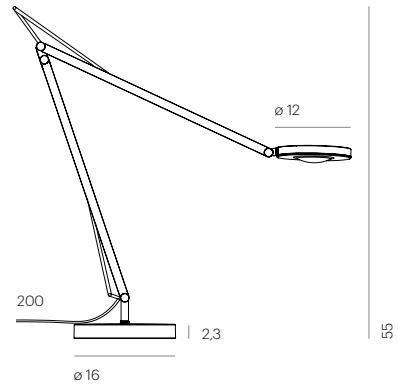

Features / Features

Warm Dim
2700 – 2200 K

Color Tune
2200 – 3500 K

Entblendung,
optische Linse /
Anti-glare, optical lens

Dimmer integriert /
Dimmer integrated

Eigenschaften / Specifications

LED / LED

700 / 850 / 950 / 1000 lm,
11 W, 2400 / 2700 / 3000 / 3500 K, CRI > 90,
850 lm, 11 W, 2700 – 2200 K, CRI >90
Dimmer integriert / Dimmer integrated

DIMMUNG / DIMMING
ENERGIEEFFIZIENZ / ENERGY EFFICIENCY
NENNSPANNUNG / VOLTAGE
HINWEIS / NOTES

A++ – A
USB-C 120 – 240 V
PIN, USM, Vitra und weitere Adaptionen erhältlich /
PIN, USM, Vitra and other adaptations available
Aluminium / Aluminium

MATERIAL / MATERIAL

Farben / Colors

● Black
● Graphite

○ White
● Light

Alle Abmessungen in cm /
All dimensions in cm



Steh / Floor

FALLING STAR FLOOR

DE Bring den Zauber der Nacht ins Haus. FALLING STAR FLOOR steht für Leichtigkeit und spielerischen Umgang mit Licht. Drei Neigungswinkel lassen sich am Fuß frei wählen.

EN Bring the magic of the night sky indoors. This versatile floor lamp offers precise and dazzling light with an adaptable angle. Simply place the lamp pole into one of the three base holes to play with different slants and effects.

Designpreise / Awards
2011 Interior Innovation Award



Varianten / Variants

FALLING STAR FLOOR

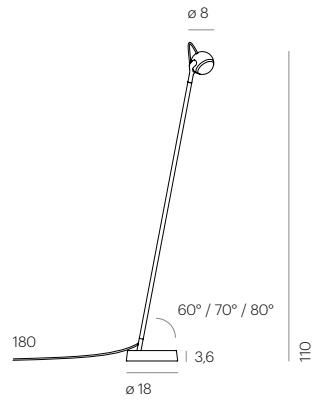

Features / Features

↕ Einstellbarer Winkel /
Adjustable angle

👆 Dimmer integriert /
Dimmer integrated

🌞 Warm Dim
2700 – 2200 K

Eigenschaften / Specifications

LED / LED
DIMMUNG / DIMMING
ENERGIEEFFIZIENZ / ENERGY EFFICIENCY
NENNSPANNUNG / VOLTAGE
MATERIAL / MATERIAL

350 lm, 6 W, 2700 – 2200 K, CRI > 90
Dimmer integriert / Dimmer integrated
A++ – A
220 – 240 V / 120 V
Aluminium, Eisen / Aluminium, iron

Farben / Colors

● Black, Black

● Chrome, Black

● Chrome, White

Alle Abmessungen in cm /
All dimensions in cm



Leuchte, Fuß /
Lamp, foot

PARROT

DE Erlebe mit PARROT eine neue Freiheit im Umgang mit Licht. Die kabellose Leuchte verbindet skulpturalen Minimalismus mit einem höhenverstellbaren Körper und beweglichen Kopf. Lade PARROT über einen innovativen Ladestein.

EN Pick up PARROT and experience a new freedom of lighting. Our fully portable standing lamp channels creative expression with its height-adjustable body and rotatable lamp head. Recharge with our innovative charging stone.

Designpreise / Awards

2019 German Design Award
2019 iF Design Award
2020 Wallpaper* Design Award





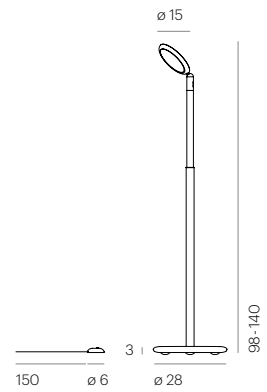

PARROT





Features / Features

 Akku 8 - 100 h /
Battery 8 - 100 h

 Warm Dim
2700 - 2200 K

 Touch Dimmung /
Touch Dim

 Smart Charge
(Ladestein inkl. /
Charger incl.)

 Höhenverstellbar
98 - 140 cm / Height-
adjustable 98 - 140 cm

 Dreh- & Schwenkbar /
Turn & Tilt (310°, 30°)

Eigenschaften / Specifications

LED / LED

DIMMUNG / DIMMING

ENERGIEEFFIZIENZ / ENERGY EFFICIENCY

NENNSPANNUNG / VOLTAGE

GEWICHT / WEIGHT

HINWEIS / NOTES

MATERIAL / MATERIAL

800 lm, 10 W, 2700 - 2200 K, CRI > 90

Berührungssensitive Dimmung /

Touch-sensitive dimming

A++ - A

USB-C 120 - 240 V

2,7 kg

Batteriestatus am Touch-Schalter angezeigt /

Battery status displayed on touch switch

Aluminium / Aluminium

Farben / Colors

 Black

 White

 Orange

 Light Blue

Alle Abmessungen in cm /
All dimensions in cm



JOHN FLOOR

DE Minimalistischer Stil und maximale Wendigkeit vereinen sich in dieser flexiblen Stehleuchte mit beweglichem Leuchtenkopf. Das Licht von JOHN FLOOR ist durch die optische Linse präzise, leistungsstark und blendfrei — ideal zum Lesen und Arbeiten.

EN Minimalist style meets maximum fluidity. JOHN FLOOR is a flexible standing lamp with top joint mobility and a rotatable lamp head. The optical lens creates precise, powerful, and glare-free light — ideal for reading and working.

Designpreise / Awards

2013 iF Design Award
2013 Red Dot Design Award
2013 Focus Open
2016 Deutscher Designer Club
2016 Good Design Award
2018 German Design Award



Varianten / Variants

JOHN FLOOR

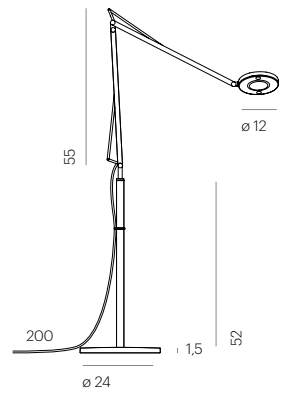

Features / Features

Warm Dim
2700 – 2200 K

Color Tune
2200 – 3500 K

Entblendung, optische
Linse / Anti-glare,
optical lens

Dimmer integriert /
Dimmer integrated

Eigenschaften / Specifications

LED / LED

700 / 850 / 950 / 1000 lm,
11 W, 2400 / 2700 / 3000 / 3500 K, CRI > 90,
850 lm, 11 W, 2700 – 2200 K, CRI >90

Dimmer integriert / Dimmer integrated

A++ – A
USB-C 120 – 240 V
Aluminium / Aluminium

DIMMUNG / DIMMING
ENERGIEEFFIZIENZ / ENERGY EFFICIENCY
NENNSPANNUNG / VOLTAGE
MATERIAL / MATERIAL

Farben / Colors

Black

Graphite

White

Light

Alle Abmessungen in cm /
All dimensions in cm



Pendel / Suspension

NICEONE

DE Mutig und modern besticht NICEONE durch Einfachheit in Perfektion. Die unbemühten und unverwechselbaren Designdetails äußern sich in der konischen Form, die stromlinienförmig mit einer sanften Krümmung zur optischen Linse hin ausläuft.

EN On upscale simplicity, NICEONE gets it just right, refining the conical form with its subtle curvature towards the lamp head. Confident and contemporary, NICEONE impresses alone, in a row, or in a powerful constellation as NICEONE RAIN.



Varianten / Variants

NICEONE UP

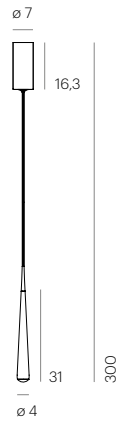

NICEONE IN

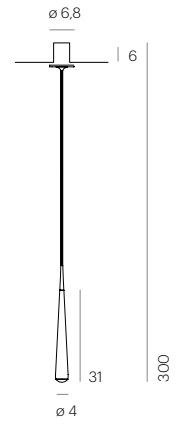

NICEONE TRACE

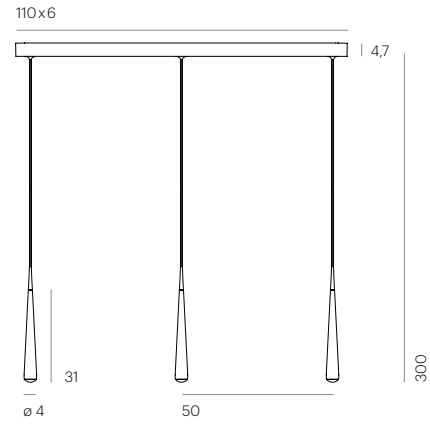

Alle Abmessungen in cm /
All dimensions in cm

Features / Features

Warm Dim
2700 – 2200 K

Bluetooth
(optional)

Eigenschaften / Specifications

LED / LED

620 lm, 11 W, 2700 – 2200 K, CRI > 90
(Pro Leuchtenkopf / Per luminaire head)

DIMMSTANDARD / DIMMING STANDARD
DIMMOPTIONEN / DIMMING OPTIONS
ENERGIEEFFIZIENZ / ENERGY EFFICIENCY
NENNSPANNUNG / VOLTAGE
DECKENTOPFFARBE / FIXTURE COLOR

Phasenabschnitt / Phase-cut
DALI, 1 – 10 V, Bluetooth
A++ – A
220 – 240 V / 120 V
UP/TRACE: Raw: Black, Black: Black, White: White,
Alu Pol: Alu Pol, Copper: White
IN: Raw: Black, Black: Black, White: White, Alu Pol: White,
Copper: White
Aluminium / Aluminium

MATERIAL / MATERIAL

Farben / Colors

- Raw
- Black
- White
- Alu Pol
- Copper



Varianten / Variants

NICEONE RAIN 3

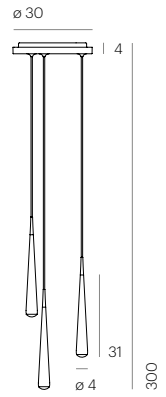

NICEONE RAIN 6

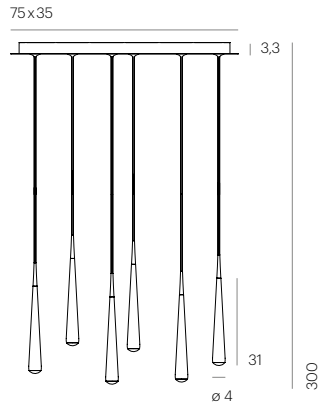

NICEONE RAIN 9

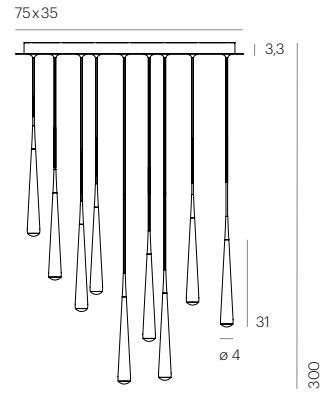
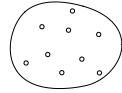

Alle Abmessungen in cm /
All dimensions in cm

Features / Features



Warm Dim
2700 – 2200 K



Bluetooth
(optional)

Eigenschaften / Specifications

LED / LED

620 lm, 11 W, 2700 – 2200 K, CRI > 90
(Pro Leuchtenkopf / Per luminaire head)

DIMMSTANDARD / DIMMING STANDARD

Phasenabschnitt / Phase-cut

DIMMOPTIONEN / DIMMING OPTIONS

DALI, 1 – 10 V, Bluetooth

ENERGIEEFFIZIENZ / ENERGY EFFICIENCY

A++ – A

NENNSPANNUNG / VOLTAGE

220 – 240 V / 120 V

DECKENTOPFFARBE / FIXTURE COLOR

Raw: Black, Black: Black, White: White,

Alu Pol: White, Copper: White

Aluminium / Aluminium

MATERIAL / MATERIAL

Farben / Colors



Raw



Black



White



Alu Pol



Copper

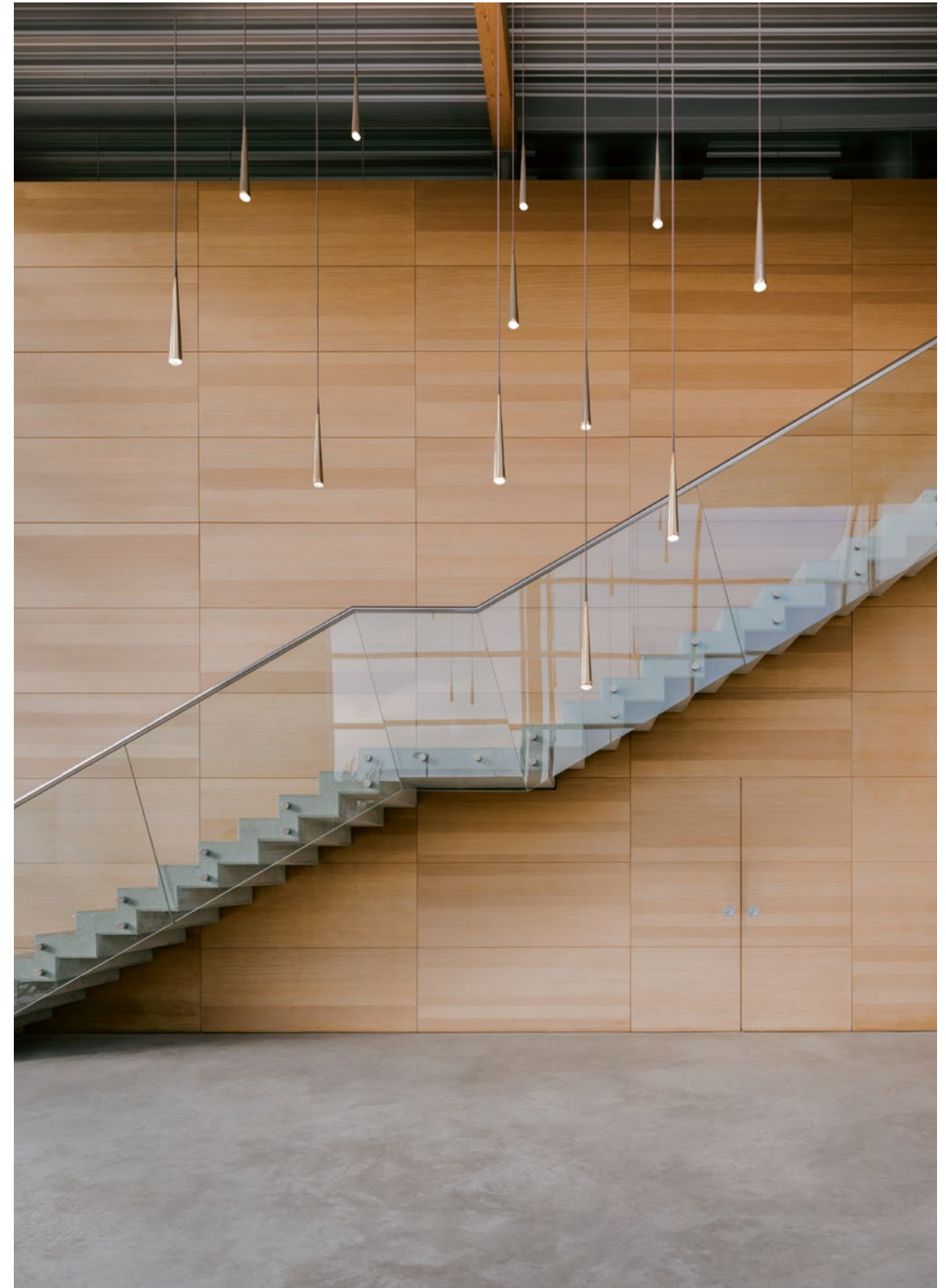

FALLING

DE FALLING verwandelt Licht in einen herabfallenden Tropfen. Mit ihrer eleganten, minimalen Form schenkt unsere ikonische Pendelleuchte brillantes Licht. Hänge sie einzeln oder als Gruppe aus drei, sechs oder neun Leuchten.

EN FALLING with the purity of raindrops. Our iconic pendant luminaire creates brilliant spots of illumination from its fresh, minimal form. Hang as a poised single pendant or as a radiant shower of light in a cluster of three, six, or nine.

Designpreise / Awards

2008 Good Design Award
2009 Red Dot Design Award
2009 Schöner Wohnen –
Neue Klassiker





Varianten / Variants

FALLING UP

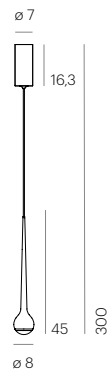

FALLING IN

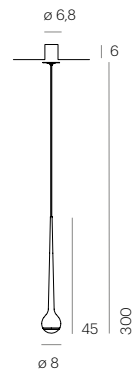

FALLING TRACE

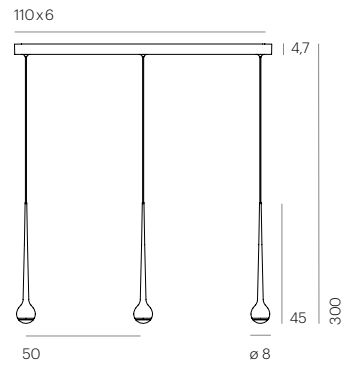

Alle Abmessungen in cm /
All dimensions in cm

Features / Features

Warm Dim
2700 – 2200 K

Bluetooth
(optional)

Eigenschaften / Specifications

LED / LED

770 lm, 11 W, 2700 – 2200 K, CRI > 94
(Pro Leuchtenkopf / Per luminaire head)

DIMMSTANDARD / DIMMING STANDARD
DIMMOPTIONEN / DIMMING OPTIONS
ENERGIEEFFIZIENZ / ENERGY EFFICIENCY
NENNSPANNUNG / VOLTAGE
DECKENTOPFFARBE / FIXTURE COLOR

Phasenabschnitt / Phase-cut
DALI, 1 – 10 V, Bluetooth
A++ – A
220 – 240 V / 120 V
Deckentopf in gleicher Farbe wie Leuchte /
Fixture same color as luminaire
Aluminium / Aluminium

MATERIAL / MATERIAL

Farben / Colors

● Black ○ White ● Alu Pol



Varianten / Variants

FALLING WATER 3

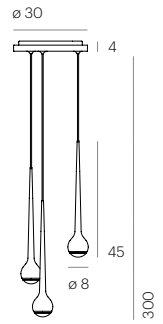

FALLING WATER 6

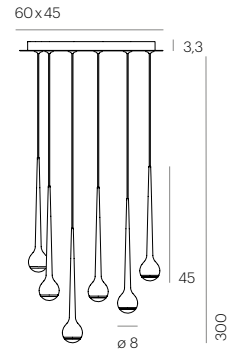

FALLING WATER 9

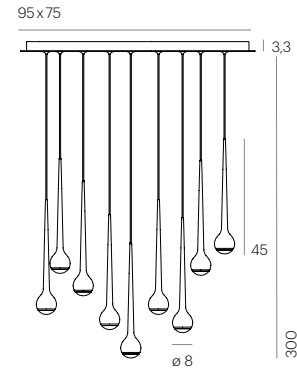
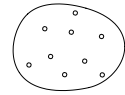

Alle Abmessungen in cm /
All dimensions in cm

Features / Features



Warm Dim
2700 – 2200 K



Bluetooth
(optional)

Eigenschaften / Specifications

LED / LED

770 lm, 11 W, 2700 – 2200 K, CRI > 94
(Pro Leuchtenkopf / Per luminaire head)
Phasenabschnitt / Phase-cut
DALI, 1 – 10 V, Bluetooth
A++ – A
220 – 240 V / 120 V
Black: Black, White: White, Alu Pol: White
Aluminium / Aluminium

DIMMSTANDARD / DIMMING STANDARD
DIMMOPTIONEN / DIMMING OPTIONS
ENERGIEEFFIZIENZ / ENERGY EFFICIENCY
NENNSPANNUNG / VOLTAGE
DECKENTOPFFARBE / FIXTURE COLOR
MATERIAL / MATERIAL

Farben / Colors



Black



White



Alu Pol

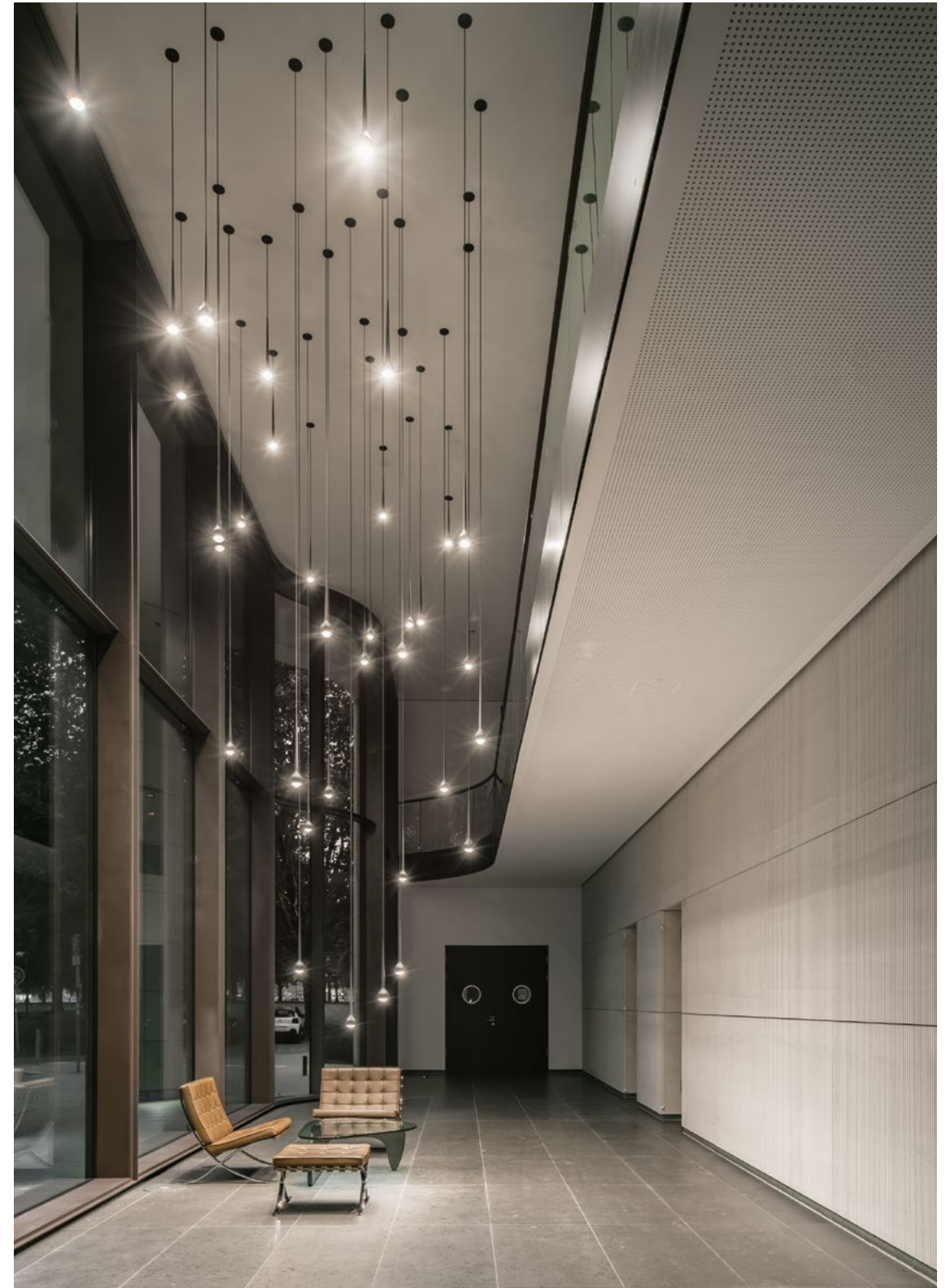

FALLING LEAF

DE Eine elegante Pendelleuchte, die ihre organische Form mit reichen Kontrasten aus poliertem Aluminium und mattem Santoprene vereint. Ihre optische Linse sorgt für brillantes Licht, das optimal entblendet wird. FALLING LEAF besticht sowohl einzeln als auch in rhythmischer Gruppe.

EN An elegant suspension luminaire blending organic form with rich textural contrasts. The lamp's state-of-the-art optical lens provides crisp, bright light and advanced glare reduction. Hang FALLING LEAF alone or as a lyrical row.

Designpreise / Awards

2012 Focus Open Award – Silber
2013 German Design Award
2013 Interior Innovation Award



Varianten / Variants

FALLING LEAF UP

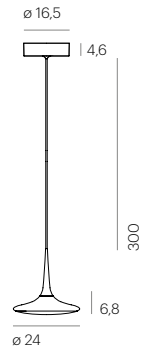

FALLING LEAF IN

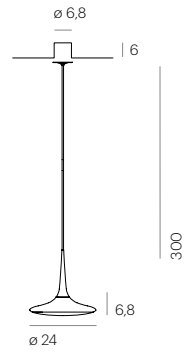

FALLING LEAF TRACE

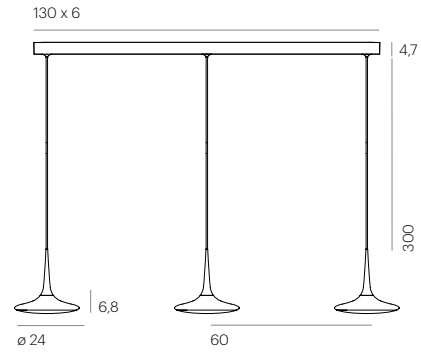

Features / Features

Warm Dim
2700 – 2200 K

Bluetooth
(optional)

Eigenschaften / Specifications

LED / LED

DIMMSTANDARD / DIMMING STANDARD
DIMMOPTIONEN / DIMMING OPTIONS
ENERGIEEFFIZIENZ / ENERGY EFFICIENCY
NENNSPANNUNG / VOLTAGE
DECKENTOPFFARBE / FIXTURE COLOR
MATERIAL / MATERIAL

1400 lm, 16 W, 2700 – 2200 K, CRI > 90
(Pro Leuchtenkopf / Per luminaire head)
Phasenabschnitt / Phase-cut
DALI, 1 – 10 V, Bluetooth
A++ – A
220 – 240 V / 120 V
Alle Varianten: Alu Pol / All variants: Alu Pol
Aluminium, Santoprene /
Aluminium, santoprene

Farben / Colors

Alu Pol, Black
Alu Pol, Charcoal
Alu Pol, Maroon

Alu Pol, White
Alu Pol, Sand

Alu Pol, Grey
Alu Pol, Olive

Alle Abmessungen in cm /
All dimensions in cm



Leuchte, Kabel /
Lamp, cable

OH CHINA

DE Hänge OH für Frieden, Zen und einzigartig strahlendes Licht. Durch das feine Bone China Porzellan und die archetypische Form, schenkt die höheninstellbare Pendelleuchte pure Harmonie.

EN Hang OH for peace, zen, and a unique warm glow. With its fine bone china and archetypal form, this height-adjustable pendant light distills simple luxury.

Designpreise / Awards

- 2001 International Design Yearbook
- 2004 International Design Yearbook
- 2018 Iconic Award
- 2018 German Innovation Award

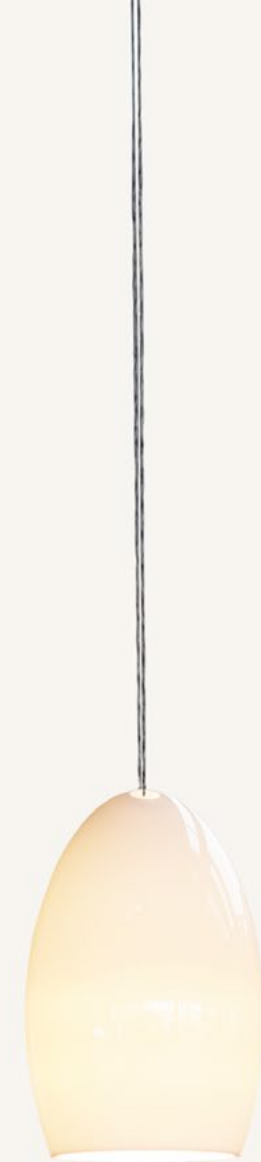



Varianten / Variants

OH CHINA UP

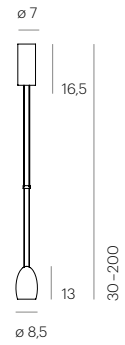

OH CHINA IN

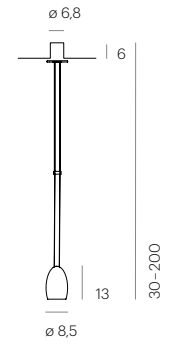

OH CHINA TRACE

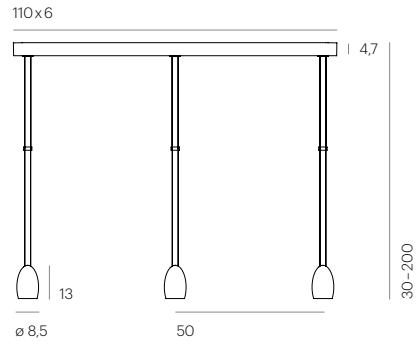

Features / Features

↑
Höhenverstellbar
bis 200 cm / Height-
adjustable up to 200 cm

⌘ Bluetooth
(optional)

Eigenschaften / Specifications

LED / LED

DIMMSTANDARD / DIMMING STANDARD
DIMMOPTIONEN / DIMMING OPTIONS
ENERGIEEFFIZIENZ / ENERGY EFFICIENCY
NENNSPANNUNG / VOLTAGE
MATERIAL / MATERIAL

OH: 415 lm, 11 W, 2200 - 2700 K CRI > 90
OH CHINA: 500 lm, 11 W, 2700 K, CRI > 90
(Pro Leuchtenkopf / Per luminaire head)
Phasenabschnitt / Phase-cut
DALI, 1 - 10 V, Bluetooth
A++ - A
220 - 240 V / 120 V
Bone China Porzellan / Bone china porcelain

Farben / Colors

● Bone China, Alu Pol

● Bone China, White

Alle Abmessungen in cm /
All dimensions in cm

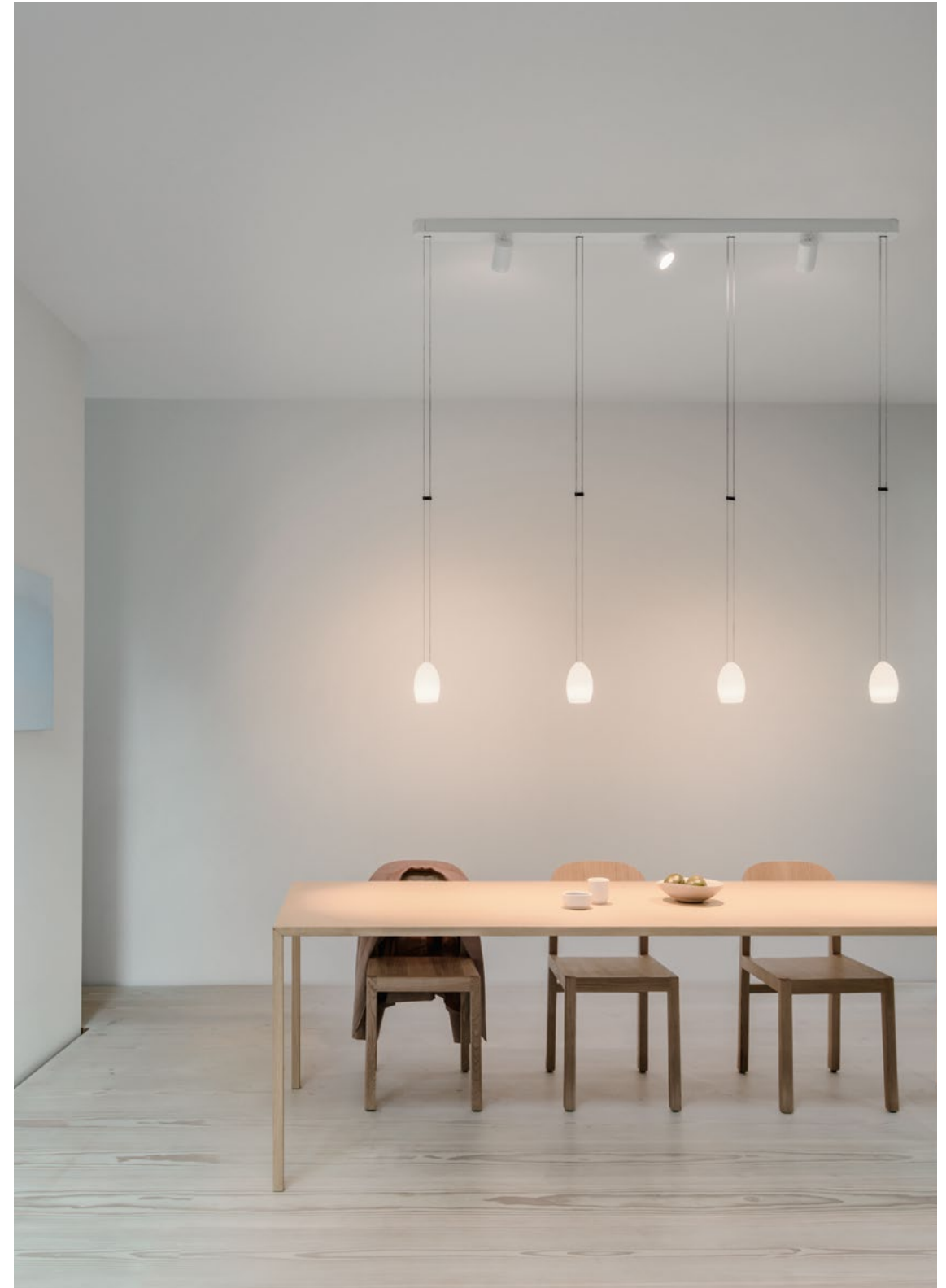

Leuchte, Deckenabingung /
Lamp, fixture

PALLA

DE Großzügig wie der Mond taucht die Kugelleuchte PALLA jede Umgebung in ein friedvolles Licht. Durch das mundgeblasene Opalglas wird das Licht harmonisch und gleichmäßig im Raum verteilt. PALLA kann einzeln oder als Gruppe gehängt werden.

EN Majestic yet tranquil, PALLA is our very own moonlight, offering a luminous focal point to any space. The mouth-blown opal glass shade provides peaceful ambient light for an entire room. PALLA can be hung individually or in constellation.





Varianten / Variants

PALLA 16 UP/IN

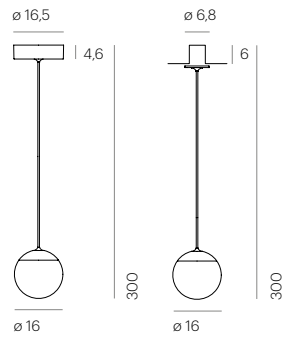

PALLA 21 UP/IN

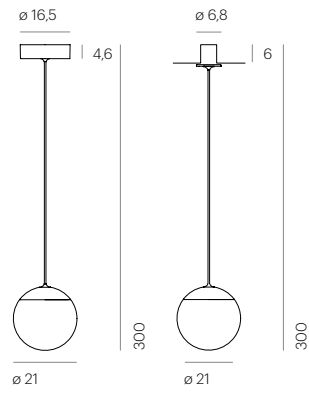

PALLA 16 RAIN 3

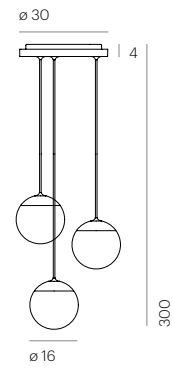

Alle Abmessungen in cm /
All dimensions in cm

Features / Features

Warm Dim
2700 – 2200 K

Bluetooth
(optional)

Eigenschaften / Specifications

LED / LED

PALLA 16: 520 lm, 11 W, 2700 – 2200 K, CRI > 90
PALLA 21: 820 lm, 16 W, 2700 – 2200 K, CRI > 90
(Pro Leuchtenkopf / Per luminaire head)
Phasenabschnitt / Phase-cut
DALI, 1 – 10 V, Bluetooth
A++ – A
220 – 240 V / 120 V
Deckentopf in gleicher Farbe wie Leuchte /
Fixture same color as luminaire
Aluminium, Opalglas / Aluminium, opal glass

DIMMSTANDARD / DIMMING STANDARD
DIMMOPTIONEN / DIMMING OPTIONS
ENERGIEEFFIZIENZ / ENERGY EFFICIENCY
NENNSPANNUNG / VOLTAGE
DECKENTOPFFARBE / FIXTURE COLOR

MATERIAL / MATERIAL

Farben / Colors

Black

Alu Pol



FLYING

DE Majestätisch schwebt FLYING im Raum. Frei Höhenverstellbar, taucht diese auffallend grazile Pendelleuchte jeden Raum und Ess- oder Konferenztisch in einen überreichen Schauer aus Licht. Lichtfarbe und Lichtintensität können über Bluetooth variiert werden.

EN Majestic FLYING floats in space. Freely lowered and raised with patented height adjustment system, this versatile luminaire casts a lavish wash of light for meeting rooms, dining tables, or architectural illumination.

Designpreise / Awards

2020 German Design Award –
Gold

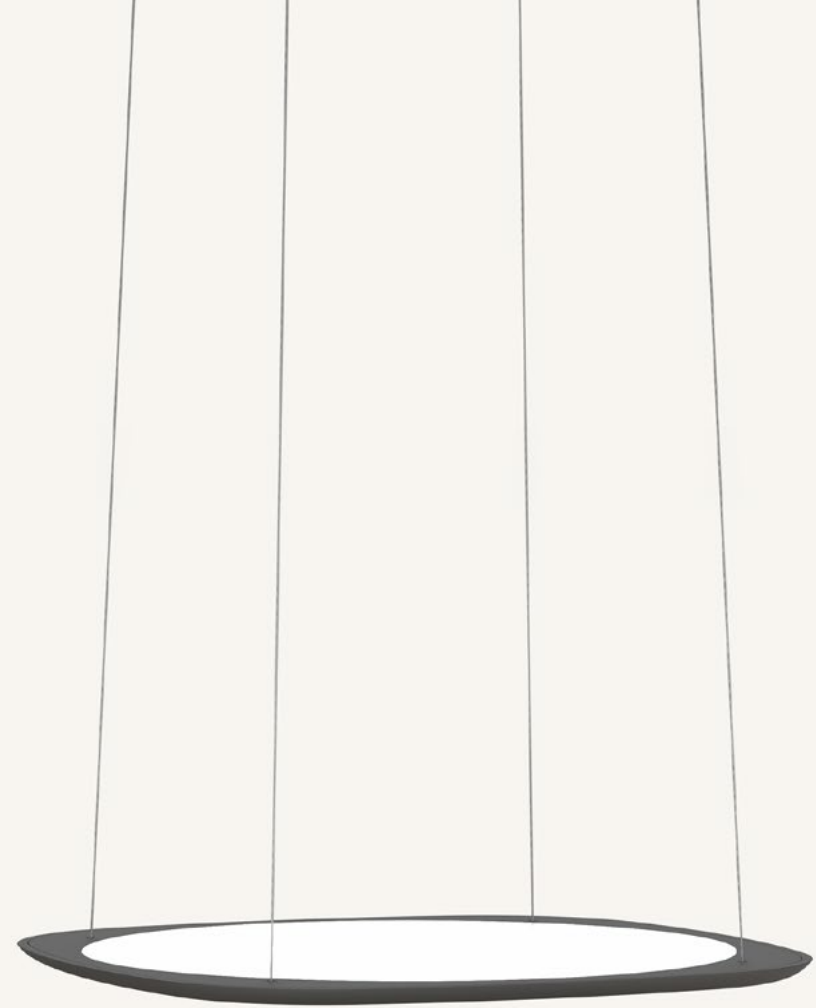



Varianten / Variants

FLYING

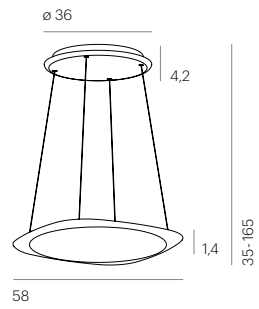

Features / Features

Warm Dim
2700 – 2200 K

↑
Höhenverstellbar
35 – 165 cm / Height-
adjustable 35 – 165 cm

Bluetooth
(integriert / integrated)

Color Tune
2200 – 3500 K

50/50
Lichtverteilung 50/50 /
Light distribution 50/50

Eigenschaften / Specifications

LED / LED
DIMMUNG / DIMMING
ENERGIEEFFIZIENZ / ENERGY EFFICIENCY
NENNSPANNUNG / VOLTAGE
DECKENTOPFFARBE / FIXTURE COLOR

4800 lm, 50 W, 2200 – 3500 K, CRI > 90
Bluetooth
A++ – A
120 – 240 V
Deckentopf in gleicher Farbe wie Leuchte
(weißer Deckentopf auf Anfrage möglich) /
Fixture same color as luminaire
(white fixture upon request)
Aluminium / Aluminium

MATERIAL / MATERIAL

Farben / Colors

● Black

○ White

○ Rosé

Alle Abmessungen in cm /
All dimensions in cm



MOVE AROUND

DE Fließende Kurven und kleine Sonnen aus Licht machen MOVE AROUND zu einer unserer außergewöhnlichsten Leuchten. Der runde Körper kombiniert seine elegante Form mit brillanten Linsen, die das Licht optimal entblenden.

EN A surface rippling like water and light beaming out like sun-rays make MOVE AROUND one of our most exquisite suspension luminaires. The circular lamp combines its supple undulating form with optical lenses for optimal deglaring.



Varianten / Variants

MOVE AROUND

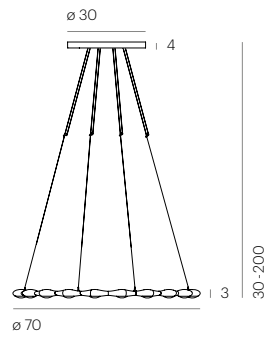

MOVE AROUND INDIRECT

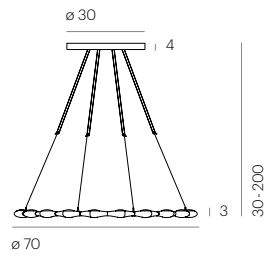

Features / Features

Warm Dim
2700 – 2200 K

↑ ↓
Höheneinstellbar
bis 200 cm / Height-
adjustable up to 200 cm

⌘ Bluetooth
(optional)

Eigenschaften / Specifications

LED / LED
DIMMSTANDARD / DIMMING STANDARD
DIMMOPTIONEN / DIMMING OPTIONS
ENERGIEEFFIZIENZ / ENERGY EFFICIENCY
NENNSPANNUNG / VOLTAGE
DECKENTOPFFARBE / FIXTURE COLOR
MATERIAL / MATERIAL

2700 lm, 50 W, 2700 – 2200 K, CRI > 90
Phasenabschnitt / Phase-cut
DALI, 1 – 10 V, Bluetooth
A++ – A
220 – 240 V / 120 V
Chrome: Alu Pol, Copper: White
Aluminium / Aluminium

Farben / Colors

● Chrome

● Copper

Alle Abmessungen in cm /
All dimensions in cm

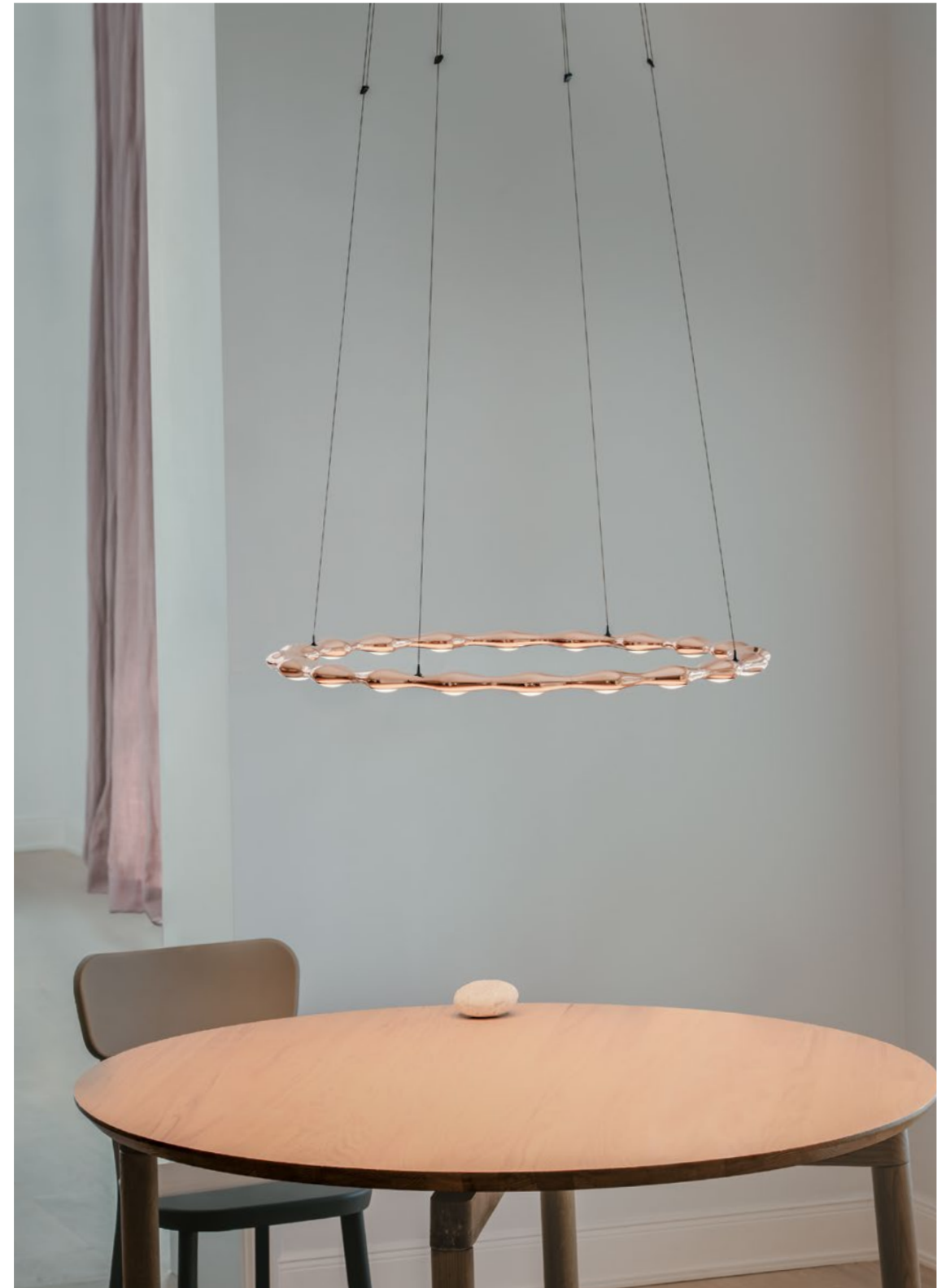

MOVE ALONG

DE MOVE ALONG ist organisch schön und irgendwie unbeschreiblich. Das skulpturale Lichtobjekt in Chrome oder Kupfer ist belebt durch warm leuchtende Linsen und verwandelt den Raum durch seine einzigartige Präsenz.

EN Supple forms shimmer in MOVE ALONG, an opulent luminaire in polished copper or chrome. The lamp's sculptural body integrates a multitude of cutting-edge LEDs with optical lenses for a dazzling wash of golden, de-glared light.



MOVE ALONG 6

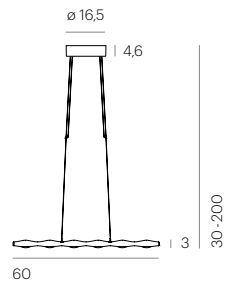

MOVE ALONG 9

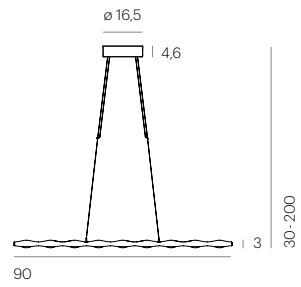

MOVE ALONG 12

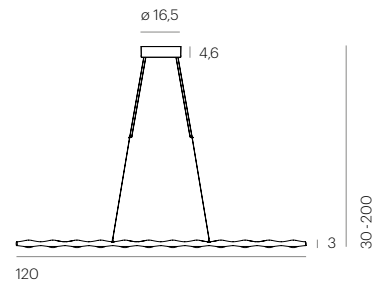

Alle Abmessungen in cm /
All dimensions in cm

Features / Features

Warm Dim
2700 – 2200 K

↕ Höhereinstellbar
bis 200 cm / Height-
adjustable up to 200 cm

Bluetooth
(optional)

Eigenschaften / Specifications

LED / LED

Variante 6 / Variant 6: 800 lm, 16 W, 2700 K, CRI > 90
 Variante 9 / Variant 9: 1200 lm, 23 W, 2700 K, CRI > 90
 Variante 12 / Variant 12: 1600 lm, 28 W, 2700 K, CRI > 90
 Phasenabschnitt / Phase-cut
 DALI, 1 – 10 V, Bluetooth
 A++ – A
 220 – 240 V / 120 V
 Chrome: Alu Pol, Copper: White
 Aluminium / Aluminium

DIMMSTANDARD / DIMMING STANDARD
 DIMMOPTIONEN / DIMMING OPTIONS
 ENERGIEEFFIZIENZ / ENERGY EFFICIENCY
 NENNSPANNUNG / VOLTAGE
 DECKENTOPFFARBE / FIXTURE COLOR
 MATERIAL / MATERIAL

Farben / Colors

● Chrome

● Copper



DANCE

DE Halte dich klar und dynamisch mit DANCE, einer Pendelleuchte, die jedem Esstisch Stimmung schenkt. Das Licht wird über Bone China Porzellan Scheiben blendfrei auf den Tisch und athmosphärisch in den Raum abgegeben.

EN Bring flair to any meeting or dining table with DANCE, our dynamic suspension luminaire. Light is delivered glare-free onto the table surface through optical glass lenses and upwards through bone china discs for an atmospheric glow.

Designpreise / Awards
2004 Design Awards London



Varianten / Variants

DANCE

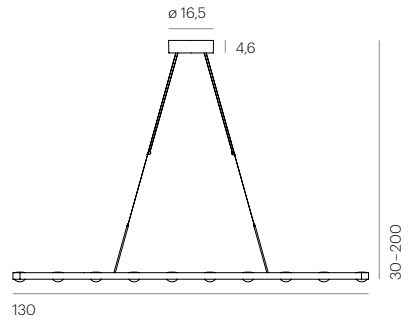

Features / Features

● Warm Dim
2700 – 2200 K

↑↓ Höhereinstellbar
bis zu 200 cm / Height
adjustable up to 200 cm

⌘ Bluetooth
(optional)

Eigenschaften / Specifications

LED / LED
DIMMSTANDARD / DIMMING STANDARD
DIMMOPTIONEN / DIMMING OPTIONS
ENERGIEEFFIZIENZ / ENERGY EFFICIENCY
NENNSPANNUNG / VOLTAGE
DECKENTOPFFARBE / FIXTURE COLOR

950 lm, 15 W, 2700 – 2200 K, CRI > 90
Phasenabschnitt / Phase-cut
DALI, 1 – 10 V, Bluetooth
A++ – A
220 – 240 V / 120 V
Deckentopf in gleicher Farbe wie Leuchte /
Fixture same color as luminaire
Aluminium, Bone China Porzellan /
Aluminium, bone china porcelain

MATERIAL / MATERIAL

Farben / Colors

● Alu Pol

Alle Abmessungen in cm /
All dimensions in cm



Strahler / Spot

SET

DE Hell und modern – SET ist unser Allround-Strahler mit einer Vielzahl an Befestigungsmöglichkeiten und einer außergewöhnlich guten Entblendung. Als Teil unseres CHOICE Systems, kann SET beliebig mit anderen Leuchten kombiniert werden.

EN Crisp, bright, and highly efficient, SET is a compact spotlight with advanced glare control. As part of the CHOICE system, SET can be combined with a variety of different fixtures to create an individual luminaire. The light is rotatable and swivel-mounted.

Designpreise / Awards

2015 Interior Innovation Award
2015 iF Design Award



Varianten / Variants

SET UP

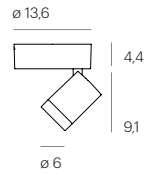

SET IN

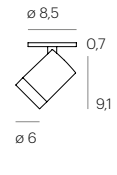

SET DUO

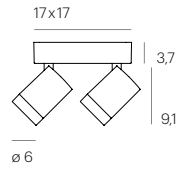

SET EURO

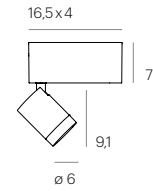

SET TRACE

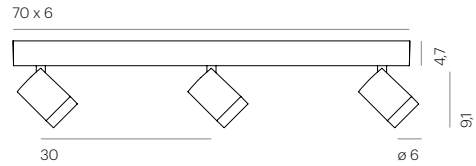

Features / Features



Warm Dim
2700 – 2200 K



Dreh-&Schwenkbar /
Turn&Tilt (90°, 145°)



Bluetooth
(optional)

Eigenschaften / Specifications

LED / LED

310 – 350 lm, 11 W, 2700 – 2200 K, CRI > 90
(Pro Leuchtenkopf / Per luminaire head)

DIMMSTANDARD / DIMMING STANDARD

Phasenabschnitt / Phase-cut

DIMMOPTIONEN / DIMMING OPTIONS

DALI, 1 – 10 V, Bluetooth

ENERGIEEFFIZIENZ / ENERGY EFFICIENCY

A++ – A

NENNSPANNUNG / VOLTAGE

220 – 240 V

HINWEIS / NOTES

IN-Variante Einbautiefe /

IN-variant mounting depth: \varnothing 6,8 cm, 6 cm

Aluminium / Aluminium

MATERIAL / MATERIAL

Farben / Colors



Black



White



Alu Pol

Alle Abmessungen in cm /
All dimensions in cm

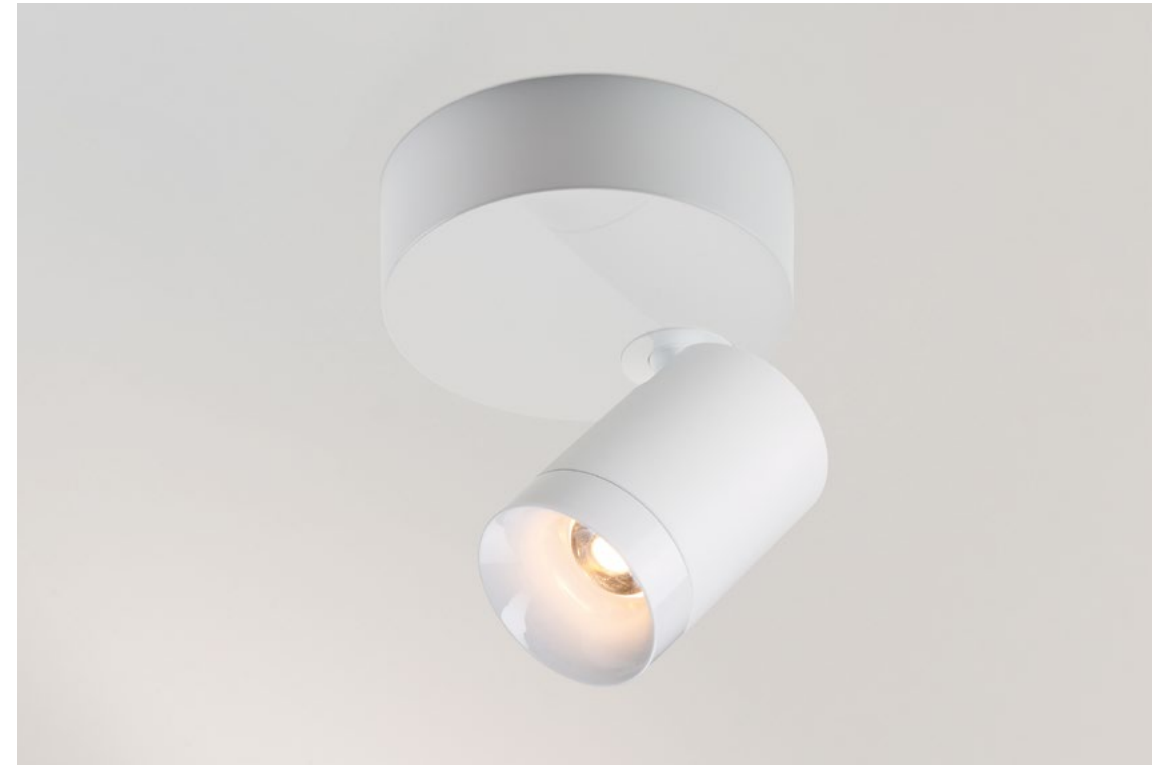

CLEAR

DE CLEAR ist ein präziser Strahler in eleganter Form. Er ist vielseitig einsetzbar und kann über den CHOICE Konfigurator mit Pendelleuchten zu einem ganzheitlichen Lichtsystem kombiniert werden.

EN A sleek and precise spotlight, CLEAR is available in a range of colors and optics for versatile effects. Use our CHOICE configurator to combine CLEAR with pendant lights in a holistic lighting scheme.



Varianten / Variants

CLEAR UP

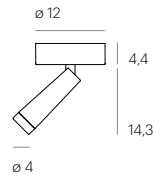

CLEAR IN

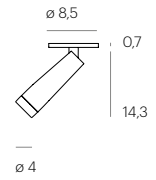

CLEAR DUO

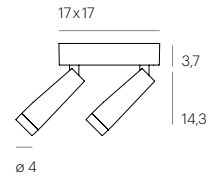

CLEAR TRIO

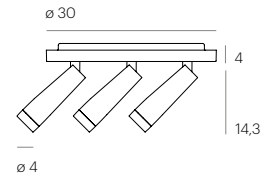

Alle Abmessungen in cm /
All dimensions in cm

Features / Features

Warm Dim
2700 – 2200 K

Dreh-&Schwenkbar /
Turn&Tilt (90°, 145°)

Bluetooth
(optional)

Eigenschaften / Specifications

LED / LED

190 – 590 lm, 11 W, 2700 – 2200 K, CRI > 90
(Pro Leuchtenkopf / Per luminaire head)

DIMMSTANDARD / DIMMING STANDARD
DIMMOPTIONEN / DIMMING OPTIONS
ENERGIEEFFIZIENZ / ENERGY EFFICIENCY
NENNSPANNUNG / VOLTAGE
HINWEIS / NOTES

Phasenabschnitt / Phase-cut
DALI, 1 – 10 V, Bluetooth
A++ – A
220 – 240 V / 120 V
IN-Variante Einbautiefe /
IN-variant mounting depth: \varnothing 6,8 cm, 6 cm
Aluminium / Aluminium

MATERIAL / MATERIAL

Farben / Colors

Black, Black

White, White

Alu Pol, Glow

Leuchte, Optik /
Lamp, optic



SET FOCUS

DE Punktlandung. SET FOCUS ist ein leistungsstarker Strahler mit einem veränderbaren Abstrahlwinkel, der Flächen, Bilder oder Gegenstände präzise beleuchtet. Mit einer einfachen Drehung am Kopf der Leuchte kann das Licht fokussiert werden.

EN SET FOCUS is right on cue — a powerful spot with an adjustable beam angle, which illuminates surfaces, pictures or objects with precision. With a simple rotation of the lamp-head reflector, the light beam can be expanded or focused.





Varianten / Variants

SET FOCUS UP

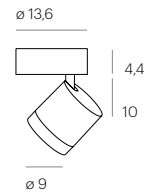

SET FOCUS IN

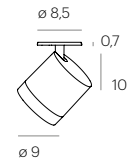

SET FOCUS DUO

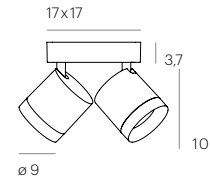

SET FOCUS EURO

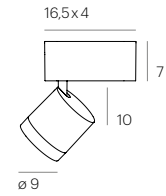

SET FOCUS TRACE



Features / Features

📐 Einstellbarer Abstrahlwinkel 35° - 80° / Adjustable beam angle 35° - 80°

🔄 Dreh-&Schwenkbar / Turn & Tilt (320°, 90°)

📶 Bluetooth (optional)

Eigenschaften / Specifications

LED / LED

1250 lm, 16 W, 2700 K, CRI > 90
1700 lm, 16 W, 3500 K, CRI > 80
(Pro Leuchtenkopf / Per luminaire head)
Phasenabschnitt / Phase-cut

DIMMSTANDARD / DIMMING STANDARD
DIMMOPTIONEN / DIMMING OPTIONS
ENERGIEEFFIZIENZ / ENERGY EFFICIENCY
NENNSPANNUNG / VOLTAGE
HINWEIS / NOTES

DALI, 1 - 10 V
A++ - A
220 - 240 V / 120 V
IN-Variante Einbautiefe /
IN-variant mounting depth: ø 6,8 cm, 6 cm
Aluminium / Aluminium

MATERIAL / MATERIAL

Farben / Colors

● Black

○ White

Alle Abmessungen in cm /
All dimensions in cm



STUDIO

DE STUDIO ist ein eleganter und leistungsstarker Strahler. Das Strahlersystem bietet unterschiedliche Varianten an Wand-, Decken und Pendelleuchten und kann über unseren CHOICE Konfigurator mit anderen Leuchten kombiniert werden.

EN STUDIO is an elegant high-performance spotlight, compact and vivid in its quadratic form. The collection includes surface-mounted, recessed and Eurotrack variants as well as a range of wall, ceiling and suspension lamps featuring quadruple spotlights.

Designpreise / Awards

2013 iF Design Award

2014 German Design Award



Varianten / Variants

STUDIO UP

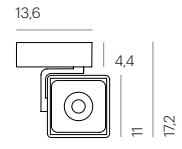

STUDIO IN

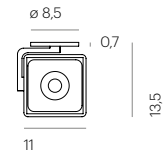

STUDIO DUO

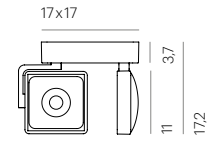

STUDIO EURO

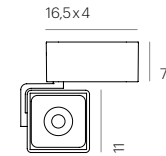

STUDIO TRACE

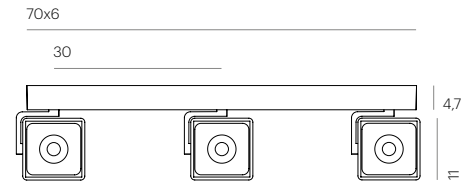

Features / Features



Warm Dim
2700 – 2200 K



Dreh-&Schwenkbar /
Turn&Tilt (270°, 270°)



Bluetooth
(optional)

Eigenschaften / Specifications

LED / LED

830 lm, 15 W, 2700 – 2200 K, CRI > 90
845 lm, 16 W, 3500 K, CRI > 80
(Pro Leuchtenkopf / Per luminaire head)

DIMMSTANDARD / DIMMING STANDARD
DIMMOPTIONEN / DIMMING OPTIONS
ENERGIEEFFIZIENZ / ENERGY EFFICIENCY
NENNSPANNUNG / VOLTAGE
HINWEIS / NOTES

Phasenabschnitt / Phase-cut
DALI, 1 – 10 V
A++ – A
220 – 240 V / 120 V
IN-Variante Einbautiefe /
IN-variant mounting depth: ø 6,8 cm, 6 cm
Aluminium / Aluminium

MATERIAL / MATERIAL

Farben / Colors

● Alu Pol, Black

● Alu Pol, White

● Satin, Black

● Satin, White

Alle Abmessungen in cm /
All dimensions in cm

Leuchte, Deckenmontierung /
Lamp, fixture



Decke / Ceiling

GLOBE

DE Die Reduktion auf das Wesentliche bestimmt das Design von GLOBE. Der flache Leuchtenkörper aus Metall verbindet sich mit einer großen optischen Linse, durch die gleichmäßiges Licht blendfrei abgegeben wird.

EN GLOBE combines formal minimalism with a generous optical lens for a wash of warm, even, and glare-free light. The surface-mounted luminaire is available in black, white, copper, and polished aluminium.



Varianten / Variants

GLOBE UP

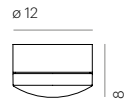

GLOBE IN

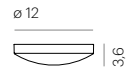

Eigenschaften / Specifications

LED / LED
DIMMSTANDARD / DIMMING STANDARD
DIMMOPTIONEN / DIMMING OPTIONS
ENERGIEEFFIZIENZ / ENERGY EFFICIENCY
NENNSPANNUNG / VOLTAGE
HINWEIS / NOTES

MATERIAL / MATERIAL

930 lm, 12 W, 2700 K, CRI > 90
Phasenabschnitt / Phase-cut
GLOBE IN: DALI, 1 – 10 V, Bluetooth
A++ – A
220 – 240 V / 120 V
IN-Variante Einbautiefe: ø 10 cm, 10,5 cm /
IN-variant mounting depth: ø 10 cm, 10,5 cm
Aluminium, PC-Glas / Aluminium, PC-glass

Farben / Colors

● Black
● Alu Pol

○ White
● Copper

Alle Abmessungen in cm /
All dimensions in cm

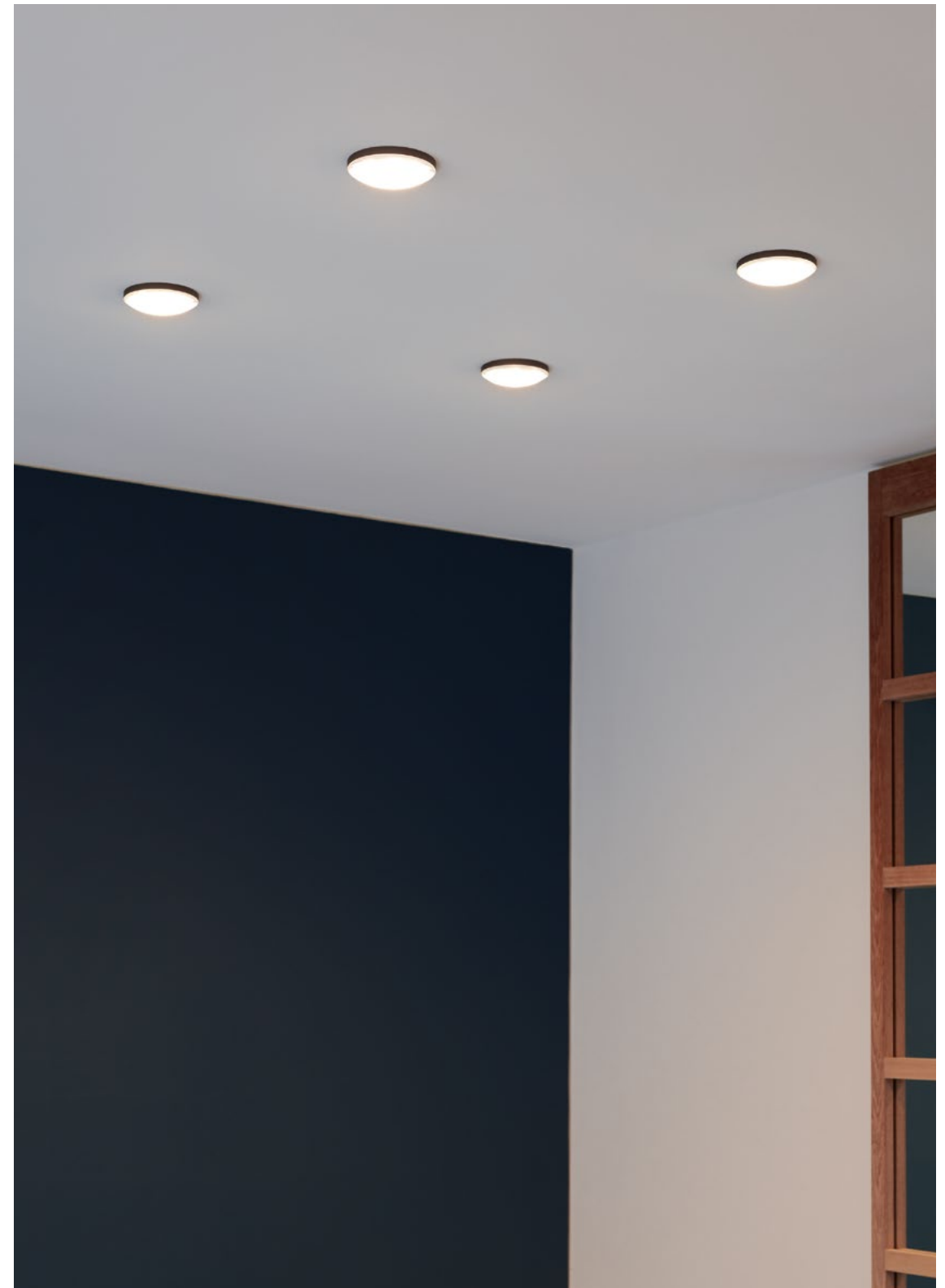

GLOBE BOX

DE GLOBE BOX ist eine lichtstarke und rundum entblendete Aufbauleuchte, mit ästhetischer Asymmetrie. Sie eignet sich hervorragend zur Beleuchtung von kleinen Räumen, wie Fluren, Küchen oder Treppenhäusern.

EN GLOBE BOX is an elegant, surface-mounted luminaire with a playful asymmetry. Its smooth metallic case integrates powerful LEDs for vivid and glare-free light, ideal for animating and illuminating hallways, stairways, and small rooms.





Varianten / Variants

GLOBE BOX

ø 16,5

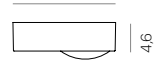

Eigenschaften / Specifications

LED / LED
DIMMSTANDARD / DIMMING STANDARD
DIMMOPTIONEN / DIMMING OPTIONS
ENERGIEEFFIZIENZ / ENERGY EFFICIENCY
NENNSPANNUNG / VOLTAGE
MATERIAL / MATERIAL

747 lm, 11 W, 2700 K, CRI > 90
Phasenabschnitt / Phase-cut
DALI, 1 - 10 V
A++ - A
220 - 240 V
Aluminium / Aluminium

Farben / Colors

● Black ○ White ● Alu Pol

Alle Abmessungen in cm /
All dimensions in cm



PALLA CEILING

DE Die klassische Form der Kugelleuchte erhält mit PALLA eine neue und markante Ausprägung, die durch ihre fließenden Übergänge zum Ausdruck kommt. Durch mundgeblasenes Opalglas wird Licht harmonisch und gleichmäßig in den Raum abgegeben.

EN Smooth and luminous, the PALLA ceiling light brings a serene glow to any room. Light is emitted evenly and harmoniously through the mouth-blown opal glass shade. Used individually or in groups, the lamp is suitable for both surface and ambient illumination.



Varianten / Variants

PALLA 16 CEILING UP

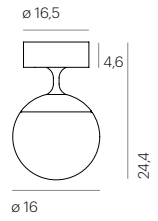

PALLA 16 CEILING IN

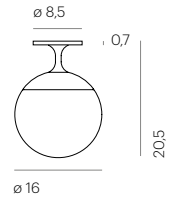

PALLA 21 CEILING UP

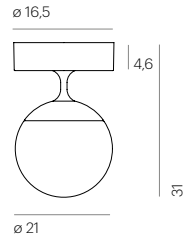

PALLA 21 CEILING IN

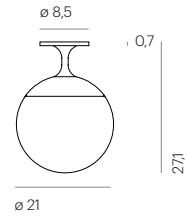

Alle Abmessungen in cm /
All dimensions in cm

Features / Features

Warm Dim
2700 – 2200 K

Bluetooth
(optional)

Eigenschaften / Specifications

LED / LED

DIMMSTANDARD / DIMMING STANDARD
DIMMOPTIONEN / DIMMING OPTIONS
ENERGIEEFFIZIENZ / ENERGY EFFICIENCY
NENNSPANNUNG / VOLTAGE
HINWEIS / NOTES

MATERIAL / MATERIAL

PALLA 16: 600 lm, 11 W, 2700 – 2200 K, CRI > 90
PALLA 21: 890 lm, 16 W, 2700 – 2200 K, CRI > 90
Phasenabschnitt / Phase-cut
DALI, 1 – 10 V, Bluetooth
A++ – A
220 – 240 V / 120 V
IN-Variante Einbautiefe /
IN-variant mounting depth: \varnothing 6,8 cm, 6 cm
Opalglas / Opal glass

Farben / Colors

Black

Alu Pol



OCEAN

DE OCEAN ist von Wellen umgeben.
Das mundgeblasene Glas in plissierter
Form gibt das Licht direkt in den Raum
ab und hat dabei eine weiche und
breitstrahlende Lichtwirkung.

EN Light ripples from WAVES, a mouth-blown
glass lamp with an exquisite pleated surface.
Affix to the ceiling or a wall for beautiful
organic texture and a warm wash of light.



Varianten / Variants

OCEAN

ø 50

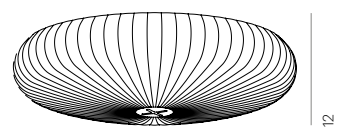

Features / Features



Bluetooth
(optional)

Eigenschaften / Specifications

LED / LED
DIMMSTANDARD / DIMMING STANDARD
DIMMOPTIONEN / DIMMING OPTIONS
ENERGIEEFFIZIENZ / ENERGY EFFICIENCY
NENNSPANNUNG / VOLTAGE
MATERIAL / MATERIAL

2050 lm, 32 W, 2700 K, CRI >90
Phasenabschnitt / Phase-cut
DALI, 1 - 10 V, Bluetooth
A++ - A
220 - 240 V
Opalglas, Aluminium /
Opal glass, aluminium

Farben / Colors



White

Alle Abmessungen in cm /
All dimensions in cm



Wand / Wall

GLOBE WALL

DE Reduktion auf das Wesentliche — GLOBE WALL bringt einen klaren Ausdruck an die Wand. Der hochwertige Aluminiumkörper ist mit großen optischen Linsen kombiniert, die das Licht blendfrei nach oben und unten abgeben. Erhältlich in zwei Größen.

EN A reduction to the essentials determines the design of GLOBE WALL, a pristine choice for ambient room lighting. The sleek metal body is combined with a large optical lens, which distributes warm and glare-free light in both an upward and downward direction. Available in two sizes.



Varianten / Variants

GLOBE WALL 6

14,8x6

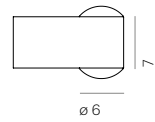

GLOBE WALL 12

21,5x12

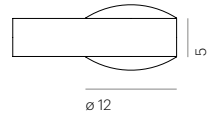

Eigenschaften / Specifications

LED / LED

DIMMSTANDARD / DIMMING STANDARD
DIMMOPTIONEN / DIMMING OPTIONS
ENERGIEEFFIZIENZ / ENERGY EFFICIENCY
NENNSPANNUNG / VOLTAGE
MATERIAL / MATERIAL

GLOBE WALL 6: 325 lm, 12 W, 2700 K, CRI > 90
GLOBE WALL 12: 747 lm, 12 W, 2700 K, CRI > 90
Phasenabschnitt / Phase-cut
GLOBE WALL 12: DALI, 1 - 10 V
A++ - A
220 - 240 V
Aluminium / Aluminium

Farben / Colors

● Black ○ White ● Alu Pol

Alle Abmessungen in cm /
All dimensions in cm

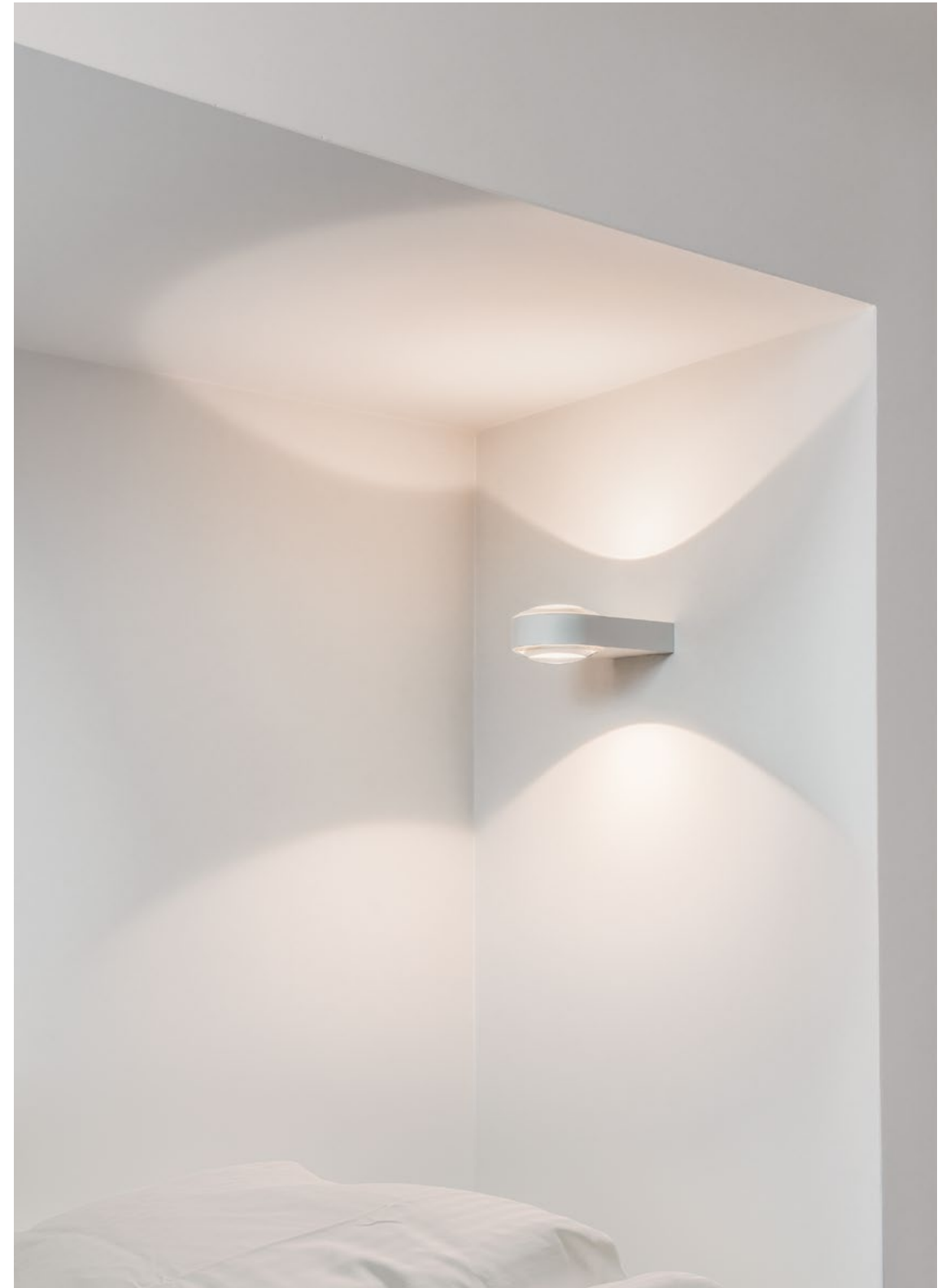

SIMPLE

DE SIMPLE ist einfach schön. Auf Augenhöhe montiert, flutet ihr Licht durch zwei Linsen nach unten und oben. Genieße die angenehme Art dieser subtilen Wandleuchte.

EN Available in various metallic finishes, SIMPLE adds discrete character to any wall. Mounted approximately at eye level, it is glare-free and simultaneously casts its light upwards and downwards through two sheets of satin-finish glass.

Designpreise / Awards

2006 Schöner Wohnen –
Neue Klassiker



Varianten / Variants

SIMPLE

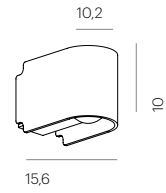

FREE SIMPLE *

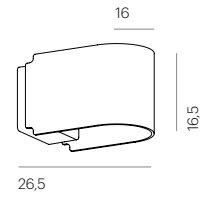

Features / Features

☼ Außenleuchte IP44 * /
Outdoor IP44 *

Eigenschaften / Specifications

LED / LED
LEUCHTMITTEL / ILLUMINANT
DIMMSTANDARD / DIMMING STANDARD
ENERGIEEFFIZIENZ / ENERGY EFFICIENCY
NENNSPANNUNG / VOLTAGE
HINWEIS / NOTES

MATERIAL / MATERIAL

SIMPLE: 325 lm, 12 W, 2700 K, CRI > 90
FREE SIMPLE: E27, 1000 lm, 11 W / max. 42 W, 2700 K
Phasenabschnitt / Phase-cut
SIMPLE: A++ - A / FREE SIMPLE: A++ - E
SIMPLE: 220 - 240 V / FREE SIMPLE: 220 - 240 V / 120 V
Das Leuchtmittel ist im Lieferumfang enthalten und hat
Energieklasse A+ / The illuminant in energyclass A+ is included
Aluminium, Messing / Aluminium, brass

Farben / Colors

- White
- Alu Pol
- Satin *
- Brass *

Alle Abmessungen in cm /
All dimensions in cm



Office Collection

DE Exzellentes Licht macht die Arbeit produktiver und angenehmer. Unsere Office Beleuchtung setzt neue Maßstäbe für Arbeitsplatzbeleuchtung, liefert optimale Leistung, eine elegante Ästhetik und intuitive Benutzerfreundlichkeit. Die Kollektion besteht aus drei Serien: XT-S, XT-A und unserem neuesten Design – TEAM Serie. Die neue Office-Serie, die die Flexibilität, die Koordination und den Kooperationsgeist fördert, und somit essentiell für einen erfolgreichen Arbeitsplatz ist.

EN Excellent light makes work more productive and enjoyable. Our Office Collection sets new standards for workplace illumination, delivering optimal performance, elegant aesthetics, and adaptive usability. The collection centres three series: XT-S, XT-A and our latest design TEAM. Streamlined in technology, aesthetics, and efficiency, this pioneering new series TEAM draws on our decades of experience to provide a truly comprehensive solution for every kind of office.



TEAM SERIES

DE Die neue Serie TEAM ist das Ergebnis intensiver Forschung zu Licht am Arbeitsplatz. Minimalistisch, nachhaltig und adaptiv, bietet sie eine ganzheitliche Lösung für alle Stile und Situationen von Arbeit. Mit einer einheitlichen, linearen Ästhetik lassen sich die fünf TEAM-Typologien problemlos miteinander und mit verschiedenen architektonischen Settings kombinieren. Wegweisende Sensor-Innovationen und unsere bahnbrechende Beam-Lens-Technologie liefern einen völlig neuen Standard für gesundes, ergonomisches und effizientes Licht.

EN The new TEAM series is the result of deep research into workspace lighting. Streamlined, sustainable, and adaptive, it offers a truly holistic solution for all workplace styles and situations. With one unified, linear aesthetic the five TEAM typologies are readily combined with one another and with different architectural settings. Our pioneering Beam Lens Technology and groundbreaking sensor innovations deliver a whole new standard of healthy, ergonomic, and efficient illumination.

 **Herrorragende Lichtqualität / Outstanding lightquality**

DE Lichtqualität beeinflusst unser Wohlbefinden und unsere Konzentration bei der Arbeit. Für eine gleichmäßige und effiziente Ausleuchtung, verteilen hunderte von LEDs hinter gerichteten Linsen das Licht präzise über den gesamten Schreibtisch. Diese Beam Lens-Technologie sorgt auch für eine außergewöhnliche Entblendung und verfügt über ein Farbspektrum von CRI 90 - damit setzt TEAM neue Maßstäbe für die Qualität von Arbeitsplatzbeleuchtung.

EN Light quality defines your wellbeing and focus at work. To deliver the most even and efficient illumination, TEAM features hundreds of LEDs behind angled lenses to distribute light precisely across the entire desk surface. This Beam Lens technology also provides outstanding de-glaring and a color accuracy of CRI 90 - setting a brilliant new standard for the quality of workplace lighting.

 **Lichtverteilung / Light distribution**

DE Die TEAM Serie besticht durch einen besonders hohen Indirektanteil des Lichts. Neben der perfekten Ausleuchtung des Arbeitsplatzes, strahlt die Leuchte 90 % des gesamten Lichtes in den Raum und sorgt für eine ausgewogene und ganzheitliche Beleuchtung des Raumes.

EN The TEAM series provides an outstanding level of indirect light, ensuring holistic and balanced brightness throughout the workplace. In addition to the pristine illumination of the workstation, the luminaire distributes 90% of its light into the room.

 **Sensor Bewegung und Konstantlicht / Motion and constant light**

DE Eine Vollautomatische Lichtsteuerung ermöglicht eine angenehme und umweltfreundliche Arbeitsumgebung. Lichtsensoren sorgen für konstante Lichtverhältnisse - wie von Zauberhand. Empfindliche Bewegungssensoren schalten das Licht an wenn du dich näherst und aus wenn du weg bist. All das wurde in einem revolutionär flachen Sensordesign realisiert, das sich elegant in die Ästhetik der Leuchte einfügt.

EN Fully-automatic lighting creates a comfortable and energy efficient workplace. Brightness sensors adjust light settings for consistent illumination - as if by magic. Advanced motion sensors switch the lamp on when you're nearby and off when you're away. All this within a revolutionary flat sensor design which maintains the series' streamlined aesthetic.

 **Color Tune Veränderbare Lichtfarbe / Choose your light color**

DE Mit der integrierten Color Tune Funktion kann die Lichtfarbe in sechs Stufen zwischen 2700K (warm) und 4000K (kalt) beliebig eingestellt und verändert werden.

EN The TEAM series' integrated Color Tune function allows users to programme and adapt their preferred light color in six levels between 2700K and 4000K.

 **Herrorragende Lichtqualität / Outstanding lightquality**

 **Color Tune Veränderbare Lichtfarbe / Choose your light color**

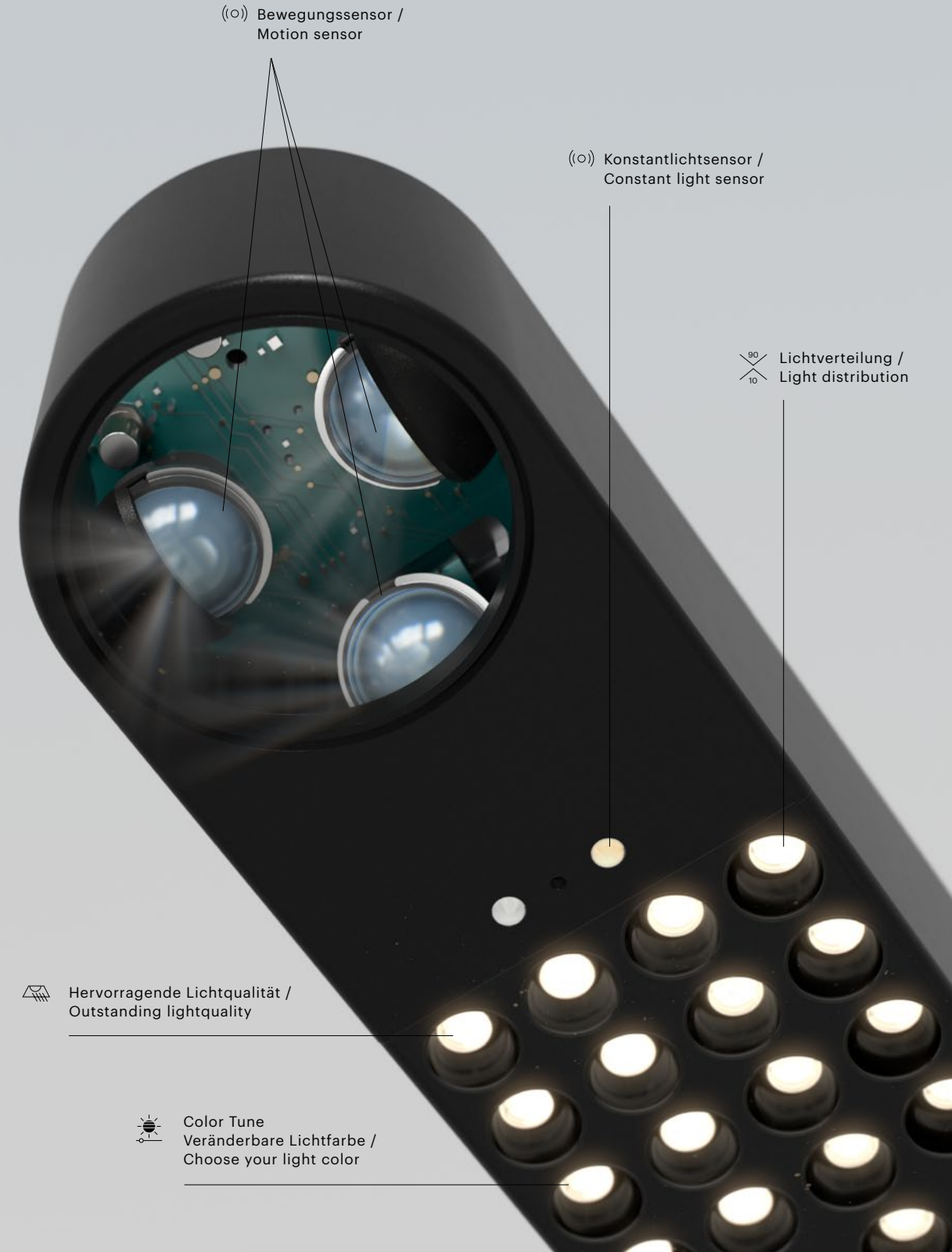

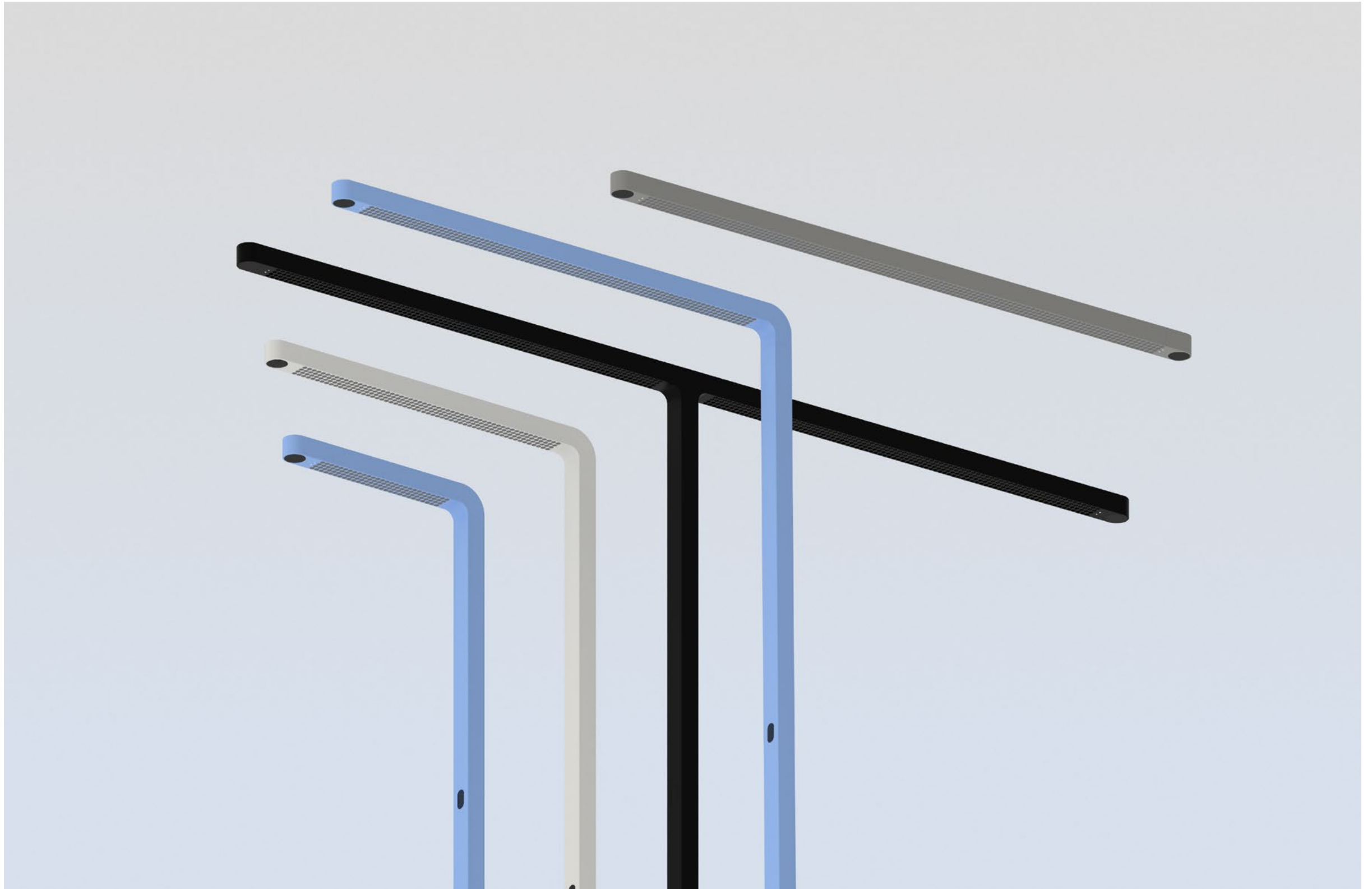

TEAM HOME

DE TEAM HOME ist die erste hochentwickelte Büroleuchte für die eigenen vier Wände. Eine innovative neue Leuchte für das Home-Office, die sich mit einer Klemme sekundenschnell auf jeder Oberfläche anbringen lässt. Mit der integrierten Technologie Color Tune lassen sich Lichtfarben einfach einstellen.

EN TEAM HOME is the first sophisticated office lamp for the home. An innovative light for the home office that can be attached to any surface in seconds with its clamp. With the integrated Color Tune technology, light colors can be easily adjusted.

Designpreise / Awards
2021 *Wallpaper Design Award
2021 Red Dot Design Award

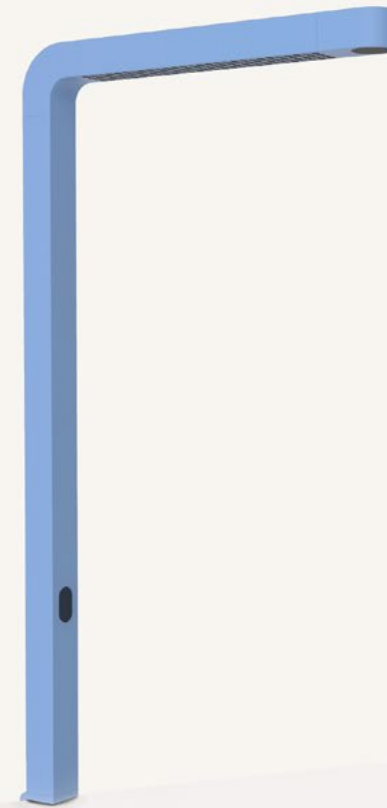



TEAM HOME TABLE

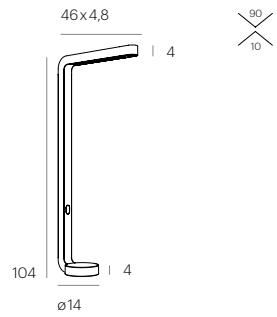

TEAM HOME CLAMP

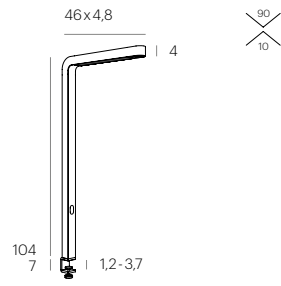

Features / Features

Color Tune
2700 – 4000 K

Optimale Lichtlenkung 20° /
Optimal light guidance 20°

Entblendung, Beam Lens,
UGR < 10 / Anti-glare,
Beam Lens, UGR < 10

Sensor – Bewegung und
Konstantlicht / Sensor –
Motion and constant light

Lichtverteilung /
Light distribution

Eigenschaften / Specifications

LED / LED
SENSORIK STANDARD / SENSOR STANDARD

STEUERUNG / CONTROLLING

ENERGIEEFFIZIENZ / ENERGY EFFICIENCY

NENNSPANNUNG / VOLTAGE

SENSORFARBE / SENSOR COLORS

HINWEIS / NOTES

MATERIAL / MATERIAL

5200 lm, 41 W, 2700 – 4000 K, CRI 94 (direkt), CRI 83 (indirekt)
Bewegungs- & Konstantlichtsensor /
Motion & constant light sensor
Grau (Bluetooth App inkl. Schwarmfunktion) /
Grau (Bluetooth app incl. swarmfunction)
A++ – A
220 – 240 V
Alle Varianten: Black / All variants: Black
Kabellänge / Cable length: 200cm
Aluminium / Aluminium

Farben / Colors

Black

White

Grey

Light Blue

Alle Abmessungen in cm /
All dimensions in cm

Leuchte / Lamp





TEAM ONE

DE Die wegweisende Büroleuchte TEAM ONE ist für individuelle und flexible Einzelarbeitsplätze konzipiert. Die Leuchte für moderne Büroräume passt sich höhenverstellbaren Schreibtischen, Hot-Desking- und Trennwandsystemen flexibel an.

EN The pioneering TEAM ONE desk lamp is designed for individual and flexible single workstations. The luminaire for modern office spaces flexibly adapts to height-adjustable desks, hot-desking and partition wall systems.

Designpreise / Awards
2021 *Wallpaper Design Award
2021 Red Dot Design Award



TEAM ONE

TEAM ONE CLAMP

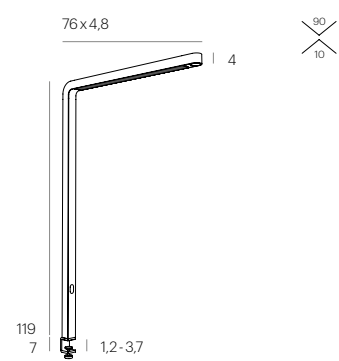
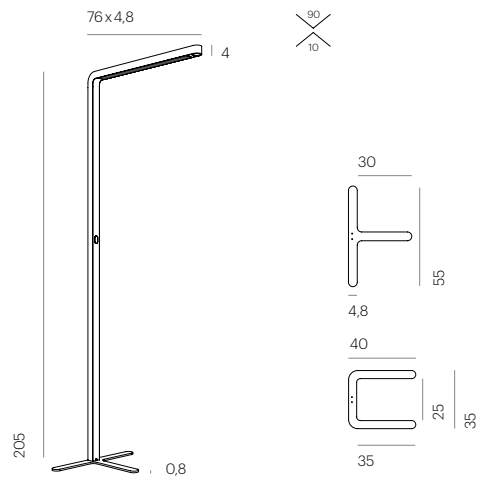

Alle Abmessungen in cm /
All dimensions in cm

Features / Features

Color Tune
2700 - 4000 K

Optimale Lichtlenkung 20° /
Optimal light guidance 20°

Entblendung, Beam Lens,
UGR < 10 / Anti-glare,
Beam Lens, UGR < 10

Sensor - Bewegung und
Konstantlicht / Sensor -
Motion and constant light

Lichtverteilung /
Light distribution

Eigenschaften / Specifications

LED / LED
SENSORIK STANDARD / SENSOR STANDARD

10400 lm, 80 W, 2700 - 4000 K, CRI 94 (direkt), CRI 83 (indirekt)

STEUERUNG / CONTROLLING

Bewegungs- & Konstantlichtsensor /
Motion & constant light sensor
Grau (Bluetooth App inkl. Schwarmfunktion) /
Grey (Bluetooth app incl. swarmfunction)

ENERGIEEFFIZIENZ / ENERGY EFFICIENCY

A++ - A

NENNSPANNUNG / VOLTAGE

220 - 240 V

SENSORFARBE / SENSOR COLORS

Alle Varianten: Black / All variants: Black

HINWEIS / NOTES

Kabellänge / Cable length: 200cm

MATERIAL / MATERIAL

Aluminium / Aluminium

Farben / Colors

Black

White

Grey

Light Blue

Leuchte / Lamp



TEAM TWO

DE TEAM TWO transformiert die Beleuchtung von Doppelarbeitsplätzen mit adaptivem, hocheffizientem Licht in einem minimalistischen und integrierten Design. Vollständig mit der Umgebungshelligkeit synchronisiert, scheint die Leuchte ein gleichmäßiges und blendfreies Licht über die gesamte Arbeitsfläche und ihr Umfeld.

EN TEAM TWO transforms the illumination of double workstations with adaptive, high-efficiency light in one minimal and integrated design. Fully synchronised to ambient brightness the lamp beams even and glare-free light across the entire work surface and surrounding area.

Designpreise / Awards
2021 *Wallpaper Design Award
2021 Red Dot Design Award



TEAM TWO

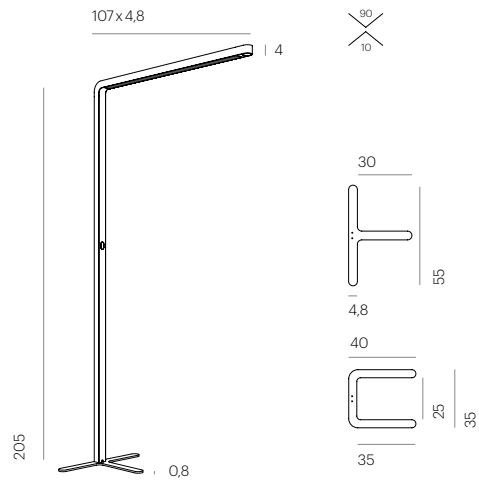

Features / Features

Color Tune
2700 – 4000 K

Optimale Lichtlenkung 20° /
Optimal light guidance 20°

Entblendung, Beam Lens,
UGR < 10 / Anti-glare,
Beam Lens, UGR < 10

(o) Sensor – Bewegung und
Konstantlicht / Sensor –
Motion and constant light

Lichtverteilung /
Light distribution

Eigenschaften / Specifications

LED / LED
SENSORIK STANDARD / SENSOR STANDARD

STEUERUNG / CONTROLLING

ENERGIEEFFIZIENZ / ENERGY EFFICIENCY

NENNSPANNUNG / VOLTAGE

SENSORFARBE / SENSOR COLORS

HINWEIS / NOTES

MATERIAL / MATERIAL

-15600 lm, 117 W, 2700 – 4000 K, CRI 94 (direkt), CRI 83 (indirekt)
Bewegungs- & Konstantlichtsensor /
Motion & constant light sensor
Grau (Bluetooth App inkl. Schwarmfunktion) /
Grau (Bluetooth app incl. swarmfunction)
A++ – A
220 – 240 V
Alle Varianten: Black / All variants: Black
Kabellänge / Cable length: 200cm
Aluminium / Aluminium

Farben / Colors

Black

White

Grey

Light Blue

Alle Abmessungen in cm /
All dimensions in cm

Leuchte / Lamp



TEAM FOUR

DE TEAM FOUR liefert helles, hocheffizientes Licht für Vier-Personen Gruppenarbeitsplätze und ist eine optimale Lösung für Co-Working Bereiche und Open-Space-Beleuchtung. Die wegweisende Sensortechnologie garantiert eine vollautomatische und effiziente Beleuchtung in einem klaren und minimalistischen Design.

EN TEAM FOUR provides luminous, high-efficiency light for four-person workstations and is a highly efficient light solution for co-working spaces and open space illumination. Advanced sensor-technology is delivering outstanding consistency and efficiency of illumination while maintaining a smooth, streamlined aesthetic.





Designpreise / Awards
2021 *Wallpaper Design Award
2021 Red Dot Design Award

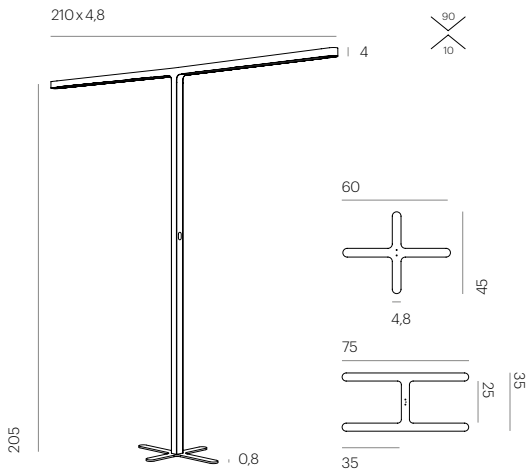

TEAM FOUR



Features / Features

-  Color Tune
2700 – 4000 K
-  Optimale Lichtlenkung 20° /
Optimal light guidance 20°
-  Entblendung, Beam Lens,
UGR < 10 / Anti-glare,
Beam Lens, UGR < 10
-  (o) Sensor – Bewegung und
Konstantlicht / Sensor –
Motion and constant light
-  Lichtverteilung /
Light distribution

Eigenschaften / Specifications

- LED / LED -31200 lm, 234 W, 2700 – 4000 K, CRI 94 (direkt), CRI 83 (indirekt)
- SENSORIK STANDARD / SENSOR STANDARD Bewegungs- & Konstantlichtsensor /
Motion & constant light sensor
- STEUERUNG / CONTROLLING Grau (Bluetooth App inkl. Schwarmfunktion) /
Grey (Bluetooth app incl. swarmfunction)
- ENERGIEEFFIZIENZ / ENERGY EFFICIENCY A++ – A
- NENNSPANNUNG / VOLTAGE 220 – 240 V
- SENSORFARBE / SENSOR COLORS Alle Varianten: Black / All variants: Black
- HINWEIS / NOTES Kabellänge / Cable length: 200cm
- MATERIAL / MATERIAL Aluminium / aluminium

Farben / Colors

-  Black
-  White
-  Grey
-  Light Blue

Alle Abmessungen in cm /
All dimensions in cm

Leuchte / Lamp

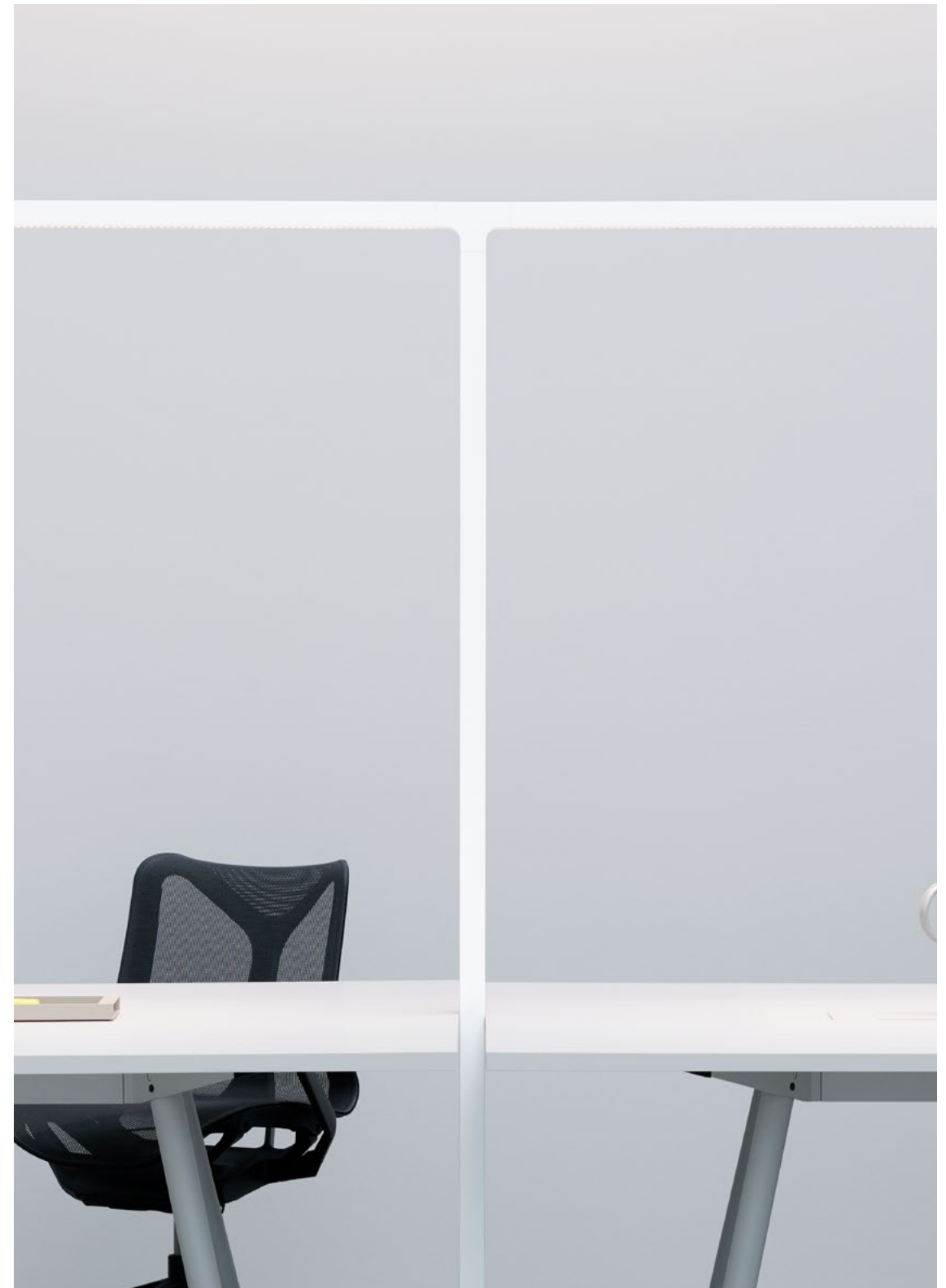

TEAM SUSPENSION

DE TEAM SUSPENSION beleuchtet als architektonische Einheit Flure, Co-Working-Bereiche, Studios und Besprechungsräume. Mit ihrer geradlinigen und minimalistischen Formsprache lässt sich TEAM SUSPENSION leicht und elegant in unterschiedliche Arbeitsplatzsituationen integrieren.

EN TEAM SUSPENSION illuminates corridors, co-working areas, studios and meeting rooms as an architectural unit. Its clear and consistent design allows designers to create and scale lighting systems. With their linear and minimalist design, all TEAM SUSPENSION can be easily and elegantly integrated into different workstation situations.

Designpreise / Awards
2021 *Wallpaper Design Award
2021 Red Dot Design Award



TEAM SUSPENSION

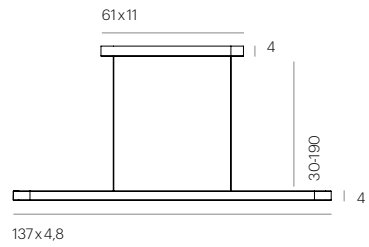

Features / Features

Color Tune
2700 - 4000 K

Optimale Lichtlenkung 20° /
Optimal light guidance 20°

Entblendung, Beam Lens,
UGR < 10 / Anti-glare,
Beam Lens, UGR < 10

Sensor - Bewegung und
Konstantlicht / Sensor -
Motion and constant light

Lichtverteilung /
Light distribution

Höhenverstellbar
0,2 - 200 cm / Height-
adjustable 0,2 - 200 cm

Eigenschaften / Specifications

LED / LED
SENSORIK STANDARD / SENSOR STANDARD

STEUERUNG / CONTROLLING

ENERGIEEFFIZIENZ / ENERGY EFFICIENCY
NENNSPANNUNG / VOLTAGE
SENSORFARBE / SENSOR COLORS
MATERIAL / MATERIAL

-14000 lm, 95 W, 2700 - 4000 K, CRI > 90 (direkt), CRI > 80 (indirekt)
Bewegungs- & Konstantlichtsensor /
Motion & constant light sensor
Grau Control (Bluetooth App inkl. Schwarmfunktion) /
Grau Control (Bluetooth app incl. swarmfunction)
A++ - A
220 - 240 V
Alle Varianten: Black / All variants: Black
Aluminium / Aluminium

Farben / Colors

- Black
- Grey
- White
- Light Blue

Alle Abmessungen in cm /
All dimensions in cm



Leuchte / Lamp



XT-A SERIES

DE XT-A ist die optimale Lösung für eine zeitgemäße und nutzerorientierte Arbeitsplatzbeleuchtung. Die Serie vereint klares, minimalistisches Design mit unserer patentierten OSA Lichttechnologie. Unsere intuitiven Lichtsteuerungssysteme und Entblendungs-Technologie helfen, ein klares, gesundes und produktives Arbeitsumfeld zu kreieren. Die Serie garantiert durch ihre Vielzahl an Modellen maximale Flexibilität und Planungsfreiheit.

EN XT-A is our essential lighting solution for the contemporary workplace. The series pairs fresh, minimalist design with our most sophisticated technologies to champion workplace style, sustainability, and wellbeing. Designed for maximum flexibility, the series includes models for multiple workplace configurations, including for height-adjustable desks. Patented anti-glare technology helps create optimal conditions for reading and working, especially for screen-based tasks.



OSA
Patentierte Lichttechnologie für blendfreies, entspanntes Arbeiten / Patented light technology for glare-free, relaxed working

DE Unsere patentierte OSA (open structure antiglare) Technologie minimiert eine störende Blendung der Leuchte und erhöht den Sehkomfort, insbesondere bei Bildschirmarbeit. OSA ist eine ergonomisch wirksame Lichttechnik, die sich besonders positiv auf die Zufriedenheit, das Wohlbefinden und die Leistung der Nutzer auswirkt.

EN OSA (open structure antiglare) technology features gridded LEDs in an open system, providing advanced efficiency and superior glare-free lighting. OSA significantly improves visual comfort, especially for screen-based tasks. OSA is an ergonomically effective technology that has a particularly positive effect on the satisfaction, well-being and performance of users.



Lichtverteilung / Light distribution
Hoher indirekter Lichtanteil für eine homogene Raumbelichtung / High indirect light portion for a homogeneous room illumination

DE Die XT-A Serie besticht durch einen besonders hohen Indirektanteil des Lichts. Neben der perfekten Ausleuchtung des Arbeitsplatzes, strahlt die Leuchte 85 % des gesamten Lichtes in den Raum und sorgt für eine ausgewogene und ganzheitliche Beleuchtung des Raumes.

EN The XT-A series provides an outstanding level of indirect light, ensuring holistic and balanced brightness throughout the workplace. In addition to the pristine illumination of the workstation, the luminaire distributes 85% of its light into the room.



CONNECT
Patentierter Schwarmfunktion / Patented swarm function

DE Über unsere Schwarmfunktion CONNECT können Leuchtengruppen miteinander kommunizieren und komplexe, koordinatenbasierte (x,y,z) Steuerungen sind geschossübergreifend möglich. Durch CONNECT kann XT-A zudem eine zusätzliche Grundbeleuchtung, z.B. in Gruppenbüros, ersetzen.

EN Our optional swarm function CONNECT allows users to program advanced, coordinate-based controls (x,y,z axes) and communication between different luminaires. CONNECT can provide an alternative to additional general lighting, e.g. in group offices.



Sensor
Bewegung und Konstantlicht / Motion and constant light

DE Alle Stehleuchten der XT-A Serie sind mit einem Bewegungsmelder und Konstantlichtregler ausgestattet. Der Konstantlichtregler steuert die Leuchte in Abhängigkeit der Umgebungshelligkeit und der Bewegungssensor erkennt wenn der Arbeitsplatz nicht mehr in Benutzung ist, wodurch die Energieeffizienz der Leuchte stark optimiert wird. Der Sensor bietet die Möglichkeit, spezifische Kunden- und Nutzungsanforderungen einzustellen.

EN Each lamp from the XT-A Series is equipped with a motion sensor and constant light regulator. The constant light regulator adjusts the light according to ambient brightness and the motion sensor detects when the workstation is not in use, which both greatly optimizes the energy efficiency of the luminaire. Our bespoke sensor allows customers to program specific customer and usage requirements, such as restricted motion detection or temporary deactivation.



ILC
Indirekte Lichtsteuerung / Indirect Light Control

DE ILC (Indirect Light Control) ist ein zusätzliche Lichtsteuerung, die unsere Schwarmfunktion CONNECT ergänzt. Sie ermöglicht die Abstimmung von Leuchtengruppen, indem die indirekten Lichtanteile gesteuert werden, während der direkte Lichtanteil individuell eingestellt werden kann. Unsere ILC-Technologie ermöglicht eine außergewöhnlich harmonische Raumbelichtung.

EN ILC (Indirect Light Control) is an additional lighting tool to our CONNECT swarm function. It enables the coordination of groups of luminaires controlling their indirect light components automatically, while the direct lighting can be adjusted individually. Our ILC technology enables an exceptionally harmonious room lighting.

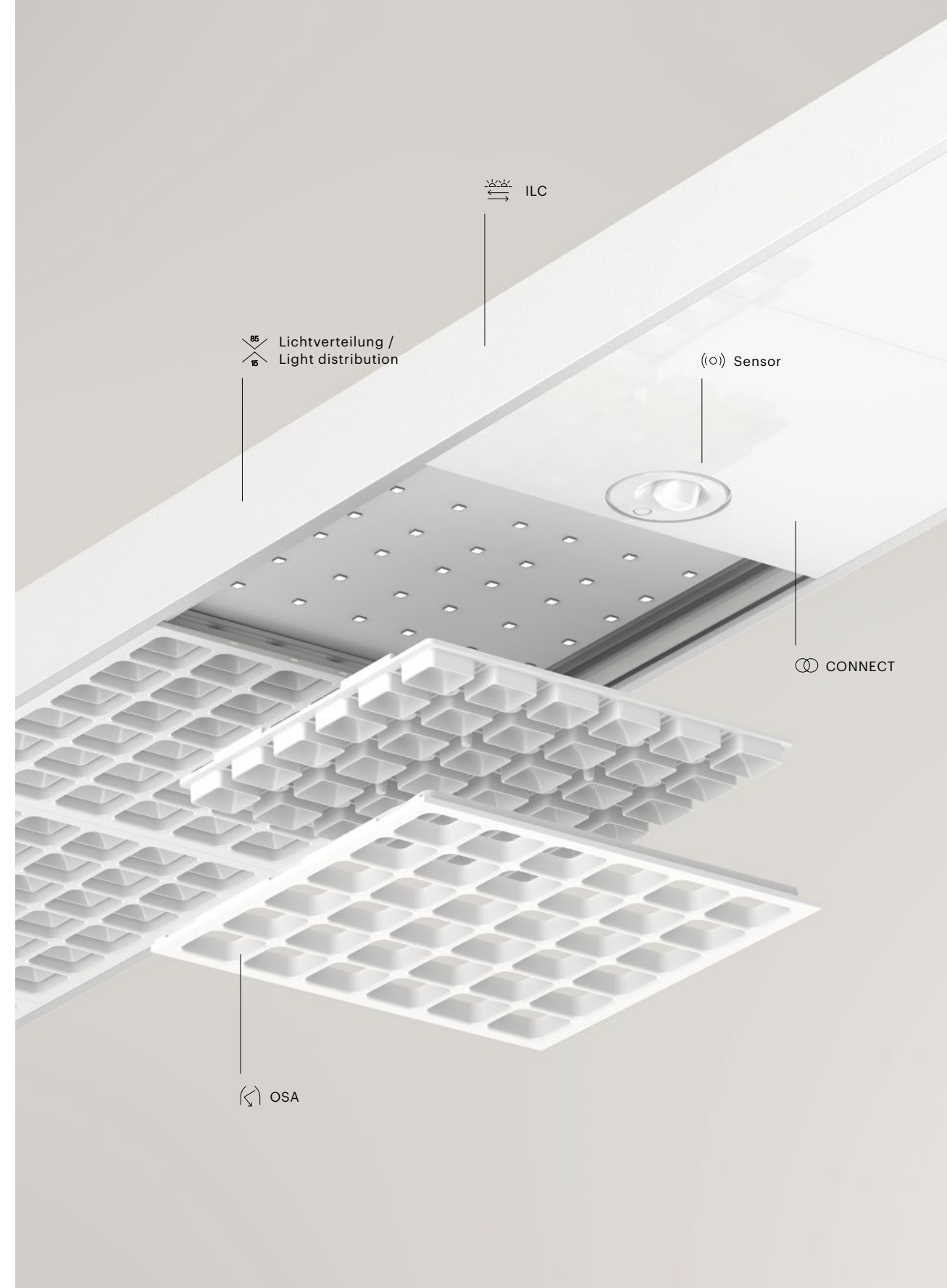

XT-A SINGLE

DE XT-A SINGLE ist für höhenverstellbare Schreibtische und moderne Steh-Sitz Arbeitsplätze konzipiert. Als flexible Einheit fährt die Leuchte mit dem Tisch hoch und runter, sodass die Ausleuchtung der Arbeitsfläche auch beim Arbeiten in stehender Position immer gleich bleibt.

EN XT-A SINGLE is designed for individual workstations, particularly height-adjustable desks. The lamp is securely integrated into the desk or flexibly attached via a clamp, allowing lamp and workstation to be moved as a single, streamlined unit. Whether seated or standing, light is evenly and consistently distributed over the desk.







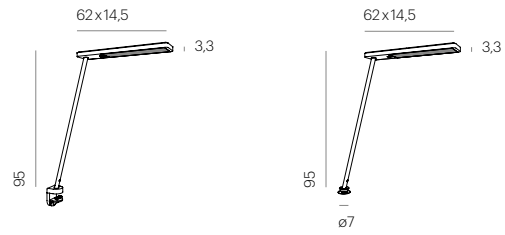



XT-A SINGLE TABLE CLAMP XT-A SINGLE TABLE IN



Features / Features

-  OSA - Patentierte Entblendungstechnik / OSA - Patented open structure anti-glare
-  Lichtverteilung / Light distribution
-  Sensor - Bewegung und Konstantlicht / Sensor - Motion and constant light
-  CONNECT - (Schwarmfunktion) / CONNECT - (Swarmfunction)
-  ILC - Automatische Steuerung des indirekten Lichtanteils / ILC - Indirect Light Control
-  Verschiedene Tischadaptionen erhältlich / Several table adaptations available

Eigenschaften / Specifications

- LED / LED
 - DIMMUNG / DIMMING
 - ENERGIEEFFIZIENZ / ENERGY EFFICIENCY
 - NENNSPANNUNG / VOLTAGE
 - HINWEIS / NOTES
 - MATERIAL / MATERIAL
- 6000 lm, 48 W, 3500 K, CRI > 80
 Sensor gesteuert - Manuelle Dimmung via Taster und Fernbedienung / Sensor controlled via switch and remote control
 A++ - A
 220 - 240 V / 120 V
 Abdeckung und Entblendung indirekt / Cover and deglaring indirect
 Aluminium, Polycarbonat / Aluminium, polycarbonate

Farben / Colors

-  Black, Black
-  White, White
-  Satin, Black

Alle Abmessungen in cm / All dimensions in cm

Leuchte, Reflektor / Leuchte, reflector



XT-A PLUS

DE XT-A PLUS ist die erfolgreichste Leuchte unserer Office Collection. Entworfen für zwei Arbeitsplätze, bietet sie einen langen Ausleger für eine gleichmäßige und ideal entblendete Lichtverteilung. Integrierte OSA Technologie sorgt für präzise gelenktes Licht und maximale Energieeffizienz.

EN XT-A PLUS is the most successful lamp of our office collection. Designed to illuminate two workstations, the lamp provides a long stretch of both directional and ambient lighting through its extended lamp head. Integrated OSA technology delivers evenly-distributed, glare-free light and maximum energy efficiency.

Designpreise / Awards
2015 iF Design Award







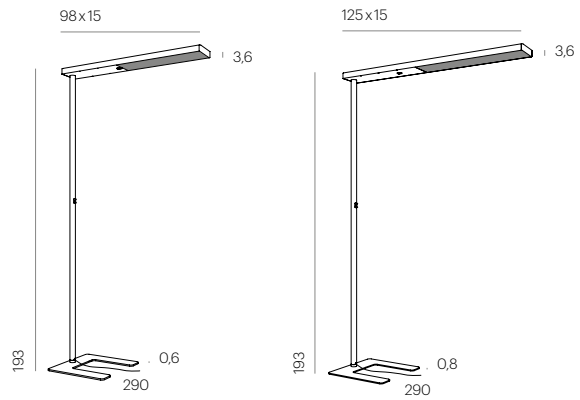

PLUS 90 FLOOR

PLUS 120 FLOOR









Features / Features

-  OSA - Patentierte Entblendungstechnik / OSA - Patented open structure anti-glare
-  Lichtverteilung / Light distribution
-  Sensor - Bewegung und Konstantlicht / Sensor - Motion and constant light
-  CONNECT - (Schwarmfunktion) / CONNECT - (Swarmfunktion)
-  ILC - Automatische Steuerung des indirekten Lichtanteils / ILC - Indirect Light Control
-  Verschiedene Tischadaptionen erhältlich / Several table adaptions available

Eigenschaften / Specifications

- LED / LED
 - DIMMUNG / DIMMING
 - ENERGIEEFFIZIENZ / ENERGY EFFICIENCY
 - NENNSPANNUNG / VOLTAGE
 - MATERIAL / MATERIAL
- PLUS 90: 14500 lm, 98 W, 3500 K, CRI > 80
 PLUS 120: 16000 lm, 108 W, 3500 K, CRI > 80
 Sensor gesteuert - Manuelle Dimmung via Taster und Fernbedienung / Sensor controlled via switch and remote control
 A++ - A
 220 - 240 V
 Aluminium, Polycarbonat / Aluminium, polycarbonate

Farben / Colors

-  Black, Black
-  White, White
-  Satin, Black
-  Satin, White
-  Chrome, Black
-  Chrome, White
-  Titan, Black

Alle Abmessungen in cm /
All dimensions in cm



Leuchte, Reflektor /
Lamp, reflector

XT-A PLUS T

DE XT-A PLUS T ist die hervorragende Lichtlösung für Gruppenarbeitsplätze in Open Space Bereichen. Integrierte OSA Technologie sorgt für gleichmäßiges, entblendetes Licht und maximale Energieeffizienz.

EN A top efficiency solution for open plan offices and coworking spaces, XT-A PLUS T illuminates four workstations in one single lamp. Integrated OSA technology delivers evenly-distributed, glare-free light in both desk and ambient directions.

Designpreise / Awards
2015 iF Design Award



PLUS T FLOOR

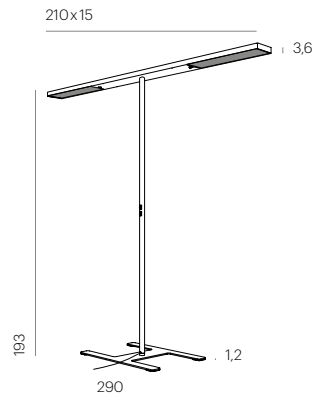

Features / Features

- OSA - Patentierte Entblendungstechnik / OSA - Patented open structure anti-glare
- CONNECT - (Schwarmfunktion) / CONNECT - (Swarmfunktion)
- Lichtverteilung / Light distribution
- ILC - Automatische Steuerung des indirekten Lichtanteils / ILC - Indirect Light Control
- Sensor - Bewegung und Konstantlicht / Sensor - Motion and constant light
- Verschiedene Tischadaptionen erhältlich / Several table adaptations available

Eigenschaften / Specifications

- LED / LED
 - DIMMUNG / DIMMING
 - ENERGIEEFFIZIENZ / ENERGY EFFICIENCY
 - NENNSPANNUNG / VOLTAGE
 - MATERIAL / MATERIAL
- 2 × 14500 lm, 2 × 98 W, 3500 K, CRI > 80
 Sensor gesteuert - Manuelle Dimmung via Taster und Fernbedienung / Sensor controlled via switch and remote control
 A++ - A
 220 - 240 V
 Aluminium, Polycarbonat / Aluminium, polycarbonate

Farben / Colors

- Black, Black
- White, White
- Satin, Black
- Titan, Black

Alle Abmessungen in cm / All dimensions in cm

Leuchte, Reflektor / Lamp, reflector



XT-A DIRECT XT-A CEILING

DE Eine ideale Wahl für Open Space Beleuchtung, Konferenzräume oder Flure. Die minimalistische Decken- oder Pendelleuchte besticht durch ihr klares Design und hochwertige Lichttechnik. Wähle zwischen einer Vielzahl an Längen sowie zwei Varianten an Indirektlichtanteil.

EN An ideal fitting for conference rooms, meeting rooms, reception areas, or for general architectural illumination, XT-A CEILING offers outstanding light in a striking and nimble design.

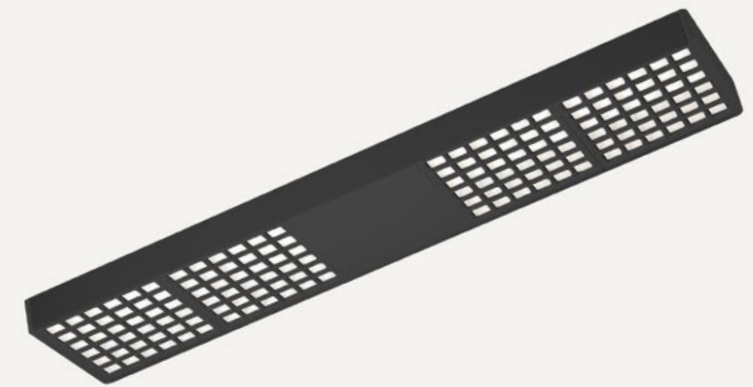

Varianten / Variants

XT-A DIRECT 70

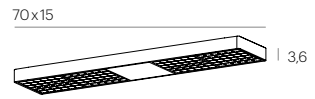

XT-A DIRECT 150

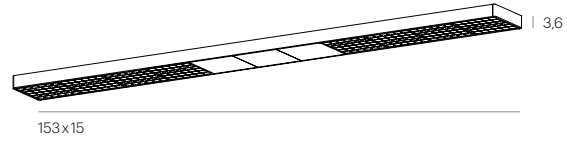

Features / Features

 OSA - Patentierte Entblendungstechnik / OSA - Patented open structure anti-glare

 Lichtverteilung / Light distribution

Eigenschaften / Specifications

LED / LED

ENERGIEEFFIZIENZ / ENERGY EFFICIENCY

NENNSPANNUNG / VOLTAGE

HINWEIS / NOTES

MATERIAL / MATERIAL

XT-A DIRECT 70: 2240 lm, 31 W, 3500 K, CRI > 90
XT-A DIRECT 150: 4530 lm, 63 W, 3500 K, CRI > 80
A++ - A
220 - 240 V / 120 V
XT-A DIRECT 150: Sensor optional /
XT-A DIRECT 150: Sensor optional
Aluminium, Polycarbonat /
Aluminium, polycarbonate

Farben / Colors

 Black, Black

 Satin, Black

 White, White

 Satin, White

Alle Abmessungen in cm /
All dimensions in cm

Leuchte, Reflektor /
Lamp, reflector



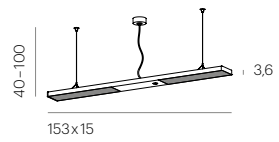

XT-A CEILING 150

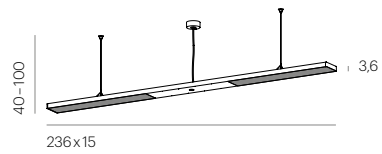

XT-A CEILING 240



Features / Features

-  OSA - Patentierte Entblendungstechnik / OSA - Patented open structure anti-glare
-  Sensor - Bewegung und Konstantlicht / Sensor - Motion and constant light

-  Lichtverteilung / Light distribution (IL: 77/23, DL: 38/62)
-  CONNECT - (Schwarmfunktion) / CONNECT - (Swarmfunction)

Eigenschaften / Specifications

- LED / LED
- DIMMUNG / DIMMING
- ENERGIEEFFIZIENZ / ENERGY EFFICIENCY
- NENNSPANNUNG / VOLTAGE
- HINWEIS / NOTES
- MATERIAL / MATERIAL

XT-A CEILING 150: 6300 lm, 75W, 3500 K, CRI > 80
 XT-A CEILING 240: 9000 lm, 125 W, 3500 K, CRI > 80
 Dimmer integriert / Dimmer integrated
 A++ - A
 220 - 240 V / 120 V
 IL: 77/23, DL: 38/62
 Aluminium, Polycarbonat /
 Aluminium, polycarbonate

Farben / Colors

-  White, White
-  Satin, Black
-  Satin, White

Alle Abmessungen in cm /
All dimensions in cm

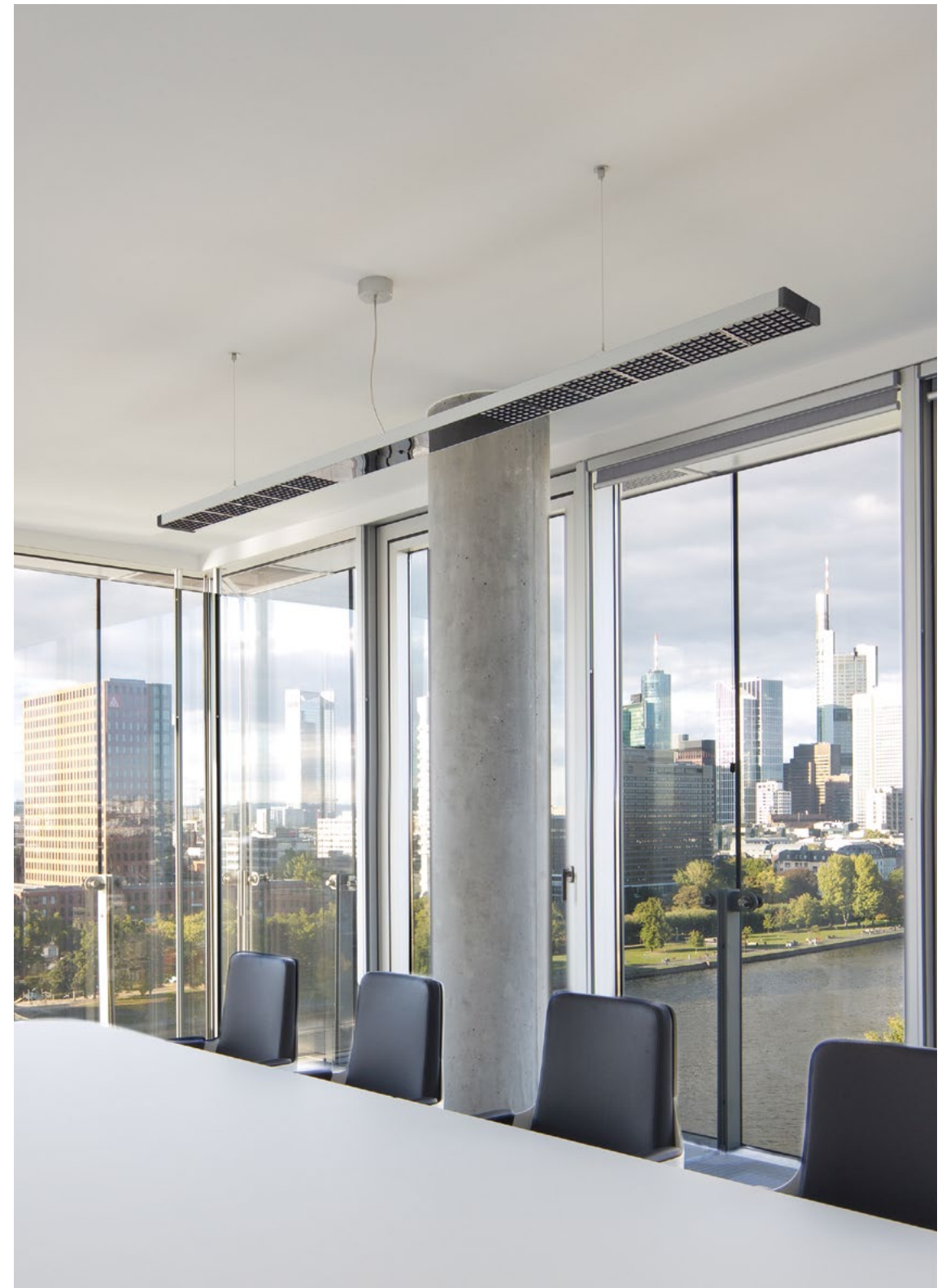

Leuchte, Reflektor /
Lamp, reflector



XT-S SERIES

DE Die XT-S Serie bringt eine radikal neue Stimmung in die Arbeitsplatzbeleuchtung. In klarem Aluminium, überzeugt das futuristische Design durch dünne Formen und ein innovatives Lichtpanel.

EN The XT-S series brings a whole new flair to workplace lighting. In pristine aluminium, the futuristic design impresses through its sleek and slimline form, integrating the latest LED technology into an avant-garde light panel.

 **Ultraflaches Lichtpanel / Ultra slim light panel**

DE Die XT-S Serie beeindruckt mit ihrem 12mm Vollaluminium Körper, minimalistischem Design und innovativer LED Technologie. Mit unserem laseroptimierten Lichtpanel wird das Licht über acht unterschiedliche Schichten gelenkt und erzeugt ein homogenes, weiches und blendfreies Lichtbild.

EN The XT-S series impresses with its 12mm slim full aluminium body, minimalistic design and innovative LED technology. With our laser-optimised light panel, light is directed through eight different layers to create homogeneous, soft, and glare-free illumination.

 **Sensor
Bewegung und Konstantlicht /
Motion and constant light**

DE Alle Stehleuchten der XT-S Serie sind mit einem Bewegungsmelder und Konstantlichtregler ausgestattet. Der Konstantlichtregler steuert die Leuchte in Abhängigkeit der Umgebungshelligkeit und der Bewegungssensor erkennt wenn der Arbeitsplatz nicht mehr in Benutzung ist, wodurch die Energieeffizienz der Leuchte stark optimiert wird. Der Sensor bietet die Möglichkeit, spezifische Kunden- und Nutzungsanforderungen einzustellen.

EN Each lamp from the XT-S Series is equipped with a motion sensor and constant light regulator. The constant light regulator adjusts the light according to ambient brightness and the motion sensor detects when the workstation is not in use, which both greatly optimizes the energy efficiency of the luminaire. Our bespoke sensor allows customers to program specific customer and usage requirements, such as restricted motion detection or temporary deactivation.

 **Color Tune
Veränderbare Lichtfarbe / Choose your light color**

DE Mit der integrierten Color Tune Funktion kann die Lichtfarbe in sechs Stufen zwischen 2700K (warm) und 6000K (kalt) eingestellt und verändert werden.

EN The XT-S series' integrated Color Tune function allows users to programme and adapt their preferred light color in six levels between 2700K and 6000K.

 **CONNECT
Patentierter Schwarmfunktion /
Patented swarm function**

DE Über unsere Schwarmfunktion CONNECT können Leuchtengruppen miteinander kommunizieren und komplexe, koordinatenbasierte (x,y,z) Steuerungen sind geschossübergreifend möglich. Durch CONNECT kann XT-S zudem eine zusätzliche Grundbeleuchtung, z.B. in Gruppenbüros, ersetzen.

EN Our optional swarm function CONNECT allows users to program advanced, coordinate-based controls (x,y,z axes) and communication between different luminaires. CONNECT can provide an alternative to additional general lighting, e.g. in group offices.

 **Ultraflaches Lichtpanel /
Ultra slim light panel**

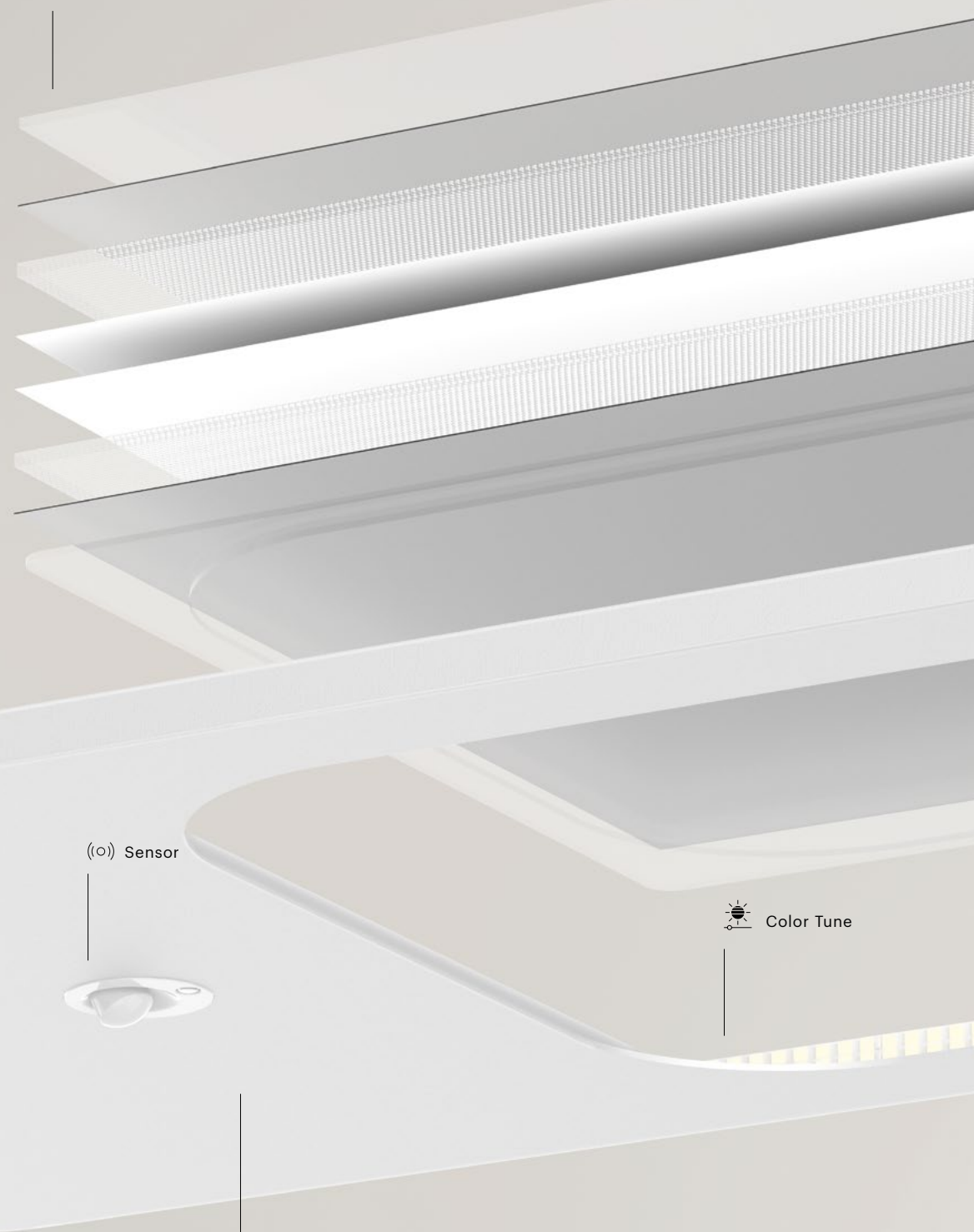

 **Sensor**

 **Color Tune**

 **CONNECT**

XT-S ONE

DE Die erstaunlich dünne Stehleuchte, entworfen für Einzelarbeitsplätze, vereint High-Tech Performance mit glatter Ästhetik. Über die integrierte Color Tune Technology kann die Lichtfarbe beliebig eingestellt werden.

EN A strikingly slim standing lamp, designed for a single workstation and distinguished by its high-tech performance and sleek aesthetics. The lamp integrates Color Tune technology to adjust color temperature.

Designpreise / Awards

2017 iF Product Design Award
2017 Red Dot Design Award
2017 Focus Open Award



XT-S ONE FLOOR

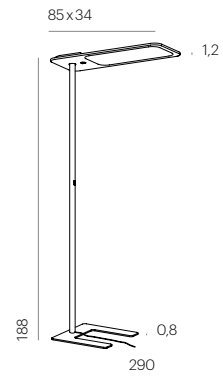



XT-S ONE TABLE





Features / Features

 Ultraflaches Lichtpanel / Ultra slim light panel

 Color Tune
2700 – 6000 K

 ((o)) Sensor – Bewegung und Konstantlicht / Sensor – Motion and constant light

 Lichtverteilung / Light distribution

 CONNECT – (Schwarmfunktion) / CONNECT – (Swarmfunktion)

 Verschiedene Tischadaptionen erhältlich / Several table adaptations available

Eigenschaften / Specifications

LED / LED

5485 lm, 48 W, 2700, 3000, 3500, 4000, 5000, 6000 K, CRI > 80

DIMMUNG / DIMMING

Sensor gesteuert – Manuelle Dimmung via Taster und Fernbedienung / Sensor controlled via switch and remote control

ENERGIEEFFIZIENZ / ENERGY EFFICIENCY

A++ – A

NENNSPANNUNG / VOLTAGE

220 – 240 V / 120 V

MATERIAL / MATERIAL

Aluminium, Polycarbonat / Aluminium, polycarbonate

Farben / Colors

 White

 Charcoal

Alle Abmessungen in cm /
All dimensions in cm



XT-S TWO

DE Entworfen für die Beleuchtung von zwei Arbeitsplätzen, steht XT-S TWO neben oder zwischen den Tischen. Ausgestattet mit unserer patentierten Schwarmfunktion CONNECT sind diese außergewöhnlichen Leuchten einzigartige Begleiter beim Arbeiten.

EN Designed to illuminate two workstations, the contemporary XT-S TWO stands like a trustworthy companion either beside or between desks. Integrating our patented swarm function CONNECT, these impressive lamps are readily connected with a wider lighting system.

Designpreise / Awards

2017 iF Product Design Award
2017 Red Dot Design Award
2017 Focus Open Award

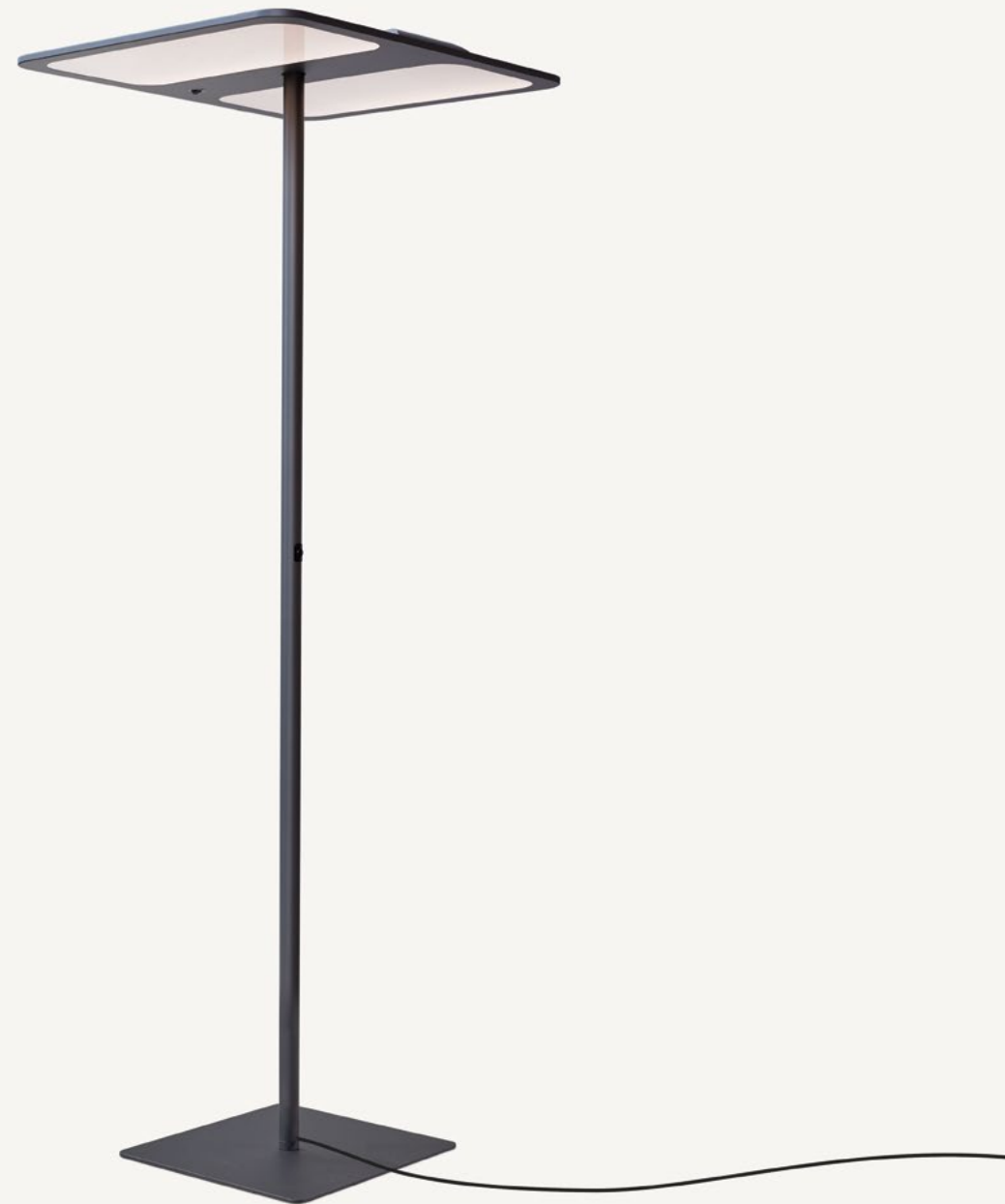



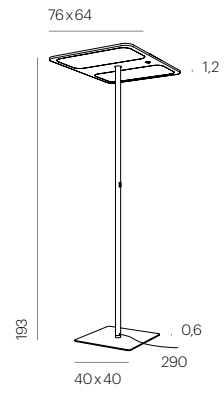
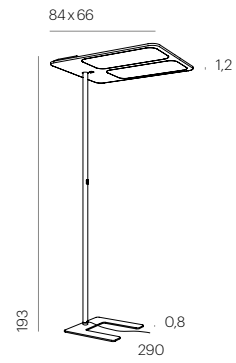

XT-S TWO SIDE FLOOR

XT-S TWO CENTER FLOOR





Features / Features

 Ultraflaches Lichtpanel / Ultra slim light panel

 Color Tune
2700 – 6000 K

 ((o)) Sensor – Bewegung und Konstantlicht / Sensor – Motion and constant light

 Lichtverteilung / Light distribution

 CONNECT – (Schwarmfunktion) / CONNECT – (Swarmfunktion)

 Verschiedene Tischadaptionen erhältlich / Several table adaptations available

Eigenschaften / Specifications

LED / LED

10970 lm, 96 W, 2700, 3000, 3500, 4000, 5000, 6000 K, CRI > 80

DIMMUNG / DIMMING

Sensor gesteuert – Manuelle Dimmung via Taster und Fernbedienung / Sensor controlled via switch and remote control

ENERGIEEFFIZIENZ / ENERGY EFFICIENCY

A++ – A

NENNSPANNUNG / VOLTAGE

220 – 240 V / 120 V

MATERIAL / MATERIAL

Aluminium, Polycarbonat / Aluminium, polycarbonate

Farben / Colors

 White

 Charcoal

Alle Abmessungen in cm /
All dimensions in cm



XT-S SUSPENSION

DE Schwebend wie ein Raumschiff, gibt XT-S SUSPENSION jedem Raum viel Licht und modernen Charakter. Mit ihrem langen, doppelseitigen Lichtpanel ist die Pendelleuchte optimal geeignet für Konferenzräume, Foyers oder als architektonische Beleuchtung.

EN Floating like a spaceship, XT-S SUSPENSION delivers striking light and character to the workplace. With its long stretch of double panel illumination, it is particularly suited to conference rooms, meeting rooms, and foyer areas, as well as for general architectural illumination.

Designpreise / Awards

2017 iF Product Design Award
2017 Red Dot Design Award
2017 Focus Open Award



XT-S SUSPENSION

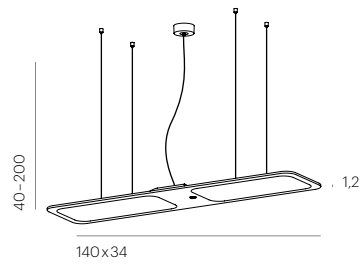

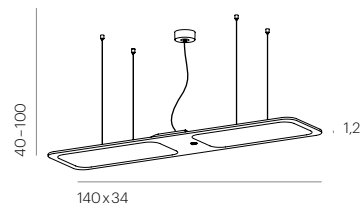

XT-S CEILING





Alle Abmessungen in cm /
All dimensions in cm

Features / Features

 Ultraflaches Lichtpanel / Ultra slim light panel

 Color Tune
2700 – 6000 K

 (o) Sensor – Bewegung und
Konstantlicht / Sensor –
Motion and constant light

 Lichtverteilung /
Light distribution

 CONNECT –
(Schwarmfunktion) /
CONNECT –
(Swarmfunction)

Eigenschaften / Specifications

LED / LED 10970 lm, 96 W, 2700, 3000, 3500,
4000, 5000, 6000 K, CRI > 80

DIMMUNG / DIMMING Sensor gesteuert – Manuelle Dimmung via
Fernbedienung / Sensor controlled and
via remote control

ENERGIEEFFIZIENZ / ENERGY EFFICIENCY A++ – A

NENNSPANNUNG / VOLTAGE 220 – 240 V / 120 V

MATERIAL / MATERIAL Aluminium, Polycarbonat /
Aluminium, polycarbonate

Farben / Colors

 White  Charcoal

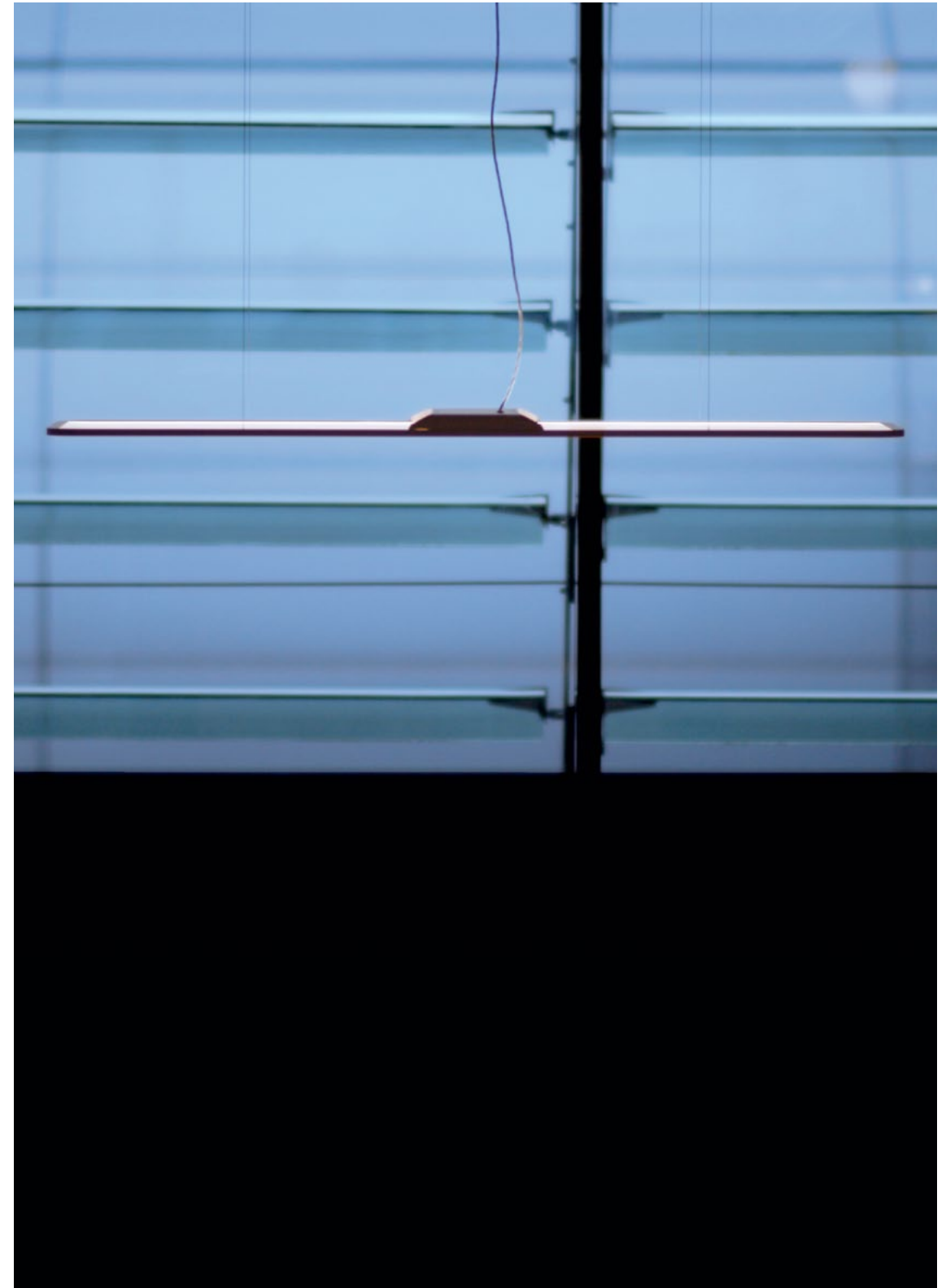

Lichtplanung / Light Planning

DE Wir freuen uns Ihnen im folgenden Abschnitt eine Reihe an Planungstools vorzustellen, welche unsere Leuchten begleiten und das Planen erleichtern. Unter Anderem führen wir Sie in verschiedene Dimmtechnologien sowie unseren CHOICE Konfigurator ein, mit dem individuelle Lichtlösungen und Leuchtenkombinationen zusammengestellt werden können.

EN In the following section we are pleased to present some of the planning tools and services which accompany our lights. These include our different dimming technologies as well as our CHOICE configurator which allows users to design and plan their own individualized light solutions.

CHOICE Konfigurator / CHOICE Configurator

DE CHOICE ist unser preisgekröntes Planungstool für Ihre personalisierten Lichtarrangements. Modern, kreativ und intuitiv, erlaubt CHOICE Ihnen eine Vielzahl an Leuchten, Farben, Varianten optimal für Ihren Raum zu kombinieren. Beginnen Sie einfach mit einer beliebigen Leuchte oder Anbringung und kombinieren Sie nach Belieben.

EN CHOICE is our award-winning planning tool for your personalised lighting arrangements. Streamlined, creative, and intuitive, CHOICE allows you to combine lamps, colors, materials, and finishes to best suit your space. Simply start with a desired lamp or fixture and build up from there.

tobiasgrau.com/choice



1. Kombinieren Sie Hängeleuchten und Strahler /
Combine suspension lights and spots
2. Nur ein Stromauslass notwendig /
Only one power supply needed
3. Einfache, modulare Montage /
Easy and modular assembly

Pendelleuchten / Suspension luminaires

Wählen und konfigurieren Sie Ihre Leuchten / Choose and configurate your luminaires

NICEONE



- Raw
- Black
- White
- Alu Pol
- Copper

Kabel A / Cable A

- Black
- White
- Grey
- Charcoal
- Maroon

FALLING



- Black
- White
- Alu Pol

Keine Kabelauswahl / No cable choice

FALLING LEAF

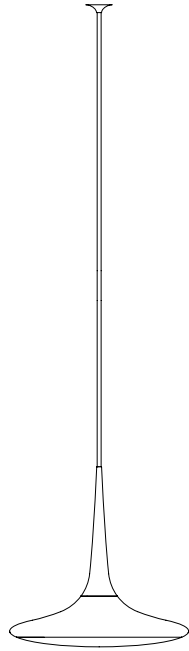

- Alu Pol

Kabel B / Cable B

- Black
- White
- Grey
- Charcoal
- Maroon

OH

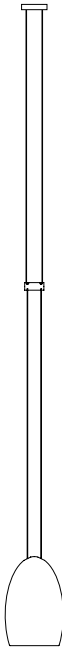

- Bone China

Keine Kabelauswahl / No cable choice

PALLA

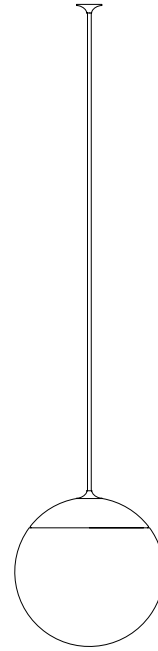

- Black
- Alu Pol

Kabel C / Cable C

- Black
- White
- Grey
- Charcoal
- Maroon

Optiken / Optics

Wählen und kombinieren Sie mit Optiken / Choose and configurate with optics

OPTICS 4

Wählbar für / Suitable for
NICE
STRAIGHT
CLEAR

CABOCHON



∅ 4

GLOW



∅ 4

○ White

SOLID



∅ 4

● Black
○ White
● Grey
● Charcoal
● Sand
● Olive

OPTICS 6

Wählbar für / Suitable for
GRAND NICE
SET

LENSE



∅ 6

GLOW



∅ 6

○ White

SOLID



∅ 6

● Black
○ White
● Grey
● Charcoal
● Sand
● Olive

Strahler / Spots

Kombinieren Sie mit Strahlern / Combine with spots

CLEAR



● Black
○ White
● Alu Pol

SET



● Black
○ White
● Alu Pol

SET FOCUS



● Black
○ White

STUDIO



● Alu Pol. Black
● Satin, Black
● Alu Pol. White
● Satin, White

Zubehör / Accessories

Setzen Sie Abdeckpunkte /
Set blind points

BLIND POINT



∅ 3,6

● Black
○ White
● Alu Pol

Passen Sie die Kabellänge an /
Adjust the cable length

CLIP STRONG



∅ 3,6

● Alu Pol

Pendeln Sie das Kabel ab /
Hook the cable

HOOK STRONG









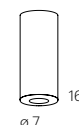

∅ 2,4

● Alu Pol

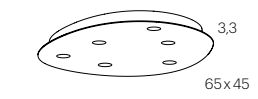
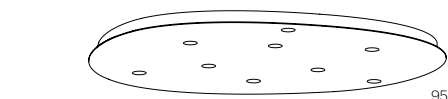
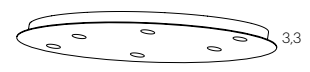
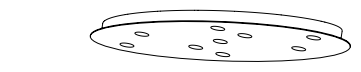

Anbringungen / Fixtures

Wählen Sie Ihre Anbringung / Choose your fixture

<p>IN</p>  <p>1 ø 8,5</p> <ul style="list-style-type: none"> ● Black ○ White 	<p>UP ROUND 7</p>  <p>16,3 ø 7</p> <ul style="list-style-type: none"> ● Black ○ White ● Alu Pol 	<p>UP ROUND 12</p>  <p>4,4 ø 12</p> <ul style="list-style-type: none"> ● Black ○ White ● Alu Pol 	<p>UP ROUND 13</p>  <p>4,4 ø 13</p> <ul style="list-style-type: none"> ● Black ○ White ● Grey
<p>UP ROUND 16</p>  <p>4,6 ø 16,5</p> <ul style="list-style-type: none"> ● Black ○ White ● Alu Pol 	<p>EUROTRACK</p>  <p>7 16,7</p> <ul style="list-style-type: none"> ● Black ○ White 	<p>DUO 17×17</p>  <p>3,7 17x17</p> <ul style="list-style-type: none"> ● Black ○ White ● Alu Pol ● Satin 	<p>DUO 13×13</p>  <p>4 13x13</p> <ul style="list-style-type: none"> ● Black ○ White ● Alu Pol ● Satin
<p>TRIO 30</p>  <p>4 ø 30</p> <ul style="list-style-type: none"> ● Black ○ White ● Alu Pol 	<p>CLOUD 6</p>  <p>3,3 65x45</p> <ul style="list-style-type: none"> ● Black ○ White 	<p>CLOUD 9</p>  <p>3,3 95x75</p> <ul style="list-style-type: none"> ● Black ○ White 	
<p>OVAL 6</p>  <p>3,3 75x35</p> <ul style="list-style-type: none"> ● Black ○ White 	<p>OVAL 9</p>  <p>3,3 75x35</p> <ul style="list-style-type: none"> ● Black ○ White 		

Schienen / Traces

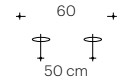
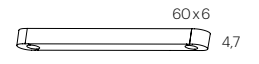
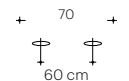
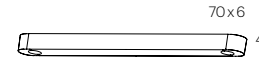
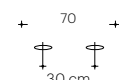
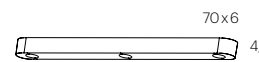
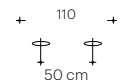
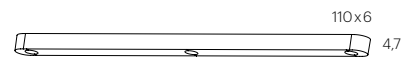
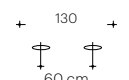
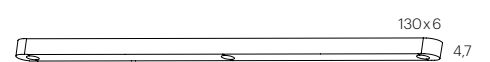
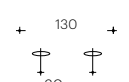
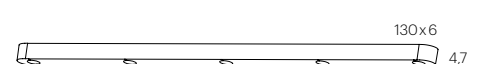
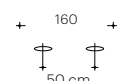
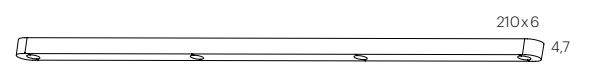
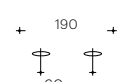
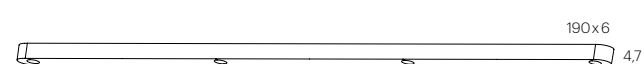
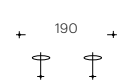
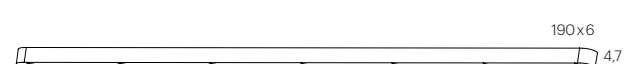
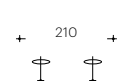
Wählen Sie die optimale Schiene für Ihr Arrangement / Choose the optimal trace for your arrangement

<p>2/60</p>  <p>60 50 cm</p>	 <p>60x6 4,7</p>
<p>2/70</p>  <p>70 60 cm</p>	 <p>70x6 4,7</p>
<p>3/70</p>  <p>70 30 cm</p>	 <p>70x6 4,7</p>
<p>3/110</p>  <p>110 50 cm</p>	 <p>110x6 4,7</p>
<p>3/130</p>  <p>130 60 cm</p>	 <p>130x6 4,7</p>
<p>5/130</p>  <p>130 30 cm</p>	 <p>130x6 4,7</p>
<p>4/160</p>  <p>160 50 cm</p>	 <p>210x6 4,7</p>
<p>4/190</p>  <p>190 60 cm</p>	 <p>190x6 4,7</p>
<p>7/190</p>  <p>190 30 cm</p>	 <p>190x6 4,7</p>
<p>9/210</p>  <p>210 25 cm</p>	 <p>210x6 4,7</p>

- Black
- White
- Alu Pol

Beliebteste Konfigurationen / Most popular configurations

NICEONE + CLEAR

Ideal für einen langen Esstisch 240 – 280 cm /
Ideal for a long dining table 240 – 280 cm

1× TRACE 7/190 – Black

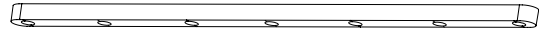

4× NICEONE – Raw, Black



3× CLEAR SPOT – Black + OPTIC – 4 Solid Black

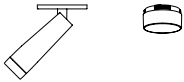

FALLING + SET SPOT

Ideal für einen kurzen Esstisch 160 – 180 cm /
Ideal for a short dining table 160 – 180 cm

1× TRACE 5/130 – Black

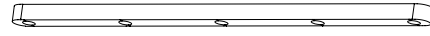

2× FALLING – Black



3× SET SPOT – Black, Black + OPTIC – 6 Solid Black

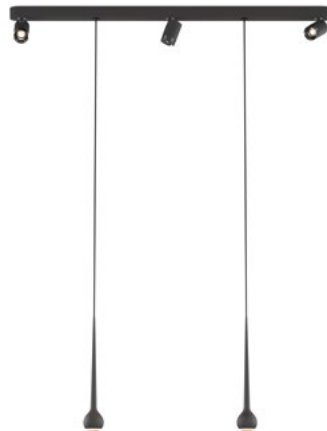
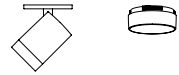

TRACE OH CHINA

Ideal für einen langen Esstisch 240 – 280 cm /
Ideal for a long dining table 240 – 280 cm

1× TRACE 4/160 – White

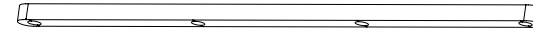

4× OH CHINA

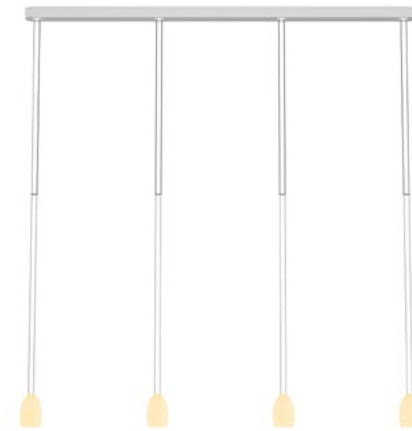

FALLING LEAF DUO

Ideal für einen kurzen Tisch 160 – 180 cm /
Ideal for a short dining table 160 – 180 cm

1× TRACE 2/70 – Alu Pol

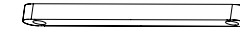

2× FALLING LEAF – Alu Pol, Grey

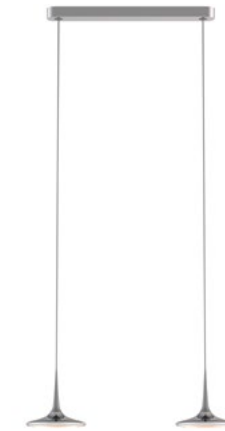

Dimmtechnologien / Dimming Technologies

DE Dimmen ist ein integraler Teil einer kreativen Beleuchtung. Wir bieten eine Reihe von Dimmtechnologien an, um die Anpassungsfähigkeit unserer Leuchten zu verbessern und Ihnen die Möglichkeit zu geben, das Licht an verschiedene Stimmungen und Tageszeiten anzupassen.

EN Dimming is an integral element of creative lighting. We offer a range of dimming technologies to enhance the adaptability of our luminaires and allow users to tailor illumination to different settings, moods, and hours of the day.

Allgemeine Dimmung / General dimming

DE Alle Tobias Grau Leuchten der Home Collection sind für eine Standarddimmung von 100% bis 30% mit einem Phasendimmer für elektronische Vorschaltgeräte ausgelegt und mit jeder Form der Hausverkabelung kombinierbar. Nach Wunsch können zudem Konverter für andere Dimmtechniken eingebaut werden. Der Großteil unserer Office Leuchten ist mit integriertem Dimmer, Bewegungsmelder und Konstantlichtregler ausgestattet und kann über die optionale Schwarmfunktion CONNECT miteinander vernetzt werden. Office Leuchten ohne Sensor sind im Standard mit 1-10 V dimmbaren Convertern ausgestattet. Der Einbau von DALI Convertern ist ebenfalls möglich.

EN All Tobias Grau luminaires are designed for standard dimming 100% to 30% with a phase dimmer for electronic ballasts in any form of home wiring. Our suspension luminaires and spots are equipped with converter for standard rotary or push-pull switches and can be enhanced by additional dimming options. Most of our Office Collection models integrate a dimmer, motion sensor, and constant light regulator and can be cross-linked via our swarm function, CONNECT. The rest of our Office Collection uses 1-10 V or DALI as standard dimming.

Warm Dim / Warm Dim

DE Viele Tobias Grau Leuchten integrieren die neueste Warm Dim-Technologie, welche die Farbtemperatur automatisch beim Dimmen anpasst. Dimmen Sie auf, scheint das Licht klar und hell. Dimmen Sie runter, leuchtet es mit einem warmen, weichen Schein.

EN Many Tobias Grau models integrate the latest Warm Dim technology, automatically adjusting color temperature to brightness. Dim up, and you'll have crisp, bright light. Dim down, and the light softens to a gentle amber glow.

Bluetooth (über Casambi) / Bluetooth (via Casambi)

DE Viele Tobias Grau Leuchten, insbesondere Pendelleuchten und Strahler, können über eine optionale Bluetooth Steuerung mit Casambi (via App) gedimmt werden. Casambi bietet eine Dimmung von 100% bis 5% sowie individuelle Licht-, Szenen- und Gruppeneinstellungen. Um ergänzend zur App-Steuerung auch per »Lichtschalter« zu dimmen, kann ein Bluetooth Sender hinter den Schalter verbaut werden oder der mobile Bluetooth Schalter (Casambi Express) ergänzt werden.

EN A number of Tobias Grau luminaires are also compatible with Bluetooth dimming via the Casambi app, allowing for 100% to 5% dimming and individual programming of light scenes and groupings. In order to dim via a regular switch, a Bluetooth converter (Casambi Xpress) can be integrated behind the switch. A portable Casambi Xpress control is also available.

DALI / DALI

DE DALI (Digital Addressable Lighting Interface) ist eine Steuerung von lichttechnischen Betriebsgeräten in der Gebäudeautomatisierung. Viele Tobias Grau Leuchten, unter anderem alle Office Leuchten, können (optional) mit DALI ausgestattet werden. Für die Verwendung von DALI wird eine fünfadrige Verdrahtung vorausgesetzt.

EN DALI (Digital Addressable Lighting Interface) is a network-based system that controls lighting in the building automation. Various Tobias Grau luminaires, including all models in our Office Collection, can be equipped with DALI technology. DALI requires a 5-wired cabling.

1-10V Dimmung / 1-10V dimming

DE Die 1-10V Schnittstelle für Vorschaltgeräte werden mehrere Leuchten parallel gedimmt. Viele Tobias Grau Leuchten können mit 1-10V Convertern ausgestattet werden. Für die Verwendung einer 1-10 V Dimmung wird eine fünfadrige Verdrahtung vorausgesetzt.

EN With the 1-10 V dimming option, several luminaires can be dimmed simultaneously. Many Tobias Grau luminaires are compatible for 1-10 V dimming. 1-10 V dimming requires a five-wire system.

Planungstools / Planning Tools

DE Zur Visualisierung und lichttechnischen Beurteilung Ihrer Raum- und Lichtplanung, stehen wir Ihnen gerne mit unserem Team beratend zur Seite. Außerdem stellen wir Ihnen die entsprechenden Daten und Planungstools zur Verfügung.

EN Tobias Grau is delighted to assist and consult on the visualization and planning of lighting schemes and interior spaces. We provide relevant data for multiple planning programs and tools, as well as our own planning service.

Lichtplanung mit DIALux und Relux / Light planning via DIALux and Relux

DE DIALux und Relux sind Lichtplanungsprogramme, mit denen professionelle Lichtplanungen und Lichtberechnungen erstellt werden können. Einen Großteil unserer Leuchten stellen wir in der jeweiligen Online Datenbank (Herstellerkataloge) zum direkten Download für Ihre Planung zur Verfügung. Benötigen Sie die reine ldt Datei, so erhalten Sie diese gern auf Anfrage, oder im Downloadbereich der entsprechenden Leuchte.

EN DIALux and Relux are light planning programs for professional planning and light calculations. Most of our luminaires are featured in the online databanks of the program and are available for direct download. If you need an ldt file, you can download it from the relevant product page(s) on our website.

pCon.planner

DE Der pCon.planner ist eine Software zur Raum- und Einrichtungsplanung, bei dem alle kaufmännisch relevanten Daten mit dem Modell verknüpft sind. Wir stellen Ihnen für einen Großteil unserer Leuchten die 3D Modelle (dwg) und OFML Planungsdaten im pCon.planner zur Verfügung.

EN The pCon.planner is a 3D planning software for room and facility planning. We offer 3D models (DWG) and OFML planning data for various Tobias Grau luminaires. All relevant information and data are integrated into the Model and can be directly connected to your personal model and project.

Zusätzliche Planungsdaten / Additional planning data

DE Für die Planungsprogramme AutoCAD, ArchiCAD und Autodesk finden Sie die Planungsdaten im Downloadbereich der entsprechenden Leuchte. DWG Dateien stehen Ihnen auch Online unter <http://pcon-catalog.com/tobias-grau/> zur Verfügung.

EN For planning with AutoCAD, ArchiCAD and Autodesk, you can download all relevant data from the relevant product page(s) on our website. DWG files are also available online at <http://pcon-catalog.com/tobias-grau/>.

Projekt- und Lichtplanung / Project and light planning

DE Zur Visualisierung und lichttechnischen Beurteilung Ihrer Raum- und Lichtplanung, stehen wir Ihnen gerne mit unserem Team beratend zur Seite. Außerdem stellen wir Ihnen die entsprechende Daten und Planungstools zur Verfügung.

EN For larger-scale projects, our light and room planning service encompasses decorative and technical lighting schemes. Working to your brief, we offer a light calculation and individualised solutions for both single spaces and multi-room lighting concepts.

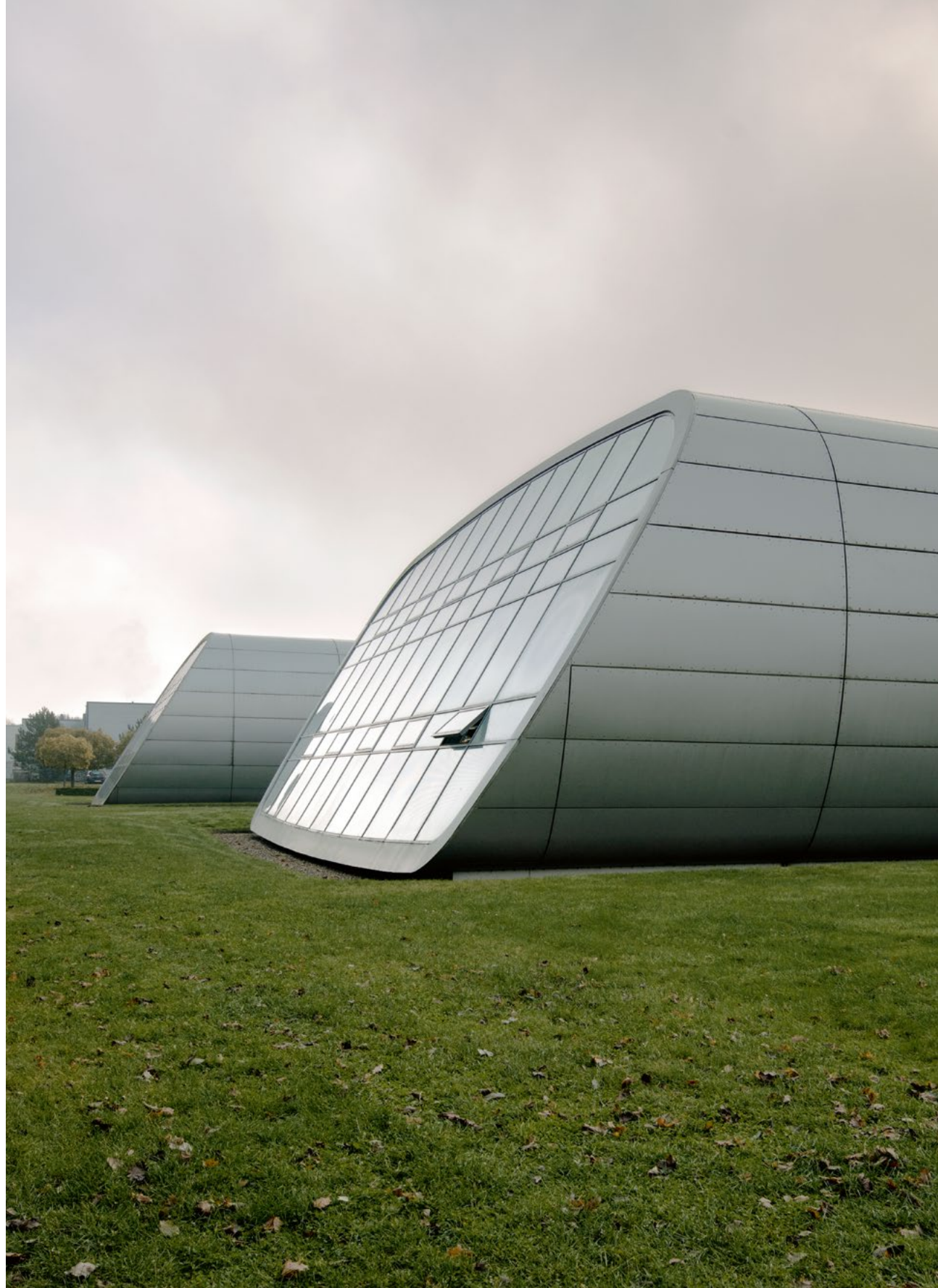

Danksagung / Acknowledgement

DE Das Tobias Grau Team möchte sich bei allen Partnern, Kreativen und Künstlern für Ihre einzigartige Arbeit und Kollaboration bedanken. Es ist eine Freude und Ehre mit Euch zusammenzuarbeiten.

Wir möchten uns besonders bei unseren Fachhandels- und Projektpartnern für Ihren Einsatz und das Vertrauen in die Tobias Grau Qualität bedanken. Wir freuen uns weiterhin voneinander zu lernen und miteinander zu wachsen.

Wir möchten unsere große Wertschätzung an alle im Tobias Grau Team ausdrücken. Dank dieser außergewöhnlichen Zusammenarbeit entwickeln wir gemeinsam unsere Faszination, Menschen eine neue Erfahrung von Licht zu schenken.

EN The Tobias Grau team wishes to extend a special thanks to all partners, creatives and artists for their work and collaboration. It is a pleasure and honour to be working with you.

We especially thank our retailer and project partners for their trust and contribution in the Tobias Grau quality and long term partnership. We are looking forward to continuously learning from each other and growing together.

We wish to express our sincere gratitude to everyone in the Tobias Grau team. It is due to our collaborative team effort that we achieve to develop the fascination to give people a new experience of lighting.

Credits

PRODUCT DESIGN

Tobias Grau
Timon & Melchior Grau

CREATIVE DIRECTION

Timon & Melchior Grau

GRAPHIC DESIGN

Studio Karl Kolbitz

TEXT

Eliza Apperly

CGI-RENDERINGS

INK Studios

COLOR SEPARATIONS

Johann Hausstätter

PHOTOGRAPHY

Alessio Bolzoni
Bastien Gomez
Bennie Gay
Johann Clausen
Luca Lomonaco
Simon Menges
Charles Negre
Michael Wurzbach

SET DESIGN

Cameranesi & Pompili
Hella Keck

STYLING

Andreas Krings
Francesca Cefis

PHOTO PRODUCTION

Hammal Production

SPECIAL THANKS TO

Marco Velardi
Giorgiana Ravizza

The Tobias Grau GmbH reserves the right to make modifications and improvements of a technical or aesthetic nature to the products at any time without notice. For further information, please visit www.tobiasgrau.com.

© Tobias Grau GmbH 07/2021

Contacts

HEADQUARTER

Tobias Grau GmbH
Siemensstraße 35b
25462 Rellingen
Germany

T +49 4101 370-0
F +49 4101 370-1000
info@tobiasgrau.com
tobiasgrau.com

TOBIAS GRAU SALES TEAM

T +49 4101 370-0
F +49 4101 370-1000
info@tobiasgrau.com

TOBIAS GRAU PROJECT AND LIGHT PLANNING

T +49 4101 370-2029
projekt@tobiasgrau.com

TOBIAS GRAU PRESS

press@tobiasgrau.com

Showrooms

HAMBURG

Große Elbstraße 66–68 — stilwerk
22767 Hamburg
T +49 40 30035831
store.hamburg@tobiasgrau.com

BERLIN

Kantstraße 17 — stilwerk
10623 Berlin
T +49 30 31012614
store.berlin@tobiasgrau.com

KÖLN

Kaiser-Wilhelm-Ring 14–16
50672 Köln
T +49 221 5000543
store.koeln@tobiasgrau.com

FRANKFURT

Bleichstraße 55–59
60313 Frankfurt
T +49 69 21659893
store.frankfurt@tobiasgrau.com