



**YES!
THIS
IS
A
CATALOGUE**

INHO MAUREN

Towers
of
flowers
to
all
the
people
who
love us.
With
embracing
thanks.

YES!

Unser Katalog ist kein Buch.

Wir sind leidenschaftlich, engagiert und glücklich, dass wir mit einem Material arbeiten, das nicht existiert: Licht.

Vielseitigkeit, sophisticated Technologie, bereit für Herausforderungen.

Neue Formensprache, neue und provozierende Ästhetik, neue Materialien, Intensität und Präzision.

Handarbeit mit Hirn.

Verantwortung ist uns wichtig.

Der Mensch muss spürbar sein.

Eine Manufaktur.

Ein starkes Team, das überzeugt ist:

What we do counts.

I.M.

YES!

A catalogue. Not a book.

Showing our devotion, passion to a non-existing material: Light.

Diversity in expressions, materials, technology, passion.

Embracing challenges.

“Manufacturers” we are.

Working with our hands and brains.

A strong team that believes in “What we do counts”*

I.M.

*An attitude which should be contagious.

002

003

YES!

A Team. Not a lone warrior.
Since decades I am driven by passion.

Ideas that surprise.

Technology and beauty
falling in love with each other.

Allowing the hazard's course.

Failing and succeeding.

Sometimes at the same time.

So many that inspired me!

That's why I dedicate

this catalogue to –
my team.

I.M.

CONTENT

Hängelampen / Hanging lamps / Suspensions / Lampade a sospensione

- 014** | 116 Black Luzy **NEW**
- 015** | 116 Blue Luzy **NEW**
- 016** | 123 Luzy Take Five **NEW**
- 019** | 128 Super Luzy'z **NEW**
- 020** | 123 Luzy From The Sky **NEW**
- 022** | 122 Luce Volante **NEW**
- 024** | 129 Zettel'z 5 / Zettel'z 6
- 028** | 130 Zettel'z Munari **NEW**
- 030** | 129 Zettel'z Laughing Buddha **NEW**
- 032** | 119 Flying Disc **NEW**
- 034** | 126 Ringelpiez Suspension **NEW**
- 035** | 126 Ringelpiez Frivoloso **NEW**
- 036** | 114 Blow Me Up **NEW**
- 040** | 120 Galactic **NEW**
- 042** | 122 Loop
- 044** | 116 Brick
- 048** | 122 Light Structure
- 051** | 122 Light Structure Three
- 052** | 121 Lacrime del Pescatore
- 056** | 120 Johnny B. Butterfly
- 057** | 118 Flatterby
- 058** | 125 One New Flame
- 059** | 119 Flying Flames
- 068** | 115 Birds Birds Birds
- 070** | 114 Birdie
- 071** | 115 Birdie's Nest
- 072** | 115 Birdie's Ring
- 074** | 117 Da + Dort
- 075** | 124 Max. Mover LED
- 076** | 128 Tu-Be Lüster
- 077** | 127 Schlitz LED
- 079** | 117 Eddie's Son
- 080** | 117 Canned Light
- 082** | 116 Campari Light
- 084** | 122 Luminophor
- 086** | 120 Hot Achille
- 088** | 124 Metall C. Cooper
- 089** | 114 Alizz C. Cooper
- 090** | 124 Max. Pender
- 091** | 118 Five Pack
- 092** | 113 24 Karat Blau
- 092** | 113 24 Karat Blau M
- 093** | 113 1000 Karat Blau
- 094** | 126 Pierre ou Paul
- 096** | 128 XXL Dome
- 098** | 125 Oh Mei Ma / Oh Mei Ma Weiss
- 099** | 125 Oh Mei Ma Kabir / Oh Mei Ma Kabir Weiss
- 100** | 123 ManOMan
- 101** | 128 Willydilly
- 102** | 121 Knitterling
- 103** | 123 Maru
- 104** | 118 Floatation
- 106** | 121 Johnny B. Good
- 107** | 120 Grasl
- 108** | 127 Savoie
- 109** | 124 Öff Öff
- 110** | 119 Fly Candle Fly!
- 111** | 130 Zufall C.
- 112** | 127 Silly-Kon

Tischlampen / Table lamps / Lampes de table / Lampade da tavolo

- 134** | 210 Koyoo **NEW**
136 | 215 Ru Ku Ku
138 | 210 Keep Balance
141 | 214 Ringelpiez Table **NEW**
142 | 208 Glatzkopf Table **NEW**
147 | 206 Bulb
148 | 206 Bulb Limited Heart
149 | 206 Bulb Limited Fly
150 | 208 I Ricchi Poveri – Bzzzz
151 | 208 I Ricchi Poveri – Five Butterflies
152 | 209 I Ricchi Poveri – Toto
154 | 209 I Ricchi Poveri – Monument for a Bulb
155 | 209 I Ricchi Poveri – Fly
156 | 216 What We Do Counts
160 | 215 Spyre
162 | 213 My New Flame
164 | 212 Lucellino LED TRI-R
165 | 212 Lucellino Table
168 | 205 Birdie's Busch
169 | 213 Mozzkito
170 | 216 Walking Bulb
171 | 209 Jetzt²
172 | 211 LED's Oskar
173 | 214 Oskar
174 | 213 Oh·LED·One
175 | 207 Dew Drops Table
176 | 211 Light Structure
177 | 211 Light Structure Three
178 | 210 Knot 1
179 | 210 Knot 2
180 | 207 Delirium Yum
182 | 206 Campari Bar
183 | 215 Veramente al Dente
184 | 214 One From The Heart
186 | 216 Zufall T
188 | 212 Max. Kugler
190 | 211 Looksoflat
192 | 205 24 Karat Blau T
193 | 215 Seven Rats
194 | 205 Bastardo
196 | 213 Metall T. Cooper
198 | 207 Don Quixote
200 | 205 Bibibibi
202 | 210 Lampampe
203 | 208 Grasl

Stehlampen / Floor lamps / Lampadaires / Lampade a stelo

- 218** | 240 Ringelpiez **NEW**
222 | 238 Glatzkopf Floor **NEW**
223 | 237 24 Karat Blau Floor **NEW**
224 | 238 Dew Drops Floor
226 | 237 Alizz F. Cooper
227 | 239 Metall F. Cooper
228 | 237 Bastardo
230 | 238 Ilios
232 | 239 Max. Floor
234 | 237 Blow Me Up
235 | 239 Knot 3

Deckenlampen / Ceiling lamps / Plafonniers / Lampade da soffitto

- 242** | 261 18 x 18
242 | 261 2 x 18 x 18 **NEW**
244 | 263 Max.Wall LED
245 | 264 WaLL.E.D **NEW**
246 | 264 Use Me C.
248 | 262 Lucellino Doppio **NEW**
249 | 261 Birdie's Nest
250 | 263 Luxury Pure
251 | 262 Lil Luxury
252 | 261 Light Cone L
252 | 262 Light Cone S
252 | 262 Light Cone S vertical
253 | 263 Schlitz Up
258 | 264 Spock
259 | 264 Zuuk

Wandlampen / Wall lamps / Appliques / Lampade da parete

- 266** | 305 Luzy On The Wall **NEW**
268 | 301 18 x 18
269 | 301 2 x 18 x 18 **NEW**
270 | 303 Eclipse Ellipse **NEW**
272 | 307 WaLL.E.D **NEW**
274 | 306 Ringelpiez Wall **NEW**
276 | 305 Max. Mover LED
280 | 305 Max.Wall LED
281 | 307 Use Me W.
282 | 301 24 Karat Blau Wall
284 | 304 Lucellino Wall
284 | 304 Lucellino Doppio **NEW**
285 | 304 Lucellino NT
286 | 306 Seven off the Wall
288 | 302 Dew Drops Wall
289 | 302 Delight
290 | 305 Oskar
291 | 303 LED's Oskar
292 | 304 Light au Lait
293 | 302 Canned Light
294 | 307 zero · one
295 | 301 Aka_Tsuki
296 | 303 Holonzki
297 | 303 Dead Bulb Alive
298 | 306 Spock

The MaMo Nouchies

- 312** | 334 Walking in the Rain **NEW**
314 | 334 Moonati **NEW**
315 | 335 Yoruba Rose **NEW**
316 | 333 Babadul **NEW**
318 | 333 Kokoro
320 | 334 Samurai
321 | 334 Poul Poul
322 | 335 Wo-Tum-Bu 1, 2, 3
323 | 333 Con-Qui
324 | 333 Jimken
325 | 335 Ysmen
326 | 334 Mahbruky
327 | 335 Watapunga
329 | 333 Gaku

Systeme / Systems / Systèmes / Sistemi

338 | 362 YaYaHo
346 | 362 Element 1
346 | 363 Element 3
346 | 363 Element 4
348 | 362 Element 2 + Spiegel/Mirror/Miroir/Specchio
349 | 363 Element 5
350 | 363 Element 77
351 | 363 Element 6
352 | 363 Element 16
353 | 363 Element 14
356 | 361 BaKaRú

By Order Only

366 | 407 Oh Man, it's a Ray!
370 | The Humblies
374 | 407 LED Table
374 | 406 LED Bench
376 | 407 Lüster
378 | 406 Hot.Hot
380 | 408 Porca Miseria!
386 | Golden Ribbon
392 | Red Ribbon
394 | 408 T.T. Moon
396 | 406 Comic Explosion
398 | Pendulum
400 | 406 Broken Egg
402 | Biotop

Showrooms + Projects

410 Showroom Munich
414 Showroom New York
418 Showroom São Paulo
422 Bellissima Brutta
423 Licht.Enstein
424 LED Wallpaper
426 One Thousand and One Lights
428 Early Future
429 Flying Future
430 Whisper Wind
432 Double C. Future
433 Double T. Future
434 Subway stations Karlsruhe
436 Subway stations Munich
437 Torre Velasca, Milano

Familien / Families / Familles / Famiglie

24 Karat Family 092 | 192 | 223 | 282
Birds Family 064 | 164 | 248 | 284
Cooper Family 088 | 196 | 226
Flame Family 058 | 162
Knots 178 | 235
Luzy's Attack 014 | 266
Max. Family 075 | 090 | 188 | 232 | 244 | 276 | 280
Ringelpiez Family 034 | 140 | 218 | 274

Zeichenerklärung / Signs and symbols / Légende / Simboli e descrizione



Leuchtmittel / Light source / Agent lumineux / Lampada.



Fassung / Socket / Douille / Attacco.



Mit eingebauten LEDs. Die Leuchtmittel können nicht vom Nutzer ausgetauscht werden. / With built-in LEDs. The light source is not exchangeable by the user. / Livré avec LED intégrés. Les ampoules LED ne peuvent pas être changées par l'utilisateur. / Munito di LED integrate. Il modulo LED non può essere sostituito dall'utente.



Mit elektronischem Transformator mit Schieberegler. / With electronic transformer with slide control. / Avec transformateur électronique à curseur. / Con trasformatore elettronico con variatore lineare.



Mit elektronischem Transformator mit Drehdimmer. / With continuously rotating electronic transformer-dimmer. / Avec transformateur électronique avec variateur à rotation. / Con trasformatore elettronico con dimmer a manopola rotante.



Mit integriertem Transformator. / With built-in transformer. / Avec transformateur intégré. / Con trasformatore integrato.



Mit Steckertransformator. / With plug-in transformer. / Avec transformateur à pris. / Con trasformatore a spina.



Kabellänge / Cable length / Longueur du câble / Lunghezza del cavo



Netzspannung / Voltage / Tension / Voltaggio

Alle Maßangaben in Zentimetern. / All dimensions in centimeters. / Toutes dimensions en centimètres. / Tutte le misure in centimetri.

Alle technischen Angaben am Ende der Rubriken. / All technical details at the end of each section. / Toutes les données techniques en fin de rubrique. / Tutti i dati tecnici sono riportati alla fine ogni rubrica.

Check our website for up-to-date-information: www.ingo-maurer.com

Hängelampen
Suspensions
Lampade a sospensione

012

HANGING LAMPS 013

014



BLACK LUZY

015



BLUE LUZY



018



LUZY ON THE WALL

019



SUPER LUZY'Z

020



021

LUZY FROM THE SKY



022

023

WHITE
SILVER
RED

The light flies up and down.



LUCE VOLANTE



1997

ZETTEL'Z

Be a painter,
be a writer,
be a cartoonist.
Unleash your
creativity and
see what
happen'z when
ZETTEL'Z is
in your house.

31 printed and
49 blank paper
sheets in DIN A5
(ZETTEL'Z 5)
or DIN A6
(ZETTEL'Z 6)
give you plenty
of room for
your own creative
outburst.

Have fun!



ZETTEL'Z

BLUSHING ZETTEL'Z

First limited edition, 2006. Sold out, now a collectible.



026



027

The legendary
Bruno Munari!
We are proud
to have the
permission of
Maurizio Corraini srl
to publish his
timeless ABC.
For children
and for others.

028



ZETTEL'Z MUNARI new limited edition, 2018



029

A smile
is the
only
curve
that sets
things
straight.



030

031

Fly high, hang loose.

The ultralight FLYING DISC is a well known flying object hovering in space like a space station. Gravity is duped by rocket science technology in form of 3 metal strings that are fixed to the ceiling. Change the gradient of the disc and enjoy different light situations.

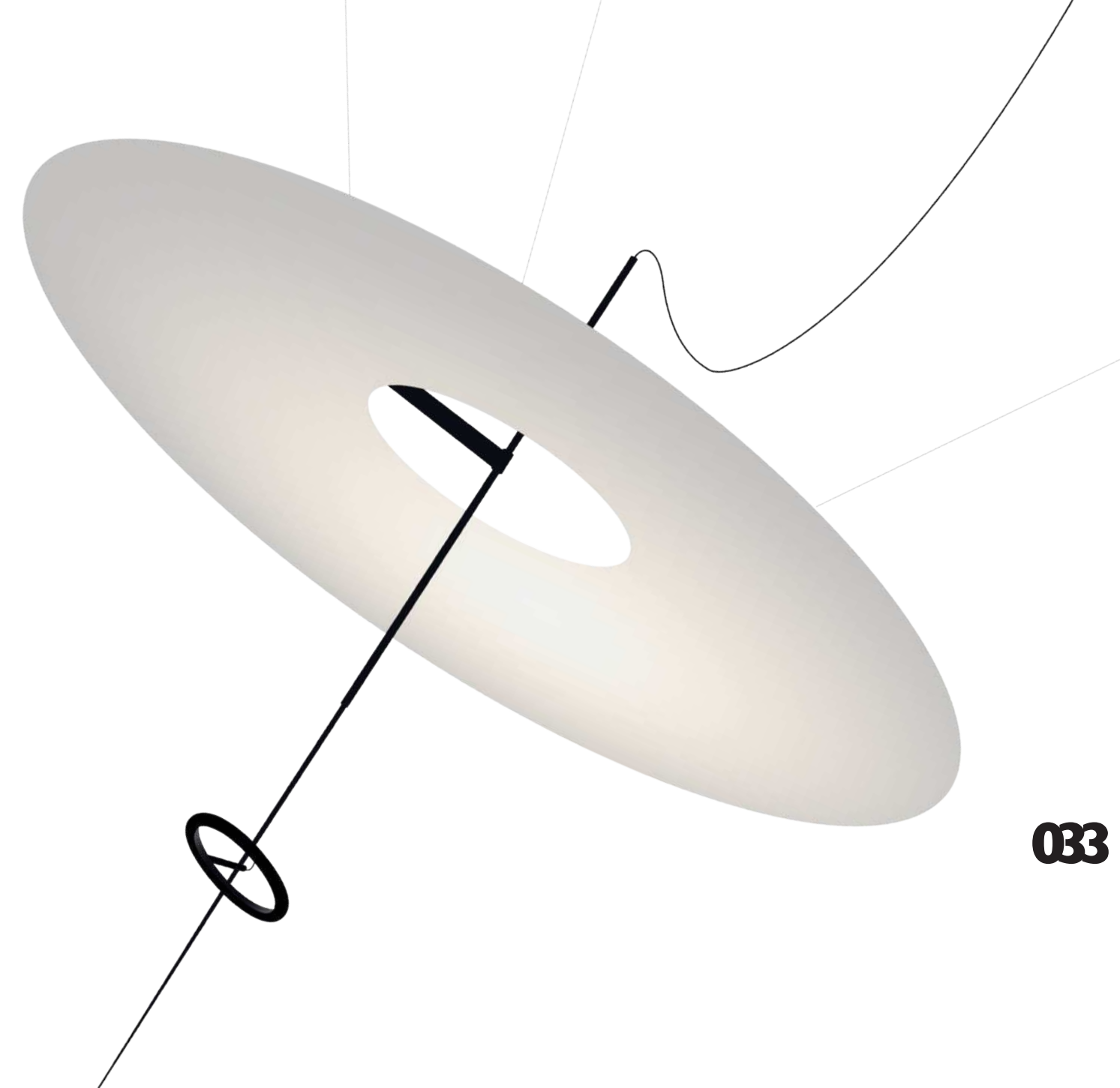

032



033

Ø 180 cm

FLYING DISC at Hotel Unique, São Paulo

Ringelpez nude



034

RINGELPIEZ SUSPENSION

Being frivolous
is a wonderful
state of mind.



035

NOMEN EST OMEN: **FRIVOLOSO**

036

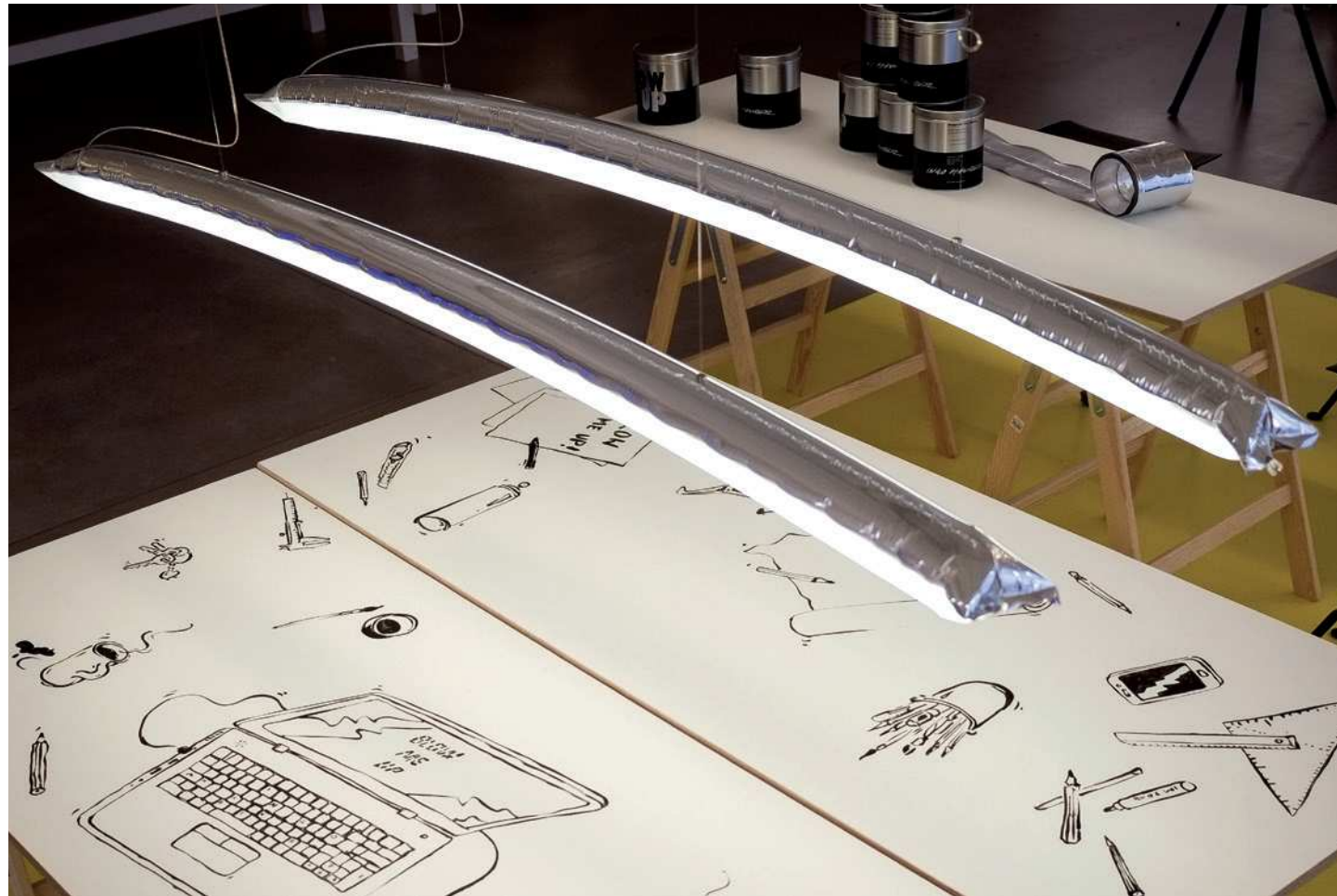

037

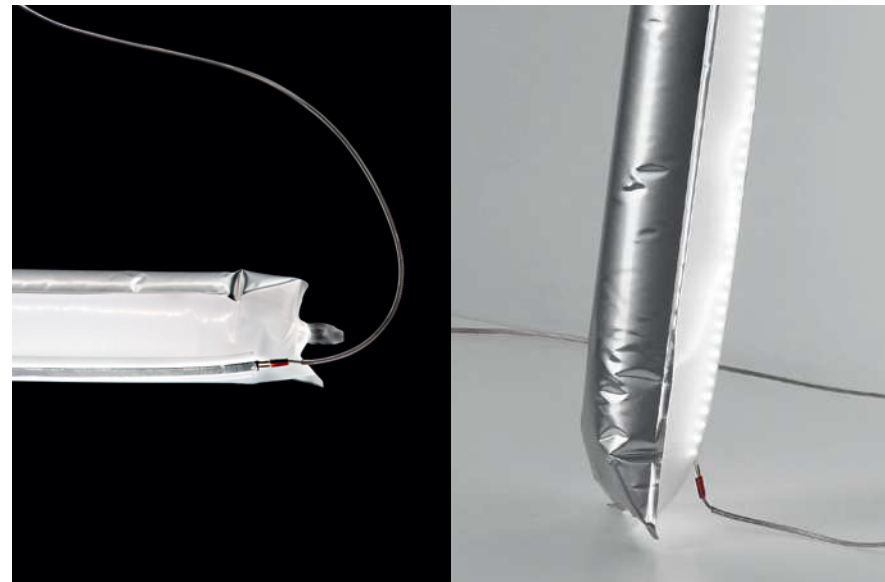

The spirit of a young
 mind fearlessly
 neglecting ordinary
 aesthetics.
 Common material
 transferred into a
 functional but
 uncommon light.
 Cleverly engineered
 with new ideas.
 LED with light reflector.
 Lights up by touching.

First Prototype. Photos by Theo Möller

BLOW ME UP



038

SILVER
PINK
GREEN
BLUE

120 or 180 CM

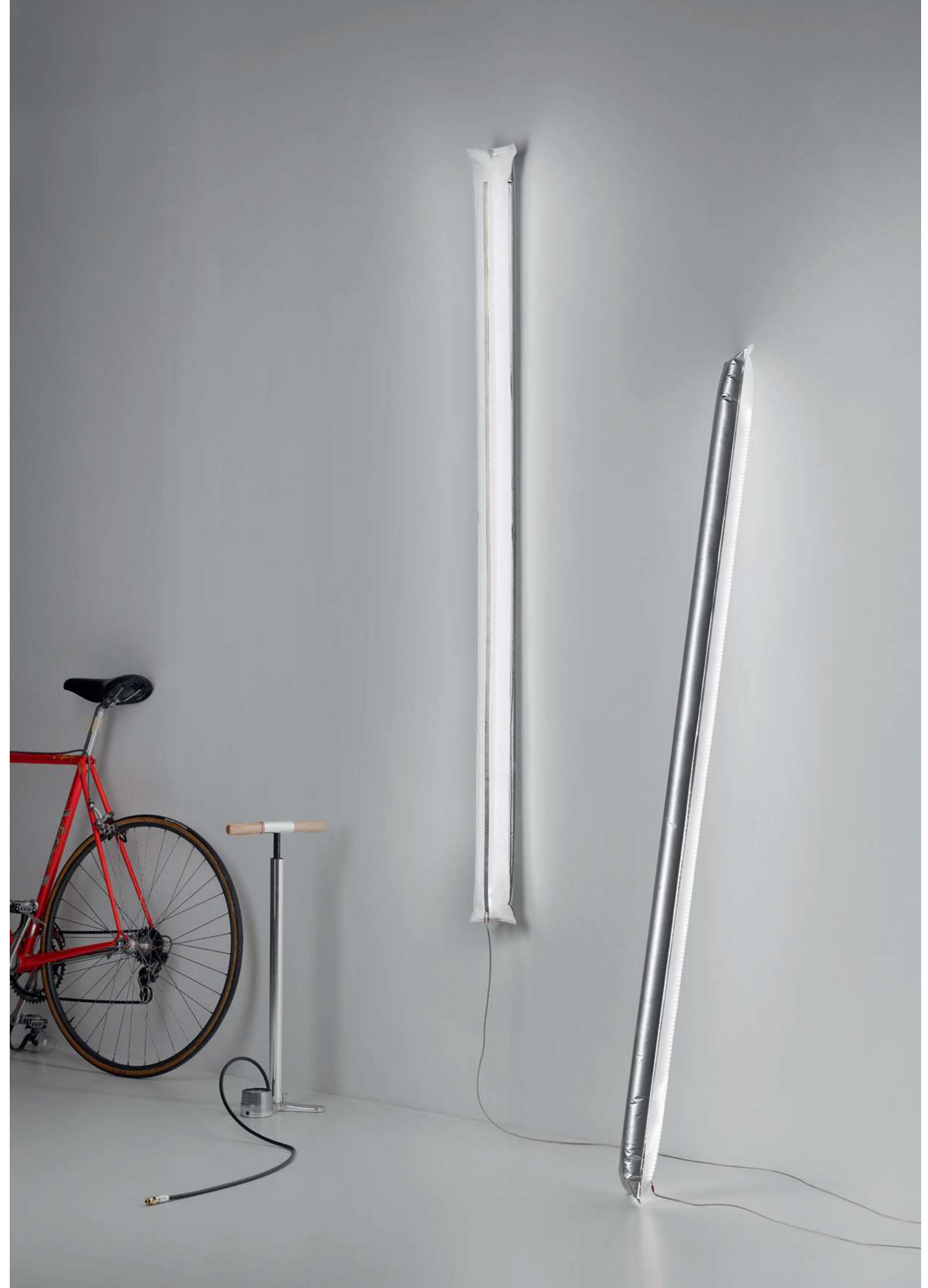

039



040



041

GALACTIC
Light up,
light down
Suspended.

042



It's no secret: Bulbs are where we come from and what we will ever dream of. The magic of the incandescent bulb is unequalled. LOOP is a dream of Michel Sempels. In his imagination he drew the outline of a bulb in the air like a stunt pilot. LOOP is made of a stainless steel wire, brass, aluminium and plastic combined with cutting-edge LED technology.

043

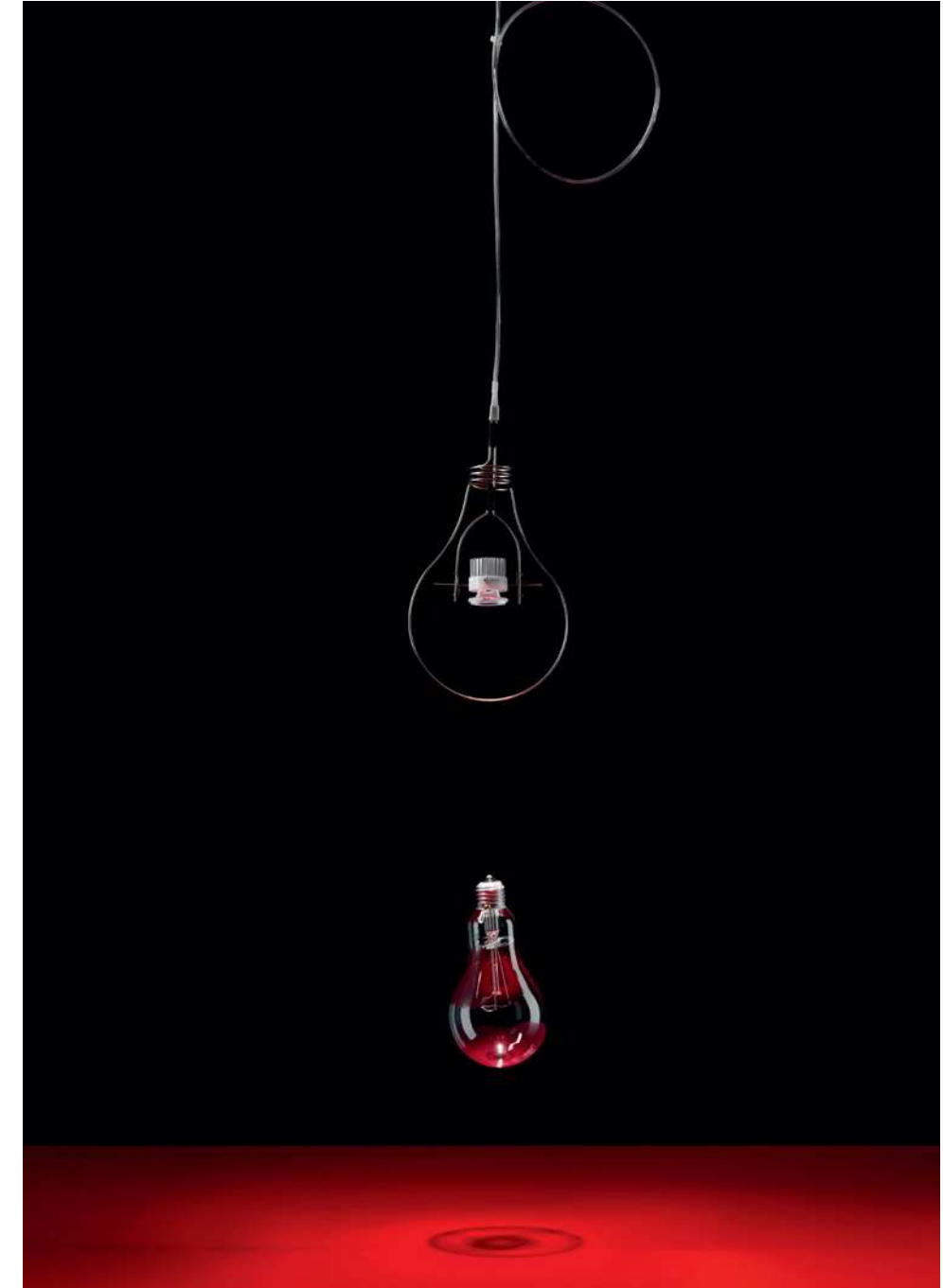

LOOP

BACK TO WORK!

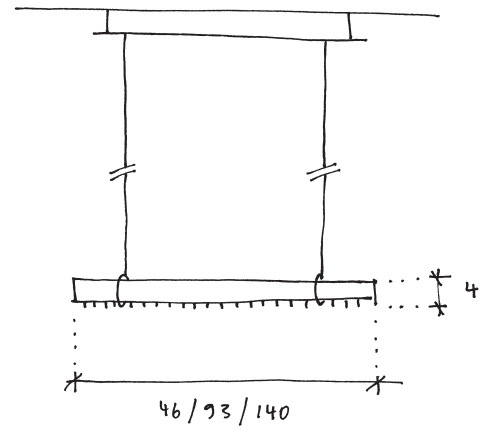

The quality of working light
BRICK a LED system.
Multifunctional for office, kitchen, private desk.
Illuminating spaces. Dimmable.

044



This is a man's world.

045



046



Up



Down

Upside down
Brick, you turn me
inside out and round
and round

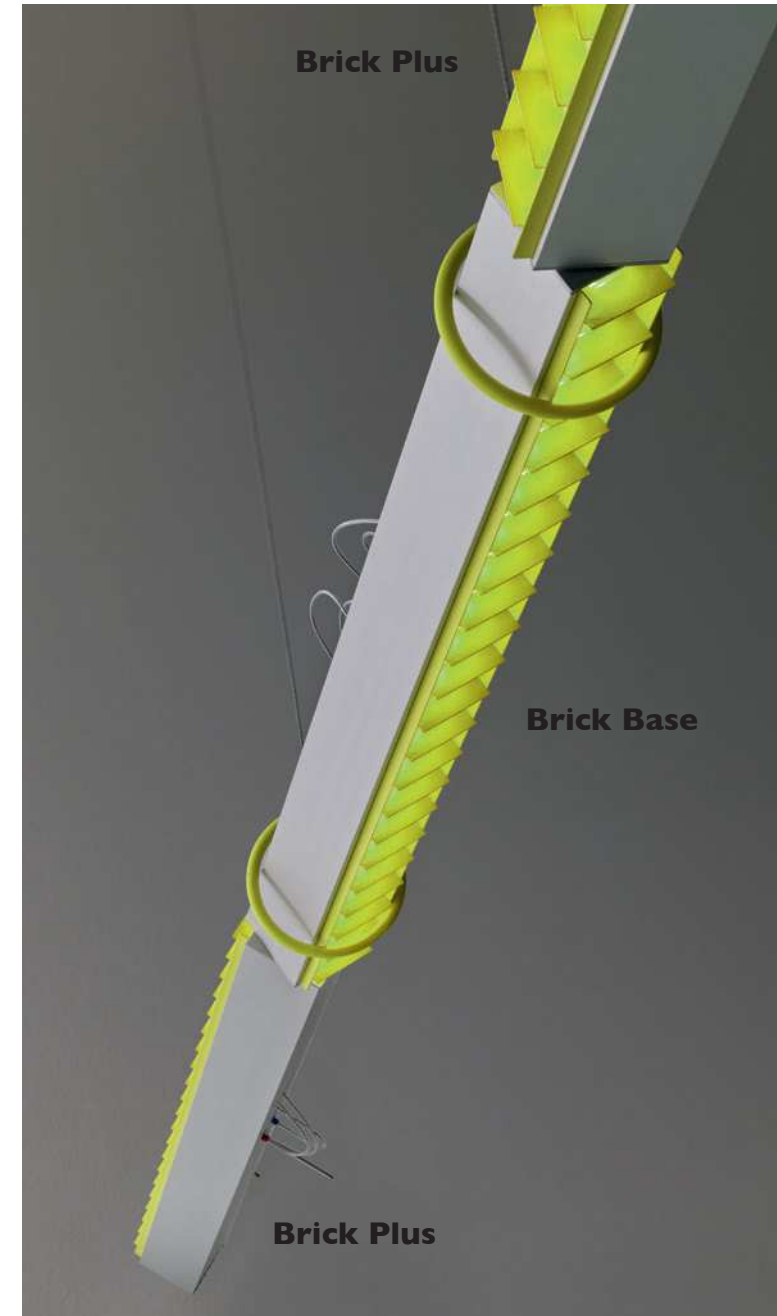

The body is available
in black, blue or
silver. The diffuser
in fluorescent red,
yellow or silver.

047

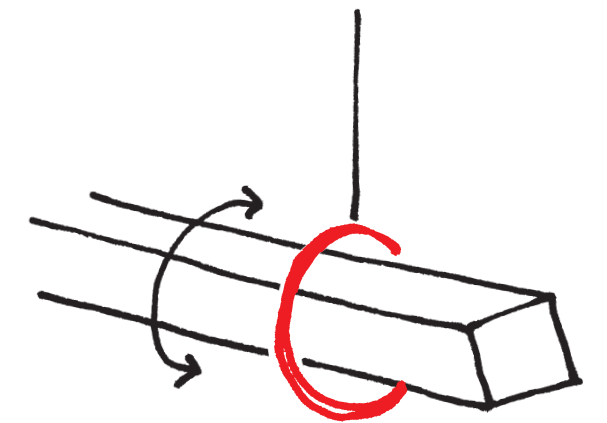

048



The original mounting tool for Light Structure from 1970. Still in use.

049



LIGHT STRUCTURE Six tubes

Inspired by
Buckminster Fuller's
Tensegrity System.
LIGHT STRUCTURE
by Peter Hamburger
and Ingo Maurer, 1970.
Soft and strong: LED.

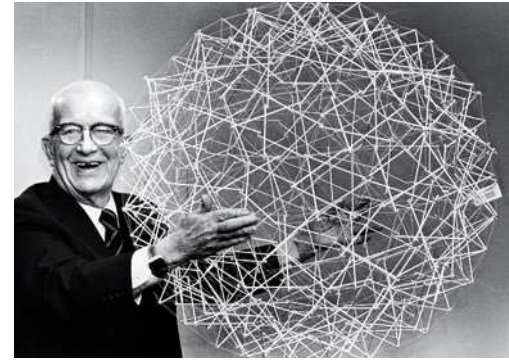

© The Estate of R. Buckminster Fuller

050



051



LIGHT STRUCTURE THREE Three tubes

052

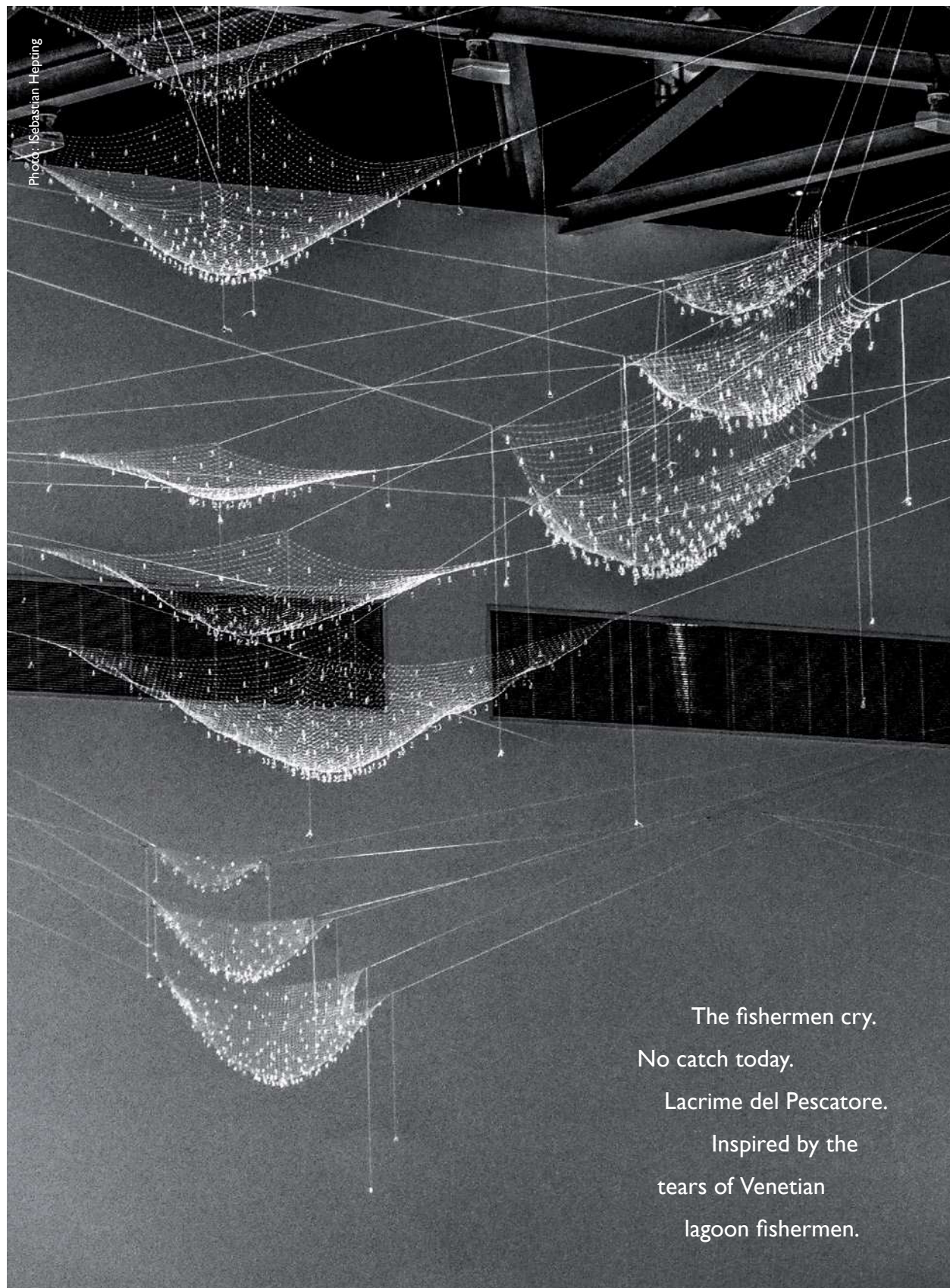
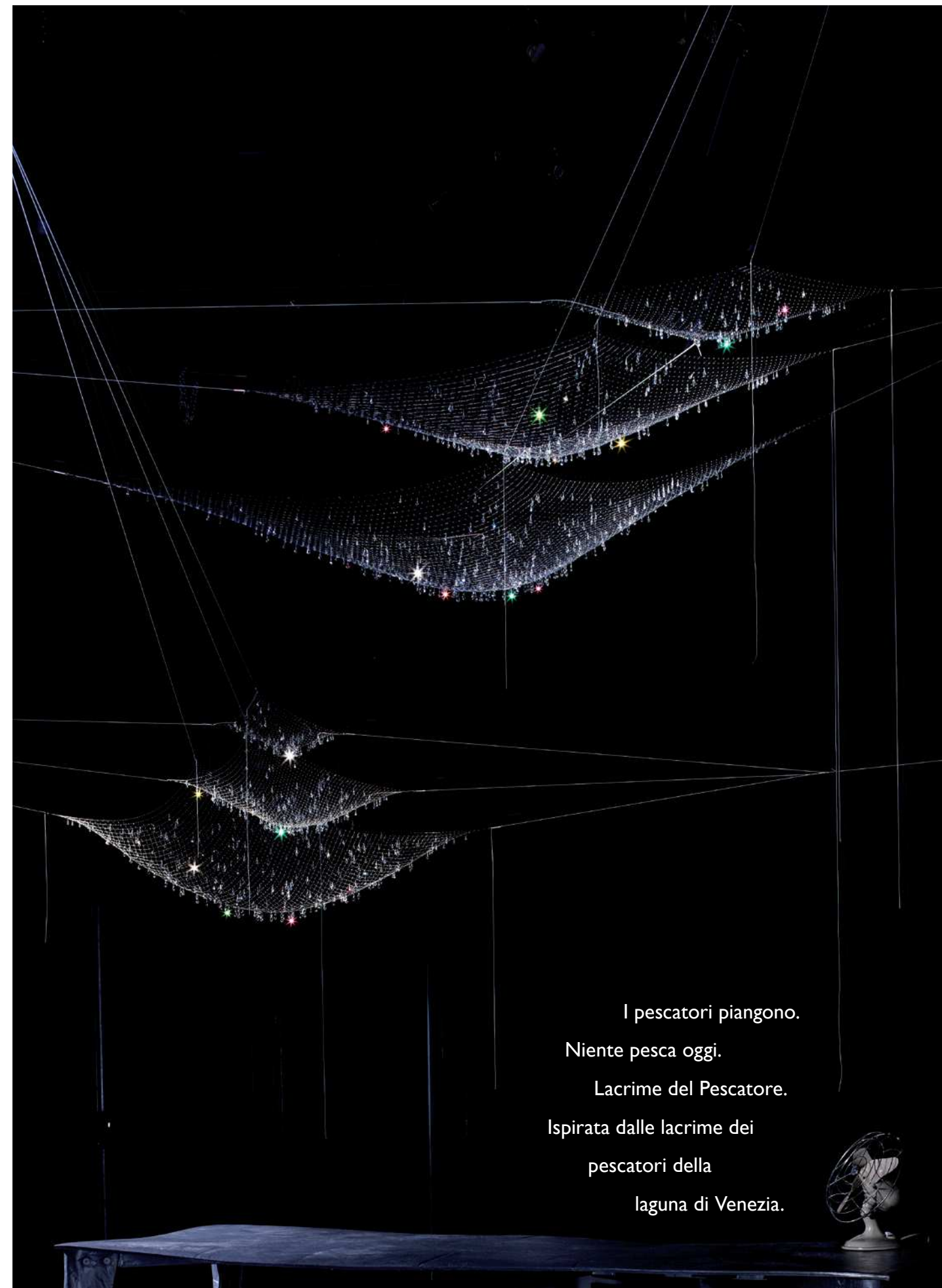

Photo: Sebastian Hepping

The fishermen cry.
 No catch today.
 Lacrime del Pescatore.
 Inspired by the
 tears of Venetian
 lagoon fishermen.

Permanent installation, Park Royal, Vancouver

053



I pescatori piangono.
 Niente pesca oggi.
 Lacrime del Pescatore.
 Ispirata dalle lacrime dei
 pescatori della
 laguna di Venezia.

LACRIME DEL PESCATORE

Installation in Milano

Can you hear
the crystal
lightdrops
whispering
in the wind?

Photo: Myzak & Janssch, Munich

056



JOHNNY B. BUTTERFLY Bulb also available in LED

昔者莊周夢為胡蝶，栩栩然胡蝶也，自喻適志與。不知周也。俄然覺，則蘧蘧然周也。不知周之夢為胡蝶與，胡蝶之夢為周與。周與胡蝶，則必有分矣。此之謂物化。



A Chinese man
dreamt he was a
butterfly, fluttering
hither and thither,
enjoying itself
to the full.
Suddenly he awoke.
Now he doesn't
know whether
he was a man
dreaming he was
a butterfly, or
whether he is
now a butterfly,
dreaming
he is a man.

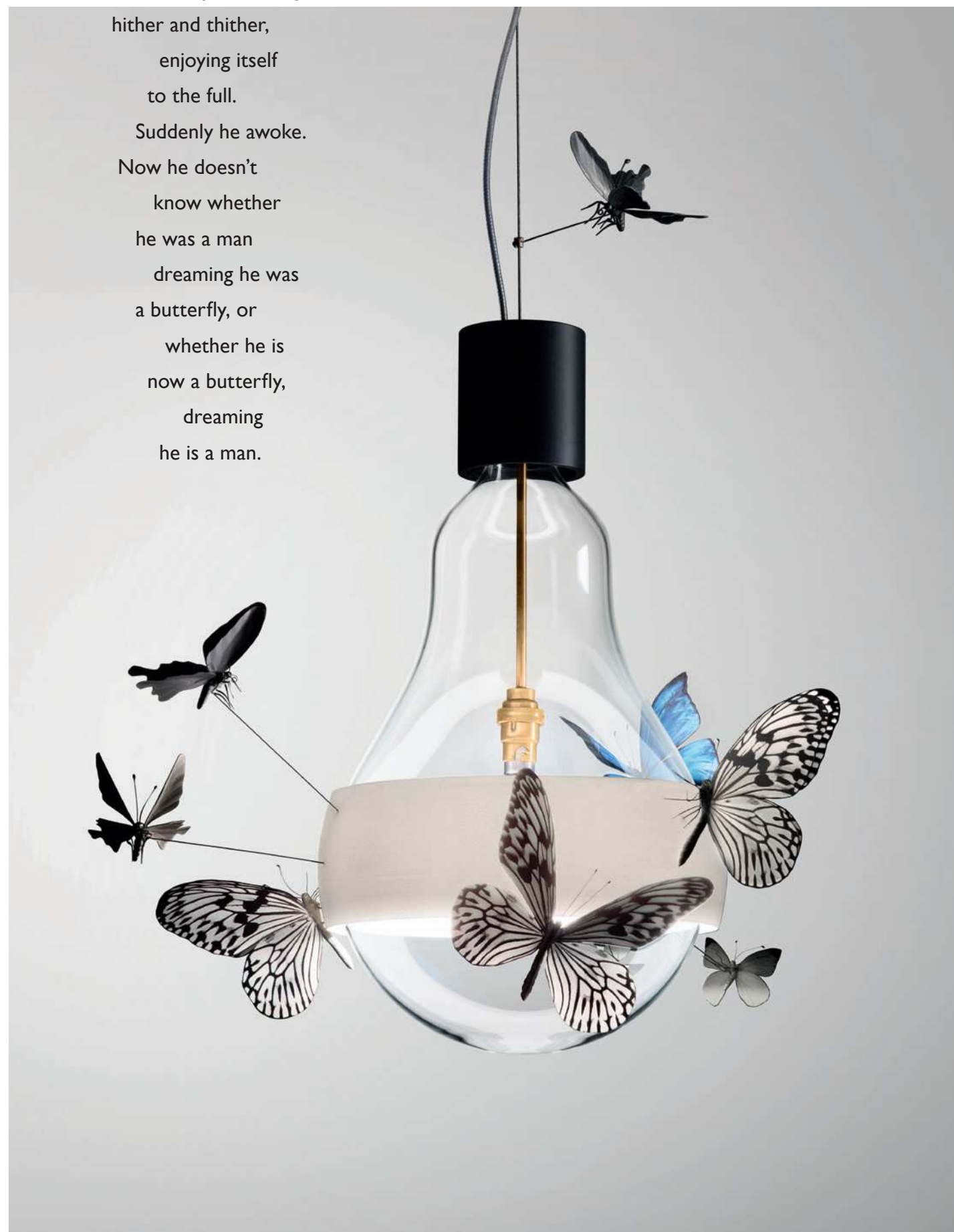

057

FLATTERBY Limited edition

058

Real or not real?
What we see.
Or what we feel?
Romance, reinvented
technically.



ONE NEW FLAME

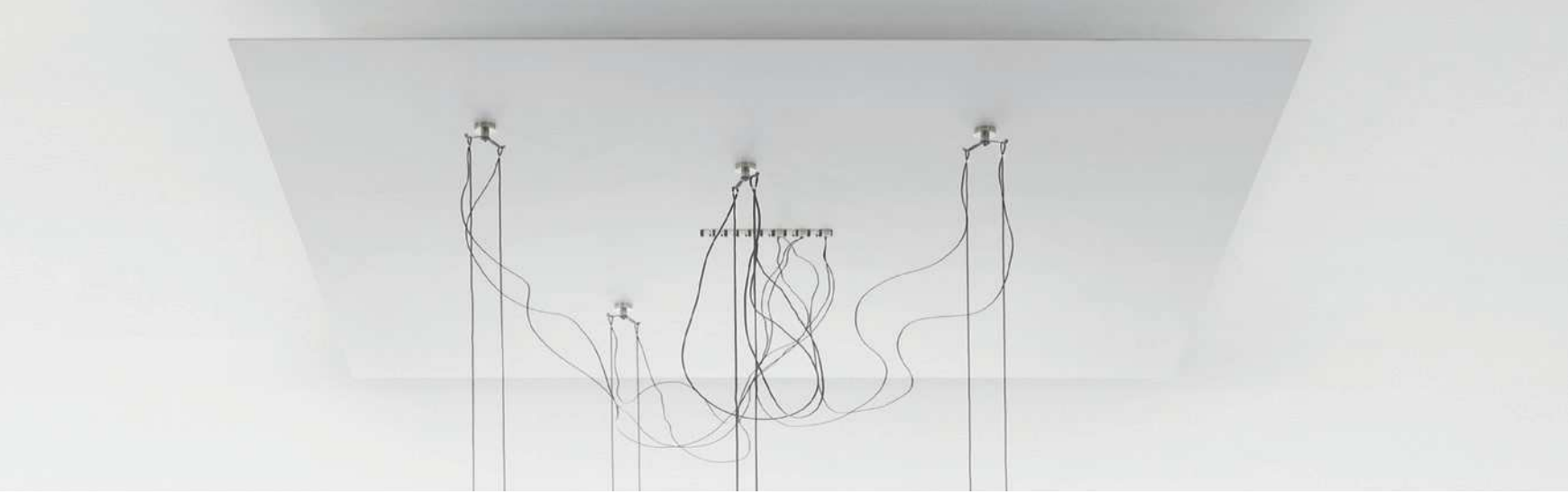

059

FLYING FLAMES



060



Downlight
also available
in polished
chrome finish.

FLYING FLAMES



061

Il Cenacolo installation at Spazio Krizia, Milano, 2013

Watch the video [▶ ingo-maurer.com](http://ingo-maurer.com)

A flame is a flame.
This flame is a
genious technical
solution.
A trompe l'oeil!
Creating illusions
flickering like
a real candle.
Digging deep
in our memories
and emotions.
Moritz Waldemeyer
in collaboration
with the
I.M. team.



MY NEW FLAME

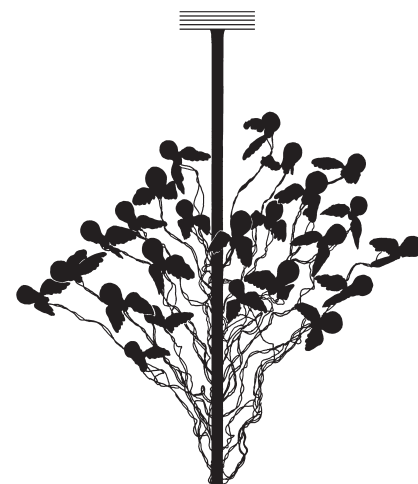

Suspension



Wall

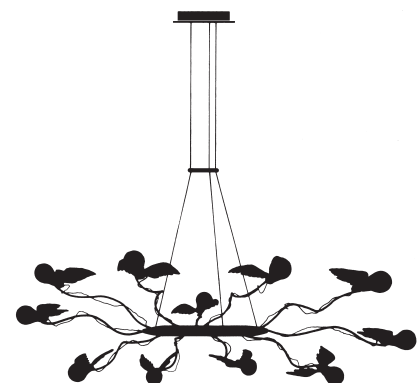
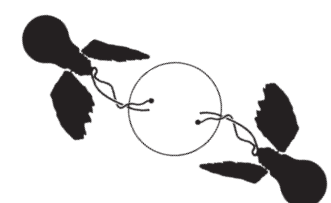

Ceiling

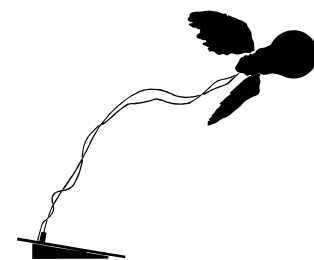
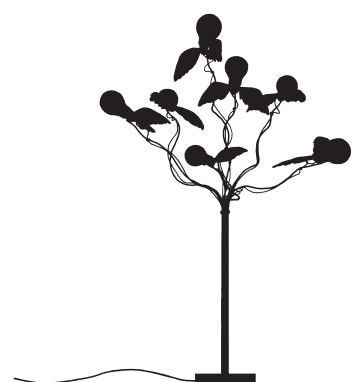

Table

THE BIRDS FAMILY



... solutely here



**MOST
MEMBERS OF
THE BIRDS FAMILY
ARE NOW
AVAILABLE IN
LED**

**TURN ME,
BENT ME,
DO EVERY
THING YOU
WANT.
I WILL
ILLUMINATE
YOU.**



070



BIRDIE



071

BIRDIE'S NEST

NOW ALSO IN LED

The birth place
were light
learned to fly.

Fondation Cartier
pour l'Art Contemporain.

The wings have
hatched at an
exhibition titled
Lumière Hazard
Réflexion in Paris.

072



073

BIRDIE'S RING

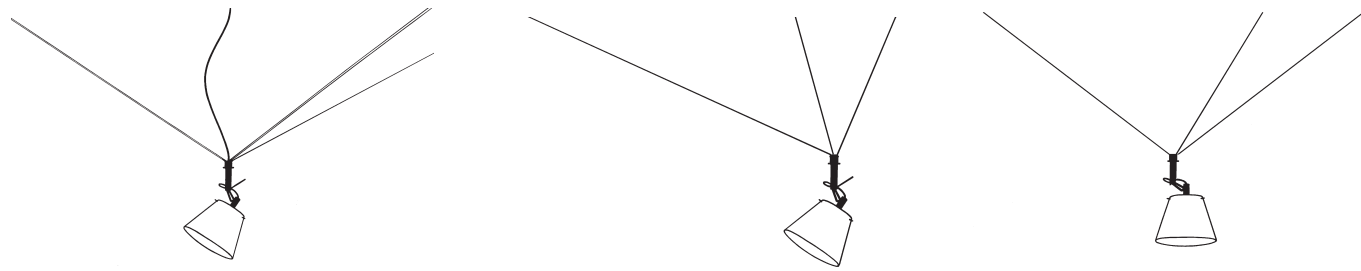

Forward, backwards,
up and down.

Like a juggler,
like a clown.

DA + DORT

dances in space

like you want it to.

Warm light

through a
paper shade.

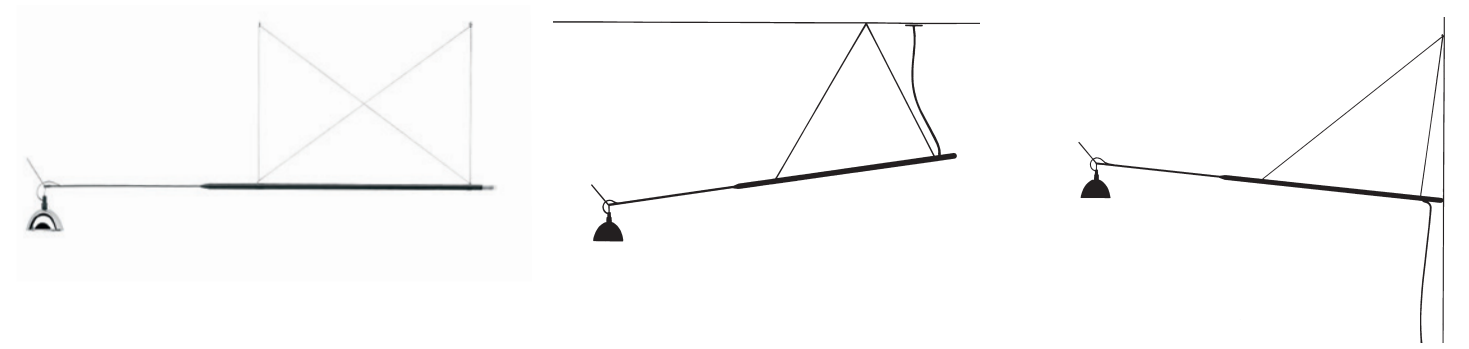

MAX. MOVER LED

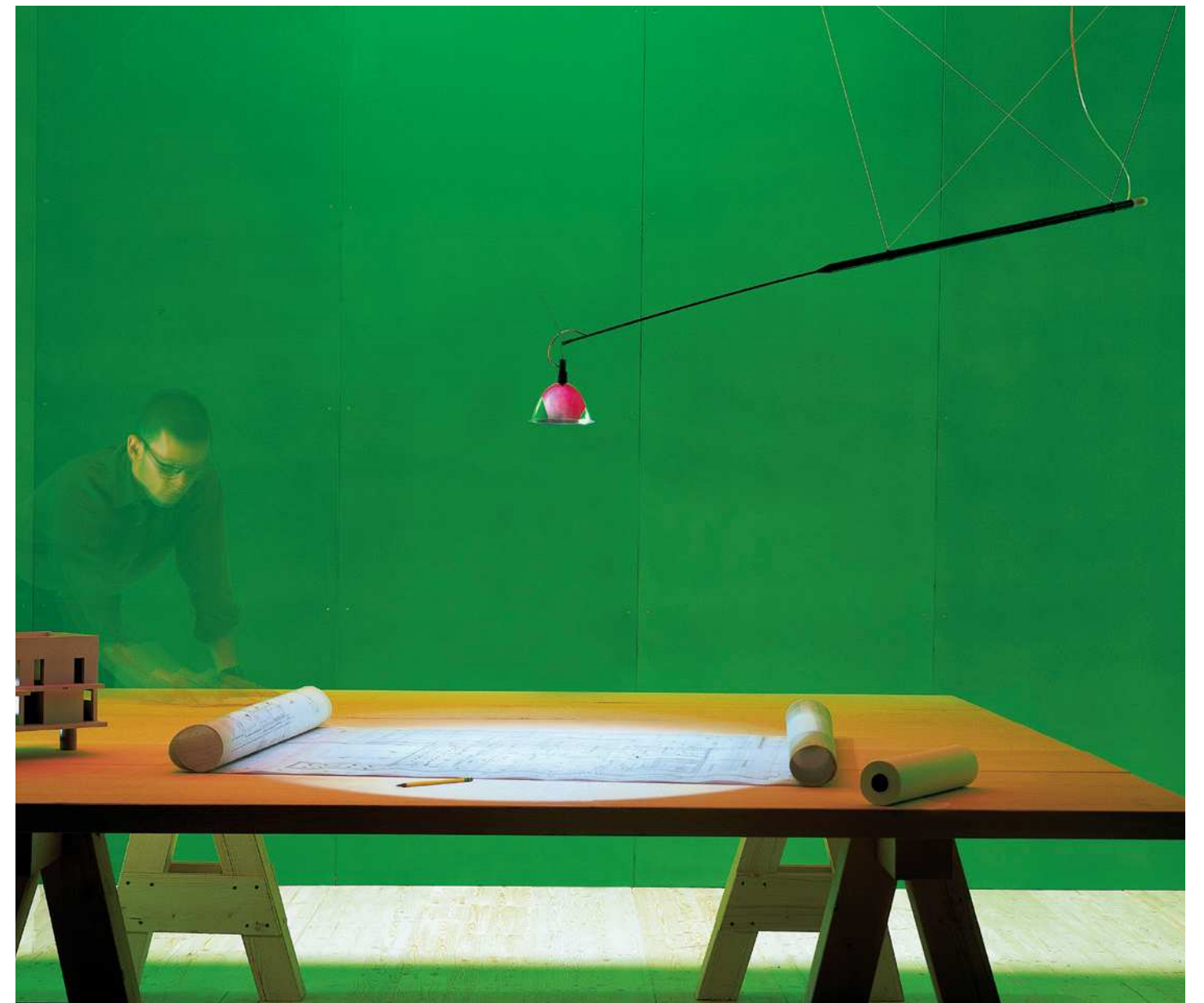

074

075

076



A daily object makes **TU-BE LÜSTER**. 93 tubes.



077

Minimalism: **SCHLITZ** the beginning of the Schlitzes. Now in LED.



078

ONCE UPON A TIME THERE WAS: WO BIST DU, EDISON, ...?

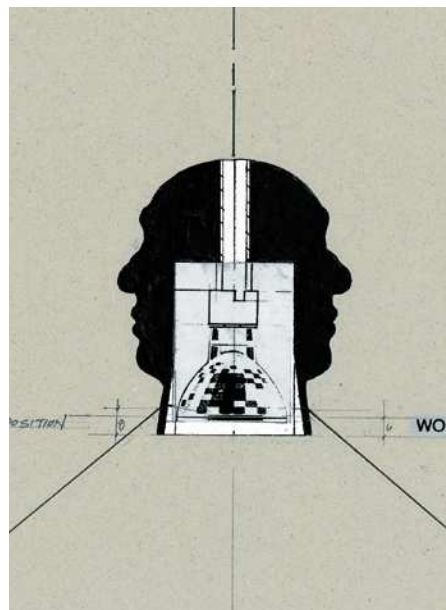

How to illuminate a hologram? Hide the light source. I used the profile of Edison.

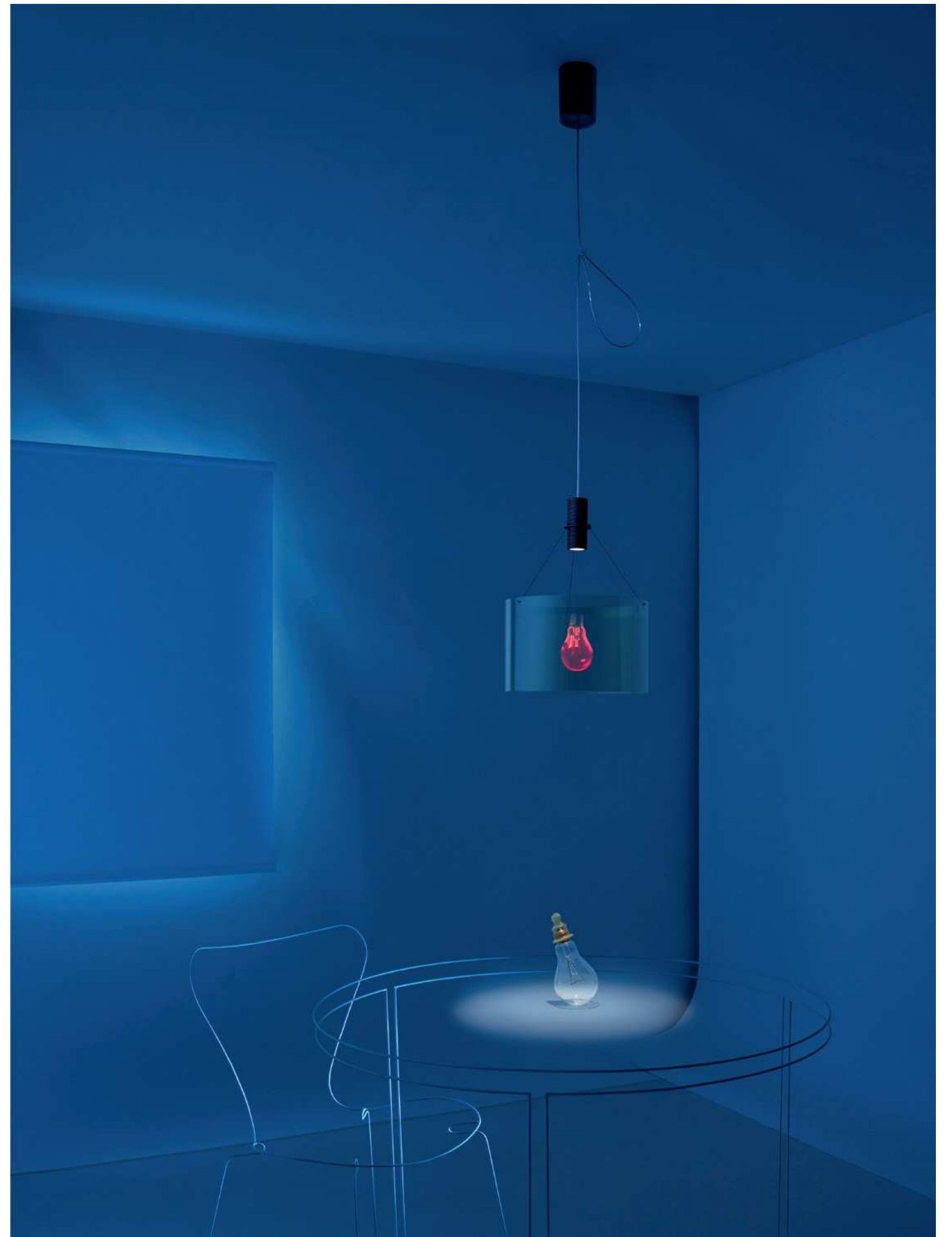

079

Only 10 pieces left

EDDIE'S SON

080



CANNED LIGHT

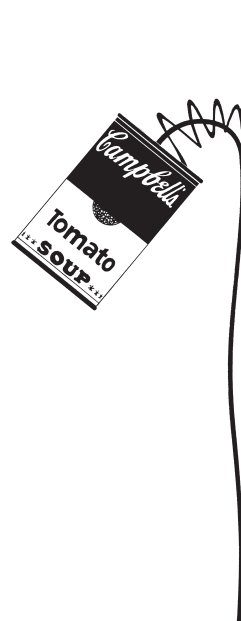

081



Campbell's

CAMPARI LIGHT BY RAFFAELE CELENTANO



082



Ten original
Campari Soda
bottles.
Individually
detachable.



083

084

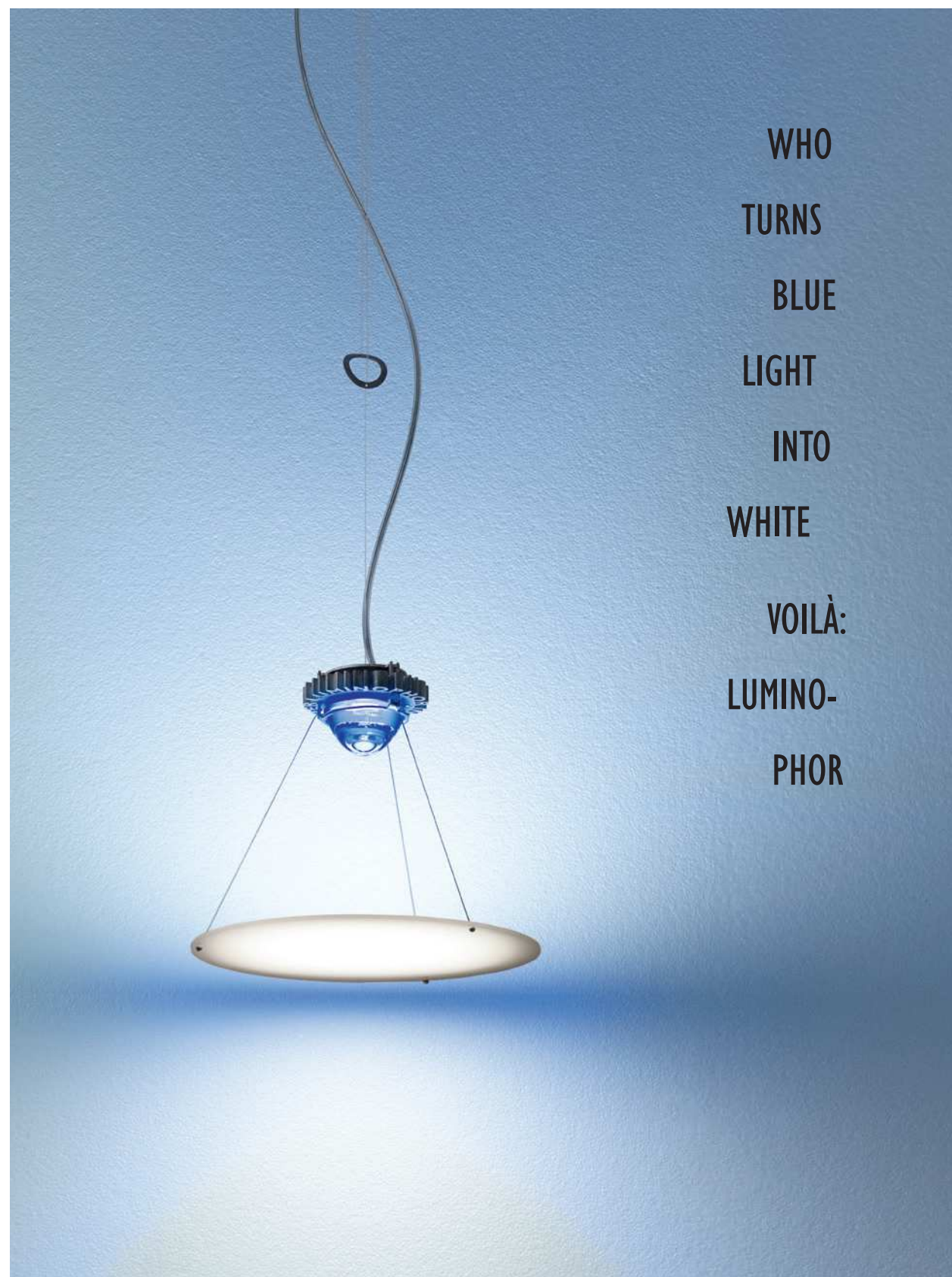

WHO
TURNS
BLUE
LIGHT
INTO
WHITE

VOILÀ:
LUMINO-
PHOR

LUMINOPHOR Suspension Ø 21 cm

085



The figure is just a fantasy

086

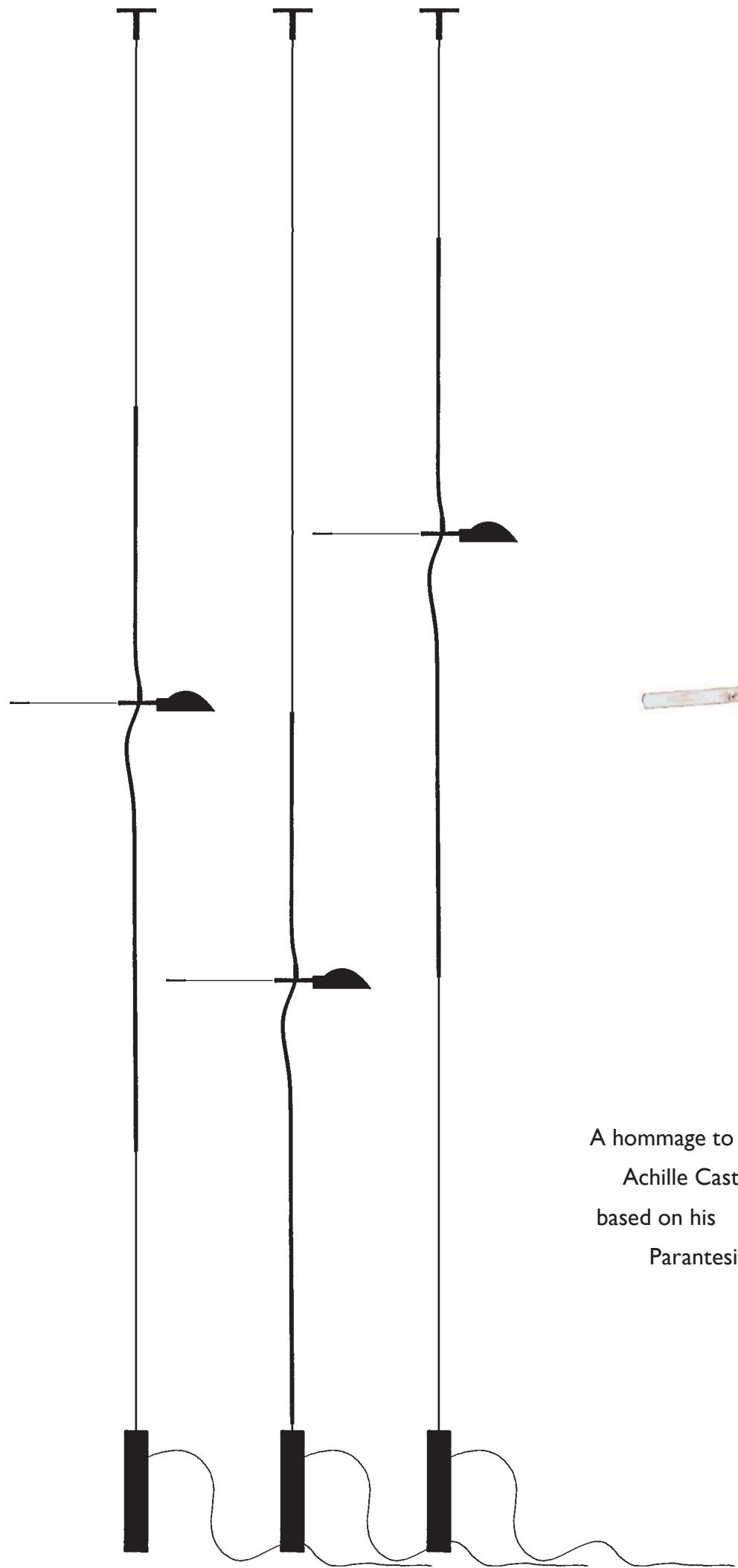

A homage to
Achille Castiglioni,
based on his
Parantesi.

087



HOT ACHILLE

088

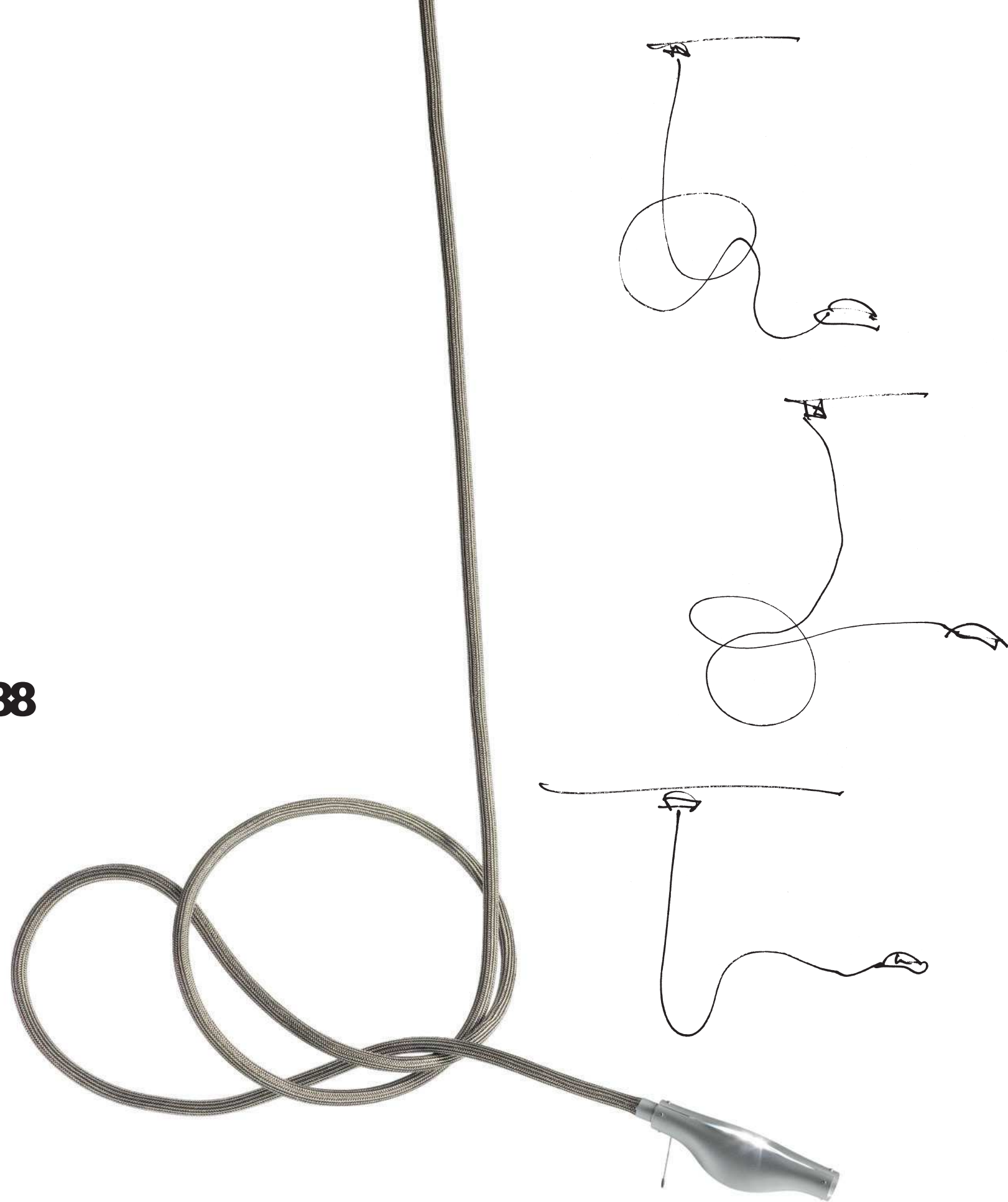

METALL C. COOPER

089

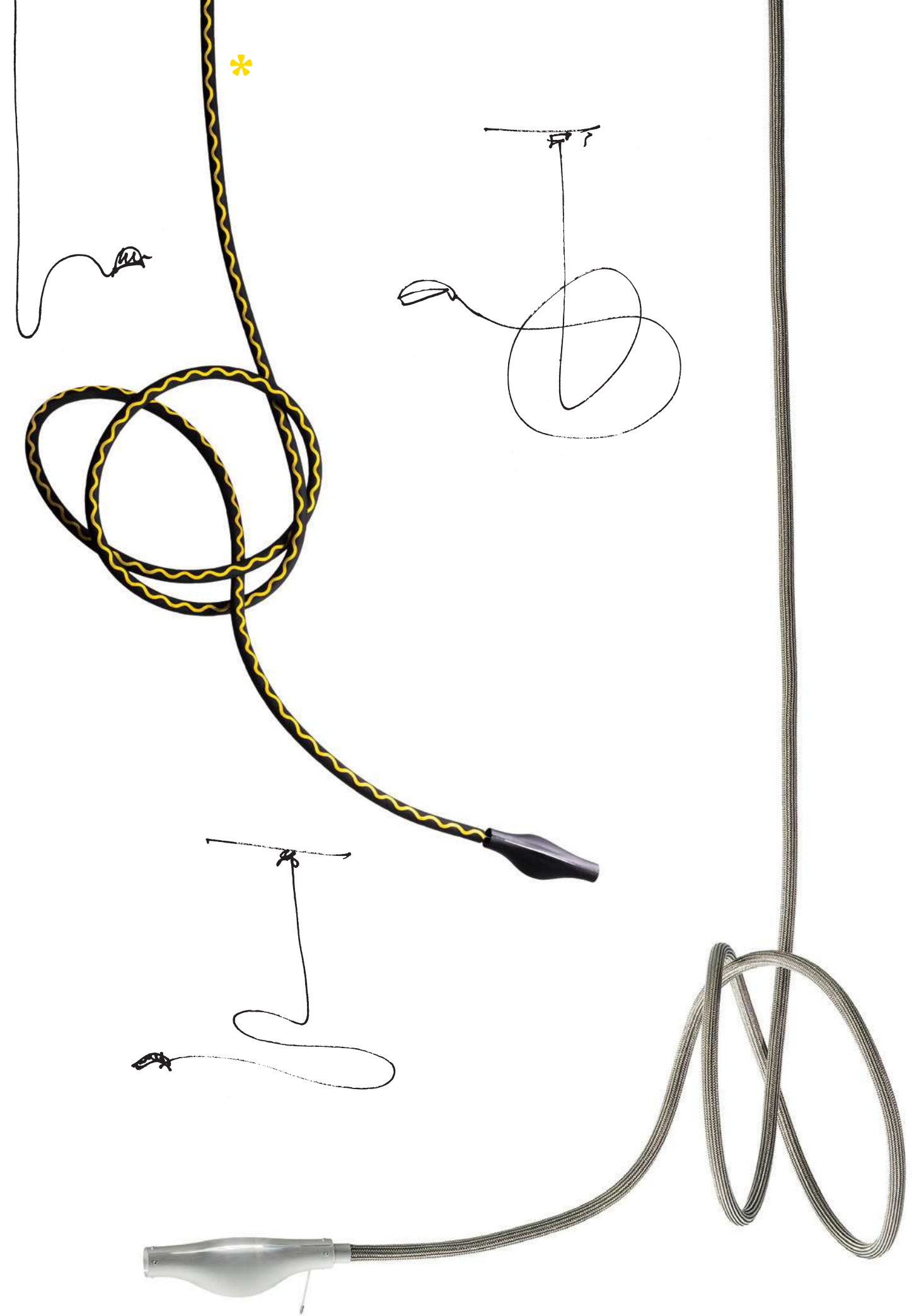

***ALIZZ C. COOPER**

090



MAX. PENDLER



091

FIVE PACK

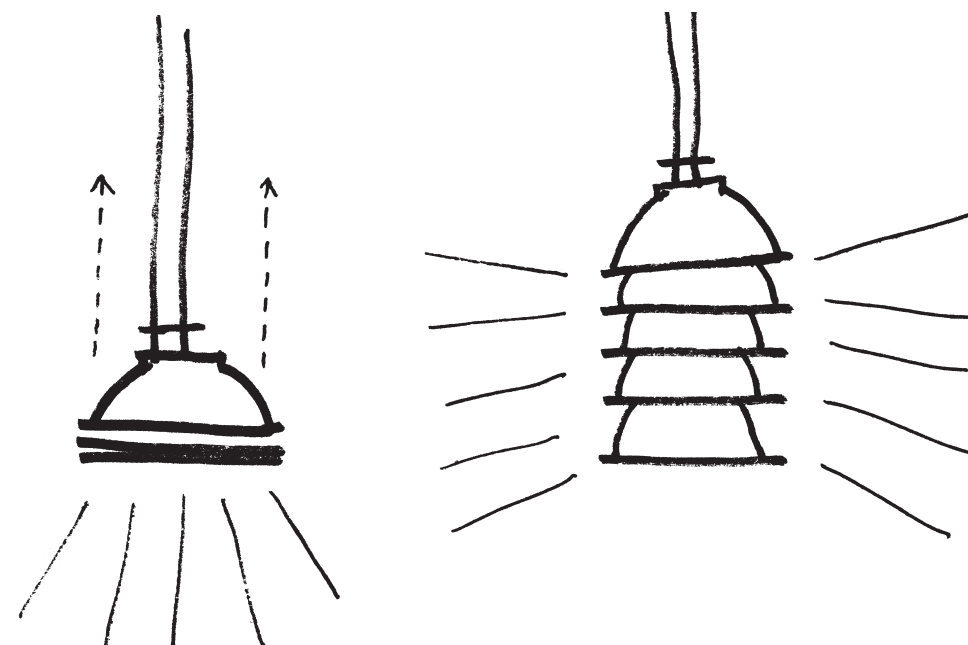

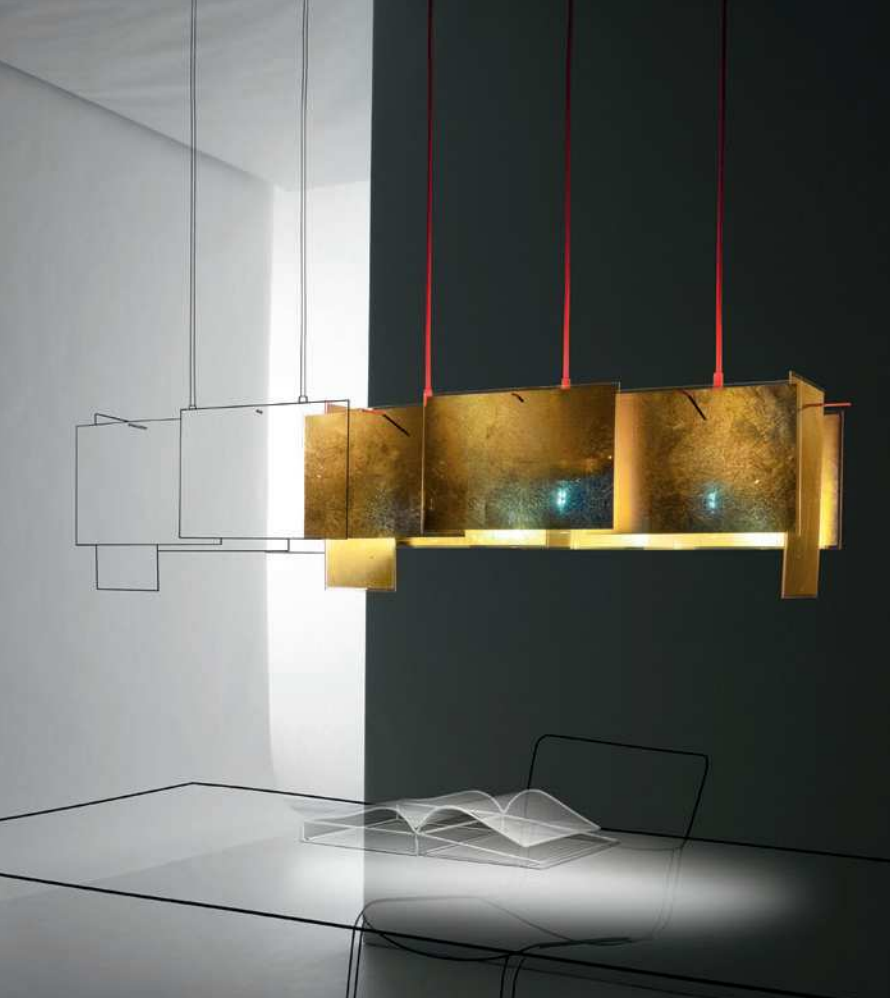

24 KARAT BLAU

092



24 KARAT BLAU M

The gold leaves
between the
shades are beaten
to a thickness
of 1/10.000 mm,
corresponding to
1.000 atomic layers.
This allows short-
wave blue light to
pass through the
molecules, with
a warm yellow-gold
light reflected inside
the shades.
Combine several
1000 Karat Blau
to create unique clusters!

24 Karat Blau M
extends 24 Karat Blau
by about one
shade's breadth.

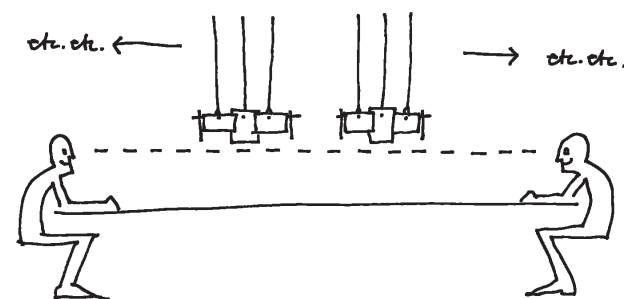

1000 KARAT BLAU

093

Ø 120, 100, 80 cm

094



095



PIERRE OU PAUL

Masterpieces of handcrafting

096



TOTALLY WHITE

ORANGE

ELECTRIC RED

24 CARAT
GOLD

SILVER OR
PLATINUM
PLATED



XXL DOME Ø 180 cm



097

Berlin, die Hauptstadt. XXL Dome at Motel One Berlin Hauptbahnhof.

098



OH MEI MA WEISS

099



OH MEI MA KABIR

MOVES LIKE A MOBILE. UPLIGHT ONLY.

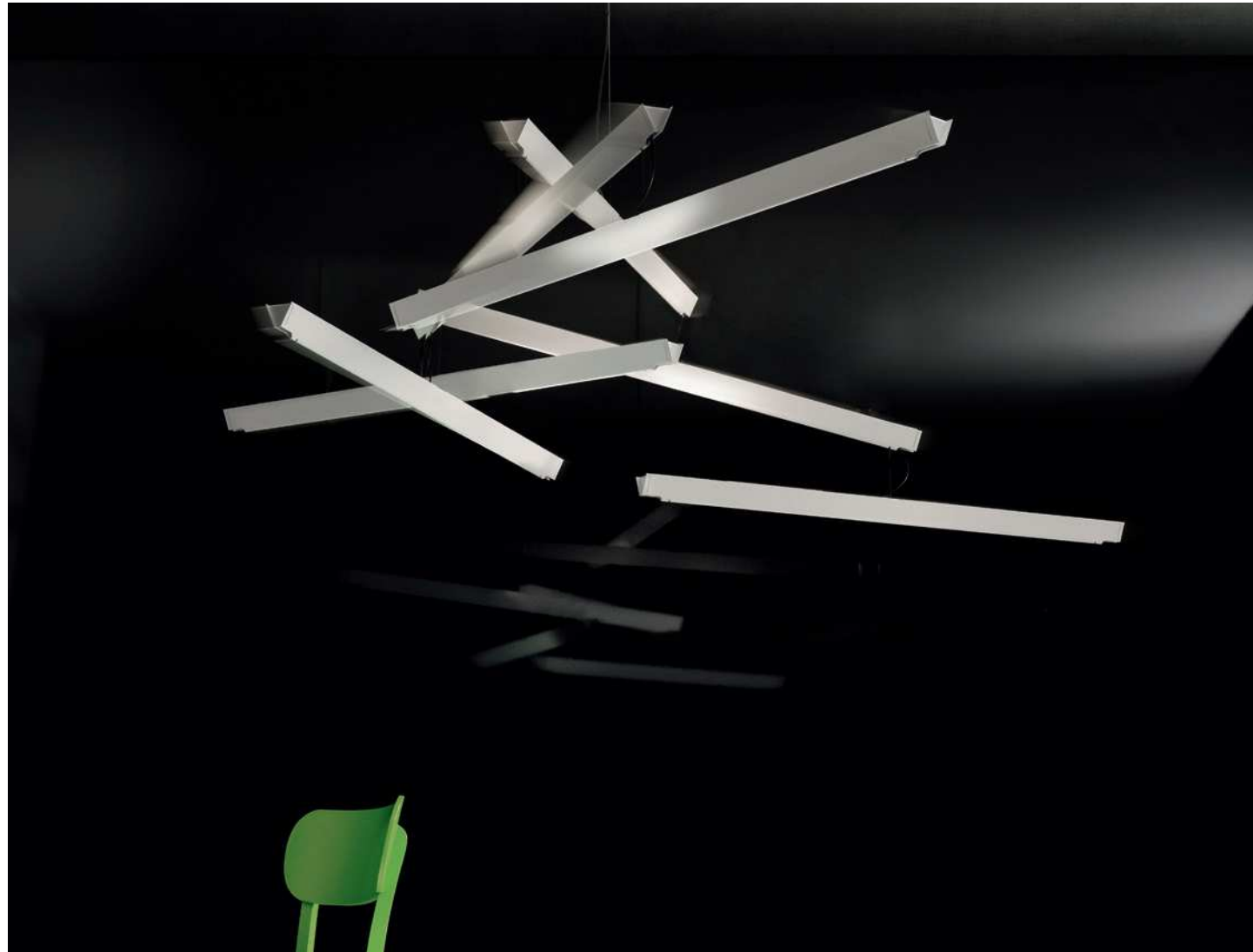

MAN.O.MAN

WILLYDILLY 1983

**EVERGREEN
WITH YOU
AS CO-DESIGNER.**

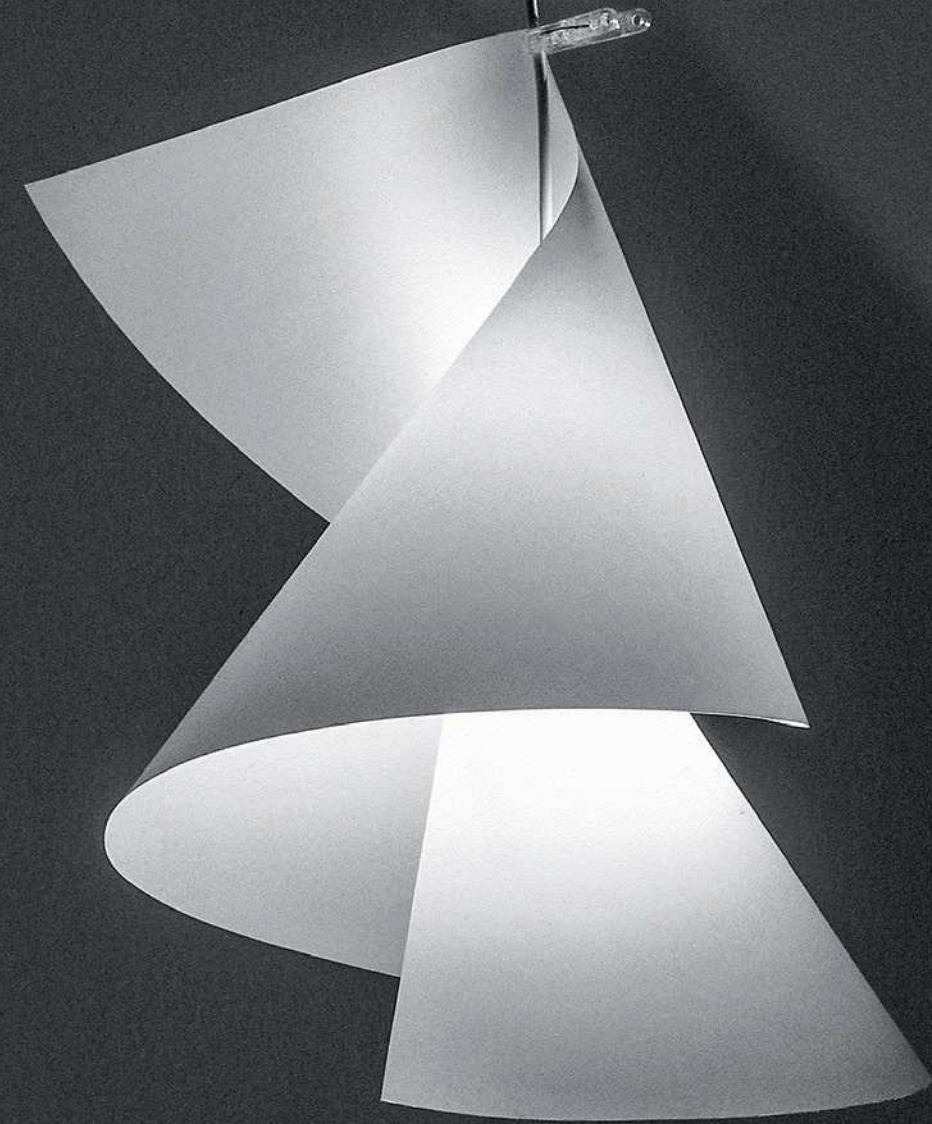

102

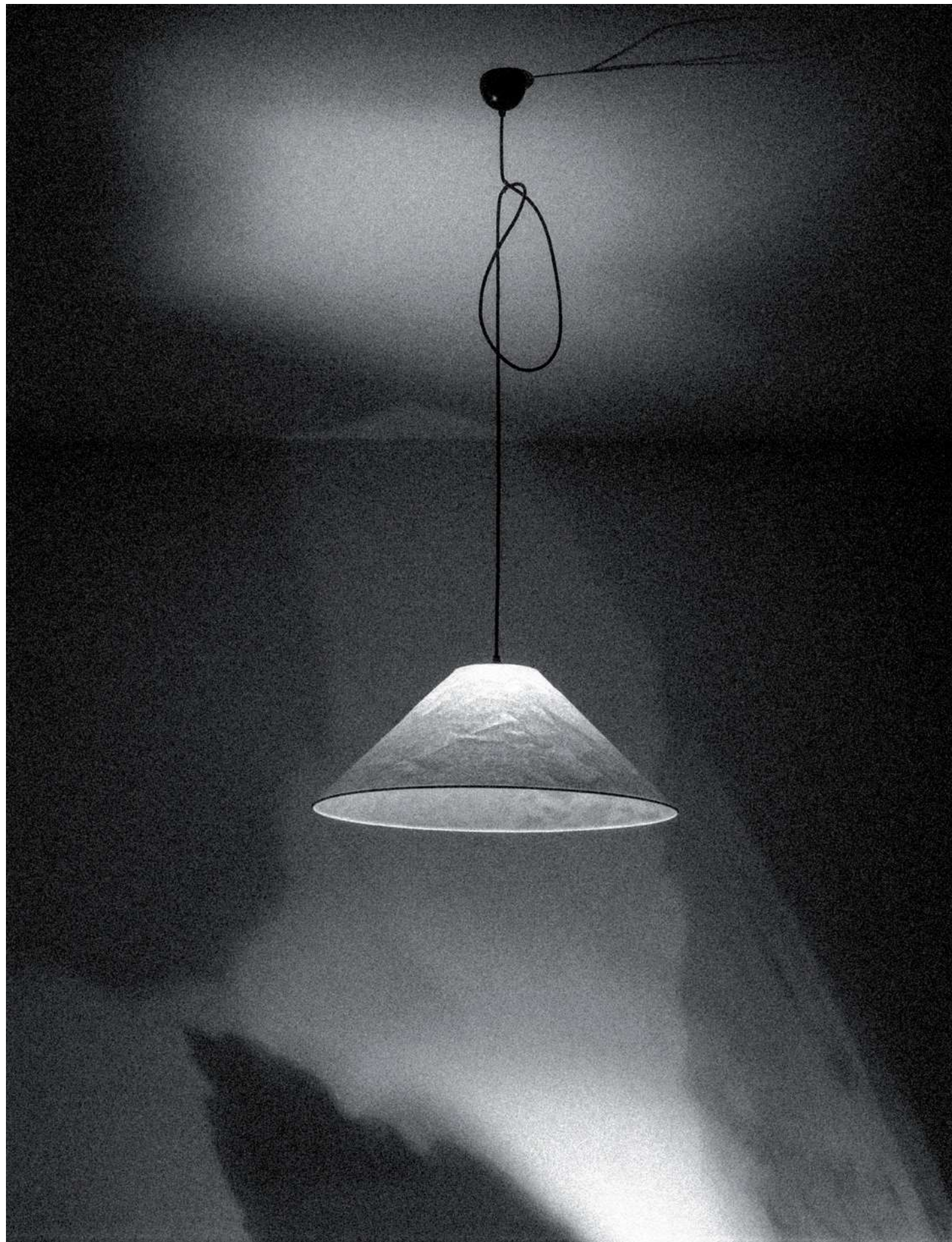

KNITTERLING

103

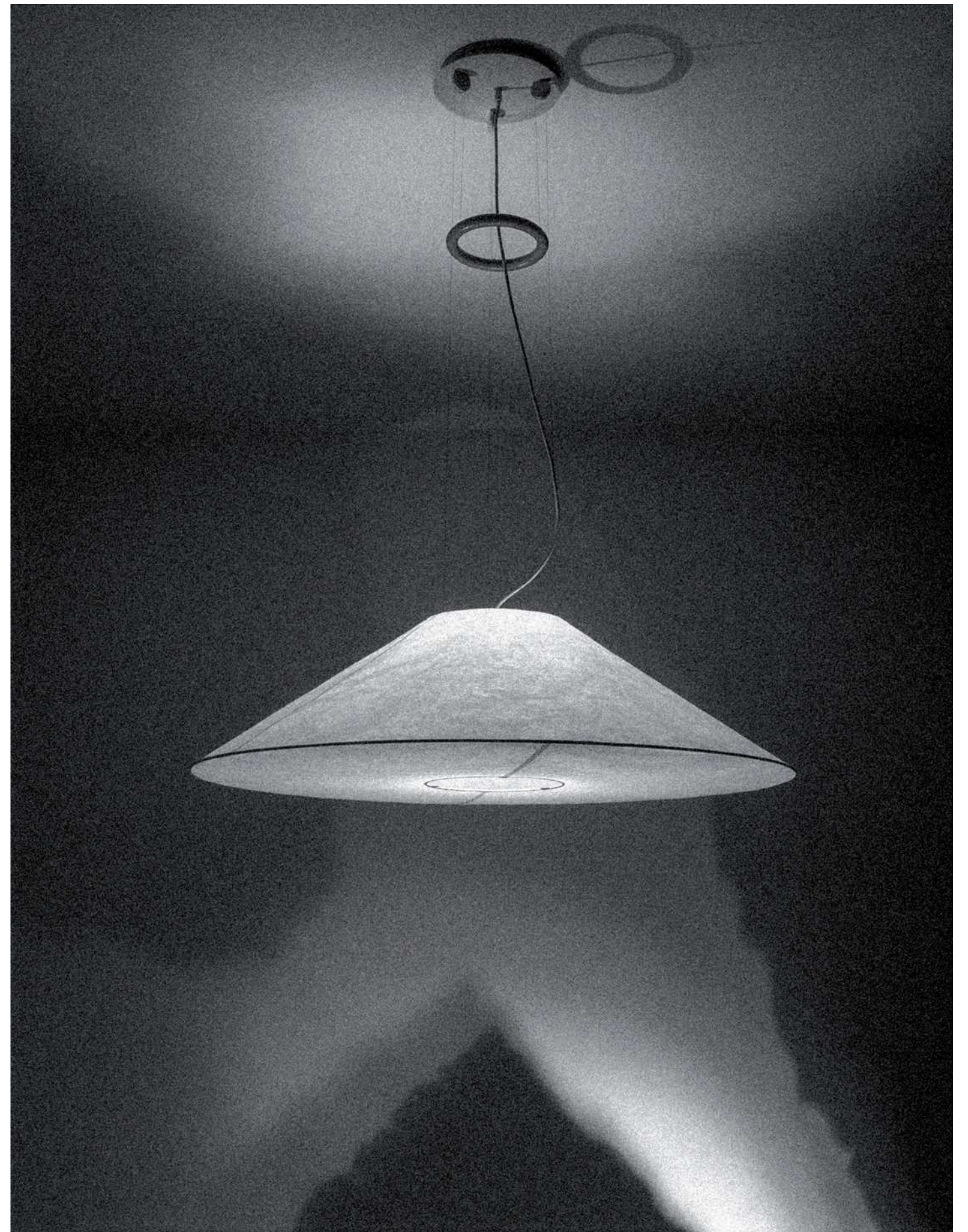

MARU



104



105

FLOATATION

Available in three diameters.
By now a classic.

Das Papier von Floatation, Knitterling, Maru und der Tischlampe Lampampe ist als gewolltes, gestalterisches Element verkittert. Es reagiert auf Schwankungen der Luftfeuchtigkeit. Dadurch kann sich die Spannung der Schirme verändern. Diese Lampen sind nicht geeignet für Räume mit hoher Luftfeuchtigkeit.

The paper of Floatation, Knitterling, Maru and the table lamp Lampampe is crinkled. This is an intended design attribute. The material reacts to fluctuations from humidity. Therefore, changes in the rigidity of the shades can not be prevented. These lamps are not suited for environments with high humidity.

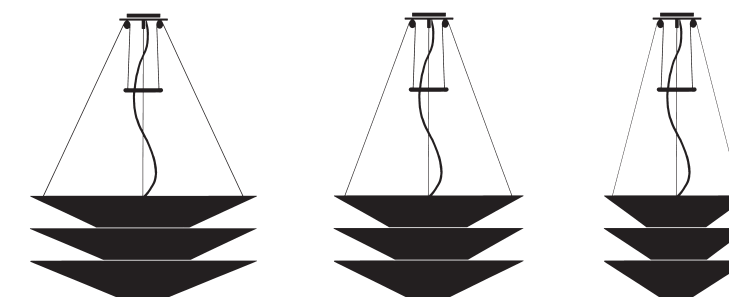

Ø 120

Ø 100

Ø 75



JOHNNY B. GOOD



GRASL

108



SAVOIE

109



ÖFF ÖFF



FLY CANDLE FLY! No electricity.

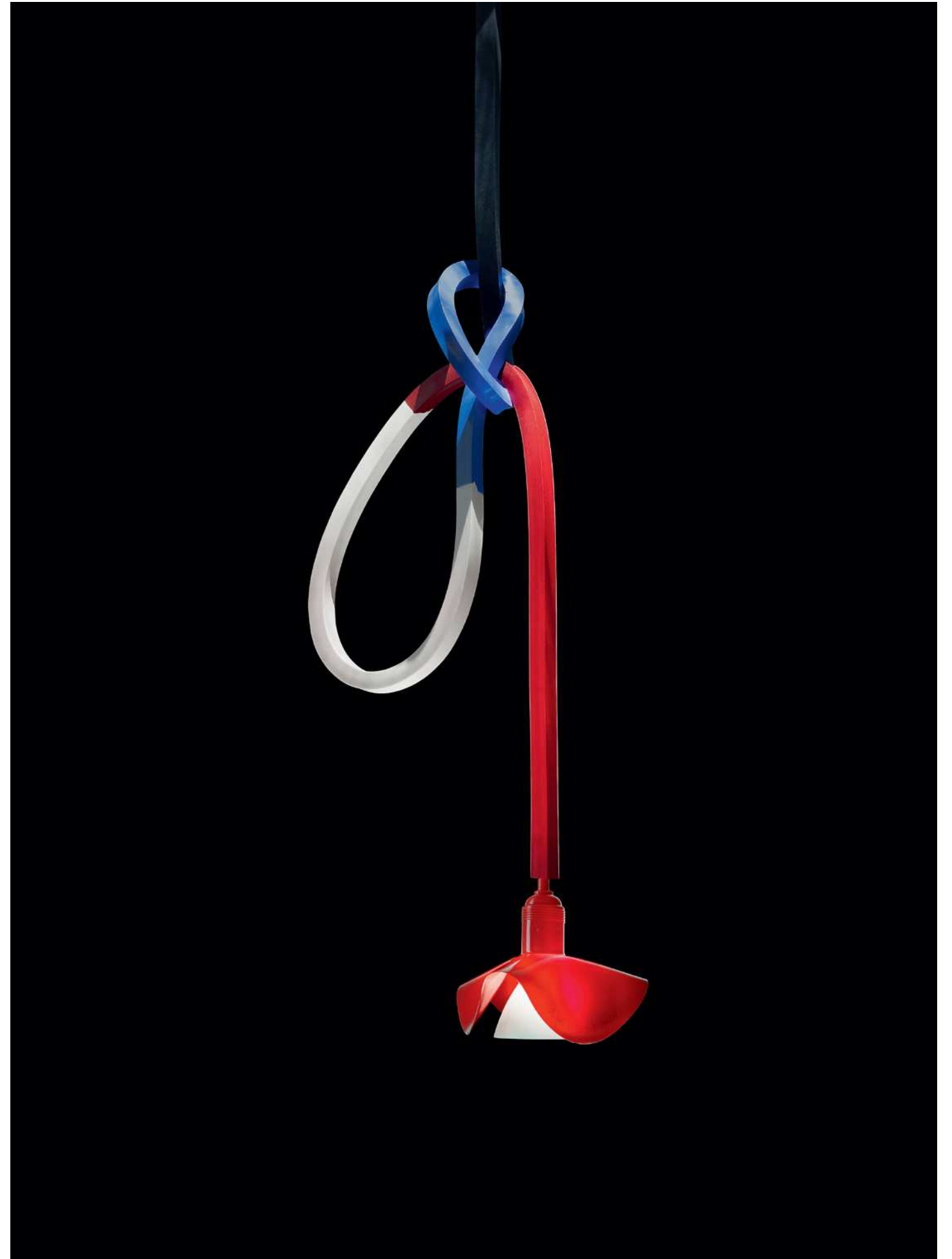

ZUFALL C.

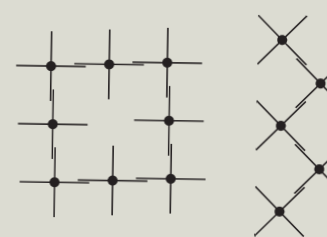
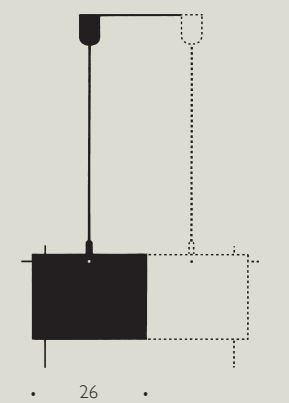
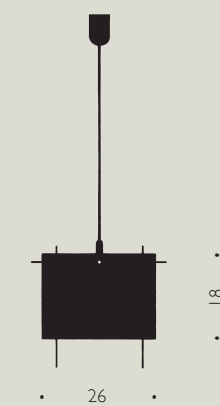
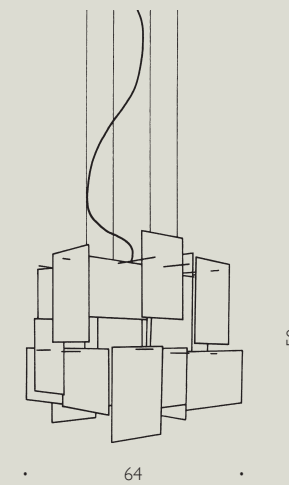

1000 Karat Blau Axel Schmid 2009/2016

18 oder 20 Blenden aus Acrylglas mit innenliegendem Blattgold. Mehrere Exemplare können verbunden werden. Kabel und Stabkreuz in Rot. Metall, Acrylglas, Gold, Kunststoff. ■ 18 or 20 shades made of acrylic glass with gold leaf inside. Combine several 1000 Karat Blau to create unique clusters. Cable and rods in red. Metal, acrylic glass, gold, plastic. ■ 18 ou 20 écrans de matériel acrylique avec feuille d'or. En combinant plusieurs exemplaires, vous pouvez concevoir de grands lustres. Câble et tiges en rouge. Métal, matière acrylique et plastique, feuille d'or. ■ 18 o 20 paralumi fatti di foglio d'oro laminato con materiale sintetico. Con più esemplari si possono creare grandi installazioni. Cavo e asta in rosso. Metallo, material sintetico, oro.

LED or Halogen E27, max. 60 W, A++-E 230/450 cm

24 Karat Blau Axel Schmid 2005

Metall, Kunststoff, Gold. Optional einsetzbarer Reflektor. Die goldenen Blenden haben jeweils vier Bohrungen, mit denen sie an dem Stabkreuz in verschiedenen Winkeln aufgehängt werden können. Kabel und Stabkreuz in Rot. ■ Metal, plastic, gold. Reflector for optional use. The golden shades have four holes each, with which they can be suspended on the rods in various angles. Cable and rods in red. ■ Métal, matière plastique, feuille d'or. Réflecteur optionnel. Les quatre écrans peuvent être suspendus dans différents angles et positions. Câble et tiges en rouge. ■ Metallo, materiale sintetico, oro. Riflettore per uso opzionale. I quattro paralumi d'oro possono essere appesi sull'asta a croce in vari angoli e posizioni. Cavo e asta in rosso.

LED or Halogen E27, max. 60 W, A++-E 230/450 cm

24 Karat Blau M Axel Schmid 2005

Material wie 24 Karat Blau. Lieferumfang: Zwei Verbindungselemente, Stabkreuz, Baldachin, Kabel, Fassung, zwei Blenden, Reflektor, Leuchtmittel. Ein Set vergrößert 24 Karat Blau um etwa eine Blendenbreite. Die Stabkreuze werden mit Verbindungselementen fixiert. Mehrere Sets ermöglichen eine individuelle Gestaltung von unterschiedlichen Gruppierungen. ■ Material same as 24 Karat Blau. Set includes: Two connectors, suspension rod, canopy, cable, socket, two shades, reflector, bulb. The set extends 24 Karat Blau about one shade's width. Connectors fix the suspension rods to each other. The use of several sets allows an individual layout in a variety of forms and sizes. ■ Même matériel que la 24 Karat Blau. Inclus: deux éléments de fixation, tige en forme de croix, baldachin, câble, douille, deux écrans, réflecteur, ampoule. Un set agrandit 24 Karat Blau d'environ un écran. Les tiges en forme de croix sont fixées par les éléments de fixation. Plusieurs sets permettent une forme personnelle et individuelle de 24 Karat Blau. ■ Materiale come 24 Karat Blau. Sono inclusi: due elementi di collegamento, asta a croce, rosone, cavo, portalampada, due paralumi, riflettore, lampadina. Un set consente di ampliare 24 Karat Blau della larghezza di un paralume circa. Le aste a croce vengono fissate mediante gli elementi di collegamento. L'impiego di più d'un set permette varie composizioni di forma e misura individuali.

LED or Halogen E27, max. 60 W, A++-E 230/450 cm

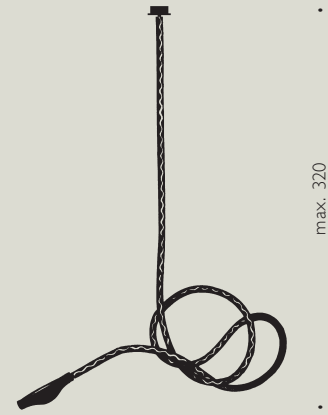

max. 320

Alizz C. Cooper Ingo Maurer und Team 2008

Metall, Kunststoff, Gummischlauch. Der flexible Arm ermöglicht die variable Einstellung des Reflektors. Reflektor 360° um das Leuchtmittel drehbar. Eine Kunststoffschur sichert die Position des Reflektors. Baldachin Ø 8,5 cm. ■ Metal, plastic, rubber hose. The flexible arm allows variable adjustment of the reflector. Reflector rotates through 360° around the bulb. A fine plastic string secures the position of the extended armature. Canopy Ø 8,5 cm. ■ Métal, matière plastique, tuyau en caoutchouc. Le bras flexible permet le réglage variable du réflecteur. Réflecteur rotatif de 360° autour de l'ampoule. Un fil en matière plastique fixe la position du réflecteur. Baldaquin Ø 8,5 cm. ■ Metallo, materiale sintetico, tubo di gomma. Il braccio flessibile permette la regolazione variabile del riflettore. Riflettore rotante di 360° intorno alla lampadina. Un filo in materiale sintetico assicura la posizione del riflettore. Rosone Ø cm. 8,5.

💡 60 W Halogen, 2800 K, 980 lm, 2000 h ⚡ G9, max. 60 W, A+–E
EU: Please check availability on our website.

Blow Me Up Theo Möller, Ingo Maurer und Team 2017

Kunststoff, Stahl. Zum Aufblasen. Rückseite in Silber, Grün, Blau oder Violett. Mit Sensor-Schalter, und Nylonseilen zum Aufhängen. Höhenverstellbar. Wahlweise mit Steckertransformator oder Baldachin mit integriertem Transformator. ■ Plastic, steel. Inflatable. Backside in Silver, Green, Blue or Violet. With sensor-switch and nylon string for suspension. Height adjustable. Choose between plug-in transformer or canopy with integrated transformer. ■ Plastique, métal. Gonflable. Face arrière en argent, vert, bleu ou violet. Avec interrupteur à capteur et fils en nylon pour suspension. Réglable en hauteur. Au choix avec transformateur à prise ou baldaquin avec transformateur intégré. ■ Materiale sintetico, acciaio. Gonfiabile. Lato superiore in argento, verde, blu o violetto. Con interruttore sensoriale e fili in nylon per la sospensione. Regolabile in altezza. A scelta con trasformatore a spina o rosone con trasformatore integrato.

💡 20/30 W LED, 2670/4000 lm, 3000 K, 25000 h, CRI >90, EEC A+
⚡ or 🌪️ 100–240 V/12 V 🌪️ 300 cm

Birdie Ingo Maurer 2002

Kronleuchter mit 12 Niedervolt-Leuchtmitteln und Flügeln aus Gänsefedern. Im Baldachin integrierter Transformator, verzinnte Metallteile. Kabel in Rot oder Transparent. Für Raumhöhen von 230 bis 260 cm. Abhängzubehör für größere Raumhöhen separat erhältlich. Lieferung mit Leuchtmitteln. ■ Chandelier with 12 low-voltage bulbs and goose-feather wings. Canopy with built-in transformer, tin-plated metal parts. Cables in red or transparent. For ceiling heights of 230 to 260 cm. Suspension kit for higher ceilings available on request. Supplied with full set of bulbs. ■ Lustre avec 12 ampoules à bas voltage et des ailes en plumes d'oie. Transformateur intégré dans le baldaquin, parties métalliques étamées. Câbles transparents ou rouges. Pour hauteurs de plafond de 230 à 260 cm. Accessoire de suspension disponible sur demande pour des pièces plus hautes. Livrée avec ampoules. ■ Lampadario con 12 lampadine a basso voltaggio e ali in piume d'oca. Trasformatore integrato nel rosone, parti in metallo stagnate. Cavi rossi o trasparenti. Per soffitti con altezza da cm. 230 a cm. 260. Kit sospensione per soffitti più alti disponibile su richiesta. Fornito con lampadine.

💡 12 x 10 W Halogen, 12 x 90 lm, 2000 h, CRI 100, EEC C ⚡ E27 🌪️ 230/125/24 V
💡 12 x 1,5 W LED, 12 x 100 lm, 15000 h, CRI 85, EEC A+ ⚡ E27 🌪️ 200–240/12 V AC



min. 50, max. 95

ca. 50

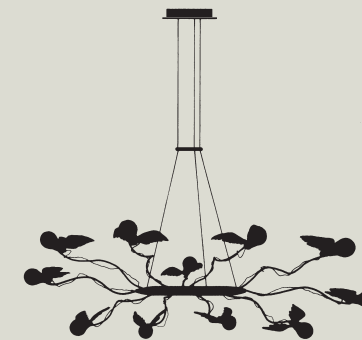

ca. 120

max. 180



ca. 120

min. 130, max. 350

Birdie's Nest Ingo Maurer 2005

Metall, Flügel aus Gänsefedern, zehn Niedervolt-Glühlampen, transparente Kabel. Birdie's Nest ist für Räume mit geringen Deckenhöhen konzipiert. Nicht geeignet für Räume mit hoher Luftfeuchtigkeit. ■ Metal, goose-feather wings, ten low-voltage bulbs, transparent cables. Birdie's Nest is designed for rooms with lower ceilings. Not suited for rooms with high humidity. ■ Métal, ailes en plumes d'oie, dix ampoules à bas voltage, câbles transparents. Birdie's Nest est conçu pour des pièces à plafond bas. N'est pas appropriée pour des pièces avec un fort taux humidité. ■ Metallo, ali in piume d'oca, dieci lampadine a basso voltaggio, cavi trasparenti. Birdie's Nest è concepita per soffitti bassi. Non adatta all'uso in ambienti ad alta umidità.

💡 10 x 10 W Halogen, 10 x 90 lm, 2000 h, CRI 100, EEC C ⚡ E27 🌪️ 230/125/24 V
💡 10 x 1,5 W LED, 10 x 100 lm, 2700 K, 15000 h, CRI 85, EEC A+ ⚡ E27 🌪️ 200–240/12 V AC

Birdie's Ring Ingo Maurer und Team 2013

Metall, 12 Niedervolt-Leuchtmittel, Flügel aus Gänsefedern. Drei LED Downlights im ringförmigen Leuchtenkörper. Höhenverstellbar, auch mit einer leichten Neigung montierbar. Dimmbar. Kabel transparent. Lieferung mit Leuchtmitteln. ■ Metal, 12 low-voltage bulbs and goose-feather wings. Three LED downlights integrated in the ring-shaped body. Height adjustable. Also to be suspended at a light angle. Dimmable. Transparent cables. Supplied with full set of bulbs. ■ Métal, 12 ampoules à bas voltage et des ailes en plumes d'oie. Trois LEDs downlight intégrés dans le corps de la lampe. La Birdie's Ring est ajustable en hauteur et peut aussi être montée légèrement inclinée. Dimmable. Câbles transparents. Livrée avec ampoules. ■ Metallo, 12 lampadine a basso voltaggio e ali in piume d'oca. Tre downlight a LED integrati nell'anello. Birdie's Ring è regolabile in altezza e può anche essere installata leggermente inclinata. Cavi trasparenti. Fornito con lampadine.

💡 12 x 10 W Halogen, 12 x 90 lm, 2000 h, CRI 100, EEC C ⚡ E27 🌪️ 230/125/24 V
💡 12 x 1,5 W LED, 12 x 100 lm, 2700 K, 15000 h, CRI 85, EEC A+ ⚡ E27
🌪️ 200–240/12 V AC 🌪️ LED dimmable 3 x 4,3 W, 3 x 430 lm, 3000 K, 40000h, CRI 80, EEC A

Birds Birds Birds Ingo Maurer 1992

Kronleuchter mit 24 Niedervolt-Glühlampen und Flügeln aus Gänsefedern. Im Baldachin (Ø 30 cm) integrierter Transformator, verzinnte Metallteile. Kabel in Transparent oder Rot/Blau. Sonderlängen auf Anfrage. Die einzelnen Glühlampen sind individuell beweglich. Lieferung mit Leuchtmitteln und sechs Ersatzglühlampen. ■ Chandelier with 24 low-voltage bulbs and goose-feather wings. Canopy (Ø 30 cm) with built-in transformer, tin-plated metal parts. Cables in transparent or red/blue. Alternative lengths available on request. Bulbs individually adjustable. Supplied with full set of bulbs, plus 6 spares. ■ Lustre avec 24 ampoules à bas voltage et des ailes en plumes d'oie. Transformateur intégré dans le baldaquin (Ø 30 cm), parties métalliques étamées. Câbles transparents ou rouges/bleus. Longueurs spéciales sur demande. Chaque ampoule est mobile individuellement. Livrée avec ampoules, plus 6 ampoules de rechange. ■ Lampadario con 24 lampadine a basso voltaggio e ali in piume d'oca. Trasformatore integrato nel rosone (Ø 30 cm), parti zincate in metallo. Cavi trasparenti o rossi/blu. Lunghezze speciali su richiesta. Le lampadine sono orientabili individualmente. Fornito con lampadine e 6 lampadine di ricambio.

💡 24 x 10 W Halogen, 2400 lm, 2000 h, EEC C ⚡ E27 🌪️ 230/125/24 V



Black Luzy/Blue Luzy Ingo Maurer 2018

Kunststoff, Metall, Niedervolt-Leuchtmittel. ■ Plastic, metal, low-voltage lamps, plastic. ■
Plastique, métal, lampes basse tension. ■ Plastica, metallo, lampade a bassa tensione.

💡 10 W Halogen, 90 lm, 2000 h, CRI 100, EEC C 🌀 E27 ⚡ 230/125/24 V

💡 1,5 W LED, 100 lm, 15000 h, CRI 85, EEC A++ 🌀 E27 ⚡ 200-240/12V AC

Brick Ingo Maurer und Team 2017

Eloxiertes Aluminium, pulverbeschichtetes Metall, Kunststoff. Brick Base kann einzeln oder in Kombination mit ein oder zwei Brick Plus, dem Zusatzelement, verwendet werden. Die Elemente sind einzeln um 360° drehbar und können sowohl als Uplight als auch als Downlight verwendet werden. Stufenlos dimmbar durch Sensorschalter mit Memofunktion. Leuchtenkörper in Schwarz, Blau oder Aluminium Natur. Lamellenblende in Leuchtröt, Leuchtgelb oder Silber. ■ Anodised aluminium, power-coated metal, plastic. Brick Base can be used single or in combination with up to two additional Brick Plus elements. The elements rotate through 360° and can serve both as up- or downlight. Touch dimmer with memo function. Elements in black, blue or aluminium. Diffusor in fluorescent red, yellow or silver. ■ Aluminium anodisé, métal avec revêtement par poudre, matière plastique. Brick Base peut être utilisée comme simple élément ou on peut ajouter jusqu'à deux éléments supplémentaires Brick Plus. Les éléments ont une rotation de 360° et peuvent être utilisés au choix comme up-light ou downlight. Touchdimmer avec fonction de mémoire. Eléments en noir, bleu ou aluminium. Diffuseur à lamelles fluorescent en rouge, jaune ou argenté. ■ Alluminio anodizzato, metallo verniciato a polvere, materiale sintetico. Brick Base può essere impiegata come elemento singolo oppure ampliata con Brick Plus fino a tre elementi in totale. I singoli elementi ruotano di 360° e possono essere usati come uplight o downlight. Regolazione continua dell'intensità luminosa mediante interruttore a sensore con funzione memoria. Elementi disponibili in nero, blu o alluminio naturale. Schermo a lamelle in rosso fluorescente, giallo fluorescente o argento.

🔘 LED dimmable, 17 W, 1500 lm, 2700 K, CRI 92 🌀 100-240 V/24V ⚡ 250 cm

Campari Light Raffaele Celentano 2002

Zehn originale Campari-Soda-Flaschen, einzeln abnehmbar, Kunststoff, Metall. Stufenlos höhenverstellbar durch Campari-Kronenkorken. Transparenter Baldachin, Ø 13 cm. Für Raumhöhen bis 300 cm, Sonderlänge für Raumhöhen bis 550 cm. ■ Ten original Campari Soda bottles, individually detachable. Plastic, metal. Height freely adjustable via Campari bottle cap. Transparent canopy, Ø 13 cm. For ceiling heights up to 300 cm. Special length for ceiling heights up to 550 cm. ■ Dix bouteilles originales de Campari Soda, détachables individuellement, matière plastique, métal. Réglable en hauteur sans graduation par une capsule Campari. Baldaquin transparent, Ø 13 cm. Pour hauteur de pièce jusqu'à 300 cm. Longueur spéciale pour hauteur de pièce jusqu'à 550 cm. ■ Dieci bottiglie di Campari Soda originali, staccabili singolarmente, materiale sintetico, metallo. Altezza regolabile in continuo mediante un tappo Campari. Rosone trasparente, Ø 13 cm. Per soffitti con altezze fino a 300 cm. Lunghezza speciale per soffitti fino a 550 cm.

💡 PAR 30 🌀 E27 (125 V: G9), max. 75 W, A++-E

Canned Light Christoph Matthias, Hagen Szezech 2003

Aluminium, Edelstahl, Kunststoff. Eine Konservendose, befüllt mit Leuchtmittel, Reflektor, Fassung, Kabel und Schalter wird zur Hänge- oder Wandlampe. Aufputz-Montage mit Abdeckscheibe weiß Ø 8 cm. Stufenlos höhenverstellbar durch Umlenkrolle und Justier-ring. ■ Aluminium, stainless steel, plastic. A tin can, containing lightbulb, reflector, socket, cable and switch, turns into a hanging or wall lamp. Surface-mounted ceiling fixture with white baseplate cover Ø 8 cm. Height freely adjustable with pulley and ring. ■ Aluminium, acier inoxydable, matière plastique. Une boîte de conserves, contenant ampoule, réflecteur, douille, câble, interrupteur se transforme en suspension ou applique. Montage sur crépi avec rondelle blanche de recouvrement Ø 8 cm. Réglable en hauteur sans graduation par poulie de renvoi et anneau coulissant. ■ Alluminio, acciaio inossidabile, materiale sintetico. Un barattolo da conserva, contenente lampadina, portalamпада, riflettore, cavo e interruttore, si trasforma in una lampada da sospensione o da parete. Scatola di derivazione esterna con piastra bianca di copertura Ø 8 cm. Regolazione continua dell'altezza con carrucola e anello di bloccaggio.

© 2003 and trademark by Campbell Soup Company used under license. All rights reserved.

💡 60W Halogen, 980 lm, 2800 K, 2000 h, EEC C 🌀 G9, max. 60 W, A++-E ⚡ 200 cm

New LED version: 🌀 GU 10, A+-E coming soon

Da + Dort Christoph Matthias, Ingo Maurer 2003/2012

Papier, Edelstahl, Kunststoff. An drei Seilen aufgehängt. Innerhalb der Aufhängepunkte stufenlos höhenverstellbar und in alle Richtungen zu verschieben. Aufhängepunkte nach Wahl. Leuchtenkopf um 360° dreh- und 45° schwenkbar. Leuchtenkopf Ø 28 cm, Deckenbaldachin Ø 8 cm. ■ Paper, stainless steel, plastic. Suspended on three wires. Freely adjustable in height and width within the lamp's suspension points. Free choice of suspension points. Head of lamp rotates through 360° and tilts through 45°. Head of lamp Ø 28 cm, canopy Ø 8 cm. ■ Papier, acier affiné, matière plastique. Suspendue à trois fils. Hauteur réglable sans graduation entre les points de fixation. Se déplace dans toutes les directions. Points de fixation au choix. Tête de la lampe rotative à 360° et orientable à 45°. Tête de la lampe Ø 28 cm, baldaquin Ø 8 cm. ■ Carta, acciaio inossidabile, materiale sintetico. Sospesa a tre cavi. Regolazione continua dell'altezza entro i punti di fissaggio. Orientabile in tutte le direzioni. Punti di fissaggio a scelta. Il riflettore ruota di 360°, e si inclina di 45°. Riflettore Ø 28 cm, rosone Ø 8 cm.

💡 LED or Halogen 🌀 E 27, max. 150 W, A++-E ⚡ 300 cm

Eddie's Son Ingo Maurer und Eckhard Knuth 2005

Kunststoff, Metall, Hologramm 360°. Transformator im Baldachin integriert. Lieferung mit Leuchtmittel. ■ Plastic, metal, hologram 360°. Transformer integrated in canopy. Complete with bulb. ■ Matière plastique, métal, hologramme 360°. Transformateur intégré dans le baldaquin. Livrée avec ampoule. ■ Materiale sintetico, metallo, ologramma 360°. Trasformatore integrato nel rosone. Lampadina inclusa.

Direkte Sonneneinstrahlung und Nikotin können die Lebensdauer der Hologramme reduzieren. ■ Direct sunlight and nicotine may reduce the life span of the holograms. ■ Une exposition directe au soleil et à la nicotine peut réduire la durée de vie des hologrammes. ■ L'esposizione diretta al sole e alla nicotina possono ridurre la durata degli ologrammi.

💡 Halogen 🌀 GY 6,35, max. 50 W ⚡ 230/125/12 V ⚡ 300 cm
No EEC – for details see our website www.ingo-maurer.com

Brick Base

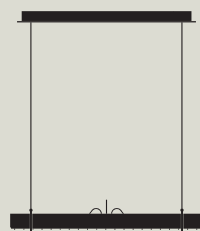

47

Brick Plus



47



max. 150/400

23



max. 200

8,5

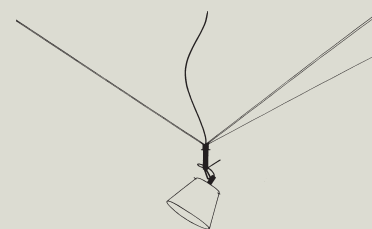

max. 400

ca. 50

min. 80, max. 240

25

16

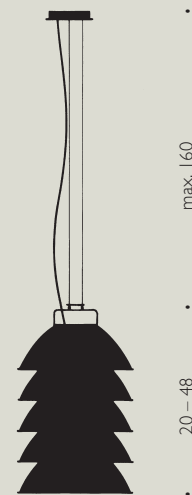

max. 160

20-48

29

Five Pack Axel Schmid 2007

Stahl. Fünf Reflektoren außen matt weiß, innen gelb bzw. weiß lackiert. Lichteffect durch Verstellen des Abstands der Reflektoren variabel. Für Raumhöhen bis 300 cm. Sonderlängen auf Anfrage. ■ Steel. Five reflectors exterior mat white, interior yellow respectively white lacquer. Light effect variable by adjusting the spacing between the reflectors. For ceiling heights up to 300 cm. Alternative lengths available on request. ■ Acier. Cinq réflecteurs: extérieur vernis blanc mat, intérieur vernis jaune et blanc. Effet lumineux variable pour régler la distance entre les réflecteurs. Pour hauteurs de pièce jusqu'à 300 cm. Longueurs spéciales sur demande. ■ Acciaio. Cinque riflettori superficie esterna verniciata bianca opaca, superficie interna verniciata giallo e bianco. Regolando i riflettori varia l'atmosfera luminosa. Per soffitti con altezze fino a 300 cm. Lunghesse speciali su richiesta.

💡 2 x LED or Halogen 🌀 E14 (125 V: G9), max. 60 W, A++-E 📏 170 cm

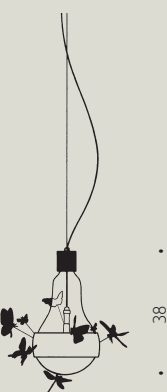

38

20

Flutterby Ingo Maurer 2016 Limited Production

Zehn handgefertigte Insektenmodelle, Glaskolben. Der Kunststoffring wird einzeln im 3D-Druckverfahren hergestellt. Die Editionsnummer ist eingepreßt. Auflage 200 Stück. ■ Ten hand-made butterfly models, large glass bulb. The shade ring is made with 3D printing technology, the serial number is imprinted in the shade. Edition of 200 pieces. ■ Dix modèles d'insectes faits main, globe en verre. L'anneau de recouvrement est confectionné grâce à une technologie en 3D d'agglomération par frittage. Le numéro de série est gravé dans l'anneau. Édition limitée à 200 pièces. ■ Dieci modellini di insetti realizzati a mano, bulbo di vetro. L'anello è realizzato singolarmente con stampa 3D. Il numero di serie è riportato nell'anello bianco. Edizione limitata di 200 esemplari.

💡 max. 75 W Halogen, 1180 lm, 2800 K, EEC C

🌀 B15 d/G9 + adapter, A++-E 📏 250 cm

Floatation Ingo Maurer 1980

Drei Schirme aus japanischem Papier, aufgehängt an dünnen Metallseilen, roter Eisenring für Höhenverstellung (Gegengewicht), Baldachin weiß lackiertes Metall Ø 22 cm. Die Schirme können einzeln ausgewechselt werden. ■ Three Japanese paper shades, suspended on thin metal cables. Height adjustable with red enamelled iron ring, which serves as a counterweight. Metal canopy, white finish Ø 22 cm. Shades separately replaceable. ■ Trois éléments abat-jour en papier japonais suspendus par des câbles fins en métal, anneau rouge en fer pour régler la hauteur (contrepois), baldaquin en métal laqué blanc Ø 22 cm. Les abat-jour peuvent être remplacés séparément. ■ Tre paralumi in carta giapponese, sostenuti da sottili fili metallici, anello rosso in ferro per la regolazione dell'altezza (contrappeso), rosone in metallo verniciato bianco Ø cm. 22. I paralumi possono essere sostituiti singolarmente.

💡 4 x LED or Halogen, 1 x PAR 30 🌀 E27, 1 x max. 100 W, 2 x max. 60 W, 2 x max. 40 W

📏 200/450 cm white

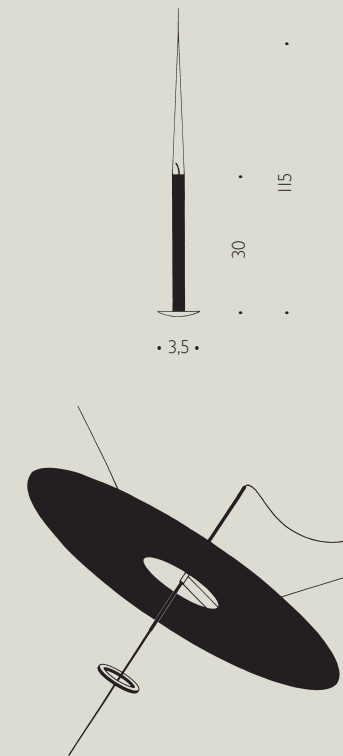

115

30

3,5

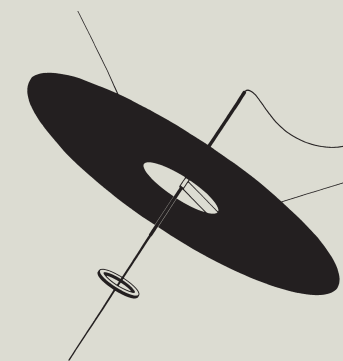

190

43

12

3

Fly Candle Fly! Georg Baldele und Team 1996

Wachskerze mit Aufhängeseil, 3 m Verlängerung und Tropfenfänger. Länge 30 cm. Brenndauer ca. 20 Stunden. ■ Wax candle with suspension wire, 3 m extension and dripcatcher. Length 30 cm. Burns for approx. 20 hours. ■ Bougie de cire avec câble de suspension, 3 m de rallonge et attrape-gouttes. Longueur 30 cm. Durée de combustion env. 20 heures. ■ Candela in cera con filo di sospensione, filo di prolungamento di m. 3 e raccoglitore di gocce. Lunghezza cm. 30. Durata ca. 20 ore.

💡 No electricity!

Flying Disc Ingo Maurer und Team 2016

Glasfaser, Kohlefaser, Metall, Kunststoff. Aufhängung an drei Metallseilen, LED-Ring einstellbar. ■ Glas fibre, carbon fibre, metal, plastic. Suspended from three wires. Ring with LEDs adjustable. ■ Fibre de verre, fibre de carbone, métal, matière plastique. Suspendue à trois cables. Anneau avec LED inclinable. ■ Fibra di vetro, fibra di carbonio, metallo, material sintetico. Sospesa a tre cavi fini. Anello di LED inclinabile.

📏 LED dimmable 25 W, 3600 lm, 3000 K, CRI 95, EEC A+ 📏 100-125 V/220-240 V/36 V

Flying Flames Moritz Waldemeyer, Ingo Maurer und Team, 2013

Konfigurierbares System bestehend aus Flame-Elementen, Downlights und Baldachin aus weiß lackiertem Stahl. Die Flammen und Downlights werden mit Magneten am Baldachin fixiert. Baldachin mit integriertem Vorschaltgerät in zwei Größen, 60 x 60 cm und 114 x 40 cm. Steckverbindungen für maximal zehn Flame-Elemente und zwei Downlights. Flame-Element erhältlich in Schwarz, Rot oder Weiß, mit zwei LED-Displays, Dimmschalter auf der Platine. Downlight-Element in Schwarz oder verchromt, mit integriertem Touchdimmer mit Memory-Funktion. Material: Platine, Metall, Aluminium eloxiert, Kunststoff. ■ Configurable system, consisting of Flame Elements, Downlights and canopy in white lacquered steel. Flames and Downlights are placed freely with a magnet. Canopy with integrated electronic ballast, in two sizes, 60 x 60 cm and 114 x 40 cm. Jacks for up to ten Flame Elements and two Downlights. Flame Element available in black, red or white, two LED displays, dimmer switch on the circuit board. Downlight Element in black or chrome finish, with touch dimmer with memory function. Material: Circuit board, metal, anodised aluminium, plastic. ■ Système configurable, comprenant des éléments Flame, downlights et baldaquin en acier blanc laqué. Flammes et downlights sont fixés avec un aimant au baldaquin. Baldaquin avec ballast électronique intégré, en deux tailles 60 x 60 cm et 114 x 40 cm. Fiche de raccordement pour maximum dix éléments Flame et deux downlights. Éléments Flame disponibles en noir, rouge ou blanc, avec deux écrans LED, variateur sur la platine. Éléments downlight en noir ou chromé, avec touchdimmer à fonction mémoire. Matériel: platine, métal, aluminium anodisé, matière plastique. ■ Sistema configurabile composto da Elementi Flame, Downlight e rosone in acciaio verniciato bianco. Gli Elementi Flame sono fissati al rosone mediante calamite. Rosone con alimentatore integrato disponibile in due misure, 60 x 60 cm e 114 x 40 cm, con contatti per fino a dieci Elementi Flame e due Downlight. Elemento Flame disponibile in nero, rosso o bianco con due display a LED, interruttore dimmer sul circuito stampato. Elemento Downlight in nero o cromato, con dimmer sensoriale con funzione memory. Materiale: Circuito stampato, metallo, alluminio anodizzato, materiale sintetico.

Flame element: 📏 LED dimmable, 0,6 W, 2700 K, CRI 80

📏 100-240 V/5 V, EEC A+ 📏 200 cm

Downlight: 📏 LED dimmable, 7,5 W, 2700 K, 670 lm, CRI 97

📏 100-240 V/38 V, EEC A+ 📏 250 cm

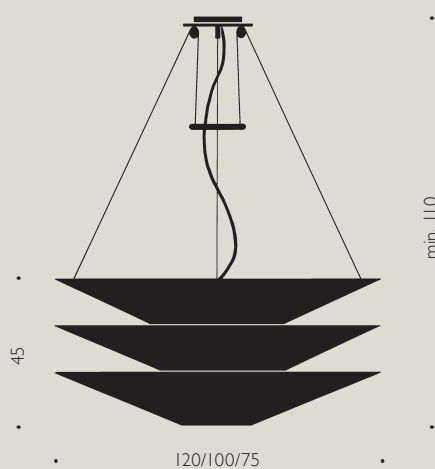

min. 110

45

120/100/75

Available in three sizes.

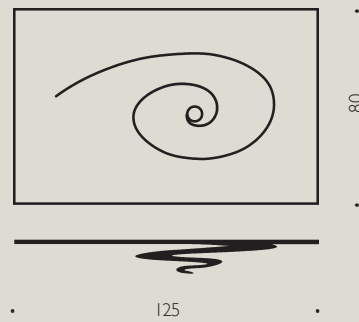

Galactic Ingo Maurer und Team 2018

Glasfaser, Kohlefaser. Matt weiß lackiert. ■ Glass fibre, carbon fibre. Matt white lacquered. ■ Fibre de verre, fibre de carbone. Laqué blanc mat. ■ Fibra di vetro, fibra di carbonio. Laccato bianco opaco.

LED dimmable, 2700 K, in development

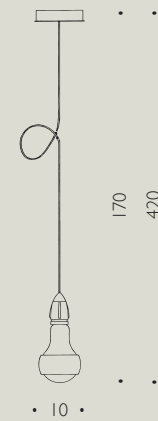

Johnny B. Good Ingo Maurer, Bernhard Dessecker 2002

Glühbirne in Sonderform (LED oder Halogen), Blendenring aus hitzebeständigem PTFE-Kunststoff, Glasfassung, transparentes Kabel. Höhenverstellbar. Weißer Blendenring. Baldachin Ø 14 cm. Für Raumhöhen bis 550 cm. ■ Special bulb (available in LED or halogene), heat-resistant PTFE shade, socket in glass, transparent cable. Height adjustable. Canopy Ø 14 cm. For ceiling heights up to 550 cm. ■ Ampoule spéciale (LED ou halogène), abat-jour PTFE résistant à la chaleur, douille en verre, câble transparent. Baldaquin Ø 14 cm. Pour des hauteurs de plafond jusqu'à 550 cm. ■ Lampadina speciale (LED o alogena), schermo in PTFE termoresistente, portalampana in vetro, cavo trasparente. Rosone Ø 14 cm. Per soffitti con altezza fino a 550 cm.

LED or Halogen dimmable E27 max. 105 W 420 cm

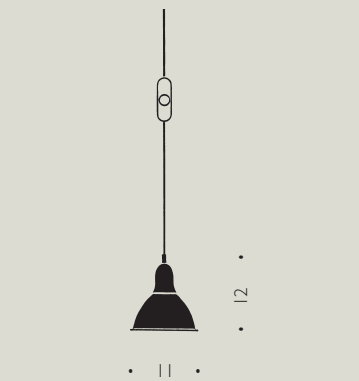

Grasl Jan Roth 1973

Reflektor aus glanzeloxiertem Aluminium und Messing. Kabel mit Schalter und Stecker. Auch als Tischlampe. ■ Reflector: anodized aluminium, brass. Cable with switch and plug. Also available as table lamp. ■ Réflecteur en aluminium électrolysé et laiton. Câble avec interrupteur et prise de courant. Egalement disponible comme lampe de table. ■ Riflettore in alluminio anodizzato e ottone. Cavo con interruttore e spina. Disponibile anche nella versione da tavolo.

LED or Halogen E14, max. 40 W 400 cm transparent

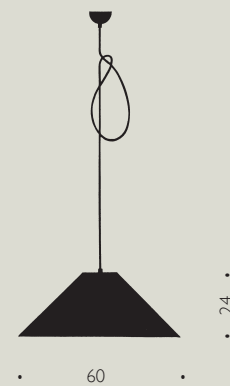

Knitterling Ingo Maurer 1978

Japanisches Papier, schwarzer Kunststoffbaldachin Ø 8 cm. Auch mit Papierabdeckung unten (wie Maru) erhältlich. ■ Japanese paper, black plastic canopy Ø 8 cm. Also available with paper cover from below, as in Maru. ■ Papier japonais, baldaquin en plastique noir Ø 8 cm. Aussi disponible avec un cache en papier en dessous, come Maru. ■ Carta giapponese, rosone in materiale sintetico nero Ø cm. 8. Anche disponibile con diffusore in carta nella parte inferiore, come Maru.

LED or Halogen E27, max. 100 W, A++-E 200/450 cm black

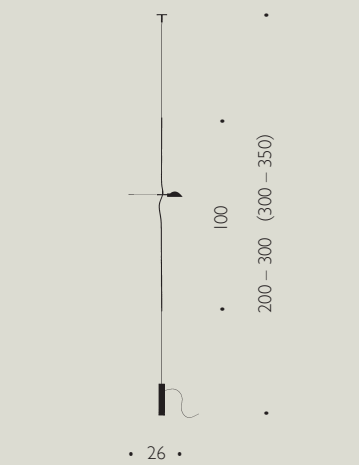

Hot Achille Ingo Maurer und Team 1994

Edelstahl, Aluminiumreflektor mit Schutzglas, Koaxialkabel. Für Raumhöhen bis 300 cm oder 350 cm. ■ Stainless steel, aluminium reflector with protective glass cover, coaxial cable. ■ Acier inoxydable, réflecteur en aluminium avec verre protecteur, câble coaxial. Adapté jusqu'à une hauteur de pièce de 300 cm ou 350 cm. ■ Acciaio inossidabile, riflettore in alluminio con vetro di protezione, cavo coassiale. Per soffitti con altezza fino a cm. 300 o 350.

35 W Halogen, 860 lm, 2900 K, 4000 h, EEC B GY 6,35, max. 50 W, B-E 230/125/12 V EU: Please check availability on our website.

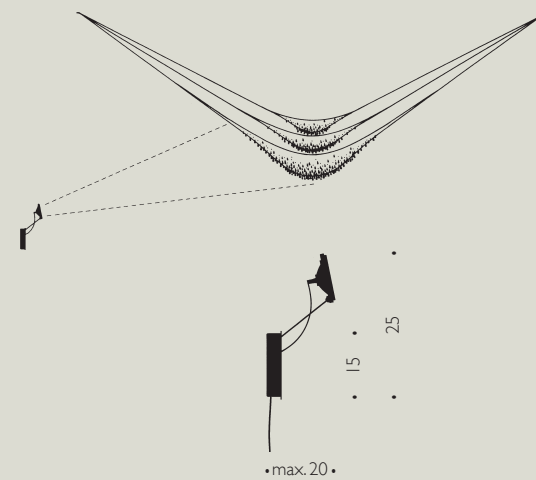

Lacrime del Pescatore Ingo Maurer 2009

Drei Nylonnetze in verschiedenen Größen, ca. 350 Kristalle. Das Leuchtmittel Ø 11 cm und der Transformator werden separat an der Wand befestigt. Nicht dimmbar. ■ Layered nylon nets in three different sizes with approximately 350 crystals. The light source Ø 11 cm and the transformer are fixed separately to the wall. Not dimmable. ■ 3 filets en nylon de tailles différentes, environ 350 cristaux. Le spot Ø 11 cm e le transformateur à accrocher séparément au mur. Non dimmable. ■ 3 reti in nylon di misure differenti, 350 cristalli ca. La lampadina Ø cm. 11 e il trasformatore vengono fissata al muro separatamente. Non dimmerabile.

100 W 8° Halogen, 3000 h, EEC B G53, max. 100 W, A++-E 230/125/12 V EU: The halogen version is a phase-out model, please check our website for up-to-date info and technical details of the new LED version.

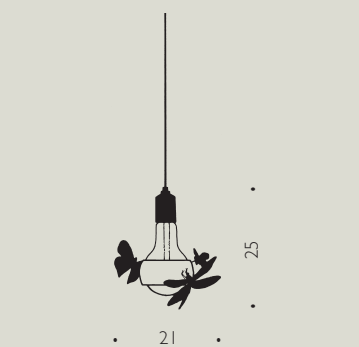

Johnny B. Butterfly Ingo Maurer 2011

Drei handgefertigte Insektenmodelle, Glühbirne in Sonderform (LED oder Halogen), Blendenring aus hitzebeständigem PTFE-Kunststoff, weiße Metallfassung, graues Textilkabel. ■ Three hand-made insect models, special bulb (available in LED or halogene), heat-resistant PTFE shade, socket in white metal, grey textile cable. ■ Trois modèles d'insectes faits main, ampoule spéciale (LED ou halogène), abat-jour PTFE résistant à la chaleur, douille en metal, vernie en blanc, cable de textile gris. ■ Tre modellini di insetti realizzati a mano, lampadina special (LED o alogena), schermo in PTFE termoresistente, portalampana in metallo, verniciato bianco, cavo tessile grigio.

LED or Halogen dimmable E27 max. 105 W 170/420 cm

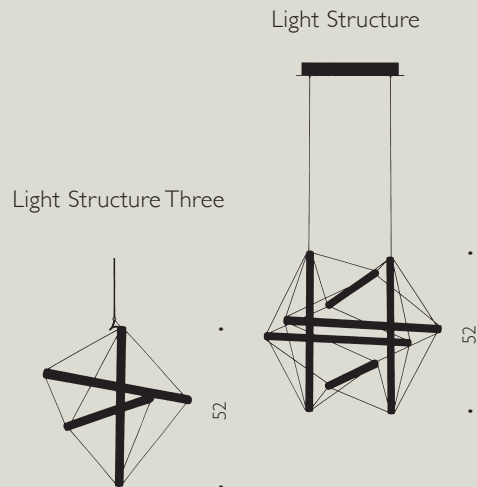

Light Structure / Light Structure Three

Peter Hamburger, Ingo Maurer 1970/2013

Plexiglas, Acryl, Aluminium. Sechs oder drei Röhren, von Kabeln in Spannung gehalten. Tischversion: Schnurtrafo mit Drehdimmer. Hängeversion: mit integriertem Transformator, dimmbar. Die LED-Röhren, Ø 2,5 cm, können nicht als Ersatzteil für die frühere Version der Light Structure (1970) verwendet werden. ■ Plexiglass, acrylic, aluminium. Six or three tubes, connected and held in tension by insulated wires. Table version: with continuously rotating transformer-dimmer. Hanging version: with integrated transformer, dimmable. The LED tubes, Ø 2.5 cm, can not be used as spare part for the former version of Light Structure (1970). ■ Plexiglas, acrylique, aluminium. Six ou trois tubes, connectés et tenues en tension aux câbles. Version pour table: avec transformateur à cordon avec variateur à rotation. Version pour suspension: avec transformateur intégré, dimmable. Les tubes LED, Ø 2,5 cm, ne peuvent pas être usés comme pièce de rechange pour la version originale de Light Structure (1970). ■ Plexiglas, acrilico, alluminio. Sei o tre tubi collegati e tenuti in tensione da cavi isolati. Versione da tavolo: con trasformatore su cavo con dimmer a manopola rotante. Versione a sospensione: con trasformatore integrato, dimmerabile. I tubi LED, Ø 2,5 cm, non possono essere usati come pezzo di ricambio per la versione originale di Light Structure (1970).

- 12 or 6 LEDs dimmable, each 3,4 W, 1320 or 660 lm, 2700 K, CRI 80, EEC A
- 110–240 V/40 V ⚡ 250 cm

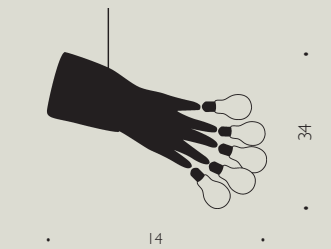

Luzy From The Sky Ingo Maurer 2018

Kunststoff, Metall, Niedervolt-Leuchtmittel. ■ Plastic, metal, low-voltage lamps, plastic. ■ Plastique, métal, lampes basse tension. ■ Plastica, metallo, lampade a bassa tensione.

- 25 x 1,5 W LED, 25 x 100 lm, 15000 h, CRI 85, EEC A++ E27 200–240 V
- 25 x 10 W Halogen, 25 x 90 lm, 2000 h, CRI 100, EEC C E27 230/125/24 V

Luzy Take Five Ingo Maurer 2018

Kunststoff, Metall, Niedervolt-Leuchtmittel. ■ Plastic, metal, low-voltage lamps, plastic. ■ Plastique, métal, lampes basse tension. ■ Plastica, metallo, lampade a bassa tensione.

- 5 x 1,5 W LED, 5 x 100 lm, 15000 h, CRI 85, EEC A++ E27 200–240 V
- 5 x 10 W Halogen, 5 x 90 lm, 2000 h, CRI 100, EEC C E27 230/125/24 V

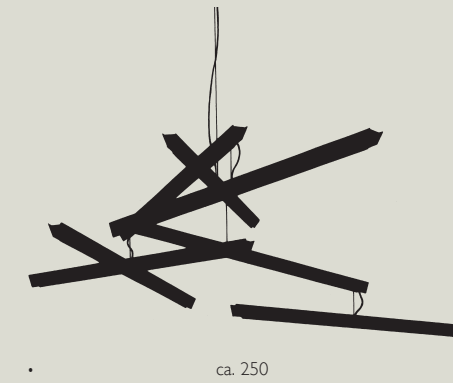

ManOMan Ingo Maurer und Team 2011

Aluminium, weiß lackierter Stahl, Kunststoff. Bewegliches Uplight zur indirekten Beleuchtung. ■ Aluminium, white lacquered steel, plastic. Mobile and uplighter for indirect lighting. ■ Aluminium, acier lacqué blanc, matière plastique. Mobile et Uplight pour l'éclairage indirecte. ■ Alluminio, acciaio verniciata bianco, materiale sintetico. Mobile e Uplight per l'illuminazione indiretta.

- 14 x Halogen 48 W, 740 lm, 2800 K, 2000 h, EEC D G9, max. 48 W, A++–E
- EU: The halogen version is a phase-out model, please check our website for up-to-date info and technical details of the new LED version.

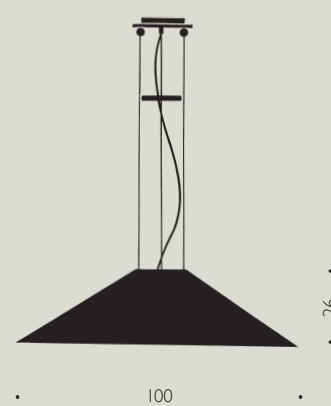

Maru Ingo Maurer 1980

Schirm aus japanischem Papier, aufgehängt an drei dünnen Metallseilen, roter Eisenring für Höhenverstellung (Gegengewicht). Baldachin weiß lackiertes Metall Ø 22 cm. Als gewolltes gestalterisches Element ist das Papier von Maru verknittert. ■ Japanese paper shade, suspended on three thin metal cables. Height adjustable with red iron ring, which serves as a counterweight. Metal canopy, white finish Ø 22 cm. The paper of Maru is crinkled. This is an intended design attribute. ■ Abat-jour en papier japonais, suspendu par trois câbles fins en métal, anneau en fer rouge pour régler la hauteur (contrepois). Baldaquin en métal laqué blanc Ø 22 cm. Le papier pour Maru est froissé, ainsi voulu comme effet de style. ■ Paralume in carta giapponese, sostenuto da tre sottili fili metallici, anello rosso in ferro per la regolazione dell'altezza (contrappeso). Rosone in metallo verniciato bianco Ø cm. 22. Una caratteristica voluta del design di Maru è l'effetto sguallato della carta.

- LED or Halogen E27, max. 150 W, A++–E ⚡ 200/450 cm white

Loop Michel Sempels 2015

Edelstahl, Messing, Aluminium, Kunststoff. Der LED-Spot ist um 360° drehbar. ■ Stainless steel, brass, aluminium, plastic. The LED spot swivels through 360° on an horizontal axis. ■ Acier spécial, aluminium, laiton, matière plastique. Le Spot LED est rotatif à 360°. ■ Ottone, acciaio inossidabile, alluminio, materiale sintetico. Rotazione orizzontale 360°.

- 4 W LED, 350 lm, 2700 K, CRI 90, EEC A+ 100–240 V/5 V

Luce Volante Ingo Maurer und Team 2012/2018

Glasfaser, Aluminium. Aufhängung an drei Punkten. Rot, Weiß oder Silber. ■ Glass fibre, aluminium. Suspended on three wires. Red, white or silver. ■ Fibre de verre, aluminium. Suspendu à trois points. Rouge, blanc ou argent. ■ Vetroresina, alluminio. Sospeso in tre punti. Rosso, bianco o argento.

- 23 W LED dimmable, 2700 K, CRI 97, Downlight 3 x 5,7 W, 2025 lm, Uplight 7,5 W, 675 lm, 25000 h, EEC A+ 90–135/180–295 V ⚡ 400 cm

Luminophor Till Armbrüster 2014

Aluminium, Kunststoff. Das blaue Licht des LED-Moduls wird durch die beschichtete Scheibe in weißes Licht umgewandelt. ■ Aluminium, plastic. The round, coated slice converts the blue light emitted by the LED into white light. ■ Aluminium, plastique. Le disque enduit convertit la lumière bleue émise par le module LED en une lumière blanche. ■ Alluminio, materiale sintetico. La naturale luce blu emessa dal modulo LED, attraverso un disco stratificato viene trasformata in luce bianca.

- 14 W LED dimmable, 1300 lm, Downlight 3000 K, CRI 90, Uplight 4500 K, CRI 90
- 100–125 V/220–240 V/40 V ⚡ 200 cm

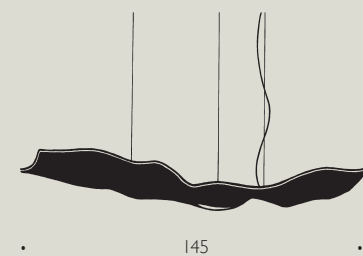
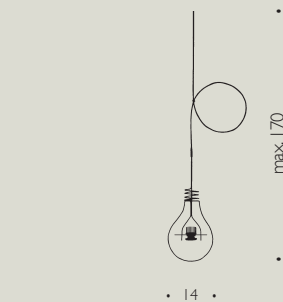

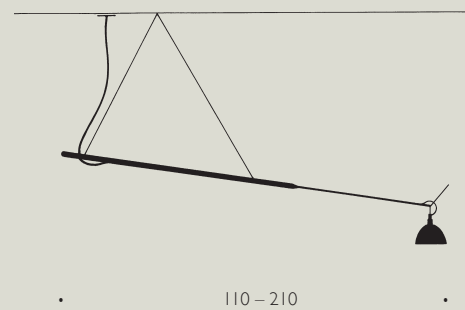

Max. Mover LED Ingo Maurer und Team 2000

Aluminium, Fiberglas. Das Teleskop ist von 110 auf 210 cm ausziehbar. Durch die Aufhängung an Nylonseilen ist Max. Mover in der Höhe zu verstellen und um 180° drehbar. An seinem Griff kann der Reflektor in zwei Richtungen stufenlos eingerichtet werden. Schalter am Ende des Stabs. ■ Aluminium, fibreglass. The telescopic arm extends from 110 to 210 cm, the nylon suspension wires allow for height adjustment and the lamp can be rotated through 180°. The reflector is freely adjustable in two directions, using the handle. Integrated switch at the end of the rod. ■ Aluminium, fibre de verre. Le télescope est extensible de 110 à 210 cm. Suspendu à des fils de nylon, Max. Mover est réglable en hauteur et rotatif à 180°. Grâce à sa poignée, le réflecteur peut être réglé sans graduation dans deux directions. Interrupteur situé à l'extrémité de la tige. ■ Alluminio, vetroresina. Il braccio telescopico è allungabile da cm. 110 a cm. 210. Essendo sospesa a fili di nylon, Max. Mover è regolabile in altezza e ruota di 180°. Agendo sulla leva, il riflettore può essere regolato in continuo in due direzioni. Interruttore all'estremità dell'asta.

15 W LED, 1300 lm, 3000 K, CRI 90, EEC A+ ⚡ 220-240 V / 110-125 V 🌀 450 cm



Max. Pender Ingo Maurer 2003/2016

Aluminium, Metall, Kunststoff, Silikon. Stufenlos höhenverstellbar. Reflektor in Weiß oder Aluminium Hochglanz. ■ Aluminium, metal, plastic, silicone. Height adjustable. Reflector in white, or highly polished aluminium. ■ Aluminium, métal, matière plastique, silicone. Réglable en hauteur. Réflecteur en blanc ou aluminium poli. ■ Alluminio, metallo, materiale sintetico, silicone. Regolazione continua dell'altezza. Riflettore in bianco o alluminio lucido.

15 W LED dimmable, 1300 lm, 3000 K, CRI 90 EEC A+ ⚡ 220-240 V / 110-125 V

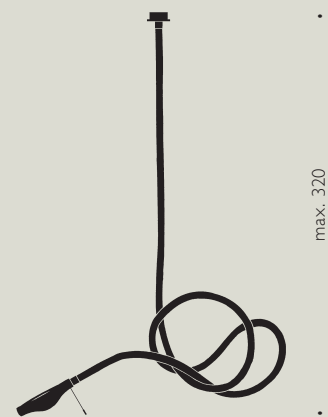

Metall C. Cooper Ingo Maurer und Team 2009

Metall, Kunststoff. Der flexible Arm ermöglicht die variable Einstellung des Reflektors. Reflektor 360° um das Leuchtmittel drehbar. Eine Kunststoffschnur sichert die Position des Reflektors. Baldachin Ø 8,5 cm. ■ Metal, plastic. The flexible arm allows variable adjustment of the reflector. Reflector rotates through 360° around the bulb. A fine plastic string secures the position of the extended armature. Canopy Ø 8,5 cm. ■ Métal, matière plastique. Le bras flexible permet le réglage variable du réflecteur. Réflecteur rotatif de 360° autour de l'ampoule. Un fil en matière plastique fixe la position du réflecteur. Baldaquin Ø 8,5 cm. ■ Metallo, materiale sintetico. Il braccio flessibile permette la regolazione variabile del riflettore. Riflettore rotante di 360° intorno alla lampadina. Un filo in materiale sintetico assicura la posizione del riflettore. Rosone Ø cm. 8,5.

60 W Halogen, 980 lm, 2800 K, 2000 h, EEC D 🌀 G9, max. 60 W
EU: Please check availability on our website.



Öff Öff Ingo Maurer und Team 1996

Porzellan glasiert, Metall. Stufenlos höhenverstellbar. Die Lampe kann in 6 Stufen in ihrer Neigung verstellt werden. Baldachin in Porzellan, Ø 8 cm. Für Raumhöhen bis 300 oder 550 cm. ■ Glazed porcelain, metal. Height freely adjustable. Tilttable in 6 stages. Porcelain canopy Ø 8 cm. For ceiling heights up to 300 or 550 cm. ■ Porcelaine glacée, métal. Réglage en hauteur sans graduation. Inclinaison en 6 graduations. Baldaquin Ø 8 cm en porcelaine. Pour hauteurs de plafond jusqu'à 300 ou 550 cm. ■ Porcellana vetrificata, metallo. Regolazione continua dell'altezza. L'inclinazione della lampada è regolabile in sei posizioni prefissate. Rosone Ø cm. 8 in porcellana. Per altezze di soffitto fino a cm. 300 o 550.

LED or Halogen 🌀 GU 10, max. 50 W, A+-E 🌀 170 / 420 cm

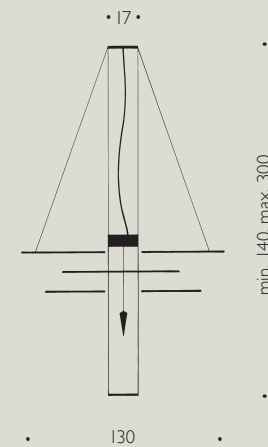

Oh Mei Ma Ingo Maurer 1993

Sechs Blätter aus blattvergoldetem Papier. Senklot aus Plexiglas. Sonderlängen auf Anfrage. ■ Six sheets of gold-plated paper. Plumb made of plexiglass. Alternative lengths available on request. ■ Six feuilles en papier doré à la feuille. Fil à plomb en plexiglas. Longueurs spéciales sur demande. ■ Sei fogli di carta dorata. Pendolo in plexiglas. Lunghezze speciali su richiesta.

Oh Mei Ma Weiss Ingo Maurer und Team 1997/2007

Metall, Glas. Sechs Blätter aus Aluminium, matt weiß lackiert. Sonderlängen auf Anfrage. ■ Metal, glass. Six sheets of aluminium, mat white finish. Alternative lengths available on request. ■ Métal, verre. Six feuilles en tôle d'aluminium, vernis en blanc mat. Longueurs spéciales sur demande. ■ Metallo, vetro. Sei fogli in lamiera d'alluminio, verniciatura bianca opaca. Lunghezze speciali su richiesta.

39 W LED, 3000 lm, 2700 K, CRI 92, 1 W LED blue, EEC A+

100-240/37 V 🌀 300/550 cm

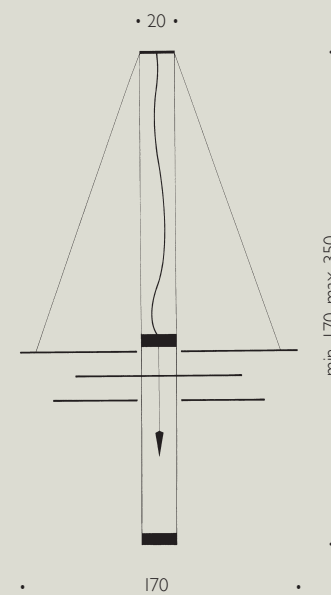

Oh Mei Ma Kabir Ingo Maurer und Team 1997/2007

Sechs Blätter aus blattvergoldetem Papier. Senklot aus Plexiglas. Auch mit versilbertem Papier und Senklot aus Metall lieferbar. Sonderlängen auf Anfrage. ■ Six sheets of gold-plated paper. Plumb made of plexiglass. Silver-coated version also available, with plumb in steel. Alternative lengths available on request. ■ Six feuilles en papier doré à la feuille. Fil à plomb en plexiglas. Egalement disponible en papier argenté avec fil à plomb en acier. Longueurs spéciales sur demande. ■ Sei fogli di carta dorata. Pendolo in plexiglas. È disponibile anche la versione in carta argentata con pendolo in acciaio. Lunghezze speciali su richiesta.

Oh Mei Ma Kabir Weiss Ingo Maurer und Team 1997/2007

Metall, Glas. Sechs Blätter aus Aluminium, matt weiß lackiert. Sonderlängen auf Anfrage. ■ Metal, glass. Six sheets of aluminium, mat white finish. Alternative lengths available on request. ■ Métal, verre. Six feuilles en tôle d'aluminium, vernis en couleur blanc mat. Longueurs spéciales sur demande. ■ Metallo, vetro. Sei fogli in lamiera d'alluminio, verniciatura bianca opaca. Lunghezze speciali su richiesta.

2 x 39 W LED, 3000 lm, 2700 K, CRI >92, 1 x 1 W LED blue, EEC A+ 🌀 100-240/37 V

🌀 350/700 cm



One New Flame Moritz Waldmeyer, Ingo Maurer und Team 2013

Platine in Schwarz, Rot oder Weiß, Metall, Kunststoff. Am oberen Ende einer schmalen Platine scheint eine Kerzenflamme zu flackern. Die Platine ist mit zwei feinen Kabeln aufgehängt. Das elektronische Netzteil ist in den schlichten, weiß lackierten Baldachin integriert. ■ Circuit board in black, red, or white, metal, plastic. At the upper end of a sleek circuit board, suspended on fine wires, a candle flame seems to flicker. The electronic ballast is integrated in the simple white canopy. ■ Platine en noir, rouge ou blanc, métal, matière plastique. Une flamme de bougie semble s'embraser au bout d'une fine platine. La platine est suspendue par deux câbles fins. Le bloc d'alimentation électronique est intégré dans le simple baldachin blanc lacqué. ■ Circuito stampato in nero, rosso o bianco, metallo, materiale sintetico. All'estremità superiore del sottile circuito stampato sembra muoversi la fiamma di una candela. Il circuito stampato è sospeso a due cavetti. L'alimentatore elettronico è integrato nel semplice rosone verniciato bianco.

2 x 128 LED dimmable, 5 V, 0,6 W, 2700 K, CRI 80 🌀 100-240/5 V

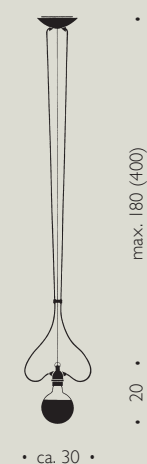
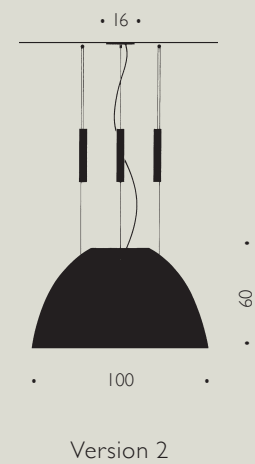
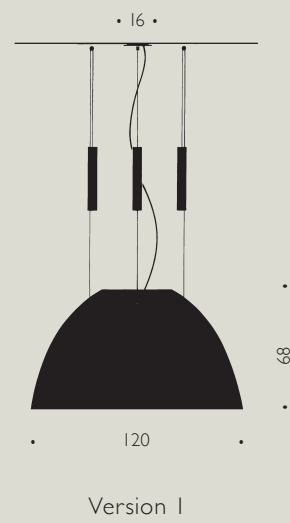

Savoie Donato Savoie, Ingo Maurer 1979

Baldachin und Fassung aus weißem Porzellan. Silikon-Kabel. Für halb mattiertes Globe-Leuchtmittel Ø 12,5 cm. Höhenverstellbar bis maximal 180 cm. ■ Canopy and socket in white porcelain. Silicone cable. For semi-frosted Globe bulb Ø 12,5 cm. Height adjustable (max. 180 cm). ■ Baldaquin et douille en porcelaine blanche. Câble en silicone. Pour ampoule Globe demi-dépolie Ø 12,5 cm. Hauteur réglable jusqu'à une longueur de 180 cm au maximum. ■ Rosone e portalampana in porcellana bianca. Cavo in silicone. Per lampadina globe semi-opalizzata Ø 12,5 cm. Regolabile in altezza fino a una lunghezza massima di cm. 180.

LED or Halogen E27, max. 60 W, A++-E 180/400 cm

Pierre ou Paul Ingo Maurer und Team 1996

Aluminium, Edelstahl. Innenfläche in Gold, Platin oder farbig matt lackiert. Höhenverstellbar durch drei Gegengewichte. Sonderlängen auf Anfrage. Baldachin mit Abdeckscheibe Ø 16 cm. Version 1: ca. 32 kg. Version 2: ca. 22 kg. ■ Aluminium, stainless steel. Inner surface gold, platinum or mat colour finish. Height adjustable by means of three counterweights. Alternative lengths available on request. Canopy with base-plate cover Ø 16 cm. Version 1: approx. 32 kg. Version 2: approx. 22 kg. ■ Aluminium, acier inoxydable. Surface intérieure dorée à la main, platine ou vernis en couleur mat. Réglable en hauteur au moyen de trois contrepoids. Longueurs spéciales sur demande. Baldaquin avec rondelle de recouvrement 16 cm. Version 1: env. 32 kg. Version 2: env. 22 kg. ■ Alluminio, acciaio inossidabile, superficie interna in oro, platino vernice colorata opaca. Altezza regolabile mediante tre contrappesi. Lunghezze speciali su richiesta. Rosone con piastra di copertura Ø 16 cm. Versione 1: ca. 32 kg. Versione 2: ca. 22 kg.

LED or Halogen, technical specification on request

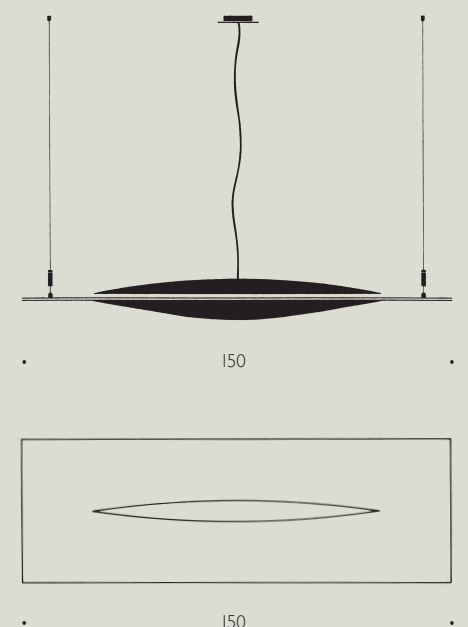

Schlitz LED Ingo Maurer 2002

Aluminium, Glas. Up- und Downlights getrennt schaltbar. Abhängung an zwei Stahlseilen. ■ Aluminium, glass. Up- and downlights separately switchable. Suspension on two steel wires. ■ Aluminium, verre. Up et downlights à allumage séparé. Suspendue à deux fils d'acier. ■ Alluminio, vetro. Uplights e downlights comandabili separatamente. Sospesa a due fili d'acciaio.

2 x 15 W Uplight, 3 x 15 W Downlight, 5 x 1300 lm, 3000 K, 50000 h, CRI >90, EEC A+ 220-240 V / 110-125 V 300 cm

Ringelpiez Suspension Ingo Maurer und Team 2017

Kohlefaser, Metall, Kunststoff. Höhenverstellbar; LED-Ring als Up- oder Downlight nutzbar. ■ Carbon fibre, metal, plastic. Height freely adjustable. LED ring can be used as up- or downlight. ■ Fibre de carbone, métal, matière plastique. Réglable en hauteur sans graduation, anneau avec LED ajustable comme uplight ou downlight. ■ Fibra di carbonio, metallo, material sintetico. Altezza regolabile. L'anello di LED funziona come uplight o downlight.

LED dimmable 25 W, 3600 lm, 3000 K, CRI 95, EEC A+

100-125 V/220-240 V/36 V 200 cm

Ringelpiez Frivoloso Ingo Maurer und Team 2017

Papierschild für alle Ringelpiez-Modelle, weiß oder grün. ■ Papershade for all Ringelpiez models, white or green. ■ Abat-jour en papier pour tous les modèles de Ringelpiez, blanc ou vert. ■ Paralume per tutte le versioni Ringelpiez, bianco o verde.

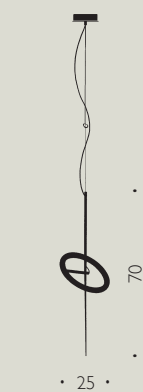

Silly-Kon Ingo Maurer und Team 2010

Silikon, Metall. Transparentes Kabel und Baldachin, Ø 8 cm. ■ Silicone, metal. Transparent cable and canopy, Ø 8 cm. ■ Silicone, métal. Câble et baldaquin transparents, Ø 8 cm. ■ Silicone, metallo. Cavo e rosone trasparenti, Ø cm. 8.

LED or Halogen E27, max. 75 W, A++-E 200/450 cm





Super Luzy'z Ingo Maurer 2018

Kunststoff, Metall, Niedervolt-Leuchtmittel. ■ Plastic, metal, low-voltage lamps, plastic. ■
Plastique, métal, lampes basse tension. ■ Plastica, metallo, lampade a bassa tensione.

💡 25 x 1,5 W LED, 25 x 100 lm, 15000 h, CRI 85, EEC A** ⚡ E27 ⚡ 200-240 V

💡 25 x 10 W Halogen, 25 x 90 lm, 2000 h, CRI 100, EEC C ⚡ E27 ⚡ 230/125/24 V

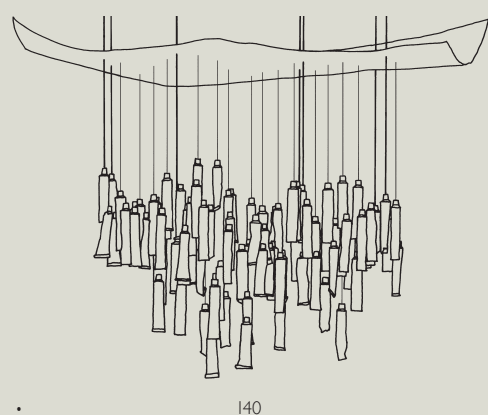

Tu-Be Lüster Ingo Maurer, Ron Arad 2007

93 Aluminium-Tuben, Stahl, Kunststoff. Für Raumhöhen bis 350 cm. Lieferung mit drei Ersatztuben. ■ 93 aluminium tubes, steel, plastic. For ceiling heights up to 350 cm. Complete with three spare tubes. ■ 93 tubes d'aluminium, acier, matière plastique. Pour hauteurs de pièce jusqu'à 350 cm. Livrée avec trois tubes de remplacement. ■ 93 tubi in alluminio, acciaio, materiale sintetico. Per soffitti con altezze fino a 350 cm. 3 tubi di ricambio inclusi.

📺 4 x 1,2 W LED blue/white 💡 LED or Halogen ⚡ G9, max. 40 W, A**–E

EU: The halogen version is a phase-out model, please check our website for up-to-date info and technical details of the new LED version.

140

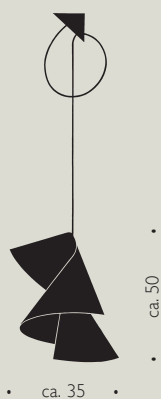

Willydilly Ingo Maurer 1983

Weißer transluzenter Karton. Kunststoff-Baldachin Ø 9 cm weiß, fluoreszierende Halteklammer. Höhenverstellbar. ■ White translucent cardboard. Plastic canopy Ø 9 cm white, with fluorescent clip. Height adjustable. ■ Carton blanc translucide. Baldaquin en plastique Ø 9 cm blanc, pince fluorescente. Hauteur réglable. ■ Cartone bianco traslucido, rosone Ø cm. 9 bianco in materiale sintetico, molletta fluorescente. Altezza regolabile.

💡 LED or Halogen ⚡ E27, max. 60 W, A**–E ⚡ 200/450 cm

ca. 35

ca. 50

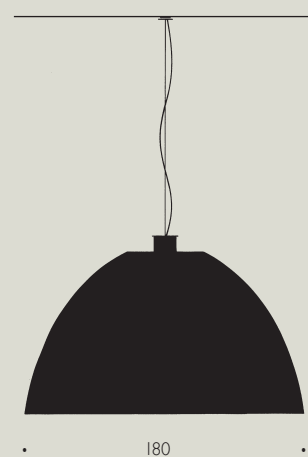

XXL Dome Ingo Maurer 1999

Fiberglas, außen alusilber, innen leucht-pink, -orange, -rot oder -grün matt lackiert. Sonderfarben möglich. Sonderlängen auf Anfrage. Gewicht ca. 45 kg. ■ Fibreglass, exterior aluminium-silver, interior fluorescent pink, orange, red or green mat lacquer. Other colours on request. Alternative lengths available on request. Weight approx. 45 kg. ■ Fibre de verre, extérieur vernis couleur argent, intérieur vernis mat, rose pink, orange, rouge ou vert fluorescent. Couleurs spéciales possibles. Longueurs spéciales sur demande. Poids env. 45 kg. ■ Vetroresina, superficie esterna verniciata color argento, superficie interna luminescente pink, arancione, rosso o verde, vernice opaca. Colori speciali su richiesta. Lunghezze speciali su richiesta. Peso ca. 45 kg.

📺 💡 LED or Halogen, technical specification on request

180

104

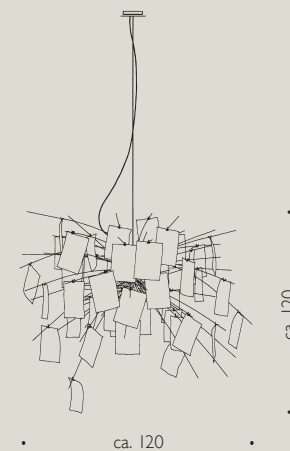

Zettel'z 5 Ingo Maurer 1997

Japanpapier, Edelstahl, hitzebeständiges satiniertes Glas. Baldachin Ø 11 cm. 31 bedruckte und 49 unbedruckte Blätter DIN A5. Ein Set mit 80 unbedruckten Blättern als Zubehör erhältlich. ■ Japanese paper, stainless steel, heatresistant satin-frosted glass. Canopy Ø 11 cm. 31 printed and 49 blank paper sheets DIN A5. Set of 80 blank paper sheets available. ■ Acier inoxydable, verre satiné résistant à la chaleur, papier japonais. Baldaquin Ø 11 cm. 31 feuilles imprimées et 49 feuilles blanches DIN A5. 80 feuilles blanches disponibles. ■ Carta giapponese, acciaio inossidabile, vetro satinato termoresistente. Rosone Ø cm. 11. 31 fogli prestampati e 49 fogli bianchi DIN A5. Possibilità di ordinare un set di 80 fogli bianchi.

💡 1 x LED or Halogen and 1 x PAR 30 LED or Halogen

⚡ 2 x E27, max. 250/75 W, A**–E ⚡ 330/600 cm

ca. 120

ca. 120

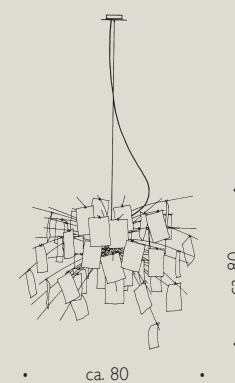

Zettel'z 6 Ingo Maurer 1998

Japanpapier, Edelstahl, hitzebeständiges satiniertes Glas. Baldachin Ø 11 cm. 40 bedruckte und 40 unbedruckte Blätter DIN A6. Set mit 80 unbedruckten Blättern als Zubehör erhältlich. ■ Japanese paper, stainless steel, heat-resistant satin-frosted glass. Canopy Ø 11 cm. 40 printed and 40 blank paper sheets DIN A6. Set of 80 blank paper sheets available. ■ Acier inoxydable, verre satiné résistant à la chaleur, papier japonais. Baldaquin Ø 11 cm. 40 feuilles imprimées et 40 feuilles blanches DIN A6. 80 feuilles blanches disponibles. ■ Carta giapponese, acciaio inossidabile, vetro satinato termoresistente. Rosone Ø cm. 11. 40 fogli prestampati e 40 fogli bianchi DIN A6. Possibilità di ordinare un set di 80 fogli bianchi.

💡 1 x LED or Halogen ⚡ 1 x E27, max. 250 W, A**–E ⚡ 200/400 cm

ca. 80

ca. 80

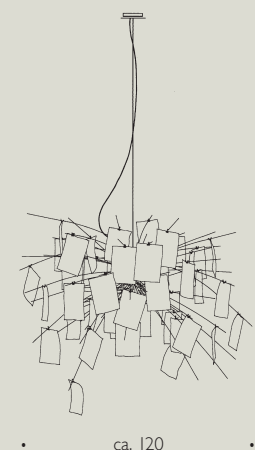

Zettel'z Laughing Buddha Ingo Maurer und Team 2018

80 Blätter aus Japanpapier; zweiseitig mit Fotos von Scherben chinesischer Buddha-Figuren bedruckt. Limitierte Auflage, 200 Stück. Japanpapier DIN A5, Edelstahl, hitzebeständiges satiniertes Glas. Baldachin Ø 11 cm. ■ 80 sheets made of Japanese paper, printed on two sides shards of Chinese Buddha figures. Limited edition of 200 pieces. Japanese paper DIN A5, stainless steel, heatresistant satin-frosted glass. Canopy Ø 11 cm. ■ 80 feuilles de papier japonais, imprimées sur deux faces avec éclats de figurines de Bouddha chinois. Édition limitée à 200 exemplaires. Papier japonais DIN A5, acier inoxydable, verre satiné résistant à la chaleur, Baldaquin Ø 11 cm. ■ 80 fogli di carta giapponese, stampati con immagini di frammenti di figure di Buddha cinesi su entrambi i lati. Edizione limitata, 200 esemplari. Carta giapponese DIN A5, acciaio inossidabile, vetro satinato termoresistente. Rosone Ø cm. 11.

💡 1 x LED or Halogen and 1 x PAR 30 LED or Halogen

⚡ 2 x E27, max. 250/75 W, A**–E ⚡ 330/600 cm

ca. 120

ca. 120

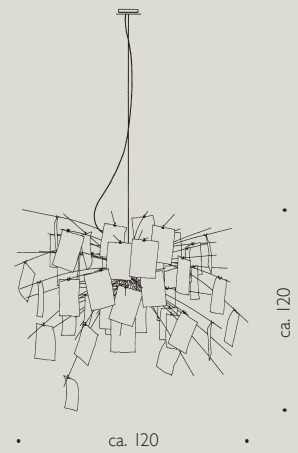

ca. 120

ca. 120

Zettel'z Munari Ingo Maurer und Team 2018

80 Blätter aus Japanpapier, zweiseitig mit Grafiken von Bruno Munari bedruckt. Limitierte Auflage, 200 Stück. Japanpapier DIN A5, Edelstahl, hitzebeständiges satiniertes Glas. Baldachin Ø 11 cm. ■ 80 sheets made of Japanese paper, printed on two sides with drawings by Bruno Munari. Limited edition of 200 pieces. Japanese paper DIN A5, stainless steel, heatresistant satin-frosted glass. Canopy Ø 11 cm. ■ 80 feuilles de papier japonais, imprimées sur deux faces avec graphisme par Bruno Munari. Édition limitée à 200 exemplaires. Papier japonais DIN A5, acier inoxydable, verre satiné résistant à la chaleur, Baldaquin Ø 11 cm. ■ 80 fogli di carta giapponese, stampati su due lati con grafica di Bruno Munari. Edizione limitata a 200 pezzi. Carta giapponese DIN A5, acciaio inossidabile, vetro satinato termoresistente. Rosone Ø cm. 11.

Bruno Munari's ABC ©1960 Bruno Munari.
All rights reserved to Maurizio Corraini srl. Italy

💡 1 x LED or Halogen and 1 x PAR 30 LED or Halogen
🔌 2 x E27, max. 250/75 W, A++-E ⚡ 330/600 cm

Zufall Ingo Maurer und Team 2008

Sonderanfertigung aus farbigem, handgegossenem Silikon, Farben nach Absprache. Der Silikonkörper kann flexibel verknotet werden. Für Raumhöhen bis 300 cm. Baldachin Ø 8 cm. ■ Hand-made silicone body, bespoke colours. The silicone body is flexible. For ceiling heights up to 300 cm. Canopy Ø 8 cm. ■ Tuyau flexible en silicone spéciale faites main. De différentes couleurs pourront être réalisées sur demande. Pour hauteurs de pièce jusqu'à 300 cm. Baldaquin Ø 8 cm. ■ Corpo flessibile di silicone fatto a mano. Colori su richiesta. Per soffitti con altezze fino cm. 300. Rosone Ø cm. 8.

💡 LED or Halogen 🔌 E27, max. 75 W, A++-E



max. 260



Laughing Buddha

Tischlampen
Lampes de table
Lampade da tavolo

TABLE LAMPS

A piece of paper.
A softly swinging
metal wire. A LED
light source.
KOYOO is
focussed on
the essential.
What a beauty!
By Axel Schmid

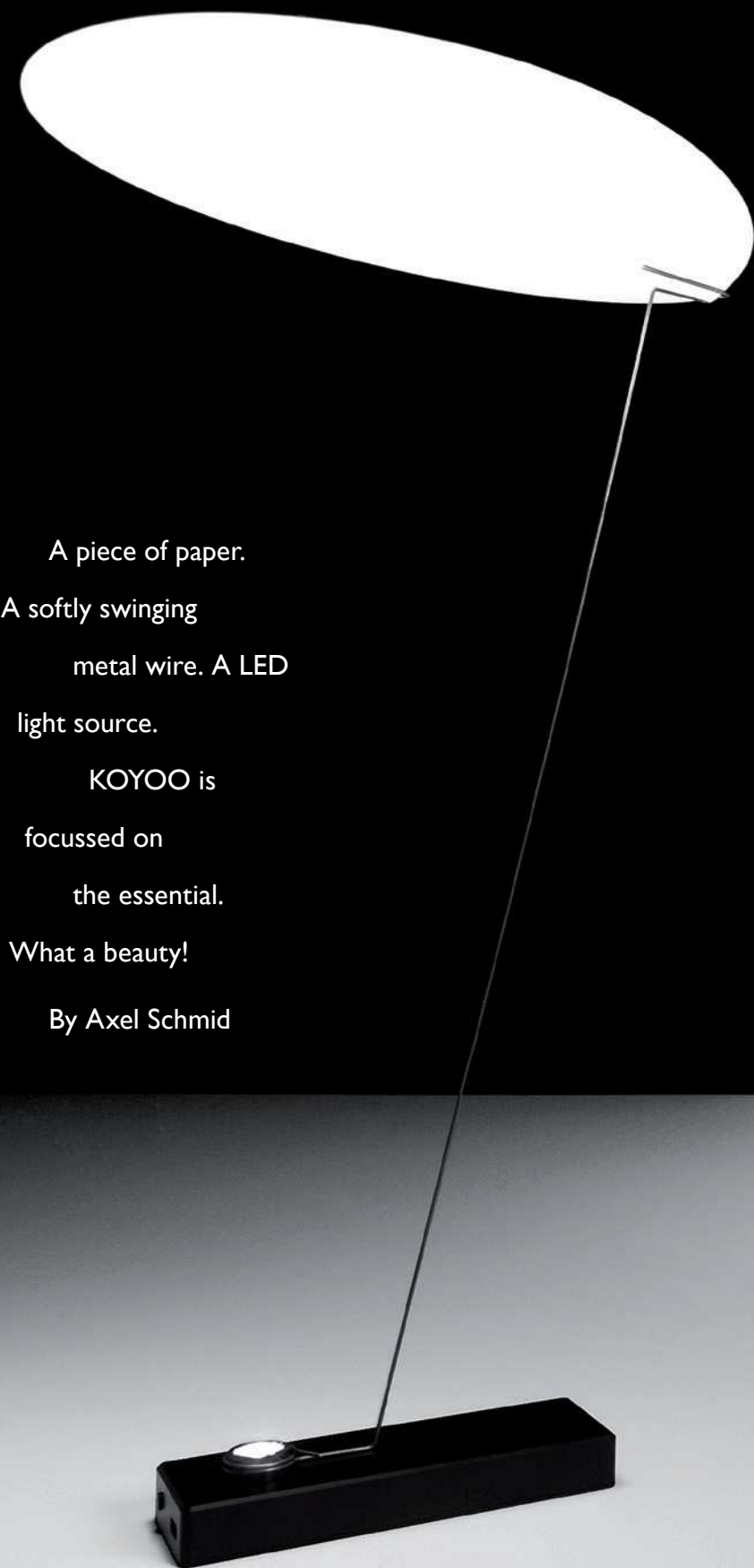

高揚 KoYoo





Ringpiez nude

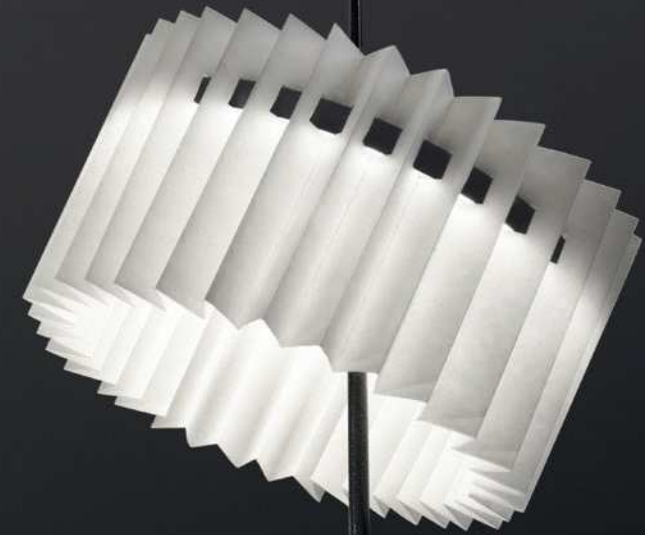

RINGELPIEZ FRIVOLOSO___Suspension

RINGELPIEZ FRIVOLOSO___Table



GLATZKOPF TABLE now, 2017

144



145

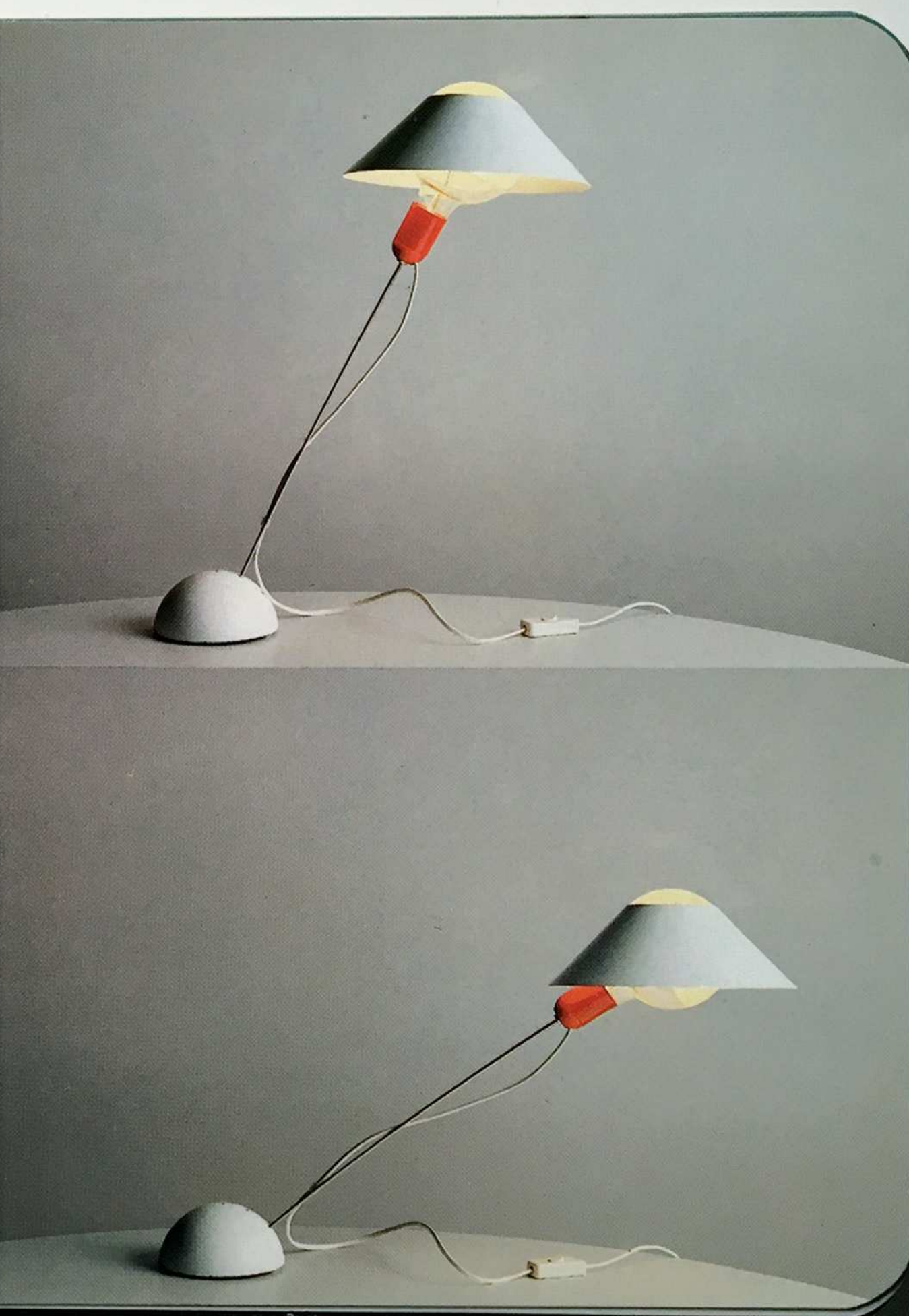

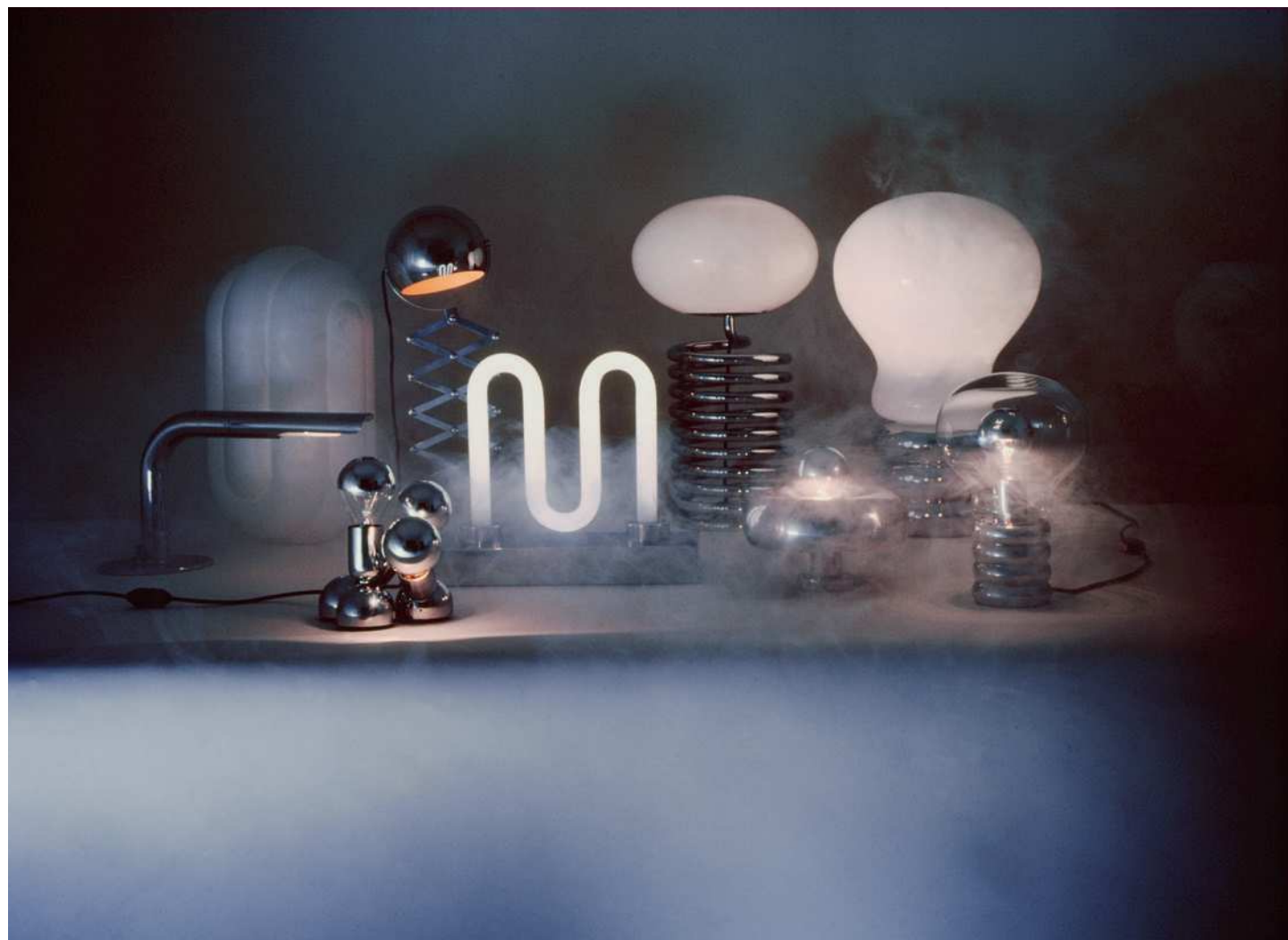

THE BEGINNING:

Vintage photograph (1967).
Oldies available
at auctions.

BULB 1966

Included into
the permanent
design collection
of the MoMA
in New York.

A classic still available.



The most beautiful light comes from the human heart. I.M.



BULB LIMITED HEART



La humanidad
se divide en
dos: Los que
cagan bien y los
que cagan mal.

Gabriel Garcia Márquez

Celebrating 50 years of Bulb

BULB LIMITED FLY

148

149

Blue, red or green
anodised dragonflies in
laser cut aluminum.



I RICCHI POVERI - BZZZZ



I RICCHI POVERI - FIVE BUTTERFLIES



Black
White
Brass
Red



154

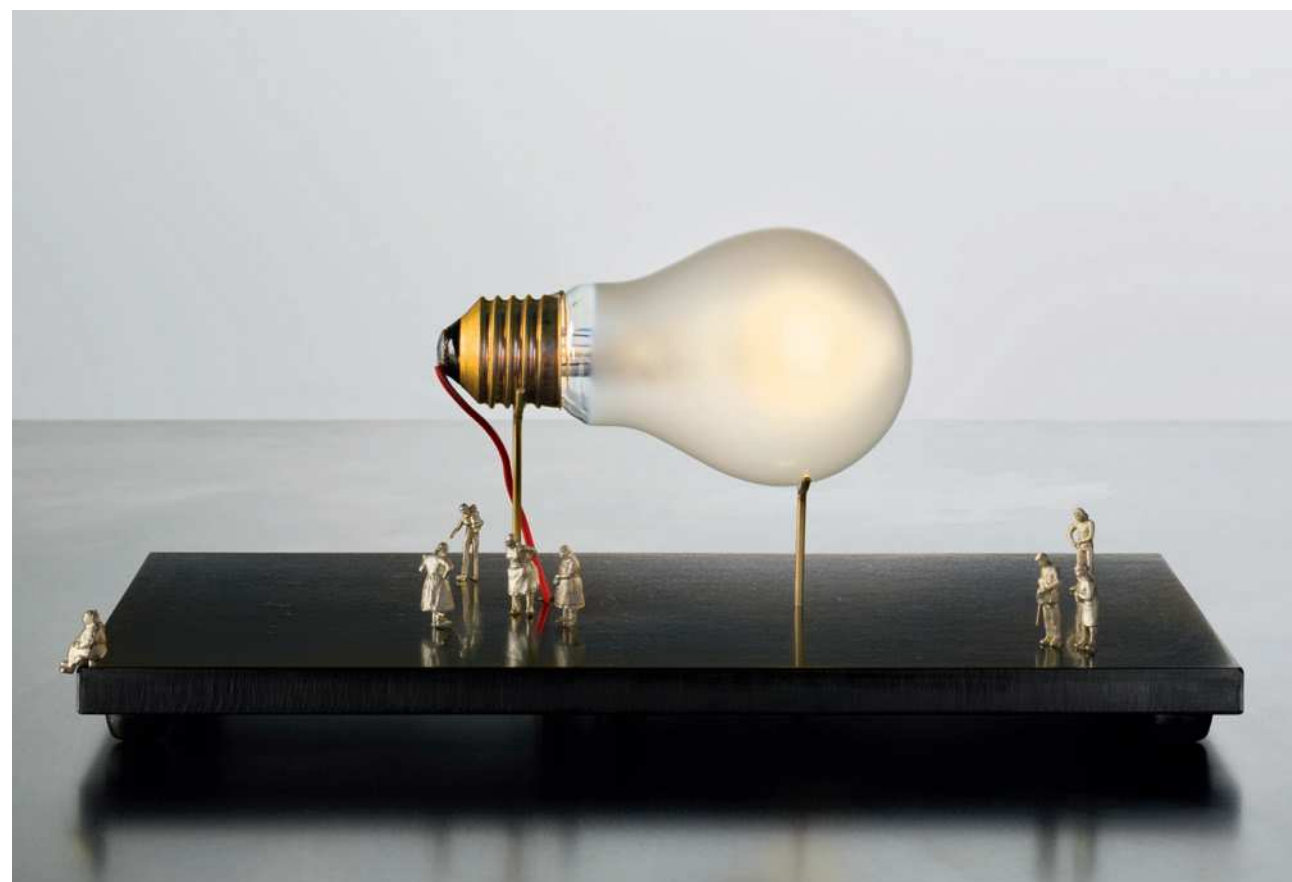

I RICCHI POVERI - MONUMENT FOR A BULB*

* Limited edition

155



I RICCHI POVERI - FLY

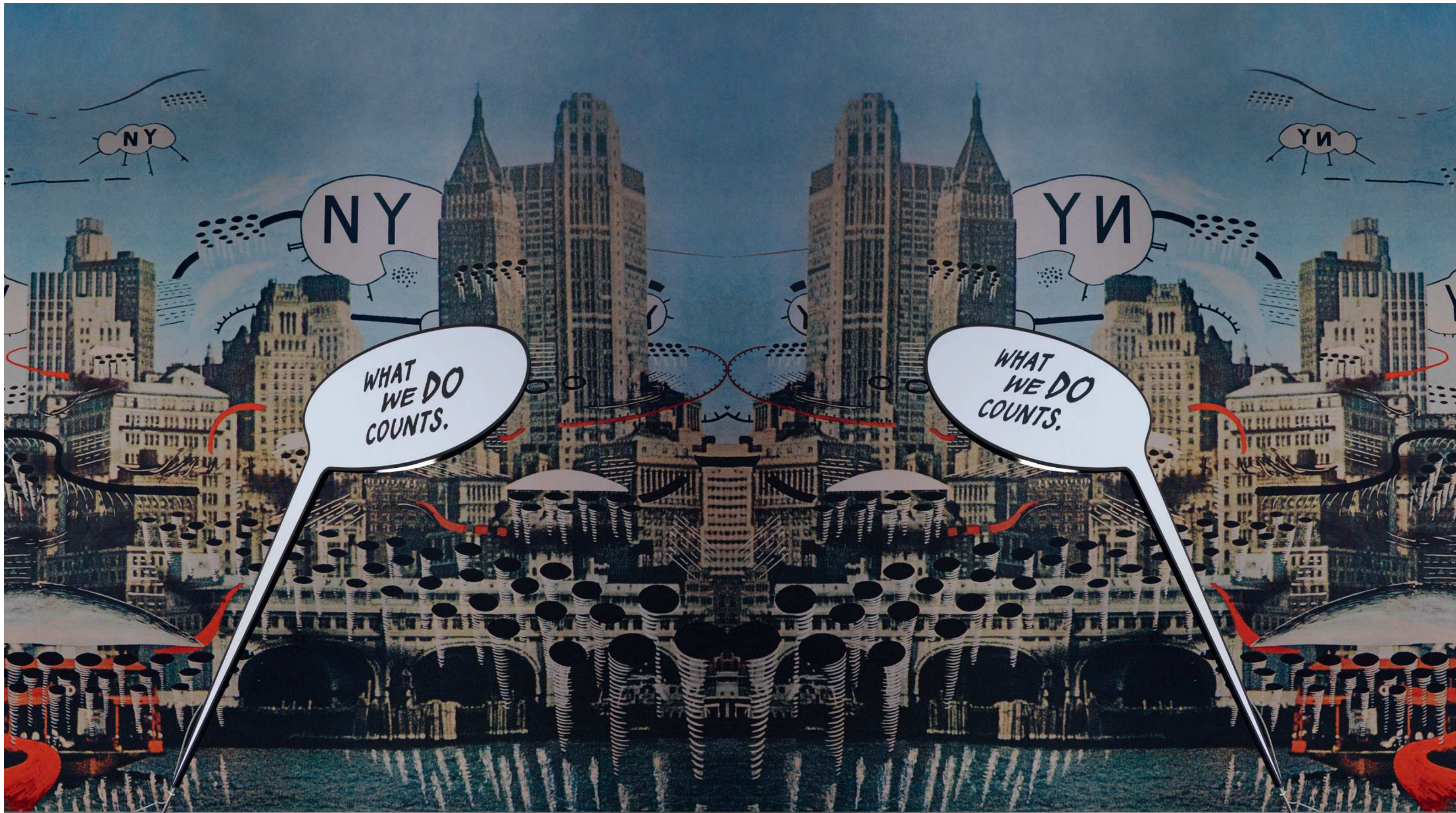

Magical New York! We are addicted to this metropolis. Our showroom *Making Light* is located in the heart of SoHo at 89 Grand and Greene, a landmark.

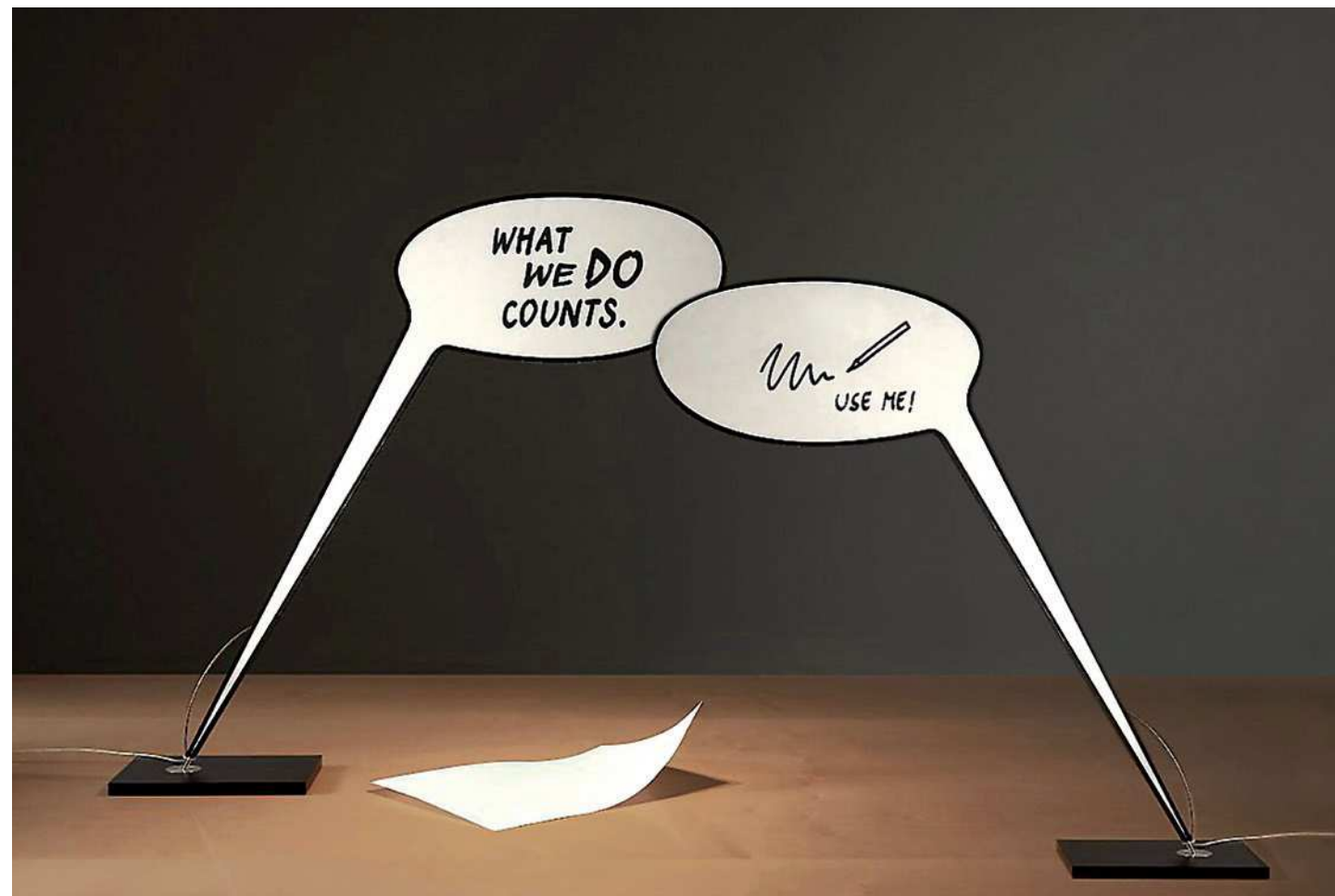

WHAT WE DO COUNTS

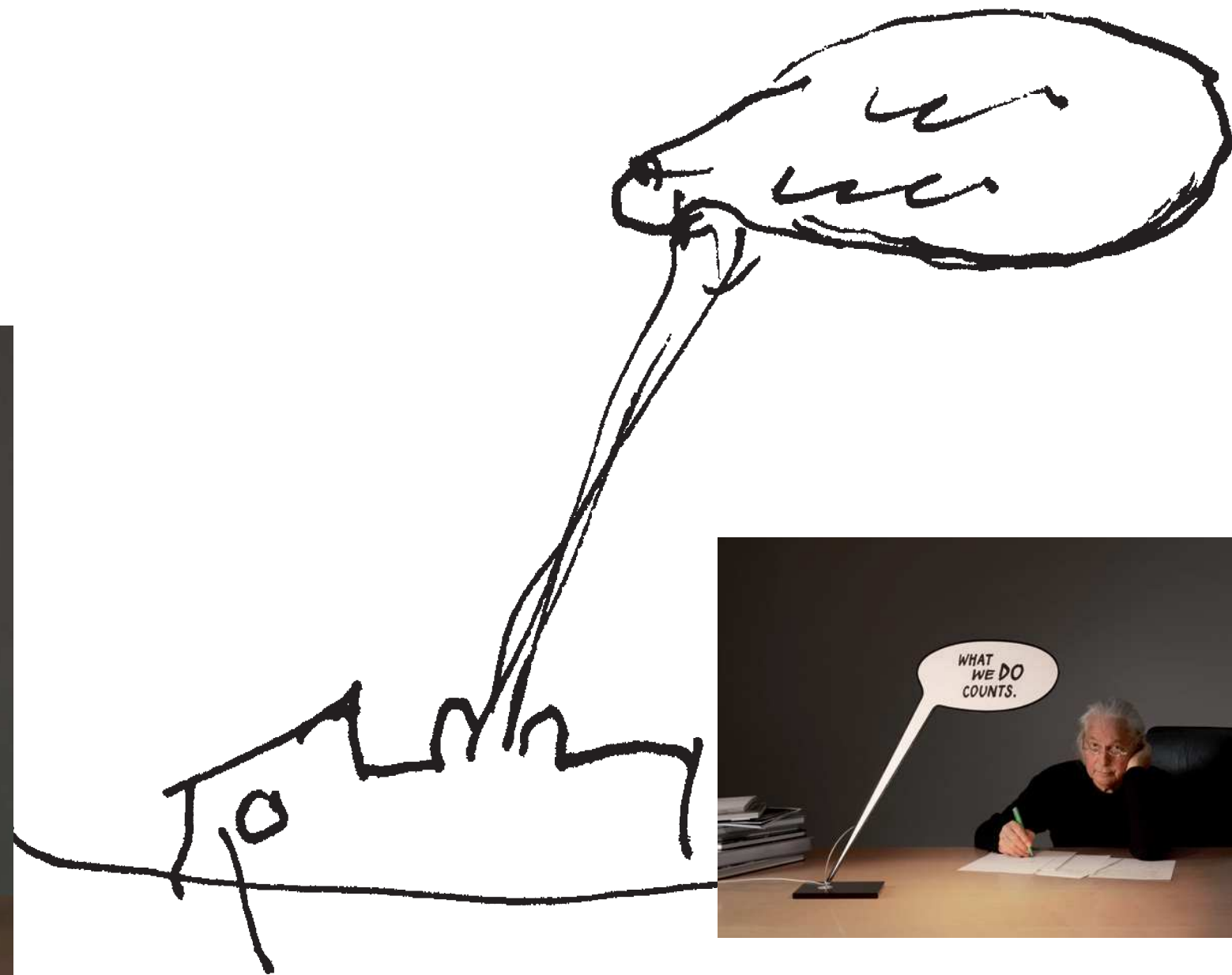

Comics have become an important part of our lives. Witty and cheerful, humorous and last but not least very inspiring. I love speech bubbles. So I thought, why not turn a speech bubble into a desk lamp? But with a strong message which concerns us all: "What we do counts."



Spyre.
 By Ron Arad.
 Inspired by
 a 17 m high
 sculpture for the
 Royal College of Art,
 London.
 Translated into
 a functional
 desk lamp by
 Ingo Maurer
 and Team.

SPYRE _____ Collector's item, limited edition of 50



Enables many positions.

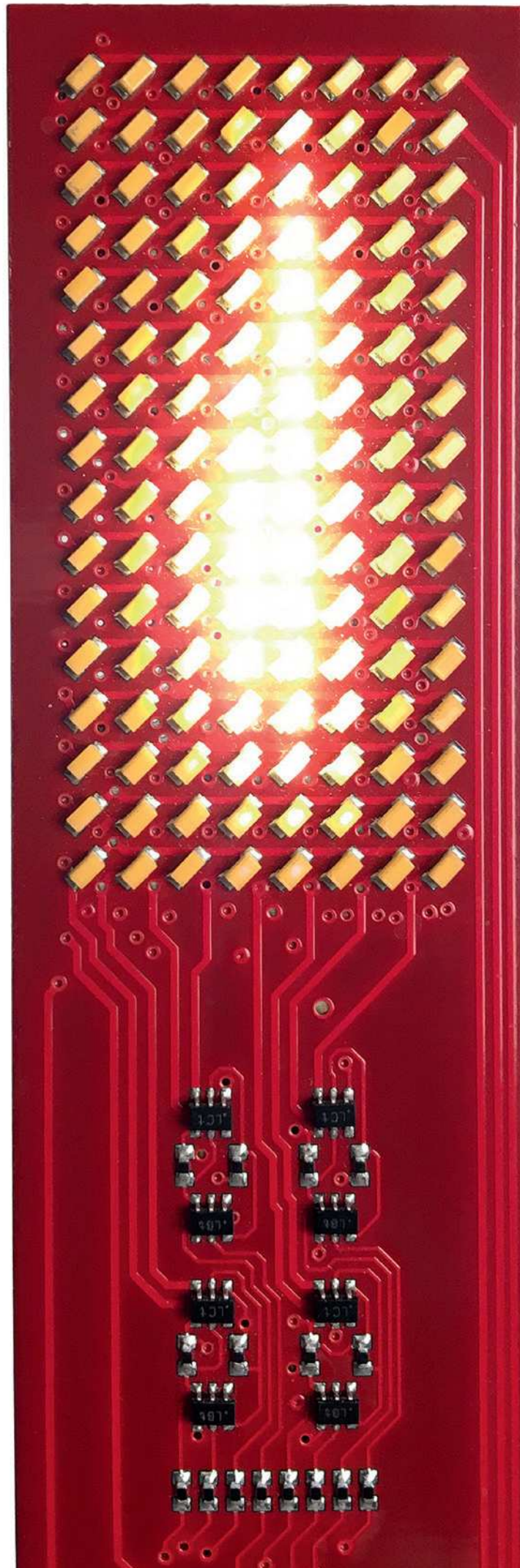

Out, out, brief candle!
Life's but a walking shadow ...
(Shakespeare).

MY NEW FLAME moves,
it flickers, it is heart warming.

And it's purely digital.

A milestone in combining
ultra-hightech with

true romance.

Let's call it:

technical beauty.

In collaboration

with Moritz Waldemeyer.

MY NEW FLAME



Black
White
Red

162

163

Watch the video [▶ ingo-maurer.com](https://www.ingo-maurer.com)

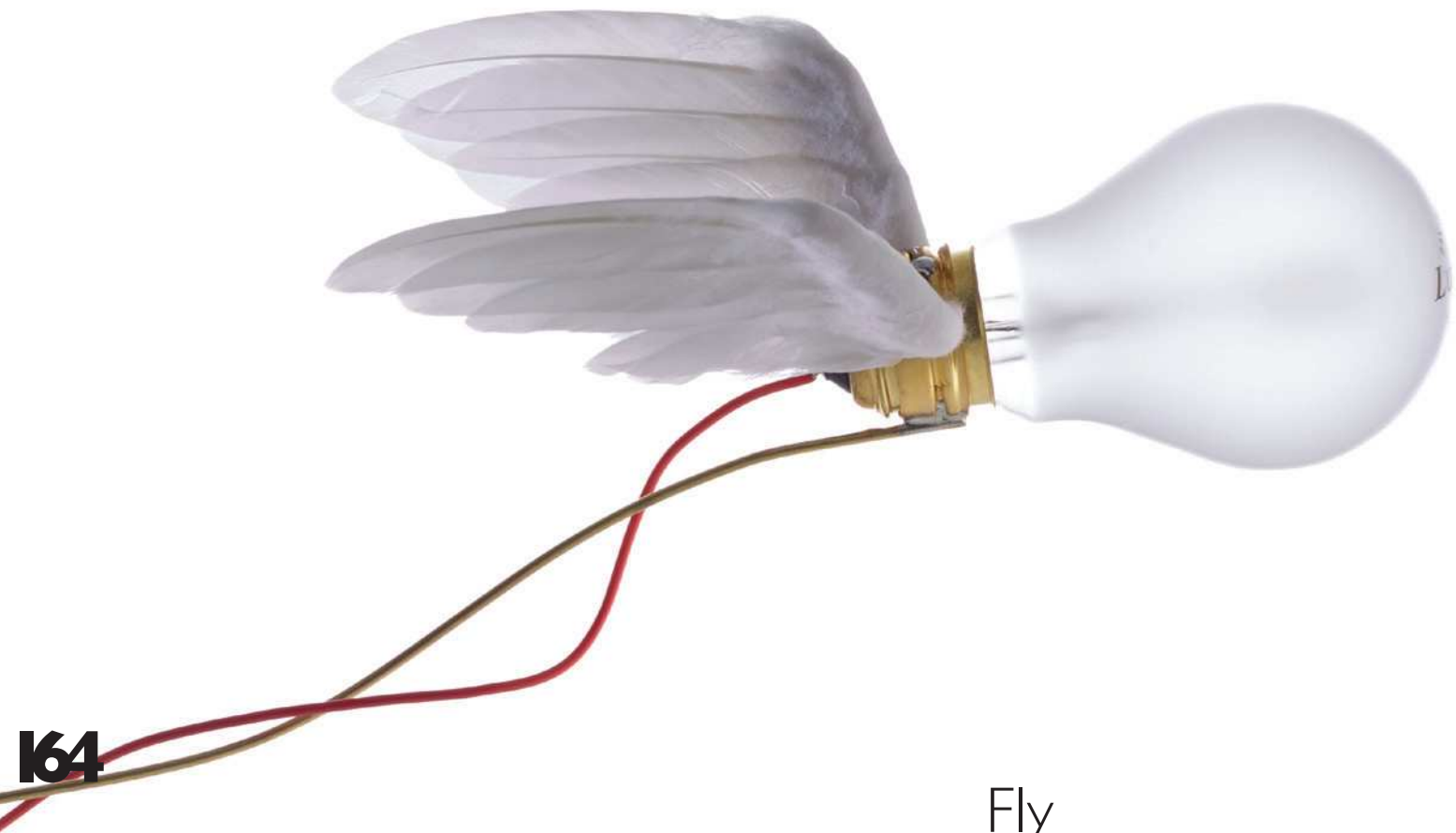

I64

Fly
high,
dim
low.

LUCELLINO LED TRI-R



I65

LUCELLINO

166

167

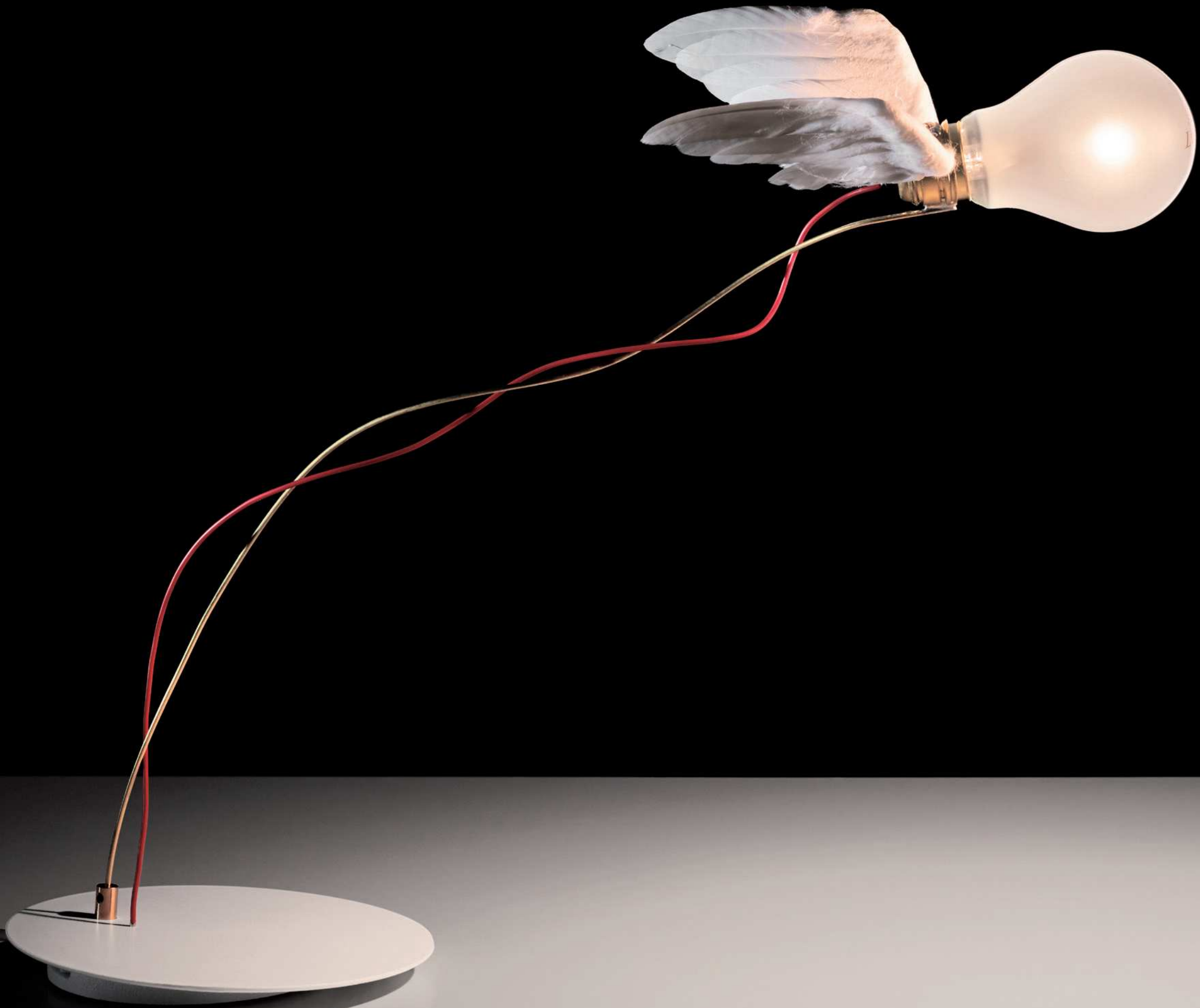

LUCELLINO LED TRI-R

168



BIRDIE'S BUSCH NOW ALSO IN LED

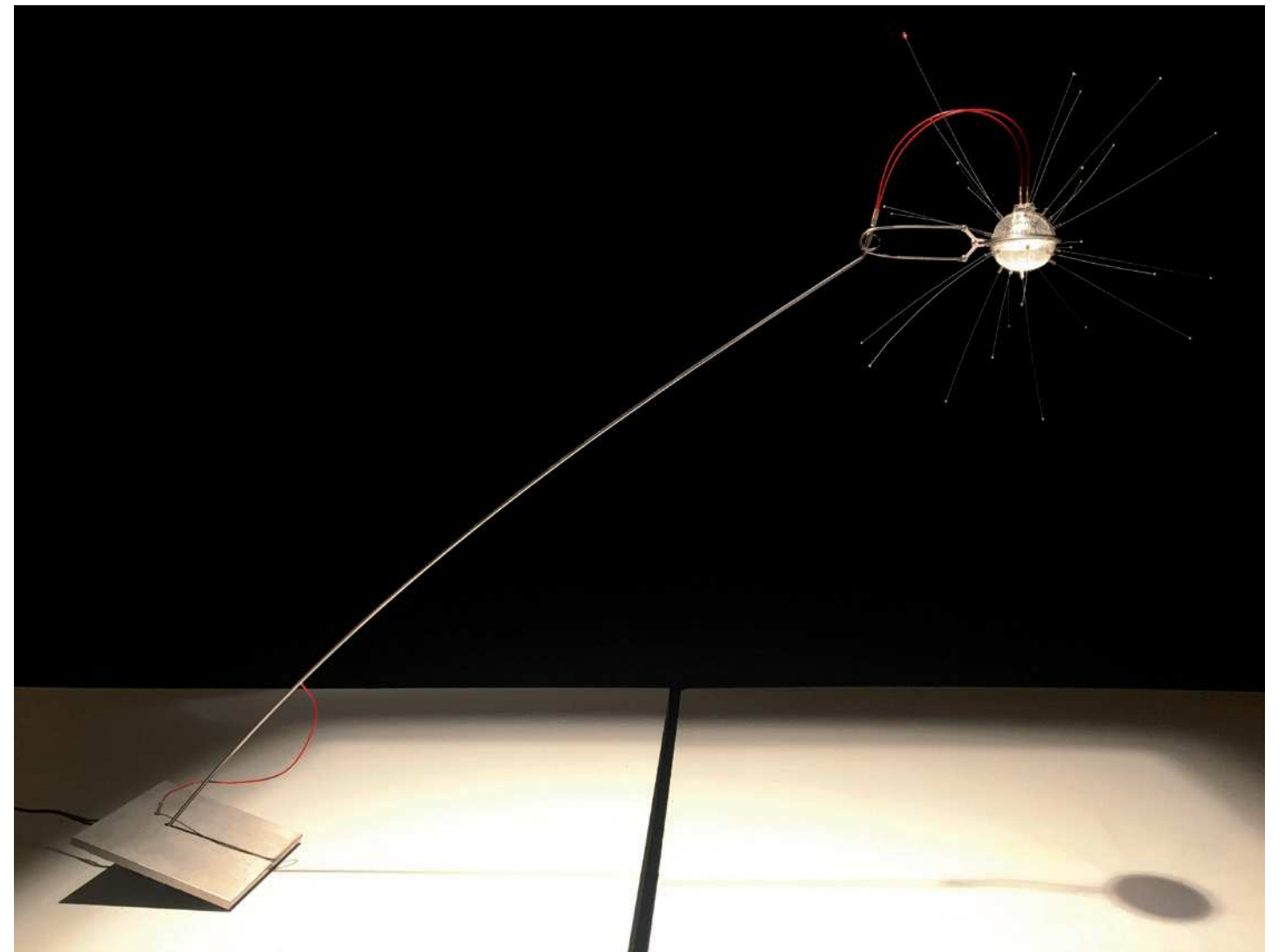

169

MOZZKITO

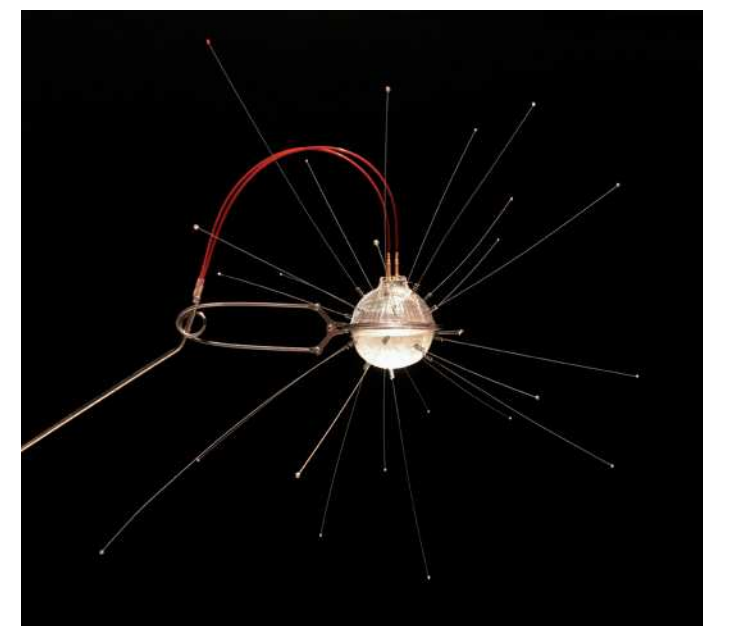

Once upon a time
I was a tea strainer.

WALKING BULB

The LED spot swivels
through 360° on a
horizontal axis.
Switch it on and off
by touching the
metal pin on
the LED spot.



JETZT²

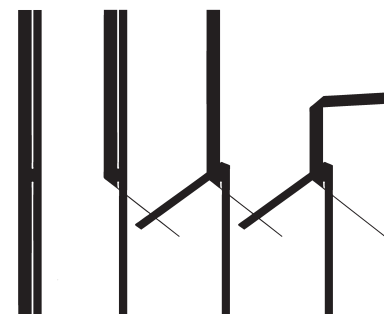

One piece of folded
aluminium makes
the lightest light.





LED'S OSKAR



OSKAR

2001.
First LED task lamp.
Sold out.

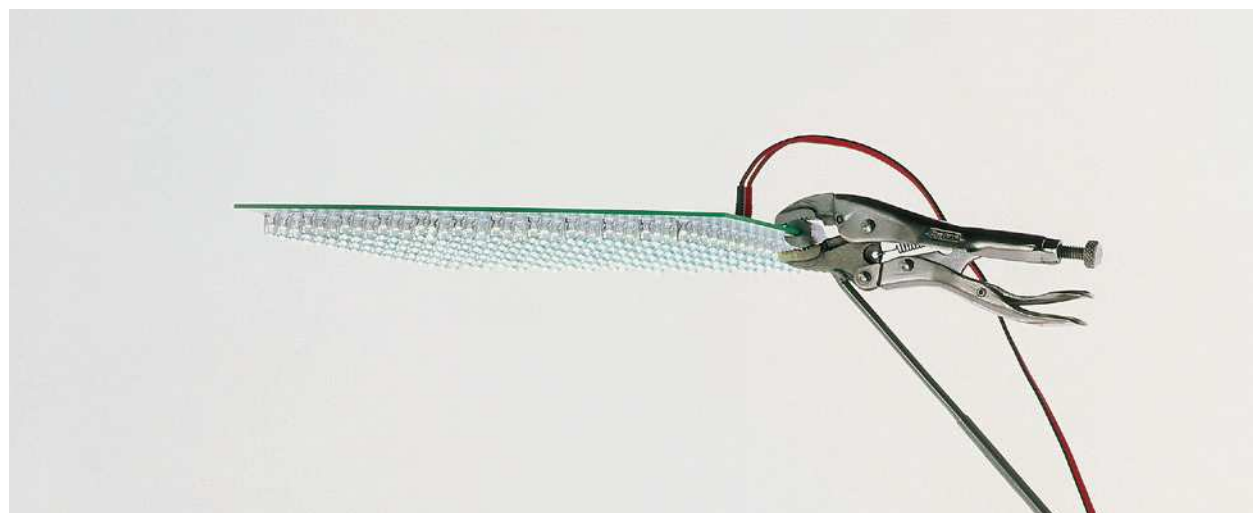

OH•LED•ONE An ingenious development that will enrich the future.



DEW DROPS TABLE



LIGHT STRUCTURE

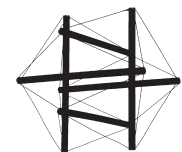
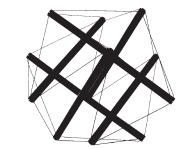
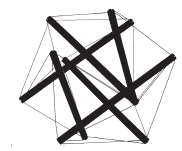
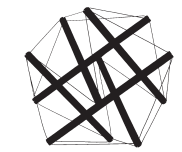
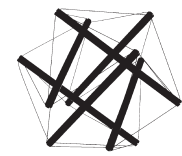
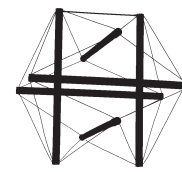

LIGHT STRUCTURE THREE

178

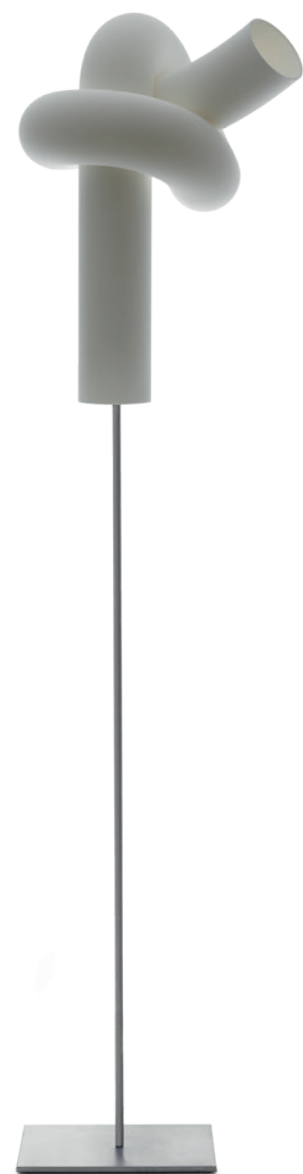

KNOT 1*

Made in three-dimensional printing technology. Knot is available as table and floor lamp.



179

KNOT 2*



* Limited production



DELIRIUM YUM

Om mani padme yum.
Meditate, gaze, free your
mind watching the eddy.
Delirium Yum is a small
version of a water column
with a height of 4 m.
Ingo Maurer and team.



CAMPARI BAR

VERAMENTE AL DENTE*



* One of a kind



KOLLEKTIV KÖLN 1985

ONE FROM THE HEART

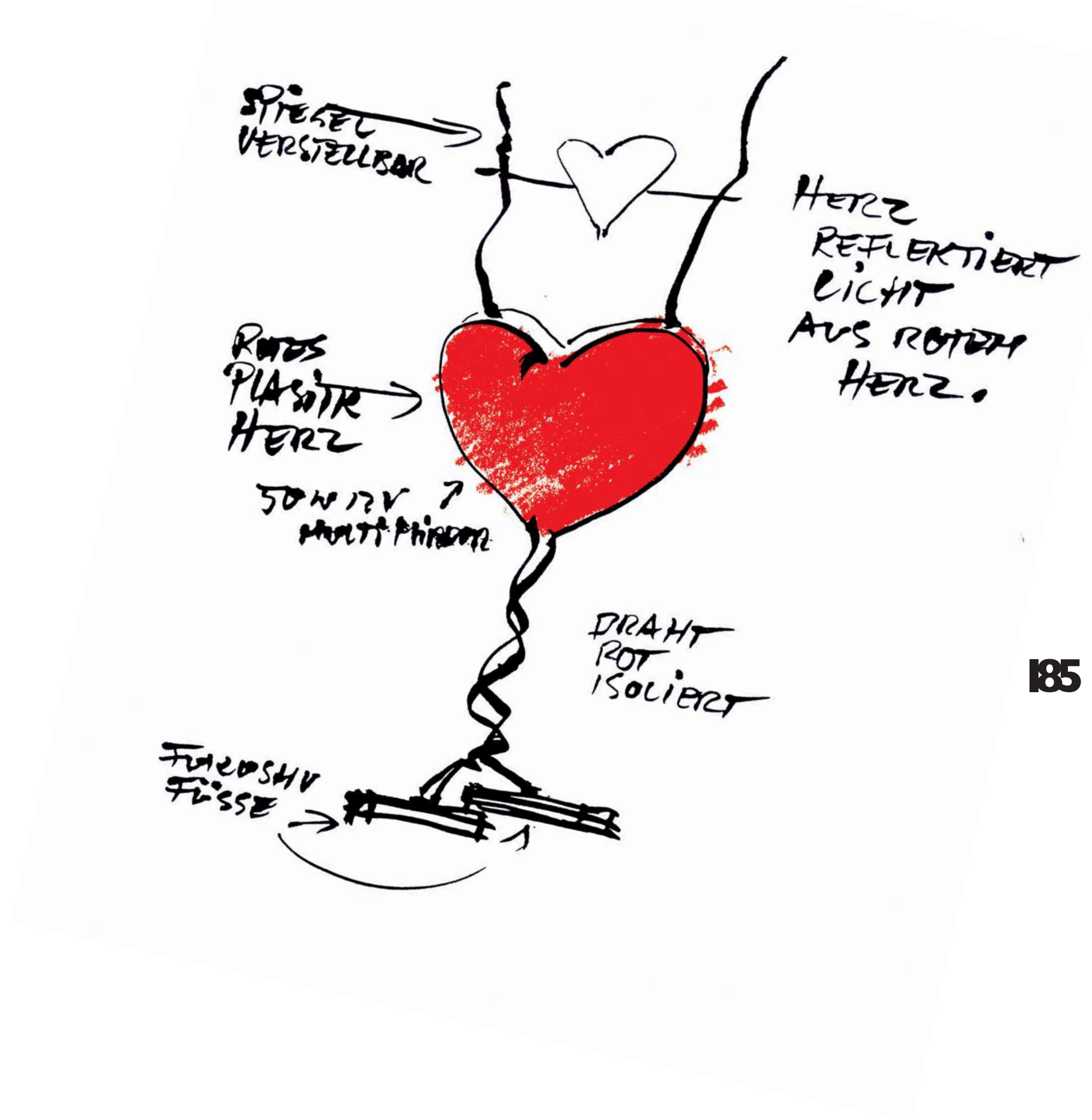

SPIEGEL
VERSTELLBAR

ROTES
PLASTIK
HERZ

50 W 12V ?
MULTI PHASEN

DRAHT
ROT
ISOLIERT

HERZ
REFLEKTIERT
LICHT
AUS ROTEM
HERZ.

FRIEDSHV
FÜSSE

SILICONE TUBE LAMP

□ SQUARE PROFIL

COLORS: BLACK,
WHITE, RED+BLUE

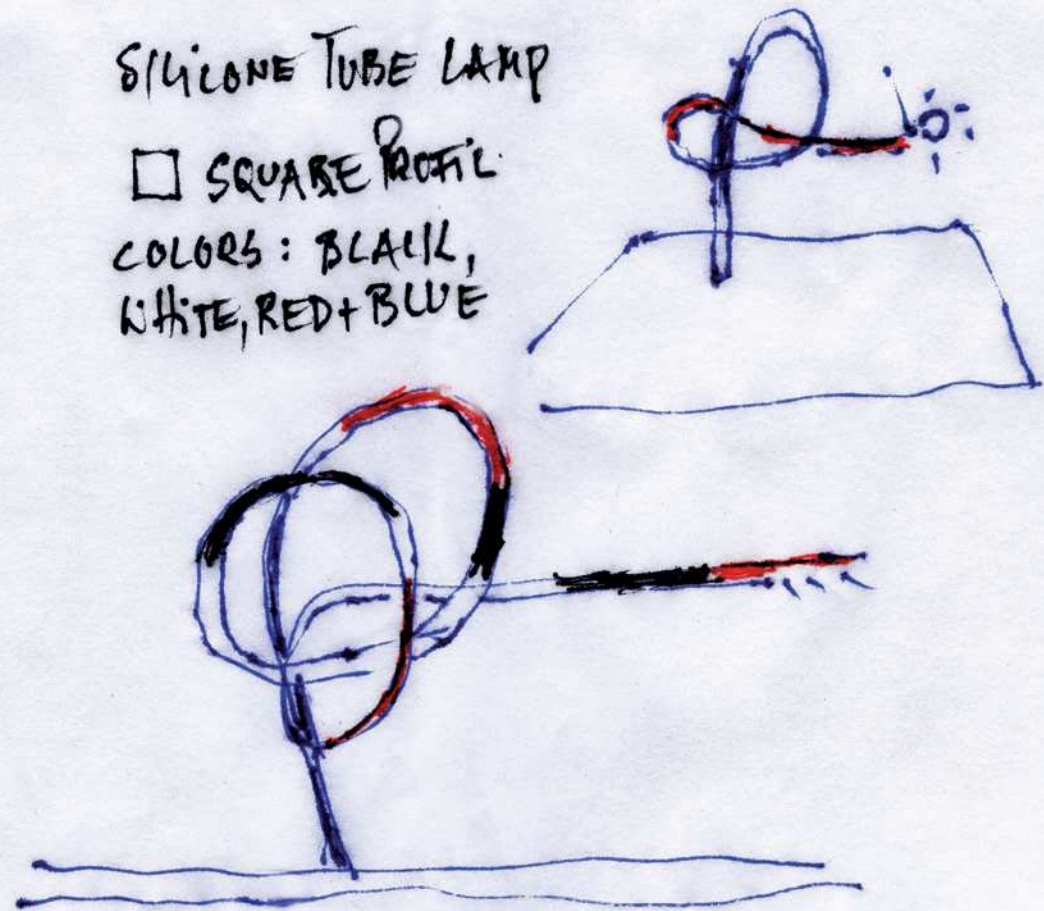

Table lamp silicone

186

ZUFALL _____ THE ARTIST'S LUCK!



187



MAX. KUGLER



LOOKSOFLAT

Super working light.
Grazie Stefan!
Sei bravissimo.

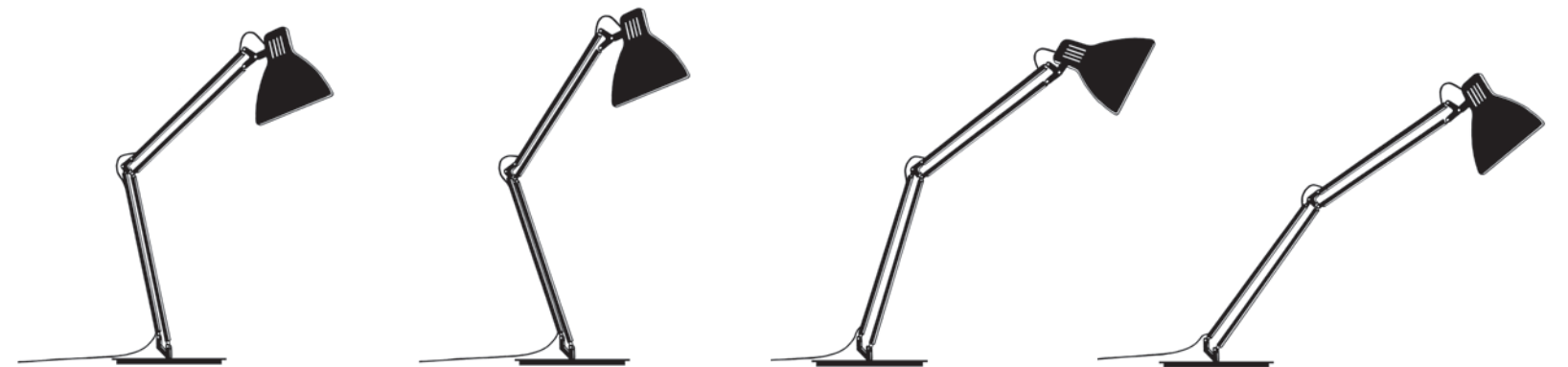



24 KARAT BLAU T

Seven Rats in Paris,
Showroom Sec Silvera,
Avenue de Wagram, 2014



SEVEN RATS



Nomen est omen:

BASTARDO

Provocative,
mixed materials,
leaving conventional
thinking.

An included
extension rod
turns the desk lamp
into a floor lamp.

By Bernhard Dessecker.



Be aware of snakes!
Especially of those
which make
a perfect light.



Don Quixote.
Table and wall.
Ingo's favorite light.
Fearlessly
mixing materials.
By special order
also in gold.



DON QUIXOTE





BIBIBIBI

Elsa watching
her chicken.



LAMPAMPE

Born in 1980



GRASL since 1973

grasl



24 Karat Blau T Axel Schmid 2005

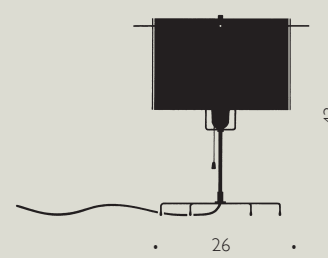

Vier Platten aus in Acrylglas eingegossenem Blattgold, Metallstab in Rot. Zugschalter an der Fassung. Rotes Kunststoffkabel. ■ Four plates made of gold leaf sealed in acrylic glass, metal rod in red. Pull switch at the socket. Red plastic cable. ■ Quatre plaques en feuilles d'or moulées dans du verre acrylique, tige en métal rouge. Interrupteur à tirette au niveau de la douille. Câble plastique rouge. ■ Quattro lastre con foglia d'oro colata in vetro acrilico, asta rossa in metallo. Interruttore a tirante sul portalampada. Cavo tessile rosso.

LED or Halogen E27, max. 60 W, A++-E 200 cm

Bastardo Bernhard Dessecker/Ingo Maurer 2015

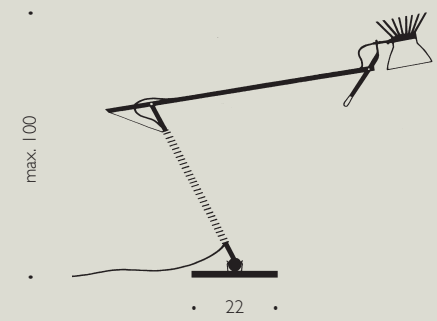

Steh- oder Tischlampe. Die Neigung lässt sich über das Kugelgelenk am Fuß einstellen. Der mitgelieferte Verlängerungsstab macht auf Wunsch aus der Tischlampe eine Stehlampe. Stahl, Aluminium, Kunststoff. ■ Desk or floor lamp. The angle is adjustable by the ball joint in the base. An included extension rod turns the desk lamp into a floor lamp. Steel, aluminium, plastic. ■ Lampe de table ou lampadaire. L'inclinaison de la lampe est réglable par l'articulation à rotule au niveau du socle. Acier, aluminium, matière plastique. ■ Lampada da tavolo o a stelo. L'inclinazione della lampada può essere regolata mediante un giunto a sfera. Acciaio, alluminio, materiale sintetico.

13,5 W LED, 1500 lm, 3000 K, CRI >90, A+ 100-240 V 250 cm



Bibibibi Ingo Maurer 1982

Porzellan, Metall und Plastik. Beweglicher Reflektor. Textilkabel mit Schalter. ■ Porcelain, metal, plastic. Adjustable reflector. Textile cable with switch. ■ Porcelaine, métal et matière plastique. Réflecteur réglable. Câble en textile avec interrupteur. ■ Porcellana, metallo e materiale sintetico. Riflettore orientabile. Cavo tessile con interruttore.

LED or Halogen E27, max. 60 W, A++-E 300 cm

Birdie's Busch Ingo Maurer und Team 2010

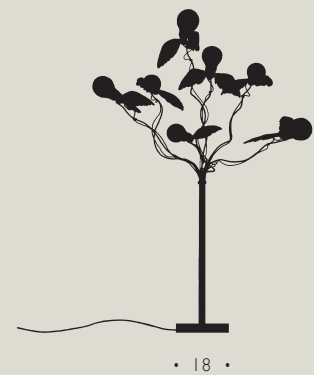

Metall, Flügel aus Gänsefedern, sieben Niedervolt-Glühlampen, transparente Kabel. Primärkabel mit Schalter, kein integrierter Dimmer. ■ Metal, goose-feather wings, seven low-voltage bulbs, transparent cables. Primary cable with switch, without integrated dimmer. ■ Métal, ailes en plumes d'oie, sept ampoules à bas voltage, câbles transparents. Câble primaire avec interrupteur, pas de variateur intégré. ■ Metallo, ali in piume d'oca, sette lampadine a basso voltaggio, cavi trasparenti. Cavo primario con interruttore, senza dimmer integrato.

7 x 10 W Halogen, 7 x 90 lm, 2000 h, CRI 100, EEC E 27 230/125/24 V

7 x 1,5 W LED, 7 x 100 lm, 2700 K, 15000 h, CRI 85, EEC A+ E 27 200-240/12 V AC



Bulb Ingo Maurer 1966

Hochglanzverchromtes Metall, mundgeblasenes Kristallglas. Lieferung mit kuppenverspiegeltem Leuchtmittel. 230-Volt-Version mit kuppenverspiegelter LED-String-Birne.
 ■ Polished chromium-plated metal base, hand-blown crystal glass. Complete with top-chromated bulb, 230 volts version with top-chromated LED string bulb. ■ Métal chromée, cristal soufflé. Livrée avec ampoule à coupole argentée, la version 230 volts avec ampoule LED String à coupole argentée. ■ Metallo cromato lucido, cristallo soffiato. Lampadina a cupola argentata inclusa, versione 230 volt con lampadina LED String a cupola argentata inclusa.

LED or Halogen E 27, max. 100 W, A++-E 200 cm

Bulb Limited Heart / Fly Ingo Maurer und Team 2016

Zwei limitierte Editionen zum Jubiläum der Bulb. Messingfuß, mundgeblasenes Kristallglas mit eingraviertem Text. Version „Heart“, limitiert auf 88 Stück, der Text lautet „The most beautiful light comes from the human heart.“ Version „Fly“, limitiert auf 12 Stück, mit handgemachten Fliegenmodellen auf dem Glaskolben und Zitat von Gabriel Garcia Marquez „La humanidad se divide en dos: Los que cagan bien y los que cagan mal.“ Lieferung mit kuppenverspiegeltem Leuchtmittel, 230-Volt-Version mit kuppenverspiegelter LED-String-Birne.
 ■ Two limited editions, created on occasion of the anniversary of Bulb. Base in brass, hand-blown crystal glass decorated with engraved text. The “Heart” version is limited to 88 pieces, with “The most beautiful light comes from the human heart.” as text. The “Fly” version is limited to 12 pieces, with handmade models of flies on the glass and a quotation of Gabriel Garcia Marquez “La humanidad se divide en dos: Los que cagan bien y los que cagan mal.” as text. Complete with top-chromated bulb, 230 volts version with top-chromated LED string bulb. ■ Deux éditions limitées pour le cinquantenaire de la Bulb. Socle en laiton, globe en cristal soufflé à la bouche avec texte gravé. Version „Heart“, limitée à 88 pièces, avec comme texte „The most beautiful light comes from the human heart.“ Version „Fly“, limitée à 12 pièces, avec modèle de mouches faites main fixées sur le globe en verre et citation de Gabriel Garcia Marquez „La humanidad se divide en dos: Los que cagan bien y los que cagan mal.“ Livrée avec ampoule à coupole argentée, version 230 Volts avec ampoule à coupole argentée LED String. ■ Due edizioni limitate per l'anniversario della lampada Bulb. Piede in ottone, cristallo soffiato con testo inciso. Versione „Heart“, limitata a 88 esemplari, con il testo „The most beautiful light comes from the human heart.“ Versione „Fly“, limitata a 12 esemplari, con modelli di mosche realizzati a mano sul bulbo in vetro e la citazione di Gabriel Garcia Marquez „La humanidad se divide en dos: Los que cagan bien y los que cagan mal.“ Fornitura con lampadina a cupola argentata, versione 230 Volt con LED String lampadina a cupola argentata.

LED or Halogen E 27, max. 100 W, A++-E 200 cm

Campari Bar Raffaele Celentano 2013

Zehn originale Campari-Soda-Flaschen, einzeln abnehmbar; Kunststoff, Metall, Glas. Über den zehn Campari-Soda-Flaschen liegen Eiswürfel aus Glas, die das Licht brechen und reflektieren. Zugschalter an der Fassung.
 ■ Ten original Campari Soda bottles, individually detachable. Plastic, metal, glass. Above the ten Campari Soda bottles, ice cubes made of glass reflect the light. With pull switch. ■ Dix bouteilles originales de Campari Soda, détachables individuellement. Matière plastique, métal, verre. Au-dessus des dix bouteilles de Campari Soda sont posés des glaçons en verre, qui font refléter la lumière. Interrupteur au niveau de la douille. ■ Dieci bottiglie originali di Campari Soda, singolarmente staccabili. Materiale sintetico, metallo, vetro. Cubetti di ghiaccio in vetro posizionati sopra le bottiglie di Campari Soda, riflettono la luce. Portalamпада con interruttore a tirante.

LED or Halogen E 27, max. 60 W, EEC A++-E 250 cm

DeliriumYum Ingo Maurer/Sebastian Hepting 2006

Corian, Kristallglas, Spiegel aus Aluminium. Externer Transformator. Interner Motor. Licht und Bewegung des Wassers regulierbar. Tempo und Intervalle der Drehung werden elektronisch gesteuert und können angepasst werden. Mit Kugel, Silberpartikeln, Tabletten zur Wasseraufbereitung.
 ■ Corian, crystal glass, aluminium mirror. External transformer. Internal motor. Light and movement of water adjustable. Speed and intervals of the rotation are electronically adjustable. Complete with ball, silver particles, tablets for water preparation. ■ Corian, cristal, miroir en aluminium. Transformateur externe. Moteur interne. Lumière et mouvement d'eau réglables. Le rythme et l'intervalle de la rotation peuvent être réglés et changés électroniquement. Livrée avec balle, particules d'argent, pastilles pour préparation de l'eau. ■ Corian, cristallo, specchio in alluminio. Trasformatore esterno. Motore interno. Intensità della luce e movimento dell'acqua regolabili. La velocità e gli intervalli del movimento rotatorio sono a comando elettronico e possono essere adattati. Con sfera, polverina d'argento, pastiglie per la preparazione dell'acqua.

LED or Halogen GU4, max. 35 W, A++-E 300 cm

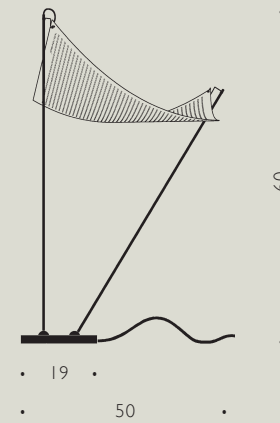
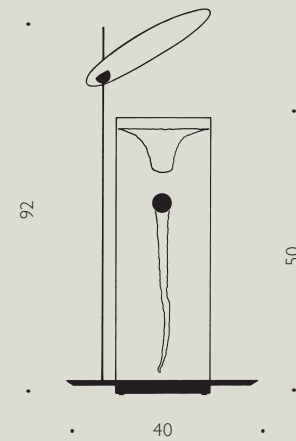

Dew Drops Table Ingo Maurer Team 2014

Transparente Kunststoffolie mit integrierten LEDs, Metall. Die Stäbe sind mit Kugelgelenken auf der Fußplatte (13 x 19 cm) montiert. Mit Sensorschalter zum Anschalten und Dimmen auf der Folie.
 ■ Transparent plastic sheet with integrated LEDs, metal. Two rods, adjustable via ball-joints mounted on the base (13 x 19 cm). With dimmable touch sensor switch on the sheet. ■ Film plastique transparent avec LEDs intégrés, métal. Les tiges sont montées grâce à une articulation à rotule sur la plaque (13 x 19 cm). Avec interrupteur à sensor tactile pour allumer et faire varier l'intensité de la lumière sur le film plastique. ■ Pellicola trasparente in materiale sintetico con LED integrati, metallo. Le due aste sono fissate alla base (13 x 19 cm) tramite giunti a sfera. Interruttore a sensore sulla pellicola stessa per accendere, spegnere e dimmerare.

LEDs dimmable, 23 W, 2600 lm, 3000 K, CRI 90, EEC A 100-240 V, EU or US 200 cm

Don Quixote Ingo Maurer und Team 1989

Stahl, Aluminium, elastischer Kunststoff. Don Quixote biegt und schwenkt sich, dreht und streckt sich.
 ■ Steel, aluminium, flexible plastic. Don Quixote bends, twists, turns and swivels. ■ Acier, aluminium, matière plastique élastique. Don Quixote s'incline et pivote, se tourne et s'étire. ■ Acciaio, alluminio, materiale sintetico elastico. Don Quixote s'inclina e si gira, ruota e si stende.

50 W Halogen, 910 lm, 3000 K, 2000 h, EEC C GY 6,35, max. 50 W, EEC B-E 230/125/12 V EU: Please check availability on our website.



Glatzkopf Table Ingo Maurer und Team 2017

Metall, Lampenschirm aus grünem, weißem oder schwarzem Karton, halb mattiertes Globe-Leuchtmittel Ø 12,5 cm. Neigung des Stabs variabel. Fußplatte mit drei Bohrungen in verschiedenen Winkeln. ■ Metal, paper shade in green, white or black, semi-frosted Globe bulb Ø 12,5 cm. Inclination of rod adjustable. Base plate with three openings in different angles. ■ Métal, abat-jour en cartonage vert, blanc ou noir, globe-ampoule semi-mat. Diamètre 12,5 cm. Inclinaison variable de la tige. Trois orifices dans le socle avec différents angles d'inclinaison. ■ Metallo, paralume in cartone verde, bianco o nero, lampadina Globe mezzo opacizzata diametro 12,5 cm. Inclinazione e lunghezza dell'asta variabili. Base con tre fori per inclinazioni differenti.

💡 LED not dimmable 2700 K, 600 lm, 6 W, 15000 h, CRI 85, EEC A+ Ø 12,5 cm
⚡ 200–240 V 🌀 E 27, max. 30 W 📏 200 cm



ca. 60

Grasl Jan Roth 1973

Reflektor aus glanzeloxiertem Aluminium und Messing. Transparentes Kabel mit Schalter und Stecker. Auch als Hängelampe. ■ Reflector: anodized aluminium, brass. Transparent cable with switch and plug. Also available as hanging lamp. ■ Réflecteur en aluminium électrolysé et laiton. Câble transparente avec interrupteur et prise de courant. Egalement disponible comme suspension. ■ Riflettore in alluminio anodizzato e ottone. Cavo trasparente con interruttore e spina. Disponibile anche nella versione a sospensione.

💡 LED or Halogen 🌀 E14, max. 40 W, A+–E 📏 400 cm



ca. 50

ca. 40

I Ricchi Poveri – Bzzzz Ingo Maurer 2014

Libelle aus eloxiertem Aluminium in Rot, Blau oder Grün. Stahl, Messing, Niedervolt-Halogen-Glühlampe. ■ Dragonfly made of anodised aluminium in red, blue or green. Steel, brass, low-voltage halogen bulb. ■ Libellule en aluminium anodisé en rouge, bleu ou vert. Acier, laiton. Ampoule halogène à bas voltage. ■ Libellula in alluminio anodizzato in rosso, blu o verde. Acciaio, ottone, lampadina alogena a basso voltaggio.

💡 35 W Halogen, 600 lm, 2000 h, CRI 100, EEC C 🌀 E27, A+–E
🔋 230/125/24 V 📏 300 cm

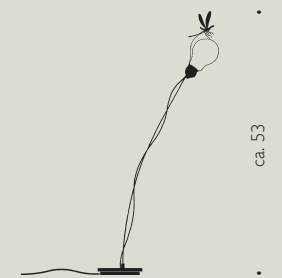

ca. 53

14

I Ricchi Poveri – Five Butterflies Ingo Maurer 2014

Limitierte Auflage, 200 Stück. Fünf handgefertigte Insektenmodelle, Stahl, Messing, Niedervolt-Halogen-Glühlampe. ■ Limited edition of 200 pieces. Five hand-made insect models, steel, brass, low-voltage halogen bulb. ■ Edition limitée à 200 pièces. Cinq modèles en insectes faits main, acier, laiton. Ampoule halogène à bas voltage. ■ Edizione limitata a 200 pezzi. Cinque modelli di insetti realizzati a mano, acciaio, ottone, lampadina alogena a basso voltaggio.

💡 35 W Halogen, 600 lm, 2000 h, CRI 100, EEC C 🌀 E27, A+–E
🔋 230/125/24 V 📏 200 cm

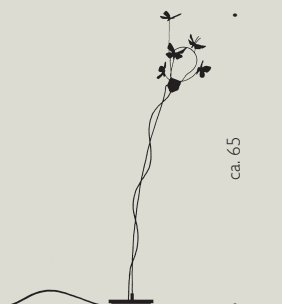

ca. 65

10

I Ricchi Poveri – Fly Ingo Maurer 2014

Limitierte Auflage, 100 Stück. Stahl, handgefertigtes Fliegenmodell. Das LED-Leuchtmittel ist stufenlos dimmbar durch einem Touch-Sensor in der Fußplatte. Beim Dimmen ändert sich die Lichtfarbe wie bei einer Halogen-Glühlampe. Das Leuchtmittel wird exklusiv für Ingo Maurer hergestellt. ■ Limited edition of 100 pieces. Steel, hand-made model of a fly. Continuously dimmable with a touch sensor on the base plate. The colour temperature changes from white to a warm red when dimmed down, just as a halogen bulb does. The LED bulb is produced exclusively for Ingo Maurer GmbH. ■ Edition limitée à 100 pièces. Acier, modèle de mouche fait main, ampoule LED. Avec interrupteur à sensor tactile pour allumer et faire varier l'intensité de la lumière sur la base en réglage continu. En faisant varier l'intensité lumineuse, la couleur de la lumière change, comme si on utilisait une ampoule halogène. L'ampoule LED est spécialement produit pour la société Ingo Maurer GmbH. ■ Edizione limitata a 100 pezzi. Acciaio, modello di mosca realizzato a mano, lampadina LED. Base sensoriale per accendere, spegnere e dimmerare (regolazione continua dell'intensità luminosa). Variando l'intensità luminosa della lampada, come per le lampadine alogene, cambia anche la tonalità di colore della luce. La lampadina LED è una produzione esclusiva per la Ingo Maurer GmbH.

💡 LED dimmable, 3 W, 120 lm, 2500-2900 K, CRI 95, EEC A 📏 100–240 V/19 V 📏 250 cm



9,5

25

I Ricchi Poveri – Monument for a Bulb Ingo Maurer 2014

Acht Figuren aus Neusilber, Stahl, Messing, Niedervolt-Halogen-Glühlampe. ■ Eight figures in nickel silver, steel, brass, low-voltage halogen bulb. ■ Huit figurines en maillechort, acier, laiton. Ampoule halogène à bas voltage. ■ Otto figure in alpacca, acciaio, ottone, lampadina alogena a basso voltaggio.

💡 35 W Halogen, 600 lm, 2000 h, CRI 100, EEC C 🌀 E27, A+–E
🔋 230/125/24 V 📏 300 cm

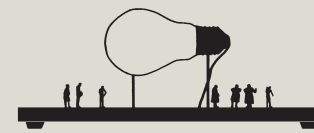

12

25

I Ricchi Poveri – Toto Ingo Maurer 2014

Stahl, Kappe aus lackiertem Messing in Schwarz, Rot, Weiß oder Messing, Niedervolt-Halogen-Glühlampe. ■ Steel, hood made of lacquered brass in black, red, white or brass, low-voltage halogen bulb. ■ Acier, capuchon en laiton laqué en noir, rouge, blanc ou laiton, ampoule halogène à bas voltage. ■ Acciaio, cappello in ottone laccato in nero, rosso, bianco o ottone, lampadina alogena a basso voltaggio.

💡 35 W Halogen, 600 lm, 2000 h, CRI 100, EEC C 🌀 E27, A+–E
🔋 230/125/24 V 📏 300 cm

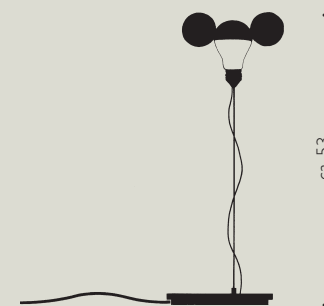

ca. 53

14

Jetzt² Axel Schmid 2009/2015

Eloxiertes Aluminium in Schwarz, Blau oder Silber, Kunststoff. Mit Sensorschalter zum Anschalten und stufenlosen Dimmen. ■ Anodized aluminium in black, blue or silver, plastic. With dimmable touch sensor switch. ■ Aluminium anodisé disponible en noir, bleu ou argent, matière plastique. Avec interrupteur à sensor tactile pour allumer et faire varier l'intensité de la lumière. ■ Alluminio anodizzato in nero, blu o argento, materiale sintetico. Interruttore a sensore per accendere, spegnere e dimmerare

💡 LED dimmable, 6 W, 3000 K, 470 lm, CRI 90, EEC A+ 📏 100–240 V/5 V 📏 200 cm



40

30

Keep Balance Ingo Maurer 2016

Metall, Kunststoff. Um 360° drehbar. Das ringförmige Gelenk ermöglicht die variable Neigung des waagrechten Metallstabs. Auch der Kopf mit integrierter LED ist einstellbar. Mit Dimmschalter am Kabel. ■ Metal, plastic. rotatable through 360°. A joint in the shape of a ring allows adjusting the angle of the horizontal rod. The lamp head with integrated LED is also adjustable. Dimmer switch on the cable. ■ Métal, plastique. Rotative à 360°. L'articulation en forme d'anneau permet une inclinaison variable de la tige en métal horizontalement. La tête avec LED intégrés est aussi réglable. Avec variateur au niveau du câble. ■ Metallo, materiale sintetico. Rotante di 360°. Il giunto anulare consente l'inclinazione variabile dell'asta in metallo orizzontale. Anche la testa con LED integrato è regolabile. Con interruttore dimmer sul cavo.

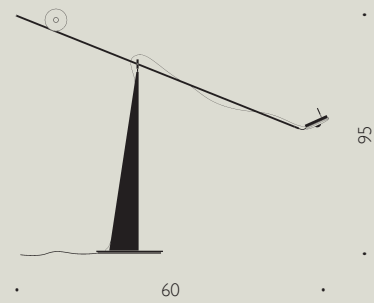

LED dimmable, 9 W, 970 lm, 2700 K, CRI >90, EEC A+ 100–240 V 250 cm

Knot 1 / Knot 2 Ingo Maurer 2013

Limitierte Produktion. Polyamid, Aluminium. Der Knoten wird in einem 3D-Druckverfahren einzeln hergestellt. Knot 1 und 3 haben einen Fuß aus Stahl. ■ Limited production. Polyamide, aluminium. Made in three-dimensional printing technology. Knot 1 and 3 have a lamp base made of steel. ■ Production limitée. Polyamide, aluminium. Chaque Knot est conçu individuellement grâce au procédé d'imprimerie 3D. Knot 1 et 3 ont une base de lampe en acier. ■ Produzione limitata. Poliamide, alluminio. Ogni nodo viene prodotto singolarmente con un procedimento di stampa 3D. Knot 1 e 3 hanno una base di acciaio.

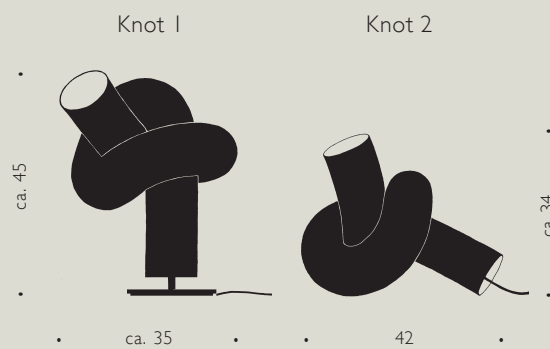

14,6 W LED, 1350 lm, 3000 K, CRI 80, EEC A 100–240 V 250 cm

Koyoo Axel Schmid 2018

Eloxiertes Aluminium, Metall, Papier. Aufladbar. Mit 3000 mAh LiPo Akku und USB-Kabel, Typ C und Ladegerät. ■ Anodised aluminium, metal, paper. Chargeable, with 3000 mAh LiPo battery, Type C USB cable and charging device. ■ Aluminium anodisé, métal, papier. Rechargeable. Avec batteries 3000 mAh LiPo et câble USB, type C et chargeur. ■ Alluminio anodizzato, metallo, carta. Ricaricabile. Con batteria 3000 mAh LiPo e cavo USB, tipo C e caricatore.

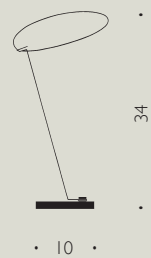

2,2 W LED, 240 lm, 3000 K, CRI >90, with 3000 mAh LiPo battery, USB Type C cable, 5 V

Lampampe Ingo Maurer 1980

Japanisches Papier, Metall. Als gewolltes gestalterisches Element ist das Papier von Lampampe verknittert. Nicht geeignet für Räume mit hoher Luftfeuchtigkeit. ■ Japanese paper, metal. The paper of Lampampe is crinkled. This is an intended design attribute. Not suited for rooms with high humidity. ■ Papier japonais, métal. Le papier pour Lampampe est froissé, ainsi voulu comme effet de style. N'est pas appropriée pour des pièces avec un fort taux humidité. ■ Carta giapponese, metallo. Una caratteristica voluta del design di Lampampe è l'effetto sgualcito della carta. Non adatta all'uso in ambienti ad alta umidità.

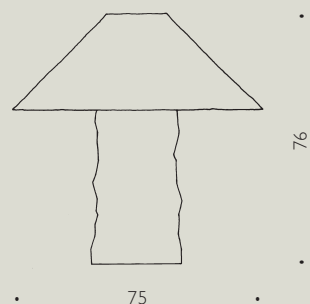

LED or Halogen E27, max. 100 W, A++–E 200/450 cm white

LED's Oskar Ingo Maurer und Team 2012

Eloxiertes Aluminium in Schwarz oder Silber, Metall. Ein flexibler Metallarm ermöglicht die variable Einstellung des Kopfes. Elektronischer Sicherheitstransformator mit integriertem Kippschalter. ■ Anodised aluminium in black or silver, metal. The flexible metal arm allows variable adjustment of the lamp head. Electronic safety transformer with integrated toggle switch. ■ Aluminium anodisé noir ou argent, métal. Le bras métallique flexible permet le réglage variable du réflecteur. Transformateur électronique de sécurité avec interrupteur à bascule intégré. ■ Alluminio anodizzato nero o argento, metallo. Il braccio metallico flessibile permette la regolazione variabile del riflettore. Trasformatore di sicurezza elettronico con interruttore a levetta integrato.

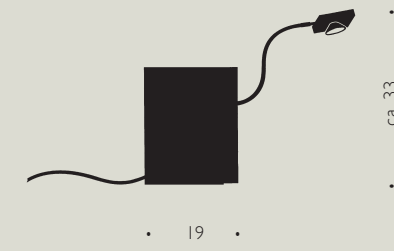

5 W, LED, 420 lm, 3000 K, 40000 h, CRI 80, EEC A 100–240 V 400 cm

Light Structure / Light Structure Three

Peter Hamburger, Ingo Maurer 1970/2013

Plexiglas, Acryl, Aluminium. Sechs oder drei Röhren, von Kabeln in Spannung gehalten. Tischversion: Schnurtrafo mit Drehdimmer. Hängeversion: mit integriertem Transformator; dimmbar. Die LED-Röhren, Ø 2,5 cm, können nicht als Ersatzteil für die frühere Version der Light Structure (1970) verwendet werden. ■ Plexiglass, acrylic, aluminium. Six or three tubes, connected and held in tension by insulated wires. Table version: with continuously rotating transformer-dimmer. Hanging version: with integrated transformer, dimmable. The LED tubes, Ø 2,5 cm, can not be used as spare part for the former version of Light Structure (1970). ■ Plexiglas, acrylique, aluminium. Six ou trois tubes, connectés et tenues en tension aux câbles. Version pour table: avec transformateur à cordon avec variateur à rotation. Version pour suspension: avec transformateur intégré, dimmable. Les tubes LED, Ø 2,5 cm, ne peuvent pas être usés comme pièce de rechange pour la version originale de Light Structure (1970). ■ Plexiglas, acrilico, alluminio. Sei o tre tubi collegati e tenuti in tensione da cavi isolati. Versione da tavolo: con trasformatore su cavo con dimmer a anopola rotante. Versione a sospensione: con trasformatore integrato, dimmerabile. I tubi LED, Ø 2,5 cm, non possono essere usati come pezzo di ricambio per la versione originale di Light Structure (1970).

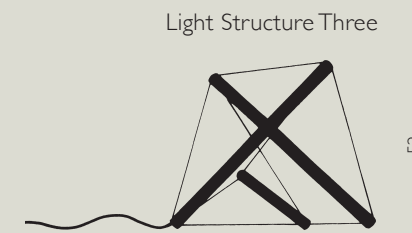
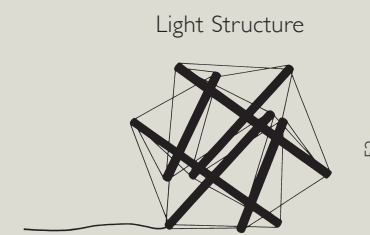

12 or 6 LEDs dimmable, each 3,4 W, 1320 or 660 lm, 2700 K, CRI 80, EEC A

110–240 V/40 V 250 cm

Looksoflat Stefan Geisbauer 2010

Aluminium. Schalter am Leuchtenkopf. Erhältlich in Aluminium natur oder Schwarz. Mit Steckernetzteil. ■ Aluminium. Toggle switch integrated in lamp head. Colour aluminium or black. Plug with integrated power supply. ■ Aluminium. Interrupteur à bascule intégré à la tête de la lampe. Couleur aluminium ou noir. Avec ballast électronique. ■ Alluminio. Interruttore integrato nella testa della lampada. Colore alluminio o nero. Con alimentatore.

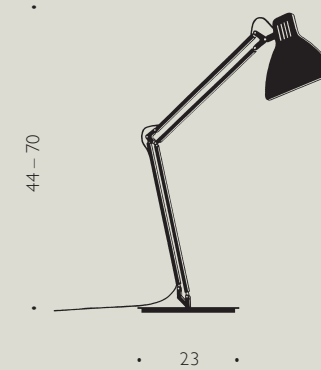

2 x 6,5 W LED, 1040 lm, 3000 K, CRI 90, EEC A 100–240 V 200 cm

Lucellino LED TRI-R Ingo Maurer 2015

Messing, Glas, Kunststoff, handgefertigte Flügel aus Gänsefedern. Das LED-Leuchtmittel ist stufenlos dimmbar durch einen Sensor in der Fußplatte. Beim Dimmen ändert sich die Lichtfarbe wie bei einer Halogenglühlampe. Das Leuchtmittel wird exklusiv für Ingo Maurer hergestellt. ■ Glass, brass, plastic, hand-crafted goose-feather wings. Continuously dimmable with a touch sensor on the base plate. The colour temperature changes from white to a warm red when dimmed down, just as a halogen bulb does. The LED bulb is produced exclusively for Ingo Maurer GmbH. ■ Verre, laiton, matière plastique, ailes confectionnées à la main en plumes d'oie. Avec interrupteur à sensor tactile pour allumer et faire varier l'intensité de la lumière sur la base en réglage continu. En faisant varier l'intensité lumineuse, la couleur de la lumière change, comme si on utilisait une ampoule halogène. L'ampoule LED est spécialement produit pour la société Ingo Maurer GmbH ■ Vetro, ottone, materiale sintetico, ali in piume d'oca lavorate a mano. Base sensoriale per accendere, spegnere e dimmerare (regolazione continua dell'intensità luminosa). Variando l'intensità luminosa della lampada, come per le lampadine alogene, cambia anche la tonalità di colore della luce. La lampadina LED è una produzione esclusiva per la Ingo Maurer GmbH.

☑ LED dimmable, 3 W, 120 lm, 2500–2900 K, CRI 95, EEC A

⚡ 100–240 V EU or US 📏 250 cm

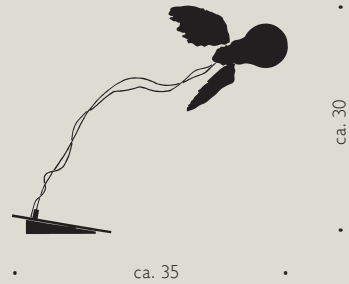

ca. 35

ca. 30

Lucellino Table Ingo Maurer 1992

Glas, Messing, Kunststoff, handgefertigte Flügel aus Gänsefedern. Lieferung mit Ersatzglühlampe. Nicht geeignet für Räume mit hoher Luftfeuchtigkeit. ■ Glass, brass, plastic, hand-crafted goosefeather wings. Complete with spare bulb. Not suited for rooms with high humidity. ■ Verre, laiton, matière plastique, ailes confectionnées à la main en plumes d'oie. Livrée avec une ampoule de rechange. N'est pas appropriée pour des pièces avec un fort taux humidité. ■ Vetro, ottone, materiale sintetico, ali in piume d'oca lavorate a mano. Fornita con lampadina di ricambio. Non adatta all'uso in ambienti ad alta umidità.

💡 35 W Halogen, 600 lm, 2000 h, CRI 100, EEC C 📏 E27, A+–E

🔋 230/125/24 V 📏 300 cm

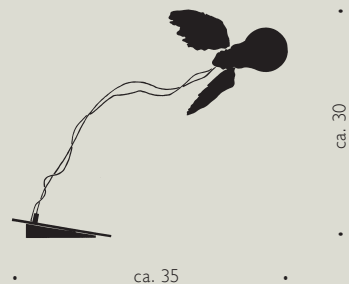

ca. 35

ca. 30

Max. Kugler Ingo Maurer und Team 2001/2015

Edelstahl, Aluminium. Das Kugelgelenk ermöglicht stufenloses Drehen und Neigen in alle Richtungen. Der Teleskoparm ist von 60 auf 90 cm ausziehbar. An seinem Griff ist der Reflektor in alle Richtungen schwenkbar. Auch mit schwarzen Reflektor erhältlich. Dimmschalter am Kabel. ■ Stainless steel, aluminium. The ball-joint makes it possible to turn and tilt the lamp in all directions. The telescope arm extends from 60 to 90 cm. The reflector (with handle) can be swivelled in any direction. Also available with reflector in black. Dimmer switch in the cable. ■ Acier inoxydable, aluminium. L'articulation à rotule permet de tourner et d'incliner la lampe sans graduation dans tous les sens. Le bras télescopique est extensible de 60 à 90 cm. Le réflecteur est orientable dans tous les sens grâce à sa poignée. Aussi disponible avec réflecteur en noir. Variateur à câble. ■ Acciaio inossidabile, alluminio. Ruotabile e inclinabile in continuo in tutte le direzioni mediante un giunto sferico. Il braccio telescopico è allungabile da 60 a 90 cm. Agendo sulla leva, il riflettore può essere regolato in tutte le direzioni. Anche disponibile con riflettore in nero. Dimmer a cavo.

☑ LED dimmable, 15 W, 1300 lm, 3000 K, CRI 90, EEC A+

⚡ 220–240 V / 110–125 V 📏 175 cm



17

ca. 60–90

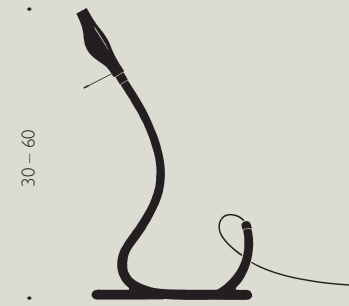

36–70

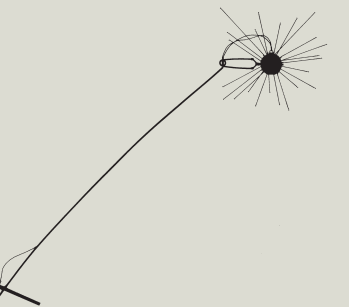

80

max. 80

Metall T. Cooper Ingo Maurer und Team 2009

Metall, Kunststoff, Kabel mit Schalter. Reflektor 360° um das Leuchtmittel drehbar. ■ Metal, plastic, cable with switch. Reflector rotates through 360° around the bulb. ■ Métal, matière plastique, câble avec interrupteur. Réflecteur rotatif de 360° autour de l'ampoule. ■ Metallo, materiale sintetico, cavo con interruttore. Riflettore rotante di 360° intorno alla lampadina.

💡 40 W Halogen, 490 lm, 2700 K, 2000 h, EEC D 📏 G9, max. 40 W, A+–E 📏 200 cm
EU: Please check availability on our website.

Mozzkito Ingo Maurer und Team 1996

Metall, Kunststoff und Gummi. Die Neigung der Lampe kann durch die bewegliche Bodenplatte verändert werden. Reflektor verstellbar. ■ Metal, plastic and rubber. Position can be modified with movable base-plate. Adjustable reflector. ■ Métal, matière plastique et caoutchouc. La plaque de base mobile permet de varier l'inclinaison de la lampe. Réflecteur réglable. ■ Metallo, materiale sintetico e gomma. La piastra di base mobile consente di variare l'inclinazione della lampada. Riflettore regolabile.

💡 LED or Halogen 📏 GU 5,3, max. 50 W, A+–E 📏 230/125/12 V 📏 350 cm

My New Flame Moritz Waldemeyer, Ingo Maurer und Team 2013

Platine, Metall, Kunststoff. Basierend auf Videomaterial, geben die zwei LED Displays das leichte Flackern einer Flamme realistisch und faszinierend wieder. Dimmbar. Mit Schalter im Fuß und USB-Kabel in Schwarz, 150 cm. Betrieben mit 4 AA/Mignon NiMH-Akkus, jeweils max. 1,2 Volt (nicht im Lieferumfang enthalten) oder über das USB-Kabel. ■ Circuit board, metal, plastic. Based on video material, the two LED displays render a flickering candle flame in a realistic and captivating way. Dimmable. On/Off switch in base plate. With black USB cable, 150 cm. Powered by 4 AA/Mignon NiMH rechargeable batteries, max. 1.2 V each (not included) or via the USB cable. ■ Platine, métal, plastique. Les deux écrans LED programmés sur la base d'un clip video, rendent le léger vacillement d'une flamme réaliste et fascinant. Dimmable. Interrupteur sur le pied. Avec câble USB noir, longueur 150 cm. Fonctionne avec 4 piles AA/Mignon NiMH rechargeables, de chacune maximal 1,2 volts (piles non fournies). ■ Circuito stampato, metallo, materiale sintetico. Programmati in base a un filmato, i schermi LED riproducono in modo realistico e affascinante l'effetto fiamma di una vera candela. Dimmerabile. Interruttore nella base. Con cavo USB in nero, lunghezza 150 cm. Funzionamento con 4 accumulatori AA/Mignon NiMH, max. 1,2 volt ciascuno (non compresi nella fornitura).

☑ 2 x 128 LED dimmable, 5 V, 0,6 W, 2700 K, CRI 80 📏 150 cm USB black

OH•LED•ONE Ingo Maurer 2015

Glas, Edelstahl, Kunststoff. Oled Modul von LG Chem. Die Neigung der Lampe lässt sich über das Kugelgelenk am Fuß stufenlos einstellen. ■ Glass, stainless steel, plastic. OLED module by LG Chem. The angle of the lamp is freely adjustable by the ball-and-socket joint in the base. ■ Verre, acier inoxydable, matière plastique. Module OLED de LG Chem. L'inclinaison de la lampe est réglable sans graduation par l'articulation à rotule au niveau du socle. ■ Vetro, acciaio inossidabile, materiale sintetico. Modulo OLED di LG Chem. L'inclinazione della lampada può essere regolata mediante un giunto a sfera.

☑ OLED, 7 W, 500 lm, 3000 K, CRI 90 ⚡ 100–240 V 📏 250 cm



40

9

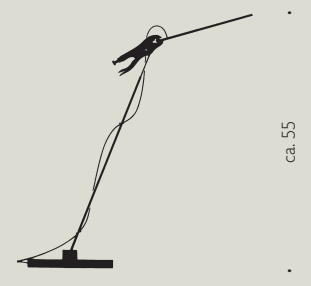

ca. 55

ca. 29

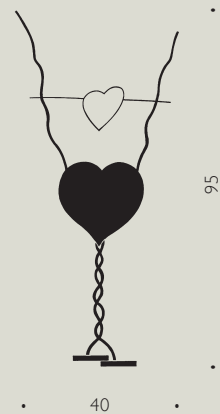

One From The Heart Ingo Maurer 1989

Metall, beweglicher Glas-Spiegel und Kunststoff. Multi Mirror-Reflektor mit Schutzglas. ■ Metal, plastic, adjustable glass mirror. Multi-Mirror reflector with protective glass cover. ■ Métal, miroir mobile en verre et matière plastique. Réflecteur Multi Mirror avec verre protecteur. ■ Metallo, specchio orientabile in vetro e materiale sintetico. Riflettore Multi Mirror con vetro di protezione

💡 LED or Halogen 🌀 GX 5,3, max. 50 W, A++-E 📏 250 cm
 EU: The halogen version is a phase-out model, please check our website for up-to-date info and technical details of the new LED version.

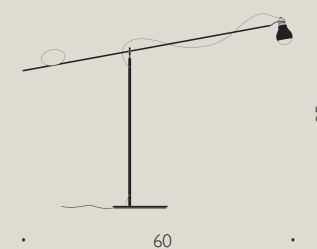
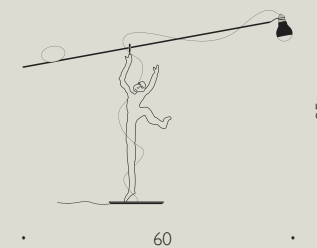

Ru Ku Ku Ingo Maurer 2016

Metall, Glas, Kunststoff, Silikon. Um 360° drehbar. Mit Figur in Weiß oder vertikalem Metallstab. Das ringförmige Gelenk ermöglicht die variable Neigung des waagrechten Metallstabs. ■ Metal, glass, plastic, silicone. Rotatable through 360°. With figure in White or with a vertical metal rod. A joint in the shape of a ring allows adjusting the angle of the horizontal rod. ■ Métal, verre, plastique, silicone. Rotative à 360°. Avec figurines blanches ou tige en métal verticale. L'articulation en forme d'anneau permet une inclinaison variable de la tige en métal horizontalement. ■ Metallo, vetro, materiale sintetico, silicone. Rotante di 360°. Con figura in bianco oppure asta metallica verticale. Il giunto anulare consente l'inclinazione variabile dell'asta din metallo orizzontale.

💡 60 W Halogen, 970 lm, 2700 K, CRI 100, EEC D 🌀 E27, A+-E
 📏 230/125/24 V 📏 300 cm



Seven Rats Ingo Maurer und Team 2007

Stahl, Gold, Messing, Kunststoff. Vier schwarze und drei weiße Kunststoffratten. ■ Steel, gold, brass, plastic. Four black and three white plastic rats. ■ Acier, or, laiton, matière plastique. Quatre rats noirs et trois rats blancs en matière plastique. ■ Acciaio, oro, ottone, materiale sintetico. Quattro topi neri e tre topi bianchi di materiale sintetico.

💡 LED or Halogen 🌀 GU 5,3, max. 50 W, A++-E 📏 350 cm

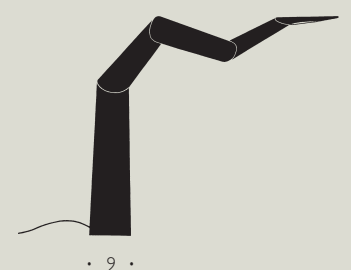

Spyre Ron Arad for Ingo Maurer 2016

Limitierte Auflage, 50 Stück. Stahl, Aluminium, Kunststoff, mattweiß lackiert. Fünf Segmente, die individuell gedreht werden können, um das Licht auszurichten. Mit Ein-/Aus-Sensor. ■ Limited edition of 50 pieces. Steel, aluminium, plastics mat white lacquered. Five segments, each individually rotatable and adjustable. With integrated On/Off sensor. ■ Edition limitée à 50 pièces. Acier, aluminium, plastique, verni blanc mat. L'objet est composé de cinq segments, pouvant être tournés individuellement pour orienter la lumière. Avec capteur on/off. ■ Edizione limitata a 50 pezzi. Acciaio, alluminio, materiale sintetico, vernice bianca opaca. L'oggetto luminoso è composto da cinque segmenti, orientabili e ruotabili singolarmente, che consentono di dirigere la luce in qualsiasi direzione. Con sensore on/off.

🔘 LED dimmable, 6,5 W, 1040 lm, 2700 K, CRI >90, EEC A+ 📏 100-250 V



Veramente al Dente Ingo Maurer und Team 2010/2013

Sonderanfertigung. Porzellan, Metall, Kunststoff. Jedes Objekt ist anders geformt. ■ Limited production. Porcelain, metal, plastic. Each object has a unique shape. ■ Production limitée. Porcelaine, métal, matière plastique. Chaque pièce est unique. ■ Produzione limitata. Porcellana, metallo, materiale sintetico. Ogni oggetto ha una forma diversa.

🔘 3 x 4 W LED, 350 lm, 2700 K, CRI 90

Oskar Ingo Maurer 1998

Metall, eloxiertes Aluminium, Reflektor mit Schutzglas. Transformator mit integriertem Kippschalter. Ein flexibler Metallarm ermöglicht die variable Einstellung des Reflektors. ■ Metal, anodized aluminium, reflector with protective glass cover. Transformer with integrated toggle switch. A flexible metal arm allows variable adjustment of the reflector. ■ Métal, aluminium anodisé, réflecteur avec verre protecteur. Transformateur avec interrupteur à bascule intégré. Un bras métallique flexible permet le réglage variable du réflecteur. ■ Metallo, alluminio anodizzato, riflettore con vetro di protezione. Trasformatore con interruttore a levetta integrato. Un flessibile braccio metallico permette la regolazione variabile del riflettore.

💡 35 W Halogen, 860 lm, 2900 K, 4000 h, EEC B 🌀 GY 6,35, max. 50 W, EEC B-E
 📏 230/125/12 V 📏 400 cm EU: Please check availability on our website.

Ringelpiez Table Ingo Maurer und Team 2017

Der Ring aus Aluminium mit LEDs ist als Up- oder Downlight nutzbar. Winkel und Ausrichtung des Rings ohne Werkzeug verstellbar. Stab aus Kohlefaser, nicht ausziehbar. LED-Ring in Schwarz, mit Papierschirm Frivoloso in Grün oder Weiß. ■ The aluminium ring with LEDs can be fixed as up- or downlight. The angle and orientation of the ring are adjustable without tools. The extendable rod in carbon fiber can be fixed vertically or at an angle of 15° in the base. LED ring in Black, papershade Frivoloso in Green or White. ■ L'anneau en aluminium équipé de LEDs est utilisable en Up- ou Downlight. L'angle et l'orientation de l'anneau ajustables sans outils. La tige en fibre de carbone, non télescopique. Anneau LED en noir, avec écran papier Frivoloso vert ou blanc. ■ L'anello in alluminio con LED può essere impiegato come uplight o downlight. Semplice regolazione senza necessità di attrezzi dell'angolo e dell'orientamento dell'anello. Asta telescopica in fibra di carbonio, non estraibile. Anello a LED disponibile in nero o bianco.

🔘 LED dimmable, 25 W, 3600 lm, 3000 K, CRI 95, EEC A+ 📏 100-240 V 📏 250 cm

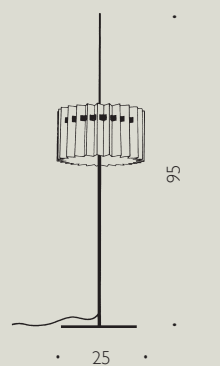
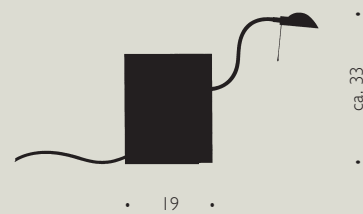

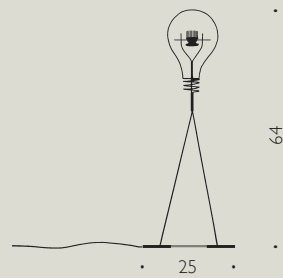

Walking Bulb Michel Sempels 2015

Edelstahl, Messing, Aluminium, Kunststoff. Der LED-Spot ist um 360° drehbar. ■ Stainless steel, brass, aluminium, plastic. The LED spot swivels through 360° on an horizontal axis. ■ Acier spécial, aluminium, laiton, matière plastique. Le Spot LED est rotatif à 360°. ■ Ottone, acciaio inossidabile, alluminio, materiale sintetico. Rotazione orizzontale 360°.

LED, 4 W, 350 lm, 3000 K, CRI 90, EEC A+ 100–240 V (EU or US) USB/5V 300 cm

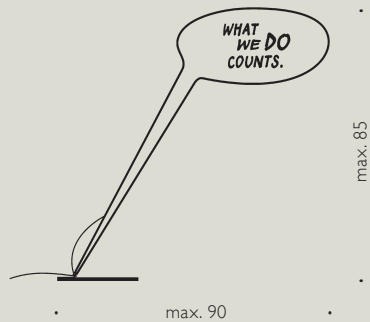

What We Do Counts Ingo Maurer 2015

Aluminium, Stahl. Die Sprechblase mit den integrierten LEDs ist in der Fußplatte um 360° drehbar und kann an einem Stab höher eingestellt werden. ■ Aluminium, steel. The speech bubble with integrated LED rotates through 360° and can be positioned higher. ■ Aluminium, acier. La bulle avec les LEDs intégrés pivote dans le pied de la lampe sur un rayon de 360° et peut être fixée sur une tige plus vers le haut, à votre convenance. ■ Alluminio, acciaio. Il balloon con i moduli LED integrati ruota di 360° e può essere variato in altezza.

LED, 2 x 6 W, 1040 lm, 3000 K, CRI 90, EEC A+ 100–240 V 200 cm

Zufall T Ingo Maurer und Team 2008

Silikon, schwarzes Corian, Aluminium. Der Silikonarm kann flexibel geformt werden. Eingebauter Kippschalter im Lampenfuß. Mit Steckertransformator. ■ Silicone, black Corian, aluminium. The silicone arm can be formed flexibly. Base plate with integrated toggle switch. With transformer. ■ Silicone, Corian noir, aluminium. La forme du tuyau flexible en silicone peut être modifiée. Plaque de base avec interrupteur à bascule intégré. Livrée avec transformateur. ■ Silicone, Corian nero, alluminio. Il braccio in silicone flessibile può essere modellato a piacere. Piastra di base con interruttore a levetta. Con trasformatore.

LED, 5 W, 420 lm, 3000 K, CRI 80 100–240 V, EU or US 200 cm



Stehlampen
Lampadaires
Lampade a stelo

FLOOR LAMPS 217

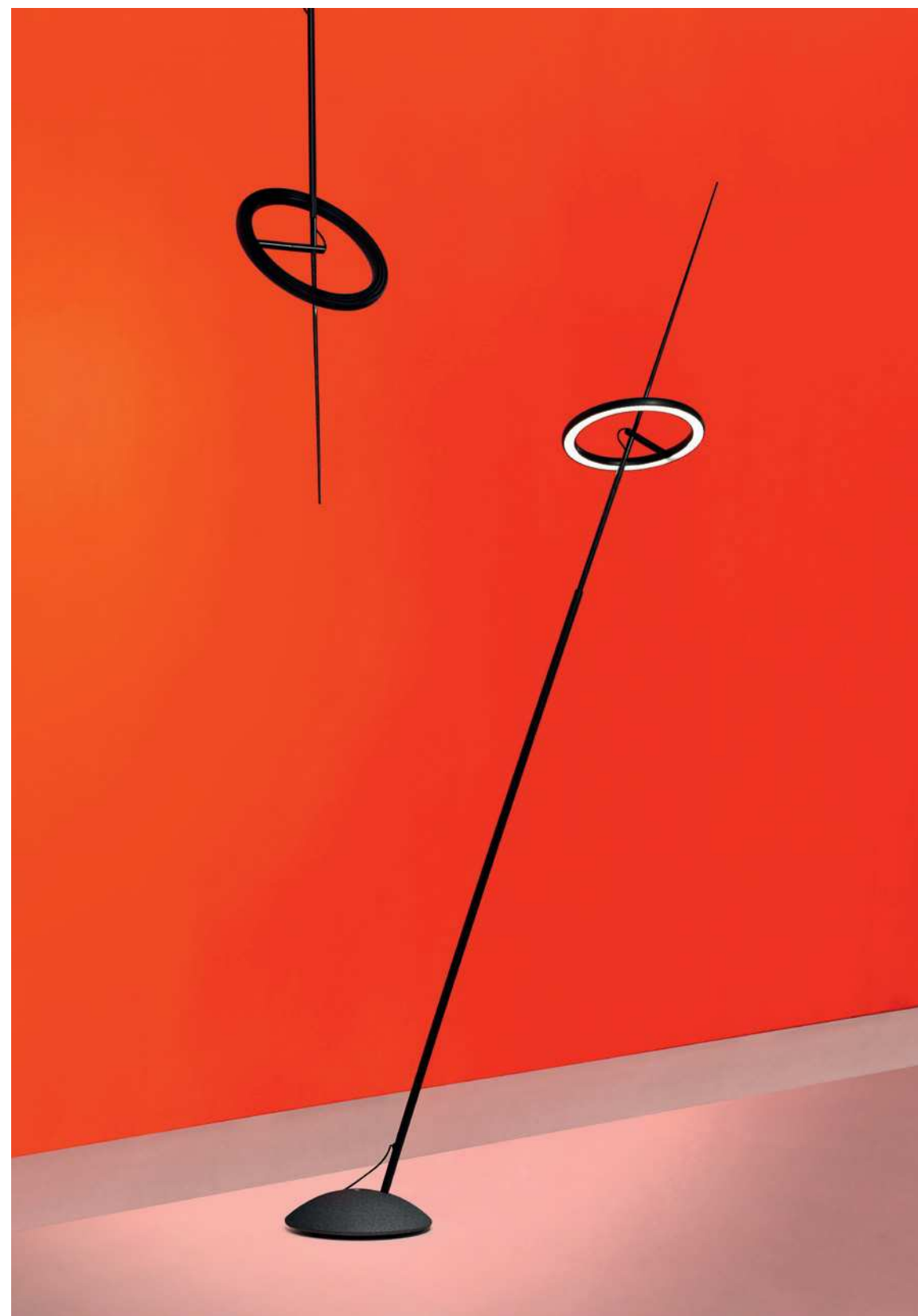

RINGELPIEZ



Watch the video [▶ ingo-maurer.com](https://www.ingo-maurer.com)

RINGELPIEZ and Flying Discs at our showroom in Munich





GLATZKOPF FLOOR also as table version

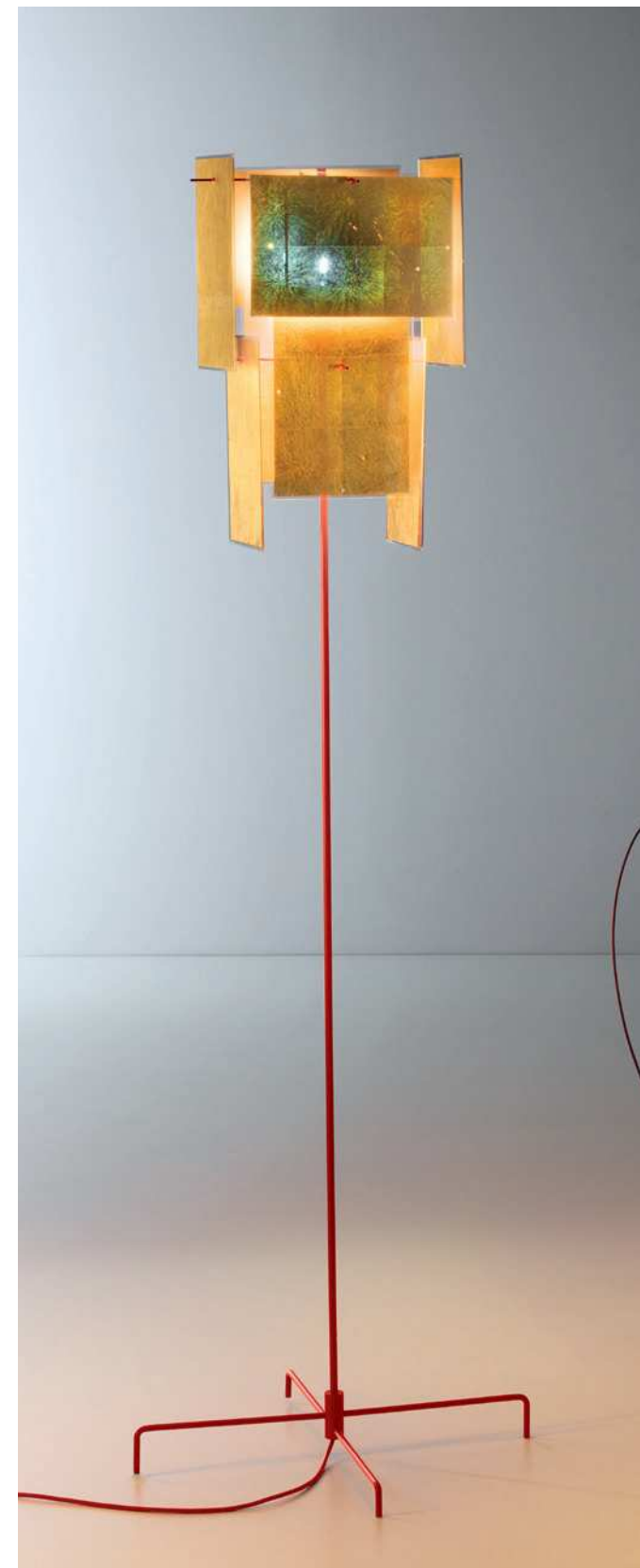

24 KARAT BLAU FLOOR

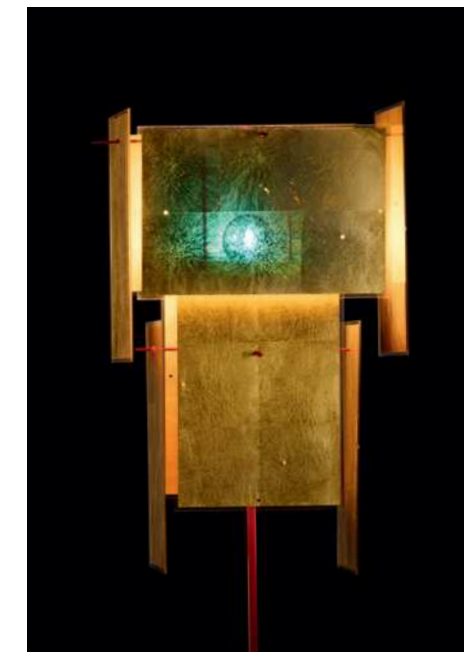

Also as table and hanging version

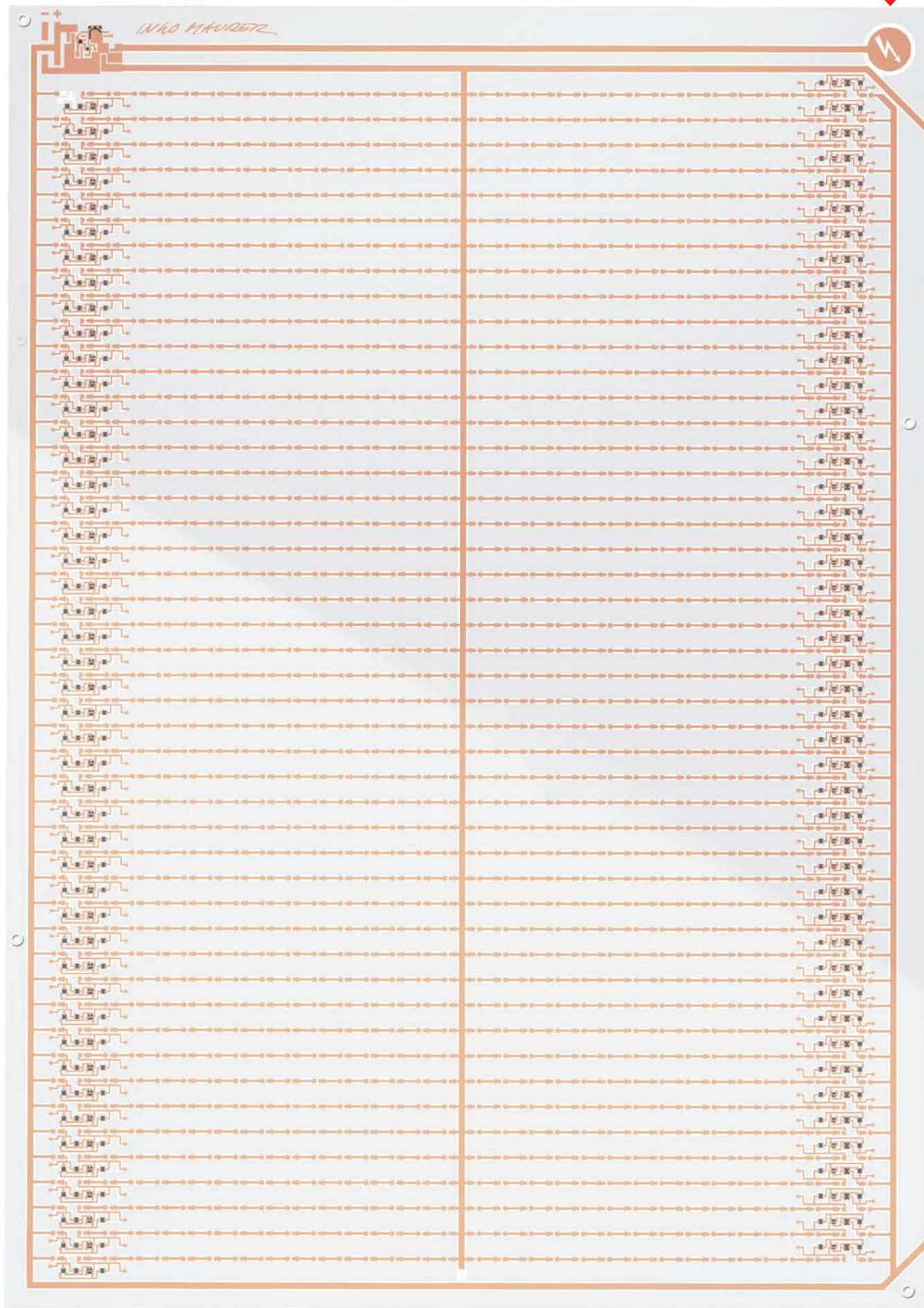

turn me on here
 turn me off here



As fresh as
 morning dew
 distill'd on flowers ...
 A sophisticated
 technological
 development
 is the base for
 DEW DROPS.
 Shakespeare
 missed that.
 A pity!

DEW DROPS FLOOR



ALIZZ F. COOPER



METALL F. COOPER



BASTARDO



Freedom, esthetical provocation: that's Bernhard Dessecker's Bastardo.

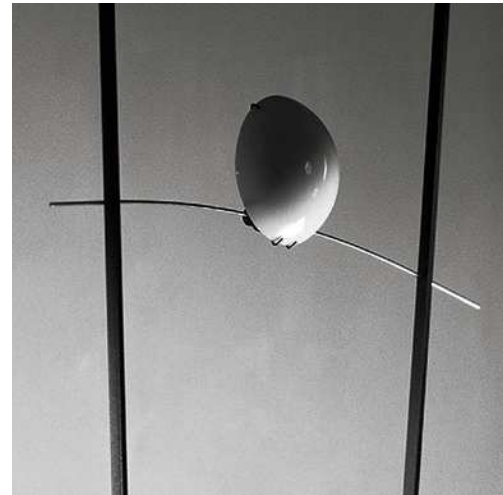

230

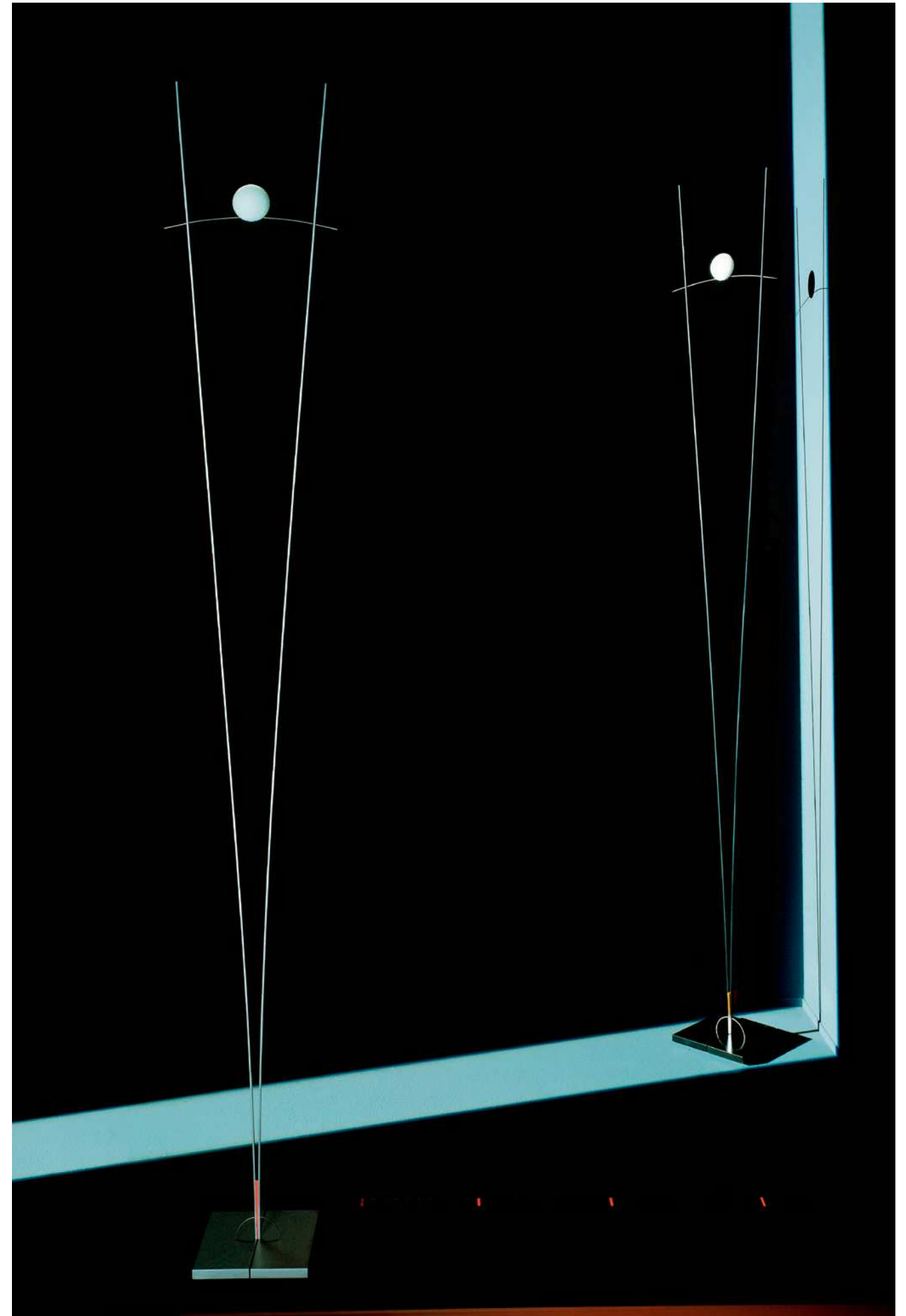
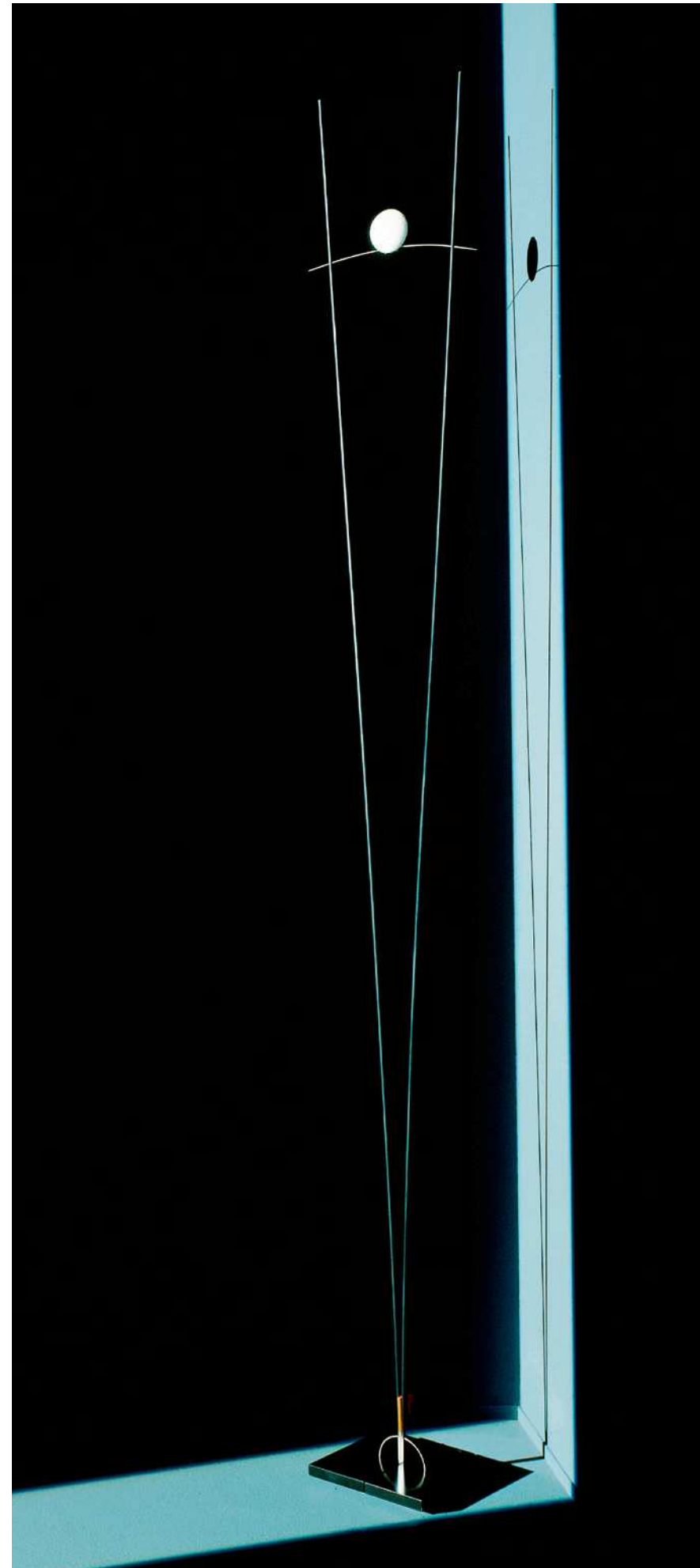

231



MAX. FLOOR admires Johnny Swing

234



BLOW ME UP

Watch the video at www.ingo-maurer.com



235

Made in three-dimensional printing technology.
Knot is available as table and floor lamp.

KNOT 3 Limited production

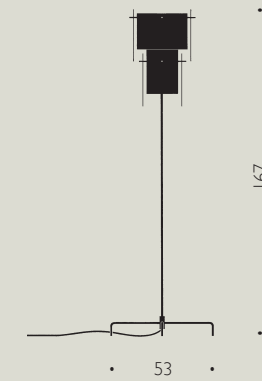

24 Karat Blau Floor Axel Schmid 2017

Acht Platten aus in Acrylglas eingegossenem Blattgold, Metallstab in Rot oder Blaugrau. Zugschalter an der Fassung. Rotes oder transparentes Kunststoffkabel. ■ Eight plates made of gold leaf sealed in acrylic glass, metal rod in red or blue-grey. Pull switch at the socket. Red or transparent plastic cable. ■ Huit plaques en feuilles d'or moulées dans du verre acrylique, tige en métal rouge ou bleu-gris. Interrupteur à tirette au niveau de la douille. Câble plastique rouge ou transparent. ■ Otto lastre con foglia d'oro colata in vetro acrilico, asta in metallo di colore grigio-blu. Interruttore a tirante sul portalampada. Cavo in materiale sintetico rosso o trasparente.

LED or Halogen E27, max. 60 W, A⁺-E



Alizz F. Cooper Ingo Maurer und Team 2008

Metall, Kunststoff, Gummischlauch. Die obere flexible Hälfte des Stabes ermöglicht die variable Einstellung des Reflektors. Reflektor 360° um das Leuchtmittel drehbar. Stufenlos dimmbar. ■ Metal, plastic, rubber hose. The upper flexible half of the stem allows variable adjustment. Reflector rotates through 360° around the bulb. Continuously variable dimmer. ■ Métal, matière plastique, tuyau en caoutchouc. La moitié supérieure et flexible de la tige permet le réglage variable du réflecteur. Réflecteur rotatif de 360° autour de l'ampoule. Réglage de l'intensité lumineuse sans graduation. ■ Metallo, materiale sintetico, tubo di gomma. La parte superiore dell'asta è flessibile e permette la regolazione variabile del riflettore. Riflettore rotante di 360° intorno alla lampadina. Regolazione continua dell'intensità luminosa.

150 W Halogen, 2870 lm, 2900 K, 2000 h, EEC D B15d/G9 + adapter, max. 150 W, A⁺-E EU: Please check availability on our website.



Bastardo Bernhard Dessecker/Ingo Maurer 2015

Steh- oder Tischlampe. Die Neigung lässt sich über das Kugelgelenk am Fuß einstellen. Der mitgelieferte Verlängerungsstab macht auf Wunsch aus der Tischlampe eine Stehlampe. Stahl, Aluminium, Kunststoff. ■ Desk or floor lamp. The angle is adjustable by the ball joint in the base. An included extension rod turns the desk lamp into a floor lamp. Steel, aluminium, plastic. ■ Lampe de table ou lampadaire. L'inclinaison de la lampe est réglable par l'articulation à rotule au niveau du socle. Acier, aluminium, matière plastique. ■ Lampada da tavolo o a stelo. L'inclinazione della lampada può essere regolata mediante un giunto a sfera. Acciaio, alluminio, materiale sintetico.

13,5 W LED, 1500 lm, 3000 K, CRI >90, EEC A⁺ 100-240 V 250 cm

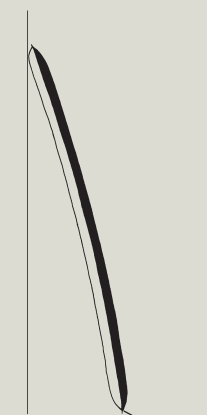

Blow Me Up Theo Möller, Ingo Maurer und Team 2017

Kunststoff, Stahl. Zum Aufblasen. Rückseite in Silber, Grün, Blau oder Violett. Mit Sensor-Schalter, und Nylonseilen zum Aufhängen. Höhenverstellbar. Wahlweise mit Steckertransformator oder Baldachin mit integriertem Transformator. ■ Plastic, steel. Inflatable. Backside in Silver, Green, Blue or Violet. With sensor-switch and nylon string for suspension. Height adjustable. Choose between plug-in transformer or canopy with integrated transformer. ■ Plastique, métal. Gonflable. Face arrière en argent, vert, bleu ou violet. Avec interrupteur à capteur et fils en nylon pour suspension. Réglable en hauteur. Au choix avec transformateur à prise ou baldachin avec transformateur intégré. ■ Materiale sintetico, acciaio. Gonfiabile. Lato superiore in argento, verde, blu o violetto. Con interruttore sensoriale e fili in nylon per la sospensione. Regolabile in altezza. A scelta con trasformatore a spina o rosone con trasformatore integrato.

20/30 W LED, 2670/4000 lm, 3000 K, 25000 h, CRI >90, EEC A⁺

or 100-240 V/12 V 300 cm



Dew Drops Floor Ingo Maurer Team 2015

Transparente Kunststoffolie mit integrierten LEDs, Metall. Die Stäbe sind mit Kugelgelenken auf der Fußplatte (19x26 cm) montiert. Mit Sensorschalter zum Anschalten und Dimmen auf der Folie. Erhältlich mit zwei LED-Folien oder mit einer LED-Folie plus einem Papiersegel als Diffusor. ■ Transparent plastic sheet with integrated LEDs, metal. Two rods, adjustable via ball-joints mounted on the base (19x26 cm). With dimmable touch sensor switch on the sheet. Available with two LED sheets or with one LED sheet plus paper sheet as diffuser. ■ Film plastique transparent avec LEDs intégrés, métal. Les tiges sont montées grâce à une articulation à rotule sur la plaque (19x26 cm). Avec interrupteur à sensor tactile pour allumer et faire varier l'intensité de la lumière sur le film plastique. Disponible avec deux films plastiques LED ou avec un film plastique LED plus une voile en papier comme diffuseur. ■ Pellicola trasparente in materiale sintetico con LED integrati, metallo. Le due aste sono fissate alla base (19x26 cm) tramite giunti a sfera. Interruttore a sensore sulla pellicola stessa per accendere, spegnere e dimmerare. Disponibile con due pellicole a LED oppure con una pellicola a LED e un foglio in carta come diffusore.

LEDs dimmable, per sheet 23 W, 2600 lm, 3000 K, CRI 90, EEC A

100–240 V, EU or US 200 cm

Glatzkopf Floor Ingo Maurer und Team 2017

Metall, Lampenschirm aus grünen, weißen oder schwarzem Karton, halb mattiertes Globe-Leuchtmittel Durchmesser 12,5 cm. Neigung und Länge des Stabs variabel. Fußplatte mit drei Bohrungen in verschiedenen Winkeln. ■ Metal, paper shade in Green, White or Black, semi-frosted Globe bulb Durchmesser 12,5 cm. Inclination and length of rod adjustable. Base plate with three openings in different angles. ■ Métal, abat-jour en cartonage vert, blanc ou noir, globe-ampoule semi-mat. Diamètre 12,5 cm. Inclinaison et longueur variables de la tige. Trois orifices dans le socle avec différents angles d'inclinaison. ■ Metallo, paralume in cartone verde, bianco o nero, lampadina Globe mezzo opacizzata diametro 12,5 cm. Inclinazione e lunghezza dell'asta variabile. Base con tre fori per inclinazioni differenti.

LED not dimmable, 6 W, 600 lm, 2700 K, 15000 h, CRI 85, EEC A**, Ø 12,5 cm

220–240 V E27, max. 30 W 200 cm

Ilios Ingo Maurer, Franz Ringelhan 1983

Silber oder schwarz. Metall und Glas, Isolationskeil fluoreszierend rot. ■ Choice of silver or black metal, glass, red fluorescent insulator. ■ Argent ou noir. Métal et verre, pièce d'isolation rouge fluorescente. ■ Argento o nero. Metallo e vetro, elemento isolante rosso fluorescente.

35 W Halogen, 860 lm, 2900 K, 4000 h, EEC B GY 6,35, max. 50 W, 230/125/12

EU: Please check availability on our website.

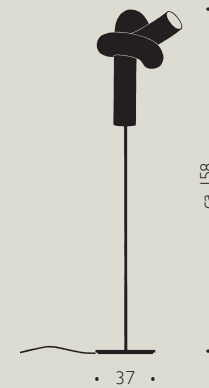

Knot 3 Ingo Maurer 2013

Limitierte Produktion. Polyamid, Aluminium. Der Knoten wird in einem 3D-Druckverfahren einzeln hergestellt. Knot 1 und 3 haben einen Fuß aus Stahl. ■ Limited production. Polyamide, aluminium. Made in three-dimensional printing technology. Knot 1 and 3 have a lamp base made of steel. ■ Production limitée. Polyamide, aluminium. Chaque Knot est conçu individuellement grâce au procédé d'imprimerie 3D. Knot 1 et 3 ont une base de lampe en acier. ■ Produzione limitata. Poliamide, alluminio. Ogni nodo viene prodotto singolarmente con un procedimento di stampa 3D. Knot 1 e 3 hanno una base di acciaio.

14,6 W LED, 1350 lm, 3000 K, CRI 80, EEC A 100–240 V 250 cm

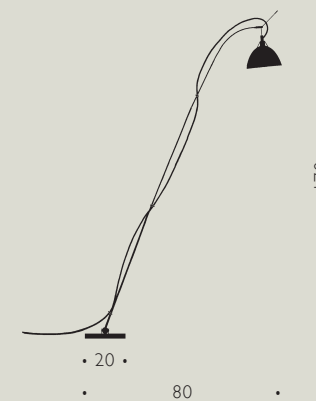

Max. Floor Ingo Maurer und Team 2015

Edelstahl, Aluminium. Das Kugelgelenk ermöglicht stufenloses Drehen und Neigen in alle Richtungen. An seinem Griff ist der Reflektor in alle Richtungen schwenkbar. Dimmer mit Schieberegler. ■ Stainless steel, aluminium. The ball-joint makes it possible to turn and tilt the lamp in all directions. The reflector (with handle) can be swivelled in any direction. Dimmer with slide control. ■ Acier inoxydable, aluminium. L'articulation à rotule permet de tourner et d'incliner la lampe sans graduation dans tous les sens. Le réflecteur est orientable dans tous les sens grâce à sa poignée. Avec variateur à curseur. ■ Acciaio inossidabile, alluminio. Ruotabile e inclinabile in continuo in tutte le direzioni mediante un giunto sferico. Agendo sulla leva, il riflettore può essere regolato in tutte le direzioni. Con varialuce lineare.

LED dimmable 15 W, 1300 lm, 3000 K, CRI 90, EEC A* 220–240 V / 110–125 V

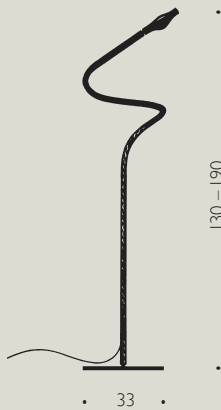

Metall F. Cooper Ingo Maurer und Team 2008

Metall, Kunststoff. Die obere flexible Hälfte des Stabes ermöglicht die variable Einstellung des Reflektors. Reflektor 360° um das Leuchtmittel drehbar. Stufenlos dimmbar. ■ Metal, plastic. The upper flexible half of the stem allows variable adjustment. Reflector rotates through 360° around the bulb. Continuously variable dimmer. ■ Métal, matière plastique. La moitié supérieure et flexible de la tige permet le réglage variable du réflecteur. Réflecteur rotatif de 360° autour de l'ampoule. Réglage de l'intensité lumineuse sans graduation. ■ Metallo, materiale sintetico. La parte superiore dell'asta è flessibile e permette la regolazione variabile del riflettore. Riflettore rotante di 360° intorno alla lampadina. Regolazione continua dell'intensità luminosa.

150 W Halogen, 2870 lm, 2900 K, 2000 h, EEC D B15d/G9 + adapter, max. 150 W, A++–E EU: Please check availability on our website.



Ringelpez Ingo Maurer und Team 2016

Der Ring aus Aluminium mit LEDs ist als Up- oder Downlight nutzbar. Winkel und Ausrichtung des Rings ohne Werkzeug verstellbar. Der ausziehbare Stab aus Kohlefaser kann in der Basis senkrecht oder im Winkel von 15° fixiert werden. LED-Ring in Schwarz oder Weiß. ■ The aluminium ring with LEDs can be fixed as up- or downlight. The angle and orientation of the ring are adjustable without tools. The extendable rod in carbon fiber can be fixed vertically or at an angle of 15° in the base. LED ring in Black. ■ L'anneau en aluminium équipé de LEDs est utilisable en Up- ou Downlight. L'angle et l'orientation de l'anneau ajustables sans outils. La tige télescopique en fibre de carbone peut être fixée dans la base à la verticale ou avec un angle à 15°. Anneau LED en noir ou blanc. ■ L'anello in alluminio con LED può essere impiegato come uplight o downlight. Semplice regolazione senza necessità di attrezzi dell'angolo e dell'orientamento dell'anello. L'asta telescopica in fibra di carbonio può essere fissata nella base in posizione verticale oppure in un angolo di 15°. Anello a LED disponibile in nero o bianco.

☐ LED dimmable 25 W, 3600 lm, 3000 K, CRI 95, EEC A+ ☐ 100–240 V



Ringelpez Frivoloso Ingo Maurer und Team 2017

Papierschirm für alle Ringelpez-Modelle, weiß oder grün. ■ Papershade for all Ringelpez models, white or green. ■ Abat-jour en papier pour tous les modèles de Ringelpez, blanc ou vert. ■ Paralume per tutte le versioni Ringelpez, bianco o verde.

Deckenlampen
Plafonniers
Lampade da soffitto

CEILING LAMPS 241

242

243

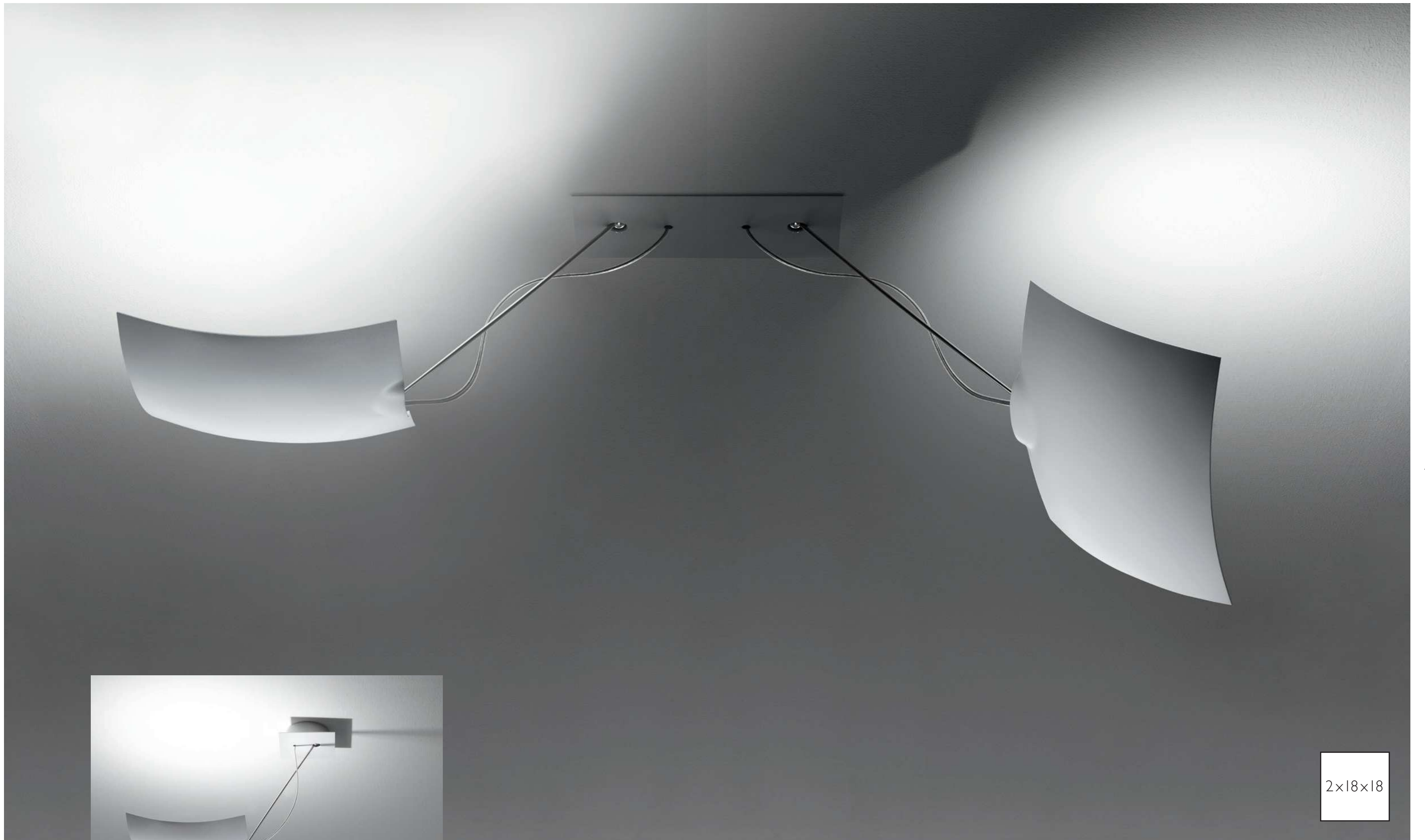

18x18

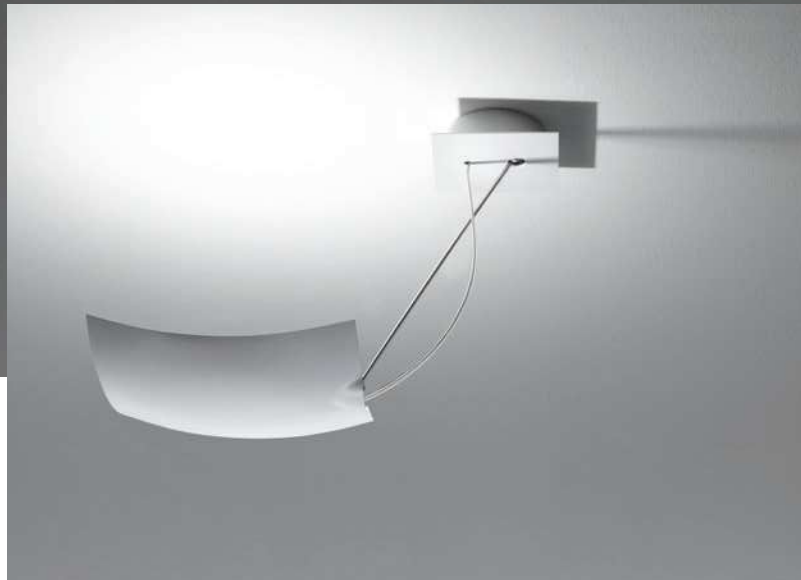

2x18x18

244



MAX. WALL LED

245



WALL.E.D



246



247

USE ME C. can be
used as downlight in
combination with
Lacrime del Pescatore,
as well from the side.
Sold separately.



248

LUCellino DOPPIO LED OR HALOGEN

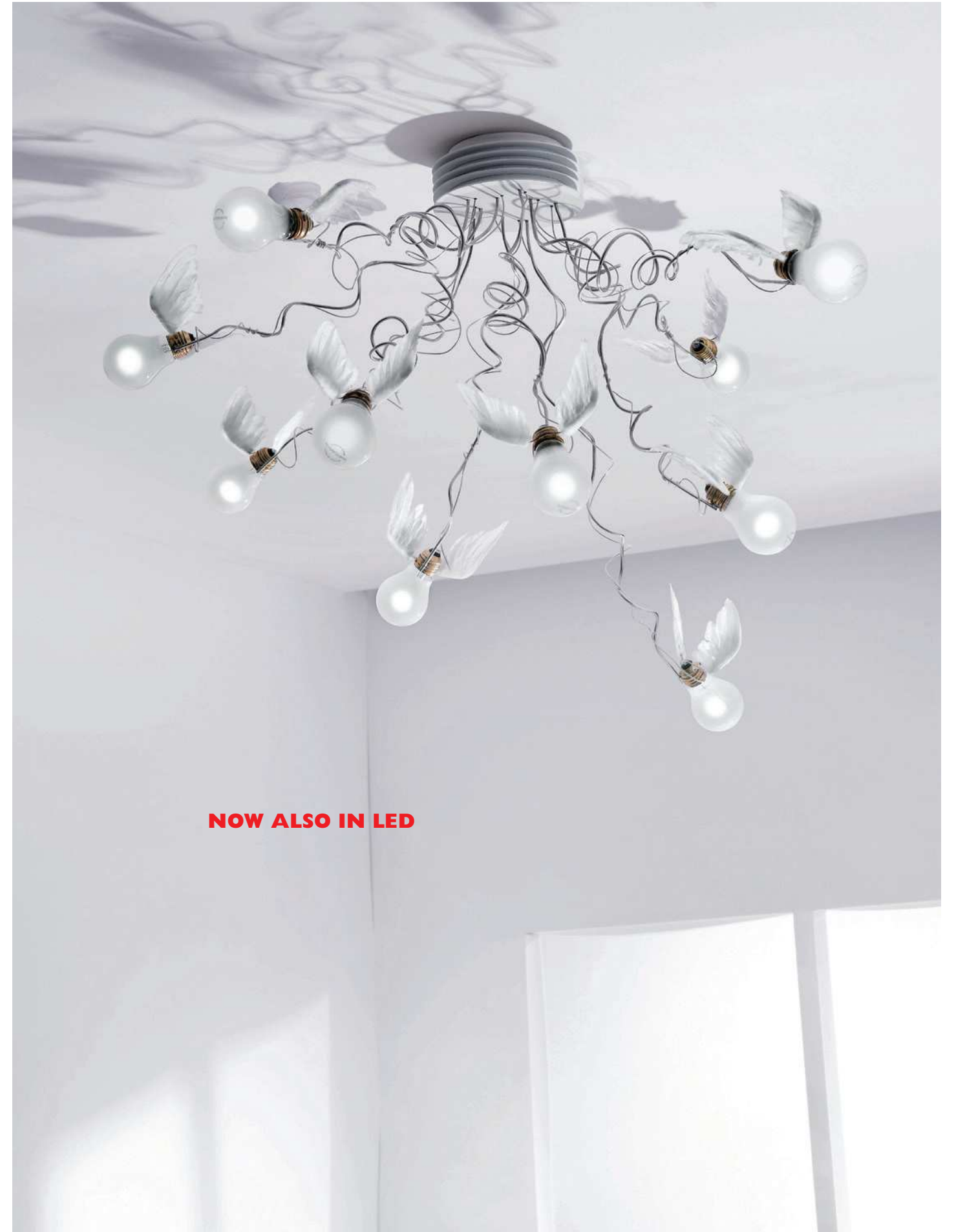

249

NOW ALSO IN LED

BIRDIE'S NEST

250



LUXURY PURE

251



LIL LUXURY

The smaller version of Luxury Pure
in silver, white and gold

252



LIGHT CONES: Ø 17 or 30 cm

253

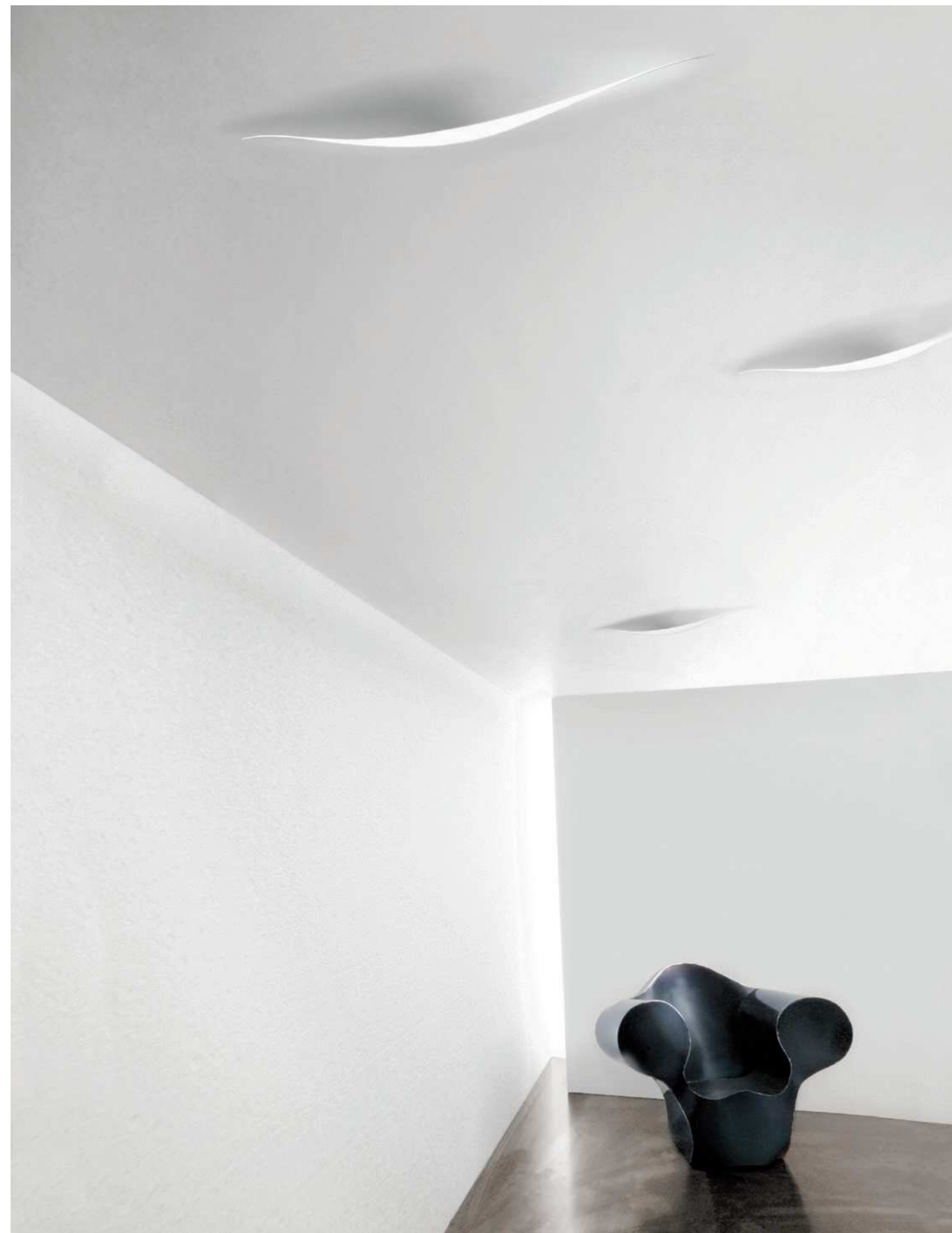

SCHLITZ UP: Length of the cut: 60 cm

SCHLITZ UP
VIEW FROM BELOW INTO OPEN RECESSED CEILING

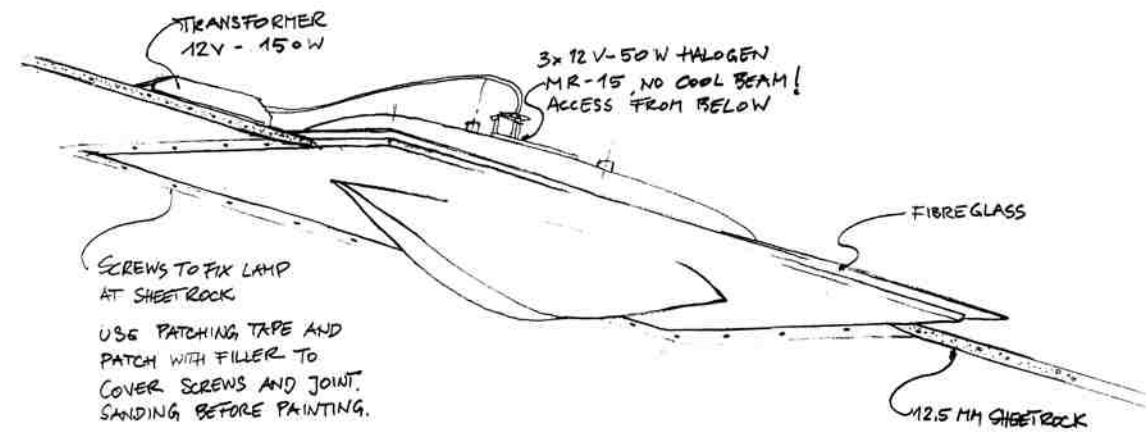

LIGHT CONE
PERSPECTIVE VIEW INTO RECESSED CEILING

My answer to
boring downlights:
"Schlitz Up!"
An elegant cut
in the ceiling.

250 or 450x50 cm. Custom sizes available on request.

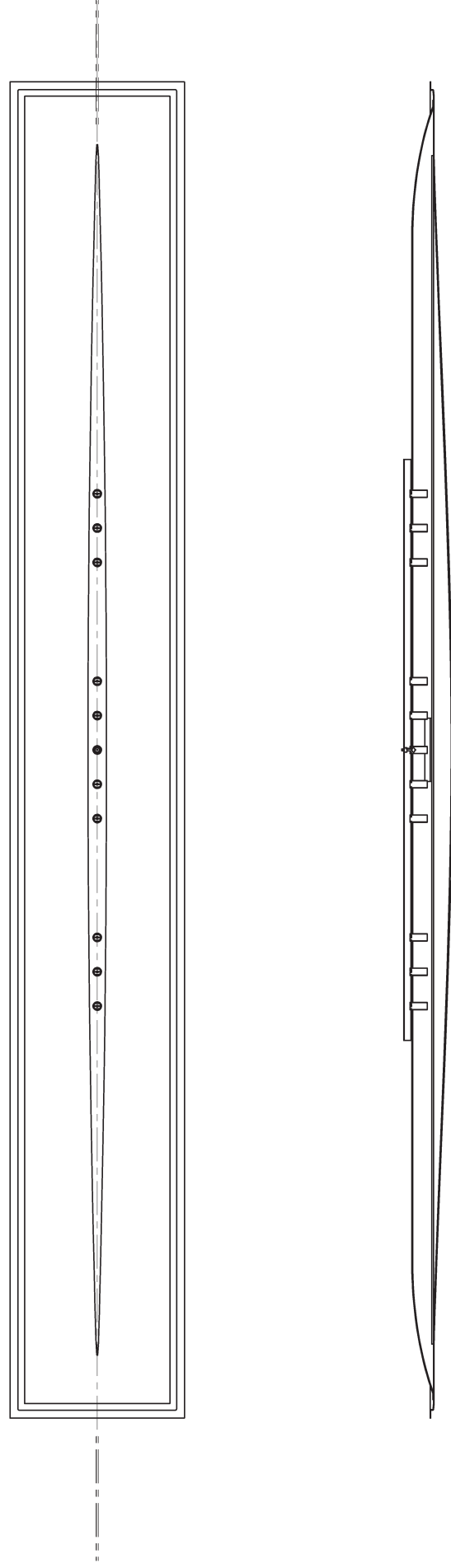



258

SPOCK
can be adjusted
thanks to a ball joint.

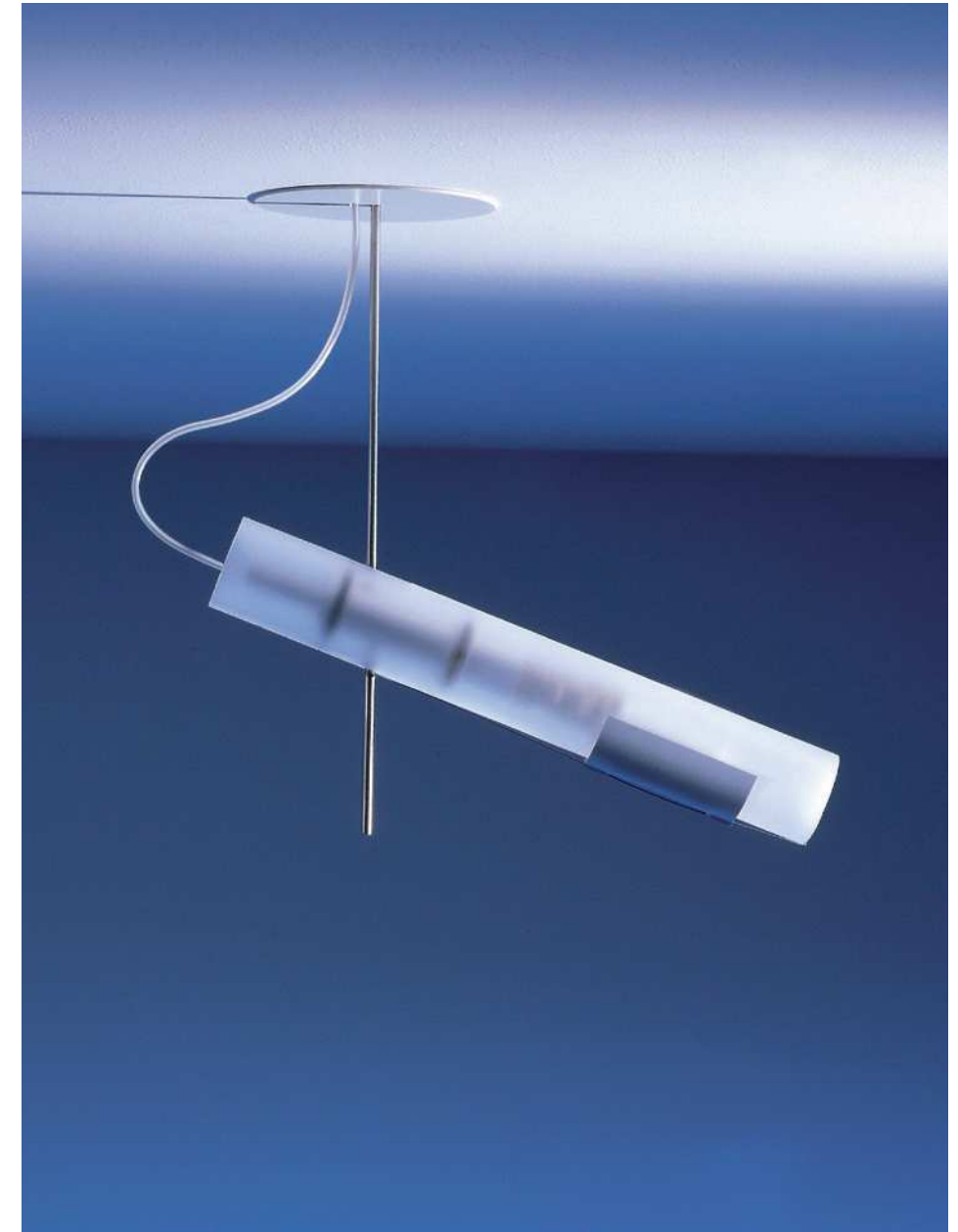

259

ZUUK

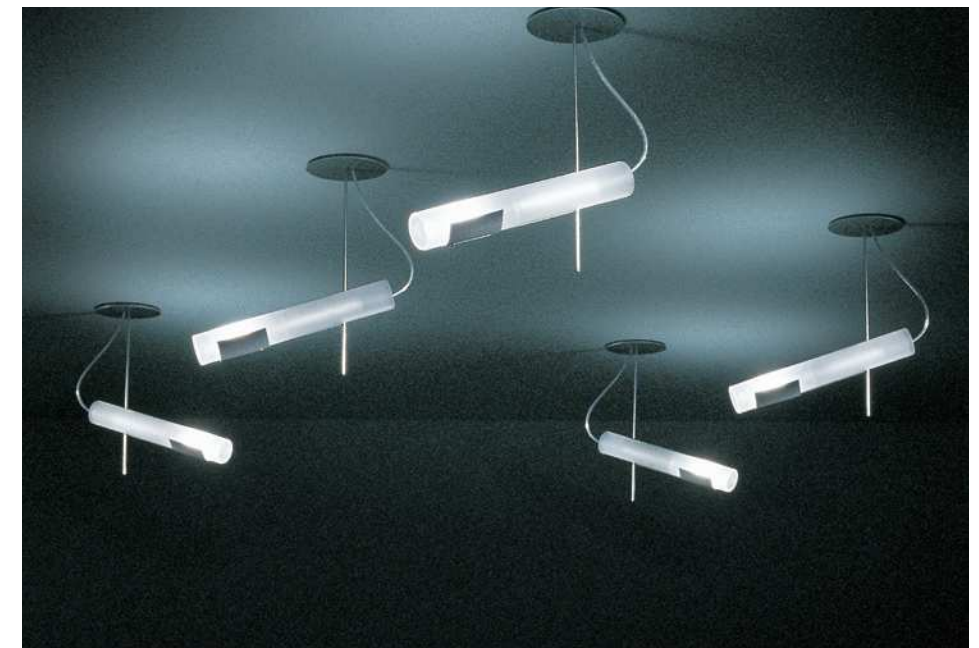

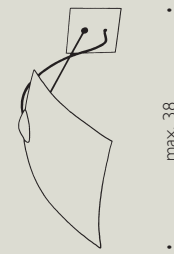
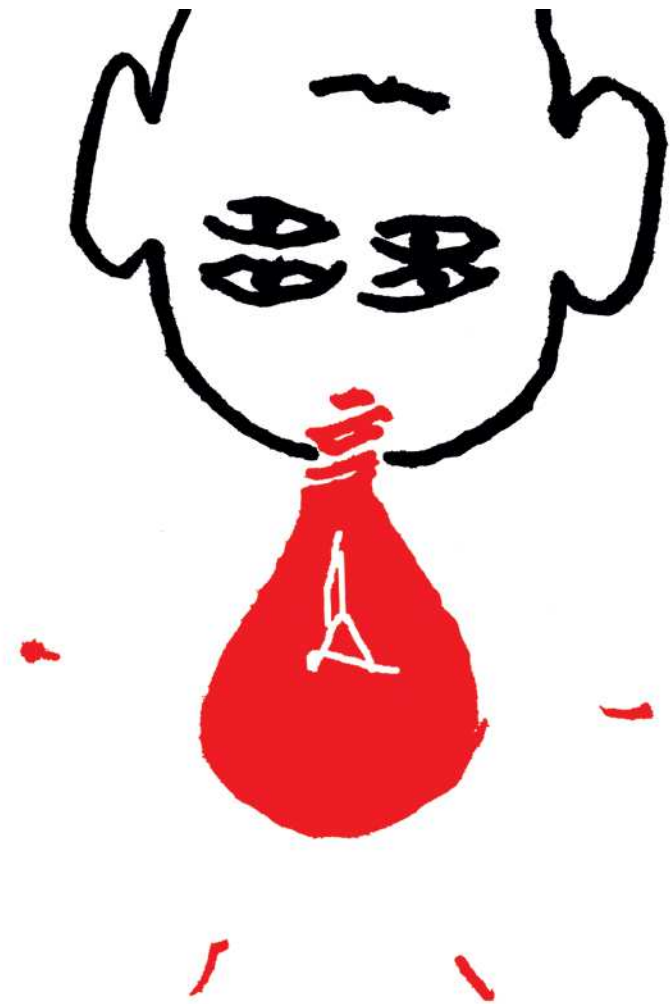

max. 38

18x18 Ingo Maurer und Team 2015

Schirm aus pulverbeschichtetem Aluminium, Edelstahl, Kunststoff. Zwei Kugelgelenke ermöglichen eine äußerst flexible Ausrichtung. ■ Lamp shade in powder-coated aluminium, stainless steel, plastic. Two ball-joints provide high flexibility. The 110–125 volts version is delivered with adapter plate to cover standard U.S. 4 inch octagonal junction boxes. ■ Ecran en aluminium revêtu par poudre, acier spécial, matière plastique. Deux rotules permettent une orientation très flexible. ■ Paralume in alluminio verniciato a polvere; acciaio inossidabile, materiale sintetico. Due giunti a sfera consentono una regolazione particolarmente flessibile.

LED dimmable, 20 W, 1600 lm, 3000 K, CRI 90, EEC A+ ⚡ 220–240 V / 110–125 V

2x18x18 Ingo Maurer und Team 2016

Schirme aus pulverbeschichtetem Aluminium, Edelstahl, Kunststoff. Zwei Kugelgelenke ermöglichen eine äußerst flexible Ausrichtung. ■ Lamp shades in powder-coated aluminium, stainless steel, plastic. Two ball-joints provide high flexibility. ■ Ecran en aluminium revêtu par poudre, acier spécial, matière plastique. Deux rotules permettent une orientation très flexible. ■ Paralume in alluminio verniciato a polvere; acciaio inossidabile, materiale sintetico. Due giunti a sfera consentono una regolazione particolarmente flessibile.

2 x LED dimmable, 20 W, 1600 lm, 3000 K, CRI 90, EEC A+ ⚡ 220–240 V / 110–125 V



ca. 40–80



ca. 50

min. 50, max. 95

Birdie's Nest Ingo Maurer 2005

Metall, Flügel aus Gänsefedern, zehn Niedervolt-Leuchtmittel, transparente Kabel. ■ Metal, goose-feather wings, ten low-voltage bulbs, transparent cables. Complete with bulbs. ■ Métal, ailes en plumes d'oie, dix ampoules à bas voltage, câbles transparents. ■ Metallo, ali in piume d'oca, dieci lampadine a basso voltaggio, cavi trasparenti.

10 x 10 W Halogen, 10 x 90 lm, 2000 h, CRI 100, EEC C ⚡ E27 ⚡ 230/125/24 V

10 x 1,5 W LED, 10 x 100 lm, 2700 K, 15000 h, CRI 85, EEC A++ ⚡ E27 ⚡ 200–240 V

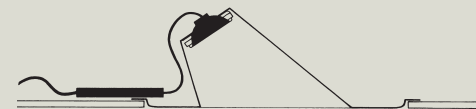

24

Light Cone L Ingo Maurer 2005

Fiberglas. Für fugenlosen Einbau in abgehängte Decken, Einbautiefe 23 cm. ■ Fibreglass. For flush mounting in lowered ceilings, installation depth 23 cm. ■ Fibre de verre. Pour montage sur plafonds surbaissés. Profondeur pour montage 23 cm. ■ Vetroresina. Per l'incasso in controsoffitti. Profondità di montaggio 23 cm.

LED or Halogen ⚡ G53, max. 100 W, A++–E ⚡ 230/125/12 V

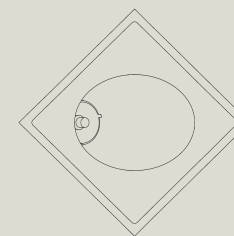

30

41 x 41



• 18 •

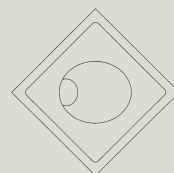

• 17 •
28 x 28



• 18 •

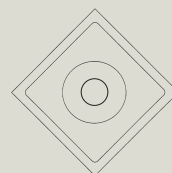

• 17 •
28 x 28

Light Cone S / Light Cone S vertical Ingo Maurer 2005

Fiberglas. Für fugenlosen Einbau in abgehängte Decken, Einbautiefe 18 cm. ■ Fibre-glass. For flush mounting in lowered ceilings. Installation depth 18 cm. ■ Fibre de verre. Pour montage sur plafonds surbaissés. Profondeur pour montage 18 cm. Livrée avec ampoule. ■ Vetroresina. Per l'incasso in controsoffitti. Profondità di montaggio 18 cm.

💡 LED or Halogen 🌀 GU10, max. 75 W, A++-E

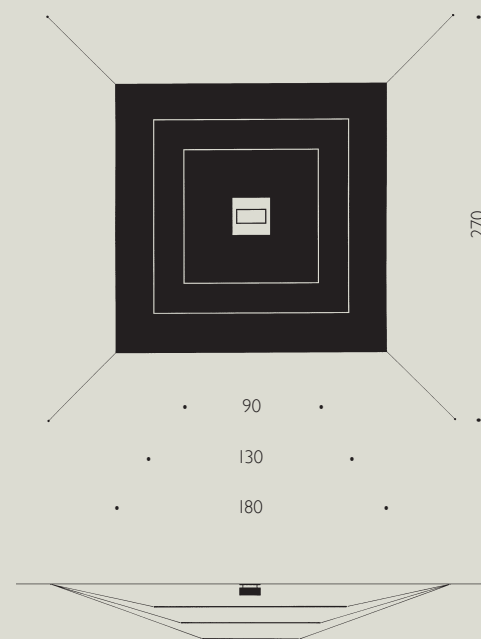

270

• 90 •

• 130 •

• 180 •

• 50 •

Luxury Pure Ingo Maurer und Team 2004

Gold lackiertes Papier, Aluminium. Aufhängung an Seilen aus Polyestergeflecht. Für Raumhöhen ab 270 cm. Segel 1: 180 x 180 cm. Segel 2: 130 x 130 cm. Segel 3: 90 x 90 cm. Abstand der Deckenhalterung: 270 x 270 cm. ■ Gold lacquered paper, aluminium. For ceiling heights of 270 cm and more. Suspension with braided polyester strings. Sail 1: 180 x 180 cm. Sail 2: 130 x 130 cm. Sail 3: 90 x 90 cm. Spacing of ceiling fixtures: 270 x 270 cm. ■ Papier laqué or, aluminium. Pour hauteurs de pièces à partir de 270 cm. Suspension par fils en polyester tressé. Voile 1: 180 x 180 cm. Voile 2: 130 x 130 cm. Voile 3: 90 x 90 cm. Distance des suspensions: 270 x 270 cm. ■ Carta verniciata oro, alluminio. Sospensione con fili in poliestere intrecciato. Per soffitti con altezza a partire da 270 cm. Vela 1: 180 x 180 cm. Vela 2: 130 x 130 cm. Vela 3: 90 x 90 cm. Distanza delle sospensioni: 270 x 270 cm.

💡 LED dimmable, 39 W, 3000 lm, 2700 K, CRI 92, EEC A+ 🌀 I 110-240 V/37 V

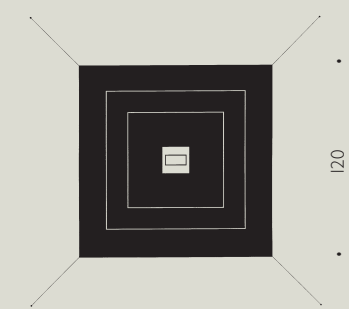

• 120 •

• 120 •



• 26 •

Lil Luxury Ingo Maurer und Team 2009

Gold, silbern oder weiß lackiertes Papier, Aluminium. Aufhängung an Seilen aus Polyestergeflecht. Für Raumhöhen ab 240 cm. Segel 1: 120 x 120 cm. Segel 2: 89 x 89 cm. Segel 3: 65 x 65 cm. Abstand der Deckenhalterung: 200 x 200 cm. ■ Gold, silver or white lacquered paper, aluminium. For ceiling heights of 240 cm and more. Suspension with braided polyester strings. Sail 1: 120 x 120 cm. Sail 2: 89 x 89 cm. Sail 3: 65 x 65 cm. Spacing of ceiling fixtures: 200 x 200 cm. ■ Papier laqué or, argent ou blanc, aluminium. Pour hauteurs de pièces à partir de 240 cm. Suspension par fils en polyester tressé. Voile 1: 120 x 120 cm. Voile 2: 89 x 89 cm. Voile 3: 65 x 65 cm. Distance des suspensions: 200 x 200 cm. ■ Carta verniciata oro, argento o bianco, alluminio. Sospensione con fili in poliestere intrecciato. Per soffitti con altezza a partire da 240 cm. Vela 1: 120 x 120 cm. Vela 2: 89 x 89 cm. Vela 3: 65 x 65 cm. Distanza delle sospensioni: 200 x 200 cm.

💡 LED dimmable, 39 W, 3000 lm, 2700 K, CRI 92, EEC A+ 🌀 I 110-240 V/37 V

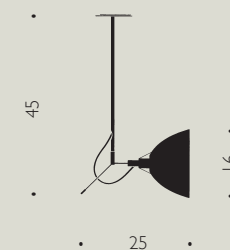

• 45 •

• 16 •

• 25 •

Max. Wall LED Ingo Maurer und Team 2001

Aluminium, Fiberglas, Edelstahl. Reflektor um 180° drehbar. ■ Aluminium, fibreglass, stainless steel. Reflector rotates through 180°. ■ Aluminium, fibre de verre, acier spécial. Réflecteur rotatif à 180°. ■ Alluminio, vetroresina, acciaio inossidabile. Il riflettore ruota di 180°.

💡 LED, 15 W, 1300 lm, 3000 K, CRI 90, EEC A+ ⚡ 220-240 V / 110-125 V

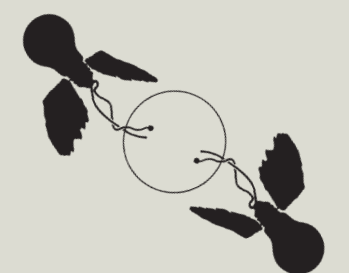

• 15 •

ca. 50

Lucellino Doppio Ingo Maurer 2018

Metall, Flügel aus Gänsefedern, zwei Niedervolt-Leuchtmittel. ■ Metal, goose-feather wings, two low-voltage bulbs, transparent cables. Complete with bulbs. ■ Métal, ailes en plumes d'oie, deux ampoules à bas voltage, câbles transparents. ■ Metallo, ali in piume d'oca, due lampadine a basso voltaggio, cavi trasparenti.

💡 2 x 35 W Halogen, 1200 lm, 3000 K, 2000 h, CRI 100, EEC C 🌀 E27 🌀 230/125/24 V
💡 2 x 1,5 W LED dimmable, 200 lm, 2700 K, 15000 h, CRI 85, EEC A++ 🌀 E27 🌀 200-240 V

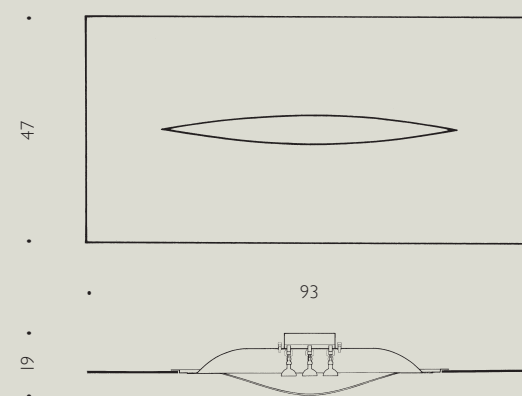

• 47 •

• 93 •

• 19 •

Schlitz Up Ingo Maurer 2002

Aluminium, GFK. Deckenlampe für Einbau in abgehängte Decken, Einbautiefe min. 15 cm. Sondergrößen auf Anfrage. Durch Kugelgelenke justierbare Multi Mirror-Reflektoren lenken das Licht an verschiedene Positionen. Die Innenflächen können auf Wunsch auch in anderen kontrastreichen Farben lackiert werden. ■ Aluminium, glass fibre. Ceiling lamp for flush mounting into lowered ceilings, installation depth 15 cm min. Alternative dimensions on request. Multimirror reflectors, adjustable by means of ball-joints, direct the light to various positions. On request, the inner surface can be lacquered in several contrast colours. ■ Aluminium, fibre de verre. Plafonnier pour montage sur plafonds surbaissés, profondeur de montage 15 cm. Dimensions spéciales sur demande. Des réflecteurs Multi Mirror réglables par des articulations à rotule dirigent la lumière dans des positions diverses. Les surfaces intérieures peuvent être laquées sur demande dans d'autres couleurs plus contrastées. ■ Alluminio, vetroresina. Lampada da soffitto per l'incasso in controsoffitti, profondità di montaggio 15 cm. Misure speciali su richiesta. Grazie a riflettori Multi Mirror regolabili tramite giunti sferici, la luce può essere diretta in varie posizioni. Le superfici interne possono essere verniciate in altri colori contrastanti su richiesta.

💡 3 x 7,5 W LED Spot, 420 lm, 2700 k, CRI >85, EEC A. Dimmable.

🌀 GU 10, max. 8 W, EEC A++-A, 125 volts version: bulbs not included.

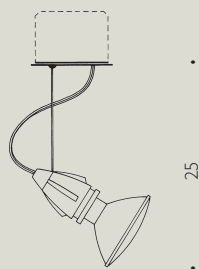

25

Spock Bernhard Dessecker 1998

Edelstahl, Glas, Aluminium. Der Strahler ist über ein Kugelgelenk einstellbar. Aufputz-Montagedose mit Abdeckscheibe Ø 8 cm. Die Montage auf eine Unterputzdose ist ebenfalls möglich. Auch an der Wand zu montieren. ■ Stainless steel, glass, aluminium. Adjustable via ball-joint. Box with cover Ø 8 cm, for surface mounting. Flush mounting also possible, or can be fixed to wall. ■ Acier inoxydable, verre, aluminium. Le spot est orientable par articulation à rotule. Boîte pour le montage sur crépi avec rondelle de recouvrement Ø 8 cm. Le montage sur une boîte encastrable sous crépi est également faisable. Possibilité de montage en applique. ■ Acciaio inossidabile, vetro, alluminio. Il faretto è regolabile mediante un giunto sferico. Scatola di derivazione esterna a soffitto con rosone Ø cm. 8. Possibilità di montaggio con una scatola di derivazione incassata. E' possibile montarla anche a parete.

💡 LED or Halogen ⚡ E27, max. 75 W, EEC A++-E



15

Use Me C. Ingo Maurer und Team, 2010

Edelstahl, Aluminium. Der Strahler ist über ein Kugelgelenk einstellbar. Das Leuchtmittel ist im Handel auch in anderen Ausstrahlungswinkeln und Wattagen erhältlich. ■ Stainless steel, aluminium. Adjustable via one ball-joint. In trade the light source is also available with other angles and wattages. ■ Acier inoxydable, aluminium. Spot ajustable par une articulation à rotule. L'halogène est aussi disponible en magasin avec d'autres angles et wattages. ■ Acciaio inossidabile, alluminio. Il faretto è regolabile mediante un giunto a sfera. La lampadina è anche disponibile in commercio con altri angoli d'irradiazione e wattaggi.

💡 100 W 8° Halogen, 3000 h, EEC B ⚡ G53, max. 100 W, EEC A++-E ⚡ 230/125/12 V
EU: The halogen version is a phase-out model, please check our website for up-to-date info and technical details of the new LED version.

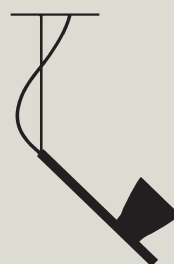

max. 40

WALL.E.D Konrad Lohöfener, Hagen Szezech 2017

Eloxiertes Aluminium in Schwarz oder Silber, Edelstahl, Kunststoff. Kugelgelenk und abgewinkelter Stab ermöglichen die flexible Ausrichtung. Mit abnehmbaren Reflektor zur Nutzung als Spot. ■ Anodised aluminium in Black or Silver, stainless steel, plastic. A ball-joint and the angled rod allow for flexible adjustments, provides flexibility. Removable reflector for use as spot. ■ Aluminium anodisé en noir ou argent, métal, matière plastique. Un joint à rotule et la tige coudée permettent un alignement flexible. Avec réflecteur supplémentaire Spot. ■ Alluminio anodizzato in nero o argento, metallo, materiale sintetico. Orientabile con giunto a sfera e asta inclinata orientabile. Con riflettore supplementare.

💡 LED dimmable, 15 W, 1300 lm, 3000 K, CRI >90, EEC A ⚡ 200-240 V / 110-125 V

Zuuk Ingo Maurer 1994

Edelstahl, farblos eloxiertes Aluminium, hitzebeständiges satiniertes Glas. Nicht verstellbar. Aufputz-Montagedose und eloxierter Abdeckscheibe Ø 8 cm. Die Montage auf eine Unterputzdose ist ebenfalls möglich. ■ Stainless steel, anodized aluminium, heat-resistant satin-frosted glass. Non-adjustable. Surface-mounted ceiling fixture and anodized base-plate cover Ø 8 cm. Flush mounting also possible. ■ Acier inoxydable, aluminium anodisé incolore, verre satiné résistant à la chaleur. Pas de possibilité de réglage en hauteur. Boîtier pour le montage sur crépi et rondelle de recouvrement Ø 8 cm en aluminium anodisé. Possibilité de montage en applique. ■ Acciaio inossidabile, alluminio anodizzato naturale, vetro satinato termoresistente. Non regolabile. Scatola di derivazione esterna e rosone anodizzato Ø cm. 8 inclusa. E' possibile montarla anche su una scatola di derivazione incassata.

💡 LED or Halogen ⚡ B15d, max. 60 W or G9 + Adapter, EEC A++-E

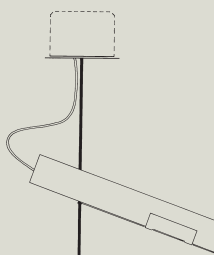

20

20

Wandlampen
Appliques
Lampade da parete

WALL LAMPS

Dear Luzi.
It was so
wonderful
and inspiring
working
with you
on that
biotope.



268



18x18

Serves as wall
or ceiling lamp.
Hotels, bedside,
restaurants,
corridors, stairways,
public spaces ...

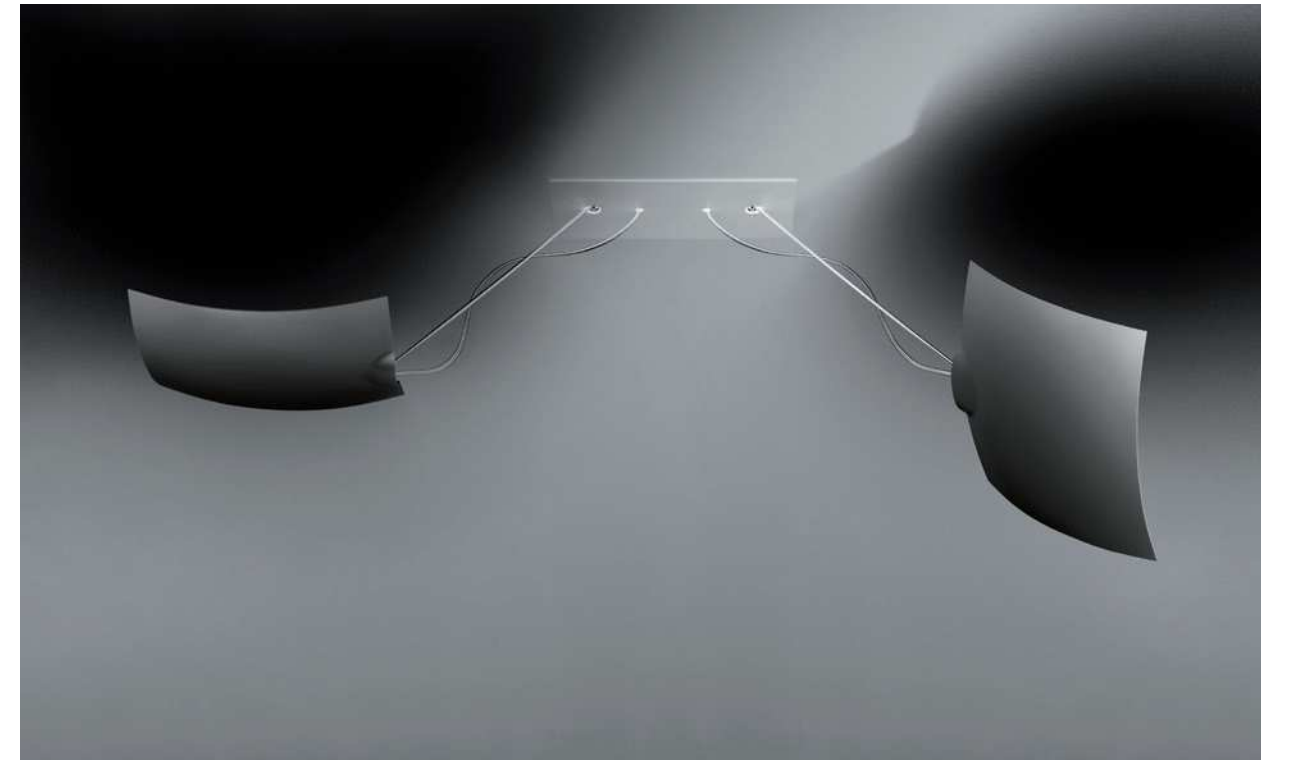

2x18x18

269

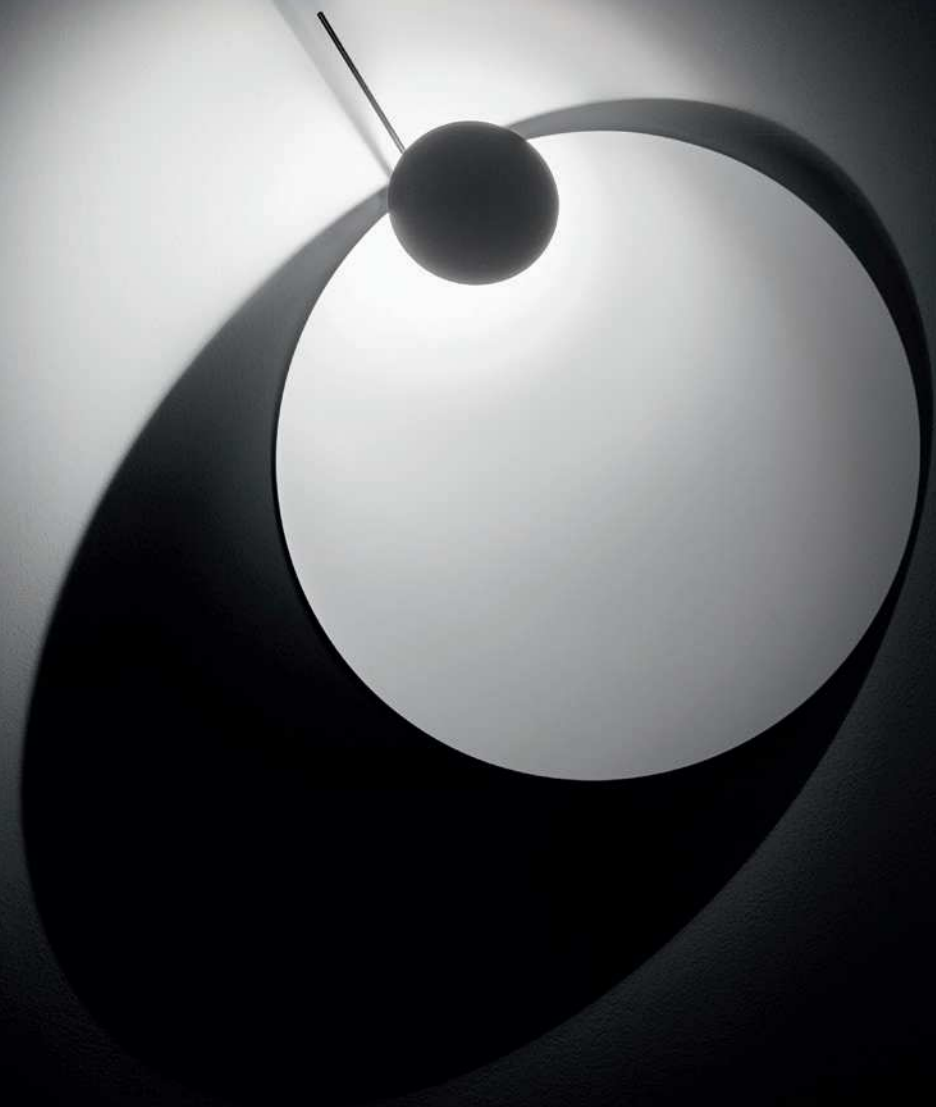

ECLIPSE ELLIPSE



Where there is light,
 there is shadow, too.
ECLIPSE ELLIPSE
 makes you become
 a creator of a
 natural spectacle.
 Change the position
 of the luminary discs
 and play with
 altering forms
 of light and shadows.



General lighting
or spotlight
with reflector.



WALL.E.D

The wall mounting
is a ball joint,
the positioning is
correspondingly
flexible.
Ringelpiez Wall
or ceiling.

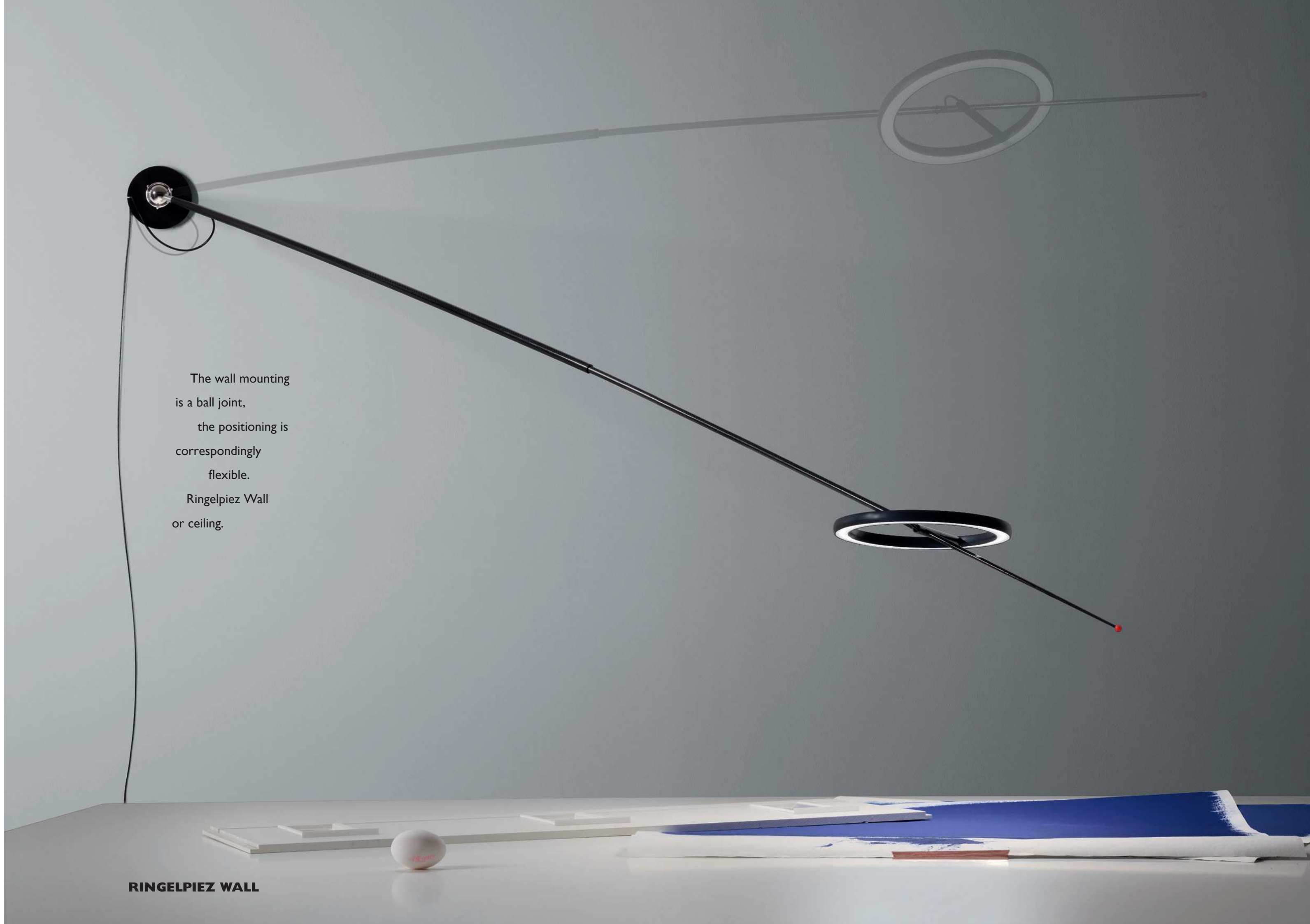

MAX. MOVER LED



276

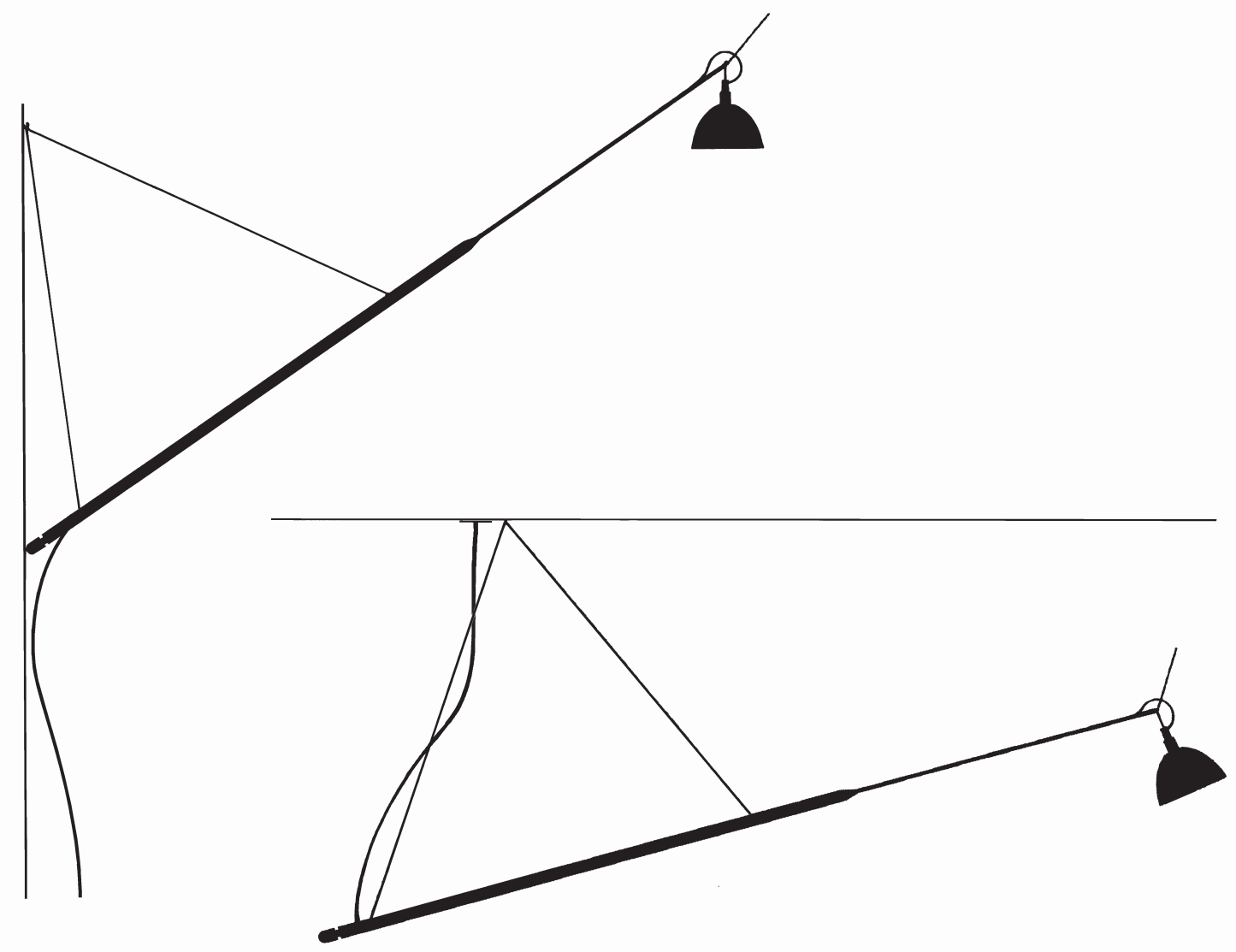

277





18 years and
no wrinkles!
Max. Mover
is still a super
lamp, maximum
flexibility, now
in LED.



MAX. WALL LED



An optional wall lamp for
Lacrime del Pescatore.
See page 52.

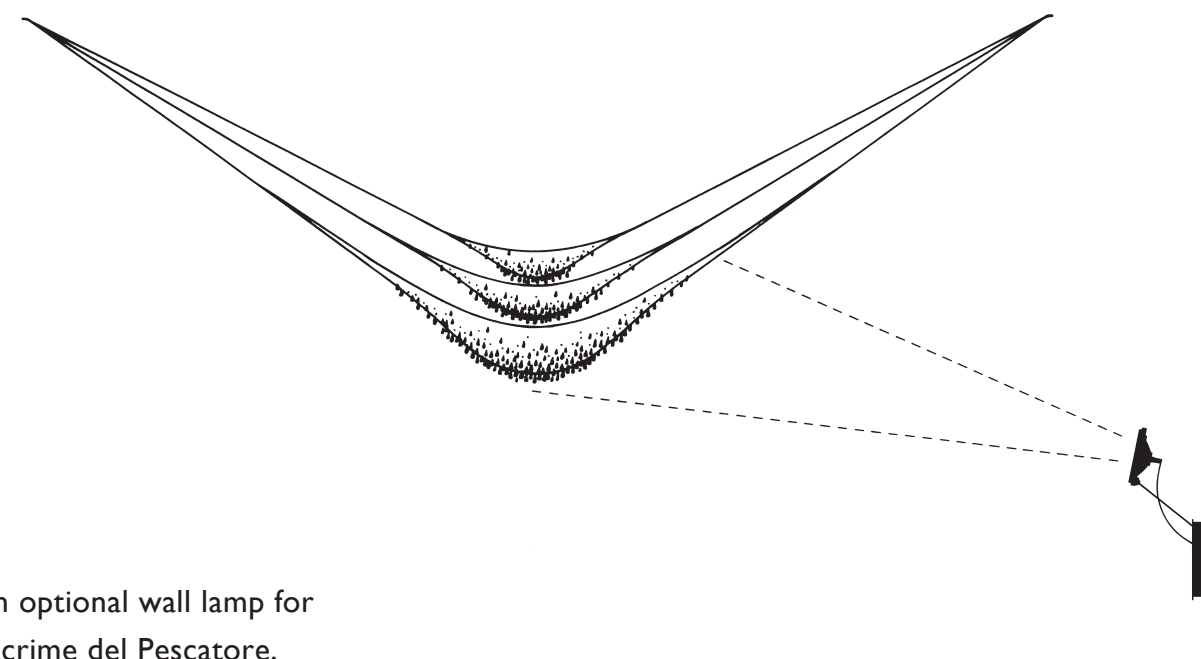

USE ME W.



Axel Schmid about
24 Karat Blau:
The gold leaf on
the shades is beaten
to a thickness of
 $1/10.000$ mm,
corresponding to
1.000 atomic layers.
This allows short-
wave blue light to
pass through the
molecules, with a
warm yellow-gold
light reflected
inside the shades.



24 KARAT BLAU WALL



284

LUCCELLINO WALL



LUCCELLINO DOPPIO

NOW ALSO IN LED

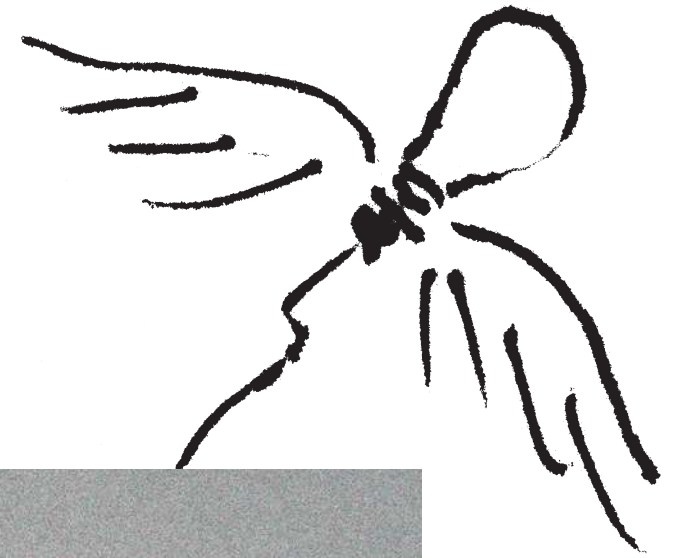

285

LUCCELLINO NT

286



SEVEN OFF THE WALL **LED OR HALOGEN**

287





DEW DROPS WALL



A sophisticated
LED high-tech
development
turned into poetry.

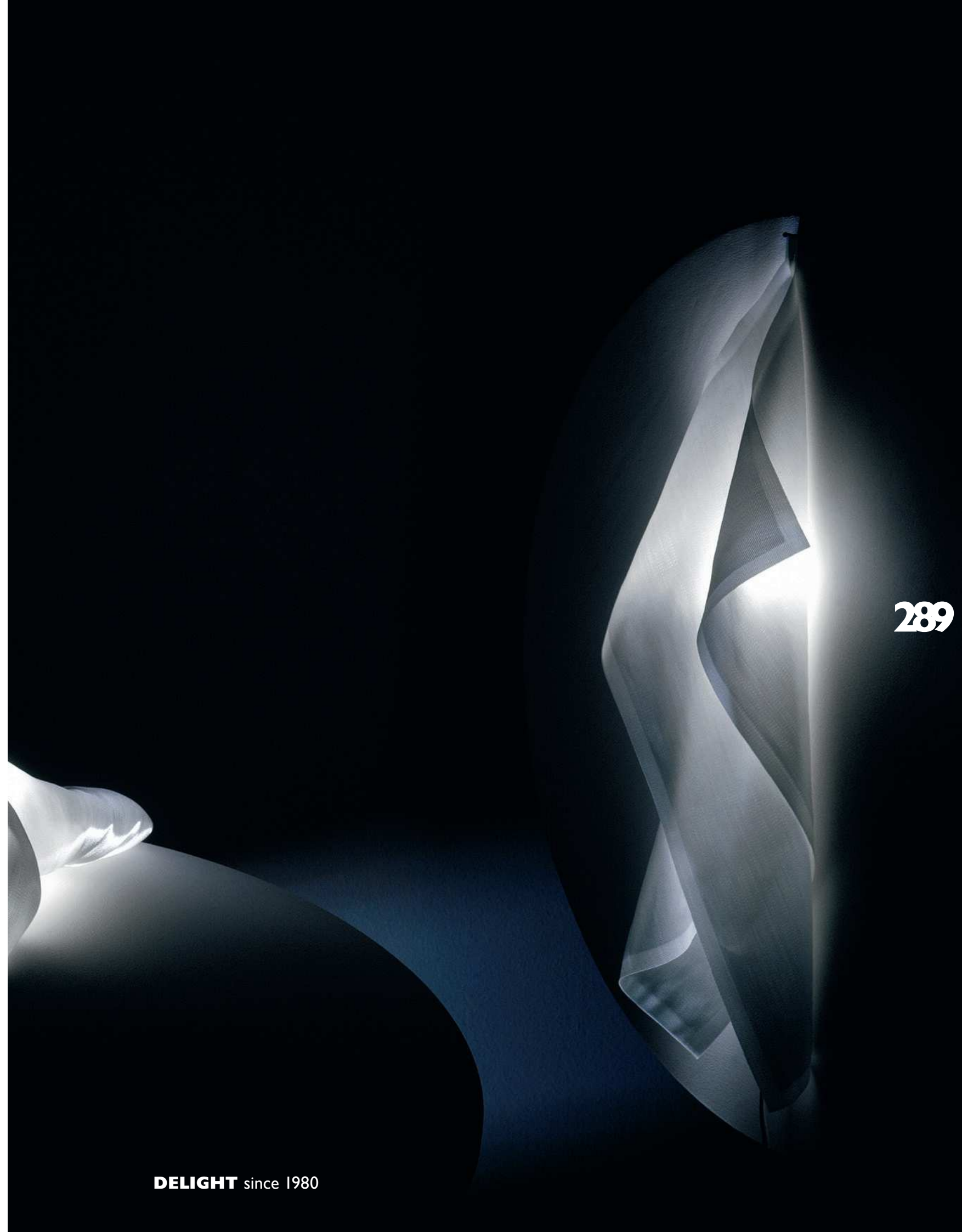

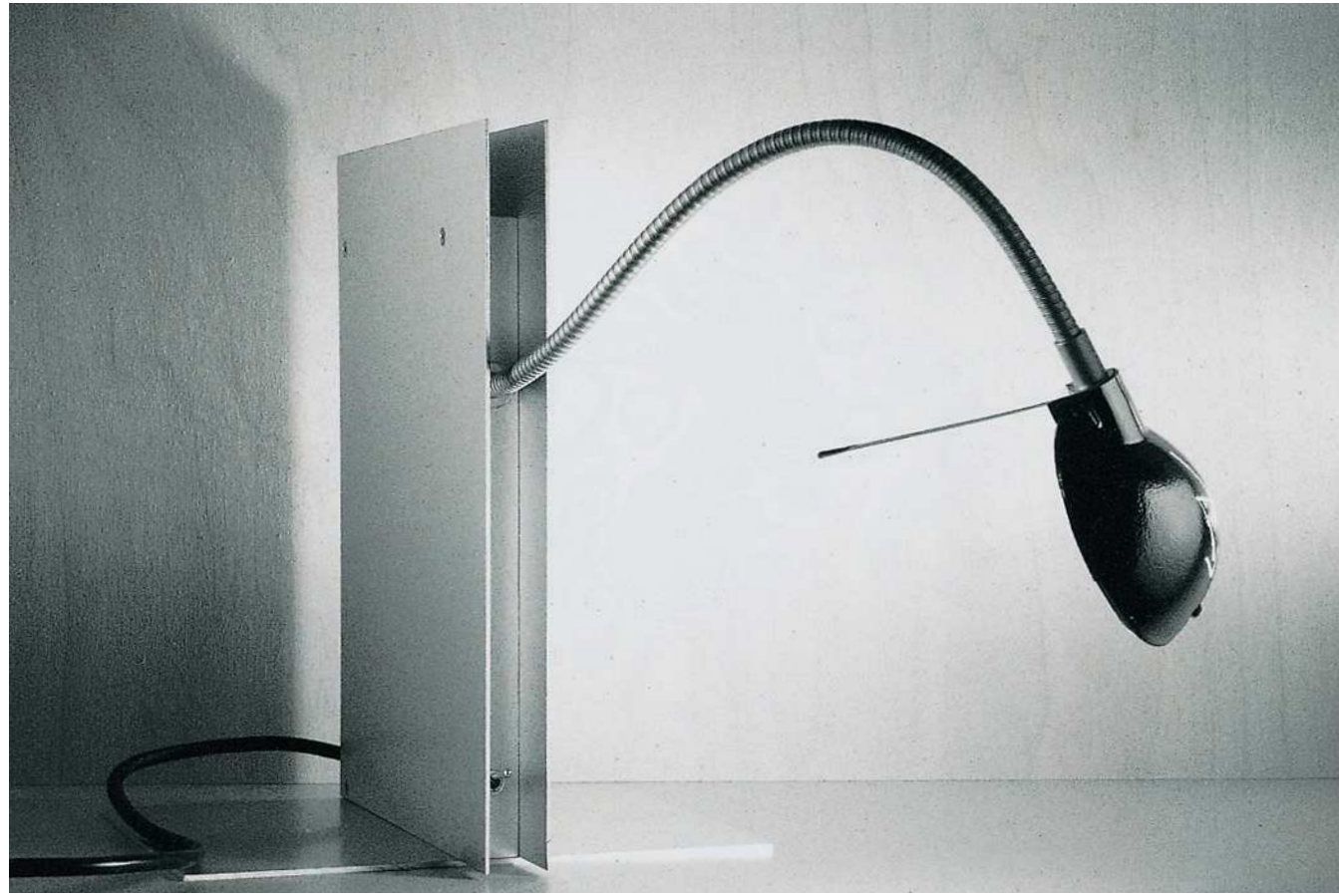

OSKAR

The body of the lamp serves as book-end.
Flexible metal arm allows variable adjustment of the lamp head.

LED'S OSKAR





LIGHT AU LAIT

The cup on the wall
fits nicely, but not
exclusively into
kitchens and cafes.



© bpk / Walter Vogel



CANNED LIGHT



ZERO•ONE

Up- and downlight:
the direction of the
light can be altered
by adjustable mirror.

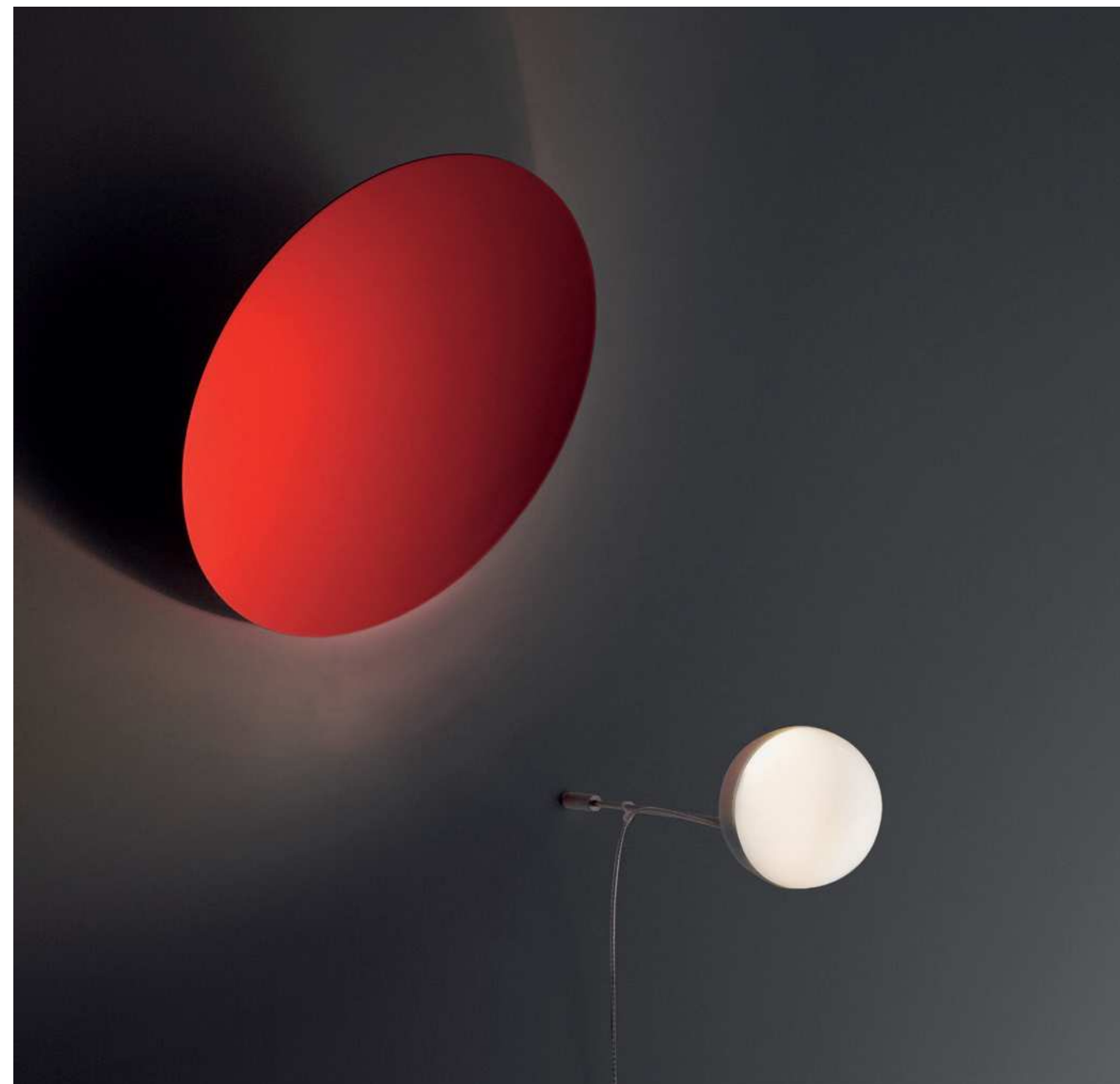

AKA_TSUKI

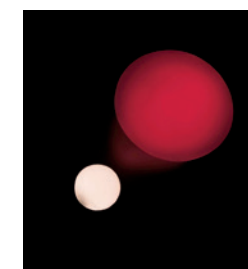

Aka_Tsuki:
red moon
in Japanese.

296



HOLONZKI



DEAD BULB ALIVE*



297

* Limited edition



SPOCK

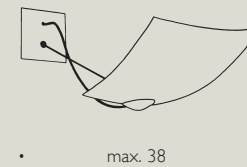

max. 38



ca. 40-80



27

38

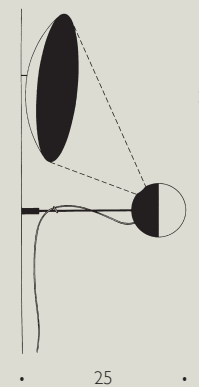

25

18x18 Ingo Maurer und Team 2015

Schirm aus pulverbeschichtetem Aluminium, Edelstahl, Kunststoff. Zwei Kugelgelenke ermöglichen eine äußerst flexible Ausrichtung. ■ Lamp shade in powder-coated aluminium, stainless steel, plastic. Two ball-joints provide high flexibility. Also available with cable and dimmer switch. The 110–125 volts version is delivered with adapter plate to cover standard U.S. 4 inch octagonal junction boxes. ■ Ecran en aluminium revêtu par poudre, acier spécial, matière plastique. Deux rotules permettent une orientation très flexible. Aussi disponible avec câble et interrupteur. ■ Paralume in alluminio verniciato a polvere; acciaio inossidabile, materiale sintetico. Due giunti a sfera consentono una regolazione particolarmente flessibile. Anche disponibili con cavo e interruttore.

LED dimmable, 20 W, 1600 lm, 3000 K, CRI 90, EEC A+ ⚡ 220–240 V / 110–125 V

2x18x18 Ingo Maurer und Team 2016

Schirme aus pulverbeschichtetem Aluminium, Edelstahl, Kunststoff. Zwei Kugelgelenke ermöglichen eine äußerst flexible Ausrichtung. ■ Lamp shades in powder-coated aluminium, stainless steel, plastic. Two ball-joints provide high flexibility. ■ Ecran en aluminium revêtu par poudre, acier spécial, matière plastique. Deux rotules permettent une orientation très flexible. ■ Paralume in alluminio verniciato a polvere; acciaio inossidabile, materiale sintetico. Due giunti a sfera consentono una regolazione particolarmente flessibile.

2 x LED dimmable, 20 W, 1600 lm, 3000 K, CRI 90, EEC A+ ⚡ 220–240 V / 110–125 V

24 Karat Blau Wall Axel Schmid 2005/2017

Vier Platten aus in Acrylglas eingegossenem Blattgold, Metallstäbe in Rot. ■ Four plates made of gold leaf sealed in acrylic glass, metal rods in Red. ■ Quatre plaques en feuilles d'or moulées dans du verre acrylique, tiges en métal rouge. ■ Quattro lastre con foglia d'oro colata in vetro acrilico, aste rosse in metallo.

LED or Halogen E27, max. 60 W, EEC A++-E ⚡ 250 cm

Aka_Tsuki Matthias Liedtke 2003

Metall, Glas. Aus einer Opalgaskugel Ø 8,5 cm angestrahlt, scheint eine rot pigmentierte Schale räumlich vor der Wand zu schweben. ■ Metal, glass. Illumination comes from wall mounted opaline glass ball Ø 8,5 cm, a red-pigmented bowl seems to be floating three-dimensionally on the wall. ■ Métal, verre. Eclairée par une sphère opaline, Ø 8,5 cm, une soucoupe pigmentée de rouge semble flotter en trois dimensions devant le mur. ■ Metallo, vetro. Illuminata da una sfera opalina, Ø 8,5 cm, un piatto colorato rosso sembra galleggiare tridimensionalmente davanti alla parete.

LED or Halogen GU 4, max. 35 W, EEC A++-E ⚡ 230/125/12 V ⚡ 200 cm

EU: The halogen version is a phase-out model, please check our website for up-to-date info and technical details of the new LED version.



Canned Light Christoph Matthias, Hagen Szezech 2003

Aluminium, Edelstahl, Kunststoff. Eine Konservendose, befüllt mit Leuchtmittel, Reflektor, Fassung, Kabel und Schalter wird zur Hänge- oder Wandlampe. Aufputz-Montage mit Abdeckscheibe weiß Ø 8 cm. Stufenlos höhenverstellbar durch Umlenkrolle und Justier-ring. ■ Aluminium, stainless steel, plastic. A tin can, containing lightbulb, reflector, socket, cable and switch, turns into a hanging or wall lamp. Surface-mounted ceiling fixture with white baseplate cover Ø 8 cm. Height freely adjustable with pulley and ring. ■ Aluminium, acier inoxydable, matière plastique. Une boîte de conserves, contenant ampoule, réflecteur, douille, câble, interrupteur se transforme en suspension ou applique. Montage sur crépi avec rondelle blanche de recouvrement Ø 8 cm. Réglable en hauteur sans graduation par poulie de renvoi et anneau coulissant. ■ Alluminio, acciaio inossidabile, materiale sintetico. Un barattolo da conserva, contenente lampadina, portalampada, riflettore, cavo e interruttore, si trasforma in una lampada a sospensione o da parete. Scatola di derivazione esterna con piastra bianca di copertura Ø 8 cm. Regolazione continua dell'altezza con carrucola e anello di bloccaggio.

© 2003 and trademark by Campbell Soup Company used under license. All rights reserved.

💡 60 W Halogen, 980 lm, 2800 K, 2000 h, EEC C 🌀 G9, max. 60 W, A++-E 📏 200 cm

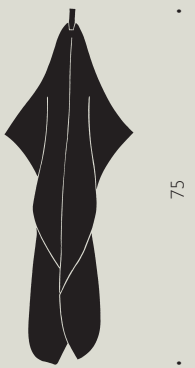

Delight Frans van Nieuwenborg, Martijn Wegman 1980

Hitzebeständiges Glasgewebe, Dauerbelastung bis 180° C möglich. Tuchformat 75 x 75 cm. ■ Heat-resistant glass fabric. Capable of withstanding continuous use at temperatures of up to 180° C. Cloth size 75 x 75 cm. ■ Fibre de verre résistant à la chaleur, supporte une chaleur continue jusqu'à 180°C max. Format du tissu en fibre de verre 75 x 75 cm. ■ Tessuto in fibre di vetro termoresistente. Sostiene calore continuo fino a 180°C. Misure del tessuto cm. 75 x 75.

💡 LED or Halogen 🌀 E27, max. 40 W, EEC A++-E 📏 180 cm white

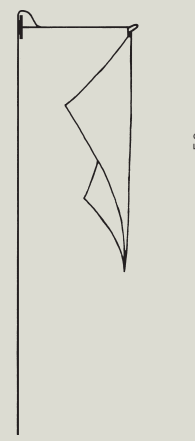

Dew Drops Wall Ingo Maurer Team 2014

Transparente Kunststoffolie mit integrierten LEDs, Metall. Die Folie ist an einer Ecke aufgehängt und fällt fast wie ein Tuch. Die Form lässt sich mit einem schlichten Metallstäbchen fixieren. Mit Sensorschalter zum Anschalten und Dimmen auf der Folie. ■ Transparent plastic sheet with integrated LEDs, metal. Suspended at one corner, the sheet is reminiscent of a cloth. The shape is adjustable with a metal pin. With a dimmable touch sensor switch on the sheet. ■ Film plastique transparent avec LEDs intégrés, métal. Le film plastique est accroché dans un coin et fait penser à un tissu qui pend. Une simple baguette en métal permet de fixer le film plastique. Avec interrupteur à sensor tactile pour allumer et faire varier l'intensité de la lumière sur le film plastique. ■ Pellicola trasparente in materiale sintetico con LED integrati, metallo. La pellicola è fissata da un angolo e ricorda un tessuto appeso. La sua forma può essere mantenuta con una semplice astina di metallo. Interruttore a sensore sulla pellicola stessa per accendere, spegnere e dimmerare.

💡 LED dimmable, 23 W, 2600 lm, 3000 K, CRI 90, EEC A

📏 100-240 V, EU or US 📏 200 cm

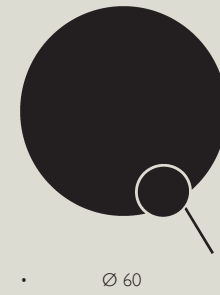

Eclipse Ellipse Ingo Maurer 2017

Stahl, Aluminium. Neigung der beiden Scheiben kann angepasst werden. Die kleine Scheibe mit dem Lichtmodul ist mit einem Magneten befestigt und kann rund um die große Scheibe platziert werden. Ein Spiel mit Licht und Schatten. ■ Steel, aluminium. The inclination of both discs is adjustable. The small disc with integrated LED is fixed magnetically, and can be placed anywhere around the large disc. A play with light and shadow. ■ Acier, aluminium. L'inclinaison des deux disques peut être adaptée. Le petit disque avec le module lumineux est fixé par un aimant et peut être placé tout autour du grand disque. Un jeu d'ombres et de lumière. ■ Acciaio, alluminio. L'inclinazione dei due dischi è modificabile. Il disco minore con l'unità illuminante è fissato con una calamita e può essere disposto intorno al disco maggiore. Un gioco di luci e ombre.

💡 LED 12 W, dimmable, 1130 lm, 2700 K, CRI 97, EEC A++ 📏 200-240 V/100-125 V

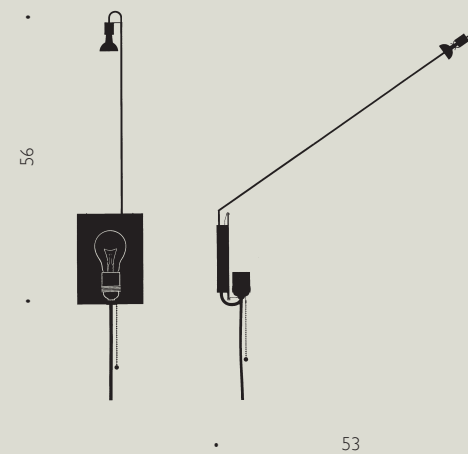

Holonzki / Dead Bulb Alive Eckard Knuth, Ingo Maurer 2000

Glas-Hologramm 13 x 18 cm, Metall, schwarzes Textilkabel. Auswahl/Festlegung der Hologrammfarbe aus technischen Gründen nicht möglich. Direkte Sonneneinstrahlung und Nikotin können die Lebensdauer des Hologramms reduzieren. ■ Glass hologram 13 x 18 cm, metal, black fabric cable. For technical reasons, customer choice of hologram colour is not possible. Direct sunlight and nicotine may reduce the hologram's life span. ■ Hologramme en verre 13 x 18 cm, métal, câble de textile noir long de 250 cm. Pour des raisons techniques, le choix de la couleur de l'hologramme n'est pas possible. Une exposition directe au soleil et à la nicotine peut réduire la durée de vie de l'hologramme. ■ Ologramma in vetro cm. 13 x 18, metallo, cavo tessile nero. Per ragioni tecniche non è possibile la scelta del colore dell'ologramma. L'esposizione diretta al sole e alla nicotina possono ridurre la durata dell'ologramma.

💡 LED or Halogen 🌀 GU 4, max. 20 W, EEC A++-E 📏 230/125/12 V 📏 250 cm

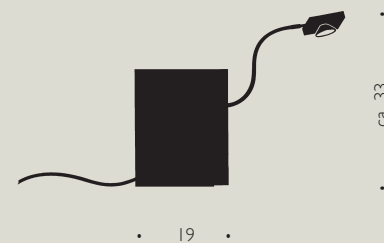

LED's Oskar Ingo Maurer and Team 2012

Eloxiertes Aluminium in Schwarz oder Silber, Metall. Ein flexibler Metallarm ermöglicht die variable Einstellung des Kopfes. Elektronischer Sicherheitstransformator mit integriertem Kippschalter. ■ Anodised aluminium in black or silver, metal. The flexible metal arm allows variable adjustment of the lamp head. Electronic safety transformer with integrated toggle switch. ■ Aluminium anodisé noir ou argent, métal. Le bras métallique flexible permet le réglage variable du réflecteur. Transformateur électronique de sécurité avec interrupteur à bascule intégré. ■ Alluminio anodizzato nero o argento, metallo. Il braccio metallico flessibile permette la regolazione variabile del riflettore. Trasformatore di sicurezza elettronico con interruttore a levetta integrato.

💡 LED, 5 W, 420 lm, 3000 K, 40000 h, CRI 80, EEC A 📏 100-240 V 📏 400 cm

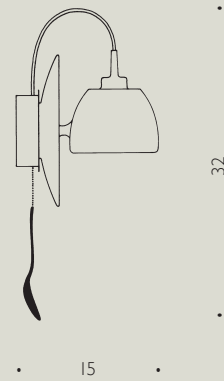

32

15

Light au Lait Fabien Dumas, Ingo Maurer und Team 2004

Steingut, Silikon, Edelstahl. Durch Kugelgelenk um 180° drehbar und um 30° verstellbar. Eingebauter Zugschalter mit Löffel. Mit Aufputz-Montagedose. Die Montage ist auch auf Unterputzdose möglich. ■ Stoneware, silicone, stainless steel. The lamp swivels through 180° and can be bent down up to 30° by means of a ball joint. Integrated pull switch with spoon. Including surface-mounting box. Flush-mounted installation is also possible. ■ Faïence, silicone, acier inoxydable. Rotative et inclinable respectivement de 180° et 30° par une articulation à bille. Interrupteur à tirette intégré dans la cuillère. Avec boîtier pour montage sur crépi. Le montage sur boîtier sous crépi est également possible. ■ Maiolica, silicone, acciaio inossidabile. Orientabile di 180° e inclinabile di 30° mediante un giunto sferico. Interruttore a catenella con cucchiaino. Con scatola di derivazione esterna. È possibile il montaggio ad una scatola di derivazione incassata. Lampadina inclusa.

💡 LED or Halogen 🌀 G9, max. 60 W, EEC A++–E 📏 200 cm with plug

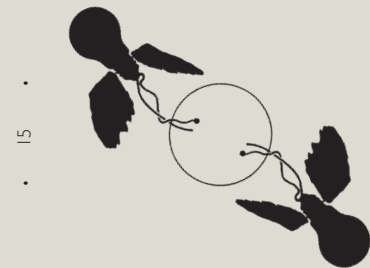

ca. 50

15

Lucellino Doppio Ingo Maurer 2018

Metall, Flügel aus Gänsefedern, zwei Niedervolt-Leuchtmittel. ■ Metal, goose-feather wings, two low-voltage bulbs, transparent cables. Complete with bulbs. ■ Métal, ailes en plumes d'oie, deux ampoules à bas voltage, câbles transparents. ■ Metallo, ali in piume d'oca, due lampadine a basso voltaggio, cavi trasparenti.

💡 2 x 35 W Halogen, 1200 lm, 3000 K, 2000 h, CRI 100, EEC C 🌀 E27 ⚡ 230/125/24 V

💡 2 x 1,5 W LED dimmable, 200 lm, 2700 K, 15000 h, CRI 85, EEC A++ 🌀 E27

⚡ 200–240/12 V AC



15

26

Lucellino NT Ingo Maurer 1992

Metall, Flügel aus Gänsefedern, zwei Niedervolt-Leuchtmittel. ■ Metal, goose-feather wings, two low-voltage bulbs, transparent cables. Complete with bulbs. ■ Métal, ailes en plumes d'oie, deux ampoules à bas voltage, câbles transparents. ■ Metallo, ali in piume d'oca, due lampadine a basso voltaggio, cavi trasparenti.

💡 35 W Halogen, 1200 lm, 3000 K, 2000 h, CRI 100, EEC C 🌀 E27 ⚡ 230/125/24 V

💡 1,5 W LED dimmable, 100 lm, 2700 K, 15000 h, CRI 85, EEC A++ 🌀 E27

⚡ 200–240/12 V AC

Lucellino Wall Ingo Maurer 1992

Glas, Messing, Kunststoff, handgefertigte Flügel aus Gänsefedern. Transformator erforderlich. Lieferung mit Ersatzglühlampe und weißer Abdeckscheibe Ø 8,5 cm. Nicht geeignet für Räume mit hoher Luftfeuchtigkeit. ■ Glass, brass, plastic, hand-crafted goosefeather wings. Transformer required. Complete with spare bulb and white base-plate Ø 8,5 cm. Not suited for rooms with high humidity. ■ Verre, laiton, matière plastique, ailes confectionnées à la main en plumes d'oie. Transformateur obligatoire. Livrée avec une ampoule de rechange et une rondelle de recouvrement blanche Ø 8,5 cm. N'est pas appropriée pour des pièces avec un fort taux humidité. ■ Vetro, ottone, materiale sintetico, ali in piume d'oca lavorate a mano. E' necessario un trasformatore. Lampadina di ricambio e piastra di copertura bianca Ø 8,5 cm incluse. Non adatta all'uso in ambienti con alta umidità.

💡 35 W Halogen, 600 lm, 2000 h, CRI 100 🌀 E27, A+–E 📏 230/125/24 V 📏 300 cm

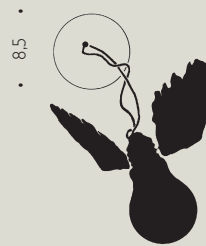

ca. 18

8,5



50

30

Luzy On The Wall Ingo Maurer 2018

Kunststoff, Metall, Niedervolt-Leuchtmittel. ■ Plastic, metal, low-voltage lamps, plastic. ■ Plastique, métal, lampes basse tension. ■ Plastica, metallo, lampade a bassa tensione.

💡 5 x 1,5 W LED, 5 x 100 lm, 15000 h, CRI 85, EEC A++ 🌀 E27 ⚡ 200–240/12 V AC

💡 5 x 10 W Halogen, 5 x 90 lm, 2000 h, CRI 100, EEC C 🌀 E27 ⚡ 230/125/24 V

Max. Mover LED Ingo Maurer und Team 2000

Aluminium, Fiberglas. Das Teleskop ist von 110 auf 210 cm ausziehbar. Durch die Aufhängung an Nylonseilen ist Max. Mover in der Höhe zu verstellen und um 180° drehbar. An seinem Griff kann der Reflektor in zwei Richtungen stufenlos eingerichtet werden. Schalter am Ende des Stabs. ■ Aluminium, fibreglass. The telescopic arm extends from 110 to 210 cm, the nylon suspension wires allow for height adjustment and the lamp can be rotated through 180°. The reflector is freely adjustable in two directions, using the handle. Integrated switch at the end of the rod. ■ Aluminium, fibre de verre. Le télescope est extensible de 110 à 210 cm. Suspendu à des fils de nylon, Max. Mover est réglable en hauteur et rotatif à 180°. Grâce à sa poignée, le réflecteur peut être réglé sans graduation dans deux directions. Interrupteur situé à l'extrémité de la tige. ■ Alluminio, vetroresina. Il braccio telescopico è allungabile da cm. 110 a cm. 210. Essendo sospesa a fili di nylon, Max. Mover è regolabile in altezza e ruota di 180°. Agendo sulla leva, il riflettore può essere regolato in continuo in due direzioni. Interruttore all'estremità dell'asta.

💡 15 W LED, 1300 lm, 3000 K, CRI 90, EEC A+ ⚡ 220–240 V / 110–125 V 📏 450 cm

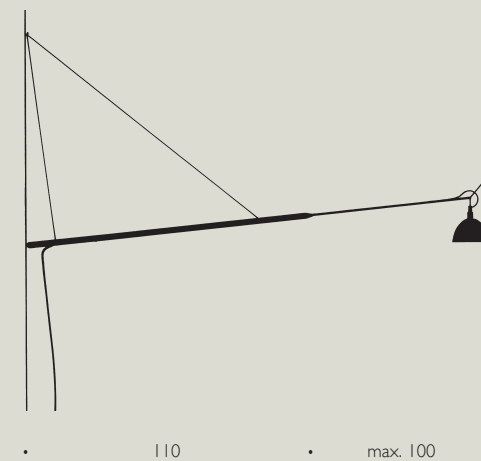

110

max. 100

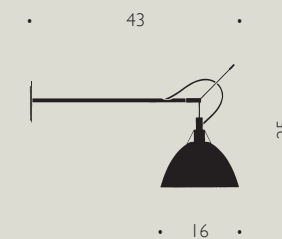

43

25

16

Max. Wall Ingo Maurer und Team 2001

Aluminium, Fiberglas, Edelstahl. Reflektor um 180° drehbar. ■ Aluminium, fibreglass, stainless steel. Reflector rotates through 180°. ■ Aluminium, fibre de verre, acier spécial. Réflecteur rotatif à 180°. ■ Alluminio, vetroresina, acciaio inossidabile. Il riflettore ruota di 180°.

💡 LED, 15 W, 1300 lm, 3000 K, CRI 90, EEC A+ ⚡ 220–240 V / 110–125 V

Oskar Ingo Maurer 1998

Metall, eloxiertes Aluminium, Reflektor mit Schutzglas. Transformator mit integriertem Kippschalter. Ein flexibler Metallarm ermöglicht die variable Einstellung des Reflektors. ■ Metal, anodized aluminium, reflector with protective glass cover. Transformer with integrated toggle switch. A flexible metal arm allows variable adjustment of the reflector. ■ Métal, aluminium anodisé, réflecteur avec verre protecteur. Transformateur avec interrupteur à bascule intégré. Un bras métallique flexible permet le réglage variable du réflecteur. ■ Metallo, alluminio anodizzato, riflettore con vetro di protezione. Trasformatore con interruttore a levetta integrato. Un flessibile braccio metallico permette la regolazione variabile del riflettore.

💡 35 W Halogen, 860 lm, 2900 K, 4000 h, EEC B 🌀 GY 6,35, max. 50 W, EEC B–E

⚡ 230/125/12 V 📏 400 cm EU: Please check availability on our website.

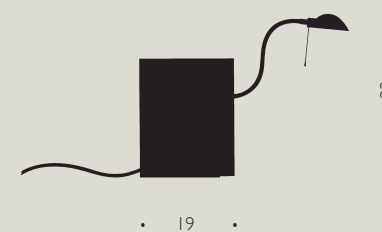

ca. 33

19

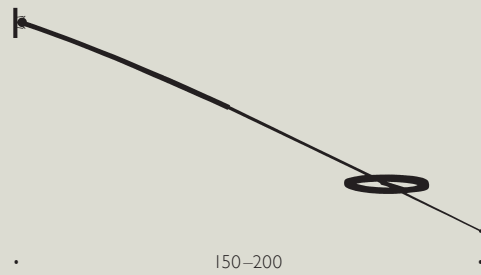

Ringelpiez Wall Ingo Maurer und Team 2017

Ausziehbarer Stab aus Kohlefaser. Kugelgelenk aus Metall als Wandbefestigung. Aluminiumring mit LEDs in Schwarz oder Weiß. Der LED-Ring kann flexibel positioniert werden. Ring als Up- oder Downlight nutzbar, mit Papierschirm Frivoloso nutzbar. Auch zur Montage an der Decke. ■ Extendable rod in carbon fibre. Ball-joint in metal as wall mounting. Aluminium ring with LEDs in Black or White. The ring of LEDs can be positioned freely, and can be attached as up or downlight, with or without the paper shade Frivoloso. Also for ceiling mounting. ■ Tige télescopique en fibre de carbone. Articulation à rotule en métal comme fixation murale. Anneau en aluminium avec LEDs en noir ou blanc. L'anneau LED peut être positionné librement. Anneau utilisable en Up- ou Downlight, avec écran papier Frivoloso. Montage au plafond aussi possible. ■ Asta telescopica in fibra di carbonio. Giunto a sfera in metallo per il fissaggio alla parete. Anello in alluminio con LED in nero o bianco. L'anello a LED può essere posizionato a piacere. L'anello può essere impiegato come uplight o downlight, utilizzabile con paralume in carta Frivoloso. Adatto anche per il montaggio al soffitto.

LED dimmable, 25 W, 3600 lm, 3000 K, CRI 95, EEC A+

100-125 V/220-240 V/36 V 400 cm

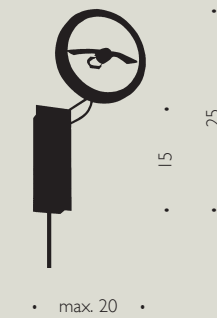

Use Me W. Ingo Maurer 2010

Edelstahl, Aluminium. Der Strahler ist über ein Kugelgelenk einstellbar. Das Leuchtmittel ist im Handel auch in anderen Ausstrahlungswinkeln und Wattagen erhältlich. ■ Stainless steel, aluminium. Adjustable via one ball-joint. In trade the light source is also available with other angles and wattages. ■ Acier inoxydable, aluminium. Spot ajustable par une articulation à rotule. L'halogène est aussi disponible en magasin avec d'autres angles et wattages. ■ Acciaio inossidabile, alluminio. Il faretto è regolabile mediante un giunto a sfera. La lampadina è anche disponibile in commercio con altri angoli d'irradiazione e wattaggi.

100 W 8° Halogen, 3000 h, EEC B G53, max. 100 W, EEC A++-E 230/125/12 V

300 cm EU: The halogen version is a phase-out model, please check our website for up-to-date info and technical details of the new LED version.



Seven off the Wall Ingo Maurer und Team 2010

Metall, Flügel aus Gänsefedern. Sieben Niedervolt-Leuchtmittel, transparente Kabel. Kabel mit Schalter, kein Dimmer. Lieferung mit Leuchtmitteln. ■ Metal, goose-feather wings. Seven low-voltage bulbs, transparent cables. Cable with switch, no dimmer included. Complete with bulbs. ■ Métal, ailes en plumes d'oie, sept ampoules à bas voltage, câbles transparents avec interrupteur, dimmer non inclus. Livrée avec ampoules. ■ Metallo, ali in piume d'oca, sette lampadine a basso voltaggio, cavi trasparenti. Cavo con interruttore, dimmer non incluso. Lampadine incluse.

7 x 10 W Halogen, 7 x 90 lm, 2000 h, CRI 100, EEC C E27 230/125/24 V 200 cm

7 x 1,5 W LED, 7 x 100 lm, 2700 K, 15000 h, CRI 85, EEC A++ E27 220-240/12 V AC

200 cm

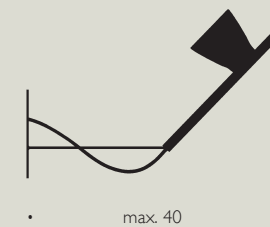

WaLL.E.D Konrad Lohöfener, Hagen Sczech 2017

Eloxiertes Aluminium in Schwarz oder Silber, Edelstahl, Kunststoff. Kugelgelenk und abgewinkelter Stab ermöglichen die flexible Ausrichtung. Mit abnehmbaren Reflektor zur Nutzung als Spot. ■ Anodised aluminium in Black or Silver, stainless steel, plastic. A ball-joint and the angled rod allow for flexible adjustments. provides flexibility. Removable reflector for use as spot. ■ Aluminium anodisé en noir ou argent, métal, matière plastique. Un joint à rotule et la tige coudée permettent un alignement flexible. Avec réflecteur supplémentaire Spot. ■ Alluminio anodizzato in nero o argento, metallo, materiale sintetico. Orientabile con giunto a sfera e asta inclinata orientabile. Con riflettore supplementare.

LED dimmable, 15 W, 1300 lm, 3000 K, CRI >90, EEC A 200-240 V / 110-125 V

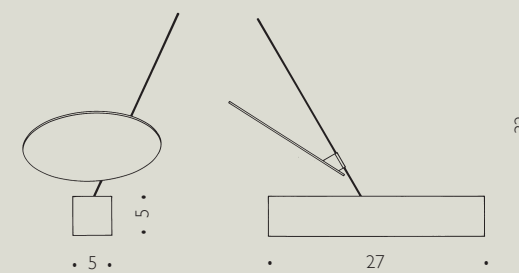

Spock Bernhard Dessecker 1998

Edelstahl, Glas, Aluminium. Der Strahler ist über ein Kugelgelenk einstellbar. Aufputz-Montagedose mit Abdeckscheibe Ø 8 cm. Die Montage auf eine Unterputzdose ist ebenfalls möglich. Auch an der Wand zu montieren. ■ Stainless steel, glass, aluminium. Adjustable via ball-joint. Box with cover Ø 8 cm, for surface mounting. Flush mounting also possible, or can be fixed to wall. ■ Acier inoxydable, verre, aluminium. Le spot est orientable par articulation à rotule. Boîte pour le montage sur crépi avec rondelle de recouvrement Ø 8 cm. Le montage sur une boîte encastrable sous crépi est également faisable. Possibilité de montage en applique. ■ Acciaio inossidabile, vetro, alluminio. Il faretto è regolabile mediante un giunto sferico. Scatola di derivazione esterna a soffitto con rosone Ø cm. 8. Possibilità di montaggio con una scatola di derivazione incassata. E' possibile montarla anche a parete.

LED or Halogen E27, max. 75 W, EEC A++-E

zero-one Ingo Maurer und Team 1990

Weißes Corian, mattierter Spiegel. Der bewegliche Spiegel dient zur Lichtumlenkung. ■ Corian, white, frosted mirror. The direction of the light can be altered by adjusting the position of the mirror. ■ Corian blanc, miroir mat. Le miroir mobile permet de modifier le faisceau lumineux. ■ Corian bianco, specchio smerigliato. Lo specchio regolabile serve per indirizzare la luce.

60 W Halogen, 980 lm, 2000 h, EEC C B15d, max. 60 W, A++-E

EU: Please check availability on our website.

The MaMoNouchies[®] 309

The tribe is growing.

When Ingo Maurer encountered a textile sample made by Dagmar Mombach, it was love at first sight. For the MaMo Nouchies the concept was applied to the unique lightness and modesty of paper which has been one of his favourite materials for many years. Transformed by the elaborate process invented by Dagmar, the paper can be formed in a variety of new ways. Our aim has always been to make lighting that combines visual beauty with technical sophistication and this is exactly how we see The MaMo Nouchies®.

+ New members

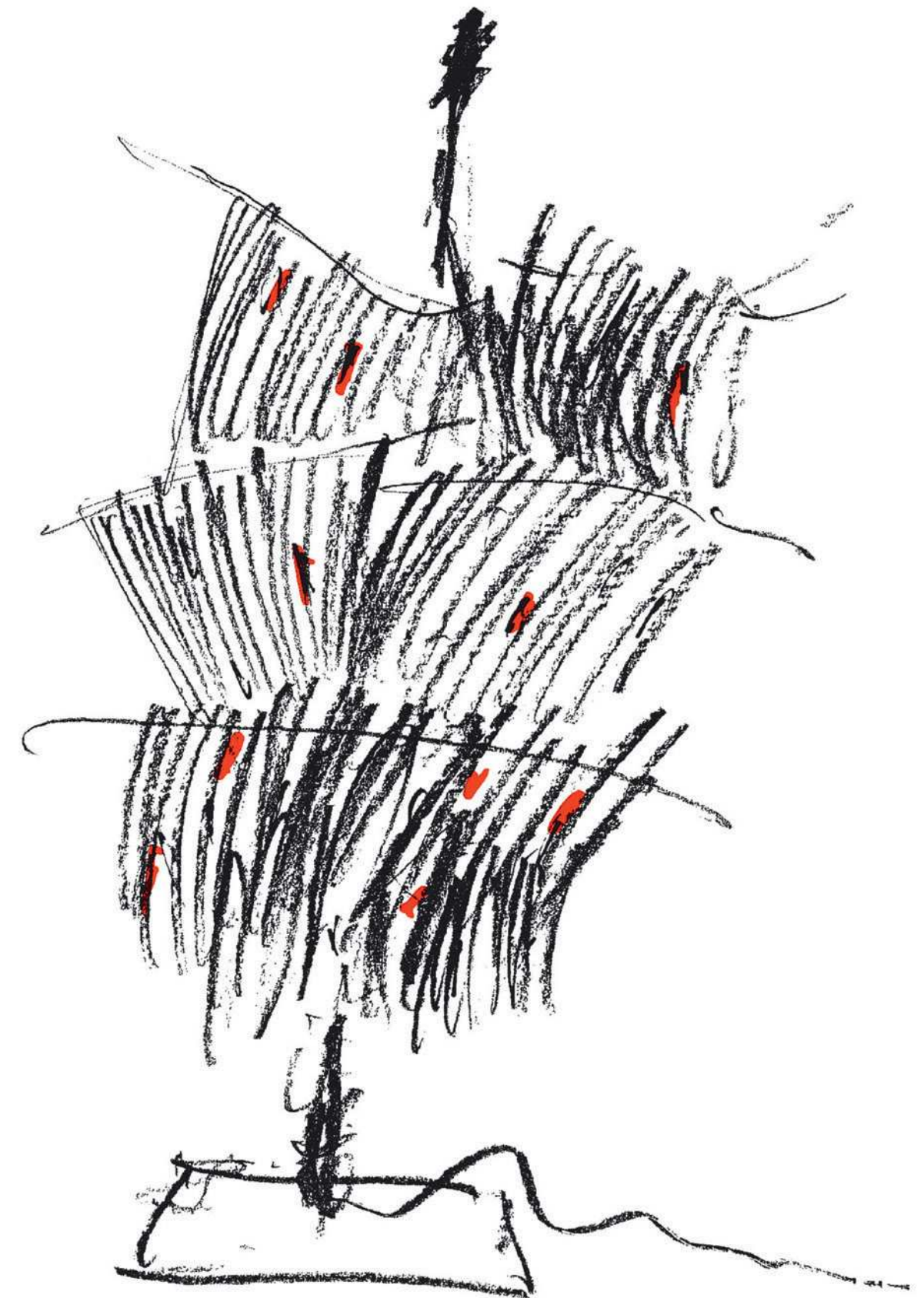

First sketch, 1997



First prototype of „Walking in The Rain“



WALKING IN THE RAIN INGO MAURER
1.1.1984 - 2004 IM. C. B. 1990

WALKING IN THE RAIN

314



MOONATI



315

YORUBA ROSE

316



BABADUL

317



Kokoro is the
word for „heart“
in Japanese.



318



319

KOKORO

320



SAMURAI

321



POUL POUL

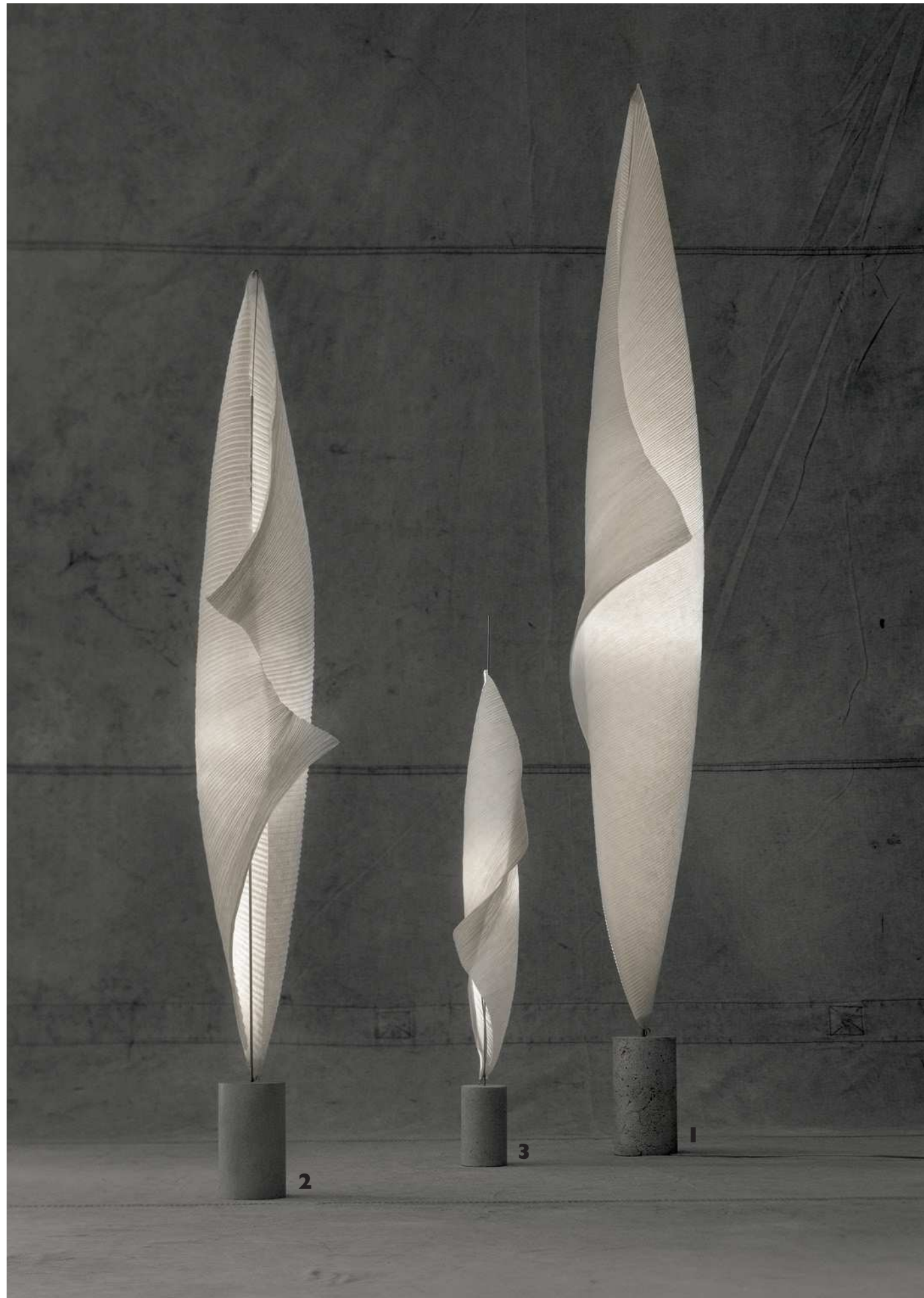

WO-TUM-BU FAMILY



CON-QUI



The MaMo Nouchies Werkstatt

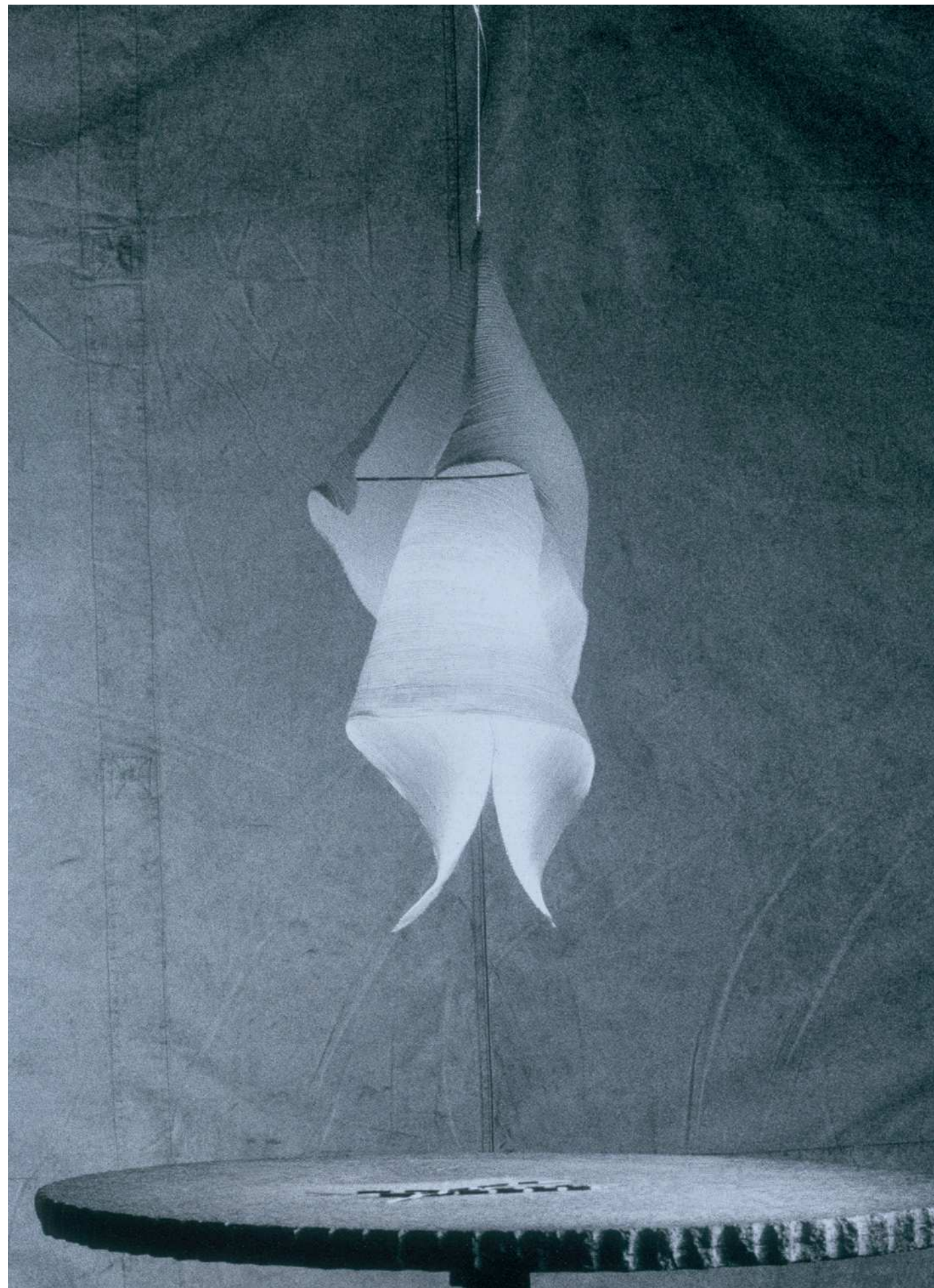

JIMKEN



YSMEN

326



MAHBRUKY

327



WATAPUNGA

jealous of the moon



GAKU





The MaMo Nouchies exhibited at a museum in New York, 2007

Let there be LED!

The MaMo Nouchies members will be equipped with LED.

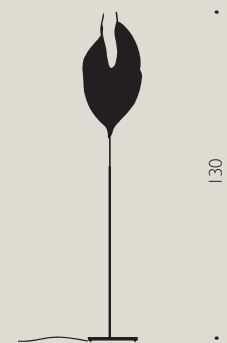

130

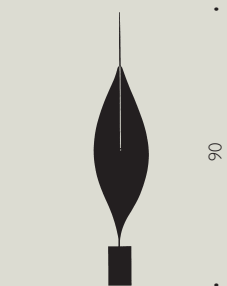

90



95



70



80

Babadul Ingo Maurer und Team 2017

Papier, Metall, Edelstahl, Silikon. ■ Paper, metal, stainless steel, silicone. ■ Papier, métal, acier spécial, silicone ■ Carta, metallo, acciaio inossidabile, silicone.

📷 9 W LED, 1000 lm, 2700 K, CRI >90, EEC A*

Con-Qui Dagmar Mombach, Ingo Maurer und Team 1998

Papier, Beton, Metall, Edelstahl, Kohlefaser, Silikon, Glasfaserblende. ■ Paper, concrete, metal, stainless steel, carbon-fibre, silicone, glassfibre shade. ■ Papier, béton, métal, acier inoxydable, fibre de carbone, silicone, écran fibre de verre. ■ Carta, calcestruzzo, metallo, acciaio inossidabile, fibra di carbonio, silicone, schermo in vetroresina.

💡 50 W Halogen, 910 lm, 3000 K, 2000 h, EEC C 📷 GY 6,35, max. 50 W, EEC B-E

🔌 230/125/12 V EU: The halogen version is a phase-out model, please check our website for up-to-date info and technical details of the new LED version.

Gaku Dagmar Mombach, Ingo Maurer und Team 1998

Papier, Metall, Edelstahl, Silikon, Glas. ■ Paper, metal, stainless steel, silicone, glass. ■ Papier, métal, acier inoxydable, silicone, verre. ■ Carta, metallo, acciaio inossidabile, silicone.

💡 50 W Halogen, 910 lm, 3000 K, 2000 h, EEC C 📷 GY 6,35, max. 50 W, EEC B-E

🔌 230/125/12 V EU: The halogen version is a phase-out model, please check our website for up-to-date info and technical details of the new LED version.

Jimken Dagmar Mombach, Ingo Maurer und Team 1998

Papier, Metall, Edelstahl, Silikon, Glas. ■ Paper, metal, stain-less steel, silicone, glass. ■ Papier, métal, acier inoxydable, silicone, verre. ■ Carta, metallo, acciaio inossidabile, silicone, vetro.

💡 50 W Halogen, 910 lm, 3000 K, 2000 h, EEC C 📷 GY 6,35, max. 50 W, EEC B-E

🔌 230/125/12 V 📏 300 cm EU: The halogen version is a phase-out model, please check our website for up-to-date info and technical details of the new LED version.

Kokoro Dagmar Mombach, Ingo Maurer und Team 1998

Rotes Papier, Metall, Edelstahl, Glas, Kunststoff. Verstellbarer Spiegel. Nicht geeignet für Räume mit hoher Luftfeuchtigkeit. ■ Red paper, metal, stainless steel, glass, plastic. Adjustable mirror. Not suited for rooms with high humidity. ■ Papier rouge, métal, acier inoxydable, verre, matière plastique. Miroir mobile. N'est pas appropriée pour des pièces avec un fort taux humidité. ■ Carta rossa, metallo, acciaio inossidabile, vetro, materiale sintetico. Specchio orientabile. Non adatta all'uso in ambienti ad alta umidità.

💡 50 W Halogen, 910 lm, 3000 K, 2000 h, EEC C 📷 GY 6,35, max. 50 W, EEC B-E

🔌 230/125/12 V EU: The halogen version is a phase-out model, please check our website for up-to-date info and technical details of the new LED version.



110

Mahbruky Dagmar Mombach, Ingo Maurer und Team 1998

Papier, Metall, Silikon, Glas, Aluminium, verstellbarer Spiegel. 230 Volt: Zwei elektronische Transformatoren, getrennt stufenlos dimmbar. 125 Volt: Transformator ohne Dimmer. Die Position der einzelnen Elemente ist variabel. ■ Paper, metal, silicone, glass, aluminium, adjustable mirror: 230 volts: two electronic transformers, separately continuously dimmable. 125 volts: transformer without dimmer. Position of lighting elements is variable. ■ Papier, métal, silicone, verre, aluminium. 230 volts: deux transformateurs électroniques, avec réglage d'intensité lumineuse séparé. 125 volts: transformateur sans réglage d'intensité lumineuse. La position des éléments individuels est variable. ■ Carta, metallo, silicone, vetro, alluminio. 230 volt: Due trasformatori elettronici, regolabili separatamente. 125 volt: Trasformatore senza variatore. La posizione degli elementi è variabile.

💡 5 x 35 W Halogen, 910 lm, 3000 K, 2000 h, EEC C ⚡ GY 6,35, max. 50 W, EEC B-E

🔌 2 x 230/125/12 V EU: Please check availability on our website.



50

Moonati Dagmar Mombach, Ingo Maurer und Team 2017

Papier, Metall, Edelstahl, Silikon. ■ Paper, metal, stainless steel, silicone. ■ Papier, métal, acier spécial, silicone ■ Carta, metallo, acciaio inossidabile, silicone.

💡 9 W LED, 1000 lm, 2700 K, CRI >90, EEC A+

Poul Poul Dagmar Mombach, Ingo Maurer und Team 1998

Papier, Metall, Edelstahl, Silikon, Glas. ■ Paper, metal, stainless steel, silicone, glass. ■ Papier, métal, acier inoxydable, silicone, verre. ■ Carta, metallo, acciaio inossidabile, silicone.

💡 50 W Halogen, 910 lm, 3000 K, 2000 h, EEC C ⚡ GY 6,35, max. 50 W, EEC B-E

🔌 230/125/12 V EU: The halogen version is a phase-out model, please check our website for up-to-date info and technical details of the new LED version.

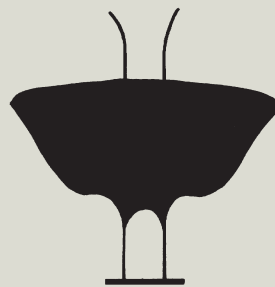

70

Samurai Dagmar Mombach, Ingo Maurer und Team 1998

Papier, Metall, Edelstahl, Silikon, Glas, Glasfaserblenden. ■ Paper, metal, stainless steel, silicone, glass, glass-fibre shades. ■ Papier, métal, acier inoxydable, silicone, verre, écrans fibre de verre. ■ Carta, metallo, acciaio inossidabile, silicone, vetro, schermi in vetroresina.

💡 50 W Halogen, 910 lm, 3000 K, 2000 h, EEC C ⚡ GY 6,35, max. 50 W, EEC B-E

🔌 230/125/12 V EU: The halogen version is a phase-out model, please check our website for up-to-date info and technical details of the new LED version.

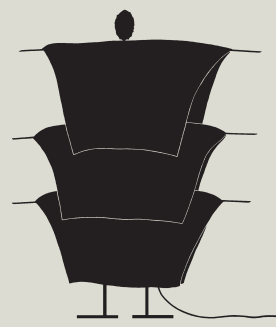

140

Walking In The Rain Ingo Maurer und Team 2017

Papier, Metall, Edelstahl, Silikon. ■ Paper, metal, stainless steel, silicone. ■ Papier, métal, acier spécial, silicone ■ Carta, metallo, acciaio inossidabile, silicone.

💡 2 x 9 W LED, 2000 lm, 2700 K, CRI >90, EEC A+

110

Watapunga Dagmar Mombach, Ingo Maurer und Team 1998

Fuß in Stahl. Papier nur natur, Metall, Silikon, Glas, Aluminium, verstellbarer Spiegel. ■ Base in steel. Paper natural only, metal, silicone, glass, aluminium, adjustable mirror. ■ Pied en acier. Papier uniquement couleur nature, métal, silicone, verre, aluminium, miroir réglable. ■ Base in acciaio. Carta solo di colore naturale, metallo, silicone, vetro, alluminio, specchio regolabile.

💡 50 W Halogen, 910 lm, 3000 K, 2000 h, EEC C ⚡ GY 6,35, max. 50 W, EEC B-E

🔌 230/125/12 V EU: Please check availability on our website.



100

Wo-Tum-Bu I Dagmar Mombach, Ingo Maurer und Team 1998

Papier, Beton, Metall, Edelstahl, Kunststoff, Glasfaserblende. Mit Schiebedimmer. ■ Paper, concrete, metal, stainless steel, plastic, glassfibre shade. Dimmer with slide-control. ■ Papier, béton, métal, acier inoxydable, plastique, écran fibre de verre. Avec variateur à curseur. ■ Carta, calcestruzzo, metallo, acciaio inossidabile, schermo in vetroresina. Con variatore lineare.

💡 LED or Halogen ⚡ E27, max. 150 W, A++-E



190

Wo-Tum-Bu 2 / Wo-Tum-Bu 3 Dagmar Mombach, Ingo Maurer und Team 1998

Papier, Beton, Metall, Edelstahl, Glasfaserblende/Glas. ■ Paper, concrete, metal, stainless steel, glass-fibre shade/glass. ■ Papier, béton, métal, acier inoxydable, écran fibre de verre/verre. ■ Carta, calcestruzzo, metallo, acciaio inossidabile, materiale sintetico, schermo in vetroresina.

💡 50 W Halogen, 910 lm, 3000 K, 2000 h, EEC C ⚡ GY 6,35, max. 50 W, EEC B-E

🔌 230/125/12 V EU: The halogen version is a phase-out model, please check our website for up-to-date info and technical details of the new LED version.

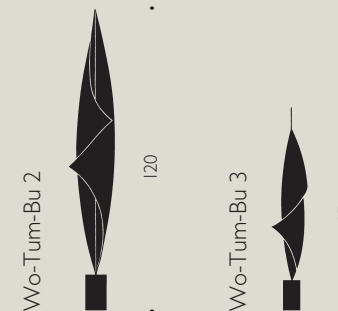

Wo-Tum-Bu 2

120

Wo-Tum-Bu 3

85



60

50

Yoruba Rose Dagmar Mombach, Ingo Maurer und Team 2017

Papier, Metall, Edelstahl, Silikon. ■ Paper, metal, stainless steel, silicone. ■ Papier, métal, acier spécial, silicone ■ Carta, metallo, acciaio inossidabile, silicone.

💡 9 W LED, 1000 lm, 2700 K, CRI >90, EEC A+

Ysmen Dagmar Mombach, Ingo Maurer und Team 1998

Papier, Metall, Edelstahl, Glas. ■ Paper, metal, stainless steel, glass. ■ Papier, métal, acier inoxydable, verre. ■ Carta, metallo, acciaio inossidabile, vetro.

💡 50 W Halogen, 910 lm, 3000 K, 2000 h, EEC C ⚡ GY 6,35, max. 50 W, B-E

🔌 230/125/12 V EU: Please check availability on our website.



70

Systeme
Systèmes
Sistemi

SYSTEMS

Yá Yá Ho

iconic since 1984

338

1980, Haiti,
drunk like a fish
at sunrise:
An early morning
New Year's
inspiration.

339



340

341

First photograph of YaYaHo, 1984



Ya Ya Ho besteht aus **Parts** und **Elementen**, die einzeln verfügbar sind. Für individuelle Zusammenstellung. Wichtig zu beachten: Gebrauchsanweisung und Gesamtwattzahl.

Ya Ya Ho is composed of **Parts** and lighting **Elements**, which are separately available. For unique configurations. Important: Study mounting instructions and observe total wattage.

Ya Ya Ho est composé de **Parts** et d'**Eléments**, qui sont disponibles séparément. Pour compositions individuelles. Important: observer attentivement les instructions de montage et le nombre total de watts.

Ya Ya Ho consiste in **Parti** ed **Elementi**, disponibili separatamente. Per soluzioni individuali. Importante: Seguire esattamente le istruzioni di montaggio e osservare la potenza massima consentita.

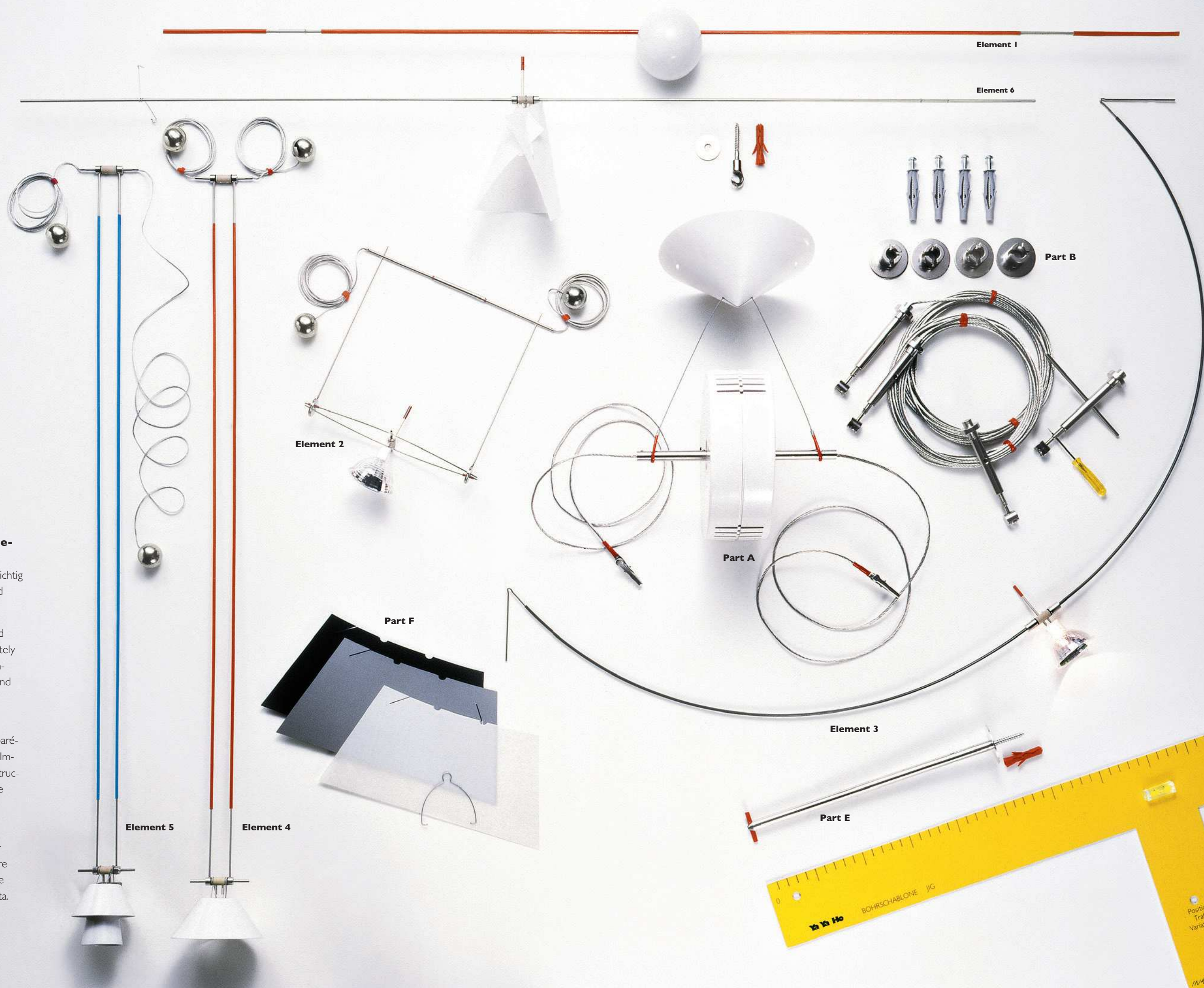

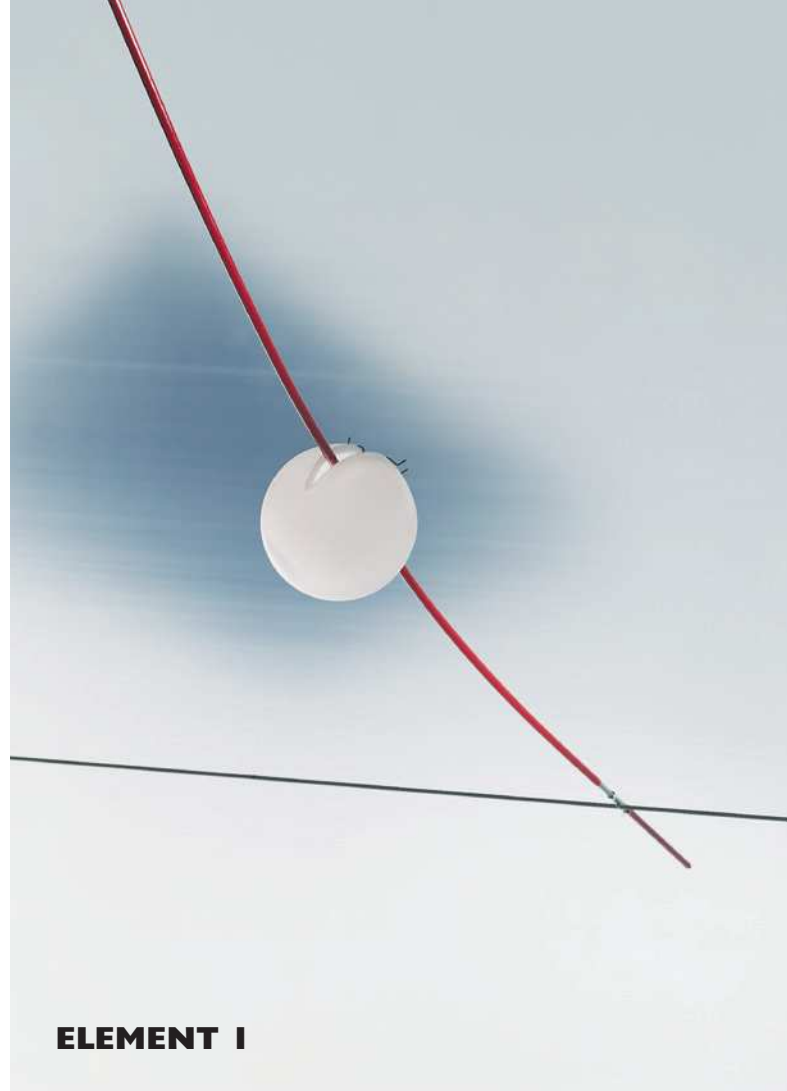

ELEMENT 1



ELEMENT 3

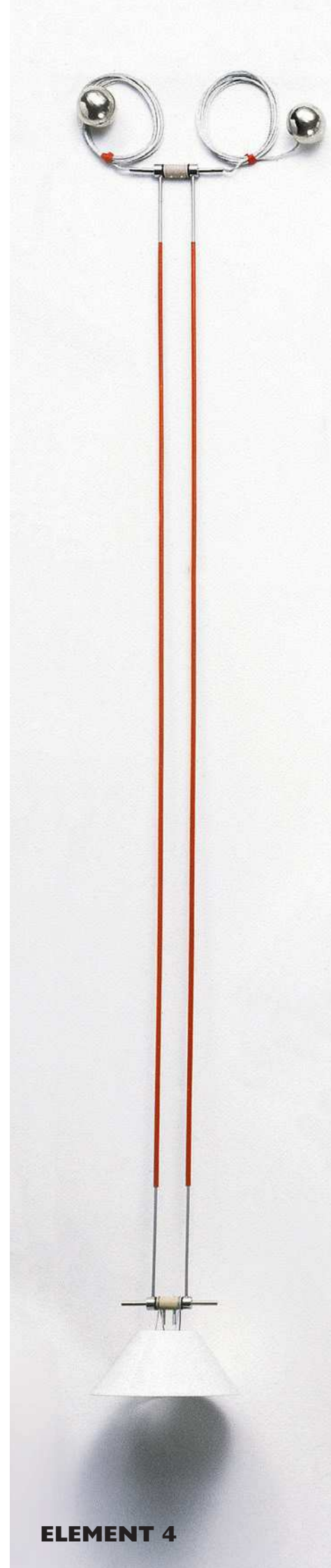

ELEMENT 4

The idea for YaYaHo (1984) came in a flash, following a New Year's celebration in Haiti, where Maurer saw how locals solder lightbulbs onto overhead power cords to illuminate street fairs. It took four years to perfect the system of suspending halogen reflectors from tautly strung low-voltage cables, and the effort almost bankrupted his company. Contemporaneous to his research, another designer, Hannes Wettstein, developed a similar concept and both were widely plagiarized.

However, the rip-offs lack the precision and artistry of the 276-part system. YaYaHo allows the user to adjust the height and placement of each suspended element as well as the tiny mirrors that bounce the light. "I want things to look unfinished, and to leave space for the people who use or look at them to add something of themselves," says Maurer. Critic Deyan Sudjic thought that YaYaHo "subverts the glossy mechanical perfection that characterizes so-called modern lighting," providing a sparkle and dazzle that take one back to the flutter of candlelight.

Michael Webb, 2003

348

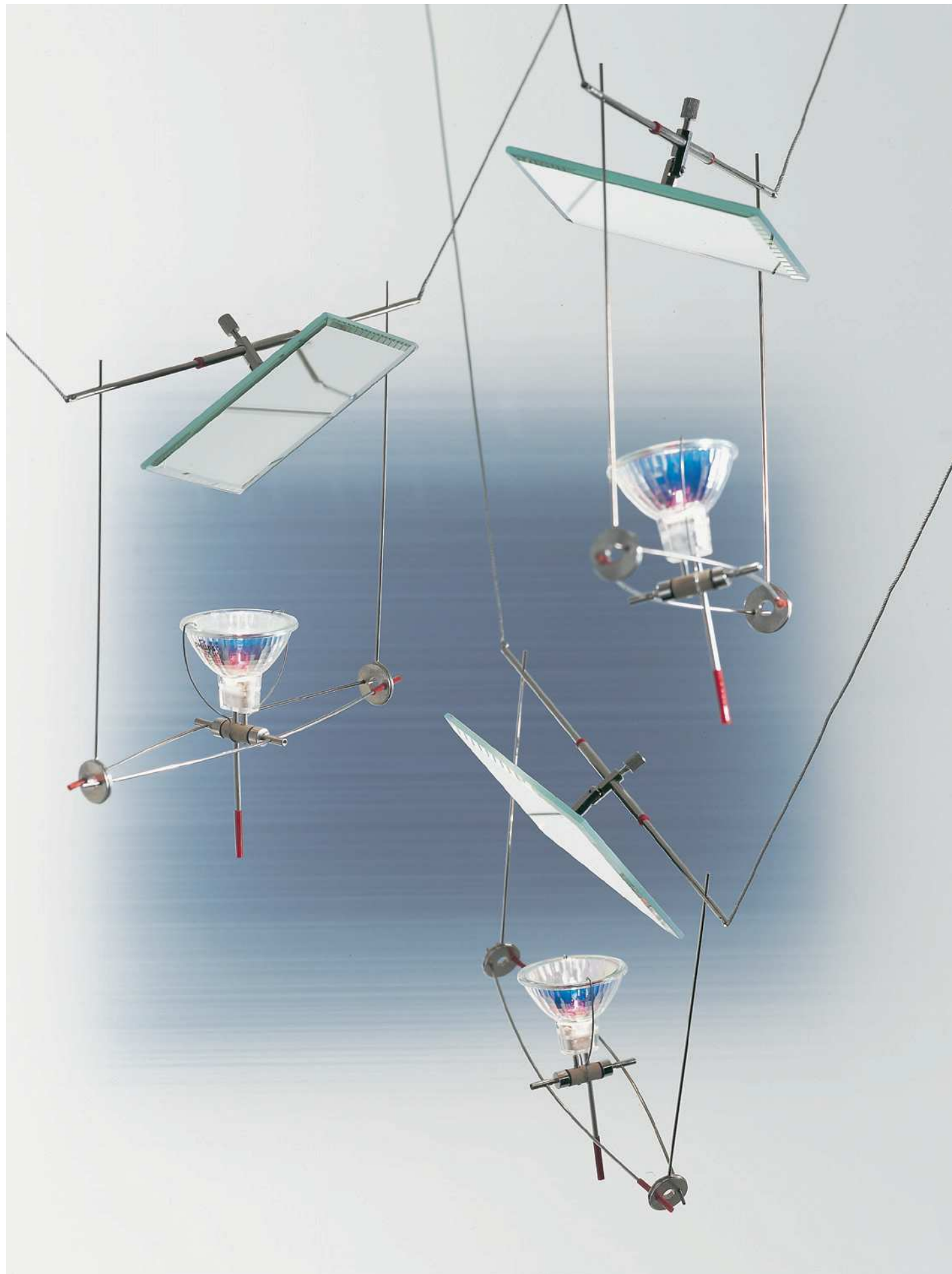

ELEMENT 2+MIRROR

349



ELEMENT 4+5

350



FUJIFILM RDPII 12262 BK EBCO QL

ELEMENT 77

351

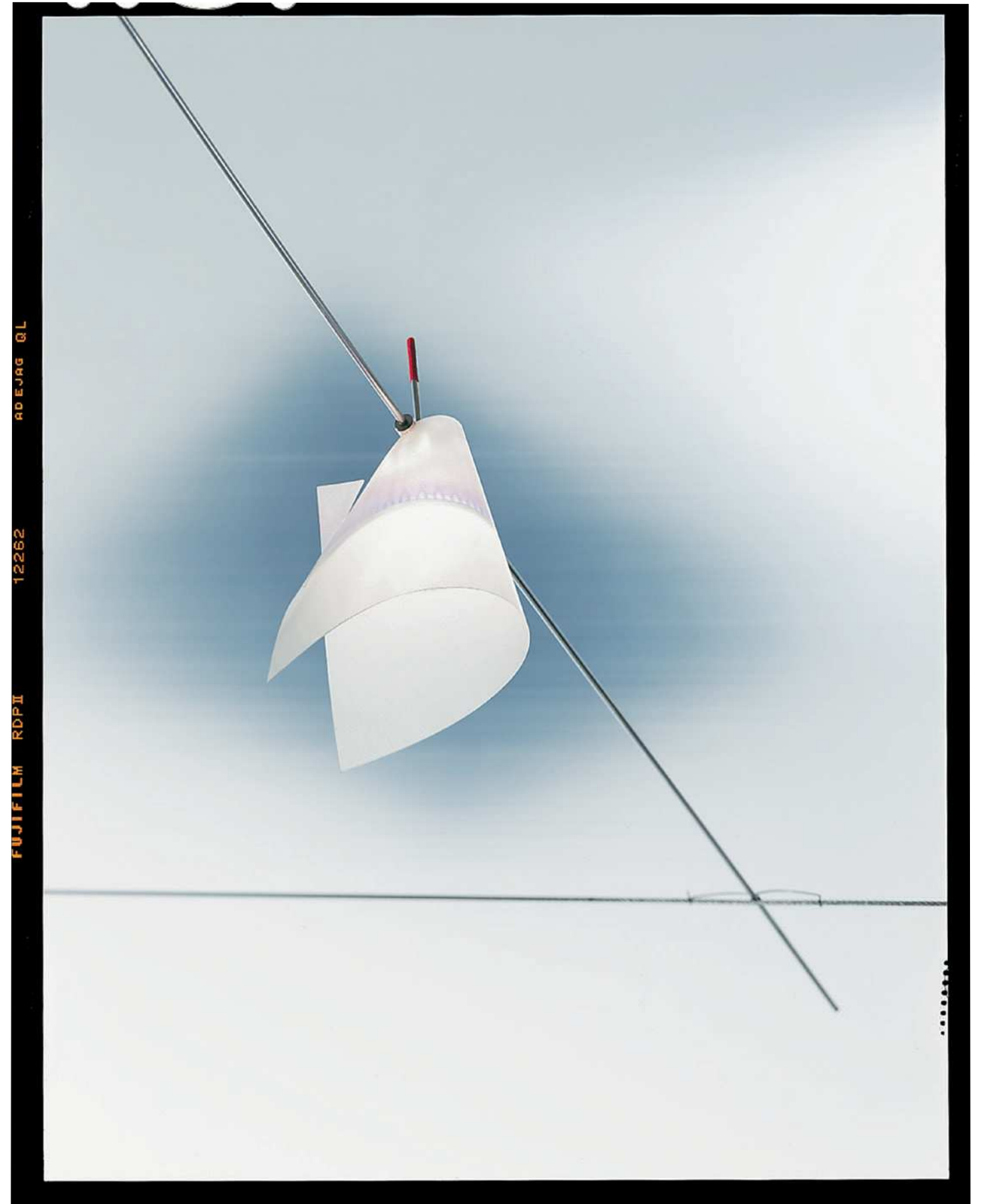

FUJIFILM RDPII 12262 ADEJAG QL

ELEMENT 6

A shade
made from
a material
that makes
light designers
dreams come
true –
pure silicone.



ELEMENT 16 in silicone



ELEMENT 14 in silicone



Symphonia Silenziosa.
Light installation with
custom-made YaYaHo parts
for Issey Miyake.
Fashion show in Paris, 1999.

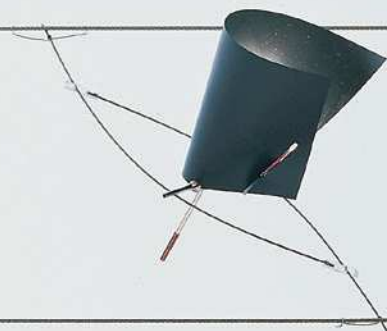

Black, blue,
and silver.
Vertically or
horizontally.

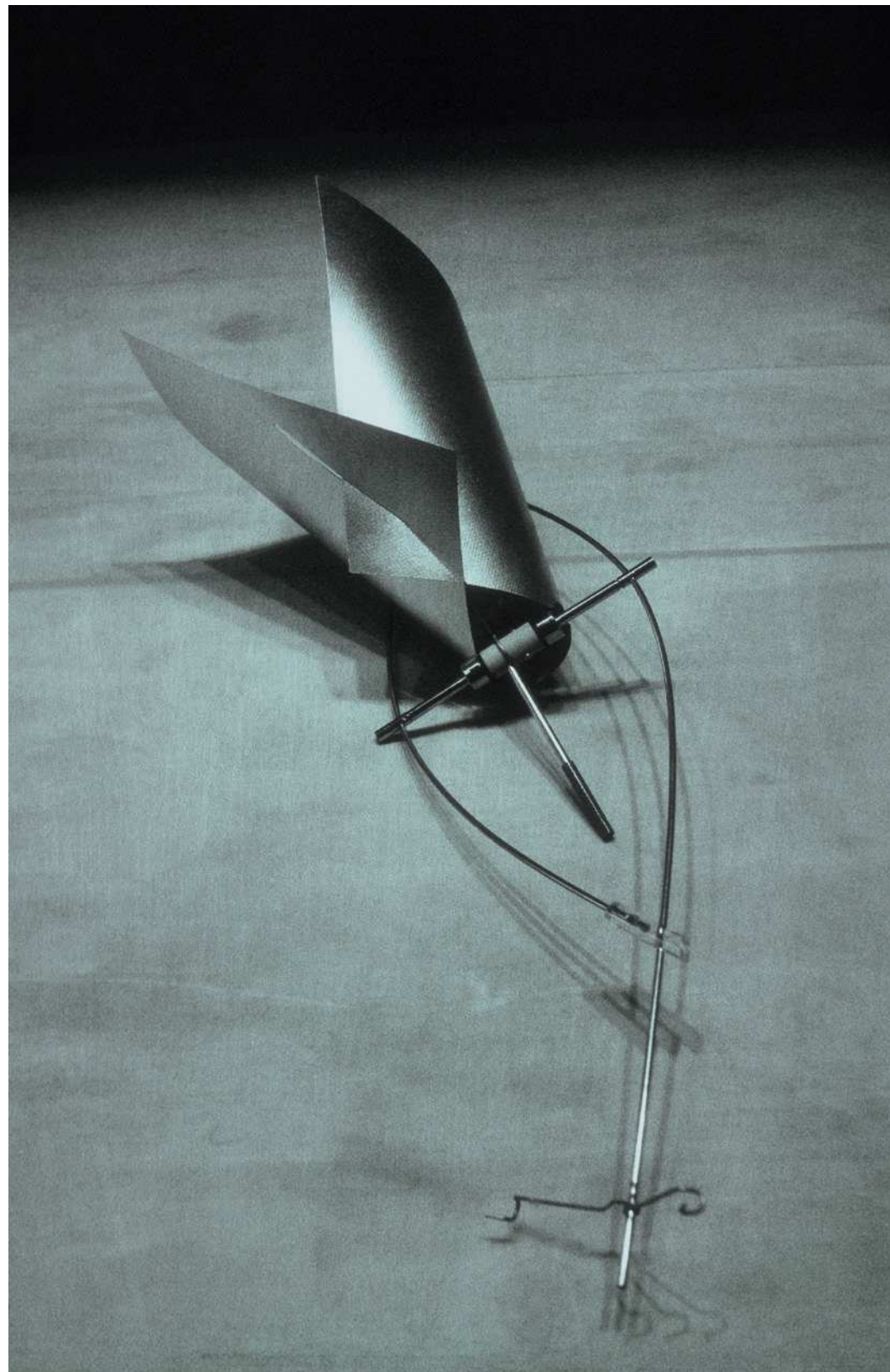

BaKa Rú Design: Ingo Maurer und Team 1986

BaKa Rú ist ein Niedervolt-Lichtsystem und wird über einen Transformator betrieben, der 230/125 Volt auf 12 Volt reduziert. Der Transformator ist mit einer Thermosicherung ausgestattet. Er ist bis max. 200 Watt belastbar.

Kunststoff, Metall, Keramik, Multi Mirror-Reflektoren mit Schutzglas. Lieferung mit hitzebeständigen naturfarbenen Blenden, Bohrschablone und Spannwerkzeug. Die Lichtelemente lassen sich in jede Richtung drehen und auf den Seilen verschieben. Durch die isolierten Spannschlösser ist die Montage auch auf leitenden Materialien möglich. Die Spezialseile können in einer Länge von 6, 8 oder 10 Metern geliefert werden. Bei größeren Distanzen wird ein zweiter Transformator mit den erforderlichen Isoliereinheiten empfohlen. Maximale Belastbarkeit der Seile 350 Watt. Schwarze Blenden erhältlich. Lichtsteuerung nur über Spezialdimmer für Trafobetrieb. BaKaRú lässt sich von Wand zu Wand spannen oder an die Decke montieren. Waagerechte, senkrechte oder auch diagonale Installation ist möglich.

BaKa Rú is a low-voltage lighting system fed by a transformer which reduces the 230/125-volt mains current to 12 volts. The transformer (max. capacity 200 watts) is fitted with a thermal fuse.

Plastic, metal, ceramic, Multi-Mirror reflectors with protective glass cover. Complete with heat-resistant shades (colour: natural), drilling template and cable-tautener. The lighting elements can be moved along the cables and turned in any direction. The insulated tensioning bolts make it possible to install the system on any surface, including conductive materials. The special cables can be supplied in lengths of 6, 8 or 10 m. For longer cables the use of a second transformer (with the necessary insulators) is recommended. Maximum capacity of cables: 350 watts. Shades in black are available. N.B. the dimmer (if any) must be specially adapted for halogen lighting. BaKaRú is equally suitable for wall or ceiling installation. It can be mounted horizontally, vertically or even on the diagonal.

BaKa Rú est un système d'éclairage basse tension, relié à un transformateur qui change les 230/125 volts en 12 volts. Le transformateur est équipé d'un fusible thermoélectrique. La capacité maximum du transformateur est de 200 watts.

Matière plastique, métal, céramique; réflecteurs Multi Mirror avec verre protecteur. Livré avec des écrans de couleur naturelle résistant à la chaleur, gabarit de perçage et tendeurs. Les éléments lumineux sont orientables dans toutes les directions et peuvent être déplacés sur les câbles. Les tendeurs isolants permettent même un montage sur des matériaux conducteurs. Les câbles spéciaux sont livrés dans les longueurs de 6, 8 ou 10 mètres. Pour des distances plus grandes, l'utilisation d'un deuxième transformateur avec les parties isolantes nécessaires est recommandée. Capacité maximum des câbles 350 watts. Ecrans noirs disponibles. Réglage de l'intensité lumineuse uniquement par un variateur spécial pour lampe halogène. BaKaRú se tend de mur à mur ou au plafond. Le système se monte à l'horizontale, mais également à la verticale ou même en diagonale.

BaKa Rú è un sistema di luci a basso voltaggio, alimentato da un trasformatore che riduce 230/125 volt a 12 volt. Il trasformatore è dotato di una sonda termica. Carico massimo consentito del trasformatore 200 watt.

Materiale sintetico, metallo, ceramica; riflettori Multi Mirror con vetro di protezione. Fornito con schermi termoresistenti di colore naturale, dima di foratura e utensili per il montaggio. Gli elementi sono orientabili in ogni direzione e possono essere spostati sui cavi. I tiranti isolati consentono il montaggio anche su materiali conduttori. I cavi speciali sono disponibili nelle lunghezze di 6, 8 e 10 metri. In caso di distanze superiori, è consigliato l'impiego di un secondo trasformatore con l'utilizzo di isolatori. Carico massimo dei cavi 350 watt. Sono disponibili schermi di colore nero. Regolazione della luce esclusivamente mediante uno speciale variatore per lampade alogene. BaKaRú può essere teso da parete a parete o montato a soffitto. E' possibile un'installazione orizzontale, verticale o diagonale.

💡 LED or Halogen 🌀 GX 5,3, max. 50 W, A++-E, external transformer 230/125/12 V

Ya Ya Ho Ingo Maurer und Team 1984

Ya Ya Ho ist ein Niedervolt-Lichtsystem und wird über einen Transformator (Leistung max. 200 Watt) betrieben, der 230/125 Volt auf 12 Volt reduziert. Alle Elemente sind horizontal und einige zusätzlich auch vertikal beweglich. Jedes Part und jedes Element ist auch einzeln lieferbar. Montagehöhe: 230–250 cm. Belastbarkeit der Seile 350 Watt. Spannlänge ohne Deckenabhängung: 10 Meter. Sonderanfertigung und Planung auf Anfrage möglich. **Ya Ya Ho** is a low-voltage lighting system fed by a transformer (max. capacity 200 watts) which reduces the 230/125 volt mains current to 12 volts. All elements are adjustable – horizontally, and in some cases vertically, too. All parts and elements can also be ordered separately. Installation height 230–250 cm. Maximum capacity of cables: 350 watts. Maximum cable length without additional ceiling fixture: 10 m. We can also supply custom-designed systems – please ask for details. **Ya Ya Ho** est un système d'éclairage basse tension, relié à un transformateur (capacité maximum 200 watts) qui change les 230/125 volts en 12 volts. Tous les éléments sont mobiles horizontalement et quelque-uns en plus verticalement. Chaque part et élément est également disponible individuellement. Hauteur de montage d'un système: 230 à 250 cm. Capacité maximum des câbles 350 watts. Longueur maximum des câbles sans utilisation d'une suspension plafond: 10 mètres. Planification et modèles hors série peuvent être réalisés sur demande. **Ya Ya Ho** è un sistema di luci a basso voltaggio, alimentato da un trasformatore (potenza 200 watt max.) che riduce 230/125 volt a 12 volt. Tutti gli elementi sono regolabili in orizzontale e alcuni anche in verticale. Ogni part e ogni elemento sono disponibili anche singolarmente. Altezza di montaggio di un sistema: da cm. 230 a cm. 250. Carico massimo dei cavi 350 watt. Lunghezza massima dei cavi senza dispositivo di fissaggio al soffitto: 10 metri. Realizzazioni speciali e progettazione su richiesta.

Element 1

Auf den Seilen horizontal beweglich. ■ Adjustable horizontally along the wires. ■ Mobile à l'horizontale sur les câbles métalliques. ■ Elemento mobile lungo i cavi in orizzontale.

💡 20 W Halogen, 300 lm, 2800 K, 4000 h, EEC C 🌀 G4, max. 20 W, EEC B–E
EU: Please check availability on our website.

Element 2 + Spiegel / Mirror / Miroir / Specchio

Multi Mirror-Reflektor. Auf den Seilen horizontal und vertikal beweglich. Leuchtenkopf schwenkbar. Lieferbar auch ohne Spiegel. ■ Multi-Mirror reflector. Adjustable vertically and horizontally along the wires. Reflector unit swivels. Also available without mirror. ■ Réflecteur Multi Mirror. Mobile à l'horizontale et à la verticale sur les câbles métalliques. La tête du luminaire est pivotante/rotative. Également disponible sans miroir. ■ Riflettore Multi Mirror. Mobile lungo i cavi in orizzontale e verticale. Corpo illuminante rotante e basculante. Disponibile anche senza specchio.

💡 LED or Halogen 🌀 GX 5,3, max. 50 W, EEC A++–E

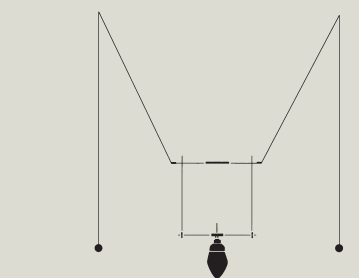
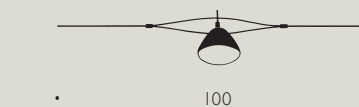
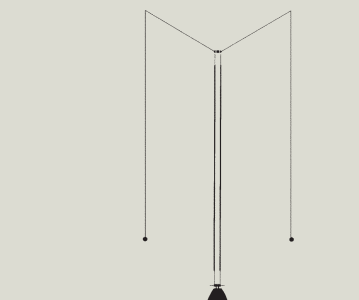
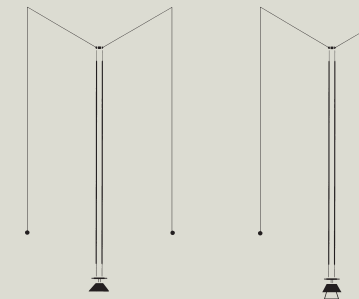
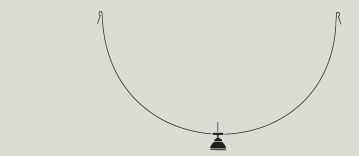

Element 3, Element 6

Multi Mirror-Reflektor. Auf den Seilen horizontal beweglich, Leuchtenkopf schwenkbar. ■ Multi-Mirror reflector. Adjustable horizontally along the wires, reflector unit swivels. ■ Réflecteur Multi Mirror. Mobile à l'horizontale sur les câbles métalliques. La tête du luminaire est pivotante/rotative. ■ Riflettore Multi Mirror. Elemento mobile lungo i cavi in orizzontale e verticale. Corpo illuminante rotante e basculante.

💡 LED or Halogen 🌀 GX 5,3, max. 50 W, EEC A++–E

Element 4, Element 5

Auf den Seilen horizontal und vertikal beweglich. ■ Adjustable vertically and horizontally along the wires. ■ Mobile à l'horizontale et à la verticale sur les câbles métalliques. ■ Mobile lungo i cavi in orizzontale e verticale.

💡 50 W Halogen, 910 lm, 3000 K, 2000 h, EEC C 🌀 GY 6,35, max. 50 W, EEC B–E
EU: Please check availability on our website.

Element 14

Silikon, Metall, Kunststoff. Auf den Seilen horizontal und vertikal beweglich. ■ Silicone, metal, plastic. Adjustable vertically and horizontally along the wires. ■ Silicone, métal, matière plastique. Mobile à l'horizontale et à la verticale sur les câbles métalliques. ■ Silicone, metallo, materiale sintetico. Mobile lungo i cavi in orizzontale e verticale.

💡 35 W, 12 V Halogen, 860 lm, 2900 K, 4000 h, EEC B 🌀 GY 6,35, max. 35 W, A++–E
EU: Please check availability on our website.

Element 16

Silikon, Metall, Kunststoff. Auf den Seilen horizontal beweglich. Leuchtenkopf schwenkbar. ■ Silicone, metal, plastic. Adjustable horizontally along the wires. Reflector unit swivels. ■ Silicone, métal, matière plastique. Mobile à l'horizontale sur les câbles métalliques. ■ Silicone, metallo, materiale sintetico. Elemento mobile lungo i cavi in orizzontale e verticale. Corpo illuminante rotante e basculante.

💡 LED or Halogen 🌀 GX 5,3, max. 50 W, A++–E

Element 77

Multi Mirror-Reflektor. Auf den Seilen horizontal und vertikal beweglich. Leuchtenkopf schwenkbar. ■ Multi-Mirror reflector. Adjustable vertically and horizontally along the wires. Reflector unit swivels. ■ Réflecteur Multi Mirror. Mobile à l'horizontale et à la verticale sur les câbles métalliques. La tête du luminaire est pivotante/rotative. ■ Riflettore Multi Mirror. Mobile lungo i cavi in orizzontale e verticale. Corpo illuminante basculante.

💡 LED or Halogen 🌀 GX 5,3, max. 50 W, A++–E

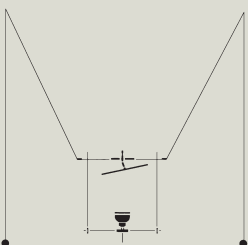
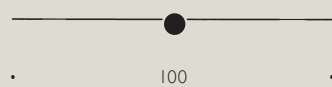

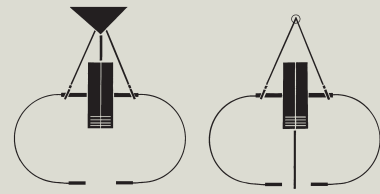

Part A

Transformator weiß mit 230/125-Volt-Zuleitung mit Schalter; für Wand- und Deckenmontage. ■ Transformer white, with 230/125-volts lead and switch, for wall or ceiling installation. ■ Transformateur blanc avec câble d'alimentation 230/125 volts et interrupteur pour le montage au mur ou au plafond. ■ Trasformatore bianco con alimentazione 230/125 volt con interruttore, per montaggio a parete o a soffitto.

Part B

2 Spezialseile à 6, 8 oder 10 Meter; 4 Wandbefestigungen mit isolierten Spannschlössern, geeignet zur Montage auch auf leitenden Materialien. ■ 2 special cables (length 6, 8 or 10 m), 4 wall anchors with insulated tensioning bolts, attachable to any kind of surface including conductive materials. ■ 2 câbles spéciaux d'une longueur de 6, 8 ou 10 m, 4 fixations murales avec tendeurs isolés permettant également un montage sur matériaux conducteurs. ■ 2 cavi speciali di 6, 8 oppure 10 metri, 4 attacchi murali con tiranti isolati che consentono il montaggio anche su materiali conduttori.



Part D

2 x 2 Spezialseile à 6, 8 oder 10 Meter; 4 Wandbefestigungen mit isolierten Spannschlössern sowie zwei Isoliereinheiten und Deckenabhängung; für beide Teillängen wird je ein Transformator benötigt. ■ 2 pairs of special cables (length 6, 8 or 10 m), 4 wall anchors with insulated tensioning bolts, 2 insulators, ceiling fixture; separate transformer required for each pair of cables. ■ 2 x 2 câbles spéciaux d'une longueur de 6, 8 ou 10 m, 4 fixations murales avec tendeurs isolés et également deux unités d'isolation et suspension plafond; chaque paire de câbles nécessitant un transformateur. ■ 2 x 2 cavi speciali di 6, 8 oppure 10 metri. 4 attacchi murali con tiranti isolati, compresi due isolatori e dispositivo di fissaggio a soffitto. Per entrambi i tratti di cavo è necessario un trasformatore.



Part E

Metallstäbe mit 25,5 cm Länge für Deckenabspannung oder Über-Eck-Spannung der Spezialseile. ■ Nickel-plated metal rods, length 25,5 cm, for ceiling or corner installation. ■ Tiges en métal nickelé d'une longueur de 25,5 cm pour fixation des câbles spéciaux soit au plafond soit en coin. ■ Aste metalliche nichelate di lunghezza cm. 25,5 per montaggio dei cavi speciali a soffitto oppure ad angolo.



Part F (YaYa Ho + BaKa Rú)

Blenden für Lichtelemente 2, 3 und 6. Naturfarben, Schwarz. ■ Shades for lighting elements 2, 3 and 6. Colours: natural, black. ■ Écrans résistant à la chaleur s'adaptant sur les éléments 2, 3 et 6. De couleur naturelle, noire. ■ Schermi termoresistenti per gli elementi illuminanti 2, 3 e 6. Disponibili nei colori naturale e nero.



Nur auf Bestellung

Uniquement sur commande

Solo su ordinazione

BY ORDER ONLY



OH MAN, IT'S A RAY!



OH MAN, IT'S A RAY!

Ingo Maurer was inspired
by the work of the artist Man Ray.

This piece is available
in various sizes and made
with the express permission
of the Man Ray Trust.

By Ingo Maurer and Team.



Wood. Natural + black.

BE HUMBLE. BUY THE HUMBLIES!

370

371



THE MAGICAL HUMBLIES.

372



373

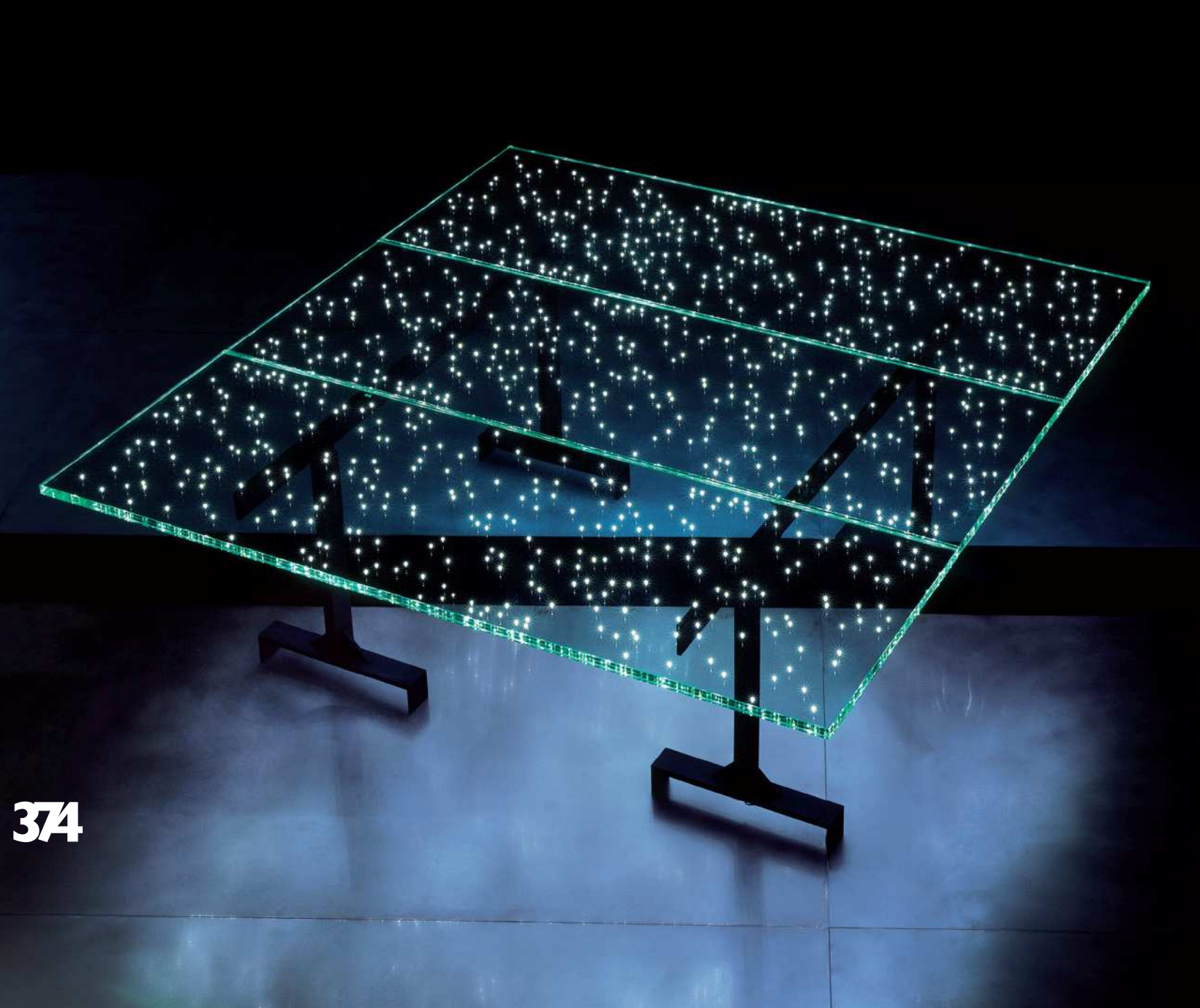

374

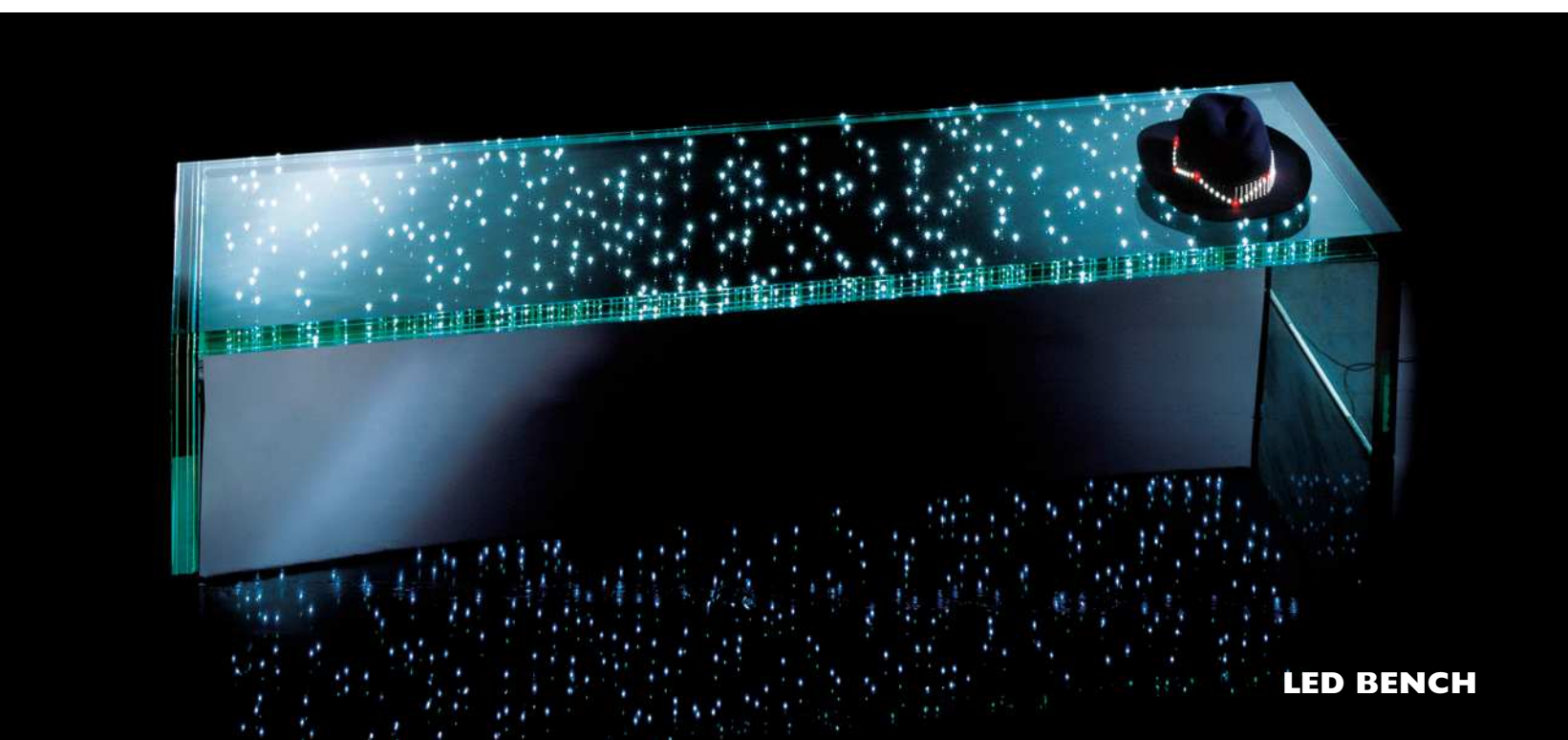

LED BENCH

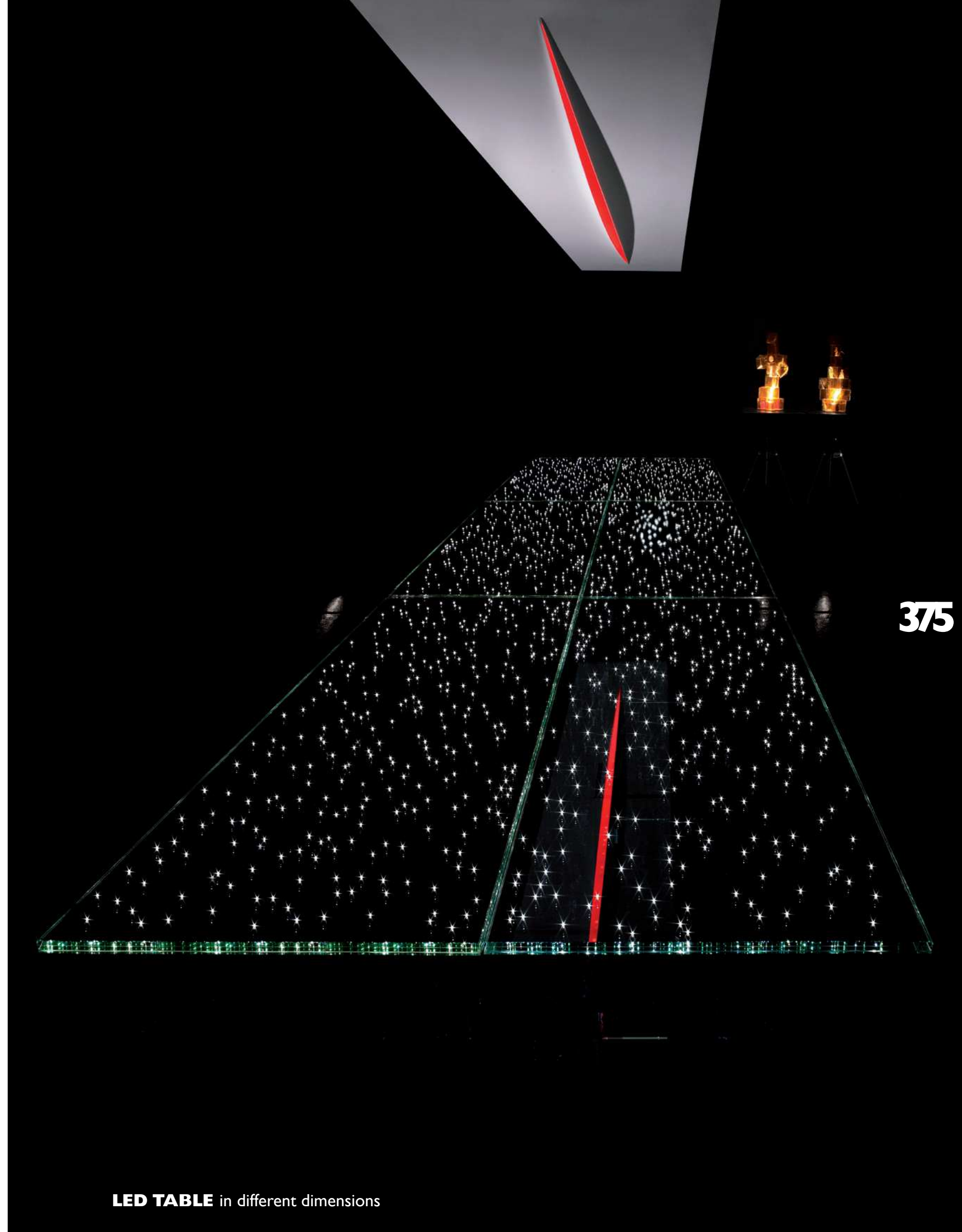

375

LED TABLE in different dimensions

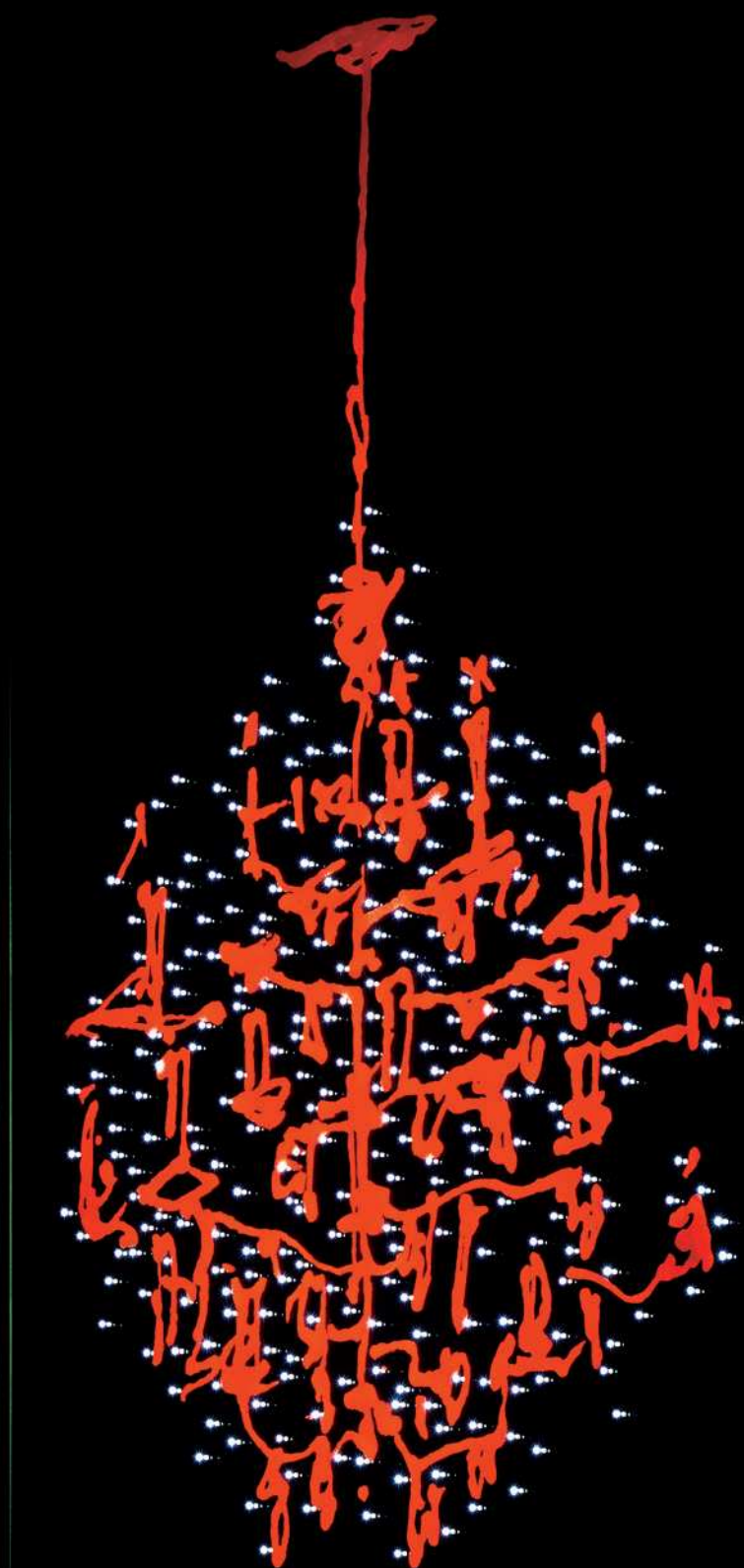

378



379



HOT.HOT CUSTOM MADE BY ORDER ONLY

Porca Miseria!
An Italian cuss.

Going to the Milano fair is always a very intense time. I felt like exploding and breaking with the average aesthetic, I broke china, played with it and created a light explosion from inside out. Playing with light and its reflection has always been exciting to me.

So the morning, when the show started, the name of the lamp was “Zabriskie Point”, because I loved the film from Antonioni. As the first customer appeared and saw it, he cried out: “Porca Miseria!”. At the very second I changed the name to Porca Miseria!

This is not a serial product. Each piece is custom-tailored. I/We love to do the Porcas although it takes at least four people to make one in ten days. It is like drawing. It demands a very sharp eye and patience. But it is fun.

Names like Totally Kaputt, Porca China, Eclat Joyeux, Porca Brasil, Porca Buddha etc. etc.



382



PORCA MISERIA! _____ Totally Kaputt

383



PORCA MISERIA! _____ Brazil Mi Amor

384



PORCA MISERIA! _____ Amour Chinois

385



Being
unique
is gold.

Each
GOLDEN RIBBON
is handcrafted
and has
its own
customised
form.

Unrivaled
in expression
and shape.

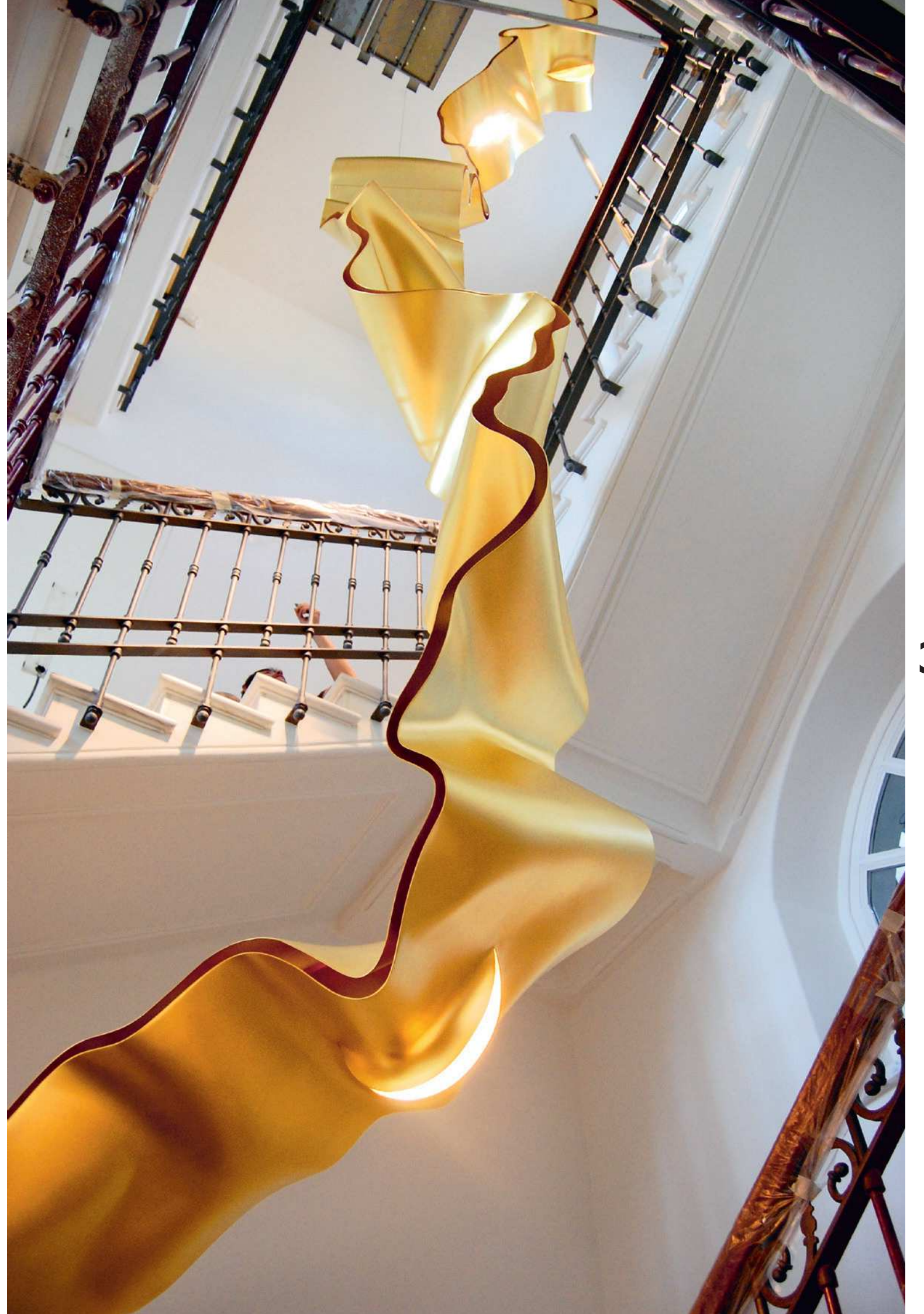

The Golden Ribbon a floating sculpture. Total length 13.5 m.
Seamarq Hotel, Korea. Architecture by Richard Meier.
Table by Japanese Master Ryutaro Yoshida.

Photo: Roland Halbe

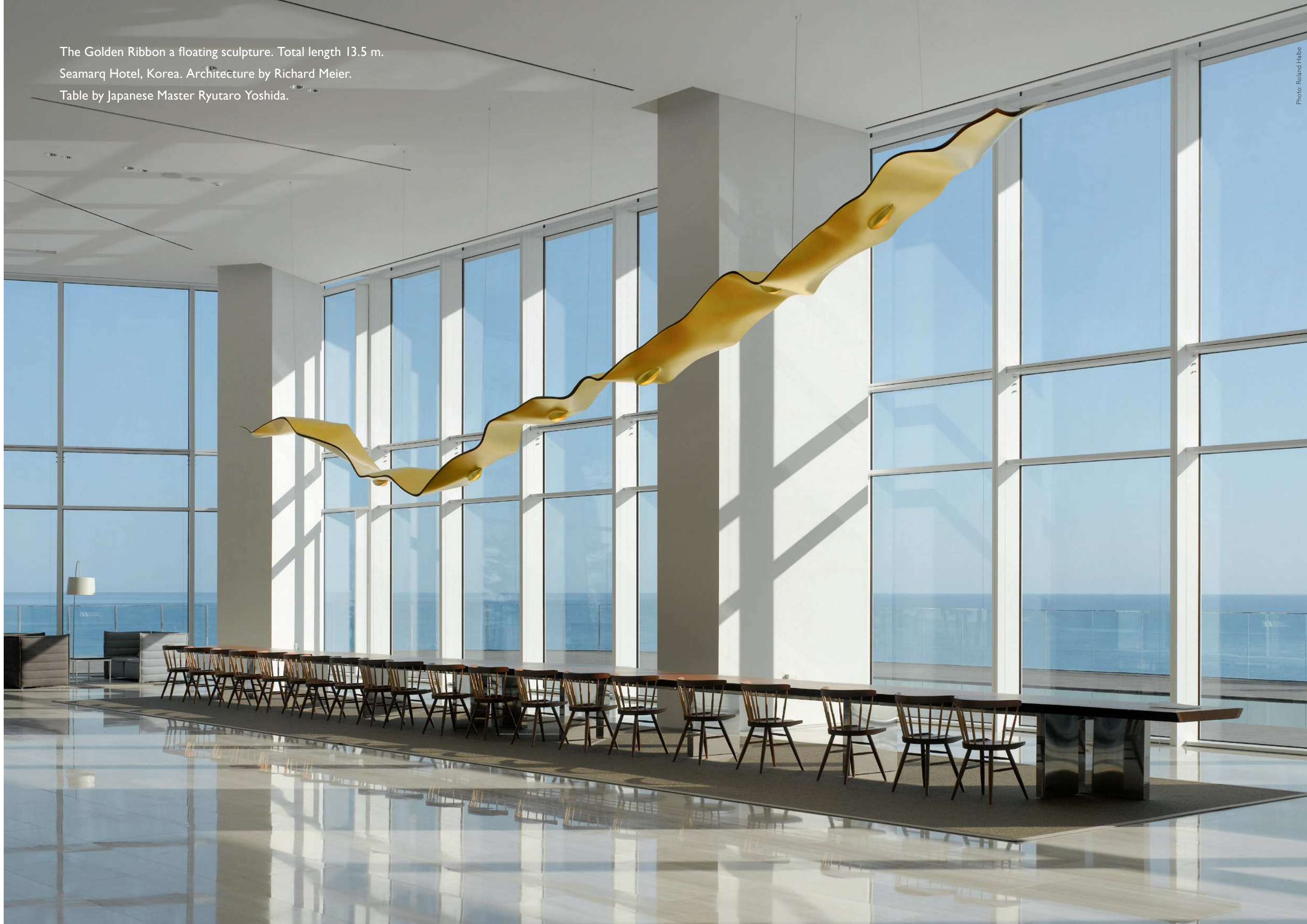



RED RIBBON

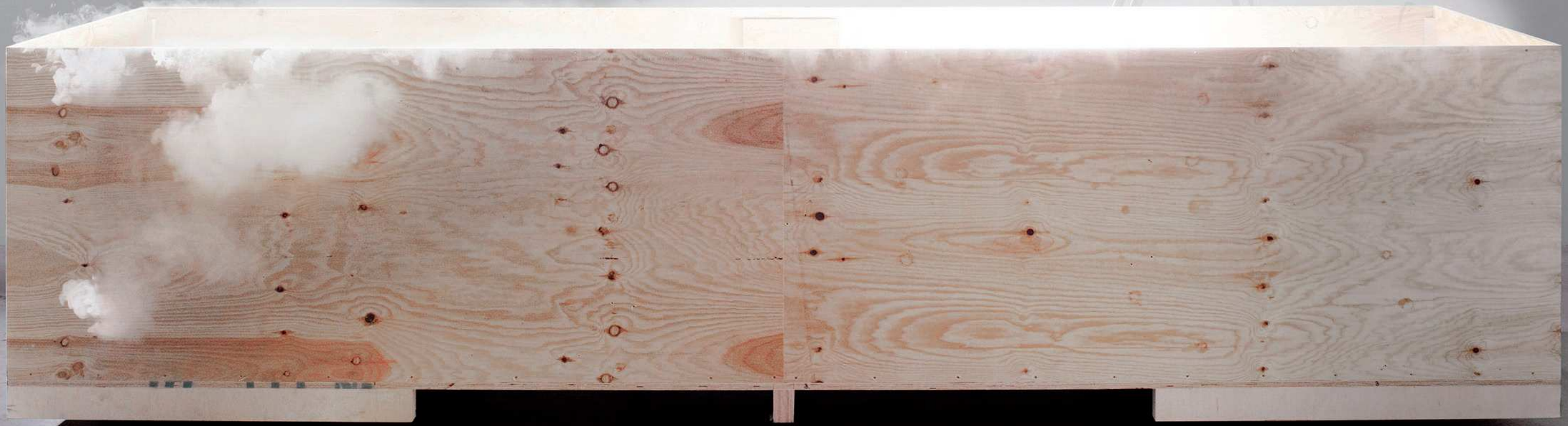
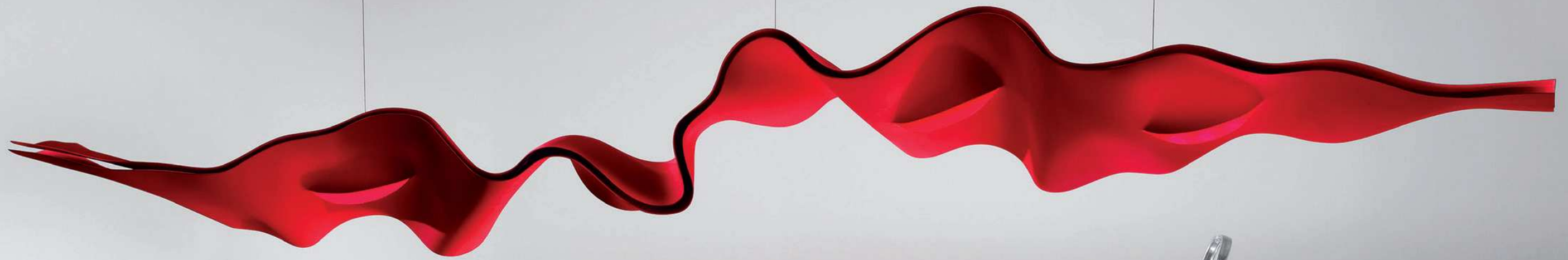

392

393

T.T. MOON

Searching
new esthetic
and technical
challenges.
Flying to
the moon?
Never give
up trying.



396



397

COMIC EXPLOSION a unique piece, at La Mania, Warsaw

As the name says,
PENDULUM is a
kinetic object.
What makes it
so special to me?
Its calm but powerful
momentum.
The egg form which
is one of the purest
and most archaic
forms ever.
And its light reflecting
surface of
polished aluminum.
Let yourself be
moved by Pendulum.





BROKEN EGG Installation at Fondazione Cassa di Risparmio Della Spezia

Detail of biotope.
Natural pigmented
sponges with
artificial butterflies.

402



403



404



405

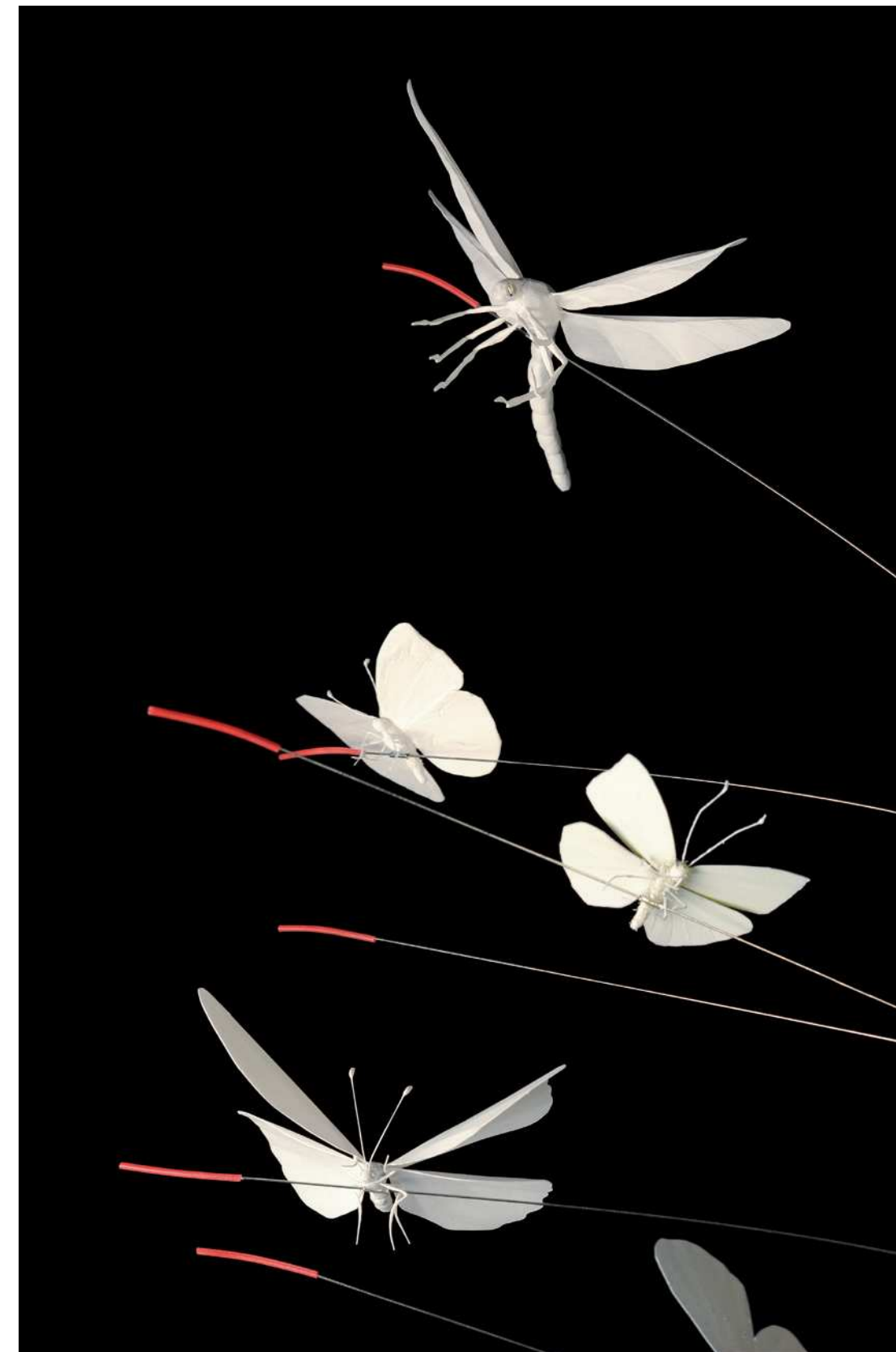

WORK IN PROGRESS

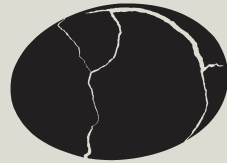

ca. 115

Broken Egg Ingo Maurer 2008

Sonderanfertigung. Details auf Anfrage. ■ Custom-made object. Details on request. ■ Fabrication spéciale. Détails techniques sur demande. ■ Oggetto di luce, realizzazione soltanto su richiesta. Dati tecnici su richiesta.

Up-to-date information on request.



ca. 270

Comic Explosion! Ingo Maurer 2010

Sonderanfertigung. Stahl, Aluminium, Kunststoff, LED. ■ Custom-made object. Steel, aluminium, plastic, LED. ■ Fabrication spéciale. Acier, aluminium, matière plastique, LED. ■ Oggetto di luce, realizzazione soltanto su richiesta. Acciaio, alluminio, materiale sintetico.

LED, up-to-date information on request.

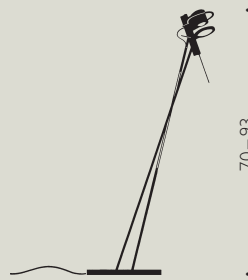

70-93

• 18,5 •
• max. 80 •

HOT.HOT Ingo Maurer und Team 2006

Metall, Glas, schwarz lackierter Stahl. Der Lichtkegel kann durch ein Linsensystem eingestellt werden. ■ Metal, glass, black lacquered steel. The cone of light is adjustable by a lens system. ■ Métal, verre, acier noir laqué. Le cône lumineux peut être ajusté à l'aide d'un système de lentilles. ■ Metallo, vetro, acciaio verniciato nero. Il cono di luce può essere regolato mediante un sistema di lenti.

Up-to-date information on request.

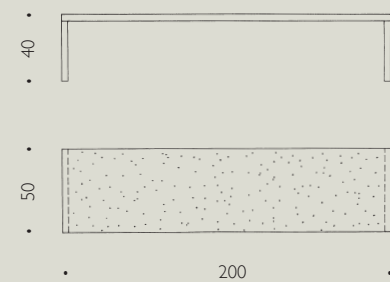

200

LED Bench Ingo Maurer 2002

Glas, 288 innen liegende weiße LEDs, beidseitig leuchtend. Dimmbar durch externes Vorschaltgerät. Die LEDs scheinen in der Glasfläche zu schweben, denn keine Leiterbahnen oder Kabel sind sichtbar. Ca. 135 kg. ■ Moulded glass. Within the glass, 288 white LEDs emit light on both sides. Possibility of dimming by use of an external ballast. The LEDs seem to be floating on the glass like magic. No conductors or cables are visible. Ca. 135 kg. ■ Verre. 288 LED blanches à émission lumineuse bilatérale à l'intérieur. Variation de l'intensité lumineuse par un ballast externe. Les LED semblent flotter sur la surface de verre, car ni câble, ni fil électrique ne sont visibles. Env. 135 kg. ■ Vetro. 288 LED bianchi a emissione luminosa bilaterale collocati all'interno. Intensità luminosa regolabile tramite un alimentatore a corrente continua esterno. Non essendo visibili conduttori d'alimentazione o cavi, i LED sembrano galleggiare all'interno del vetro. 135 kg ca.

Up-to-date information on request.

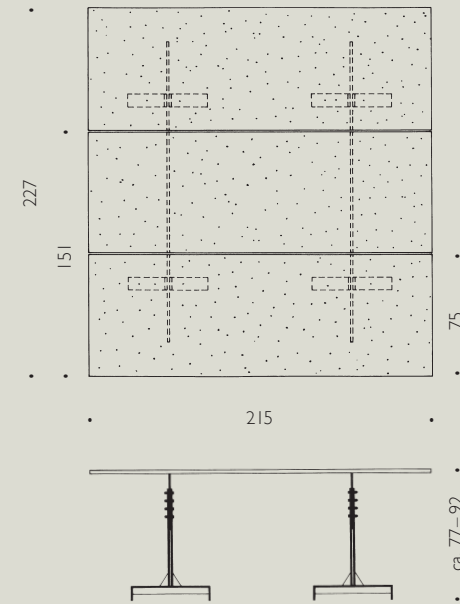

227

151

75

215

ca. 77-92

LED Table Ingo Maurer 2003

Sicherheitsglas. Metall. 278 innen liegende weiße LEDs pro Glasplatte, beidseitig leuchtend. Unsichtbare Stromführung. Dimmbar durch externes Vorschaltgerät. Höhenverstellbare Metallgestelle. Lieferbar mit 1, 2 oder 3 Glasplatten. Gewichte: mit 2 Glasplatten ca. 360 kg, mit 3 Glasplatten ca. 500 kg. ■ Laminated safety glass, metal. 278 white LEDs per table top inside, emitting light on both sides. Invisible live parts. Possibility of dimming by use of an external ballast. Metal bases adjustable in height. Available with 1, 2 or 3 table tops. Weights: with 2 table tops approx. 360 kg, with 3 table tops approx. 500 kg. ■ Verre feuilleté, métal. 278 LEDs blanches à émission lumineuse bilatérale à l'intérieur d'un plateau. Conduction invisible du courant. Variation de l'intensité lumineuse par un ballast externe. Supports métalliques réglables en hauteur. Livrable avec 1, 2 ou 3 plateaux en verre. Poids: avec 2 plateaux env. 360 kg, avec 3 plateaux env. 500 kg. ■ Vetro temperato, metallo, 278 LEDs bianchi a emissione luminosa bilaterale collocati all'interno di ogni lastra. Conduttori elettrici tra i LED invisibili. Intensità luminosa regolabile tramite un alimentatore a corrente continua esterno. Con piedi in metallo regolabili in altezza. Disponibile con 1, 2 o 3 lastre. Pesì complessivi: con 2 lastre ca. 360 kg., con tre lastre ca. 500 kg.

Up-to-date information on request.

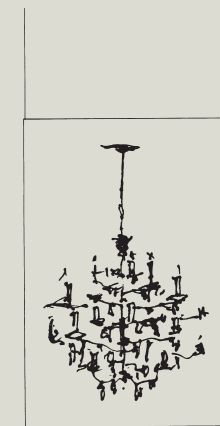

100

65

Lüster Ingo Maurer 2003

Bedrucktes Glas. 287 innen liegende weiße LEDs, beidseitig leuchtend. Dimmbar durch externes Vorschaltgerät. Keine Leiterbahnen oder Kabel sind sichtbar; die Abhängeseile versorgen den Lüster mit Strom. ■ Imprinted moulded glass. Within the glass, 287 white LEDs emit light on both sides. Possibility of dimming by use of an external ballast. No conductors or cables are visible. The suspension wires transport electricity to the chandelier. ■ Verre imprimé. 287 LED blanches à émission lumineuse bilatérale. Variation de l'intensité lumineuse par un ballast externe. Aucun fil et câble électrique ne sont visibles, les fils de suspension alimentent le lustre en courant. ■ Vetro stampato. 287 LED bianchi a emissione luminosa bilaterale collocati all'interno. Intensità luminosa regolabile tramite un alimentatore a corrente continua esterno. Non sono visibili conduttori d'alimentazione o cavi; il lampadario è alimentato da cavi di sospensione.

Up-to-date information on request.



ca. 75

200-250

Oh Man, It's a Ray! Ingo Maurer 2009

Sonderanfertigung in verschiedenen Größen. Holz, Metall, Glas, Kunststoff. Details auf Anfrage. ■ Limited production in various sizes. Wood, metal, glass, plastic. Details on request. ■ Production limitée en différentes tailles. Bois, métal, verre, plastique. Détails techniques sur demande. ■ Produzione limitata in misure diverse. Legno, metallo, vetro, materiale sintetico. Dati tecnici su richiesta.

Up-to-date information on request.



Porca Miseria! Ingo Maurer 1994

Limitierte Produktion. Nähere Angaben auf Anfrage. ■ Limited production. Please contact us for more detailed information. ■ Production limitée. Indications plus détaillées sur demande. ■ Produzione limitata. Informazioni dettagliate su richiesta.

Up-to-date information on request.

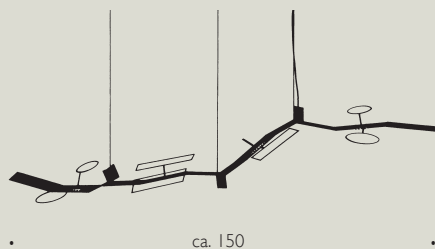

T.T. Moon Ingo Maurer und Team 2014

Limitierte Edition, max. 15 Stück. ■ Limited series of max. 15 pieces. ■ Edition limitée de max. 15 pièces. ■ Edizione limitata di 15 pezzi max.

Up-to-date information on request.

SHOWROOMS & PROJECTS

studio
showroom
werkstatt
atelier

+ shop

Kaiserstrasse 47

80801 Munich

Germany

+49 89 38160691

space@ingo-maurer.com

www.ingo-maurer.com

shop.ingo-maurer.com

410

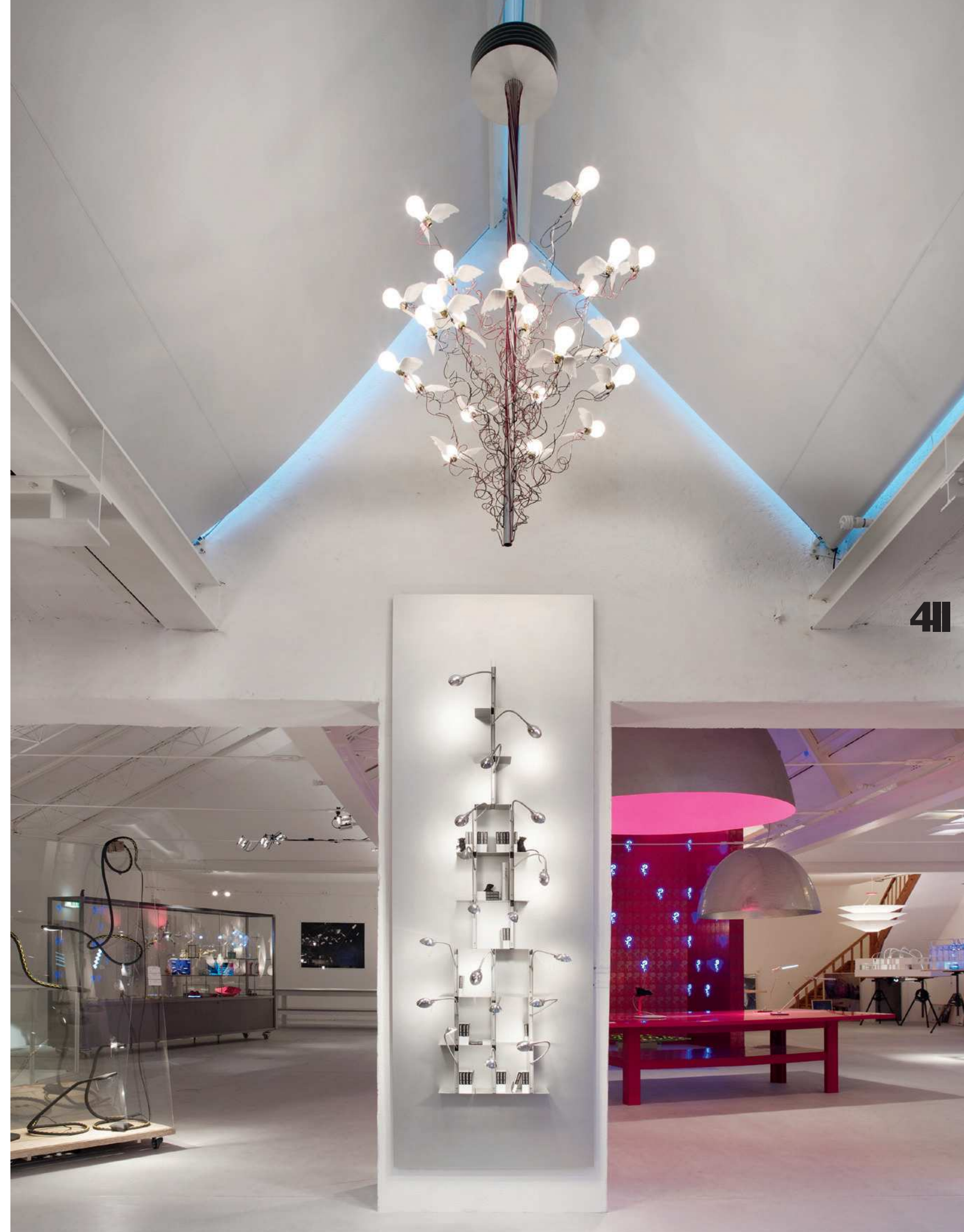

411





44



45



Ingo Maurer LLC
Making Light
89 Grand Street,
corner of Green
New York, NY 10013
Tel. 212 965 8817
making-light@ingomaurer-usa.com



416

417

ESTUDIO BRASIL

INAO MAUREZ



420

421

ESTUDIO BRASIL

Ingo Maurer / FAS Iluminação
Alameda Gabriel Monteiro da Silva, 413,
Jardim Paulistano-São Paulo-SP



BELLISSIMA BRUTTA One Off, Ingo Maurer 1997

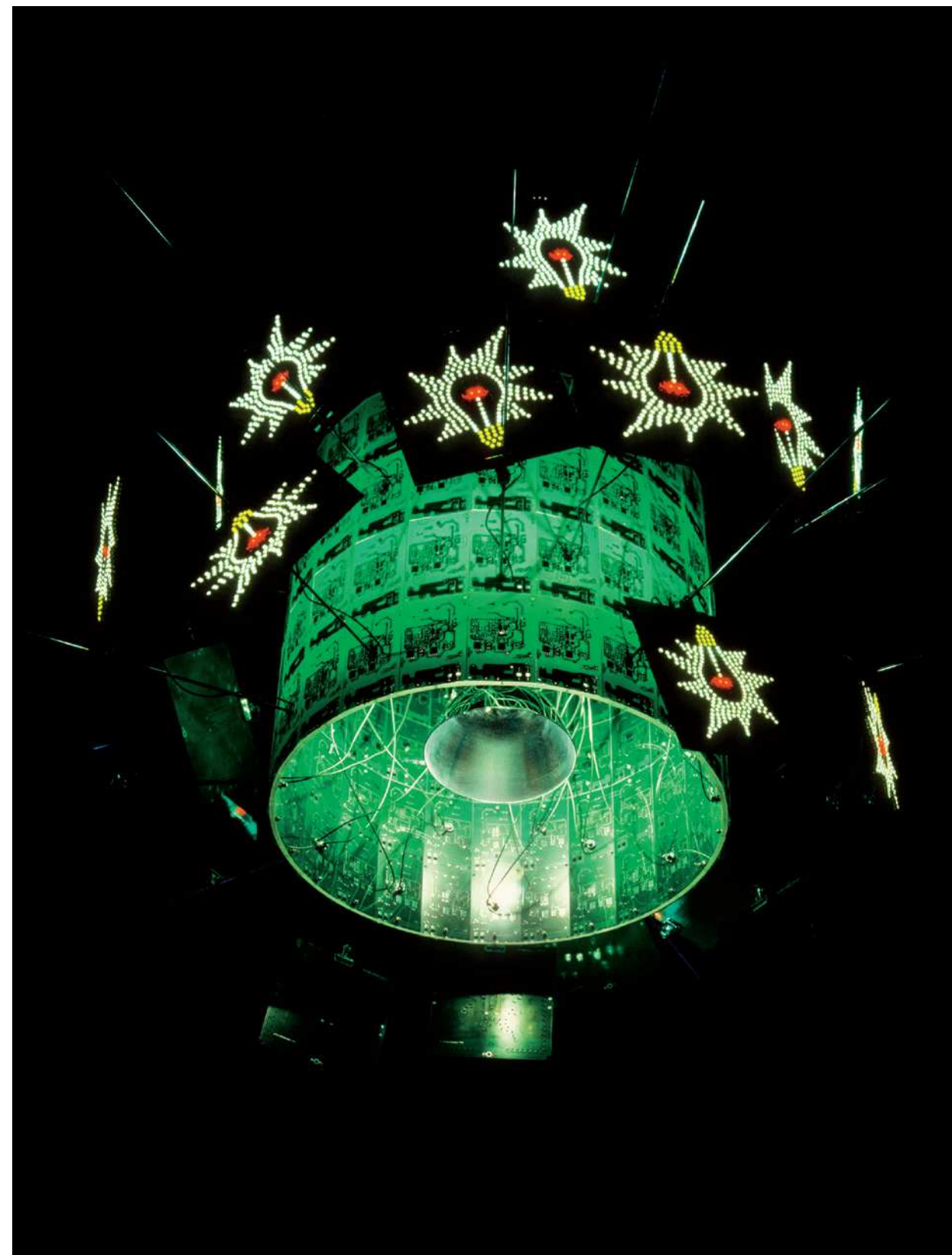

LICHT.ENSTEIN Limited Production, Ingo Maurer 2001

Thinking of Roy Licht-Enstein!

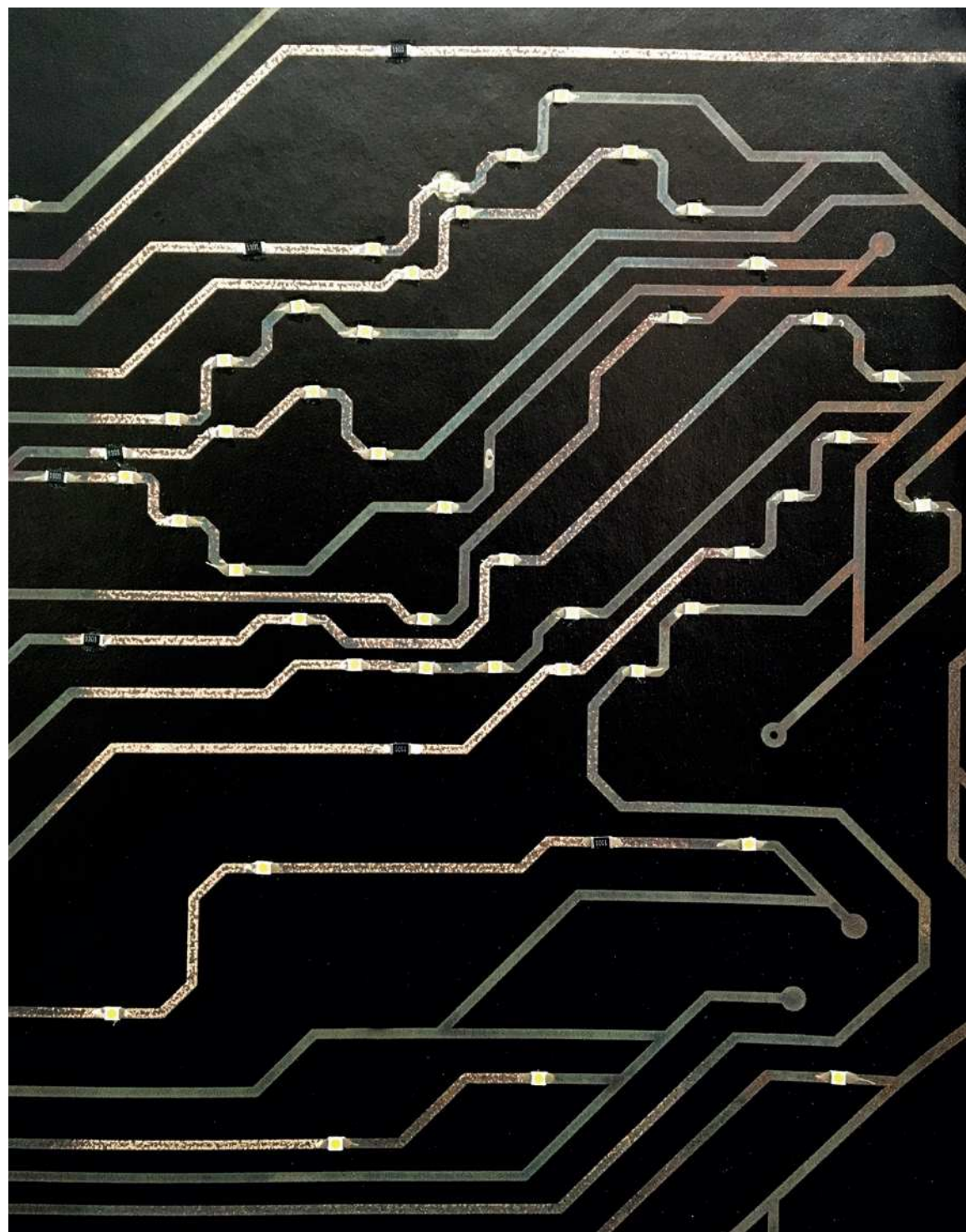

Original size of circuit board. Handmade.

First **LED WALLPAPER** 2011, Colour and brightness adjustable.

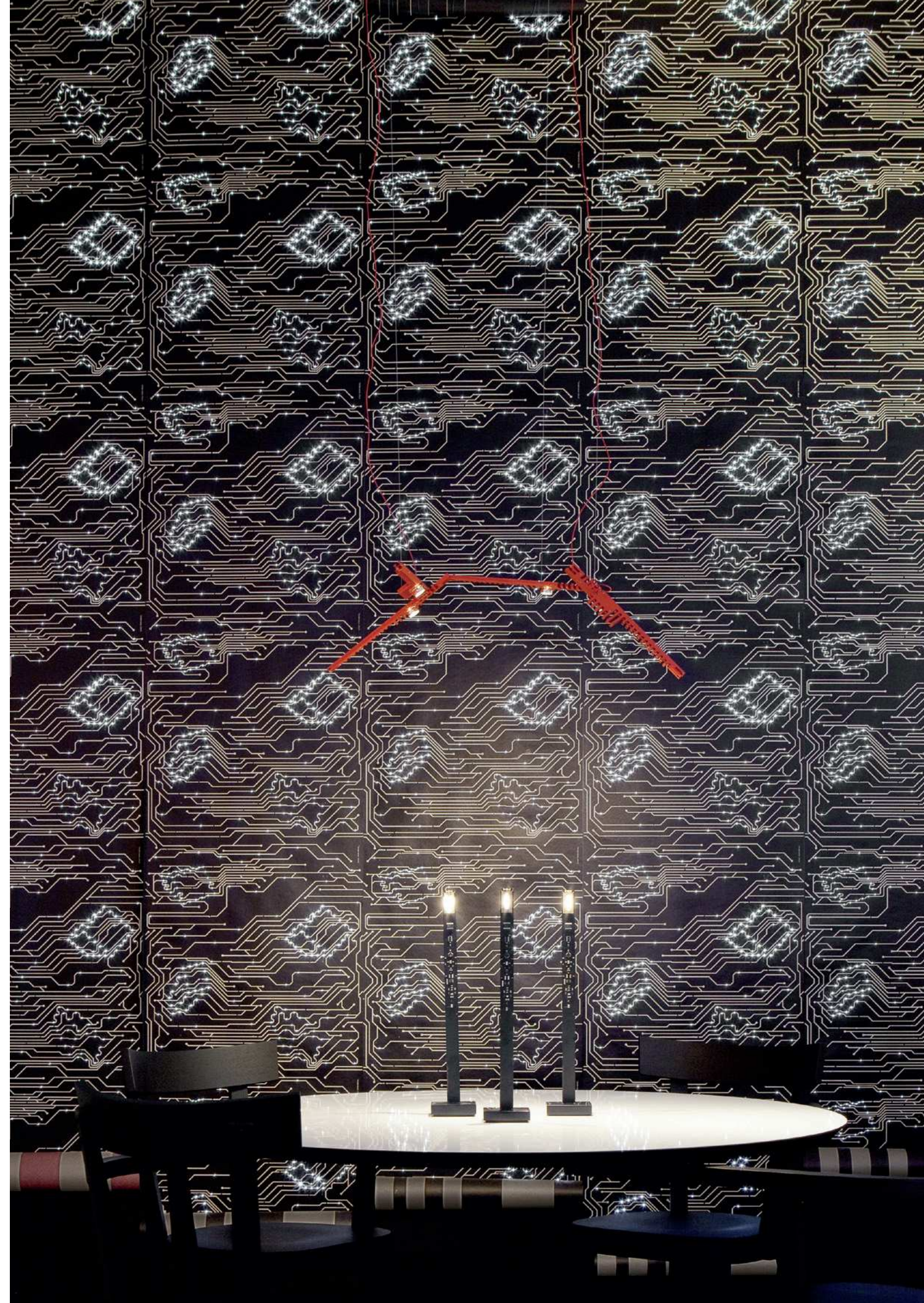



ONE THOUSAND AND ONE LIGHTS Ingo Maurer 2006

EARLY FUTURE



428



429

FLYING FUTURE OLED 2006. We are still working on it.

WHISPER WIND



We love to play seriously with the future.

Early Future. Flying Future. We believe in future.

432



DOUBLE C. FUTURE

433



DOUBLE T. FUTURE

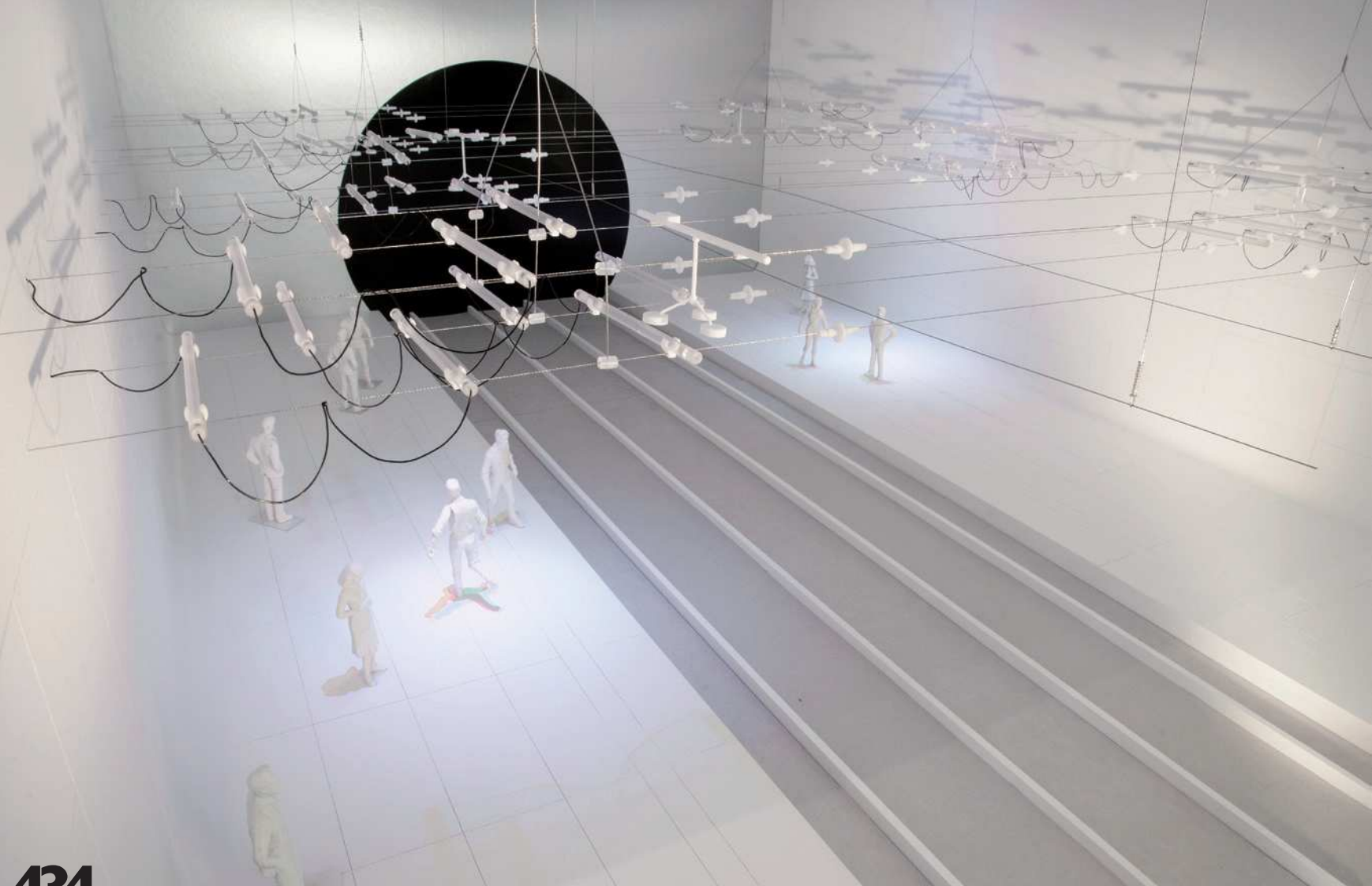

434



435

Model of one of seven subway stations in Karlsruhe, 2018.

Work in progress.





436

Subway station Munich Marienplatz, Level - 1, 2015



Coming soon.
Order now!

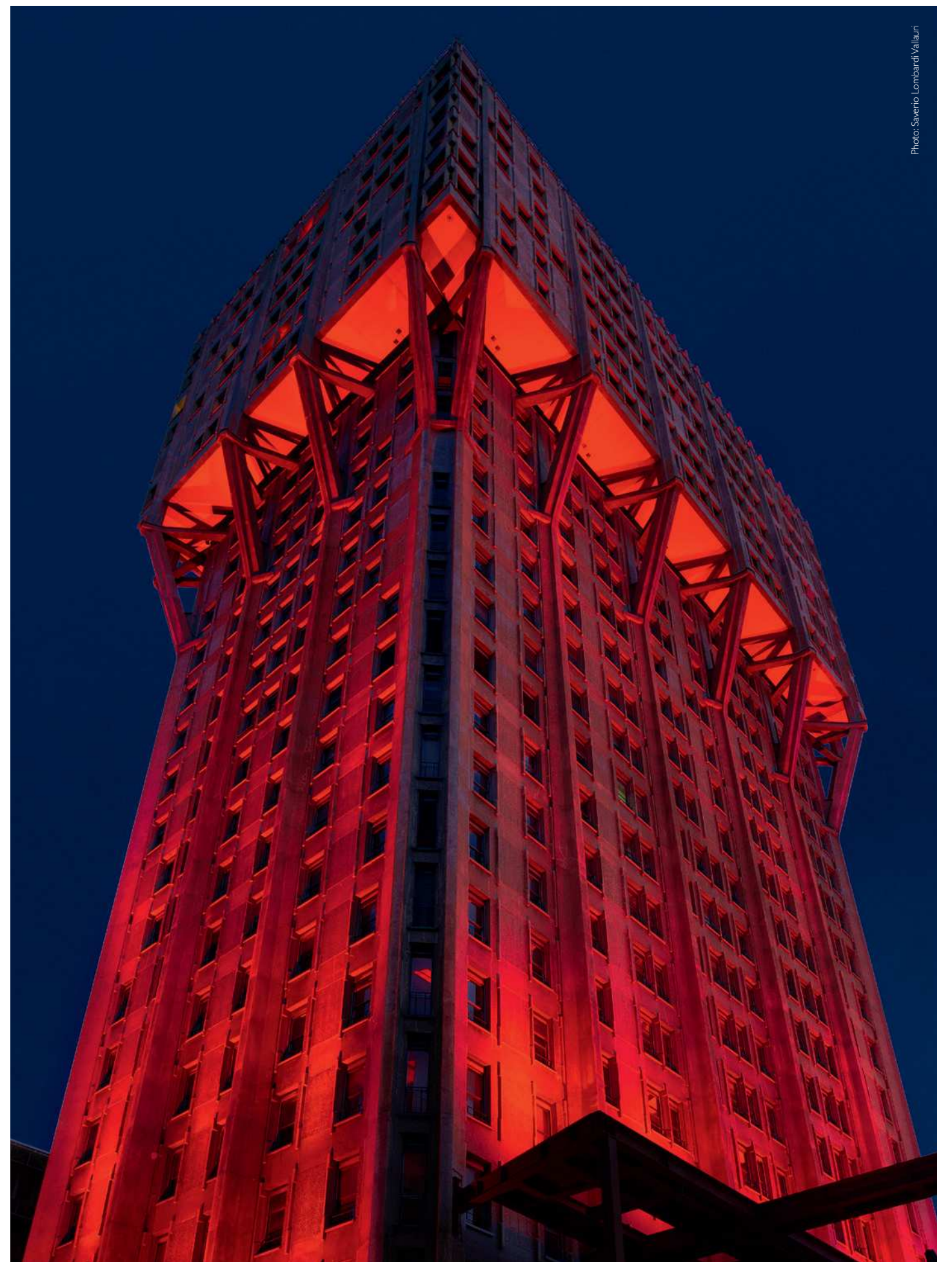

Photo: Saverio Lombardi Vallauri

437

TORRE VELASCA Milano 2016

Technische und formale Änderungen vorbehalten. Unsere Website bietet weitere Fotos, Skizzen und aktuelle Informationen. Die in diesem Katalog gedruckten Farben können von den tatsächlichen Farben der Lampen abweichen. Wir führen ein großes Spektrum von Ersatzteilen für unsere Produkte. Bitte wenden Sie sich an Ihren lokalen Händler, die zuständige Vertretung oder direkt an die Ingo Maurer GmbH.

We reserve the right to all make technical or aesthetic modifications. Our website offers more images and detailed up-to-date information. Please allow for colour discrepancies between the illustrations in this catalogue and the actual products. We carry a large range of spare parts for our products. Please contact your local dealer, your agency or Ingo Maurer GmbH.

Sous réserve de modifications techniques et de forme. Notre site internet vous propose davantage de photos, d'esquisses et d'informations détaillées et actuelles. Les couleurs imprimées dans ce catalogue peuvent varier des couleurs réelles des lampes. Nous avons une grande variété de pièces détachées pour nos produits. Veuillez contacter votre revendeur local, votre agent ou la société Ingo Maurer GmbH directement.

Salvo modifiche di carattere tecnico o formale. Il nostro sito offre ulteriori fotografie, dettagli e informazioni aggiornate. I colori riprodotti nel catalogo possono differire dai colori reali delle lampade. Offriamo una vasta gamma di ricambi per i nostri prodotti. Per informazioni rivolgersi al vostro rivenditore locale, al vostro agente oppure direttamente alla Ingo Maurer GmbH.



VISIT OUR WEBSHOP
shop.ingo-maurer.com

Photographie:
Tom Vack, Milano
Hagen Sczech, München

Studio Azzurro, Milano
Nomi Baumgartl, München
Antoine Bootz, New York
Stefan Büchner, Hahnbach
Hans Buttermilch, München
Peter Cook, London
Domus, Milano – Donato di Bello
Bernhard Dessecker, München
Robert Fischer, München
Friederike Klesper, München
Frank Koschembar, Cleeberg
Eric Laignel, New York
Tim Lehrmacher, New York
Claude Maurer, München
Elsa Maurer, München
Giovanna Piemonte, Rom
Christof Piepenstock, München
Jonathan B. Ragle, New York
Markus Tollhopf, Hamburg
Sebastian Utermöhlen, München
Peter Wachowich, Vancouver

Grafik Design/Realisierung:
Frank Koschembar/www.gute-kommunikation.com

Druck:
Druckerei Vogl GmbH & Co. KG, Zorneding

Geschäftsleitung:

Ingo Maurer
Claude Maurer
Marc-Oliver Schneider

Design, Entwicklung, Planung,
Produktion, Vertrieb:

Ralf Altermann
Viktor Antonijevic
Moritz Behrens
Werner Berthold
Albert Brandmair
Reinhold Brandmair
Winfried Brecheler
Marilyn Cassidy
Silvia Catanese
Sylvie Chevalier
Birget Daenell
Heike Dewald
Fabio Dini
Stella Doerner
Gertraud Eisenreich
David Engelhorn
Petra Fleissner
Thomas Fröhlich
Angela Guevara
Barbara Häberlein
Thomas Happel
Haki Haxhiu
Sebastian Hepting
Elke Herpich
Sandy Hofmann
Nasser Jaber
Marion Kaindl
Manfred Kaiser
Gabi Kümmerlin
Helmut Lange
Alexej Lawor
Michael Lechner
Ursula Leitner
Vassili Lianos
Dimitra Lionda
Konrad Lohöfener
Marisa Mariscal
Eric McNeil
Zoltan Mezes
Matthias Mörtlbauer
Ivica Nesic
Petra Obermaier
Tobias Reischle
Helmut Reitberger
Bernd Schäfer
Carolin Schlenker-Böhnke
Axel Schmid
Oswald Schneider
Hagen Sczech
Michel Sempels
Simone Sinhuber

Dzermal Smajlovic
Flavia Thumshirn
Evangelia Tsaoussi
Sarah Utermöhlen
Sebastian Utermöhlen
Isagani Vengco
Jenny Weber
Regina Wilhelm
Eugen Wronek

440

Ingo Maurer GmbH
Kaiserstrasse 47
80801 München
Tel. +49 89 381 6060
Fax +49 89 381 606 20
info@ingo-maurer.com

Ingo Maurer LLC
89 Grand Street
New York, NY 10013
Tel. 212 965 8817
Fax 212 965 8819
making-light@ingomaurer-usa.com

www.ingo-maurer.com



INHO MAUREN