

Kdl*n*'s light vibrates with emotion and takes shape. Unusual associations between the past and the contemporary give life to original projects that speak a universal language but are always unique. Each lamp is reminiscent of its inspiration; it is the story of a research on materials and techniques. A multifaceted world of luminous objects that meet the most diverse needs and desires in domestic settings and public spaces.

2023 PRICE LIST

Alle Preise zzgl. ges. MwSt.

EN: Light, according to Kdln, is poetry and beauty, functionality and technique, simplicity and character. A universal language, a unique and versatile style, that draws on the past in an interpretation that is original and contemporary. From domestic to contract, each project is consistent with the company's identity. Key values: attention to quality, reliability and concreteness. Together with an out-of-the-box creativity that Kdln shares with established designers as well as with emerging talents.

IT: La luce secondo Kdln è poesia e bellezza, funzionalità e tecnica, semplicità e carattere. Un linguaggio universale, uno stile unico e versatile, che attinge al passato in una lettura originale e contemporanea. Dal domestico al contract, ogni progetto è coerente con l'identità dell'azienda. Valori chiave: attenzione alla qualità, affidabilità e concretezza. Insieme a una creatività fuori dagli schemi che Kdln condivide con designer affermati e talenti emergenti.

FR: La lumière, selon Kdln est poésie et beauté, fonctionnalité et technique, simplicité et caractère. Un langage universel, un style unique et polyvalent, qui puise dans le passé dans une lecture originale et contemporaine. Du résidentiel au contract, chaque projet est cohérent avec l'identité de l'entreprise. Les valeurs-clés : attention à la qualité, fiabilité et caractère concret. Avec une créativité hors des sentiers battus que Kdln partage avec des designers confirmés et des talents émergents.

D: Für Kdln ist Licht Poesie und Schönheit, Funktionalität und Technik, Schlichtheit und Charakter. Eine universelle Sprache, ein einzigartiger und vielseitiger Stil, der sich in einer originellen und zeitgenössischen Interpretation auf die Vergangenheit stützt. Vom Wohnbereich bis hin zum Contract-Bereich steht jedes Projekt im Einklang mit der Identität des Unternehmens. Schlüsselwerte: besonderes Augenmerk auf die Qualität, Zuverlässigkeit und Konkretheit. Gemeinsam mit einer unkonventionellen Kreativität, die Kdln mit etablierten Designern und aufstrebenden Talenten teilt.

ES: La luz según Kdln es poesía y belleza, funcionalidad y técnica, simplicidad y carácter. Un lenguaje universal, un estilo único y versátil, que recurre al pasado en una lectura original y contemporánea. Desde el doméstico al contract, cada proyecto es coherente con la identidad de la empresa. Valores clave: atención a la calidad, confiabilidad y concreción. Junto a una creatividad fuera de los esquemas que Kdln comparte con diseñadores establecidos y talentos emergentes.

FLOOR

p. 14



EVITA
p. 15



E.T.A.
p. 17



KUSHI FLOOR
p. 19



KUSHI XL FLOOR
p. 21

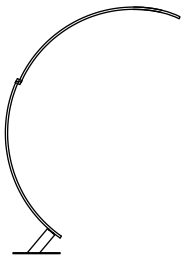

KYUDO
p. 23



MODEL T
p. 25



OPYO FLOOR
p. 27



POISE FLOOR
p. 29



SHAKTI
p. 31



SPILLO FLOOR
p. 33



SPILLO OUTDOOR
p. 34

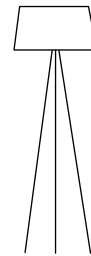

TRIPOD FLOOR
p. 37



TYLA
p. 39

TABLE

p. 40

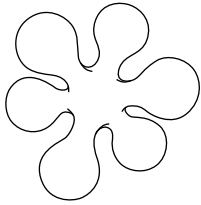

ATOMIUM
p. 41

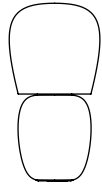

HIVE
p. 43



KUSHI MOBILE
p. 45

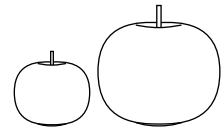

KUSHI TABLE
p. 46-47

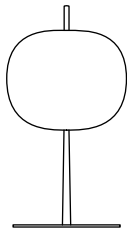

KUSHI XL TABLE
p. 49

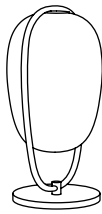

LANNÀ TABLE
p. 51

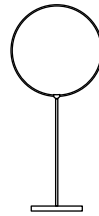

POISE
p. 53

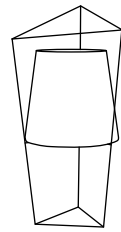

TATU
p. 55

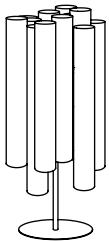

TOOT TABLE
p. 57

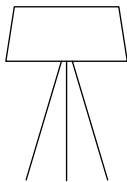

TRIPOD TABLE
p. 59

CEILING & SUSPENSION

p. 60

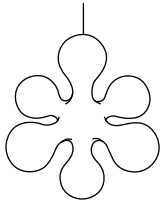

ATOMIUM SUSPENSION
p. 61

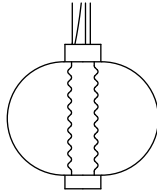

BOLHA
p. 63

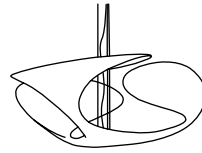

CLOVER
p. 65

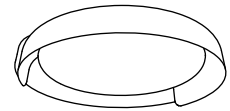

DALA
p. 67

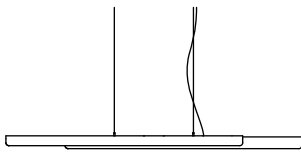

DALA LINEAR
p. 69

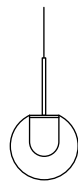

DEW
p. 71-72

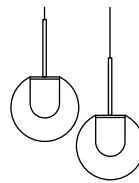

DEW CHANDELIER
p. 73-77

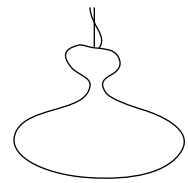

E.T.A. SAT
p. 79

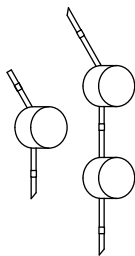

FLOED
p. 81-82

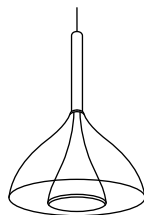

FLOOB SUSPENSION
p. 85

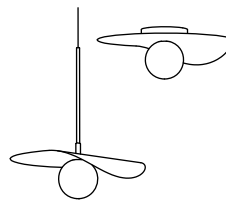

FLOW
p. 87-88

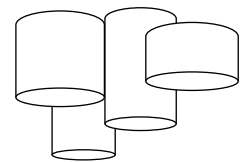

GIASS
p. 91-94



JER
p. 97



KATE
p. 99

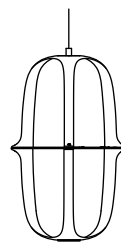

KOOI
p. 101

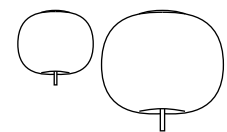

KUSHI CEILING
p. 103-105

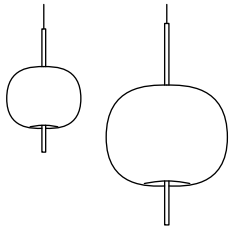

KUSHI SUSPENSION
p. 107-109

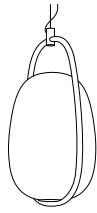

LANNÀ SUSPENSION
p. 111



LILLI
p. 113

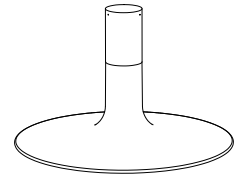

LOUIS
p. 115



MINIMAL
p. 117

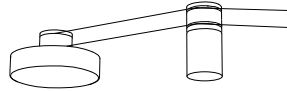

MITOS
p. 119



MOTUS
p. 121

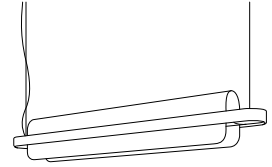

NAMI
p. 123



NEW YORK
p. 125

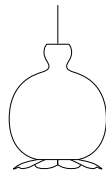

OPYO SUSPENSION
p. 127

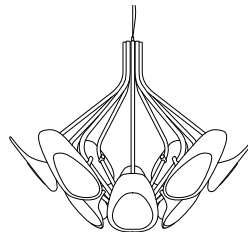

PEACOCK
p. 129

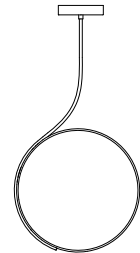

POISE CEILING
p. 131

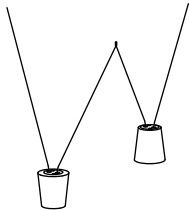

SLING
p. 133



SPILLO SUSPENSION
p. 135

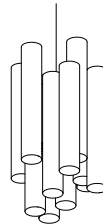

TOOT SUSPENSION
p. 137

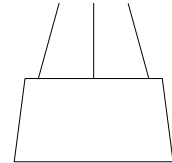

TRIPOD SUSPENSION
p. 139

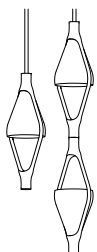

VICEVERSA
p. 141



YUMA
p. 143

WALL

p. 144

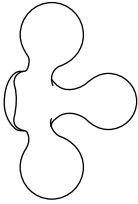

ATOMIUM WALL
p. 145

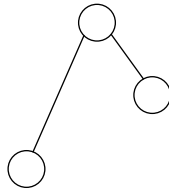

AZOU
p. 147-149



FRAME
p. 151

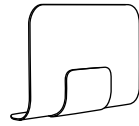

NAMI WALL
p. 153

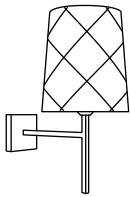

NEW YORK WALL
p. 155

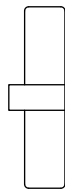

PASTILLA
p. 157

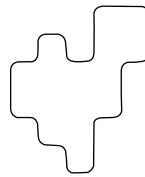

PIXEL
p. 159



SHAKTI WALL
p. 161



TUA
p. 163

ACCESSORIES

p. 164

SPECIAL CANOPIES

p. 165

FAMILY COLLECTION

ATOMIUM p. 41
ATOMIUM SUSPENSION p. 61
ATOMIUM WALL p. 145

DALA p. 67
DALA LINEAR p. 69

DEW p. 71
DEW 3 p. 72
DEW CHANDELIER p. 73-77

E.T.A. p. 17
E.T.A. SAT p. 79

FLOW p. 87
FLOW CEILING p. 88

KUSHI FLOOR p. 19
KUSHI XL FLOOR p. 21
KUSHI 16 MOBILE p. 45
KUSHI 16 TABLE p. 46
KUSHI 33 TABLE p. 47
KUSHI XL TABLE p. 49
KUSHI 16 CEILING p. 103
KUSHI 33 CEILING p. 104
KUSHI XL CEILING p. 105
KUSHI 16 SUSPENSION p. 107
KUSHI 33 SUSPENSION p. 108
KUSHI XL SUSPENSION p. 109

LANNÀ TABLE p. 51
LANNÀ SUSPENSION p. 111

NAMI p. 123
NAMI WALL p. 153

NEW YORK 33 p. 125
NEW YORK 45 p. 125
NEW YORK WALL p. 155

OPYO FLOOR p. 27
OPYO SUSPENSION p. 127

POISE FLOOR p. 29
POISE p. 53
POISE CEILING p. 131

SHAKTI 200 p. 31
SHAKTI 250 p. 31
SHAKTI WALL FIX 80 p. 161

SPILLO FLOOR p. 33
SPILLO OUTDOOR FIX p. 34
SPILLO OUTDOOR FLOOR p. 34
SPILLO OUTDOOR PEG p. 34
SPILLO SUSPENSION p. 135
SPILLO OUTDOOR SUSP. p. 135

TOOT TABLE p. 57
TOOT SUSPENSION p. 137

TRIPOD FLOOR p. 37
TRIPOD TABLE p. 59
TRIPOD SUSPENSION p. 139

TECHNICAL INFO

GLOSSARY

bulbs . lampadine . ampoules . Leuchtmittel . bombillas
cable length . lunghezza cavo . longueur de câble . Kabellänge . longitud del cable
canopy . rosone . rosace . Baldachin . plafón
certifications . certificazioni . certifications . Zertifizierungen . certificaciones
colours . colori . couleurs . Farben . colores
code . codice . code . Artikelnummer . código
description . descrizione . description . Beschreibung . descripción
dimensions . dimensioni . dimensions . Größe . dimensiones
dimmable . dimmerabile . dimmable . dimmbar . regulable
dimmer . dimmer . variateur . Dimmer . dimmer
feeding . alimentazione . alimentation . Spannung . tensión de red
finish . finitura . finitions . Oberflächen . acabados
materials . materiali . matériaux . Materialien . materiales
packaging . imballo . emballage . Verpackung . embalaje
price vat excl. . prezzo iva esc. . prix ht . Preis ohne MwSt . precio iva excluida

LIGHT DIRECTION



Direct and indirect lighting
Luce diretta e indiretta
Lumière directe et indirecte
Direktes und indirektes Licht
Luz directa y indirecta



Indirect lighting
Luce indiretta
Lumière indirecte
Indirektes Licht
Luz indirecta



Direct lighting
Luce diretta
Lumière directe
Direktes Licht
Luz directa



Indirect and spot lighting
Luce indiretta e spot
Lumière indirecte et spot
Indirektes und fokussiertes Licht
Luz indirecta y puntual



Direct and spot lighting
Luce diretta e spot
Lumière directe et spot
Direktes und fokussiertes Licht
Luz directa y puntual



Diffused lighting
Luce diffusa
Lumière diffuse
Verbreitetes Licht
Luz difusa



acid-etched brass
ottone acidato
laiton acide
satinierter Bronzefarbe
latón acidificado



amber
ambra
ambre
Bernstein
ámbar



black
nero
noir
Schwarz
negro



black marble
marmo nero
marbre noir
schwarz Marmor
mármol negro



black nickel
nichel nero
nickel noir
schwarzes Nickel
níquel negro



black tin
stagno nero
étain noir
schwarzem Zinn
estaño negro



* brass
ottone
laiton
Messing
latón



bronze
bronzó
bronce
Bronze
bronce



chrome
cromo
chrome
Chrom
cromado



** copper
rame
cuivre
Kupfer
cobre



coral
corallo
corail
Koralle
coral



dark blue
blu scuro
bleu foncé
dunkel Blau
azul oscuro



dark grey + concrete finish
grigio scuro + finitura cemento
gris foncé + finition ciment
dunkel Grau + Zementoberfläche
gris oscuro + acabado de cemento



dark grey + copper
grigio scuro + rame
gris foncé + cuivre
dunkel Grau + Kupfer
gris oscuro + cobre



dark grey + wood finish
grigio scuro + finitura legno
gris foncé + finition bois
dunkel Grau + Holzoberfläche
gris oscuro + acabado de madera



dove-grey
grigio tortora
gris tourterelle
Taubengrau
gris paloma



ecrù
ecrù
écru
Ecrú
ecru



green onyx
onice verde
onyx vert
grüner Onyx
ónix verde



grey chrome
grigio cromato
gris chromé
Chromgrau
gris cromado



mixed colours
colori misti
couleurs mélangées
gemischte Farben
colores mezclados



moka
moka
moka
Mokka
moka



orange
arancione
orange
Orange
naranja



pop
pop
pop
Pop
pop



red
rosso
rouge
Rot
rojo



sand + copper
sabbia + rame
sable + cuivre
Sand + Kupfer
arena + cobre



sand + concrete
sabbia + cemento
sable + ciment
Sand + Zement
arena + cemento



sand + wood
sabbia + legno
sable + bois
Sand + Holz
arena + madera



smokey blue
blu fumè
bleu fumé
rauch Blau
azul ahumado



smokey brown
marrone fumè
marron foncé
rauch Braun
marrón ahumado



smokey green
verde fumè
vert fumé
rauch Grün
verde ahumado



smokey grey
grigio fumè
gris fumé
Rauchgrau
gris ahumado



transparent
trasparente
transparent
durchsichtig
transparente



warm white
bianco caldo
blanc chaud
Warmweiß
blanco roto



white
bianco
blanc
Weiß
blanco



white marble
marmo bianco
marbre blanc
weiss Marmor
mármol blanco

* 111 powder coating . verniciatura a polvere . revêtement en poudre . Pulverbeschichtung . recubrimiento en polvo
205 . 209 . 219 liquid painting . verniciatura a liquido . peinture liquide . Nasslackierung . pintura líquida, 305 . 307 plated . galvanico . plaqué . galvanisch . chapado

** 212 . 221 liquid painting . verniciatura a liquido . peinture liquide . Nasslackierung . pintura líquida, 304 plated . galvanico . plaqué . galvanisch . chapado

CODES

EN. The codes in this price list are referred to devices with voltage feeding 220-240 V and are produced according to the standards in compliance with **CE** directives.

Where the abbreviation / GB is mentioned it states the possibility to order devices with plug adaptor suitable for the UK market (type G, standard IEC). The devices without plug do not require any different fitting from **CE** standard for being used in the UK market.

IT. I codici riportati in questo listino si riferiscono ad apparecchi funzionanti con tensioni di alimentazione a 220- 240 V realizzati secondo gli standard in conformità alle direttive comunitarie **CE**.

Ove presente la sigla / GB si indica la possibilità di ordinare apparecchi dotati di spine adatte per il mercato UK (tipo G, standard IEC). Gli apparecchi non dotati di spina non richiedono allestimenti diversi dagli standard **CE** per essere utilizzati nel mercato UK.

FR. Les codes dans ce tarif font référence aux luminaires à tension 220-240 V uniquement, qui sont fabriqués en conformité des normes **CE**.

Le paraphe / GB signale la possibilité de commander des lampes sur pied avec des fiches appropriées pour le marché britannique (type G, standard IEC). Les appareils sans fiches sont utilisables en Grande Bretagne sans modifications par rapport aux standards **CE**.

D. Die in dieser Preisliste aufgeführten Artikelnummer beziehen sich auf Geräte mit der Versorgungsspannung von 220-240 V, die unter der Einhaltung des **CE** Standards hergestellt wurden.

Die Abkürzung / GB ermöglicht die Bestellung der Geräte mit den Steckern, die für den britischen Markt (Typ G, Standard IEC) bestimmt sind. Geräte ohne Stecker erfordern für den britischen Markt keine besondere Ausrüstung, die unterschiedlich vom **CE** Standard ist.

ES. Los códigos que aparecen en esta tarifa, se refieren a aparatos que funcionan con tensión de alimentación a 220-240 V realizados según los standards con conformidad a las directivas comunitarias de la **CE**.

Donde esté presente las siglas / GB se indica la posibilidad de pedir aparatos dotados de enchufe adaptado para el mercado UK (tipo G, standard IEC). Los aparatos que no están dotados con enchufe no necesitan complementos diversos a los estándares **CE** para ser utilizados en el mercado UK.

NOTES

EN. Goods delivery have to be considered Ex Factory.

Goods are carefully and accurately packaged, Kdln S.r.l. declines all responsibilities for any damage caused by the transport.

All merchandise is shipped at the dealer's risk, even if free of carriage.

Any claim related to apparent and occult defects has to be communicated to Kdln by mail or fax within 8 days from the date of receipt of the goods.

Kdln reserves the right to alter any of the above conditions, at its own discretion and without notice.

Suspension lamps are supplied with 180 cm (70.9 in) long cables. Different lengths can be produced on demand. The company reserves the right to change the design of the canopies and the cable length without notice.

The dimmability of suspension and wall lamps with E27 (E26) and E14 (E12) bulb sockets depends on the dimmability of the chosen light source.

Product colors can differ from what is shown in the catalogue and from batch to batch.

The listed light emission in Lumen is nominal.

For any disputes the involved Forum is Milan (Italy).

IT. La merce si intende franco fabbrica.

La merce è attentamente e accuratamente imballata, Kdln S.r.l. declina ogni responsabilità per danni causati dal trasporto.

La merce viaggia a rischio e pericolo del committente, anche se spedita in porto franco.

Reclami per difetti apparenti ed occulti devono essere comunicati via mail o fax entro 8 giorni dal ricevimento della merce.

Kdln si riserva il diritto di modificare qualsiasi delle suddette condizioni, a propria discrezione e senza alcun preavviso.

Le lampade a sospensione sono dotate di cavi lunghi 180 cm (70.9 in).

Eventuali misure diverse possono essere prodotte su richiesta. La società si riserva comunque il diritto di variare il disegno dei rosoni e la lunghezza dei cavi senza alcun preavviso.

La dimmerabilità delle lampade a sospensione e delle lampade da parete con attacco E27 (E26) e E14 (E12) dipende dalla dimmerabilità della sorgente luminosa scelta.

I colori dei prodotti possono variare rispetto a quanto rappresentato nel catalogo e da lotto a lotto.

I lumen indicati sono da considerarsi nominali.

Per qualsiasi controversia sarà competente il Foro di Milano, Italia.

FR. La marchandise est livrée à la condition 'départ usine'.

Toutes les marchandises voyagent aux risques et périls du revendeur, même si elles sont rendues franco de port.

Les réclamations pour défauts apparents et occultes doivent être notifiés par mail ou fax dans les 8 jours suivant la réception de la marchandise.

Kdln se réserve le droit de modifier n'importe laquelle des clauses précédentes sans préavis, en fonction de ses exigences.

Les lampes à suspension sont équipées de câbles d'une longueur de 180 cm (70.9 in). D'éventuelles autres mesures peuvent être produites sur demande. La société se réserve toutefois le droit de modifier le dessin des rosaces et la longueur des câbles sans aucun préavis.

La variation de lumière des suspensions et appliques E27 (E26) et E14 (E12) dépend de la source lumineuse choisie.

Les couleurs des produits peuvent varier par rapport à ce qui est présenté dans le catalogue ainsi que de lot à lot.

Les lumens indiqués s'entendent nominaux.

Le Tribunal de Milan (Italie) sera le seul compétent pour toutes contestations.

D. Die Ware wird ab Werk verkauft.

Die Ware wird sorgfältig und gründlich verpackt. Kdln S.r.l. lehnt jegliche Haftung für Transportschäden ab.

Sämtliche Waren werden auf Risiko und Gefahr des Einzelhändlers transportiert, auch im Falle von Verschickung frei Bestimmungsort.

Jegliche Reklamationen der Waren müssen innerhalb von 8 Tagen nach Erhalt der Lieferung per Post oder Fax mitgeteilt werden.

Kdln behält sich das Recht vor, alle oben genannten Bedingungen nach eigenem Ermessen und ohne vorherige Ankündigung zu ändern. Die Hängelampen verfügen über 180 cm (70.9 in) lange Kabel.

Andere Längen können auf Anfrage hergestellt werden. Das Unternehmen behält sich in jedem Falle das Recht vor, das Design der Rosetten und die Länge der Kabel ohne Vorankündigung zu ändern.

Die Dimmbarkeit der Pendel- und Wandleuchten mit den E27-Fassungen (E26) und E14-Fassungen (E12) ist von der Dimmbarkeit der gewählten Lichtquelle abhängig.

Die Farben der Produkte können sich von den Abbildungen im Katalog unterscheiden und von einem Fertigungslos zum anderen variieren.

Die angegebenen Lumen sind Nominalwerte.

Der zuständige Gerichtshof ist Mailand (Italien).

^{ES} La mercancía se entiende a portes debidos.

La mercancía está atentamente y cuidadosamente embalada, Kdln srl declina cualquier responsabilidad por los daños causados por el transporte.

Todas las mercancías viajan a riesgo del comerciante aunque se hayan franqueado por el destinatario.

Las reclamaciones por defectos aparentes y ocultos tienen que ser comunicados por mail o por fax dentro de 8 días del recibo de la mercancías.

Kdln se reserva el derecho de modificar cualquiera de las cláusulas precedentes sin aviso previo en caso de necesidades, decisiones o exigencias propias.

Las lámparas de suspensión cuentan con cables de 180 cm (70.9 in).

Bajo petición, se pueden producir diversas medidas.

De todas formas, la sociedad se reserva el derecho de cambiar el diseño de los florones y la longitud de los cables sin previo aviso.

La dimabilidad de las lámparas a suspensión y de las lámparas a pared con enchufe E27 (E26) y E14 (E12) depende de la dimabilidad de la fuente de luz elegida.

Los lúmenes indicados son nominales.

Los colores de los productos pueden variar respecto a lo que se muestra en el catálogo y de un lote a otro. Para toda pendencia el Forum implicado es Milán (Italia).

MARKING



Class I luminaire: it's necessary to connect the device to the yellow/green protective conductor (earthing).

Apparecchio in Classe I: è obbligatoria la connessione al conduttore di protezione giallo/verde (messa a terra).

Classe I: il est obligatoire de relier l'appareil à la terre.

Schutzklasse I: alle berührbaren Metallteile sind elektrisch leitend miteinander verbunden und werden mit dem Netzschutzleiter verbunden.

Aparato en clase I: es obligatoria la conexión al conductor de protección amarillo/verde (toma de tierra).



Class II luminaire: appliance with double insulation.

Apparecchio in Classe II: apparecchio in doppio isolamento.

Classe II: appareil dote de double isolation.

Schutzklasse II: gerat mit doppelter isolierung.

Aparato en clase II: aparato provisto de aislamiento doble.



Class III luminaire: appliance in which protection against electrical shock is guaranteed by the extremely lowvoltage power supply.

Apparecchio in Classe III: apparecchio in cui la protezione contro la scossa elettrica si basa sulla alimentazione a bassissima tensione di sicurezza.

Classe III: appareil avec protection contre les décharges électriques basée sur l'alimentation à une tension de sécurité très basse.

Schutzklasse III: Zum Schutz vor elektrischen Schlägen mit Niedervolt gespeistes Gerät.

Aparato en clase III: aparato en el cual la protección contra la descarga eléctrica se debe a la alimentación a muy baja tensión.

IP20

Device protected against the penetration of solid objects greater than 12mm.

Apparecchio protetto contro la penetrazione di corpi solidi di dimensioni maggiori a 12mm.

Protégé contre la pénétration des corps solides aux dimensions supérieures à 12mm.

Gegen das Eindringen von Festkörpern größer als 12mm geschützt.

Protección contra la penetración de cuerpos sólidos de un tamaño superior a 12mm.

IP65

Device dust-tight and protected against water jets.

Apparecchio totalmente protetto contro la polvere e protetto contro i getti d'acqua.

Appareil totalement protégé contre la poussière et les projections d'eau.

Gerät mit absolutem Schutz gegen das Eindringen von Staub und geschützt gegen Druckwasser.

Aparato totalmente protegido contra el polvo y los chorros de agua.

CE

It certifies the conformity of the product to the European community directives.

Attesta la conformità del prodotto alle disposizioni della Comunità Europea.

Il atteste la conformité du produit aux directives de la Communauté Européenne.

Das Zeichen bescheinigt die Konformität des Produktes mit den Bestimmungen der Europäischen Gemeinschaft.

Certifica la conformidad del producto con las disposiciones de la Comunidad Europea.

EAC

It certifies the conformity of the product to the Eurasian Customs Union directives.

Attesta la conformità del prodotto alle disposizioni dell'Unione doganale eurasiatica.

Il atteste la conformità du produit aux directives de l'union douanière eurasiatique.

Das Zeichen bescheinigt die Konformität des Produktes mit den Bestimmungen der Eurasischen Zollunion.

Certifica la conformidad del producto con las disposiciones de la Unión Aduanera Euroasiática.



It certifies the conformity of the product to the North American market directives.

Attesta la conformità del prodotto alle disposizioni del mercato nordamericano.

Il atteste la conformité du produit aux directives du marché nord-américain.

Das Zeichen bescheinigt, dass das Produkt den Vorschriften des nordamerikanischen Marktes entspricht.

Certifica la conformidad del producto con las disposiciones del mercado norteamericano. Marca de conformidad U.S.A. y Canada.

COLLECTION

FLOOR

p. 14

TABLE

p. 40

CEILING & SUSPENSION

p. 60

WALL

p. 144

EVITA

AQUILIALBERG

EN. The name conjures up a woman of immense charm and character who inspired films, music and literature. It conveys a decisive, yet delicate elegance in its sinuous, unpredictable shape. The special elastic fabric, normally used in other contexts, wraps around the body of the light like a garment, creating unexpected curves.

IT. Nel nome cita una donna di grande fascino e carattere, che ha ispirato cinema, musica e letteratura. Nelle forme sinuose e imprevedibili comu-

nica un'eleganza decisa e delicata. Lo speciale tessuto elastico, utilizzato solitamente in altri contesti, avvolge il corpo luminoso come un abito generando curve sorprendenti.

FR. Le nom cite une femme de grand charme et au caractère fort, qui a inspiré le cinéma, la musique et la littérature. Dans ses formes sinueuses et imprévisibles, elle communique une élégance décidée tout en étant délicate. Le tissu spécial élastique, utilisé en général dans d'autres contextes,

enveloppe le corps lumineux comme un vêtement en donnant forme à des courbes surprenantes.

D. Im Namen ist eine Frau mit besonderem Zauber und Charakter verborgen, die Kino, Musik und Literatur inspiriert hat. Mit den geschwungenen und unvorhersehbaren Formen wird eine entschlossene und zarte Eleganz vermittelt. Der besondere elastische Stoff, der eigentlich für andere Kontexte verwendet wird, umhüllt den Leuchtkörper wie ein Kleid und lässt

überraschende Kurven entstehen.

ES. Su nombre cita a una mujer atractiva y de gran carácter que ha inspirado al cine, la música y la literatura. A través de sus formas sinuosas e imprevisibles comunica una elegancia determinada y delicada. El tejido elástico especial, por lo general utilizado en otros contextos, envuelve el cuerpo luminoso como si fuera un vestido generando curvas sorprendentes.





CODE

COLOUR

PRICE VAT excl.

K155060B / GB
 K155060N / GB
 K155060T / GB
 K155060R / GB

warm white
 black
 dove-grey
 red

1590 €

LIGHT SOURCE*

2x54W - T5 fluorescent
 or compatible LED light source

FEEDING

220-240 / 120 V

DIMMER

yes

LIGHT DIRECTION



CERTIFICATIONS

⊕ IP20 CE ENEC

MATERIALS

steel + technopolymers

PACKAGING

BOX 1

gross w. 12.54 kg / 27.59 lbs
 vol. 0.219 m³ / 4.548 ft³
 dim. L 25.5 x W 25 x H 202 cm
 L 10 x W 9.8 x H 79.5 in

BOX 2

gross w. 6.32 kg / 13.9 lbs
 vol. 0.006 m³ / 0.203 ft³
 dim. L 41 x W 40 x H 3.5 cm
 L 16.1 x W 15.7 x H 1.4 in



warm white RAL1013



black RAL9005



dove-grey RAL7006



red RAL3003

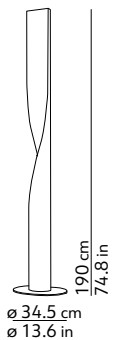

E.T.A.

GUGLIELMO BERCHICCI

EN. Craftsmanship and materials in a fascinating combination. A floor lamp in fibreglass shaped by hand. A sinuous object flooded with light that seems to arrive from faraway worlds to grace the space it occupies.

IT. Artigianalità e materia in un incontro suggestivo. Una lampada da terra in vetroresina plasmata a mano. Un

oggetto sinuoso che si illumina completamente e sembra provenire da mondi lontani, per abitare lo spazio con gentilezza.

FR. Artisanat et matière dans une rencontre suggestive. Une lampe sur pied en fibre de verre modelé à la main. Un objet sinueux qui s'éclaire entièrement et semble provenir de mondes

lointains, pour habiter l'espace avec gentillesse.

D. Handwerklichkeit und Materie treffen auf wunderbare Weise aufeinander. Eine am Bodenstehende Lampe aus handgeformtem Fiberglas. Ein geschwungener Gegenstand, der sich vollständig erhellt und aus einer fernen Welt zu kommen scheint, um den

Raum auf sanfte Weise auszufüllen.

ES. Artesanía y materia en un sugestivo encuentro. Una lámpara de pie realizada en fibra de vidrio modelada a mano. Un objeto sinuoso que se ilumina por completo y que parece provenir de mundos lejanos para habitar el espacio con desenvoltura.





CODE	COLOUR	PRICE VAT excl.
0171596BIEU / GB	white	1330 €
0171596AREU / GB	orange	

LIGHT SOURCE*

3x40W max - E14 (E12) +
1x100W max - E27 (E26)

FEEDING

220-240 / 120 V

DIMMER

yes

LIGHT DIRECTION



CERTIFICATIONS

☐ IP20 CE ENEC

MATERIALS

fiberglass + metal

PACKAGING

BOX 1

gross w. 14.32 kg / 31.50 lbs
vol. 0.399 m³ / 14.089 ft³
dim. L 44 x W 45 x H 201.5 cm
L 17.3 x W 17.7 x H 79.3 in



white



orange

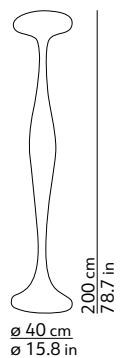

KUSHI FLOOR

ALBERTO SAGGIA & VALERIO SOMMELLA

EN. Travel, explore and get inspired. Kushi, the traditional Japanese skewer, becomes an original floor lamp. Three slim rods and three glass diffusers are intertwined. Elegant, welcoming atmospheres for the contract world and home interiors.

IT. Viaggiare, scoprire e ispirarsi. Kushi, il tradizionale spiedino giapponese, diventa originale lampada da

terra. Tre aste sottili e tre diffusori in vetro si intrecciano fra loro. Atmosfere eleganti e accoglienti per il contract e gli interni della casa.

FR. Voyager, découvrir et s'inspirer. Kushi, la traditionnelle brochette japonaise, devient un lampadaire original. Trois fines tiges et trois diffuseurs en verre s'entrecroisent. Atmosphères élégantes et accueillantes pour le secteur

contract et les intérieurs de maison.

D. Reisen, entdecken, sich inspirieren lassen. Kushi, der traditionell japanische Spieß, wird zu einer originellen Stehlampe. Drei schmale Stangen und drei Lampenschirme aus Glas verflechten sich miteinander. Elegante und wohlige Atmosphären für den Contract- und den Wohnbereich.

ES. Viajar, descubrir e inspirarse. Kushi, la brocheta tradicional japonés, se convierte en una lámpara de pie original. Tres barras sutiles y tres difusores de cristal se entrelazan uno con otro. Elegantes y acogedoras atmósferas para ambientes comerciales e interiores de la casa.



KUSHI FLOOR



CODE	COLOUR	PRICE VAT excl.
K2281059N / GB	black	960 €
K2281059O / GB	brass	
K2281059R / GB	copper	

LIGHT SOURCE*

board LED 3x4.6W
 2700 K - 1900 lm - CRI>80

FEEDING

100-240 V

DIMMER

yes

LIGHT DIRECTION



CERTIFICATIONS

☐ IP20 CE ENEC

MATERIALS

glass + metal

PACKAGING

BOX 1

gross w. 7.6 kg / 16.72 lbs
 vol. 0.202 m³ / 7.127 ft³
 dim. L 139 x W 44 x H 33 cm
 L 54.7 x W 17.3 x H 13 in



black RAL9005



brass 205



copper 212

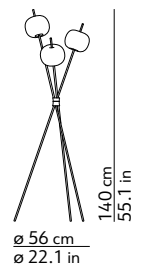

KUSHI XL FLOOR

ALBERTO SAGGIA & VALERIO SOMMELLA

EN. A long, metal rod pierces the soft glass diffuser. The evocative intensity of the simplest and purest of shapes for an imposing lamp with a sophisticated and discrete presence.

IT. Una lunga asta in metallo attraversa il morbido diffusore in vetro. L'intensità evocativa delle forme più

semplici e pure per una lampada dalle dimensioni importanti e dalla presenza sofisticata e discreta.

FR. Une longue tige métallique traverse le diffuseur en verre. L'intensité évocatrice des formes les plus simples et les plus pures pour une lampe aux dimensions importantes et à la prés-

ence à la fois sobre et sophistiquée.

D. Eine lange Stange aus Metall durchquert den zarten Lampenschirm aus Glas. Die wunderbare Intensität der einfachsten und reinsten Formen für eine Lampe mit großen Abmessungen und einer raffiniert-unauffälligen Präsenz.

ES. Una larga barra de metal atraviesa el suave difusor de cristal. La intensidad evocativa de las formas más sencillas y puras para una lámpara de tamaño importante con una presencia elegante y discreta.



KUSHI XL FLOOR



CODE	COLOUR	PRICE VAT excl.
K219105N / GB	black	1160 €
K219105O / GB	brass	
K219105R / GB	copper	

LIGHT SOURCE*

2x70W max - E27 (E26)
 Ø 6cm max

FEEDING

220-240 / 120 V

DIMMER

yes

LIGHT DIRECTION



CERTIFICATIONS

☐ IP20 CE ENEC

MATERIALS

glass + metal

PACKAGING

BOX 1

gross w. 5.5 kg / 12.1 lbs
 vol. 0.107 m³ / 3.766 ft³
 dim. L 51 x W 51 x H 41 cm
 L 20.1 x W 20.1 x H 16.1 in

BOX 2

gross w. 4.2 kg / 9.24 lbs
 vol. 0.068 m³ / 2.401 ft³
 dim. L 170 x W 20 x H 20 cm
 L 66.9 x W 7.9 x H 7.9 in

BOX 3

gross w. 10.2 kg / 22.44 lbs
 vol. 0.009 m³ / 0.319 ft³
 dim. L 47.5 x W 47.5 x H 4 cm
 L 18.7 x W 18.7 x H 1.6 in



black RAL9005

brass 205

copper 304

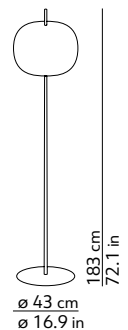

KYUDO

HANSANDFRANZ

EN. Kyudo literally means the "way of the bow", a thousand-year-old discipline inspired by Zen philosophy. And like an arc of light, the floor lamp conveys a sense of balance and elegance. The continuous sequence of LED lights creates an adjustable ribbon of light thanks to the two arcs that form the structure and slide one over the other.

IT. Kyudo è la via dell'arco, disciplina millenaria ispirata alla filosofia Zen. E come un arco di luce, la lampada da

terra trasmette sensazioni di equilibrio ed eleganza. La sequenza continua di led traccia un nastro luminoso posizionabile a piacere, grazie ai due archi che compongono la struttura e scorrono uno sull'altro.

FR. Kyudo est la voie de l'arc, discipline millénaire inspirée de la philosophie zen. Et comme un arc de lumière, la lampe sur pied transmet des sensations d'équilibre et d'élégance. La séquence continue

de LEDs trace un ruban lumineux qui peut être positionné au plaisir, grâce à deux arcs qui composent la structure et glissent l'un sur l'autre.

D. Kyudo ist ein Bogen, eine jahrtausendealte Disziplin, die von der Zen-Philosophie inspiriert ist. Und wie ein Lichtbogen vermittelt die auf dem Boden stehende Lampe das Gefühl der Ausgewogenheit und Eleganz. Die durchgehende Sequenz mit LEDs stellt einen nach Belieben positionierbaren

Lichtstrahl dar, und zwei Bögen bilden die Struktur und verlaufen aufeinander.

ES. Kyudo es la vía del arco, disciplina milenaria inspirada en la filosofía Zen. Al igual que un arco de luz, la lámpara de pie transmite sensaciones de equilibrio y elegancia. La secuencia continua de led traza una banda luminosa, que puede instalarse a placer, gracias a los dos arcos que componen la estructura y se deslizan uno sobre el otro.



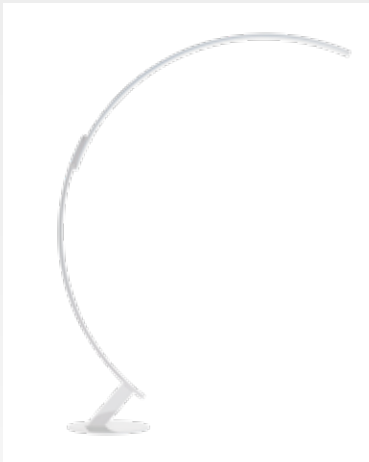

CODE	COLOUR	PRICE VAT excl.
K048133BIEU / GB	white	1650 €
K048133NEEU / GB	black	
K048133AREU / GB	orange	

LIGHT SOURCE*
strip LED 1x43.2W
2700 K - 4200 lm - CRI>90

FEEDING
100-240 V

DIMMER
yes

LIGHT DIRECTION



CERTIFICATIONS
IP20 CE ENEC

MATERIALS
aluminium

PACKAGING
BOX 1
gross w. 6.74 kg / 14.83 lbs
vol. 0.075 m³ / 2.664 ft³
dim. L 46 x W 10 x H 164 cm
L 18.1 x W 3.9 x H 64.6 in

BOX 2
gross w. 7.24 kg / 15.93 lbs
vol. 0.015 m³ / 0.530 ft³
dim. L 50 x W 50 x H 6 cm
L 19.7 x W 19.7 x H 2.4 in

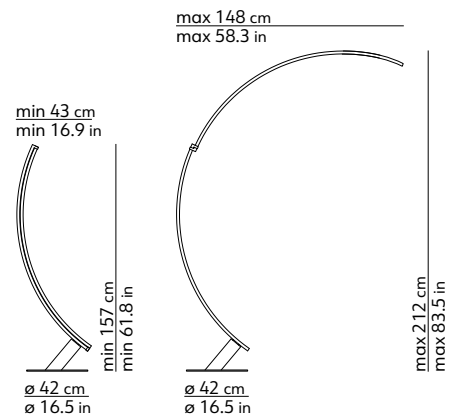
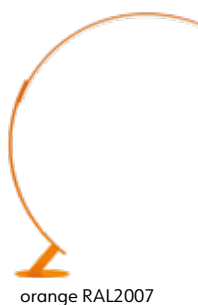

MODEL T

FRANCESCA SMIRAGLIA

EN. The De Stijl artistic movement inspires with its linear and simple forms. And precisely, the two-dimensional geometric shapes such as the square and the rectangle act as a counterweight to the tubular and three-dimensional light of Model T, the minimalist, sculptural and universal floor lamp.

IT. Il movimento artistico De Stijl ispira con il suo linearismo e semplicità delle

forme. E proprio le forme geometriche bidimensionali come il quadrato e il rettangolo fanno da contrappeso alla luce tubolare e tridimensionale di Model T, la lampada da terra minimalista, scultorea e universale.

FR. Le mouvement artistique De Stijl inspire par son linéarisme et la simplicité de ses formes. Et ce sont précisément les formes géométriques bidimensionnelles telles que le carré

et le rectangle qui contrebalancent la lumière tubulaire et tridimensionnelle de Model T, le lampadaire minimaliste, sculptural et universel.

D. Die Kunstrichtung De Stijl inspiriert durch ihre Geradlinigkeit und Einfachheit der Form. Und es sind gerade die zweidimensionalen geometrischen Formen wie das Quadrat und das Rechteck, die ein Gegengewicht zum röhrenförmigen, dreidimensionalen

Licht der minimalistischen, skulpturalen und universellen Stehleuchte Model T bilden.

ES. El movimiento artístico De Stijl inspira con su linealismo y simplicidad de formas. Y son precisamente las formas geométricas bidimensionales, como el cuadrado y el rectángulo, las que equilibran la luz tubular y tridimensional de Model T, la lámpara de pie minimalista, escultural y universal.





CODE	COLOUR	PRICE VAT excl.
K511435N / GB K511435POP / GB	black pop	970 €
K511435INOX / GB	inox	1250 €

LIGHT SOURCE*

board LED 1x60W
2700 K - 6600 lm - CRI>90

FEEDING

100-240 V

DIMMER

yes

LIGHT DIRECTION



CERTIFICATIONS

☐ IP20 CE

MATERIALS

metal + plexiglas

PACKAGING

BOX 1

gross w. 6.8 kg / 15 lbs
vol. 0.077 m³ / 2.702 ft³
dim. L 30 x W 30 x H 85 cm
L 11.8 x W 11.8 x H 33.5 in

BOX 2

gross w. 3.4 kg / 7.5 lbs
vol. 0.062 m³ / 2.174 ft³
dim. L 18 x W 18 x H 190 cm
L 7.1 x W 7.1 x H 74.8 in

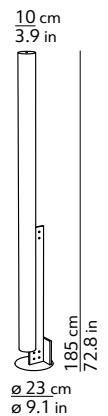

OPYO FLOOR

CRISTINA CELESTINO

EN. The intelligence of nature with its perfect and unexpected forms is the inspiration behind the Opyo design. The delicate, clean lines of the poppy seed pod inspire the opal glass diffuser. It is supported by a long metal stem, just like the flower. A floor lamp which brings the harmonious mystery of the botanical world indoors.

IT. L'intelligenza della natura, con le sue forme perfette e inaspettate, suggerisce il design di Opyo. Le linee delicate e nitide del baccello di papavero

ispirano il diffusore in vetro opale. Lo sorregge il lungo stelo in metallo, proprio come nel fiore. Una lampada da terra che porta negli interni la misteriosa armonia del mondo botanico.

FR. L'intelligence de la nature, avec ses formes parfaites et inattendues, suggère le design d'Opyo. Les lignes délicates et nettes de la cosse de pavot inspirent le diffuseur en verre opale. Il est soutenu par une longue tige en métal, tout comme la fleur. Une lampe sur pied qui apporte aux espa-

ces d'intérieur l'harmonie mystérieuse du monde botanique.

D. Die Intelligenz der Natur mit ihren perfekten und unerwarteten Formen ist im Design von Opyo wiederzufinden. Die zarten und klaren Linien der Samenhülse von Mohnblüten dienen als Inspiration für den Lampenschirm aus mattem Glas. Er wird vom langen Stiel aus Metall gehalten, genau gleich wie bei der Blume. Eine Stehlampe, die die mysteriöse Harmonie der Welt der Botanik in die Innenräume bringt.

ES. La inteligencia de la naturaleza, con sus formas perfectas e inesperadas, evoca el diseño de Opyo. Las delicadas y nítidas líneas de la flor de amapola inspiran al difusor de cristal ópalo. Al igual que en la flor, un largo tallo de metal sujeta la estructura. Una lámpara de pie que da a los espacios interiores la misteriosa armonía del mundo botánico.





CODE

COLOUR

PRICE VAT excl.

K350355B / GB
K350355C / GB
K350355O / GB

white
coral
brass

896 €

LIGHT SOURCE*

1x70W max - E27 (E26)

FEEDING

220-240 / 120 V

DIMMER

yes

LIGHT DIRECTION



CERTIFICATIONS

☐ IP20 CE ENEC

MATERIALS

glass + metal

PACKAGING

BOX 1

gross w.

vol. 2.00 kg / 4.40 lbs

dim. 0.027 m³ / 0.968 ft³

L 29.5 x W 29.5 x H 31.5 cm

L 11.6 x W 11.6 x H 12.4 in

BOX 2

gross w.

vol. 3.50 kg / 7.70 lbs

dim. 0.046 m³ / 1.625 ft³

L 165 x W 18.5 x H 15 cm

L 65 x W 7.3 x H 5.9 in

BOX 3

gross w.

vol. 12.00 kg / 26.40 lbs

dim. 0.007 m³ / 0.249 ft³

L 17.5 x W 17.5 x H 23 cm

L 6.9 x W 6.9 x H 9.1 in

BOX 4

gross w.

vol. 1.54 kg / 3.39 lbs

dim. 0.012 m³ / 0.410 ft³

L 22 x W 22 x H 24 cm

L 8.7 x W 8.7 x H 9.5 in



white RAL9010

coral RAL3012

brass 219

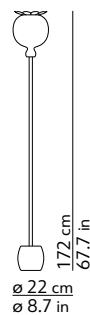

POISE FLOOR

ROBERT DABI

EN. In Poise, human curiosity and the interaction with light source, are encouraged by the flexible section between frame and the circle, allowing the latter to be moved into any position. A vitality capable of creating ever-changing configurations defying gravity.

IT. In Poise, la curiosità e l'interazione umana con la sorgente luminosa sono incoraggiate dalla sezione flessibile

tra l'asta e l'anello, che consente di spostare quest'ultimo in qualsiasi posizione. Un dinamismo che sfida la forza di gravità per creare configurazioni mutevoli.

FR. Sur Poise, la curiosité et l'interaction humaine avec la source lumineuse sont encouragées par la section flexible entre la tige et le cercle, qui permet de déplacer ce der-

nier dans n'importe quelle position. Un dynamisme qui défie la force de gravité pour créer des configurations changeantes.

D. Bei Poise werden die Neugier und die menschliche Interaktion mit der Lichtquelle durch den flexiblen Abschnitt zwischen Stab und Ring gefördert, der es ermöglicht, letzteren in jede Position zu bewegen. Eine Dynamik, die der

Schwerkraft trotzt, um veränderbare Konfigurationen zu schaffen.

ES. En Poise, la curiosidad y la interacción humana con la fuente de luz se ven favorecidas por la sección flexible entre la varilla y el anillo, que permite mover este último a cualquier posición. Un dinamismo que desafía la fuerza de gravedad para crear configuraciones cambiantes.



POISE FLOOR



CODE	COLOUR	PRICE VAT excl.
505425N / GB	black	550 €

LIGHT SOURCE*

strip LED 1x28W
2700 K - 3600 lm - CRI>90

FEEDING

220-240 / 120 V

DIMMER

yes

LIGHT DIRECTION**CERTIFICATIONS**

☐ IP20 CE

MATERIALS

metal

PACKAGING**BOX 1**

gross w. 5.60 kg / 12.32 lbs
vol. 0.034 m³ / 1.194 ft³
dim. L 65 x W 65 x H 8 cm
L 25.6 x W 25.6 x H 3.2 in



black RAL9005

∅ 55 cm
∅ 21.7 in



max 196 cm
max 77.2 in

28 cm
11.0 in

SHAKTI

MARZIO RUSCONI CLERICI

EN. Industrial language finds an unusual expression and plays on simple, clean lines. The tubular diffuser, sliced diagonally at both ends, acquires a new impetus. Formal purity for a floor lamp that is always up-to-date.

IT. Il linguaggio industriale trova una singolare espressività e gioca con linee essenziali e nette. Il diffusore

tubolare tagliato in diagonale alle due estremità assume nuovo slancio. Purezza formale per una lampada da terra sempre attuale.

FR. Le langage industriel trouve une expression singulière et joue avec les lignes essentielles et nettes. Le diffuseur tubulaire coupé en diagonale aux deux extrémités prend un nouvel

élan. Pureté formelle pour une lampe sur pied toujours actuelle.

D. Die industrielle Sprache findet eine einzige Ausdrucksform und spielt mit einfachen und klaren Linien. Der röhrenförmige Lampenschirm, der an beiden Enden diagonal durchgeschnitten wurde, erlebt einen neuen Aufschwung. Formelle Reinheit für eine

stets aktuelle Stehlampe.

ES. El lenguaje industrial encuentra una expresividad original y juega con líneas esenciales y limpias. El difusor tubular cortado en diagonal en los dos extremos asume un nuevo impulso. Pureza formal para una lámpara de pie siempre actual.





CODE	COLOUR	PRICE VAT excl.
SHAKTI 200		
KSA110BIEU / GB	white + satin base	780 €
KCR110BIEU / GB	white + polished base	830 €
SHAKTI 250		
KSA111BIEU / GB	white + satin base	950 €

LIGHT SOURCE*
2x100W max - E27 (E26)

FEEDING
220-240 / 120 V

DIMMER
yes

LIGHT DIRECTION



CERTIFICATIONS
IP20 CE ENEC

MATERIALS
plexiglas + steel

PACKAGING
SHAKTI 200

BOX 1
gross w. 5.50 kg / 12.10 lbs
vol. 0.116 m³ / 4.110 ft³
dim. L 220 x W 23 x H 23 cm
L 86.6 x W 9.1 x H 9.1 in

BOX 2
gross w. 3.46 kg / 7.61 lbs
vol. 0.007 m³ / 0.230 ft³
dim. L 37 x W 32 x H 5.5 cm
L 14.6 x W 12.6 x H 2.2 in

SHAKTI 250

BOX 1
gross w. 6.88 kg / 15.14 lbs
vol. 0.174 m³ / 6.129 ft³
dim. L 267 x W 26 x H 25 cm
L 105.1 x W 10.2 x H 9.8 in

BOX 2
gross w. 4.84 kg / 10.65 lbs
vol. 0.008 m³ / 0.287 ft³
dim. L 36.5 x W 40.5 x H 5.5 cm
L 14.4 x W 15.9 x H 2.2 in



white

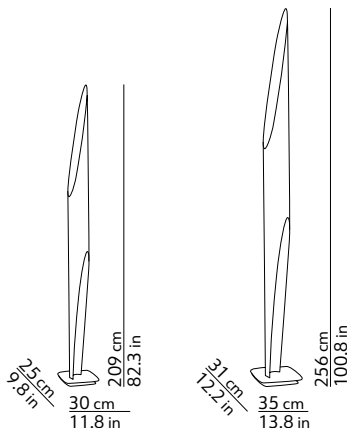

1. SPILLO FLOOR 2. SPILLO OUTDOOR

CONSTANTIN WORTMANN

EN. The subtle poetry of the simplicity of a lamp which, with elegance and irony, mimics an everyday object. Producing a fluid, elementary sign. An organic form which takes its lightness outdoors as well. Perfect in the outdoor version for terraces, gardens and open-air spaces.

IT. La sottile poesia della semplicità in una lampada che, con eleganza e ironia, cita un oggetto di uso quotidiano.

Nasce un segno fluido ed elementare. Una forma organica che porta la sua leggerezza anche in esterni. Perfetta nella versione outdoor per terrazze, giardini e dehors.

FR. La fine poésie de la simplicité en une lampe qui, avec élégance et ironie, cite un objet que l'on utilise tous les jours. Naissance d'un signe fluide et élémentaire. Une forme organique qui porte sa légèreté même en

extérieur. Parfaite dans la version extérieure pour des terrasses, des jardins et des espaces extérieurs.

D. Die zarte Poesie der Einfachheit in einer Lampe, die mit Eleganz und Ironie einen Alltagsgegenstand zitiert. So entsteht ein fließendes und wichtiges Zeichen. Eine organische Form, die ihre Leichtigkeit auch in Außenräumen zeigt. Perfekt in der Outdoorversion für Terrassen, Gärten und Außenbereiche.

ES. La sutil poesía de la simplicidad en una lámpara que con elegancia e ironía interpreta a un objeto de uso cotidiano. Nace un signo fluido y básico. Una forma orgánica que da su ligereza incluso en los espacios exteriores. Perfecta en la versión de exterior para terrazas, jardines y zonas al aire libre.



SPILLO FLOOR



CODE	COLOUR	PRICE VAT excl.
232134EU / GB	white	659 €

LIGHT SOURCE*

1x21W max - E27 (E26)
 Ø 5cm max

FEEDING

220-240 / 120 V

DIMMER

no

LIGHT DIRECTION**CERTIFICATIONS**

☐ IP20 CE ENEC

MATERIALS

polyethylene + metal

PACKAGING**BOX 1**

gross w. 8.94 kg / 19.67 lbs

vol. 0.218 m³ / 7.688 ft³

dim. L 129.5 x W 41 x H 41 cm
 L 51 x W 16.1 x H 16.1 in



white

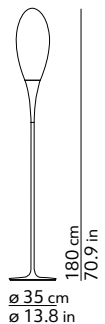

SPILLO OUTDOOR



CODE	COLOUR	PRICE VAT excl.
SPILLO OUTDOOR FIX K232134IPEU	white	550 €
SPILLO OUTDOOR FLOOR K232134EU	white	778 €
SPILLO OUTDOOR PEG 232134IPEU	white	583 €

LIGHT SOURCE*

1x21W max - E27 (E26)
Ø 5cm max

FEEDING

220-240 / 120 V

DIMMER

no

LIGHT DIRECTION**CERTIFICATIONS**

☐ IP65 CE ENEC

MATERIALS

polyethylene + metal

PLUG

IP65 connector

PACKAGING

SPILLO OUTDOOR FIX
SPILLO OUTDOOR FLOOR
SPILLO OUTDOOR PEG

BOX 1

gross w. 2.92 kg / 6.42 lbs
vol. 0.047 m³ / 1.647 ft³
dim. L 26 x W 26 x H 69 cm
L 10.2 x W 10.2 x H 27.2 in

SPILLO OUTDOOR FIX

BOX 2

gross w. 1.54 kg / 3.39 lbs
vol. 0.028 m³ / 0.988 ft³
dim. L 56 x W 37 x H 13.5 cm
L 22.1 x W 14.6 x H 5.3 in

SPILLO OUTDOOR FLOOR

BOX 2

gross w. 5.96 kg / 13.11 lbs
vol. 0.028 m³ / 0.988 ft³
dim. L 56 x W 37 x H 13.5 cm
L 22.1 x W 14.6 x H 5.3 in

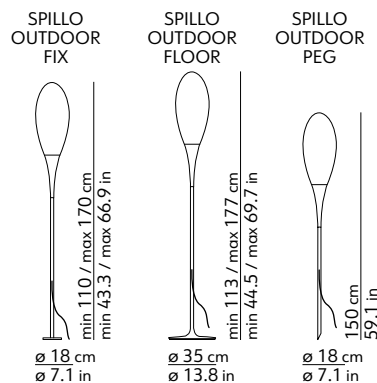
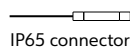



TRIPOD FLOOR

CHRISTOPHE PILLET

EN. The modular elements of the most classic of lamps become basic and exclusive. Three simple lines for the support and straightforward volume for the fabric lampshade. An ethereal, refined and timeless object.

IT. Gli elementi compositivi della più classica delle lampade diventano es-

senziali, rarefatti. Tre semplici linee per i sostegni, volumetria pulita per il paralume in tessuto. Un oggetto etereo, raffinato e senza tempo.

FR. Les éléments qui composent la plus classique des lampes deviennent essentiels, raréfiés. Trois lignes simples pour les soutiens,

volumes propres pour l'abat-jour en tissu. Un objet éthéré, raffiné et hors du temps.

D. Die Elemente, aus denen die klassische aller Lampen besteht, werden essenziell, raffiniert. Drei einfache Linien für die Halterung, klare Volumen für den Lampenschirm aus Stoff. Ein

ewiger Gegenstand, raffiniert und zeitlos.

ES. Los elementos compositivos de la lámpara más clásica de vuelven esenciales y rarefactos. Tres simples líneas para los soportes y una volumetría limpia para la pantalla realizada de tela. Un objeto etéreo, refinado y atemporal.



TRIPOD FLOOR



CODE

COLOUR

PRICE VAT excl.

K947BIEU / GB
K947BEEU / GB
K947MOEU / GB

white
ecrù
moka

890 €

LIGHT SOURCE*

3x70W max - E27 (E26)

FEEDING

220-240 / 120 V

DIMMER

yes

LIGHT DIRECTION



CERTIFICATIONS

☐ IP20 CE ENEC

MATERIALS

metal + fabric

PACKAGING

BOX 1

gross w. 3.54 kg / 7.79 lbs

vol. 0.119 m³ / 4.195 ft³

dim. L 60 x W 60 x H 33 cm

L 23.6 x W 23.6 x H 13 in

BOX 2

gross w. 4.4 kg / 9.68 lbs

vol. 0.060 m³ / 2.133 ft³

dim. L 176.5 x W 18.5 x H 18.5 cm

L 69.5 x W 7.3 x H 7.3 in



white



ecrù



moka

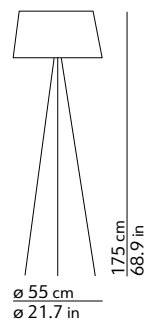

TYLA

MARC SADLER

EN. The long slender stems of the bulrush, an elegant aquatic plant, are the inspiration behind the elements which support this light with a delicate, almost lyrical design. And the same movement of the plant in the wind is reflected in the unusual lampshade. A slightly irregular shape, featuring opaque glass on the inside and clear glass on the outside, brought to life by the bright faceted surface.

IT. I lunghi steli filiformi della Typha latifolia, elegante pianta acquatica, ispirano i sostegni di questa lampada

dal design delicato, quasi lirico. E lo stesso movimento delle piante mosse dal vento torna nell'originale paralume. Una forma dolcemente irregolare, in vetro opaco all'interno e trasparente all'esterno, animata da luminose frastagliature.

FR. Les longues tiges filiformes de Typha latifolia, une élégante plante aquatique, inspirent les supports de cette lampe au design délicat, presque lyrique. Et le même mouvement des plantes bercées par le vent revient dans l'abat-jour original. Une forme

délicate légèrement irrégulière, en verre opaque à l'intérieur et transparent à l'extérieur, animée par des dentelures lumineuses.

D. Die langen, fadenförmigen Stiele der Typha latifolia, einer eleganten Wasserpflanze, inspirierten die Halterung dieser Lampe mit raffiniertem, fast lyrischem Design. Und die Bewegung der Pflanzen, die im Wind wiegen, wird für den originellen Lampenschirm aufgenommen. Eine wunderbar unregelmäßige Form mit mattem Glas innen und transparentem Glas außen,

bewegt durch leuchtende Einschnitte.

ES. Esta lámpara de diseño delicado, casi lírico, se inspira en los largos tallos filiformes de la Typha latifolia, una elegante planta acuática. Y el mismo movimiento de las plantas cuando las mueve el viento se reproduce también en la original pantalla. Una forma dulcemente irregular, en cristal opaco por dentro y transparente por fuera, animada por luminosas facetas.





CODE

COLOUR

PRICE VAT excl.

K501418B / GB
K501418BLU / GB
K501418RO / GB

white
dark blue
red

935 €

LIGHT SOURCE*

1x70W max - E27 (E26)

FEEDING

220-240 / 120 V

DIMMER

yes

LIGHT DIRECTION



CERTIFICATIONS

IP20 CE ENEC

MATERIALS

glass + steel

PACKAGING

BOX 1

gross w. 7 kg / 15.43 lbs

vol. 0.109 m³ / 3.858 ft³

dim. L 51 x W 51 x H 42 cm

L 20.1 x W 20.1 x H 16.5 in

BOX 2

gross w. 10 kg / 22.05 lbs

vol. 0.062 m³ / 2.176 ft³

dim. L 180 x W 18.5 x H 18.5 cm

L 70.9 x W 7.3 x H 7.3 in



white RAL9010



dark blue RAL5004



red RAL3004

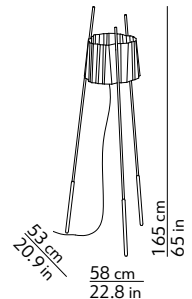

ATOMIUM

HOPF&WORTMANN - BÜRO FÜR FORM

EN. The luminous reinterpretation of the historic architectural symbol of Brussels, created for Expo in 1958. A large, versatile lamp with a hybrid use that can be placed freely on the table or the floor, emanating a soft light in all directions.

IT. Reinterpretazione luminosa della storica architettura simbolo di Bruxelles, realizzata per l'Esposizione Universale del 1958. Lampada ver-

satile e dall'utilizzo ibrido, con le sue dimensioni importanti si posiziona liberamente sul tavolo o anche a terra, emanando una luce multidirezionale e soffusa.

FR. Réinterprétation lumineuse de l'architecture historique, symbole de la ville de Bruxelles, réalisée pour l'Exposition universelle de 1958. Lampe polyvalente et à l'utilisation hybride, avec ses dimensions importantes, elle

se positionne librement sur la table ou également au sol, en diffusant une lumière dans toutes les directions et tamisée.

D. Eine strahlende Neuinterpretation der historischen Architektur, die das Symbol Brüssels ist, errichtet für die Weltausstellung 1958. Eine vielseitig einsetzbare Lampe, die dank ihrer auffälligen Volumen frei am Tisch oder auch am Boden aufgestellt werden

kann und Licht in mehrere Richtungen diffus abgibt.

ES. Reinterpretación luminosa de la histórica arquitectura símbolo de Bruselas, realizada con motivo de la Exposición Universal del 1958. Lámpara versátil y para un uso híbrido, al tener grandes dimensiones puede colocarse perfectamente sobre la mesa o incluso de pie, emanando una luz multidireccional y tenue.



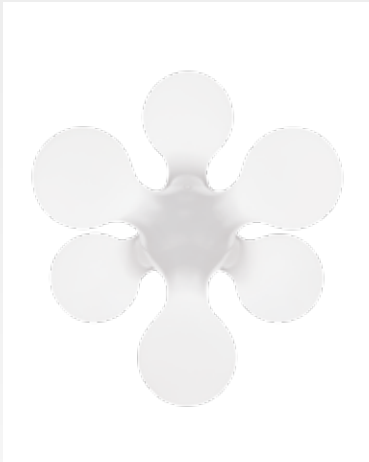

CODE	COLOUR	PRICE VAT excl.
011890BIEU / GB	white	630 €

LIGHT SOURCE*
6x40W max - E14 (E12)

FEEDING
220-240 / 120 V

DIMMER
no

LIGHT DIRECTION



CERTIFICATIONS
IP20 CE ENEC

MATERIALS
polyethylene

PACKAGING
BOX 1
gross w. 7.92 kg / 17.42 lbs
vol. 0.199 m³ / 7.042 ft³
dim. L 65 x W 59 x H 52 cm
L 25.6 x W 23.2 x H 20.5 in



white

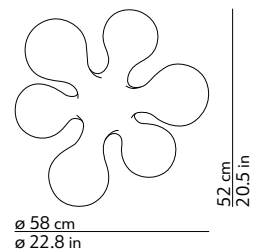

HIVE

INI ARCHIBONG

EN. The purity of Art Déco in the shapes. The allure of ancient Japanese ceramics in the pattern which envelops the body of the lamp. The freedom to merge styles and influences to create a one-of-a-kind object and the third firing technique to produce fine decoration in pure gold. A light, delicate design produced using multiple firings of the ceramic.

IT. Purezza Art Déco nelle forme. Il fascino delle antiche ceramiche giapponesi nel pattern che avvolge il corpo della lampada. La libertà di mesco-

lare stili e suggestioni per creare un oggetto unico e la tecnica del terzo fuoco per realizzare il prezioso decoro in oro zecchino. Un disegno leggero e delicato, eseguito grazie a cotture multiple della ceramica.

FR. Pureté Art Déco dans les formes. Le charme des antiques céramiques japonaises du modèle qui enveloppe le corps de la lampe. La liberté de mélanger des styles et des suggestions pour créer un objet unique et la technique du troisième feu pour réaliser la précieuse décoration en or pur.

Un dessin léger et délicat, exécuté grâce à de multiples cuissons de la céramique.

D. Die Reinheit des Art déco in den Formen. Der Zauber der alten Fliesen aus Japan im Muster, das den Korpus der Lampe umhüllt. Die Freiheit, Stile und Eindrücke zu vermischen, um einen einzigartigen Gegenstand entstehen zu lassen und die drei Brennvorgänge zu nutzen, um das hochwertige Dekor aus Dukatengold anzubringen. Ein leichtes und zartes Muster, das durch das mehrfache Brennen der Keramik entsteht.

ES. Pureza Art Déco en sus formas. Las atractivas antiguas cerámicas japonesas en la estructura que envuelve el cuerpo de la lámpara. La libertad de mezclar estilos y sugerencias para crear un objeto único y el uso de la técnica del tercer fuego para realizar la preciosa decoración en oro puro. Un diseño ligero y delicado realizado gracias a las múltiples cocciones de la cerámica.





CODE	COLOUR	PRICE VAT excl.
K390325B / GB	white	550 €
K390325N / GB	black	
K390325R / GB	red	

LIGHT SOURCE*

1x30W max - E27 (E26)

FEEDING

220-240 / 120 V

DIMMER

no

LIGHT DIRECTION



CERTIFICATIONS

IP20 CE ENEC

MATERIALS

glass + ceramic

PACKAGING

BOX 1

gross w. 2.2 kg / 4.84 lbs

vol. 0.033 m³ / 1.157 ft³

dim. L 32 x W 32 x H 32 cm

L 12.6 x W 12.6 x H 12.6 in

BOX 2

gross w. 2.72 kg / 5.98 lbs

vol. 0.033 m³ / 1.157 ft³

dim. L 32 x W 32 x H 32 cm

L 12.6 x W 12.6 x H 12.6 in

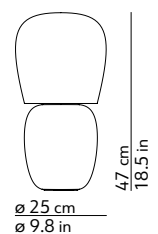

1. KUSHI MOBILE 2. KUSHI TABLE

ALBERTO SAGGIA & VALERIO SOMMELLA

EN. The round shape of the soft-feel glass diffuser. The strength of the metal rod which runs through it. A new balance for a statement lamp. Even in the portable version, to take with you wherever you go, from the living room to the terrace, study or bedroom.

IT. La rotondità del diffusore in vetro delicato al tatto. Il rigore dell'asta in metallo che lo attraversa. Una nuova

armonia per una lampada di carattere. Anche nell'originale versione mobile, da portare sempre con sé, dal living, alla terrazza, dallo studio, alla zona notte.

FR. Le caractère rond du diffuseur en verre délicat au toucher. La rigueur de la tige en métal qui le traverse. Une nouvelle harmonie pour une lampe de caractère. Également dans la version

mobile originale, à emporter partout avec soi, du salon à la terrasse, du bureau à la chambre.

D. Die Rundlichkeit des Lampenschirms aus Metall fühlt sich sanft an. Die Starre der Stange aus Metall, die den Lampenschirm durchquert. Eine neue Harmonie für eine stilvolle Lampe. Auch in der originellen mobilen Version, die Sie überallhin mitnehmen können - vom

Wohnzimmer auf die Terrasse, vom Studio ins Schlafzimmer.

ES. La redondez del difusor de cristal delicado al tacto. La rigidez de la varilla de metal que lo atraviesa. Una nueva armonía para una lámpara con carácter. También en la versión original mobile, para llevar siempre consigo, del comedor a la terraza, del estudio a la zona noche.





CODE	COLOUR	PRICE VAT excl.
K2291059N	black	295 €
K2291059O	brass	
K2291059R	copper	

LIGHT SOURCE*

board LED 1x1.3W
 2700 K - 150 lm - CRI>80

FEEDING**

rechargeable battery
 5 V min 500 mA

DIMMER

no

LIGHT DIRECTION



CERTIFICATIONS

◆ IP20 CE ENEC

MATERIALS

glass + metal

BATTERY LIFE

5h 30min

PACKAGING

BOX 1

gross w. 1.08 kg / 2.38 lbs
 vol. 0.011 m³ / 0.380 ft³
 dim. L 23.5 x W 23.5 x H 19.5 cm
 L 9.3 x W 9.3 x H 7.7 in

BOX 2

gross w. 0.42 kg / 0.92 lbs
 vol. 0.005 m³ / 0.159 ft³
 dim. L 14 x W 14 x H 23 cm
 L 5.5 x W 5.5 x H 9.1 in



black RAL9005



brass 205



copper 212

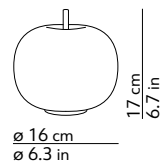

* included

** micro USB charger cable included (100 cm - 39.4 in)

KUSHI 16 TABLE



CODE	COLOUR	PRICE VAT excl.
K227105N / GB	black	260 €
K227105O / GB	brass	
K227105R / GB	copper	

LIGHT SOURCE*
 1x25W max - G9

FEEDING
 220-240 / 120 V

DIMMER
 no

LIGHT DIRECTION



CERTIFICATIONS
 IP20 CE ENEC

MATERIALS
 glass + metal

PACKAGING

BOX 1
 gross w. 1.08 kg / 2.38 lbs
 vol. 0.011 m³ / 0.380 ft³
 dim. L 23.5 x W 23.5 x H 19.5 cm
 L 9.3 x W 9.3 x H 7.7 in

BOX 2
 gross w. 0.36 kg / 0.79 lbs
 vol. 0.005 m³ / 0.159 ft³
 dim. L 14 x W 14 x H 23 cm
 L 5.5 x W 5.5 x H 9.1 in



black RAL9005



brass 205



copper 212

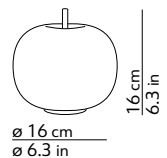

KUSHI 33 TABLE



CODE	COLOUR	PRICE VAT excl.
K222105N / GB	black	465 €
K222105O / GB	brass	
K222105R / GB	copper	

LIGHT SOURCE*

1x30W max - E27 (E26)

FEEDING

220-240 / 120 V

DIMMER

yes

LIGHT DIRECTION



CERTIFICATIONS

IP20 CE ENEC

MATERIALS

glass + metal

PACKAGING

BOX 1

gross w. 3.34 kg / 7.35 lbs
 vol. 0.053 m³ / 1.865 ft³
 dim. L 40 x W 40 x H 33 cm
 L 15.8 x W 15.8 x H 13 in

BOX 2

gross w. 0.84 kg / 1.85 lbs
 vol. 0.012 m³ / 0.411 ft³
 dim. L 18.5 x W 18.5 x H 34 cm
 L 7.3 x W 7.3 x H 13.4 in



black RAL9005



brass 205



copper 212

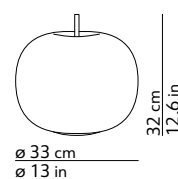

KUSHI XL TABLE

ALBERTO SAGGIA & VALERIO SOMMELLA

EN. A perfectly balanced contrast in shapes and materials. The clear-cut, understated metal rod pierces the soft glass diffuser. Kushi, in the XL version, amplifies the sensation of balance and purity.

IT. Un contrasto di forme e materiali perfettamente calibrato. L'asta in

metallo, netta e asciutta, attraversa il morbido diffusore in vetro. Kushi nella versione XL amplifica le sensazioni di equilibrio e purezza.

FR. Un contraste de formes et de matériaux parfaitement équilibré. La tige métallique, nette et sèche, traverse le diffuseur en verre. La ver-

sion Kushi XL amplifie les sensations d'équilibre et de pureté.

D. Ein perfekt ausgewogener Kontrast aus Formen und Materialien. Die Stange aus Metall, klar und einfach, durchquert den zarten Lampenschirm aus Glas. Kushi verstärkt in der Version XL die Gefühle Gleichge-

wicht und Reinheit.

ES. Un contraste de formas y materiales perfectamente calibrado. La barra de metal, neta y ágil, atraviesa el suave difusor de cristal. Kushi en la versión XL amplifica las sensaciones de equilibrio y pureza.



KUSHI XL TABLE



CODE	COLOUR	PRICE VAT excl.
K223105N / GB	black	620 €
K223105O / GB	brass	
K223105R / GB	copper	

LIGHT SOURCE*

1x70W max - E27 (E26)

FEEDING

220-240 / 120 V

DIMMER

yes

LIGHT DIRECTION



CERTIFICATIONS

IP20 CE ENEC

MATERIALS

glass + metal

PACKAGING

BOX 1

gross w. 3.34 kg / 7.35 lbs
 vol. 0.053 m³ / 1.865 ft³
 dim. L 40 x W 40 x H 33 cm
 L 15.8 x W 15.8 x H 13 in

BOX 2

gross w. 3.93 kg / 8.65 lbs
 vol. 0.036 m³ / 1.286 ft³
 dim. L 25.5 x W 25.5 x H 56 cm
 L 10 x W 10 x H 22.1 in



black RAL9005

brass 205

copper 304

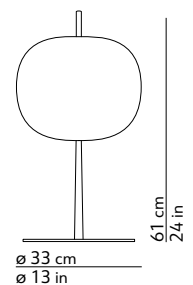

LANNÀ TABLE

NOÉ DUCHAUFOUR LAWRENCE

EN. A beguiling, lightweight design for a table lamp that is reminiscent of the fascinating tradition of the Lanna. This ancient Thai population used to release hundreds of lanterns into the night sky during festivals. And it is as if one of these had floated down into the most sophisticated and contemporary interiors, recreating the magic with its warm, welcoming light.

IT. Design seducente e leggero per una lampada che riprende l'affascinante tradizione dei Lanna. Questo antico popolo thailandese, nelle notti

di festa, lascia librare fra le stelle centinaia di lanterne. Ed è come se una di queste si posasse negli interni più raffinati e contemporanei, creando una nuova magia con la sua luce calda e avvolgente.

FR. Design séduisant et léger pour une lampe qui reprend la tradition fascinante des Lanna. Pendant les nuits de fête, cet antique peuple thaïlandais libère parmi les étoiles des centaines de lanternes. Et c'est comme si l'une d'entre elles se posait dans les intérieurs les plus raffinés et

contemporains, en créant une nouvelle magie avec sa lumière chaude et enveloppante.

D. Ein verführerisches und leichtes Design für eine Lampe, die die faszinierende Tradition der aufgreift. Dieses alte thailändische Volk lässt an Festnächten Hunderte Laternen in den Sternenhimmel steigen. Und es ist, als ob eine dieser Laternen in den raffiniertesten und modernsten Innenräumen landen würde und mit ihrem warmen und umhüllenden Licht neue Magie entstehen lässt.

ES. Diseño cautivador y ligero para una lámpara que reproduce la fascinante tradición de los Lanna. Durante las noches de fiesta, esta antigua civilización tailandesa, lanza centenares de lamparas al aire para que vuelen por el cielo estrellado. Y como resultado de esto, es como si una de estas se posara en los interiores más refinados y contemporáneos creando una nueva magia con su luz cálida y envolvente.





CODE

COLOUR

PRICE VAT excl.

K385320N / GB
K385320 / GB

black
brass

490 €

LIGHT SOURCE*

1x20W max - E27 (E26)
Ø 6cm max

FEEDING

220-240 / 120 V

DIMMER

no

LIGHT DIRECTION



CERTIFICATIONS

☐ IP20 CE ENEC

MATERIALS

glass + metal

PACKAGING

BOX 1

gross w. 2.02 kg / 4.44 lbs
vol. 0.022 m³ / 0.788 ft³
dim. L 26 x W 26 x H 33 cm
L 10.2 x W 10.2 x H 13 in

BOX 2

gross w. 1.96 kg / 4.31 lbs
vol. 0.026 m³ / 0.927 ft³
dim. L 44.5 x W 29.5 x H 20 cm
L 17.5 x W 11.6 x H 7.9 in



black RAL9005



brass 209

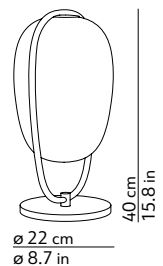

POISE

ROBERT DABI

EN. A circle of light and a metal rod. Slender, lightweight and adjustable up to 320 degrees, they can be moved as one to create ever-changing configurations. The solid T-shaped base acts as a counterweight. The rod is placed at a tangent to the circle, in acrobatic or static poses. An invitation for two-way interaction with the light.

IT. Un cerchio di luce e un'asta in metallo. Sottili, leggeri e mobili fino a 320 gradi, danzano fra loro in configurazioni sempre diverse. A fare da

contrappeso la solida base a T. L'asta è tangente al cerchio, in pose acrobatiche oppure statiche. Un invito a interagire con la luce in una relazione empatica.

FR. Un cercle de lumière et une tige de métal. Fins, légers et mobiles jusqu'à 320 degrés, ils dansent l'un avec l'autre pour créer des chorégraphies toujours nouvelles. Une base solide en forme de T fait office de contrepoids. La tige est tangente au cercle et donne vie à des poses acrobatiques ou statiques. Une

invitation à interagir avec la lumière dans une relation empathique.

D. Ein Kreis aus Licht und eine Stange aus Metall. Fein, leicht und um bis zu 320 Grad drehbar, tanzen sie in stets neuen Konfigurationen miteinander. Das Gegengewicht dazu bildet die solide Basis in T-Form. Der Bügel ist eine Tangente zum Kreis und nimmt akrobatische oder statische Positionen ein. Eine Einladung, um mit dem Licht in einem empathischen Verhältnis zu interagieren.

ES. Un aro de luz y una barra de metal. Sutiles, ligeros y móviles hasta 320 grados, danzan uno con otro en configuraciones siempre diferentes. Como contrapeso la sólida base en T. La barra es tangente al aro, en posiciones acrobáticas o bien estáticas. Una invitación a interactuar con la luz en una relación empática.





CODE	COLOUR	PRICE VAT excl.
505424N / GB	black	360 €

LIGHT SOURCE*

strip LED 1x17.5W
2700 K - 1050 lm - CRI>90

FEEDING

220-240 / 120 V

DIMMER

yes

LIGHT DIRECTION



CERTIFICATIONS

☐ IP20 CE

MATERIALS

metal

PACKAGING

BOX 1

gross w. 3.86 kg / 8.49 lbs
vol. 0.060 m³ / 2.105 ft³
dim. L 69 x W 54 x H 16 cm
L 27.2 x W 21.3 x H 6.3 in



black RAL9005

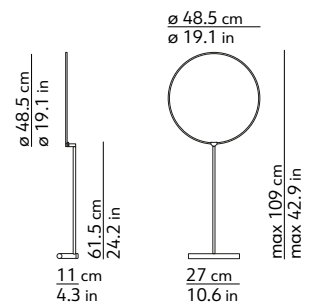

TATU

MRSMITH STUDIO

EN. Tatu, which means "three" in Swahili, consists of slimline triangular shapes. The lightweight, slimline structure frames the satin-finish glass light allowing it to shine through. Elegant contrasts between solid and hollow elements for a contemporary take on the classic table lamp, resulting in a unique, signature look.

IT. Tatu, "tre" in lingua swahili, combina fra loro sottili forme triangolari. La struttura leggera e sottile

custodisce il corpo luminoso in vetro satinato lasciandolo trasparire. Eleganti contrasti tra vuoto e pieno per una lettura contemporanea della classica abatjour, che diventa segno caratterizzante e unico.

FR. Tatu, "trois" en langue swahili, associe entre elles des formes triangulaires très fines. La structure légère et fine protège le corps lumineux en verre satiné en le laissant transparître. Contrastes élégants entre vide et

plein pour une lecture contemporaine de l'abat-jour classique qui devient un signe caractérisant et unique.

D. Tatu, "drei" in der Sprache Swahili, vereint feine Dreiecksformen miteinander. Die leichte und dünne Struktur beherbergt den Leuchtkörper aus satiniertem Glas und lässt ihn durchscheinen. Elegante Kontraste aus Fülle und Leere für eine moderne Version des klassischen Lampenschirms, der zu einem markanten und ein-

zigartigen Kennzeichen wird.

ES. Tatu, significa "tres" en lengua Swahili, combina entre ellas finas formas triangulares. La ligera y fina estructura guarda el cuerpo luminoso de cristal satinado dejándolo transparentarse. Contrastes elegantes entre vacío y lleno para dar una lectura contemporánea de la clásica lámpara de mesa, convirtiéndose en un signo definido y único.





CODE	COLOUR	PRICE VAT excl.
K360375N / GB	black	760 €
K360375O / GB	brass	

LIGHT SOURCE*
1x100W max - E27 (E26)

FEEDING
220-240 / 120 V

DIMMER
yes

LIGHT DIRECTION



CERTIFICATIONS
□ IP20 CE ENEC

MATERIALS
glass + metal

PACKAGING
BOX 1
gross w. 2.5 kg / 5.5 lbs
vol. 0.064 m³ / 2.260 ft³
dim. L 40 x W 40 x H 40 cm
L 15.8 x W 15.8 x H 15.8 in

BOX 2
gross w. 4 kg / 8.8 lbs
vol. 0.128 m³ / 4.520 ft³
dim. L 35 x W 35 x H 73 cm
L 13.8 x W 13.8 x H 31.5 in



black RAL9005



brass 219

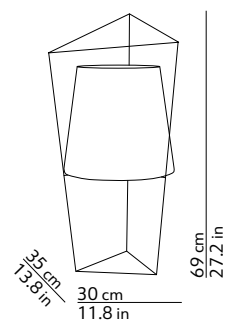

TOOT TABLE

KARIM RASHID

EN. A sculptural lamp inspired by the design of the Sixties. An object that conveys a sense of harmony and movement. The coloured or satin-finish plexiglass tubes give life to a fascinating vertical dance. The different elements are joined together by an unusual magnet system.

IT. Una lampada scultura che si ispira nel design agli anni '60. Un oggetto che trasmette armonia e movimento.

I tubi di plexiglass, colorati o satinati, mettono in scena una suggestiva danza verticale. Insolito il sistema di fissaggio dei diversi elementi tramite magneti.

FR. Une lampe sculpture qui s'inspire du design des années 60. Un objet qui transmet harmonie et mouvement. Les tubes de plexiglas, colorés ou satinés, mettent en scène une danse verticale suggestive. Le système de

fixation des différents éléments à l'aide d'aimants est très insolite.

D. Eine skulpturale Lampe, inspiriert vom Design der 60er-Jahre. Ein Gegenstand, der Harmonie und Bewegung vermittelt. Die Rohre aus Plexiglas, bunt oder satiniert, zeigen einen zauberhaften vertikalen Tanz. Das Befestigungssystem in Form von Magneten zwischen den verschiedenen Elementen ist etwas außergewöhnlich.

ES. Una lampada escultura inspirada en el diseño de los Años 60. Un objeto que transmite armonía y movimiento. Los tubos de polimetilmetacrilato, de colores o satinados, representan una sugestiva danza vertical. Es insólito el sistema de fijación de los diferentes elementos a través de imanes.



TOOT TABLE



CODE	COLOUR	PRICE VAT excl.
K400335 / GB	mixed colours	1430 €

LIGHT SOURCE*

board LED 3x5W
2700 K - 1500 lm - CRI>90

FEEDING

100-240 V

DIMMER

yes

LIGHT DIRECTION**CERTIFICATIONS**

☐ IP20 CE ENEC

MATERIALS

plexiglas + metal

PACKAGING**BOX 1**

gross w. 3.2 kg / 7.04 lbs
vol. 0.033 m³ / 1.171 ft³
dim. L 27 x W 27 x H 45.5 cm
L 10.7 x W 10.7 x H 17.9 in

BOX 2

gross w. 3.82 kg / 8.40 lbs
vol. 0.033 m³ / 1.171 ft³
dim. L 27 x W 27 x H 45.5 cm
L 10.7 x W 10.7 x H 17.9 in



mixed colours

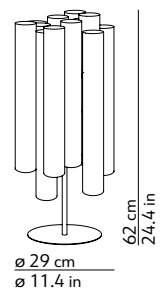

TRIPOD TABLE

CHRISTOPHE PILLET

EN. A graphic and minimal interpretation of the traditional lampshade. The design reduces the compositional elements to the minimum and reinvents a classic object, giving it a new modernity.

IT. Una lettura grafica e minimale del tradizionale paralume. La progetta-

zione riduce all'essenziale gli elementi compositivi e reinventa un oggetto classico, dandogli una nuova modernità.

FR. Une interprétation graphique et minimaliste de l'abat-jour traditionnel. Le design réduit les éléments de composition à l'essentiel et réinvente

un objet classique en lui donnant une nouvelle modernité.

D. Eine grafische und minimalistische Interpretation des traditionellen Lampenschirms. Das Design reduziert die kompositorischen Elemente auf das Wesentliche und erfindet ein klassi-

sches Objekt neu, indem es ihm eine neue Modernität verleiht.

ES. Una lectura gráfica y minimalista de la pantalla tradicional. El diseño reduce los elementos compositivos a lo esencial y reinventa un objeto clásico, dándole una nueva modernidad.



TRIPOD TABLE



CODE

K946BIEU / GB
K946BEEU / GB
K946MOEU / GB

COLOUR

white
ecrù
moka

PRICE VAT excl.

510 €

LIGHT SOURCE*

3x40W max - E14 (E12)

FEEDING

220-240 / 120 V

DIMMER

no

LIGHT DIRECTION



CERTIFICATIONS

IP20 CE ENEC

MATERIALS

metal + fabric

PACKAGING

BOX 1

gross w. 1.38 kg / 3.04 lbs

vol. 0.032 m³ / 1.128 ft³

dim. L 39 x W 39 x H 21 cm

L 15.4 x W 15.4 x H 8.3 in

BOX 2

gross w. 1.86 kg / 4.09 lbs

vol. 0.024 m³ / 0.851 ft³

dim. L 24 x W 20.5 x H 49 cm

L 9.5 x W 8.1 x H 19.3 in



white



ecrù



moka

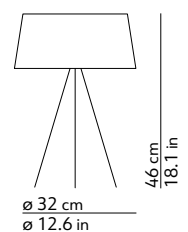

ATOMIUM SUSPENSION

HOPF&WORTMANN - BÜRO FÜR FORM

EN. A luminous object with an organic, sinuous design somewhere between science and art. A magnified version of the atom, for a suspended light that is even more eye-catching when arranged in sequence, perfect for large spaces.

IT. Tra scienza e arte, un oggetto luminoso dal design organico e sinuoso.

Versione immaginifica dell'atomo, per una lampada a sospensione che diventa ancora più suggestiva in sequenze ripetute perfette per grandi spazi.

FR. Entre science et art, un objet lumineux au design organique et sinueux. Version créatrice d'image de l'atome, pour une lampe à suspension qui

devient encore plus suggestive en séquence répétée parfaite pour les grands espaces.

D. Zwischen Wissenschaft und Kunst ein Leuchtmittel im organischen und geschwungenen Design. Eine imaginäre Version des Atoms für eine Hängelampe, die in wiederholten Sequenzen, die sich insbesondere für

große Räume eignen, noch wunderbarer wirkt.

ES. Entre arte y ciencia, un objeto luminoso con un diseño orgánico y sinuoso. Es la versión imaginativa del átomo, para una lámpara de suspensión que se vuelve aún más suggestiva en secuencias repetidas y perfectas para grandes espacios.



ATOMIUM SUSPENSION



CODE	COLOUR	PRICE VAT excl.
011892BIEU	white	630 €

LIGHT SOURCE*

6x40W max - E14 (E12)

FEEDING

220-240 / 120 V

DIMMABLE

yes

LIGHT DIRECTION



CERTIFICATIONS

⊕ IP20 CE ENEC

MATERIALS

polyethylene

CABLE LENGTH

180 cm / 70.9 in

CANOPY

white

PACKAGING

BOX 1

gross w. 8.1 kg / 17.82 lbs

vol. 0.199 m³ / 7.042 ft³

dim. L 65 x W 59 x H 52 cm

L 25.6 x W 23.2 x H 20.5 in



white

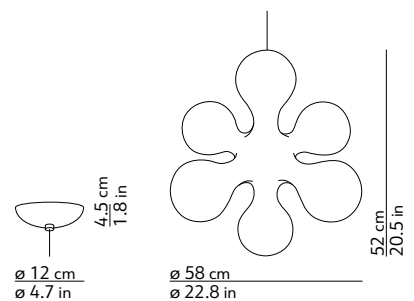

BOLHA

VALERIO SOMMELLA & ANONIMA LUCI

EN. Two different forms of glass. An ethereal, transparent bubble for the diffuser. A textured inner cylinder for the light source which resembles the filaments of traditional incandescent light bulbs. The continuously refracted light takes on a tangible appearance thanks to the interaction between the two elements.

IT. Il vetro in due diverse declinazioni. Una bolla eterea e trasparente per il

diffusore. Un cilindro materico per la sorgente luminosa, che ricorda i filamenti delle tradizionali lampadine a incandescenza. Nel dialogo fra i due elementi si generano continue rifrazioni, che restituiscono fisicità alla luce.

FR. Le verre en deux déclinaisons différentes. Une bulle éthérée et transparente pour le diffuseur. Un cylindre texturé pour la source de lumière, rappelant les filaments des ampoules à

incandescence traditionnelles. Le dialogue entre les deux éléments génère des réfractions continues qui redonnent à la lumière son aspect physique.

D. Glas in zwei verschiedenen Versionen. Eine himmlische und transparente Blase als Lampenschirm. Ein materieller Zylinder für die Lichtquelle, der an die Fäden der traditionellen Glühlampen erinnert. Im Dialog zwischen den beiden Elementen entstehen kontinu-

ierliche Lichtbrechungen, die das Licht physisch werden lassen.

ES. El cristal en dos declinaciones diferentes. Una burbuja etérea y transparente para el difusor. Un cilindro matérico para la fuente luminosa, que recuerda los filamentos de las bombillas incandescentes tradicionales. El diálogo entre los dos elementos genera continuas refracciones, que devuelven materialidad a la luz.





CODE	COLOUR	PRICE VAT excl.
K502419A	amber	1450 €
K502419F	smokey brown	

LIGHT SOURCE*

board LED 1x22W
2700 K - 2200 lm - CRI>90

FEEDING

220-240 / 120 V

DIMMABLE

phase cut

LIGHT DIRECTION



CERTIFICATIONS

⊕ IP20 CE ENEC

MATERIALS

glass + aluminium

CABLE LENGTH

180 cm / 70.9 in

CANOPY

brown

PACKAGING

BOX 1

gross w. 4.45 kg / 9.79 lbs
vol. 0.076 m³ / 2.690 ft³
dim. L 46 x W 46 x H 36 cm
L 18.1 x W 18.1 x H 14.2 in

BOX 2

gross w. 2.9 kg / 6.38 lbs
vol. 0.017 m³ / 0.616 ft³
dim. L 41.5 x W 28 x H 15 cm
L 16.3 x W 11 x H 5.9 in

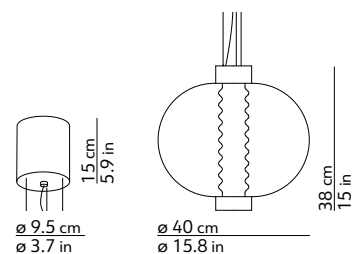

CLOVER

BRODIE NEILL

EN. The open, enveloping, intriguing three-dimensional structure is reminiscent of the natural design of a clover. Almost a sculpture, with large dimensions yet extreme lightness. The light source, inserted in the meeting point of the three large petals, creates a play of light reflections on the internal surfaces.

IT. La suggestiva struttura tridimensionale avvolgente e aperta, richiama il disegno naturale di un

trifoglio. Quasi una scultura dalle dimensioni importanti, ma dalla leggerezza estrema. La sorgente luminosa, inserita nel punto d'incontro fra i tre grandi petali, riflette la luce sulle superfici interne in un gioco di rimandi.

FR. La structure tridimensionnelle particulière, enveloppante et ouverte, rappelle la forme naturelle d'un trèfle. Presque une sculpture de dimensions importantes, mais d'une extrême lég-

èreté. La source lumineuse, insérée au point de rencontre des trois grands pétales, réfléchit la lumière sur les surfaces internes dans un jeu de renvois.

D. Die stimmungsvolle dreidimensionale Struktur, umhüllend und offen, erinnert an das natürliche Design eines Klee. Fast eine Skulptur von bedeutenden Ausmaßen, aber mit extremer Leichtigkeit. Die Lichtquelle, die an der Stelle eingesetzt wird, an der sich die drei großen Blütenblätter

treffen, reflektiert das Licht in einem Spiel von Bezügen auf die Innenflächen.

ES. La sugestiva estructura tridimensional envolvente y abierta evoca el diseño natural de un trébol. Casi una escultura de dimensiones importantes, pero de una ligereza extrema. La fuente luminosa, insertada en el punto de encuentro entre los tres grandes pétalos, refleja la luz sobre las superficies internas en un juego de retornos.





CODE	COLOUR	PRICE VAT excl.
140049LED	white	1700 €

LIGHT SOURCE*

board LED 1x20W
 2700 K - 2600 lm - CRI>80
 (110-120 V: board LED 1x15W
 2700 K - 1600 lm - CRI>80)

FEEDING

110-240 V

DIMMABLE

1-10V or push

LIGHT DIRECTION



CERTIFICATIONS

⊕ IP20 CE ENEC

MATERIALS

polyurethane + aluminium

CABLE LENGTH

180 cm / 70.9 in

CANOPY

white RAL9016

PACKAGING

BOX 1

gross w. 18.46 kg / 40.7 lbs
 vol. 0.336 m³ / 11.866 ft³
 dim. L 80 x W 80 x H 52.5 cm
 L 31.5 x W 31.5 x H 20.7 in



white RAL9016

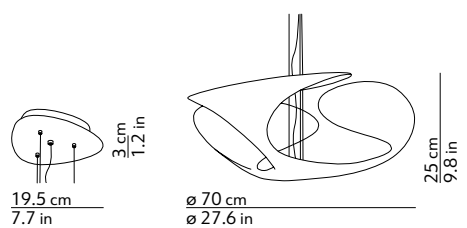

DALA

FRANCESCA SMIRAGLIA

EN. Highly decorative with an architectural look, Dala blends fluid lines with a strong design. The two outer metal casings wrap around the large diffuser, overlapping like the petals of a flower. In two different sizes, featuring a sophisticated contrast in colours, reminiscent of the natural shape of the flower's corolla which envelops the light.

IT. Decorativa e insieme architettuale, Dala associa segno fluido e progettazione rigorosa. Le due scocche metal-

liche circondano il grande diffusore, sovrapponendosi fra loro come i petali di un fiore. In due diverse dimensioni e in un raffinato contrasto di colori, riprendono il movimento naturale di una corolla che abbraccia la luce.

FR. A la fois décoratif et architectural, Dala combine des lignes fluides avec un design rigoureux. Les deux coques métalliques entourent le grand diffuseur, se chevauchant comme les pétales d'une fleur. Dans deux tailles, avec un contraste de couleurs raffinés,

elles rappellent le mouvement naturel d'une corolle qui embrasse la lumière.

D. Dekorativ und gleichzeitig architektonisch, vereint Dala ein fließendes Zeichen mit einer strengen Projektplanung. Die beiden Metallgehäuse umgeben den großen Lampenschirm und überlappen wie die Blütenblätter einer Blume. In zwei unterschiedlichen Größen und einem raffinierten Farbkontrast nehmen sie die natürliche Bewegung einer Blütenkrone auf, die das Licht umhüllt.

ES. Dala, decorativa y a la vez arquitectural, asocia una línea fluida a un diseño riguroso. Los dos cuerpos de metal rodean el difusor de gran tamaño, superponiéndose uno a otro como los pétalos de una flor. En dos tamaños diferentes y con un contraste elegante de colores, imitan el movimiento natural de una corola que abraza la luz.





CODE	COLOUR	PRICE VAT excl.
2700 K	3000 K	
K503420GL / K503420GL30	dark grey + wood finish	950 €
K503420SL / K503420SL30	sand + wood finish	
K503420GC / K503420GC30	dark grey + concrete finish	
K503420SC / K503420SC30	sand + concrete finish	
K503420GR / K503420GR30	dark grey + copper	
K503420SR / K503420SR30	sand + copper	
K503420BB / K503420BB30	white	840 €

LIGHT SOURCE*

DALA 2700 K

board LED 1x42W
2700 K - 4200 lm - CRI>90

DALA 3000 K

board LED 1x42W
3000 K - 4350 lm - CRI>90

FEEDING

220-240 / 120 V

DIMMABLE

phase cut

LIGHT DIRECTION



CERTIFICATIONS

⊕ IP20 CE ENEC

MATERIALS

metal

PACKAGING

BOX 1

gross w. 7.80 kg / 17.20 lbs
vol. 0.007 m³ / 0.247 ft³
dim. L 61 x W 61 x H 18 cm
L 24 x W 24 x H 7.1 in

BOX 2

gross w. 1.20 kg / 2.65 lbs
vol. 0.015 m³ / 0.523 ft³
dim. L 61 x W 27 x H 9 cm
L 24 x W 10.6 x H 3.5 in



white



dark grey + wood finish



dark grey + concrete finish



dark grey + copper 221



sand + wood finish



sand + concrete finish



sand + copper 221

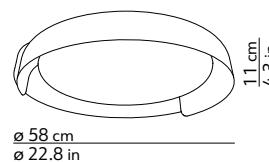

DALA LINEAR

FRANCESCA SMIRAGLIA

EN. A harmonious synthesis of form and function is traced by two linear elements of different sizes that frame the white diffuser overlapping each other like the petals of a flower. Thanks to the different combinations of finishes, Dala Linear integrates elegantly into collective and residential spaces.

IT. Un connubio armonico tra forma e funzione è tracciato da due elementi lineari di differenti dimensioni che incorniciano il diffusore bianco sovrappo-

ponendosi tra loro come petali di un fiore. Dala Linear, grazie alle diverse combinazioni di finiture, si integra elegantemente negli spazi collettivi e residenziali.

FR. Une fusion entre forme et fonction est tracée par deux éléments linéaires de différentes tailles qui encadrent le diffuseur blanc en se superposant les uns sur les autres comme les pétales d'une fleur. Grâce aux différentes combinaisons de finitions, Dala Linear

s'intègre élégamment dans les espaces collectifs et résidentiels.

D. Eine harmonische Verbindung zwischen Form und Funktion wird durch zwei lineare Elemente unterschiedlicher Größe nachgezeichnet, die den weißen Streukörper umrahmen, der sich wie die Blütenblätter einer Blume überlappt. Dank der verschiedenen Kombinationen von Oberflächen fügt sich Dala Linear elegant in Gemeinschafts- und Wohnräume ein.

ES. Una armoniosa unión de forma y función se traza mediante dos elementos lineales de diferentes dimensiones que enmarcan el difusor blanco, superponiéndose entre sí como los pétalos de una flor. Dala Linear se integra con elegancia en los espacios colectivos y residenciales gracias a las diferentes combinaciones de acabados.





CODE	COLOUR	PRICE VAT excl.
2700 K	3000 K	
K503427GL / K503427GL30	dark grey + wood finish	950 €
K503427SL / K503427SL30	sand + wood finish	
K503427GC / K503427GC30	dark grey + concrete finish	
K503427SC / K503427SC30	sand + concrete finish	
K503427GR / K503427GR30	dark grey + copper	
K503427SR / K503427SR30	sand + copper	

LIGHT SOURCE*

DALA LINEAR 2700 K

board LED 1x42W
2700 K - 5150 lm - CRI>90

DALA LINEAR 3000 K

board LED 1x42W
3000 K - 5300 lm - CRI>90

FEEDING

220-240 / 120 V

DIMMABLE

phase cut

LIGHT DIRECTION



CERTIFICATIONS

⊕ IP20 CE

MATERIALS

metal

CABLE LENGTH

180 cm / 70.9 in

CANOPY

dark grey or sand

PACKAGING

BOX 1 1.96 kg / 4.31 lbs
gross w. 0.016 m³ / 0.568 ft³
vol. L 133 x W 11 x H 11 cm
dim. L 52.4 x W 4.3 x H 4.3 in

BOX 2 3.3 kg / 7.26 lbs
gross w. 0.026 m³ / 0.916 ft³
vol. L 131 x W 11 x H 18 cm
dim. L 51.6 x W 4.3 x H 7.1 in

BOX 3 2.64 kg / 5.81 lbs
gross w. 0.021 m³ / 0.753 ft³
vol. L 148 x W 16 x H 9 cm
dim. L 58.3 x W 6.3 x H 3.5 in

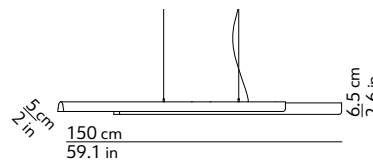
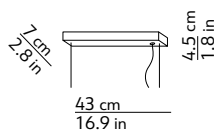
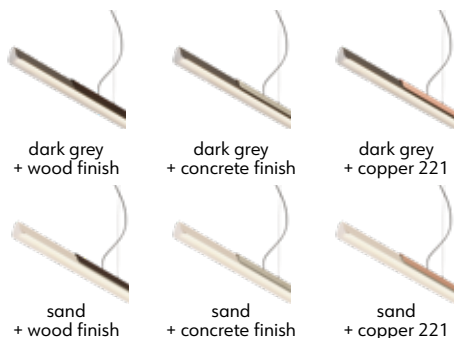

1. DEW 2. DEW CHANDELIER

EMMANUEL BABLED

EN. Glass drops suspended in space like dew, tangible and fleeting, they multiply their luminous reflections. A system that allows for total compositional freedom. From two to an infinite number of elements to create a chandelier of all shapes and sizes, from cascades to strings of light. Bringing a dreamlike dimension to any space with a custom finish to every project.

IT. Gocce di vetro sospese nello spazio come rugiada, solide e evanescenti, moltiplicano i loro riflessi luminosi. Un

sistema che dà massima libertà compositiva. Da due a infiniti elementi per creare chandelier di ogni dimensione e forma, dalle cascate alle linee di luce. E per portare la dimensione del sogno in ogni spazio, personalizzando ogni progetto.

FR. Gouttes de verre suspendues dans l'espace comme de la rosée, solides et évanescents, qui multiplient leurs reflets lumineux. Un système qui donne une plus grande liberté de composition. De deux à d'infinis éléments pour créer un chandelier de n'importe

quelle dimension et forme, des cascades aux lignes de lumière. Pour porter la dimension du rêve dans chaque espace, en personnalisant chaque projet.

D. Wie Tau im Raum hängende Glaspfropfen, solide und kaum wahrnehmbar, vervielfältigen ihre Lichtreflexe. Ein System, das maximale Freiheit bei der Zusammensetzung garantiert. Zwei bis unendlich viele Elemente lassen Chandeliers in jeder Größe und Form entstehen - von Wasserfällen bis hin zu Lichtlinien. So wird jeder Raum

mit einem Traum erfüllt und jedes Projekts personalisiert.

ES. Gotas de cristal suspendidas en el espacio como gotas de rocío, sólidas y evanescentes, multiplican sus luminosos reflejos. Un sistema que da la máxima libertad compositiva. De dos a infinitos elementos para crear candelabros de cualquier tamaño y forma: de las cascadas a las líneas de luz. Y para evocar las dimensiones del sueño en cualquier espacio, dando un carácter personal a cada proyecto.





CODE	COLOUR	PRICE VAT excl.
DEW		
0451291EU	chrome	395 €
0451291NEU 0451291OEU	black brass	425 €
DEW FALSE CEILING		
0451291C	chrome	380 €
0451291CN 0451291CO	black brass	415 €

LIGHT SOURCE*

board LED 1x5W
2700 K - 440 lm - CRI>90

FEEDING

220-240 / 120 V

DIMMABLE

phase cut

LIGHT DIRECTION**CERTIFICATIONS****DEW**

⊕ IP20 CE ENEC

DEW FALSE CEILING

⊕ IP20 CE ENEC

MATERIALS

glass + aluminium

CABLE LENGTH

250 cm / 98.4 in

CANOPY

chromed
or black
or brass

PACKAGING**BOX 1**

gross w. 2.34 kg / 5.15 lbs
vol. 0.009 m³ / 0.303 ft³
dim. L 18.5 x W 16 x H 29 cm
L 7.3 x W 6.3 x H 11.4 in



chrome



black RAL9005

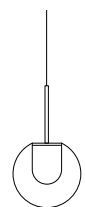
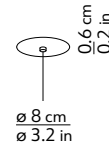
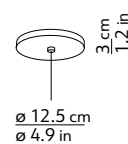

brass 205

DEW**DEW
FALSE CEILING**



CODE	COLOUR	PRICE VAT excl.
0451293EU	chrome	1150 €
0451293NEU	black	1250 €
0451293OEU	brass	

LIGHT SOURCE*

board LED 3x5W
2700 K - 1320 lm - CRI>90

FEEDING

220-240 / 120 V

DIMMABLE

phase cut

LIGHT DIRECTION**CERTIFICATIONS**

⊕ IP20 CE ENEC

MATERIALS

glass + aluminium

CABLE LENGTH

250 cm / 98.4 in

CANOPY

chromed
or black
or brass

PACKAGING**BOX 1**

gross w. 6.72 kg / 14.78 lbs
vol. 0.022 m³ / 0.788 ft³
dim. L 26 x W 26 x H 33 cm
L 10.2 x W 10.2 x H 13 in



chrome



black RAL9005



brass 205

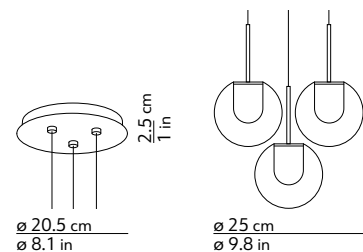

DEW 5 CHANDELIER



CODE	COLOUR	PRICE VAT excl.
K0451375EU	chrome	2300 €
K0451375NEU K0451375OEU	black brass	2500 €

LIGHT SOURCE*

board LED 5x5W
2700 K - 2200 lm - CRI>90

FEEDING

220-240 / 120 V

DIMMABLE

phase cut

SPECIAL REQUESTS

It is possible to ask for quotes for different shapes, sizes and finishing according to your needs.

LIGHT DIRECTION**CERTIFICATIONS**

⊕ IP20 CE ENEC

MATERIALS

glass + aluminium

CABLE LENGTH

450 cm / 177.2 in

NET WEIGHT

10 kg / 22 lbs

CANOPY

INTERNAL CANOPY
metal - black RAL9005

CANOPY COVER

mirrored plexiglas
or black
or brass

PACKAGING**BOX 1-5**

gross w. 2.34 kg / 5.15 lbs
vol. 0.009 m³ / 0.303 ft³
dim. L 18.5 x W 16 x H 29 cm
L 7.3 x W 6.3 x H 11.4 in

BOX 6

gross w. 2.5 kg / 5.51 lbs
vol. 0.015 m³ / 0.523 ft³
dim. L 38.5 x W 38.5 x H 10 cm
L 15.2 x W 15.2 x H 3.9 in



chrome



black RAL9005



brass 205

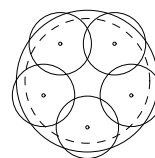

ø 25 cm
ø 9.8 in

DEW x5

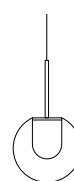

ø 11 cm
ø 4.3 in

DEW 7 CHANDELIER



CODE	COLOUR	PRICE VAT excl.
K0451377EU	chrome	3200 €
K0451377NEU	black	3400 €
K0451377OEU	brass	

LIGHT SOURCE*

board LED 7x5W
2700 K - 3080 lm - CRI>90

FEEDING

220-240 / 120 V

DIMMABLE

phase cut

SPECIAL REQUESTS

It is possible to ask for quotes for different shapes, sizes and finishing according to your needs.

LIGHT DIRECTION**CERTIFICATIONS**

⊕ IP20 CE ENEC

MATERIALS

glass + aluminium

CABLE LENGTH

450 cm / 177.2 in

NET WEIGHT

13.6 kg / 29.92 lbs

CANOPY

INTERNAL CANOPY
metal - black RAL9005

CANOPY COVER

mirrored plexiglas
or black
or brass

PACKAGING**BOX 1-7**

gross w. 2.34 kg / 5.15 lbs
vol. 0.009 m³ / 0.303 ft³
dim. L 18.5 x W 16 x H 29 cm
L 7.3 x W 6.3 x H 11.4 in

BOX 8

gross w. 2.5 kg / 5.51 lbs
vol. 0.015 m³ / 0.523 ft³
dim. L 38.5 x W 38.5 x H 10 cm
L 15.2 x W 15.2 x H 3.9 in



chrome



black RAL9005



brass 205

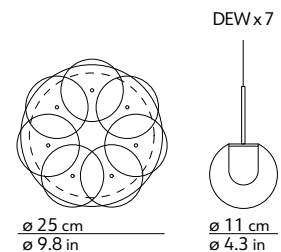

ø 25 cm
ø 9.8 in

ø 11 cm
ø 4.3 in

DEW 9 CHANDELIER



CODE	COLOUR	PRICE VAT excl.
K0451379EU	chrome	4500 €
K0451379NEU K0451379OEU	black brass	4800 €

LIGHT SOURCE*

board LED 9x5W
2700 K - 3960 lm - CRI>90

FEEDING

220-240 / 120 V

DIMMABLE

phase cut

SPECIAL REQUESTS

It is possible to ask for quotes for different shapes, sizes and finishing according to your needs.

LIGHT DIRECTION**CERTIFICATIONS**

⊕ IP20 CE ENEC

MATERIALS

glass + aluminium

CABLE LENGTH

450 cm / 177.2 in

NET WEIGHT

18 kg / 39.6 lbs

CANOPY

INTERNAL CANOPY
metal - black RAL9005

CANOPY COVER

mirrored plexiglas
or black
or brass

PACKAGING**BOX 1-9**

gross w. 2.34 kg / 5.15 lbs

vol. 0.009 m³ / 0.303 ft³

dim. L 18.5 x W 16 x H 29 cm

L 7.3 x W 6.3 x H 11.4 in

BOX 10

gross w. 4 kg / 8.82 lbs

vol. 0.035 m³ / 1.250 ft³

dim. L 59.5 x W 59.5 x H 10 cm

L 23.4 x W 23.4 x H 3.9 in



chrome



black RAL9005



brass 205

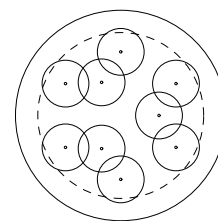

ø 49.5 cm
ø 19.5 in

DEW x9

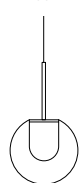

ø 11 cm
ø 4.3 in

DEW 15 CHANDELIER



CODE	COLOUR	PRICE VAT excl.
K04513715EU	chrome	6880 €
K04513715NEU	black	7560 €
K04513715OEU	brass	

LIGHT SOURCE*

board LED 15x5W
2700 K -6600 lm - CRI>90

FEEDING

220-240 / 120 V

DIMMABLE

phase cut

SPECIAL REQUESTS

It is possible to ask for quotes for different shapes, sizes and finishing according to your needs.

LIGHT DIRECTION**CERTIFICATIONS**

⊕ IP20 CE ENEC

MATERIALS

glass + aluminium

CABLE LENGTH

450 cm / 177.2 in

NET WEIGHT

28.8 kg / 63.36 lbs

CANOPY

INTERNAL CANOPY
metal - black RAL9005

CANOPY COVER

mirrored plexiglas
or black
or brass

PACKAGING**BOX 1-15**

gross w. 2.34 kg / 5.15 lbs
vol. 0.009 m³ / 0.303 ft³
dim. L 18.5 x W 16 x H 29 cm
L 7.3 x W 6.3 x H 11.4 in

BOX 16

gross w. 4 kg / 8.82 lbs
vol. 0.035 m³ / 1.250 ft³
dim. L 59.5 x W 59.5 x H 10 cm
L 23.4 x W 23.4 x H 3.9 in



chrome



black RAL9005



brass 205

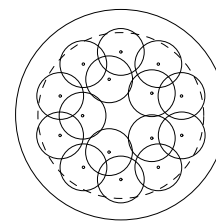

ø 49.5 cm
ø 19.5 in

DEW x 15

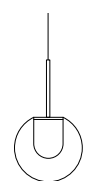

ø 11 cm
ø 4.3 in

DEW 19 CHANDELIER



CODE	COLOUR	PRICE VAT excl.
K04513719EU	chrome	8450 €
K04513719NEU K04513719OEU	black brass	9300 €

LIGHT SOURCE*

board LED 19x5W
2700 K - 8360 lm - CRI>90

FEEDING

220-240 / 120 V

DIMMABLE

phase cut

SPECIAL REQUESTS

It is possible to ask for quotes for different shapes, sizes and finishing according to your needs.

LIGHT DIRECTION**CERTIFICATIONS**

⊕ IP20 CE ENEC

MATERIALS

glass + aluminium

CABLE LENGTH

450 cm / 177.2 in

NET WEIGHT

36 kg / 79.2 lbs

CANOPY

INTERNAL CANOPY
metal - black RAL9005

CANOPY COVER

mirrored plexiglas
or black
or brass

PACKAGING**BOX 1-19**

gross w. 2.34 kg / 5.15 lbs
vol. 0.009 m³ / 0.303 ft³
dim. L 18.5 x W 16 x H 29 cm
L 7.3 x W 6.3 x H 11.4 in

BOX 20

gross w. 4 kg / 8.82 lbs
vol. 0.035 m³ / 1.250 ft³
dim. L 59.5 x W 59.5 x H 10 cm
L 23.4 x W 23.4 x H 3.9 in



chrome



black RAL9005



brass 205

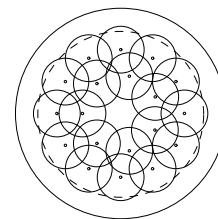

ø 49.5 cm
ø 19.5 in

DEW x 19

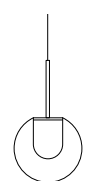

ø 11 cm
ø 4.3 in

E.T.A. SAT

GUGLIELMO BERCHICCI

EN. The material is transformed and turned into a light. Physical presence and abstract concept for a light with an original aesthetic look. Fluid, irregular shapes create an innovative, eye-catching equilibrium. A highly decorative object, ideal for communal spaces and show-stopping contract settings.

IT. La materia si trasforma e diventa corpo luminoso. Fisicità e astrazione in una lampada dall'originale forza

estetica. Forme fluide e irregolari creano un nuovo, suggestivo equilibrio. Un oggetto dalla spiccata valenza decorativa, ideale per gli spazi collettivi e per le scenografie contract.

FR. La matière se transforme et devient un corps lumineux. Matérialité et abstraction dans une lampe à la force esthétique originale. Formes fluides et irrégulières qui créent un nouvel équilibre suggestif. Un objet à la valeur décoratrice marqué, parfait

pour les espaces collectifs et pour les scènes contract.

D. Die Materie verwandelt sich und wird zum Leuchtkörper. Physikalität und Abstraktion in einer Lampe mit origineller ästhetischer Wirkung. Fließende und unregelmäßige Formen lassen ein neues, wunderbares Gleichgewicht entstehen. Ein Gegenstand mit besonderer dekorativer Funktion, ideal für Gemeinschaftsräume und Contract-Bereiche.

ES. La materia se transforma y se convierte en un cuerpo luminoso. Apariencia y abstracción en una lámpara con una original fuerza estética. Las formas fluidas e irregulares crean un equilibrio nuevo y suggestivo. Un objeto con un valor decorativo en relieve, ideal para los espacios comunes y para las escenografías de espacios comerciales.





CODE	COLOUR	PRICE VAT excl.
017106BIEU	white	1100 €
017106AREU	orange	

LIGHT SOURCE*

1x40W max - E14 (E12) +
1x100W max - E27 (E26)

FEEDING

220-240 / 120 V

DIMMABLE

yes

LIGHT DIRECTION



CERTIFICATIONS

⊕ IP20 CE ENEC

MATERIALS

fiberglass + polycarbonate + metal

CABLE LENGTH

180 cm / 70.9 in

CANOPY

white

PACKAGING

BOX 1

gross w. 7.9 kg / 17.38 lbs

vol. 0.316 m³ / 11.149 ft³

dim. L 67 x W 76 x H 62 cm

L 26.4 x W 29.9 x H 24.4 in



white



orange

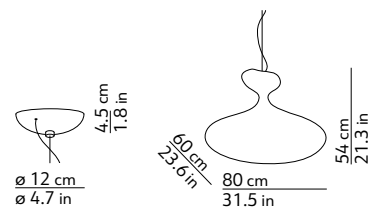

1. FLOED 2. FLOED 2

STORAGE MILANO

EN. The surprising shapes of gorgonian coral inspire a structure of great visual and material impact. Between nature, art and architecture, a lamp installation with a strong and magnetic presence. The size of the blunt cylinder in opaline glass and the aluminium bar that make up Floed are impressive. For wall or ceiling surface-mounted installation.

IT. Le sorprendenti forme del corallo gorgonia ispirano una struttura di grande impatto visivo e materico.

FR. Fra natura, arte e architettura, una lampada installazione dalla presenza forte e magnetica. Importanti sono le dimensioni del cilindro smussato in vetro opalino e della barra in alluminio che compongono Floed. Da installare a parete o a plafone.

FR. Les formes surprenantes du corail gorgone inspirent une structure d'un grand effet visuel et matériel. Entre nature, art et architecture, une lampe-installation d'une présence forte et magnétique. Les dimensions du

cylindre chanfreiné en verre opalin et de la barre en aluminium qui composent Floed sont importantes. À installer au mur ou au plafond.

D. Die erstaunlichen Formen der gorgonischen Koralle inspirieren zu einer Struktur von großer visueller und plastischer Wirkung. Zwischen Natur, Kunst und Architektur, eine Lampe-installation mit starker und magnetischer Präsenz. Beachtlich sind die Abmessungen des abgeschrägten Zylinders aus Milchglas und der Alumi-

niumstange, aus der Floed besteht. Für Wand- oder Deckenmontage.

ES. Las sorprendentes formas del coral gorgonia inspiran una estructura de gran impacto visual y de materiales. Entre naturaleza, arte y arquitectura, una lámpara instalación de presencia fuerte y magnética. Son importantes las dimensiones del cilindro biselado de vidrio opalino y de la barra de aluminio que componen Floed. Para instalar en la pared o en el techo.





CODE	COLOUR	PRICE VAT excl.
K375416BR	bronze	845 €

LIGHT SOURCE*

1x70W max - E27 (E26)
L 10.5cm max

FEEDING

220-240 / 120 V

DIMMABLE

yes

LIGHT DIRECTION**CERTIFICATIONS**

⊕ IP20 CE ENEC

MATERIALS

glass + aluminium

PACKAGING**BOX 1**

gross w. 2.5 kg / 5.5 lbs
vol. 0.018 m³ / 0.644 ft³
dim. L 32 x W 32 x H 25 cm
L 12.6 x W 12.6 x H 9.8 in

BOX 2

gross w. 2.85 kg / 6.27 lbs
vol. 0.050 m³ / 1.777 ft³
dim. L 89 x W 29 x H 19.5 cm
L 35 x W 11.4 x H 7.7 in



bronze

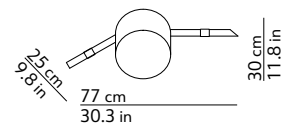



CODE	COLOUR	PRICE VAT excl.
K375417BR	bronze	1450 €

LIGHT SOURCE*

2x70W max - E27 (E26)
L 10.5cm max

FEEDING

220-240 / 120 V

DIMMABLE

yes

LIGHT DIRECTION



CERTIFICATIONS

⊕ IP20 CE ENEC

MATERIALS

glass + aluminium

PACKAGING

BOX 1 / BOX 2

gross w. 2.5 kg / 5.5 lbs
vol. 0.018 m³ / 0.644 ft³
dim. L 32 x W 32 x H 25 cm
L 12.6 x W 12.6 x H 9.8 in

BOX 3

gross w. 5.1 kg / 11.22 lbs
vol. 0.107 m³ / 3.781 ft³
dim. L 161.5 x W 34 x H 19.5 cm
L 63.4 x W 13.4 x H 7.7 in

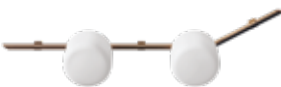

bronze

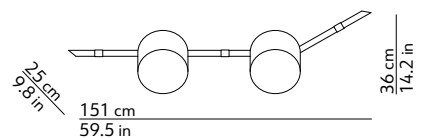



FLOOB SUSPENSION

KARIM RASHID

EN. The transparency of plexiglass joins the floral inspiration. An upside-down corolla with a fluid and harmonious volume. Many lamps together lend themselves to creating balanced compositions, giving a joyful note to the interior.

IT. La trasparenza del plexiglass si unisce all'ispirazione floreale. Una corolla

la rovesciata dalla volumetria fluida e armoniosa. Più lampade si prestano a creare composizioni equilibrate, dando una nota gioiosa agli interni.

FR. La transparence du plexiglas s'unit à l'inspiration florale. Une corolle inversée aux volumes fluides et harmonieux. Un nombre multiple de lampes crée des compositions équilibrées, donnant une

note joyeuse aux intérieurs.

D. Die Transparenz von Plexiglas kombiniert mit floraler Inspiration. Eine auf den Kopf gestellte Blumenkrone mit einem fließenden und harmonischen Volumen. Mehrere Lampen eignen sich zur Schaffung ausgewogener Kompositionen, die den Innenräumen eine fröhliche Note verleihen.

ES. La transparencia del plexiglás se une a la inspiración floral. Una corolla invertida con un volumen fluido y armonioso. Más lámparas se prestan a crear composiciones equilibradas, dando una alegre nota a los interiores.



FLOOB SUSPENSION



CODE	COLOUR	PRICE VAT excl.
0181634TREU	transparent	590 €

LIGHT SOURCE*
1x100W max - E27 (E26)

FEEDING
220-240 / 120 V

DIMMABLE
yes

LIGHT DIRECTION



CERTIFICATIONS
⊕ IP20 CE ENEC

MATERIALS
plexiglas + aluminium

CABLE LENGTH
180 cm / 70.9 in

CANOPY
white

PACKAGING

BOX 1

gross w. 4.36 kg / 9.59 lbs

vol. 0.146 m³ / 5.171 ft³

dim. L 46.5 x W 47 x H 67 cm

L 18.3 x W 18.5 x H 26.4 in



transparent

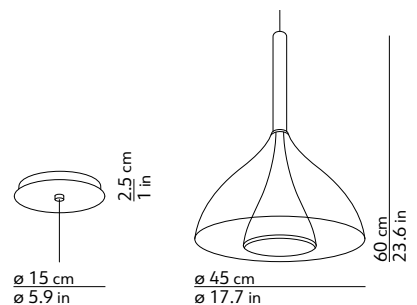

1. FLOW 2. FLOW CEILING

CHRIS BASIAS

EN. "Floating Leaves Out of the Window". The metallic disc of the lamp imitates the shape of the leaves of a tree, blown by the wind. With or without light, the elements can be combined to make touching installations. Playing with shadows and lights, Flow reproduces the dance of nature on a windy day.

IT. "Floating Leaves Out of the Window". Foglie danzanti fuori dalla finestra. Come le foglie di un albero portate dal vento, il disco metallico

della lampada ne imita la forma. Con o senza luce, gli elementi compositivi possono essere combinati per creare installazioni suggestive. Giocando con ombre e luci, Flow riproduce la danza della natura in una giornata ventosa.

FR. "Floating Leaves Out of the Window". Feuilles dansantes à travers la fenêtre. Comme les feuilles d'un arbre portées par le vent, le disque métallique de la lampe en imite la forme. Avec ou sans lumière, les éléments de composition peuvent être combinés pour

créer des installations suggestives. En jouant avec les ombres et les lumières, Flow reproduit la danse de la nature pendant une journée venteuse.

D. "Floating Leaves Out of the Window". Tanzende Blätter vor dem Fenster. Wie die vom Wind verwehten Blätter eines Baumes imitiert die Metallscheibe der Leuchte dessen Form. Mit oder ohne Licht lassen sich die kompositorischen Elemente zu suggestiven Installationen kombinieren. Durch das Spiel mit Licht und Schatten

imitiert Flow den Tanz der Natur an einem windigen Tag.

ES. "Floating Leaves Out of the Window". Hojas danzando fuera de la ventana. Como las hojas de un árbol llevadas por el viento, el disco metálico de la lámpara imita su forma. Con o sin luz, los elementos compositivos pueden combinarse para crear instalaciones impresionantes. Jugando con sombras y luces, Flow reproduce la danza de la naturaleza en un día de viento.





CODE	COLOUR	PRICE VAT excl.
506428N	black	250 €
ACCESSORIES		
500500N	black canopy	68 €
500501N	black false ceiling canopy	42 €
500517N**	black multiple canopy	230 €
LEAF		
506430N	black	140 €

** max 8 lamps. Decentralizers included

LIGHT SOURCE*

1x25W max - G9

FEEDING

220-240 / 120 V

DIMMABLE

yes

LIGHT DIRECTION**CERTIFICATIONS**

⊕ IP20 CE

MATERIALS

glass + metal

CABLE LENGTH

180 cm / 70.9 in

CANOPY

black RAL9005

PACKAGING**BOX 1**

gross w. 1.8 kg / 3.96 lbs

vol. 0.029 m³ / 1.007 ft³

dim. L 39 x W 43 x H 17 cm

L 15.4 x W 16.9 x H 6.7 in

LEAF**BOX 1**

gross w. 1.12 kg / 2.46 lbs

vol. 0.014 m³ / 0.484 ft³

dim. L 43 x W 37.5 x H 8.5 cm

L 16.9 x W 14.8 x H 3.4 in



black RAL9005

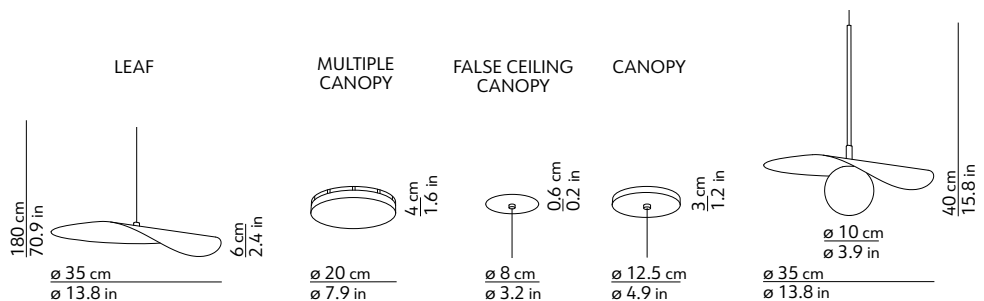

SUSPENSION

* not included



CODE	COLOUR	PRICE VAT excl.
506429N	black	260 €
LEAF 506430N	black	140 €

LIGHT SOURCE*

1x25W max - G9

FEEDING

220-240 / 120 V

DIMMABLE

yes

LIGHT DIRECTION**CERTIFICATIONS**

⊕ IP20 CE

MATERIALS

glass + metal

PACKAGING**BOX 1**

gross w. 1.8 kg / 3.96 lbs

vol. 0.029 m³ / 1.007 ft³

dim. L 39 x W 43 x H 17 cm

L 15.4 x W 16.9 x H 6.7 in

LEAF**BOX 1**

gross w. 1.12 kg / 2.46 lbs

vol. 0.014 m³ / 0.484 ft³

dim. L 43 x W 37.5 x H 8.5 cm

L 16.9 x W 14.8 x H 3.4 in

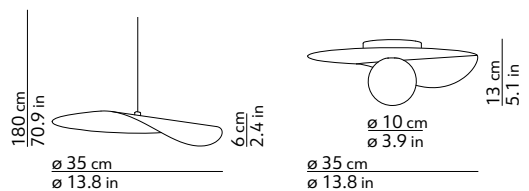

black RAL9005

LEAF



GIASS

SEBASTIAN HERKNER

EN. The glass of tumblers and ice, "giass" in Milanese dialect. The retro style of bars from a by-gone era. A world reinterpreted with a modern vision. Continuous reflections and iridescent light and the possibility of creating numerous combinations at will. The elements in four different sizes and two colour variations leave ample room for compositional freedom.

IT. Il vetro dei bicchieri e il ghiaccio, "giass" in dialetto milanese. Il gusto retrò dei bar di un'altra epoca. Un mondo reinterpretrato in una visione

moderna. Riflessi continui e cangianti di luce e la possibilità di creare a piacere molteplici combinazioni. Gli elementi in quattro diverse dimensioni e due varianti di colore, danno grande libertà compositiva.

FR. Le verre des verres et la glace, "giass" en dialecte milanais. Le goût rétro des bars d'une autre époque. Un monde réinterprété dans une vision moderne. Reflets continus et changeants de lumière et la possibilité de créer au plaisir des multiples combinaisons. Les éléments en quatre di-

mensions différentes et deux variantes de couleur apportent une grande liberté de composition.

D. Das Trinkglas und das Eis wird im Mailänder Dialekt "giass" genannt. Der Retro-Akzent der Bars einer weit zurückliegenden Zeit. Eine im modernen Stil neu interpretierte Welt. Kontinuierliche und schillernde Lichtreflexe und die Möglichkeit zahlreiche Kombinationen nach Belieben zusammenzustellen. Die Elemente in vier verschiedenen Größen und zwei Farbvarianten sorgen für besondere

Freiheit bei der Kombination.

ES. El cristal de los vasos y el hielo, el término "giass" viene del dialecto milanés. El gusto retro de los bares de otra época. Un mundo reinterpretrado en una visión moderna. Reflejos continuos y tornasolados de luz y la posibilidad de crear múltiples combinaciones a placer. Los elementos en cuatro dimensiones diferentes y dos variantes de color dan una gran libertad compositiva.





CODE	COLOUR	PRICE VAT excl.
K395330S	white	1380 €
K395330G	smokey grey	

LIGHT SOURCE*

board LED 1x19W
2700 K - 1700 lm - CRI>90

FEEDING

100-240 V

DIMMABLE

0-10V

LIGHT DIRECTION**CERTIFICATIONS**

⊕ IP20 CE ENEC

MATERIALS

glass + metal

PACKAGING**BOX 1**

gross w. 5.2 kg / 11.5 lbs
vol. 0.056 m³ / 1.962 ft³
dim. L 31.5 x W 31.5 x H 56 cm
L 12.4 x W 12.4 x H 22.1 in

BOX 2

gross w. 2.1 kg / 4.6 lbs
vol. 0.009 m³ / 0.312 ft³
dim. L 30.5 x W 30.5 x H 9.5 cm
L 12 x W 12 x H 3.7 in



white



smokey grey

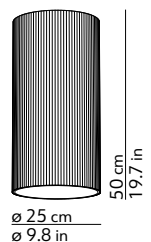



CODE

COLOUR

PRICE VAT excl.

K396330S
K396330G

white
smokey grey

1480 €

LIGHT SOURCE*

board LED 1x25W
2700 K - 2250 lm - CRI>90

FEEDING

100-240 V

DIMMABLE

0-10V

LIGHT DIRECTION



CERTIFICATIONS

⊕ IP20 CE ENEC

MATERIALS

glass + metal

PACKAGING

BOX 1

gross w. 5.5 kg / 12.1 lbs
vol. 0.064 m³ / 2.258 ft³
dim. L 36.5 x W 36.5 x H 48 cm
L 14.4 x W 14.4 x H 18.9 in

BOX 2

gross w. 2.7 kg / 6 lbs
vol. 0.011 m³ / 0.388 ft³
dim. L 34 x W 34 x H 9.5 cm
L 13.4 x W 13.4 x H 3.7 in



white



smokey grey

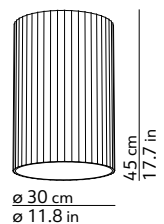



CODE	COLOUR	PRICE VAT excl.
K397330S	white	1600 €
K397330G	smokey grey	

LIGHT SOURCE*

board LED 1x35W
2700 K - 3100 lm - CRI>90

FEEDING

100-240 V

DIMMABLE

0-10V

LIGHT DIRECTION



CERTIFICATIONS

⊕ IP20 CE ENEC

MATERIALS

glass + metal

PACKAGING

BOX 1

gross w. 5.8 kg / 12.8 lbs
vol. 0.090 m³ / 3.169 ft³
dim. L 46.5 x W 46.5 x H 41.5 cm
L 18.3 x W 18.3 x H 16.3 in

BOX 2

gross w. 4.2 kg / 9.3 lbs
vol. 0.018 m³ / 0.650 ft³
dim. L 44 x W 44 x H 9.5 cm
L 17.3 x W 17.3 x H 3.7 in



white



smokey grey

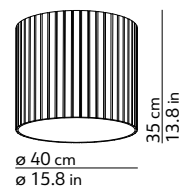



CODE	COLOUR	PRICE VAT excl.
K398330S	white	1745 €
K398330G	smokey grey	

LIGHT SOURCE*

board LED 1x44W
2700 K - 3950 lm - CRI>90

FEEDING

100-240 V

DIMMABLE

0-10V

LIGHT DIRECTION



CERTIFICATIONS

⊕ IP20 CE ENEC

MATERIALS

glass + metal

PACKAGING

BOX 1

gross w. 5.2 kg / 11.5 lbs
vol. 0.099 m³ / 3.495 ft³
dim. L 56.5 x W 56.5 x H 31 cm
L 22.2 x W 22.2 x H 12.2 in

BOX 2

gross w. 6.5 kg / 14.3 lbs
vol. 0.028 m³ / 0.991 ft³
dim. L 54.5 x W 54.5 x H 9.5 cm
L 21.5 x W 21.5 x H 3.7 in



white



smokey grey

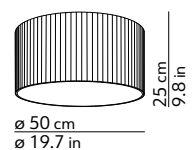



JER

VALERIO SOMMELLA & ANONIMA LUCI

EN. Elegant geometric patterns are traced on the blown glass. The cylinder shape is tinged by colours in eye-catching shades. The shapes and decorations are reminiscent of collections of old-fashioned cut glass with a contemporary twist. Jer can be used to compose groups of multiple elements, ideal for illuminating large spaces.

IT. Eleganti pattern geometrici impreziosiscono il vetro soffiato. La volumetria a cilindro si tinge di suggestivi co-

lori sfumati. Forme e decori ricordano i preziosi servizi di bicchieri di un'altra epoca in una rivisitazione moderna. Jer si presta a comporre gruppi di elementi multipli, ideali per illuminare grandi spazi.

FR. Élégants motifs géométriques enrichissent le verre. La forme cylindrique est teintée de couleurs nuancées et séduisantes. Les formes et les décorations évoquent les services en verre précieux d'une autre époque

dans une réinterprétation moderne. Jer se prête à la combinaison de différents éléments pour créer l'éclairage parfait de grands espaces.

D. Elegante geometrische Muster bereichern das Glas. Die Zylinderform ist in wunderschönen, nuancierten Farben gestaltet. Die Formen und Verzierungen erinnern in ihrer modernen Verarbeitung an die wertvollen Gläser aus einer früheren Zeit. Jer eignet sich, um Gruppen aus verschiedenen Ele-

menten zusammensetzen, die ideal sind, um große Räume zu erhellen.

ES. Elegantes patrones geométricos enriquecen el cristal. El volumen de cilindro se tinte de sugestivos colores matizados. Las formas y las decoraciones recuerdan los preciosos servicios de vasos de otra época pero en clave moderna. Jer puede componer grupos de elementos múltiples, ideales para iluminar espacios grandes.





CODE	COLOUR	PRICE VAT excl.
K504421FB	smokey blue	585 €
K504421FM	smokey brown	
K504421FV	smokey green	

LIGHT SOURCE*

board LED 1x6W
2700 K - 540 lm - CRI>80

FEEDING

220-240 / 120 V

DIMMABLE

phase cut

LIGHT DIRECTION



CERTIFICATIONS

⊕ IP20 CE ENEC

MATERIALS

glass + metal

CABLE LENGTH

180 cm / 70.9 in

CANOPY

black 9005

PACKAGING

BOX 1

gross w. 1.8 kg / 3.97 lbs
vol. 0.015 m³ / 0.530 ft³
dim. L 60 x W 16 x H 16 cm
L 23.6 x W 6.3 x H 6.3 in

BOX 2

gross w. 0.6 kg / 1.32 lbs
vol. 0.002 m³ / 0.071 ft³
dim. L 13 x W 14 x H 11 cm
L 5.1 x W 5.5 x H 4.3 in



smokey blue



smokey brown



smokey green

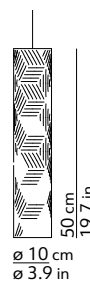
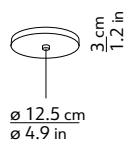

KATE

FRANCESCA SMIRAGLIA

EN. Architectural forms and unconventional dimensions. The headgear worn by the Duchess of Cambridge for the 70th anniversary of the English jubilee inspires Kate, the ceiling light that rewrites the perceptual rules of space. This conical lamp is positioned on the ceiling with an inclination of 15 degrees in order to diffuse the light in an unexpected way.

IT. Forme architettoniche e dimensioni non convenzionali. Il copricapo sfoggiato dalla duchessa di Cambridge per i 70 anni del giubileo inglese, ispi-

ra Kate, la plafoniera che riscrive le regole percettive dello spazio. Questa lampada dalla forma conica è posizionata a soffitto con un'inclinazione di 15 gradi in modo da diffondere la luce in maniera inaspettata.

FR. Des formes architecturales et dimensions non conventionnelles. La coiffe portée par la duchesse de Cambridge pour le 70e anniversaire du Jubilé britannique a inspiré Kate, le plafonnier qui réécrit les règles de perception de l'espace. Cette lampe en forme de cône est positionnée au

plafond avec un angle de 15 degrés afin de diffuser la lumière de manière inattendue.

D. Architektonische Formen und unkonventionelle Dimensionen. Der Kopfschmuck, den die Herzogin von Cambridge zum 70. Jahrestag des britischen Thronjubiläums trug, inspirierte Kate, die Deckenleuchte, die die Wahrnehmungsregeln des Raums neu schreibt. Die kegelförmige Leuchte ist in einem Winkel von 15 Grad an der Decke angebracht, um das Licht auf unerwartete Weise zu streuen.

ES. Formas arquitectónicas y dimensiones no convencionales. El tocado que lució la Duquesa de Cambridge en el 70° aniversario del Jubileo Británico, ha sido la fuente de inspiración de Kate, la lámpara de techo que reescribe las reglas perceptivas del espacio. Esta lámpara de forma cónica se coloca en el techo con un ángulo de 15 grados para difundir la luz de forma inesperada.





CODE	COLOUR	PRICE VAT excl.
KATE 2700 K 510434B27	white	940 €
510434-XXX27	colours on request	1150 €
KATE 3000 K 510434B30	white	940 €
510434-XXX30	colours on request	1150 €

LIGHT SOURCE***KATE 2700 K**

board LED 1x60W
2700 K - 6600 lm - CRI>90

KATE 3000 K

board LED 1x60W
3000 K - 6835 lm - CRI>90

CERTIFICATIONS

⊕ IP20 CE

MATERIALS

metal

PACKAGING**BOX 1**

gross w. 8.0 kg / 17.6 lbs
vol. 0.316 m³ / 11.155 ft³
dim. L 95 x W 95 x H 35 cm
L 37.4 x W 37.4 x H 13.8 in

FEEDING

220-240 / 120 V

DIMMABLE

phase cut

LIGHT DIRECTION

white RAL9010

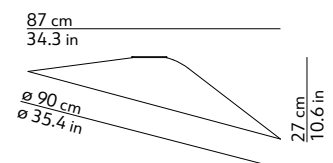

KOOI

STUDIO SHUU

EN. Kooi is inspired by Chinese Shan shui painting and conveys its philosophy. Thanks to the contrast between the glass diffuser and the metal frame, lights and shadows become the protagonists of continuous visual effects and unprecedented changes of perspective. Glass and metal. Light and heavy. Black and white. The Shan shui spirit becomes a suspension lamp.

IT. Kooi si ispira alla pittura cinese Shan shui e ne veicola la filosofia. Grazie al contrasto tra il diffusore in

vetro e la struttura in metallo a fare da cornice, luci e ombre diventano le protagoniste di continui effetti visivi e inediti cambi di prospettiva. Vetro e metallo. Leggero e pesante. Bianco e nero. Lo spirito Shan shui si fa lampada a sospensione.

FR. Kooi s'inspire de la peinture chinoise Shanshui et en transmet la philosophie. Grâce au contraste entre le diffuseur en verre et le cadre métallique, l'ombre et la lumière deviennent les protagonistes d'effets visuels conti-

nus et de changements de perspective sans précédent. Verre et métal. Léger et lourd. Noir et blanc. L'esprit Shanshui devient une lampe suspendue.

D. Kooi ist von der chinesischen Shan-Shui-Malerei inspiriert und vermittelt deren Philosophie. Dank des Kontrasts zwischen dem Glasdiffusor und dem Metallrahmen werden Licht und Schatten zu Protagonisten kontinuierlicher visueller Effekte und noch nie dagewesener Perspektivwechsel. Glas und Metall. Leicht und schwer.

Schwarz und Weiß. Der Geist von Shan Shui wird zu einer Hängeleuchte.

ES. Kooi se inspira en la pintura china Shan shui y transmite su filosofía. Gracias al contraste entre el difusor de cristal y el marco de metal, la luz y la sombra se convierten en protagonistas de continuos efectos visuales y cambios de perspectiva originales. Cristal y metal. Luz y peso. Blanco y negro. El espíritu Shan shui se convierte en una lámpara colgante.





CODE	COLOUR	PRICE VAT excl.
509433N	black	680 €

LIGHT SOURCE*

board LED 1x25W
2700 K - 2750 lm - CRI>90

FEEDING

220-240 / 120 V

DIMMABLE

phase cut

LIGHT DIRECTION**CERTIFICATIONS**

⊕ IP20 CE

MATERIALS

glass + metal

CABLE LENGTH

180 cm / 70.9 in

CANOPY

black RAL9005

PACKAGING**BOX 1**

gross w. 5.5 kg / 12.1 lbs
vol. 0.072 m³ / 2.531 ft³
dim. L 34 x W 34 x H 62 cm
L 13.4 x W 13.4 x H 24.4 in



black RAL9005

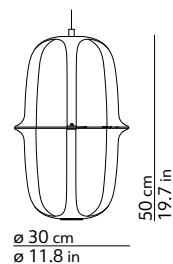
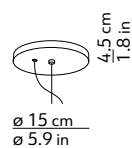

KUSHI CEILING

ALBERTO SAGGIA & VALERIO SOMMELLA

EN. A play on opposites, unexpected equilibrium. Soft, natural curves for the glass diffuser and a simple metal line which passes through and completes it. A convergence of shapes which rest gently on walls and ceilings producing a soft, warm light. When the beauty of design stems from the quest for simplicity.

IT. Gioco di opposti, equilibri inaspettati. Curve morbide e naturali per il diffusore in vetro e una essenziale linea in metallo che lo attraversa e

lo completa. Incontro di forme che si adagiano con leggerezza su pareti e soffitti, con un effetto di luce calda e diffusa. Quando la bellezza del design nasce dalla ricerca della semplicità.

FR. Jeu d'opposé, équilibres inattendus. Courbes souples et naturelles pour le diffuseur en verre et une ligne essentielle en métal qui le traverse et le complète. Rencontre de formes qui s'adaptent avec légèreté sur des murs et des plafonds, avec un effet de lumière chaude et diffusée. Lorsque la

beauté du design naît de la recherche de la simplicité.

D. Ein Spiel aus Gegensätzen und unerwarteten Gleichgewichten. Weiche und natürliche Kurven für den Lampenschirm aus Glas und eine einfache Linie aus Metall, die ihn durchdringt und vervollständigt. Ein Aufeinandertreffen verschiedener Formen, die sich mit Leichtigkeit auf Wänden und Decken platzieren, mit einem Effekt von warmem und diffusum Licht. Wenn die Schönheit des Designs aus der Erfor-

schung der Einfachheit entsteht.

ES. Juego de opuestos, equilibrios inesperados. Curvas suaves y naturales para el difusor de cristal y una línea básica de metal que lo atraviesa y lo completa. Un encuentro de formas que se colocan suavemente en paredes y techos, creando un efecto de luz cálida y tenue. Cuando la belleza del diseño nace de la búsqueda de la simplicidad.



KUSHI 16 CEILING



CODE	COLOUR	PRICE VAT excl.
K225105N	black	260 €
K225105O	brass	
K225105R	copper	

LIGHT SOURCE*
 1x25W max - G9

FEEDING
 220-240 / 120 V

DIMMABLE
 yes

LIGHT DIRECTION



CERTIFICATIONS
 ⓘ IP20 CE ENEC

MATERIALS
 glass + metal

PACKAGING

BOX 1

gross w. 1.08 kg / 2.38 lbs
 vol. 0.011 m³ / 0.380 ft³
 dim. L 23.5 x W 23.5 x H 19.5 cm
 L 9.3 x W 9.3 x H 7.7 in

BOX 2

gross w. 0.3 kg / 0.66 lbs
 vol. 0.005 m³ / 0.159 ft³
 dim. L 14 x W 14 x H 23 cm
 L 5.5 x W 5.5 x H 9.1 in



black RAL9005



brass 205



copper 212

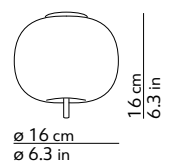

KUSHI 33 CEILING



CODE	COLOUR	PRICE VAT excl.
K220105N	black	395 €
K220105O	brass	
K220105R	copper	

LIGHT SOURCE*
 1x30W max - E27 (E26)

FEEDING
 220-240 / 120 V

DIMMABLE
 yes

LIGHT DIRECTION



CERTIFICATIONS
 ⊕ IP20 CE ENEC

MATERIALS
 glass + metal

PACKAGING

BOX 1
 gross w. 3.34 kg / 7.35 lbs
 vol. 0.053 m³ / 1.865 ft³
 dim. L 40 x W 40 x H 33 cm
 L 15.8 x W 15.8 x H 13 in

BOX 2
 gross w. 0.74 kg / 1.63 lbs
 vol. 0.012 m³ / 0.411 ft³
 dim. L 18.5 x W 18.5 x H 34 cm
 L 7.3 x W 7.3 x H 13.4 in



black RAL9005

brass 205

copper 212

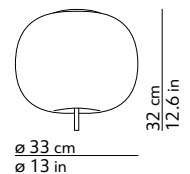

KUSHI XL CEILING



CODE	COLOUR	PRICE VAT excl.
K217105N	black	570 €
K217105O	brass	
K217105R	copper	

LIGHT SOURCE*
 2x70W max - E27 (E26)

FEEDING
 220-240 / 120 V

DIMMABLE
 yes

LIGHT DIRECTION



CERTIFICATIONS
 ⓘ IP20 Ⓢ ENEC

MATERIALS
 glass + metal

PACKAGING
BOX 1
 gross w. 5.5 kg / 12.1 lbs
 vol. 0.107 m³ / 3.766 ft³
 dim. L 51 x W 51 x H 41 cm
 L 20.1 x W 20.1 x H 16.1 in

BOX 2
 gross w. 0.90 kg / 1.98 lbs
 vol. 0.016 m³ / 0.581 ft³
 dim. L 22 x W 22 x H 34 cm
 L 8.7 x W 8.7 x H 13.4 in



black RAL9005

brass 205

copper 212

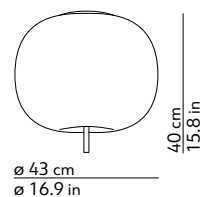

KUSHI SUSPENSION

ALBERTO SAGGIA & VALERIO SOMMELLA

EN. Kushi, "skewer" in Japanese. An abstract shape freely inspired by Japanese cuisine. A gently rounded glass shape pierced by a thin metal rod. Its soft, warm light floats gently in the space. In the suspended version, it is an elegant invitation for dining in contract spaces and at home.

IT. Kushi, "spiedino" in giapponese. Forma astratta liberamente ispirata alla cucina orientale. Geometria in vetro dolcemente arrotondata trafitta

da una sottile bacchetta in metallo. La sua luce calda e soffusa galleggia leggera nello spazio. Nella versione a sospensione, un invito elegante al convivio negli spazi contract e della casa.

FR. Kushi, "brochette" en japonais. Forme abstraite librement inspirée à la cuisine orientale. Géométrie en verre doucement arrondie lancée par une fine baguette en métal. Sa lumière chaude et tamisée flotte légère dans l'espace. Dans la version en

suspension, une invitation élégante au banquet dans les espaces contract et ceux d'une maison.

D. Kushi bedeutet auf Japanisch "Spieß". Eine abstrakte Form, frei inspiriert von der östlichen Küche. Die geometrische und leicht abgerundete Form aus Glas wird durch einen dünnen Stab aus Metall durchquert. Das warme und diffuse Licht schwebt leicht im Raum. In der hängenden Version ist die Lampe eine elegante Einladung, in

Contract- und Wohnräumen gemeinsam Zeit zu verbringen.

ES. Kushi significa "pincho" en japonés. Forma abstracta inspirada libremente en la cocina oriental. Forma del cristal suavemente redondeada atravesada por una fina varita de metal. Su luz cálida y tenue parece flotar en el espacio. En la versión de suspensión, es una invitación elegante a un convite tanto en los espacios comerciales como en los de casa.



KUSHI 16 SUSPENSION



CODE	COLOUR	PRICE VAT excl.
K226105N	black	270 €
K226105O	brass	
K226105R	copper	

LIGHT SOURCE*

1x25W max - G9

FEEDING

220-240 / 120 V

DIMMABLE

yes

LIGHT DIRECTION



CERTIFICATIONS

⊕ IP20 CE ENEC

MATERIALS

glass + metal

CABLE LENGTH

180 cm / 70.9 in

CANOPY

white RAL9010

PACKAGING

BOX 1

gross w. 1.08 kg / 2.38 lbs
 vol. 0.011 m³ / 0.380 ft³
 dim. L 23.5 x W 23.5 x H 19.5 cm
 L 9.3 x W 9.3 x H 7.7 in

BOX 2

gross w. 0.54 kg / 1.19 lbs
 vol. 0.005 m³ / 0.159 ft³
 dim. L 14 x W 14 x H 23 cm
 L 5.5 x W 5.5 x H 9.1 in



black RAL9005



brass 205



copper 212

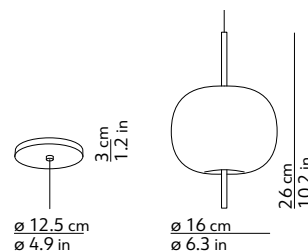

KUSHI 33 SUSPENSION



CODE	COLOUR	PRICE VAT excl.
K221105N	black	495 €
K221105O	brass	
K221105R	copper	

LIGHT SOURCE*

1x30W max - E27 (E26)

FEEDING

220-240 / 120 V

DIMMABLE

yes

LIGHT DIRECTION



CERTIFICATIONS

⊕ IP20 CE ENEC

MATERIALS

glass + metal

CABLE LENGTH

180 cm / 70.9 in

CANOPY

white RAL9010

PACKAGING

BOX 1

gross w. 3.34 kg / 7.35 lbs
 vol. 0.053 m³ / 1.865 ft³
 dim. L 40 x W 40 x H 33 cm
 L 15.8 x W 15.8 x H 13 in

BOX 2

gross w. 0.86 kg / 1.89 lbs
 vol. 0.012 m³ / 0.411 ft³
 dim. L 18.5 x W 18.5 x H 34 cm
 L 7.3 x W 7.3 x H 13.4 in



black RAL9005

brass 205

copper 212

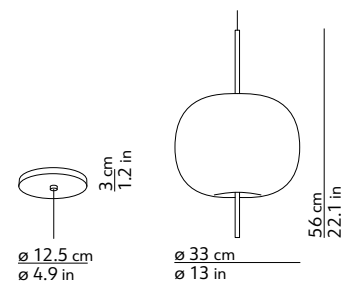

KUSHI XL SUSPENSION



CODE	COLOUR	PRICE VAT excl.
K218105N	black	730 €
K218105O	brass	
K218105R	copper	

LIGHT SOURCE*

2x70W max - E27 (E26)

FEEDING

220-240 / 120 V

DIMMABLE

yes

LIGHT DIRECTION



CERTIFICATIONS

⊕ IP20 CE ENEC

MATERIALS

glass + metal

CABLE LENGTH

180 cm / 70.9 in

CANOPY

white RAL9010

PACKAGING

BOX 1

gross w. 5.5 kg / 12.1 lbs
 vol. 0.107 m³ / 3.766 ft³
 dim. L 51 x W 51 x H 41 cm
 L 20.1 x W 20.1 x H 16.1 in

BOX 2

gross w. 0.87 kg / 1.91 lbs
 vol. 0.007 m³ / 0.252 ft³
 dim. L 14.5 x W 14.5 x H 34 cm
 L 5.7 x W 5.7 x H 13.4 in

BOX 3

gross w. 1.37 kg / 3.02 lbs
 vol. 0.001 m³ / 0.026 ft³
 dim. L 8 x W 6 x H 24 cm
 L 3.2 x W 2.4 x H 9.5 in



black RAL9005

brass 205

copper 212

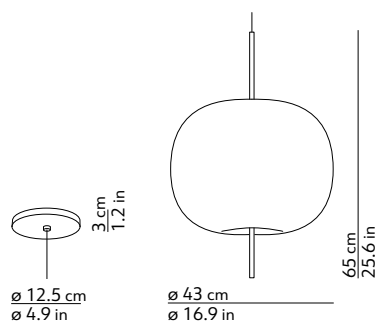

LANNÀ SUSPENSION

NOÉ DUCHAUFOUR LAWRENCE

EN. A contemporary lightness, an ancient rite. The rite of the Lanna, the Thai people, who every year release hundreds of lanterns into the starlit sky. The glass diffuser, balanced in the suspended metal structure, appears ethereal and sophisticated. Intimate, dreamlike atmospheres in the bedroom and all the interiors of home and contract settings alike.

IT. Una leggerezza contemporanea, un rito antico. Quello dei Lanna, popolo thailandese che ogni anno libera

centinaia di lanterne nella notte stellata. Il diffusore in vetro, sospeso in equilibrio nella struttura in metallo, appare etereo e sofisticato. Atmosfere intime e sognanti, nella zona notte e in tutti gli interni domestici e contract.

FR. Une légèreté contemporaine, un rite antique. Celui des Lanna, peuple thaïlandais qui chaque année libère des centaines de lanternes dans la nuit étoilée. Le diffuseur en verre, suspendu en équilibre dans la structure en métal, apparaît éthéré et sophisti-

qué. Atmosphères intimes et rêveuses, dans la zone nuit et dans toutes les pièces internes domestiques et du secteur contract.

D. Moderne Leichtigkeit und ein antikes Ritual. Das ist Lanna, ein thailändisches Volk, das jedes Jahr Hunderte Laternen in den Sternenhimmel steigen lässt. Der Lampenschirm aus Glas, der gleichmäßig im Gestell aus Metall hängt, erscheint ewig und raffiniert. Intime und traumhafte Atmosphären im Schlafzimmer sowie in

allen Wohn- und Contract-Bereichen.

ES. Una ligereza contemporánea, un rito antiguo. El de los Lanna, un pueblo tailandés que todos los años lanza centenares de lamparas al aire para que vuelen por el cielo estrellado. El difusor de cristal, suspendido en equilibrio sobre la estructura de metal, da un aspecto etéreo y sofisticado. Atmosferas íntimas y de ensueño, tanto en la zona noche como en todos los interiores domésticos y comerciales.



LANNÀ SUSPENSION



CODE	COLOUR	PRICE VAT excl.
K386320N	black	490 €
K386320	brass	

LIGHT SOURCE*

1x20W max - E27 (E26)
 Ø 6cm max

FEEDING

220-240 / 120 V

DIMMABLE

yes

LIGHT DIRECTION**CERTIFICATIONS**

⊕ IP20 CE ENEC

MATERIALS

glass + metal

CABLE LENGTH

180 cm / 70.9 in

CANOPY

black RAL9005
 or brass 209

PACKAGING**BOX 1**

gross w. 2.02 kg / 4.44 lbs
 vol. 0.022 m³ / 0.788 ft³
 dim. L 26 x W 26 x H 33 cm
 L 10.2 x W 10.2 x H 13 in

BOX 2

gross w. 1.74 kg / 3.83 lbs
 vol. 0.026 m³ / 0.927 ft³
 dim. L 44.5 x W 29.5 x H 20 cm
 L 17.5 x W 11.6 x H 7.9 in



black RAL9005



brass 209

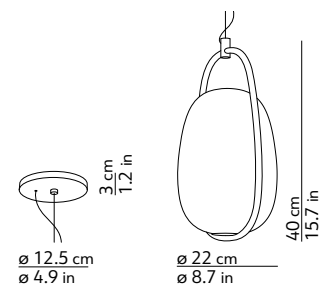

LILLI

CRISTINA CELESTINO

EN. As in a sophisticated collection of botanical drawings, the delicate lines of Lilli recall the beauty of a rare flower. The delicate inverted corolla of the Martagon Lily is reinterpreted in an original lamp. The soft shape of the white opal glass diffuser is perfectly combined with the brass pistil to create an even more elegant effect.

IT. Come in un sofisticato erbario del design, le linee gentili di Lilli richiamano la bellezza di un fiore raro. La delicata corolla rovesciata del Giglio

Martagone viene reinterpretata in una lampada originale. La morbida geometria del diffusore in vetro opale bianco si accosta armoniosamente al pistillo in ottone, con un effetto ancora più prezioso.

FR. Comme dans un herbier sophistiqué du design, les lignes gentilles de Lilli rappellent la beauté d'une fleur rare. La corolle délicate renversée du lis martagon est réinterprétée en une lampe originale. La géométrie souple du diffuseur en verre opale blanc s'as-

sortit de manière harmonieuse au pistil en laiton, avec un effet encore plus précieux.

D. Wie in einem raffinierten Herbarium des Designs erinnern die zarten Linien von Lilli an die Schönheit einer seltenen Blume. Die zarte Blütenkrone, vom Türkenbund zerstört, wurde in einer originellen Lampe neu interpretiert. Die weiche geometrische Form des Lampenschirms aus mattweißem Glas passt harmonisch zum Blütenstempel aus Messing, der für einen

noch hochwertigeren Effekt sorgt.

ES. Al igual que en un sofisticado herbario de diseño, las graciosas líneas de Lilli evocan la belleza de una flor rara. La delicada corola colgante del Lirio Martagón se reinterpreta en una lámpara original. La delicada forma del difusor de cristal ópalo blanco se combina de forma armoniosa con el pistilo de latón, creando aún más un efecto precioso.





CODE	COLOUR	PRICE VAT excl.
K355365O	brass	695

LIGHT SOURCE*

3x42W max - E14 (E12)

FEEDING

220-240 / 120 V

DIMMABLE

yes

LIGHT DIRECTION



CERTIFICATIONS

⊕ IP20 CE ENEC

MATERIALS

glass + metal

CABLE LENGTH

180 cm / 70.9 in

CANOPY

white RAL9010

PACKAGING

BOX 1

gross w. 4 kg / 8.8 lbs
 vol. 0.049 m³ / 1.719 ft³
 dim. L 39 x W 39 x H 32 cm
 L 15.4 x W 15.4 x H 12.6 in

BOX 2

gross w. 1.58 kg / 3.48 lbs
 vol. 0.006 m³ / 0.212 ft³
 dim. L 16 x W 16 x H 42 cm
 L 6.3 x W 6.3 x H 16.5 in



brass 305

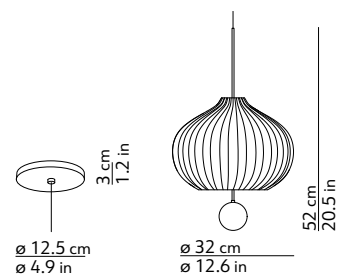

LOUIS

STUDIO 14

EN. New connections between light and music and new rhythm even in the largest environments, with a lamp that pays homage to the great Louis Armstrong. The design is reminiscent of the shape of a trumpet, the instrument of the legendary jazz musician. The ceiling lamp, available in different heights, lends itself to creating always different compositions, just like a brilliant jam session.

IT. Nuove connessioni fra luce e musica e nuovo ritmo anche negli spazi più vasti, con una lampada che rende

omaggio al grande Louis Armstrong. Il design riprende le forme della tromba, strumento del leggendario jazzista. La plafoniera, declinata in diverse altezze, si presta a creare composizioni sempre diverse come in una jam session luminosa.

FR. Une nouvelle harmonie entre la lumière et la musique et un nouveau rythme, même dans les plus grands espaces, avec une lampe qui rend hommage à Louis Armstrong. Le design rappelle les formes d'une trompette, instrument du légendaire jazzman.

Le plafonnier, disponible en différentes hauteurs, se prête à la création de compositions toujours changeantes, comme dans une jam-session lumineuse.

D. Neue Verbindungen zwischen Licht und Musik und neuer Rhythmus auch in den größten Räumen, mit einer Leuchte, die dem großen Louis Armstrong Tribut zollt. Das Design erinnert an die Form der Trompete, dem Instrument des legendären Jazzers. Die Deckenleuchte, die in verschiedenen Höhen erhältlich ist, eignet sich für

immer neue Kompositionen, wie eine leuchtende Jamsession.

ES. Nuevas conexiones entre luz y música y nuevo ritmo incluso en los espacios más vastos, con una lámpara que rinde homenaje al gran Louis Armstrong. El diseño retoma las formas de la trompeta, instrumento del legendario jazzista. La lámpara de techo, declinada en diversas alturas, se presta a crear composiciones siempre diferentes como en una jam session luminosa.





CODE	COLOUR	PRICE VAT excl.
LOUIS 34 K075245	white	370 €
LOUIS 41 K075245M	white	390 €
LOUIS 48 K075245L	white	410 €

LIGHT SOURCE*

1x30W max - E27 (E26)
Ø 5.5cm max

FEEDING

220-240 / 120 V

DIMMABLE

yes

LIGHT DIRECTION



CERTIFICATIONS

⊕ IP20 CE ENEC

MATERIALS

polyethylene + aluminium

PACKAGING

BOX 1

gross w. 5.12 kg / 11.26 lbs
vol. 0.174 m³ / 6.153 ft³
dim. L 66 x W 66 x H 40 cm
L 26 x W 26 x H 15.8 in

BOX 2

gross w. 1.14 kg / 2.51 lbs
vol. 0.007 m³ / 0.244 ft³
dim. L 27 x W 16 x H 16 cm
L 10.6 x W 6.3 x H 6.3 in



white

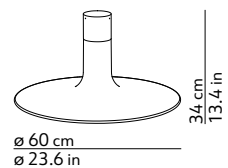
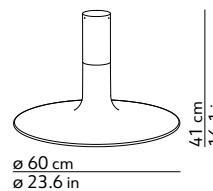
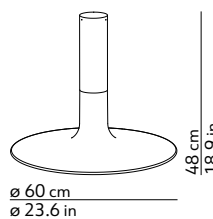

MINIMAL

DAVID POMPA

EN. The encounter between a young designer and the artisan culture of his birthplace. The minimal lines reveal the beauty of Barro Negro pottery created with age-old techniques. The polished black colour obtained with a special firing, together with the minor imperfections of manual craftsmanship, create an eye-catching contrast with the metal part.

IT. L'incontro fra un giovane designer e la cultura artigianale della sua terra. Le linee minimali svelano la bellezza del Barro Negro, ceramica realizza-

ta con tecniche antiche. Il suo colore nero lucente ottenuto con una speciale cottura, insieme alle leggere imperfezioni dell'esecuzione manuale, creano un interessante contrasto con la parte in metallo.

FR. La rencontre entre un jeune designer et la culture artisanale de sa terre. Les lignes minimales dévoilent la beauté du Barro Negro, céramique réalisée avec des techniques antiques. Sa couleur noire brillante obtenue grâce à une cuisson spéciale, avec de légères

imperfections dues à l'exécution manuelle, crée un contraste intéressant avec la partie en métal.

D. Das Aufeinandertreffen zwischen einem jungen Designer und der handwerklichen Kultur seiner Region. Die minimalen Linien erinnern an die Schönheit der Barro Negro Keramik, die anhand antiker Techniken hergestellt wird. Die schwarz glänzende Farbe entsteht durch einen besonderen Brennvorgang und sie lässt gemeinsam mit den leichten Unvollkommenheiten durch die händische

Fertigung einen interessanten Kontrast zum Teil aus Metall entstehen.

ES. El encuentro entre un joven diseñador y la cultura artesanal de su tierra. Las líneas minimalistas revelan la belleza del Barro Negro, un tipo de cerámica realizada con técnicas antiguas. Su color negro brillante que se obtiene a través de una cocción especial, junto con las ligeras imperfecciones de la realización manual, crean un contraste interesante con la parte metálica.





CODE	COLOUR	PRICE VAT excl.
380315R	copper	265 €
380315N	black nickel	
OPTIONAL		
ALI-CC350_8W	driver (not dimmable)	30 €
500500N	black canopy	68 €

LIGHT SOURCE*

board LED 1x3.15W
2700 K - 410 lm - CRI>80

FEEDING**

DC 350mA constant current

DIMMABLE

yes

LIGHT DIRECTION**CERTIFICATIONS****MINIMAL**

◆ IP20 CE ENEC

MINIMAL + DRIVER

□ IP20 CE ENEC

MINIMAL + OPTIONAL CANOPY

⊕ IP20 CE ENEC

MATERIALS

ceramic + metal

CABLE LENGTH

180 cm / 70.9 in

CANOPY

black RAL9005

PACKAGING**BOX 1**

gross w. 0.8 kg / 1.76 lbs

vol. 0.003 m³ / 0.102 ft³

dim. L 40 x W 8.5 x H 8.5 cm

L 15.8 x W 3.4 x H 3.4 in



copper 306

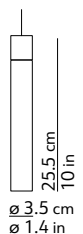
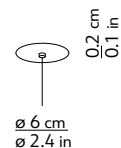
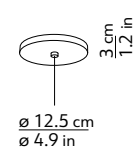

black nickel

OPTIONAL**SUSPENSION**

* included

** driver not included

MITOS

CHRIS BASIAS

EN. Like Ariadne donates Theseus a thread so that he could retrace his way out of the labyrinth of the Minotaur, MitoS goes along with light in domestic and public environments. This system of adjustable spotlights transfers an unusual eclecticism over the ceiling, enhancing the ambience of the scene.

IT. Come Arianna dona a Teseo il filo

per trovare la via d'uscita dal labirinto del Minotauro, MitoS accompagna la luce nelle scene domestiche e contract. Questo sistema di faretti orientabili trasferisce un insolito eclettismo nei soffitti esaltando il design degli interni.

FR. Comme Ariane donne à Thésée le fil pour trouver la sortie du labyrinthe du Minotaure, MitoS accompagne la lumière dans les scènes résidentiell-

es et contract. Ce système de spots orientables transfère un éclectisme insolite dans les plafonds et exalte ainsi le design des intérieurs.

D. Wie Ariadne Theseus den Faden gibt, um den Weg aus dem Labyrinth des Minotaurus zu finden, begleitet MitoS das Licht in häuslichen und geschäftlichen Umgebungen. Dieses System verstellbarer Spots überträgt

einen ungewöhnlichen Eklektizismus auf die Decken und wertet das Innendesign auf.

ES. Como Ariadna da a Teseo el hilo para encontrar la salida del laberinto del Minotauro, MitoS acompaña la luz en las escenas domésticas y contract. Este sistema de focos orientables transfere un insólito eclecticismo a los techos realzando el diseño de interiores.





CODE	COLOUR	PRICE VAT excl.
507431N	black	210 €
ACCESSORIES		
507-ALI70N	driver kit (48V - 70W max)	250 €
507-CAV10	copper cable (10m / 32.8ft)	64 €
507-CAV30	copper cable (30m / 98.4ft)	165 €
507-AC1	cable holder plate	15 €

LIGHT SOURCE*

1x10W max - GU 5.3

FEEDING

100-240 V

DIMMABLE

yes

LIGHT DIRECTION**CERTIFICATIONS**
MATERIALS

aluminium + technopolymer

DRIVER KIT

black RAL9005

PACKAGING**BOX 1**

gross w. 1.2 kg / 2.65 lbs

vol. 0.003 m³ / 0.106 ft³

dim. L 11 x W 11 x H 23 cm

L 4.3 x W 4.3 x H 9.1 in

DRIVER KIT**BOX 1**

gross w. 2.3 kg / 5.07 lbs

vol. 0.013 m³ / 0.459 ft³

dim. L 28 x W 28 x H 17 cm

L 11 x W 11 x H 6.7 in

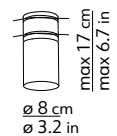
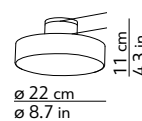

black RAL9005

DRIVER KIT

MOTUS

SHULAB

EN. Unconditional freedom and ability to adapt to a stimulating environment and changing needs. This is the common denominator between Motus and a skill sport such as vertical wall climbing. Press and Release. A single interaction, a simple movement. Motus slides along its power cord, adjusting to different heights and supporting itself thanks to its own weight.

IT. Libert  incondizionata e capacit  di adattarsi all'ambiente, ricco di stimoli ed esigenze mutevoli. Questo   il comune denominatore tra Motus e uno sport di abilit  come l'arrampica-

ta su parete verticale. Premi e Rilascia. Un'unica interazione, un semplice movimento. Motus scorre lungo il proprio cavo di alimentazione regolandosi ad altezze diverse e sostenendosi grazie al suo stesso peso.

FR. Une libert  inconditionnelle et la capacit  de s'adapter   l'environnement, plein de stimuli et de besoins changeants. C'est le d nominateur commun entre Motus et un sport d'adresse tel que l'escalade de parois verticales. Appuyer et rel cher. Une seule interaction, un mouvement simple. Motus glisse le long de son propre

c ble d'alimentation, s'ajuste   diff rentes hauteurs et se soutient gr ce   son propre poids.

D. Bedingungslose Freiheit und die F higkeit, sich an die Umgebung anzupassen, die voller Reize und wechselnder Bed rfnisse ist. Das ist der gemeinsame Nenner zwischen Motus und einer Geschicklichkeitssportart wie dem Klettern an vertikalen W nden. Dr cken und Loslassen. Eine einzige Interaktion, eine einfache Bewegung. Motus gleitet entlang seines eigenen Stromkabels, stellt sich auf verschiedene H hen ein und tr gt sich selbst

durch sein eigenes Gewicht.

ES. Libertad incondicional y capacidad de adaptaci n al entorno, lleno de est mulos y necesidades cambiantes. Este es el denominador com n entre Motus y un deporte de habilidad como la escalada en pared vertical. Presionar y soltar. Una interacci n, un simple movimiento. Motus se desliza a lo largo de su propio cable de alimentaci n, ajust ndose a diferentes alturas y sosteni ndose gracias a su propio peso.





CODE	COLOUR	PRICE VAT excl.
K512436B	white	470 €
K512436N	black	
K512436R	red	

LIGHT SOURCE*

board LED 1x22W
2700 K - 2420 lm - CRI>90

FEEDING

220-240 / 120 V

DIMMABLE

phase cut

LIGHT DIRECTION**CERTIFICATIONS**

⊕ IP20 CE

MATERIALS

glass + metal

CABLE LENGTH

~350 cm / ~137.8 in

CANOPY

white RAL9010 or black RAL9005
or red RAL3016

PACKAGING**BOX 1**

gross w. 2.02 kg / 4.44 lbs
vol. 0.022 m³ / 0.788 ft³
dim. L 26 x W 26 x H 33 cm
L 10.2 x W 10.2 x H 13 in

BOX 2

gross w. 1.74 kg / 3.83 lbs
vol. 0.026 m³ / 0.927 ft³
dim. L 44.5 x W 29.5 x H 20 cm
L 17.5 x W 11.6 x H 7.9 in



white RAL 9010



black RAL 9005



red RAL 3016

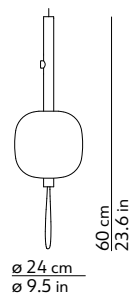
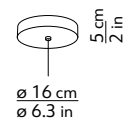

NAMI

ALBERTO SAGGIA & VALERIO SOMMELLA

EN. Nami, which means "wave" in Japanese, creates a continuous, eye-catching refraction of light. The diffuser, with its signature elegant grooves, opens unexpectedly at the sides to amplify the reflections of light. The graphic outline of the structure creates a visual contrast with the glass surface in an innovative balance between solidity and lightness.

IT. Nami, che in giapponese significa "onda", crea un continuo e suggestivo rifrangersi di luce. Il diffusore,

caratterizzato da eleganti scanalature, si apre inaspettatamente ai lati amplificando i riflessi luminosi. La linea grafica della struttura fa da contrappunto visivo alle superfici in vetro, in una nuova armonia tra solidità e leggerezza.

FR. Nami, qui en japonais signifie "vague", crée une réflexion continue et suggestive de lumière. Le diffuseur, caractérisé par des rainures élégantes, s'ouvre de manière inattendue sur les côtés, amplifiant les reflets

lumineux. La ligne graphique de la structure sert de contrepoint visuel aux surfaces en verre en une nouvelle harmonie entre solidité et légèreté.

D. Nami, was im Japanischen "Welle" bedeutet, lässt ein kontinuierliches und zauberhaftes Brechen des Lichts entstehen. Der Diffusor, der sich durch elegante Kanäle auszeichnet, öffnet sich an den Seiten auf unerwartete Weise und erweitert die Lichtreflexe. Die grafische Linie der Struktur dient als sichtbarer Kontrapunkt zu den

Oberflächen aus Glas, in einem neuen Gleichgewicht aus Festigkeit und Leichtigkeit.

ES. Nami, que en japonés significa "ola", crea una refracción de luz continua y sugestiva. El difusor, caracterizado por acanaladuras elegantes, se abre de manera inesperada en los lados amplificando los reflejos luminosos. La línea gráfica de la estructura sirve de contrapunto visual a las superficies de cristal, en una nueva armonía entre solidez y ligereza.





CODE	COLOUR	PRICE VAT excl.
K405340N	black	1850 €
K405340	brass	

LIGHT SOURCE*

board LED 4x15W
2700 K - 2520x2 lm - CRI>90

FEEDING

100-240 V

DIMMABLE

1-10V

LIGHT DIRECTION



CERTIFICATIONS

⊕ IP20 CE ENEC

MATERIALS

glass + metal

CABLE LENGTH

180 cm / 70.9 in

CANOPY

black RAL9005
or brass 111

PACKAGING

BOX 1

gross w. 7.4 kg / 16.28 lbs
vol. 0.075 m³ / 2.641 ft³
dim. L 130 x W 19.5 x H 29.5 cm
L 51.2 x W 7.7 x H 11.6 in

BOX 2

gross w. 12.6 kg / 27.72 lbs
vol. 0.019 m³ / 0.672 ft³
dim. L 160 x W 17 x H 7 cm
L 63 x W 6.7 x H 2.8 in



black RAL9005

brass 111

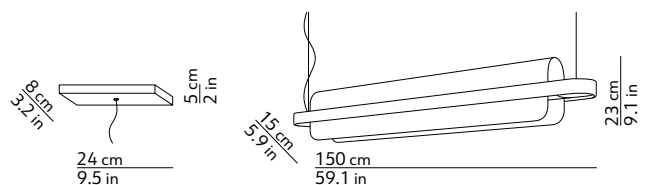

SUSPENSION

* included

NEW YORK

PETER JAMIESON

EN. Metropolitan life frame. The typical lozenge pattern of the hot dog carts of New York inspires the diffuser. Vintage industrial style, obtained with a special use of the die-cutting technique.

IT. Frame di vita metropolitana. Il tipico pattern a losanghe dei banchetti di hot dog agli angoli delle strade

newyorchesi ispira il diffusore. Suggestioni vintage industriali, ottenute con uno speciale utilizzo della tecnica di fustellatura.

FR. Cadre de la vie métropolitaine. Le motif typique en losange des stands de hot-dogs aux coins des rues de New York inspire le diffuseur. Des suggestions industrielles rétro, obtenues

grâce à une utilisation particulière de la technique du découpage.

D. Rahmen des großstädtischen Lebens. Das typische Rautenmuster der Hot-Dog-Stände an den Straßenecken von New York inspirierte den Diffusor. Vintage-Industrieanregungen, die mit einer speziellen Anwendung der Stanztechnik erzielt werden.

ES. Marco de la vida metropolitana. El típico patrón de rombos de los puestos de perros calientes en las esquinas de las calles neoyorquinas inspira al difusor. Sugerencias industriales vintage, obtenidas con un uso especial de la técnica de troquelado.





CODE	COLOUR	PRICE VAT excl.
NEW YORK 33		
K090261MB	white	362 €
K090261MC	grey chrome	
K090261MR	red	
NEW YORK 45		
K090261LB	white	513 €
K090261LC	grey chrome	
K090261LR	red	

LIGHT SOURCE*

NEW YORK 33
1x30W max - E27 (E26)

NEW YORK 45
3x30W max - E27 (E26)

FEEDING
220-240 / 120 V

DIMMABLE
yes

CERTIFICATIONS

⊕ IP20 CE ENEC

MATERIALS

technopolymer + methacrylate

CABLE LENGTH

180 cm / 70.9 in

CANOPY

chromed

LIGHT DIRECTION



PACKAGING

NEW YORK 33

BOX 1

gross w. 1.36 kg / 2.99 lbs
vol. 0.009 m³ / 0.316 ft³
dim. L 43 x W 104 x H 2 cm
L 16.9 x W 40.9 x H 0.8 in

BOX 2

gross w. 1.3 kg / 2.86 lbs
vol. 0.024 m³ / 0.862 ft³
dim. L 34.5 x W 34.5 x H 20.5 cm
L 13.6 x W 13.6 x H 7.9 in

NEW YORK 45

BOX 1

gross w. 2.58 kg / 5.68 lbs
vol. 0.022 m³ / 0.773 ft³
dim. L 61 x W 143.5 x H 2.5 cm
L 24 x W 56.5 x H 1 in

BOX 2

gross w. 2.46 kg / 5.41 lbs
vol. 0.040 m³ / 1.399 ft³
dim. L 41 x W 42 x H 23 cm
L 16.1 x W 16.5 x H 9.1 in



white



grey chrome



red

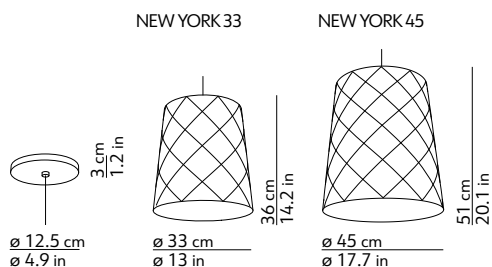

SUSPENSION

* not included

OPYO SUSPENSION

CRISTINA CELESTINO

EN. The infinite abundance of shapes in the natural world has always inspired art and design. The simple, harmonious lines of the poppy seed pod appear as if by magic in Opyo. The suspended version is a sophisticated design object. One individual lamp or multiple lamps placed side by side conjure up an evocative, refined atmosphere.

IT. L'infinita ricchezza di forme del mondo naturale ispira da sempre l'arte e il design. Le linee semplici e

armoniose del baccello di papavero si riconoscono quasi per magia in Opyo. Nella versione a sospensione, un oggetto dal design sofisticato. La lampada singola o più lampade accostate fra loro creano atmosfere evocative e raffinate.

FR. La richesse infinie de formes dans le monde naturel inspire depuis toujours l'art et le design. Les lignes simples et harmonieuses de la cosse de pavot se reconnaissent presque par magie dans Opyo. Dans la version à suspen-

sion, un objet au design sophistiqué. La lampe individuelle ou plusieurs lampes mises côte à côte créent une atmosphère évocatrice et raffinée.

D. Der unendliche Reichtum an Formen in der natürlichen Welt inspiriert seit jeher Kunst und Design. Die einfachen und harmonischen Linien der Samenhülse von Mohnblüten sind auf magische Weise in Opyo zu erkennen. In der hängenden Version ist diese Lampe ein raffinierter Design-Genstand. Die einzelne Lampe oder

mehrere miteinander kombinierte Lampen lassen zauberhafte und raffinierte Atmosphären entstehen.

ES. La infinita riqueza de formas del mundo natural inspira desde siempre al arte y al diseño. Las líneas simples y armoniosas de la flor de amapola se reconocen, casi por arte de magia, en Opyo. En la versión en suspensión es un objeto con un sofisticado diseño. Tanto una lámpara sola como varias lámparas apoyadas entre ellas crean atmósferas evocadoras y refinadas.



OPYO SUSPENSION



CODE	COLOUR	PRICE VAT excl.
K350356B	white	420 €
K350356C	coral	
K350356O	brass	

LIGHT SOURCE*

1x70W max - E27 (E26)

FEEDING

220-240 / 120 V

DIMMABLE

yes

LIGHT DIRECTION



CERTIFICATIONS

⊕ IP20 CE ENEC

MATERIALS

glass + metal

CABLE LENGTH

180 cm / 70.9 in

CANOPY

white RAL 9010

PACKAGING

BOX 1

gross w. 2.00 kg / 4.40 lbs

vol. 0.027 m³ / 0.968 ft³

dim. L 29.5 x W 29.5 x H 31.5 cm

L 11.6 x W 11.6 x H 12.4 in

BOX 2

gross w. 1.5 kg / 3.3 lbs

vol. 0.003 m³ / 0.089 ft³

dim. L 22.5 x W 22.5 x H 5 cm

L 8.9 x W 8.9 x H 2 in



white RAL9010

coral RAL3012

brass 219

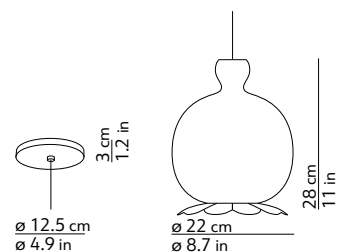

PEACOCK

NOÉ DUCHAUFOUR LAWRENCE

EN. The marvellous logic of nature reveals patterns of surprising beauty and precision. Like a peacock's tail feathers, the source of inspiration for an original chandelier. The individual elements from which it is composed create a one-of-a-kind and perfect design which unexpectedly seems to conjure up faraway atmospheres in a contemporary version.

IT. La logica meravigliosa della natura svela pattern di una bellezza e precisione sorprendente. Come la coda

del pavone, fonte di ispirazione di un originale chandelier. I singoli elementi che lo compongono creano un disegno unico e perfetto, che a sorpresa sembra citare atmosfere lontane in versione contemporanea.

FR. La logique merveilleuse de la nature dévoile un modèle d'une beauté et d'une précision surprenante. Comme la queue du paon, source d'inspiration d'un chandelier original. Chaque élément qui la compose crée un dessin unique et parfait, qui par surprise

semble citer des atmosphères lointaines en version contemporaine.

D. Die wunderbare Logik der Natur zeigt Muster einer überraschenden Schönheit und Präzision. Dazu gehört auch der Schwanz des Pfau, Inspirationsquelle für einen originellen Chandelier. Die einzelnen Elemente, aus denen er besteht, garantieren ein einzigartiges und perfektes Design, das überraschenderweise in moderner Version von fernen Atmosphären zu erzählen scheint.

ES. La maravillosa lógica de la naturaleza revela una estructura con una belleza y precisión sorprendente. La cola del pavo real se convierte en fuente de inspiración de un original candelabro. Cada uno de los elementos que lo componen crean un diseño único y perfecto, que como por sorpresa da la sensación de evocar lejanas atmósferas pero en una versión contemporánea.





CODE	COLOUR	PRICE VAT excl.
080250T	acid-etched brass	6300 €

LIGHT SOURCE*

board LED 12x4.5W
2700 K - 6000 lm - CRI>90

FEEDING

110-240 V

DIMMABLE

1-10V (push or DALI on request)

LIGHT DIRECTION



CERTIFICATIONS

⊕ IP20 CE ENEC

MATERIALS

steel + glass

CABLE LENGTH

180 cm / 70.9 in

CANOPY

acid-etched brass

PACKAGING

BOX 1

gross w. 30.4 kg / 66.88 lbs
vol. 0.673 m³ / 23.768 ft³
dim. L 86 x W 86 x H 91 cm
L 33.9 x W 33.9 x H 35.8 in



acid-etched brass

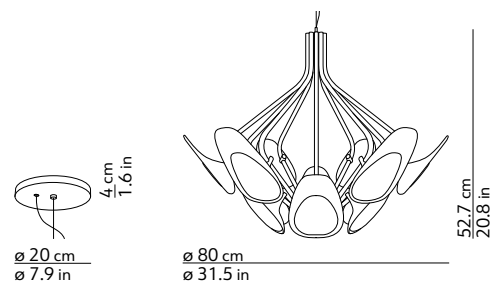

POISE CEILING

ROBERT DABI

EN. In Poise, human curiosity and the interaction with light source, are encouraged by the flexible section between frame and the circle, allowing the latter to be moved into any position. A vitality capable of creating ever-changing configurations defying gravity.

IT. In Poise, la curiosità e l'interazione umana con la sorgente luminosa sono incoraggiate dalla sezione flessibile

tra l'asta e l'anello, che consente di spostare quest'ultimo in qualsiasi posizione. Un dinamismo che sfida la forza di gravità per creare configurazioni mutevoli.

FR. Sur Poise, la curiosité et l'interaction humaine avec la source lumineuse sont encouragées par la section flexible entre la tige et le cercle, qui permet de déplacer ce der-

nier dans n'importe quelle position. Un dynamisme qui défie la force de gravité pour créer des configurations changeantes.

D. Bei Poise werden die Neugier und die menschliche Interaktion mit der Lichtquelle durch den flexiblen Abschnitt zwischen Stab und Ring gefördert, der es ermöglicht, letzteren in jede Position zu bewegen. Eine Dynamik,

die der Schwerkraft trotzt, um veränderbare Konfigurationen zu schaffen.

ES. En Poise, la curiosidad y la interacción humana con la fuente de luz se ven favorecidas por la sección flexible entre la varilla y el anillo, que permite mover este último a cualquier posición. Un dinamismo que desafía la fuerza de gravedad para crear configuraciones cambiantes.





CODE	COLOUR	PRICE VAT excl.
505426N	black	460 €

LIGHT SOURCE*

strip LED 1x28W
2700 K - 3600 lm - CRI>90

FEEDING

220-240 / 120 V

DIMMER

phase cut

LIGHT DIRECTION**CERTIFICATIONS**

⊕ IP20 CE

MATERIALS

metal

PACKAGING**BOX 1**

gross w. 3.4 kg / 7.48 lbs

vol. 0.034 m³ / 1.194 ft³

dim. L 65 x W 65 x H 8 cm

L 25.6 x W 25.6 x H 3.2 in



black RAL9005

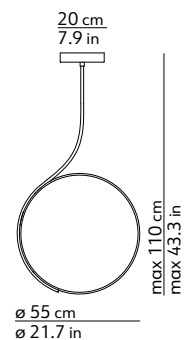

SLING

CHRIS BASIAS

EN. A single unipolar cable transfers current and supports multiple light sources. Like a slingshot in the open air, this cable projects light installations, giving life to spectacular geometries and configurations that are always unexpected. Straight from our childhood, Sling plays with simplicity and endless variables.

IT. Un unico cavo unipolare trasferisce la corrente e supporta sorgenti luminose multiple. Come una fionda

all'aria aperta, questo cavo proietta installazioni di luce, dando vita a geometrie spettacolari e configurazioni sempre inaspettate. Direttamente dalla nostra infanzia, Sling gioca con semplicità e infinite variabili.

FR. Un seul câble unipolaire transfère le courant et supporte plusieurs sources lumineuses. Comme une fronde à l'air libre, ce câble projette des installations lumineuses, créant des géométries spectaculaires et des

configurations toujours inattendues. Tout droit sorti de notre enfance, Sling joue avec la simplicité et les variables infinies.

D. Ein einziges unipolares Kabel überträgt Strom und unterstützt mehrere Lichtquellen. Wie eine Schleuder im Freien projiziert dieses Kabel Lichtinstallationen, die spektakuläre Geometrien und immer wieder unerwartete Konfigurationen schaffen. Direkt aus unserer Kindheit spielt Sling mit

Einfachheit und unendlichen Variablen.

ES. Un único cable unipolar transfiere corriente y soporta múltiples fuentes de luz. Como un tirachinas al aire libre, este cable proyecta instalaciones de luz, creando geometrías espectaculares y configuraciones siempre inesperadas. Directamente desde nuestra infancia, Sling juega con la simplicidad y las variables infinitas.





CODE	COLOUR	PRICE VAT excl.
508432N	black	92 €
ACCESSORIES		
508-ALIEU	driver kit (from 2 to 9 lamps max)	150 €

LIGHT SOURCE*

board LED 1x6W
3000 K - 660 lm - CRI>90

FEEDING

220-240 / 120 V

DIMMER

1-10V or push

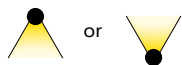
LIGHT DIRECTION**CERTIFICATIONS**

◆ IP20 CE

MATERIALS

metal

CABLE LENGTH

2 x 200 cm / 2 x 78.7 in
for each lamp

DRIVER KIT

black RAL9005

PACKAGING**BOX 1**

gross w. 0.8 kg / 1.76 lbs
vol. 0.001 m³ / 0.029 ft³
dim. L 8 x W 8 x H 13 cm
L 3.2 x W 3.2 x H 5.1 in

DRIVER KIT**BOX 1**

gross w. 2.5 kg / 5.5 lbs
vol. 0.003 m³ / 0.094 ft³
dim. L 22 x W 22 x H 5.5 cm
L 8.7 x W 8.7 x H 2.2 in

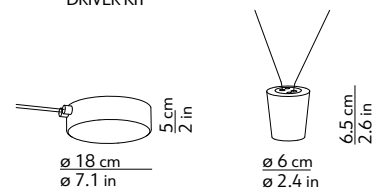

black RAL9005

DRIVER KIT

SPILLO SUSPENSION

CONSTANTIN WORTMANN

EN. Fluid, light design. A drop of light that can be multiplied at will to create ever-changing effects. Unique atmospheres for stunning contract interiors. The outdoor model creates evocative atmospheres with its elegance and exclusiveness.

IT. Design fluido e leggero. Una goccia di luce da moltiplicare a piacere per creare effetti sempre diversi. At-

mosfere uniche per interni contract di grande effetto. Con la sua eleganza e semplicità, il modello outdoor crea suggestive atmosfere.

FR. Design fluide et léger. Une goutte de lumière à multiplier au plaisir pour créer des effets toujours différents. Atmosphères uniques pour des intérieurs contract de grand effet. Avec son élégance et sa simplicité, le mo-

dèle pour l'extérieur crée des atmosphères suggestives.

D. Fließendes und leichtes Design. Ein Tropfen des Lichts, der nach Belieben vervielfacht wird, um stets neue Effekte entstehen zu lassen. Einzigartige Atmosphären für wirkungsvolle Innenräume im Contract-Bereich. Mit seiner Eleganz und Einfachheit lässt auch das Outdoormodell wunderbare

Atmosphären entstehen.

ES. Diseño fluido y ligero. Una gota de luz para multiplicar a placer para crear efectos siempre diferentes. Atmosferas únicas para espacios comerciales interiores de gran efecto. Con su elegancia y simplicidad, el modelo de exterior recrea atmósferas sugestivas.



SPILLO SUSPENSION



CODE	COLOUR	PRICE VAT excl.
SPILLO SUSPENSION 232135EU	white	390 €
SPILLO OUTDOOR SUSP. 232135IPEU	white	355 €

LIGHT SOURCE*

1x21W max - E27 (E26)
Ø 5cm max

FEEDING

220-240 / 120 V

DIMMABLE

yes

LIGHT DIRECTION



CERTIFICATIONS

SPILLO SUSPENSION

⊕ IP20 CE ENEC

SPILLO OUTDOOR SUSPENSION

⊠ IP65 CE ENEC

MATERIALS

polyethylene + metal

CABLE LENGTH

180 cm / 70.9 in

CANOPY

SPILLO SUSPENSION

white

SPILLO OUTDOOR SUSPENSION

IP 65 connector

PACKAGING

BOX 1

gross w. 2.44 kg / 5.37 lbs

vol. 0.047 m³ / 1.647 ft³

dim. L 26 x W 26 x H 69 cm

L 10.2 x W 10.2 x H 27.2 in

SPILLO SUSP.

SPILLO OUTDOOR SUSP.



white



white + black cable

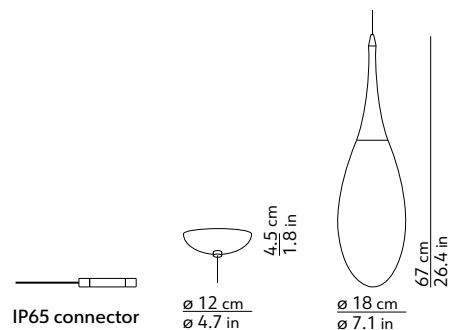

TOOT SUSPENSION

KARIM RASHID

EN. The atmosphere of the Sixties and contemporary rhythm. Three-dimensional elements arranged at different heights create a play on light and movement. The suspended model combines movement with a dramatic look. An original element with a powerful decorative effect to add an extra touch of style to communal spaces and home interiors.

IT. Atmosfere anni '60 e ritmo contemporaneo. Volumi tridimensionali

disposti ad altezze diverse creano giochi di luce e movimento. Il modello a sospensione unisce dinamismo e presenza scenica. Un elemento originale, dal potente effetto decorativo per dare ancora più stile agli spazi collettivi e all'interior della casa.

FR. Atmosphère des années 60 et rythme contemporain. Des volumes tridimensionnels disposés à des hauteurs différentes créent des jeux de lumière et du mouvement. Le modèle en sus-

sension unit dynamisme et présence scénique. Un élément original, au puissant effet décoratif pour donner encore plus de style aux espaces collectifs et à l'intérieur de la maison.

D. Atmosphären der 60er-Jahre und moderner Geist. Dreidimensionale Volumen auf verschiedenen Höhen lassen Spiele aus Licht und Bewegung entstehen. Das hängende Modell vereint Dynamik und szenische Präsenz. Ein originelles Element mit besonde-

rer Dekorationswirkung, um Gemeinschaftsräumen und Wohnräumen noch mehr Stil zu verleihen.

ES. Atmosferas Años 60 y ritmo contemporáneo. Volúmenes tridimensionales colocados en diferentes alturas crean juegos de luz y movimiento. El modelo en suspensión une dinamismo y presencia escénica. Un elemento original, con un potente efecto decorativo para aún más estilo a los espacios comunes y al interior de la casa.



TOOT SUSPENSION



CODE	COLOUR	PRICE VAT excl.
K401335	mixed colours	1450 €

LIGHT SOURCE*

board LED 3x5W
2700 K - 1500 lm - CRI>90

FEEDING

100-240 V

DIMMABLE

1-10V or push

LIGHT DIRECTION**CERTIFICATIONS**

⊕ IP20 CE ENEC

MATERIALS

plexiglas + metal

CABLE LENGTH

180 cm / 70.9 in

CANOPY

black RAL9005

PACKAGING**BOX 1**

gross w. 3.2 kg / 7.04 lbs

vol. 0.033 m³ / 1.171 ft³

dim. L 27 x W 27 x H 45.5 cm
L 10.7 x W 10.7 x H 17.9 in

BOX 2

gross w. 3.52 kg / 7.74 lbs

vol. 0.033 m³ / 1.171 ft³

dim. L 27 x W 27 x H 45.5 cm
L 10.7 x W 10.7 x H 17.9 in



mixed colours

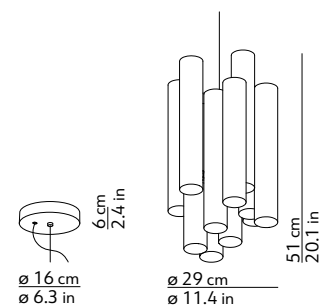

TRIPOD SUSPENSION

CHRISTOPHE PILLET

EN. Purity of shapes, colours and materials. Soft, warm light. The suspended lampshade is an elegant, abstract interpretation. Lightweight and aerial, it floats in space. A perfect encounter between tradition and contemporary design.

IT. Purezza di forme, colori e materiali. Luce calda e soffusa. Il paralume

a sospensione in un'elegante interpretazione astratta. Leggero e aereo galleggia nello spazio. Un incontro perfetto fra tradizione e design contemporaneo.

FR. Pureté des formes, des couleurs et des matières. Lumière chaude et tamisée. L'abat-jour en suspension dans une interprétation élégante et abstrai-

te. Légère et aérienne, elle flotte dans l'espace. Une rencontre parfaite entre tradition et design contemporain.

D. Reinheit der Formen, Farben und Materialien. Warmes und diffuses Licht. Der hängende Lampenschirm in einer elegant-abstrakten Interpretation. Leicht und luftig pendelt die Lampe im Raum. Ein perfektes Aufei-

nandertreffen zwischen Tradition und modernem Design.

ES. Pureza de formas, colores y materiales. Luz cálida y tenue. La pantalla en suspensión es una elegante interpretación abstracta. Ligero y aéreo parece flotar en el espacio. Un encuentro perfecto entre la tradición y el diseño contemporáneo.



TRIPOD SUSPENSION



CODE	COLOUR	PRICE VAT excl.
223945BIEU	white	660 €
223945ECEU	ecrù	
223945MOEU	moka	

LIGHT SOURCE*

3x70W max - E27 (E26)

FEEDING

220-240 / 120 V

DIMMABLE

yes

LIGHT DIRECTION



CERTIFICATIONS

⊕ IP20 CE ENEC

MATERIALS

metal + fabric

CABLE LENGTH

180 cm / 70.9 in

CANOPY

white

PACKAGING

BOX 1

gross w. 5.32 kg / 11.7 lbs

vol. 0.119 m³ / 4.195 ft³

dim. L 60 x W 60 x H 33 cm

L 23.6 x W 23.6 x H 13 in

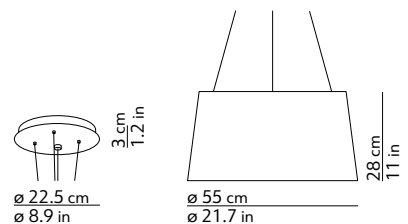

VICEVERSA

NOÉ DUCHAUFOUR LAWRENCE

EN. Light/nature. Structure/life. Sculpture/movement. Viceversa. Multiple readings for a unique object. A simple rotation and the suspended lamp suddenly makes space for plant elements. Bright vertical gardens take shape. Dreamlike and vibrant scenes, which reconnect the inhabited space with the breath of greenery.

IT. Luce/natura. Struttura/vita. Scultura/movimento. Viceversa. Molteplici letture per un oggetto unico. Una

semplice rotazione e la lampada a sospensione può accogliere a sorpresa elementi vegetali. Prendono forma luminosi giardini verticali. Scenografie oniriche e vibranti, che riconnettono lo spazio abitato con il respiro del verde.

FR. Lumière/nature. Structure/vie. Sculpture/mouvement. Vice-versa. De multiples lectures pour un objet unique. Une simple rotation et la suspension peut accueillir par surprise des éléments végétaux. Pour prendre

ainsi la forme de jardins verticaux lumineux. Des décors oniriques et vibrants, qui reconnectent l'espace habité au le souffle de la verdure.

D. Licht/Natur. Struktur/Leben. Skulptur/Bewegung. Viceversa. Vielfältige Interpretationen für ein einzigartiges Objekt. Eine einfache Drehung und die Hängeleuchte kann mit Pflanzenelementen überraschen. Helle vertikale Gärten nehmen Gestalt an. Traumhafte und lebendige Szeno-

graphien, die den Wohnraum wieder mit einem Hauch von Grün verbinden.

ES. Luz/naturaleza. Estructura/vida. Escultura/movimiento. Viceversa. Múltiples lecturas para un único objeto. Una simple rotación y la lámpara colgante puede incorporar por sorpresa elementos vegetales. Toman forma luminosos jardines verticales. Escenografías oníricas y vibrantes, que reconectan el espacio habitado con la respiración del verde.





CODE	COLOUR	PRICE VAT excl.
VICEVERSA K370280GA K370280GF	amber smokey grey	1200 €
VICEVERSA 2 K370281GA K370281GF	amber smokey grey	2100 €

LIGHT SOURCE*

VICEVERSA

board LED 9W
2700 K - 800 lm - CRI>90

VICEVERSA 2

board LED 16.5W
2700 K - 1600 lm - CRI>90

FEEDING

110-240 V

DIMMABLE

1-10V

LIGHT DIRECTION



CERTIFICATIONS

⊕ IP20** CE ENEC

MATERIALS

glass + metal

CABLE LENGTH

180 cm / 70.9 in

CANOPY

grey RAL7016

** canopy IP20
structure built in compliance
with IP54 specifications

PACKAGING

VICEVERSA BOX 1

VICEVERSA 2 BOX 1 - BOX 2

gross w. 2.3 kg / 5.06 lbs
vol. 0.031 m³ / 1.090 ft³
dim. L 29 x W 28 x H 38 cm
L 11.4 x W 11 x H 15 in

VICEVERSA BOX 2

VICEVERSA 2 BOX 3 - BOX 4

gross w. 3.92 kg / 8.62 lbs
vol. 0.027 m³ / 0.967 ft³
dim. L 83 x W 33 x H 10 cm
L 32.7 x W 13 x H 3.9 in

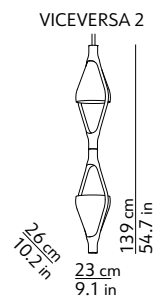
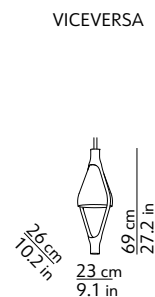
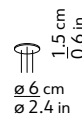
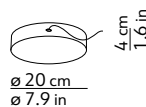

YUMA

DAVID POMPA

EN. The Yuma desert stretches between the USA and northern Mexico and is revived in the design culture of the designer, David Pompa. The polished brass body of the lamp constantly reflects and changes everything around it, conjuring up the dunes that disappear into infinity, never alike. The magic of oases and mirages returns in the refraction of the rough, textured glass.

IT. Il deserto di Yuma si estende fra gli USA e il nord del Messico e rivive nella cultura progettuale del designer David Pompa. Il corpo in ottone lucido

della lampada riflette e modifica di continuo ciò che sta attorno, evocando le dune che si perdono all'infinito, mai uguali a sé stesse. La magia di oasi e miraggi torna nelle rifrazioni del vetro, grezzo e materico.

FR. Le désert de Yuma s'étend entre les États-Unis et le nord du Mexique et revit dans la culture conceptuelle du designer David Pompa. Le corps en laiton brillant de la lampe reflète et modifie en continu ce qui se trouve autour, évoquant les dunes qui se perdent à l'infini, mais égales à elles-mêmes. La magie d'oasis et de

mirages revient dans les réfractions du verre, brute et de la matière.

D. Die Wüste Yuma erstreckt sich über die USA und den Norden Mexikos und lebt in der projektplanerischen Kultur des Designers David Pompa auf. Der Korpus der Lampe aus glänzendem Messing spiegelt seine Umgebung wider und verändert sie kontinuierlich. Gleichzeitig erinnert er an die Dünen, die sich in der Unendlichkeit verlieren und alle gleich aussehen. Die Magie der Oasen und Wunder ist in den Lichtbrüchen im Glas zu erkennen, roh und materiell.

ES. El desierto de Yuma se extiende entre EE.UU y el norte de México y revive en la cultura proyectiva del diseñador David Pompa. El cuerpo de latón brillante de la lámpara refleja y modifica de manera continua lo que se encuentra a su alrededor, evocando dunas que se pierden en el infinito pero que nunca son iguales entre ellas. La magia de oasis y espejismos regresa en las refracciones del cristal, de aspecto tosco y matérico.





CODE	COLOUR	PRICE VAT excl.
370310EU	brass	380 €

LIGHT SOURCE*

1x20W max - E27 (E26)

FEEDING

220-240 / 120 V

DIMMABLE

yes

LIGHT DIRECTION**CERTIFICATIONS**

⊕ IP20 CE ENEC

MATERIALS

glass + metal

CABLE LENGTH

180 cm / 70.9 in

CANOPY

brass 307

PACKAGING**BOX 1**

gross w. 1.78 kg / 3.92 lbs

vol. 0.012 m³ / 0.426 ft³dim. L 30.5 x W 25.5 x H 15.5 cm
L 12 x W 10 x H 6.1 in

brass 307

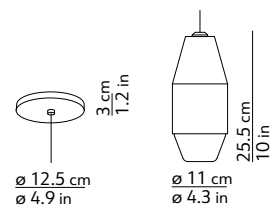

ATOMIUM WALL

HOPF&WORTMANN - BÜRO FÜR FORM

EN. The design explores the structure of matter and translates the atom into an astonishing luminous body. A decorative and functional object that diffuses a multidirectional and atmospheric light.

IT. Il design esplora la struttura della

materia e traduce l'atomo in sorprendente corpo luminoso. Un oggetto decorativo e funzionale, che diffonde una luce multidirezionale e d'atmosfera.

FR. Le design explore la structure de la matière et traduit l'atome en un corps lumineux surprenant. Un objet

décoratif et fonctionnel qui diffuse une lumière multidirectionnelle et de grande atmosphère.

D. Das Design erforscht die Struktur der Materie und übersetzt das Atom in einen überraschenden Leuchtkörper. Ein dekoratives und funktionales

Objekt, das ein multidirektionales und atmosphärisches Licht verbreitet.

ES. El diseño explora la estructura de la materia y traduce el átomo en un sorprendente cuerpo luminoso. Un objeto decorativo y funcional que difunde una luz multidireccional y de atmósfera.



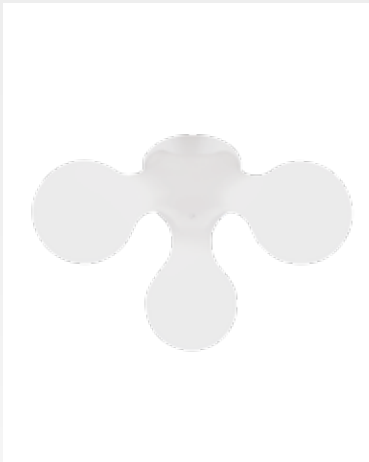

CODE	COLOUR	PRICE VAT excl.
011891BIEU	white	420 €

LIGHT SOURCE*

3x40W max - E14 (E12)

FEEDING

220-240 / 120 V

DIMMABLE

yes

LIGHT DIRECTION**CERTIFICATIONS**

⊕ IP20 CE ENEC

MATERIALS

polyethylene

PACKAGING**BOX 1**

gross w. 5.16 kg / 11.35 lbs

vol. 0.099 m³ / 3.493 ft³

dim. L 59.5 x W 54.5 x H 30.5 cm

L 23.4 x W 21.5 x H 12 in



white

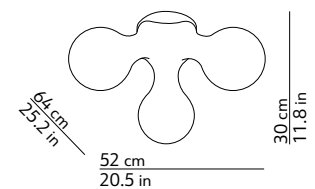

AZOU

CHRIS BASIAS

EN. Exploring space and marking off the next steps on a journey that always has something to recount. Each point of light is connected to the next one by a slender thread, tracing unexpected paths. Azou always draws different maps. An infinite number of compositions to make a bold statement and add a touch of poetry to interior design.

IT. Esplorare lo spazio e segnare le prossime tappe di un viaggio che ha sempre qualcosa da raccontare. Ogni

punto luminoso si collega all'altro tramite un filo sottile, tracciando percorsi inaspettati. Azou disegna mappe sempre diverse. Infinite composizioni possibili, per dare carattere e poesia alla progettazione d'interni.

FR. Explorer l'espace et marquer les prochaines étapes d'un voyage qui a toujours quelque chose à raconter. Chaque point lumineux est relié à l'autre grâce à un fil fin, traçant des parcours inattendus. Azou dessine des cartes toujours différentes. D'infinies

compositions possibles, pour donner du caractère et de la poésie à la conception d'intérieurs.

D. Den Raum erkunden und die nächsten Etappen einer Reise markieren, von der es viel zu erzählen gibt. Jeder Lichtpunkt ist mit dem anderen über einen dünnen Draht verbunden, sodass unerwartete Wege entstehen. Azou erschafft stets neue Landkarten. Unendliche Kombinationsmöglichkeiten, um der Projektplanung von Innenräumen Charakter und Poesie zu verleihen.

ES. Explorar el espacio y marcar las próximas etapas de un viaje que tiene siempre algo nuevo por contar. Cada punto luminoso está conectado al otro a través de un cable muy fino, como si trazara etapas inesperadas. Azou diseña siempre mapas diferentes. Infinitas composiciones posibles, para dar carácter y poesía al diseño de interiores.





CODE	COLOUR	PRICE VAT excl.
K3454113MB	white marble	720 €
K3454113MN	black marble	
K3454113MO	green onyx	1140 €
OPTIONAL		
345-PLUGEU / GB	driver + dimmer + plug	160 €
500515N**	black canopy	115 €
ALI-0003	driver dim. 1-10V or push	105 €

**driver not included

LIGHT SOURCE*

board LED 3x4.2W
2700 K - 1350 lm - CRI>90

FEEDING

220-240 / 120 V

DIMMABLE

yes

LIGHT DIRECTION



CERTIFICATIONS

⊕ IP20 CE ENEC

DRIVER + DIMMER + PLUG

⊞ IP20 CE ENEC

MATERIALS

metal + marble or onyx

PACKAGING

BOX 1

gross w. 1.6 kg / 3.52 lbs
vol. 0.007 m³ / 0.243 ft³
dim. L 24.5 x W 17 x H 16.5 cm
L 9.7 x W 6.7 x H 6.5 in

BOX 2

gross w. 1.3 kg / 2.86 lbs
vol. 0.009 m³ / 0.314 ft³
dim. L 38.5 x W 21 x H 11 cm
L 15.2 x W 8.3 x H 4.3 in



white marble



black marble



green onyx

CANOPY

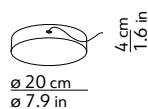

DRIVER+DIMMER+PLUG

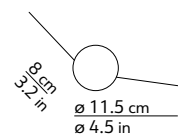

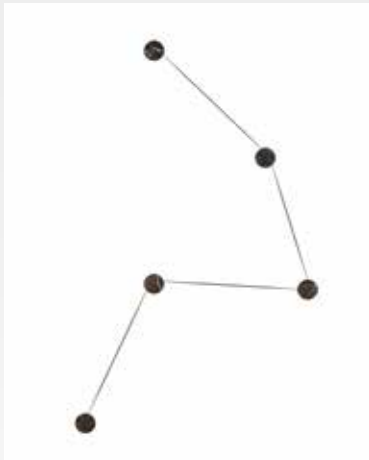

CODE	COLOUR	PRICE VAT excl.
K3454115MB	white marble	990 €
K3454115MN	black marble	
K3454115MO	green onyx	1650 €
OPTIONAL		
345-PLUGEU / GB	driver + dimmer + plug	160 €
500515N**	black canopy	115 €
ALI-0003	driver dim. 1-10V or push	105 €

**driver not included

LIGHT SOURCE*

board LED 5x4.2W
2700 K - 2250 lm - CRI>90

FEEDING

220-240 / 120 V

DIMMABLE

yes

LIGHT DIRECTION



CERTIFICATIONS

⊕ IP20 CE ENEC

DRIVER + DIMMER + PLUG

⊞ IP20 CE ENEC

MATERIALS

metal + marble or onyx

PACKAGING

BOX 1

gross w. 2.68 kg / 5.9 lbs

vol. 0.012 m³ / 0.434 ft³

dim. L 48 x W 16 x H 16 cm

L 18.9 x W 6.3 x H 6.3 in

BOX 2

gross w. 1.84 kg / 4.05 lbs

vol. 0.009 m³ / 0.314 ft³

dim. L 38.5 x W 21 x H 11 cm

L 15.2 x W 8.3 x H 4.3 in



white marble



black marble



green onyx

CANOPY

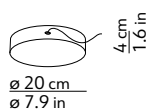

DRIVER+DIMMER+PLUG

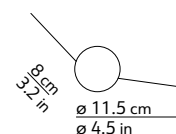



CODE	COLOUR	PRICE VAT excl.
K3454117MB	white marble	1350 €
K3454117MN	black marble	
K3454117MO	green onyx	2350 €
OPTIONAL		
345-PLUGEU / GB	driver + dimmer + plug	160 €
500515N**	black canopy	115 €
ALI-0003	driver dim. 1-10V or push	105 €

**driver not included

LIGHT SOURCE*

board LED 7x4.2W
2700 K - 3150 lm - CRI>90

FEEDING

220-240 / 120 V

DIMMABLE

yes

LIGHT DIRECTION



CERTIFICATIONS

⊕ IP20 CE ENEC

DRIVER + DIMMER + PLUG

⊠ IP20 CE ENEC

MATERIALS

metal + marble or onyx

PACKAGING

BOX 1

gross w. 3.02 kg / 6.64 lbs

vol. 0.012 m³ / 0.434 ft³

dim. L 48 x W 16 x H 16 cm

L 18.9 x W 6.3 x H 6.3 in

BOX 2

gross w. 2.32 kg / 5.104 lbs

vol. 0.009 m³ / 0.314 ft³

dim. L 38.5 x W 21 x H 11 cm

L 15.2 x W 8.3 x H 4.3 in



white marble



black marble



green onyx

CANOPY

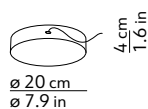

DRIVER+DIMMER+PLUG

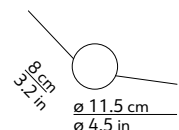

FRAME

BENJAMIN HUBERT

EN. Frame surrounds the light, diffusing it on the walls and enhancing it. Austere architectural design for a linear and compact wall light. Purity, solidity and lightness are the result of an extensive research project and production.

IT. Frame incornicia la luce, la diffonde sulla parete e la valorizza. Rigore

architettonico per un'applicare lineare e compatta. Purezza, solidità e leggerezza sono il risultato di un lungo lavoro di ricerca progettuale e produttiva.

FR. Frame encadre la lumière, la diffuse sur le mur et la valorise. Rigueur architectonique pour une applique linéaire et compacte. Pureté, solidité e légèreté sont le résultat d'un long travail de

recherche conceptuel de production.

D. Frame fängt das Licht ein, verteilt es an der Wand und setzt es in Szene. Architektonische Strenge für einen linearen und kompakten Wandleuchter. Reinheit, Festigkeit und Leichtigkeit sind das Ergebnis einer langen projektplanerischen und produktionsbezogenen Forschungsarbeit.

ES. Frame enmarca la luz, la difunde en la pared y la resalta. Precisión arquitectónica para una aplicación lineal y compacta. Pureza, solidez y ligereza son el resultado de un largo trabajo de investigación proyectiva y de producción.





CODE	COLOUR	PRICE VAT excl.
145050B	white	281 €
145050C	chrome	329 €

LIGHT SOURCE*

1x150W max - R7s - L 78 mm

FEEDING

220-240 / 120 V

DIMMABLE

yes

LIGHT DIRECTION**CERTIFICATIONS**

⊕ IP20 CE ENEC

MATERIALS

aluminium

PACKAGING**BOX 1**

gross w. 1.42 kg / 3.12 lbs
 vol. 0.007 m³ / 0.257 ft³
 dim. L 40.5 x W 36 x H5 cm
 L 16 x W 14.2 x H 2 in



white RAL9010



chrome

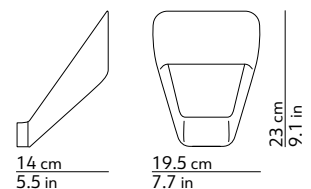

NAMI WALL

ALBERTO SAGGIA & VALERIO SOMMELLA

EN. Elegant and mysterious. A wave of glass and light emerges from an essential metal element. Precious grooves reveal multiple light refractions. Nami, "wave" in Japanese, unleashes the reflections of the sea in a continuous play of perspectives. Now also in the functional wall-mounted version, alongside the suspended model.

IT. Elegante e misteriosa. Un'onda di vetro e di luce affiora da un essenziale elemento in metallo. Preziose scan-

lature lasciano trasparire molteplici rifrazioni luminose. Nami, "onda" in giapponese, sprigiona i riflessi del mare in un continuo gioco di prospettive. Ora anche nella funzionale versione applique, accanto al modello a sospensione.

FR. Élégante et mystérieuse. Une vague de verre et de lumière émerge d'un élément essentiel en métal. De précieuses rainures laissent transparaître de multiples reflets lumineux.

Nami, "vague" en japonais, libère les reflets de la mer dans un jeu continu de perspectives. Maintenant disponible en version applique, en plus du modèle en suspension.

D. Elegant und geheimnisvoll. Aus einem essentiellen Metallelement entspringt eine Welle aus Glas und Licht. Edle Rillen erzeugen mehrfache Lichtbrechungen. Nami, "Welle" auf Japanisch, setzt die Lichtreflexe des Meeres in einem kontinuierlichen Spiel

der Perspektiven frei. Jetzt auch in der Ausführung als funktionelle Wandleuchte, neben dem Hängemodell.

ES. Elegante y misteriosa. Una onda de vidrio y de luz florece de un elemento esencial de metal. Preciosas ranuras dejan resaltar múltiples refracciones luminosas. Nami, "onda" en japonés, emana los reflejos del mar en un continuo juego de perspectivas. Ahora también en la funcional versión de aplique, junto al modelo colgante.





CODE	COLOUR	PRICE VAT excl.
K340406N	black	281 €
K340406O	brass	

LIGHT SOURCE*

board LED 1x12W
2700 K - 1750 lm - CRI>90

FEEDING

220-240 / 120 V

DIMMABLE

phase cut

LIGHT DIRECTION**CERTIFICATIONS**

⊕ IP20 CE ENEC

MATERIALS

glass + aluminium

PACKAGING**BOX 1**

gross w. 0.93kg / 2.05 lbs
vol. 0.011 m³ / 0.371 ft³
dim. L 35 x W 24 x H 12.5 cm
L 13.8 x W 9.5 x H 4.9 in

BOX 2

gross w. 1.07 kg / 2.35 lbs
vol. 0.003 m³ / 0.096 ft³
dim. L 20 x W 13 x H 10.5 cm
L 7.9 x W 5.1 x H 4.1 in



black RAL9005



brass 111

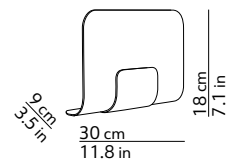

NEW YORK WALL

PETER JAMIESON

EN. A New York touch to the walls with a lamp that plays with the contemporary vintage atmosphere. The lozenge pattern of the diffuser is reminiscent of the covering of the classic hot dog carts found on the streets of The Big Apple.

IT. Un tocco newyorchese alle pareti con una lampada che gioca con atmosfere vintage contemporanee. Il

pattern a losanghe del diffusore riprende il rivestimento dei classici banchetti di hot dog, che si incontrano per le strade della Grande Mela.

FR. Une touche new-yorkaise sur les murs avec une lampe qui joue avec les atmosphères rétro contemporaines. Le motif en losange du diffuseur rappelle le revêtement des stands de

hot-dogs classiques, que l'on trouve dans les rues de la "Big Apple".

D. Ein New Yorker Touch an den Wänden mit einer Lampe, die mit zeitgenössischen Vintage-Atmosphären spielt. Das Rautenmuster des Diffusors erinnert an die klassischen Hot-Dog-Stände, die man in den Straßen des Big Apple findet.

ES. Un toque neoyorquino en las paredes con una lámpara que juega con atmósferas vintage contemporáneas. El diseño de rombos del difusor retoma el revestimiento de las clásicos puestos de perros calientes que se encuentran por las calles de la Gran Manzana.





CODE	COLOUR	PRICE VAT excl.
K090262WB	white	265 €
K090262WC	grey chrome	
K090262WR	red	

LIGHT SOURCE*
1x30W max - E27 (E26)

FEEDING
220-240 / 120 V

DIMMABLE
yes

LIGHT DIRECTION



CERTIFICATIONS
⊕ IP20 CE ENEC

MATERIALS
technopolymer + methacrylate

PACKAGING

BOX 1

gross w. 0.5 kg / 1.1 lbs
vol. 0.003 m³ / 0.121 ft³
dim. L 28 x W 61 x H 2 cm
L 11 x W 24 x H 0.8 in

BOX 2

gross w. 0.76 kg / 1.67 lbs
vol. 0.008 m³ / 0.272 ft³
dim. L 29.5 x W 26 x H 10 cm
L 11.6 x W 10.2 x H 3.9 in

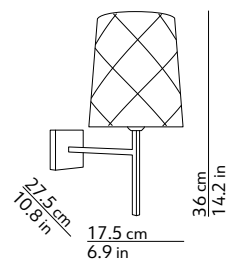

PASTILLA

PATRICIA URQUIOLA

EN. Light becomes a clear-cut, delicate shape. In white or bronze, it punctuates surfaces and interacts with each space, adding new lightness and style to interiors.

IT. La luce diventa volumetria nitida e leggera. In bianco e bronzo, scandisce

le superfici e interagisce con ogni spazio, dando nuova leggerezza e stile agli interni.

FR. La lumière devient volumétrique, nette et légère. En blanc et bronze, elle scande les surfaces et interagit avec chaque espace, en donnant une

nouvelle légèreté et des styles aux espaces intérieurs.

D. Licht wird zu einer klaren und leichten Volumetrie. In Weiß und Bronze werden die Oberflächen betont und die Lampe interagiert mit jedem Raum, indem sie ihm Leichteit

gkeit und Stil verleiht.

ES. La luz se convierte en volumetría nitida y ligera. En color blanco y bronce, escande las superficies e interactúa con cualquier espacio, dando una nueva ligereza y estilo a los ambientes interiores.





CODE	COLOUR	PRICE VAT excl.
218970BIAEU	white	290 €
218970BREU	bronze	

LIGHT SOURCE*

2x42W max - E14 (E12)

FEEDING

220-240 / 120 V

DIMMABLE

yes

LIGHT DIRECTION**CERTIFICATIONS**

⊕ IP20 CE ENEC

MATERIALS

glass + metal

PACKAGING**BOX 1**

gross w. 2.06 kg / 4.53 lbs

vol. 0.011 m³ / 0.401 ft³

dim. L 21 x W 19.5 x H 28 cm

L 8.3 x W 7.7 x H 11 in



white RAL9016



bronze

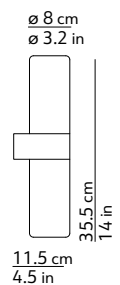

PIXEL

BAKERY GROUP

EN. A matrix element to be replicated at will, to create constantly changing light shapes of all sizes. The project takes inspiration from the digital language of the Seventies when the pixel was used to define the smallest element in an image for the first time. Pioneering atmospheres to play with light in contemporary spaces.

IT. Un elemento-matrice da replicare come si vuole, per costruire forme luminose sempre diverse e di ogni dimensione. Il progetto prende spunto

dal linguaggio digitale degli anni '70, quando il pixel definisce per la prima volta il più piccolo elemento costitutivo dell'immagine. Atmosfere pionieristiche per giocare con la luce negli spazi contemporanei.

FR. Un élément-matrice à répliquer comme on le souhaite, pour construire des formes lumineuses toujours différentes et de n'importe quelle dimension. Le projet s'inspire du langage numérique des années 70, lorsque le pixel définit pour la première fois

le plus petit élément constitutif de l'image. Atmosphères pionnières pour jouer avec la lumière dans les espaces contemporains.

D. Ein Element und eine Matrix, nach Belieben nachzuahmen, um stets unterschiedliche leuchtende Formen jeder Größe entstehen zu lassen. Das Projekt ist inspiriert von der digitalen Sprache der 70er-Jahre, als Pixel zum ersten Mal das kleinste Element eines Bildes darstellt. Bahnbrechende Atmosphären, um in modernen Räumen

mit dem Licht zu spielen.

ES. Un elemento-matriz que se puede reproducir a placer, para construir formas luminosas diferentes y de cualquier tamaño. El proyecto se inspira en el lenguaje digital de los Años 70, cuando el pixel se define por primera vez como el elemento más pequeño que constituye una imagen. Atmosferas primitivas para jugar con la luz en los espacios contemporáneos.



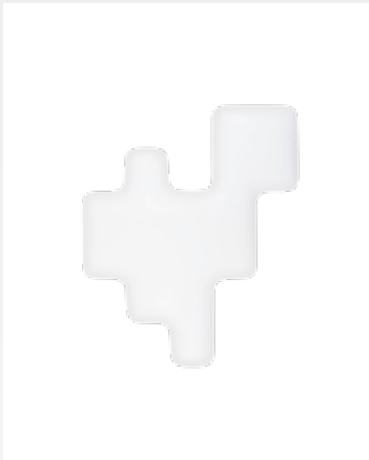

CODE	COLOUR	PRICE VAT excl.
044128BIEU	white	240 €

LIGHT SOURCE*

3x12W max - E14 (E12)

FEEDING

220-240 / 120 V

DIMMABLE

yes

LIGHT DIRECTION



CERTIFICATIONS

⊕ IP20 CE ENEC

MATERIALS

polyethylene + metal

PACKAGING

BOX 1

gross w. 2.1 kg / 4.62 lbs

vol. 0.035 m³ / 1.221 ft³

dim. L 52.5 x W 42.5 x H 15.5 cm

L 20.7 x W 16.7 x H 6.1 in



white

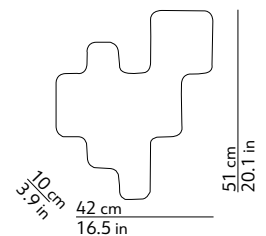

SHAKTI WALL

MARZIO RUSCONI CLERICI

EN. A cylinder and two diagonal cuts at the ends for an object of extreme purity. The light seems to become one with the diffuser. The lamps, if arranged in sequence, add a new sense of rhythm to spaces and walls.

IT. Un cilindro e due tagli diagonali alle estremità per un oggetto di estrema purezza. La luce sembra fondersi

completamente con il diffusore. Le lampade, se ripetute in sequenza, danno nuovo ritmo a spazi e pareti.

FR. Un cylindre et deux coupes diagonales aux extrémités pour un objet d'une très grande pureté. La lumière semble se fondre entièrement avec le diffuseur. Les lampes, si répétées en séquence, donnent un nouveau ryth-

me aux espaces et aux murs.

D. Der Zylinder und zwei diagonale Schnitte an den Enden für einen Gegenstand der besonderen Reinheit. Das Licht scheint komplett mit dem Lampenschirm zu verschmelzen. Die Lampen verleihen bei einer aufeinanderfolgenden Anreihung Räumen und Wänden neuen Rhythmus.

ES. Un cilindro y dos cortes diagonales en los extremos para un objeto de pureza extrema. La luz parece fundirse por completo con el difusor. Las lámparas, si se repiten en secuencia, dan un nuevo ritmo a los espacios y a las paredes.



SHAKTI WALL FIX 80



CODE	COLOUR	PRICE VAT excl.
035341BIEU	white	288 €

LIGHT SOURCE*

1x60W max - E27 (E26)

FEEDING

220-240 / 120 V

DIMMABLE

yes

LIGHT DIRECTION**CERTIFICATIONS**

⊕ IP20 CE ENEC

MATERIALS

plexiglas

PACKAGING**BOX 1**

gross w. 1.2 kg / 2.64 lbs

vol. 0.012 m³ / 0.417 ft³

dim. L 82 x W 12 x H 12 cm

L 32.3 x W 4.7 x H 4.7 in



white

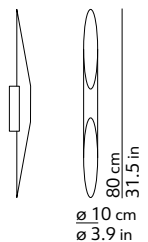

TUA

BEHURT

EN. An elegant synthesis between retro lines and a contemporary, almost futuristic style. Polished metal for the body of the lamp and etched glass for the diffuser, in a carefully balanced contrast. The spherical shape is reminiscent of the Fifties, but renewed by the oblique cut. An eye-catching wall light which fits in perfectly in communal spaces, from restaurants to retail stores.

IT. Una sintesi elegante fra linee retrò e stile attuale, quasi futuribile. Metallo lucido per il corpo della lampada

e vetro acidato per il diffusore, in un contrasto ben calibrato. La forma a sfera cita gli anni '50, ma si rinnova grazie al taglio in obliquo. Un'applicazione di carattere, che si inserisce perfettamente negli spazi collettivi, dalla ristorazione al retail.

FR. Une synthèse élégante entre les lignes rétro et un style actuel, presque futurible. Métal brillant pour le corps de la lampe et verre acide pour le diffuseur, dans un contraste bien équilibré. La forme sphérique rappelle les années 50, mais se renouvelle grâce à

la découpe en oblique. Une applique de caractère, qui s'insère parfaitement dans les espaces collectifs, de la restauration à la vente au détail.

D. Eine elegante Kombination aus Retro-Linien und einem modernen, fast schon zukunftsweisenden Stil. Glänzendes Metall für den Korpus der Lampe und geätztes Glas am Lampenschirm lassen einen gut abgewogenen Kontrast entstehen. Die Kugelform erinnert an die 50er-Jahre, erscheint aber durch den schrägen Schnitt neu. Eine charaktervolle Wan-

dleuchte, die perfekt in Räume der Gemeinschaft passt - vom Restaurant bis zum Handelsbetrieb.

ES. Una síntesis elegante entre líneas retro y estilo actual, casi futurista. Metal brillante para el cuerpo de la lámpara y cristal acidato para el difusor, creando un contraste bien calibrado. La forma esférica evoca los Años 50 pero se renueva gracias al corte en oblicuo. Una aplicación de carácter, que se introduce a la perfección en los espacios comunes: de la gastronomía a la venta al detalle.





CODE	COLOUR	PRICE VAT excl.
100266SNNL	black tin	390 €

LIGHT SOURCE*

1x100W max - R7s - L 78 mm

FEEDING

220-240 / 120 V

DIMMABLE

yes

LIGHT DIRECTION**CERTIFICATIONS**

⊕ IP20 CE ENEC

MATERIALS

glass + metal

PACKAGING**BOX 1**

gross w. 1.26 kg / 2.77 lbs

vol. 0.012 m³ / 0.419 ft³

dim. L 22 x W 22 x H 24.5 cm



L 8.7 x W 8.7 x H 9.7 in

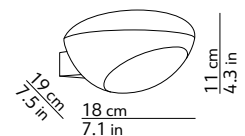

black tin

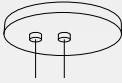

ACCESSORIES

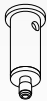
ACCESSORIES	CODE	COLOUR	PRICE VAT excl.
2 HOLES CANOPY 	500521CR	chrome	65 €
	500521N	black	
	500521O	brass 307	
	500521B	white	
DECENTRALIZER 	500518CR	chrome	26 €
	500518N	black	
	500518O	brass 307	
	500518B	white	
DECENTRALIZER HOOK 	500519N	black	15 €
	500519B	white	
WIRE GRIPLOCK 	500520CR	chrome	15 €
	500520N	black	
	500520B	white	

SPECIAL CANOPIES

SPECIAL CANOPIES *

* illustrative examples

It is possible to ask for quotes for different shapes, sizes and finishing according to your needs. Thanks to the technical and commercial support of the company, all needs can be met, customising each and every aspect of the project with great flexibility.

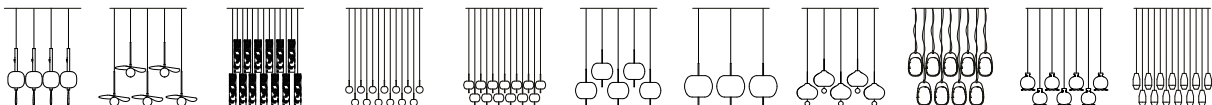
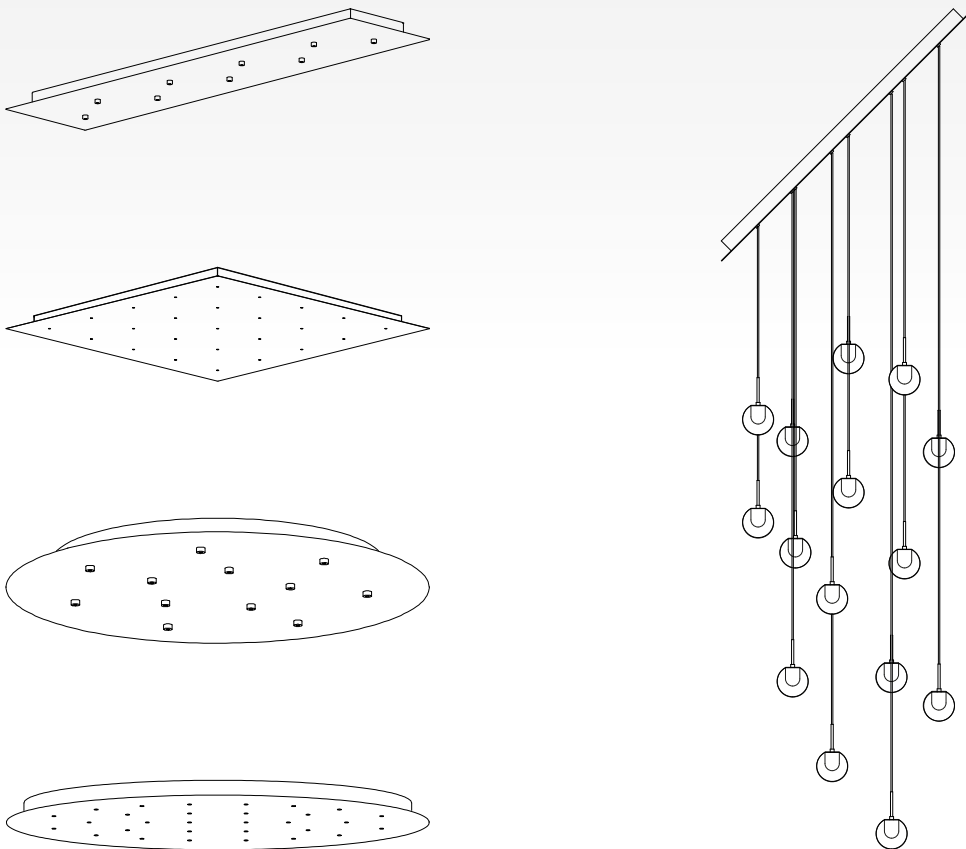

GRAPHIC PROJECT

VZNstudio

Printed in Italy

Industrie Grafiche Pacini, April 2023

kdln is a registered trademark

Copyright © 2023 Kdln Srl

All Rights Reserved.

Reproduction in whole or in part of texts and images
without express written permission is prohibited.



Viale L. da Vinci, 277
20090 Trezzano sul Naviglio, Milano
T. +39 0236538950 info@kdln.it

Registered office
Viale F. Crispi, 5/A 20121 Milano
IT11792050152

kdln.it

