

OUTDOOR







UNI EN ISO 9001- 2008
cert. n°9105 ARTM



INDEX for family

CIULIFRULI Pag. 4



TRILLY Pag. 10



BOWL Pag. 14



GLOUGLOU POL Pag. 18

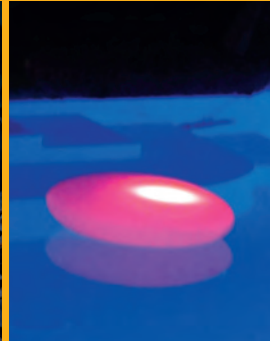

BICONICA POL Pag. 26



PISTILLO Pag. 30



LALALAMPADA Pag. 32

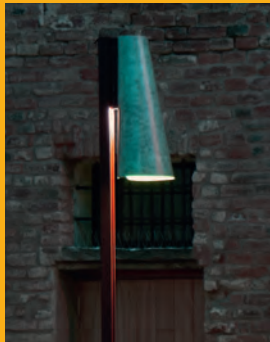

OUT Pag. 34

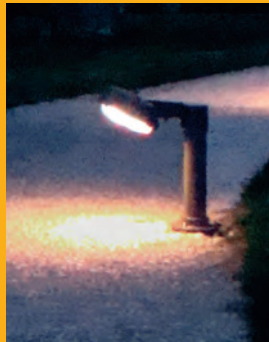

POLO Pag. 38



2250 Pag. 40



LEGENDA

- AZ**  azzurro / light blue / bleu / blau
- BI**  bianco / white / blanc / weiss
- GI**  giallo / yellow / jaune / gelb
- AN**  antracite / anthracite / anthracite / anthrasiz
- RO**  rosso / red / rouge / rot
- VE**  verde / green / vert / grün



martinelli luce
si riserva il diritto di apportare
ai propri modelli in ogni momento
senza nessun preavviso, qualsiasi
modifica ritenesse opportuna.

martinelli luce
reserves the right to introduce
any changes to its own models,
without prior notice.

MADE IN ITALY

OUTDOOR

martinelli luce®



CIULIFRULI



design Studio 5+1 AA e Emiliana Martinelli, 2015

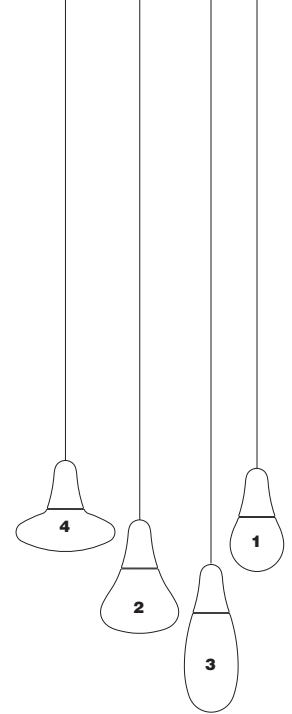

Diffusore bianco
Diffuser white
Diffuseur blanc
Weißer Strahler

30859/BI Ø16 H16 **1**
30860/BI Ø23 H19 **2**
30861/BI Ø16 H29 **3**
30862/BI Ø29 H12,5 **4**

Supporto colorato
con cavo arancione di m 5
e spina cablato per l'esterno.

Coloured support with
an orange cable m 5
and plug wired for outdoor.

Support coloré avec câble
orange et fiche câblé m 5
pour usage extérieur.

Gefärbte Stütze mit
Orangenkabel und m 5
Stecker, versehen mit
Aussenraum-Kabelverbindung.

30858/GI Ø10 H14
30858/AZ Ø10 H14
30858/VE Ø10 H14
30858/RO Ø10 H14
30858/BI Ø10 H14

4 Lampada a sospensione per esterno o interno a luce diffusa, materiale polietilene stampato in rotazionale. Formata da un supporto in 5 colori e da un diffusore bianco intercambiabile in 4 diverse forme e dimensioni. Per lampadina a LED.

Swinging lamp for outdoor or indoor with diffused light made of rotational polyethylene printed material. It consists of a support in 5 colours and in a white interchangeable diffuser in 4 different sizes and shapes. For LED bulb.

IP54



Lampadaire pour usage extérieur ou intérieur avec lumière diffusée, fait en matériel polyéthylène imprimé en rotation. Il est formé par un support en 5 couleurs et par un diffuseur blanc interchangeable en 4 formes et dimensions différentes. Pour ampoule à LED.

Außenraum- oder Innenraum-Pendelleuchtapparat mit gestreutem Licht, aus durch Rotationsformen-Technologie geformte Polyäthylene.
Er es besteht aus einer Stütze in fünf Farben und aus einem weißen auswechselbaren Strahler in vier verschiedenen Formen für Leuchtmittel LED.

1x10W /14W E27 LED A+





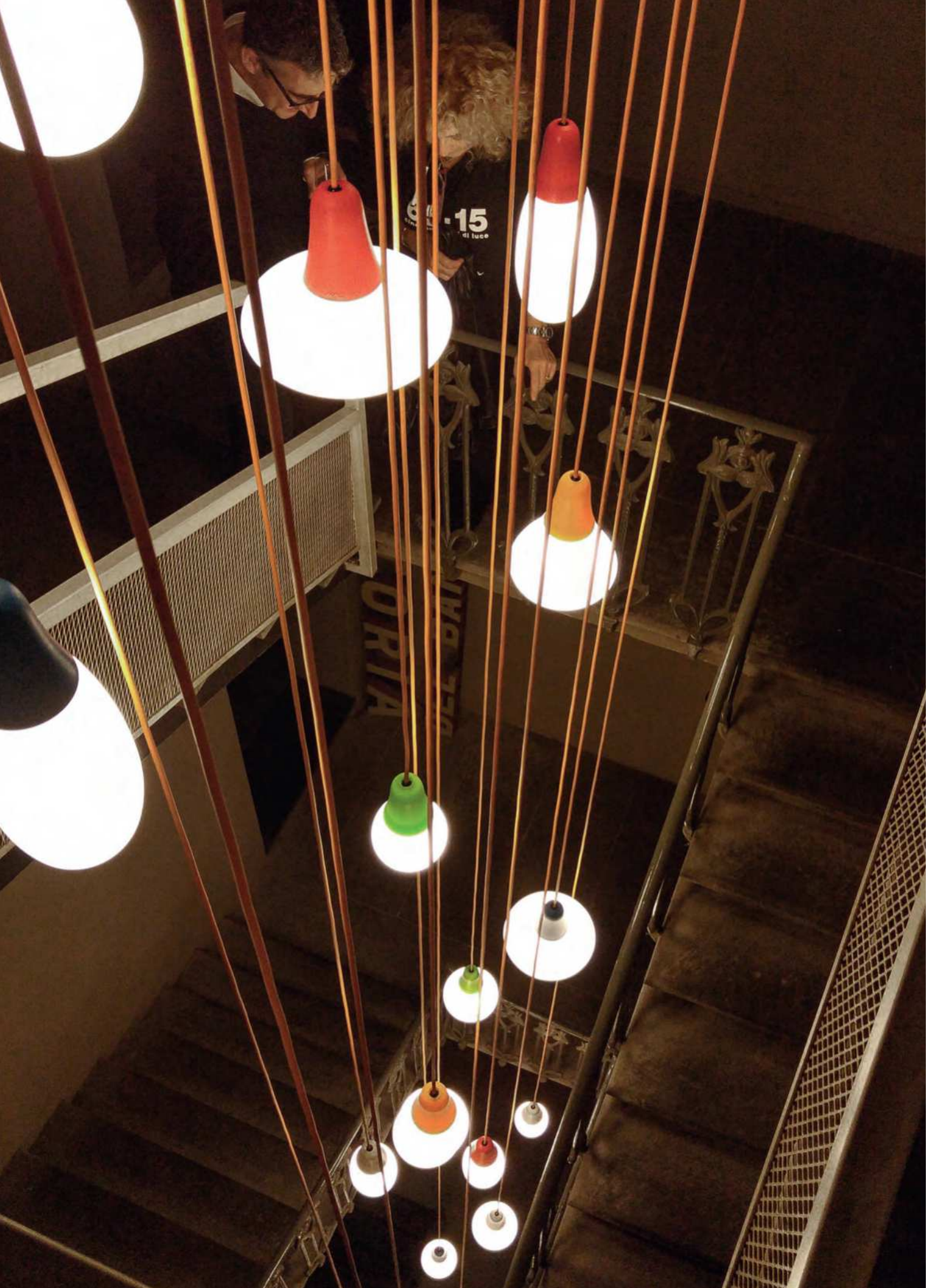





TRILLY



design Emiliana Martinelli, 2011

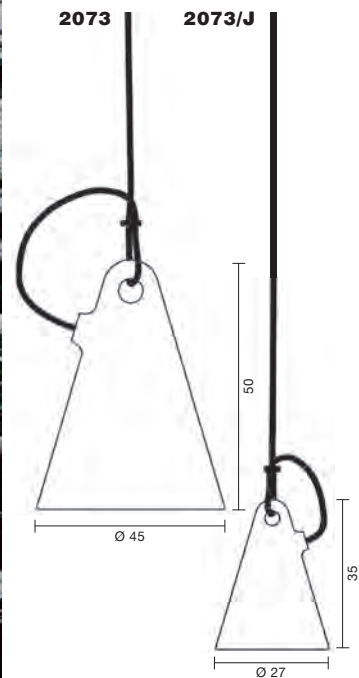

10 Lampada a sospensione, parete o da appoggio per esterno a luce diffusa, struttura in polietilene stampato in rotazionale. Per lampadina a LED, con cavo arancione m 5 e spina da esterno. Disponibile in due misure.

Hanging, wall or ground outdoor lamp, diffused light rotational moulding in polyethylene.
For LED bulb, orange cable m 5 and plug for outdoor.
Available in two sizes.

IP54



Lampe à suspension ou d'appui au sol avec lumière diffuse, moulé par rotation, en polyéthylène blanc pour ampoule à LED.
Avec 5 mètres de câble orange pour l'extérieur et fiche. Deux tailles.

Pendel-, Wand- oder Legelampe für den Außenraum mit gestreutem Licht, Struktur aus durch Rotationsformen-Technologie geformtem Polyäthylén.
Für Leuchtmittel LED mit Orangenkabel 5 m und Außenraum-Stecker.
Es ist in zwei Größen verfügbar.



2073 Ø 45 1x15W E27 LED  A+

2073/J Ø 27 1x6W E14 LED  A+

30837 Gancio per attacco a parete Su richiesta
 Hook for wall mounting On request
 Crochet pour montage mural Sur demande
 Haken für Wandbefestigung Auf Anfrage





BOWL



design Serge & Robert Cornelissen, 2011

14

Lampada da appoggio o interno, a luce diffusa, struttura stampata in rotazionale, materiale polietilene bianco, con particolare maniglia stampata in resina. Cavo arancione m 3 con spina, per lampadina a LED.

Standing Outdoor, or indoor lamp, diffused light, white polyethylene material rotational moulded, with particular support in resin. With orange cable m 3 and plug. For LED bulb.

Lampe de table ou d'appui au sol, pour intérieur et extérieur à lumière diffusée. Diffuseur en polyéthylène, moulé par rotation 3 m de câble orange pour l'extérieur et fiche, pour ampoule à LED.

Außenraum-oder Innenraumlampe, mit gestreutem Licht, durch Rotationsformen-Technologie geformte Struktur aus weißem Polyäthylen, mit besonderem geformtem Harz-Griff. 3 m Orange-Kabel mit Stecker, für Leuchtmittel LED.

IP54



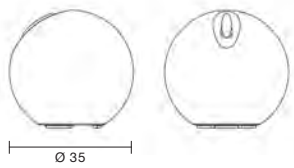

812 Ø 35 1x14W E27 LED  A+





GLOUGLOU POL

design Emiliana Martinelli, 2013

18 Lampada da appoggio per esterno a luce diffusa stampata in rotazionale materiale polietilene bianco. Con cavo arancione 3 m e spina da esterno, per lampadina a LED.

Standing outdoor lamp, diffused light rotational moulded white polyethylene material, with orange cable 3 m and plug for outdoor, for LED bulb.

Lampe a lumière diffusée, moulée par rotation, en polyéthylène blanc, avec câble orange 3 metres et fiche pour l'extérieur. Pour ampoule à LED.

Außenraum-Legelampe mit gestreutem Licht aus weißem durch Rotationsformen-Technologie geformtem Polyethylen. Mit Orangenkabel 3 m und Stecker für Leuchtmittel LED.

IP54



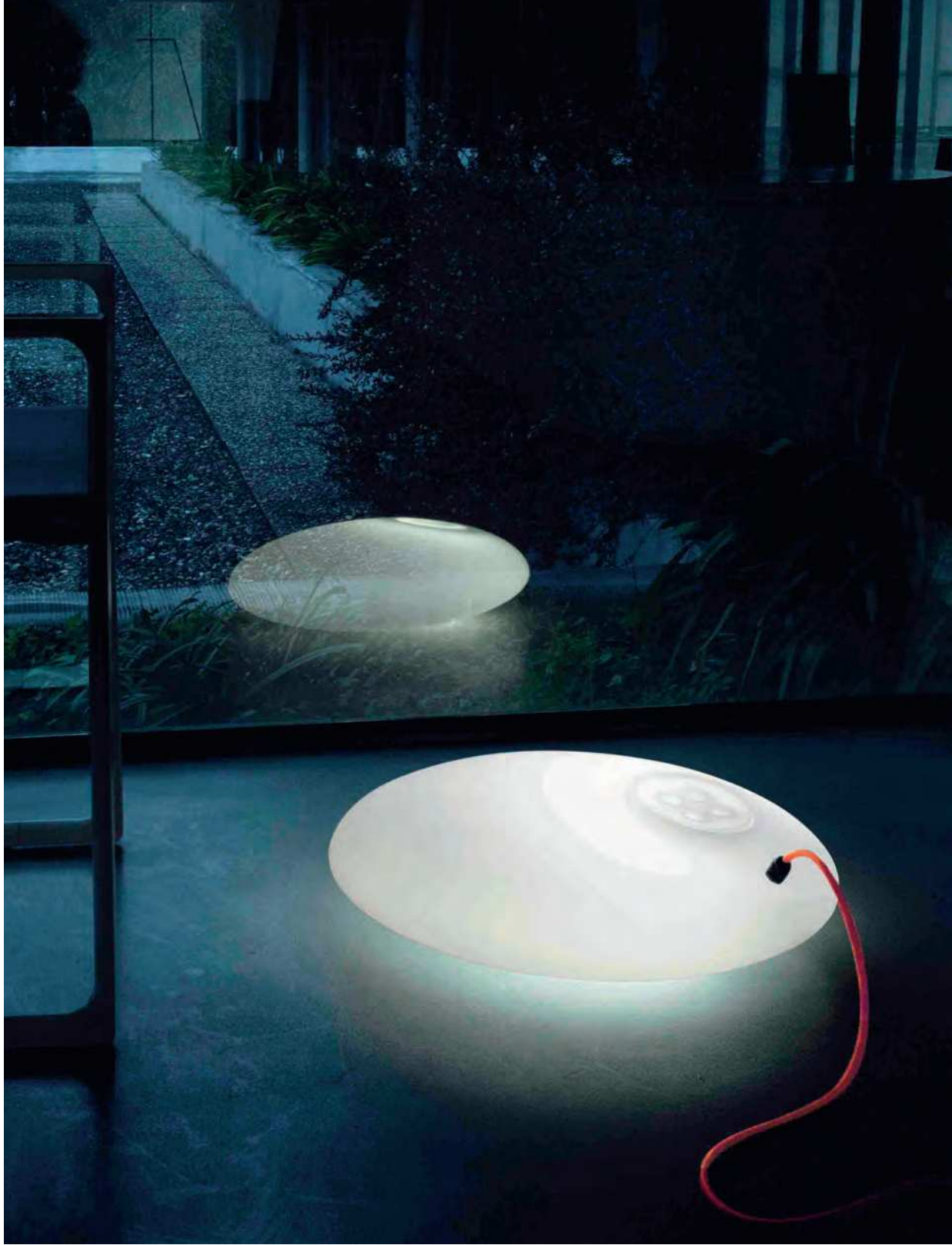
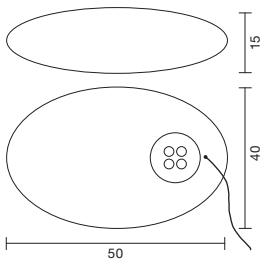

821 40x50x15 1x6W E14 LED  A+



GLOUGLOU POL FLOATING



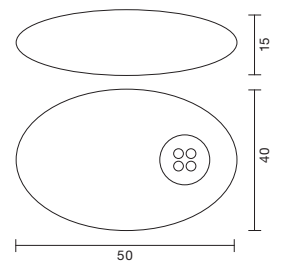

22

Lampada galleggiante per esterno a luce diffusa, stampata in rotazionale materiale polietilene. Per sorgente di luce a LED, batteria inclusa ricaricabile e telecomando, durata 6 ore.

Floating outdoor lamp, diffused light rotational moulded polyethylene material.
For LED light source, rechargeable battery included, and remote control, life 6 hours.

Lampe flottante pour usage extérieur avec lumière diffusée imprimée en rotation en polyéthylène. Sources de lumière LED, batterie rechargeable et télécommandé incluse. Autonomie 6 heures.

Schwimmende Lampe für den Außenraum mit gestreutem Licht, durch Rotationsformen-Technologie geformte Lampe aus Polyäthylen.
Für LED-Lichtquelle, wiederaufladbare Batterie eingeschlossen und Fernsteuerung, 6 stunden.

IP54



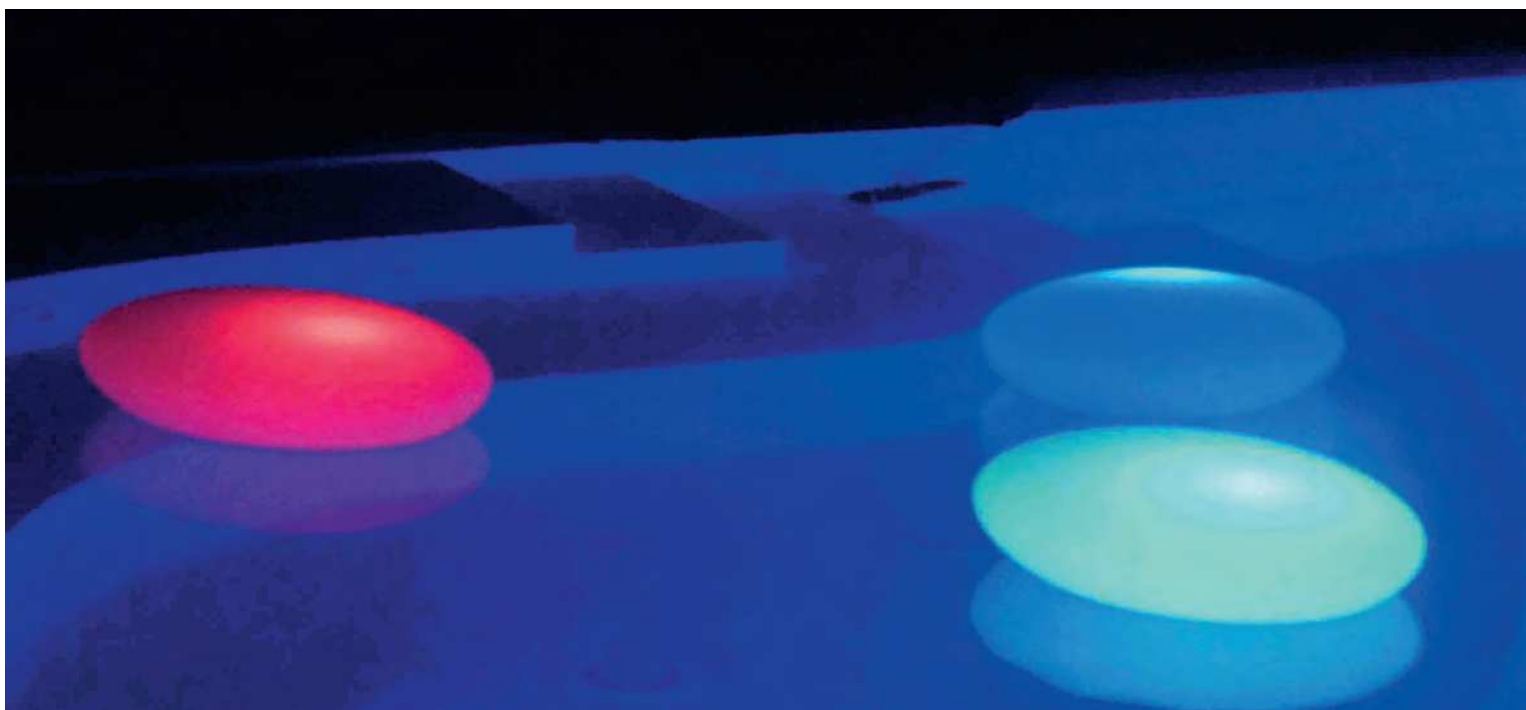

822 40x50x15 1x0,5W LED RGB  A++

Lampada galleggiante con comando remoto
Floating lamp with remote control
Lamp flottante avec télécommande
Schwimmende Lampe mit Fernsteuerung

BICONICA POL



MUSA

MUSEO VIRTUALE
DELLA SCULTURA
E DELL'ARCHITETTURA
VIRTUAL MUSEUM
OF SCULPTURE
AND ARCHITECTURE

design Emiliana Martinelli, 1987- 2011



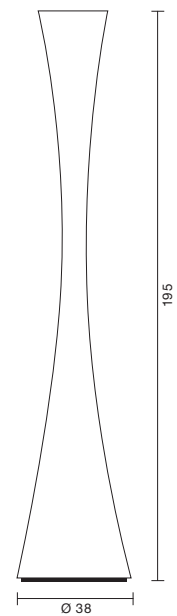

26 Lampada da terra a luce diffusa, struttura stampata in rotazionale, materiale polietilene bianco. Per sorgente di luce a LED integrato nel colore bianco o RGB. Completa di alimentatori dimmerabili e con 3 m di cavo e spina.

Standing lamp, diffused light, rotational moulded, white polyethylene material. For LED light source integrated, white colour or RGB. Complete of dimmable driver and orange cable 3 m with plug for outdoor.

IP54



Lampadaire à lumière diffuse en polyéthylène, moulé par rotation. Avec 3 mètres de câble pour l'extérieur et fiche. Source lumineuse à LED intégrate avec driver dimmerable.

Bodenlampe mit gestreutem Licht, mit durch Rotationsformen-Technologie geformter Struktur, aus weißem Polyäthylen. Für LED-Lichtquelle in der weißen Farbe oder in der RGB-Farbe. Versehen mit Dimmertreiber und mit 3 m Kabel und Außenraumstecker.



2217/POL/P/L/1 28W LED WHITE 2500 lm 3000K  A++
 Con telecomando remoto
 With remote control
 Avec télécommande
 Mit Fernsteuerung

2217/POL/P/L 40W LED RGB 3300 lm  A++
 Con telecomando remoto
 With remote control
 Avec télécommande
 Mit Fernsteuerung



PISTILLO



design Emiliana Martinelli, 2009-2015



30

Apparecchio a sospensione per esterno a luce diffusa, formato da un tubo in metacrilato antiurto opal bianco, con particolari supporti di chiusura e di aggancio stampati in resina nel colore nero. Completo di alimentatori elettronici e cavo arancio, 5 m con spina. Disponibili in tre dimensioni.

Hanging lamp for outdoor, diffused light consisting of a tube in white opal methacrylate antishock, closing and details are in black moulded resin. Complete with electronic ballast and orange cable 5 m with plug. Available in 3 sizes.

IP65



Suspension pour extérieur, à lumière diffuse. Structure en méthacrylate opale blanc, greche et détails en noir. Alimentateur électronique compris, et câble, 5 m avec fiche. Disponible en 3 dimensions.

Außenraum-Pendelleuchtapparat mit gestreutem Licht, es besteht aus einem opalweißen stoßdämpfenden Methakrylat-Rohr, mit besonderen Verschluss-Stützen und Befestigungsstützen aus Harz in der schwarzen Farbe. Versehen mit elektronischen Speisern und 5 m Orangenkabel mit Stecker. Es ist in drei Größen verfügbar.

2064/P

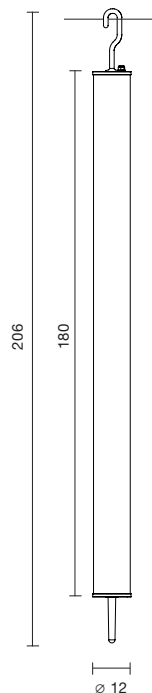

2064/P/J

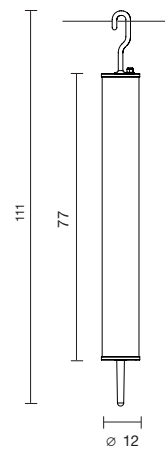

2064/P/XS

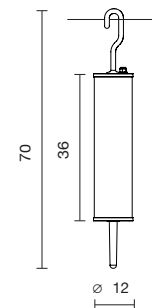

30812

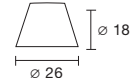

30812/NE Ø 26 H 18

Riflettore in alluminio nero
Black aluminium screen
Écran en aluminium noir
Aluminium Schirm-Reflektor
in der schwarzen Farbe

2064/P

2x35W G5 T5 FL A

2064/P/J

2x21W G5 T5 FL A

2064/P/XS

1x14W E27 LED  A+



2294/L
2294/L/1

2294

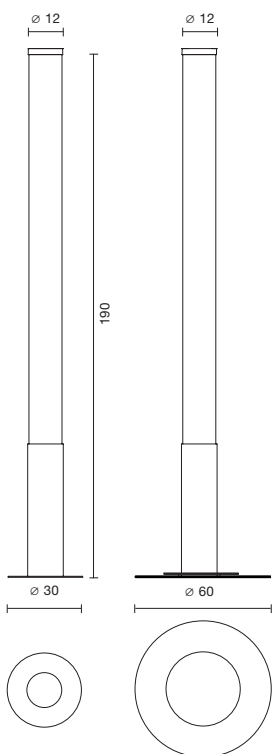

2294/L/DIM
10W LED RGB **LED** A++

2294/L/1/DIM
7W LED WHITE
700 lm 3000K **LED** A++

30870
Base-Lege Ø 60

Pistillo con supporto e base in acciaio da fissare a terra di Ø 30 cm o con base da appoggiare di Ø 60 cm, con cavo arancio 3 m e spina.

Per sorgente di luce a LED bianco o RGB, completo di alimentatore elettronico dimmerabile.

Pistillo with metal support and base in stainless steel of Ø 30 cm to fix to the ground or with base Ø 60 cm to lay on the ground, with orange cable 3 m and plug. For LED light source, complete of electronic dimmable driver.

Pistillo avec support et base en acier à fixer par terre de Ø 30 cm ou avec une base à appuyer de Ø 60 cm, avec 3 mètres de câble orange et fiche.

Pour des sources de lumière à LED blanc ou RGB, équipé d'un alimentateur électrique dimmerable.

Pistillo mit Stahlstütze und Stahlunterlage zur Bodenbefestigung Ø 30 cm oder mit Lege-Unterlage Ø 60 cm, mit Orangenkabel 3 m und Stecker. Für LED-Lichtquelle in der weißen Farbe oder in der RGB-Farbe, versehen mit elektronischem Dimmertreiber.

IP65



LALALAMPADA

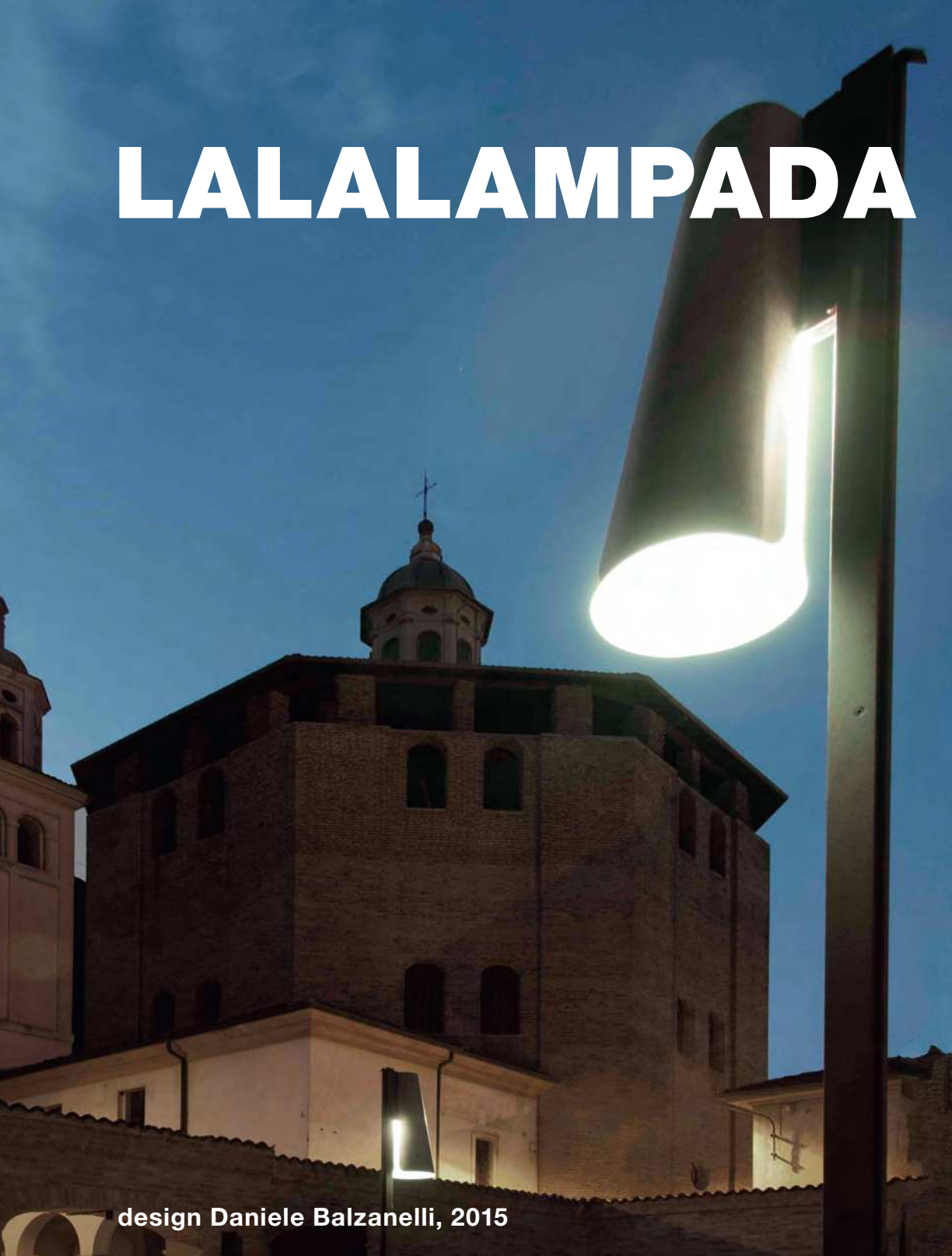

design Daniele Balzanelli, 2015

32

Apparecchio da esterno a luce diretta.
Struttura in metallo verniciato nel colore corten.
Riflettore in alluminio nel colore rame ossidato.
Diffusore interno in vetro satinato.
Per lampadina a LED.

Outdoor lamp direct light. Lacquered metal structure, corten color.
Copper oxidated colour aluminium reflector, with internal satin glass diffuser.
For LED bulb.

IP54



Dispositif pour usage extérieur avec lumière directe.
Structure en métal peint en couleur corten.
Réflecteur en aluminium en couleur de cuivre oxydé.
Diffuseur interne en verre dépoli.
Pour ampoule à LED.

Außenraum-Leuchtapparat mit direktem Licht.
Struktur aus lackiertem Metall in der Corten-Farbe.
Aluminium-Schirm-Reflektor in der eloxiertes-Kupfer-Farbe.
Eingebauter Strahler aus Satin-Glas.
Für LED Lampe.

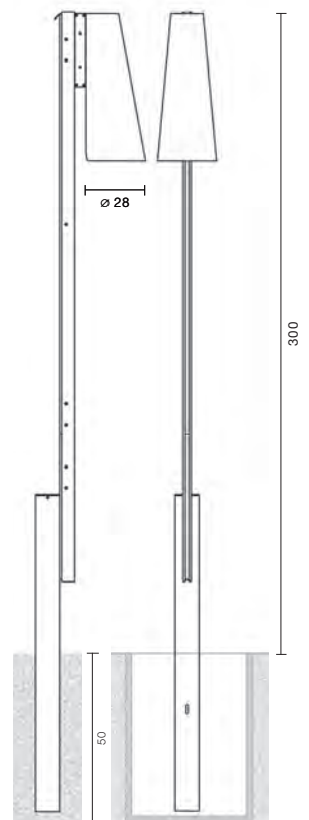



2296 1x14W E27 LED  A+

OUT



design Elio Martinelli, 1984

34

Serie di apparecchi da esterno a luce diffusa, da terra con palo e corpo in resina, da parete e soffitto per sorgente di luce a LED. Finitura con vernici poliuretatiche, nei colori bianco e antracite. Griglia in acciaio verniciato. Diffusore in policarbonato.

A set of devices for outdoor with diffused light floor lamp with a pole and the body made of resin, wall lamp, and ceiling lamp. Finishing with polyurethane paints, in white and anthracite. Grid made of paint steel. Diffuser made of polycarbonate. For LED light source.

IP54 / IP65



Série de dispositifs pour usage extérieur avec lumière diffusée, lampadaire avec une tige et corp réalisée en resin, applique, lampadaire. Finition avec peintures de polyuréthanes, en blanc et anthracite. Grille en acier. Diffuseur en polycarbonate. Pour source lumineuse à LED.

Serie von Außenraumgeräten mit gestreutem Licht, Bodengeräte und leuchtkörper mit Harz. Wandgeräte, Deckengeräte. Polyurethanlack-Oberflächenausführung in der weißen und in der anthracite Farbe. Stahlgitter. Polycarbonat-Strahler. Für LED Lichtquelle.

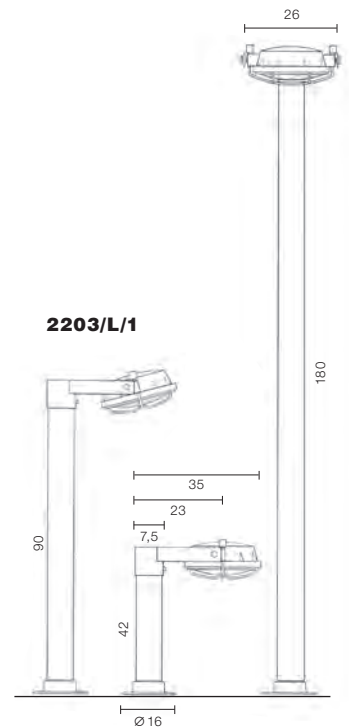

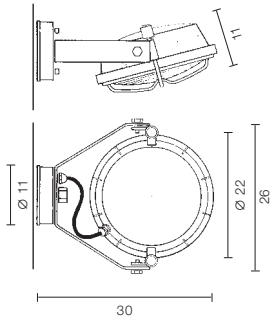

1245/L/1

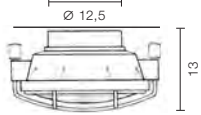

2813/L/1



- 1245/L/1/BI** Ø26 H11→30 7,5W LED 1100 lm 3000K  A++ **IP54**
- 1245/L/1/AN**
- 2203/180/L/1/BI** Ø22 H180 7,5W LED 1100 lm 3000K  A++ **IP65**
- 2203/180/L/1/AN**
- 2203/90/L/1/BI** Ø22 H90 7,5W LED 1100 lm 3000K  A++ **IP65**
- 2203/90/L/1/AN**
- 2203/42/L/1/BI** Ø22 H42 7,5W LED 1100 lm 3000K  A++ **IP65**
- 2203/42/L/1/AN**
- 2813/L/1/BI** Ø26 H11 7,5W LED 1100 lm 3000K  A++ **IP54**
- 2813/L/1/AN**



POLO



design Elio Martinelli, 1986

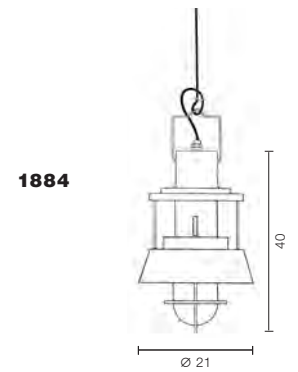
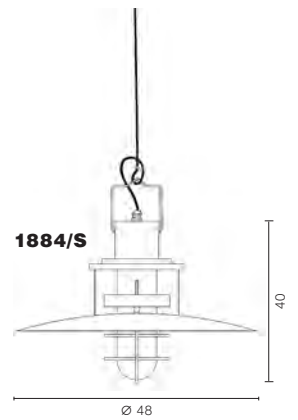

38

Serie di apparecchi da esterno a luce diffusa, da terra con palo e corpo in resina, da parete, da soffitto e a sospensione. Per lampadina a LED.

Finitura con vernici poliuretatiche, nei colori bianco e antracite. Griglia in acciaio. Diffusore in vetro satinato.

A set of devices for outdoor with diffused light, floor lamp with a pole and the body made of resin, wall, ceiling, and hanging lamp. For LED bulb. Finishing with polyurethane paints, in white and anthracite. Grid made of steel. Diffuser made of glazed glass.

IP54 / IP65



Série de dispositifs pour usage extérieur avec lumière diffusée, lampadaire avec une tige et corp réalisée en resin, applique, lampadaire au suspension.

Pour ampoule à LED. Finition avec peintures de polyuréthanes, en blanc et anthracite. Grille en acier. Diffuseur en verre dépoli.

Serie von Außenraumgeräten mit gestreutem Licht. Bodengeräte und leuchtkörper mit Harz. Wandgeräte Hängeleuchte, Deckengeräte. Für Leuchtmittel LED. Polyurethanlack-Oberflächenausführung in der weißen und in der anthrazit Farbe. Stahlgitter. Satinglasstrahler.

2208

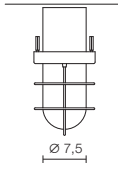
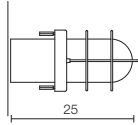

2213

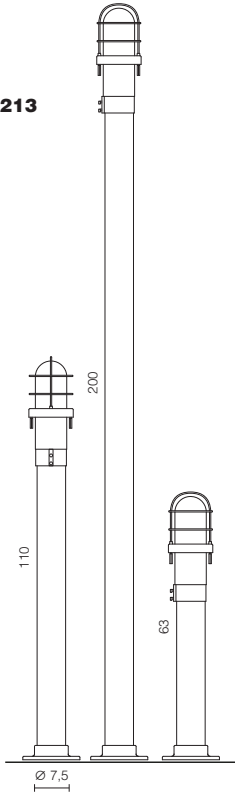

2808/BI - 2808/AN	1x15W E27 LED  A+	IP54
2213/200/BI - 2213/200/AN	1x15W E27 LED  A+	IP65
2213/110/BI - 2213/110/AN	1x15W E27 LED  A+	IP65
2213/63/BI - 2213/63/AN	1x15W E27 LED  A+	IP65
1884/BI - 1884/AN	1x15W E27 LED  A+	IP54
1884/S/BI - 1884/S/AN	1x15W E27 LED  A+	IP54

2250



design Elio Martinelli, 1986

40

Lampada da esterno a luce diffusa e riflessa, riflettore in alluminio, diffusore in vetro pirex satinato, guarnizioni in silicone. Corpo completo di gruppo di alimentazione, palo cilindrico in acciaio zincato verniciato antracite. Verniciatura a polvere nel colore grigio scuro. Con sorgente di luce a LED.

Standing outdoor lamp, reflected and diffused light, in powered coating aluminium, Pyrex glass diffused, silicon rubber seal. Complete of wiring parts, cylindrical metal pole, powered coated painted in anthracite colour. For LED light source.

IP54



Lampe pour usage extérieur avec lumière diffusée et réfléchie, réflecteur en aluminium, diffuseur en verre pirex dépoli, garnitures en silicones. Corps équipé d'un groupe d'alimentation, tige cylindrique en acier galvanisé. Peinture à poudre en anthracite sombre. Pour source de lumière LED.

Außenraumlampe mit gestreutem und reflektiertem Licht, Aluminium-Schirmreflektor, Pirex-Satinglas-Strahler, Silikondichtungen. Leuchtkörper versehen mit Versorgungseinheit, zylinderförmigem Pfosten aus verzinktem Stahl. Pulverbeschichtung in der anthrasid Farbe. Für LED-Lichtquelle.

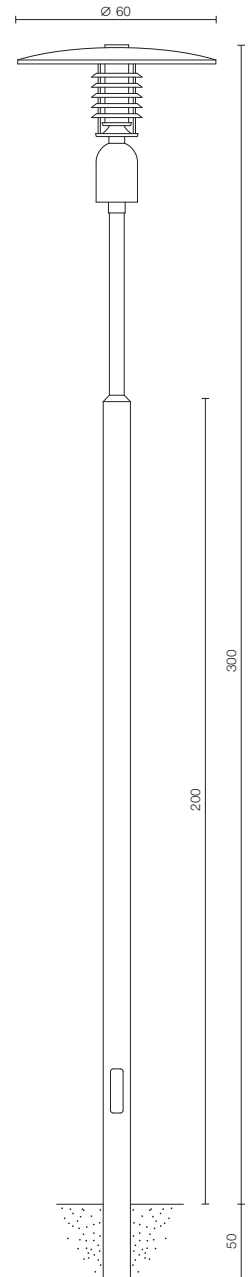

2250/L/1

39W LED
4200 lm 3000K  A++

CREDITS

ART DIRECTION & EDITING

EMILIANA MARTINELLI

STILL LIFE PHOTOGRAPHY

BENVENUTO SABA
EMILIANA MARTINELLI

IN PLACE PHOTOGRAPHY

EMILIANA MARTINELLI
MARCO GHILARDUCCI
KALIN GEMIGNANI
DANIELE BALZANELLI
MARCO DEL GRECO
LUIGI MAISTO

PREPRESS

GRAFICHE GELLI - FIRENZE

PRINTING

GRAFICHE MARTINELLI - FIRENZE

EDITION

MARZO 2017 © ALL RIGHTS RESERVED

X-PER

CARTIERE FEDRIGONI - VERONA



THANKS FOR LOCATION TO:

MICHEL BOUCQUILLON E
DONIA MAAOUI BOUCQUILLON - LUCCA
GIOVANNI SILVANO - LUCCA
FIORELLA PARENTI - CAMAIORE
ALFONSO FEMIA - EVENTO MILANO
SHOWROOM FORTE IN - FORTE DEI MARMI
DANIELE BALZANELLI - PALAZZO DUCALE, SABBIONETA
MUSA, PIETRASANTA
MARINI PANDOLFI, FIRENZE
LE CLUB - MAISON & OBJECT -PARIGI
VILLA BERNARDINI - LUCCA



martinelli luce spa

via Teresa Bandettini
55100 Lucca - Italy
tel. +39 0583 418315
fax +39 0583 419003
www.martinelliluce.it
info@martinelliluce.it

showroom martinelli luce
via S. Lucia 9, 55100 Lucca
tel. + 39 0583 496254
showroom@martinelliluce.it

showroom martinelli luce - albed
via S. Damiano 5, 20122 Milano
tel. + 39 02 76340610
milano@martinelliluce.it
milano@albed.it