



NEW  
PERSPECTIVES  
ON SCANDINAVIAN  
DESIGN

**MUUTO**



# NEW PERSPECTIVES ON SCANDINAVIAN DESIGN

Muuto is rooted in the Scandinavian design tradition characterized by enduring aesthetics, functionality, craftsmanship and an honest expression.

By expanding this heritage with forward-looking materials, techniques and bold creative thinking, our ambition is to deliver new perspectives on Scandinavian design.

In fact our name, Muuto, comes from *muutos*, meaning new perspective in Finnish. We handpick leading contemporary designers who are strong interpreters of our philosophy and combine their talents with the passionate Muuto creative team.

You will know our design because it has muutos: objects made sublime through new perspectives, enjoyed across the world, representing the best of Scandinavian design today.

The Post Wall Lamp brings an innovative character to modern lighting through its graphic expression, forward-thinking functionalities and refined finish



2





**WORKSHOP COFFEE TABLE**  
by Cecilie Manz p. 64

**PEBBLE RUG**  
by Margrethe Odgaard p. 81

**POST FLOOR LAMP**  
by Farnest Studio p. 77

**OUTLINE SOFA 3-SEATER  
& STUDIO CHAIR**  
by Anderssen & Voll p. 60





FIBER SIDE CHAIR SWIVEL BASE  
by Iskos-Berlin p. 68

70/70 TABLE  
by TAF Studio p. 62

RIDGE VASE  
by Studio Kaksikko p. 80

STRAND PENDANT LAMP  
by Benjamin Hubert p. 74



5

# KINK VASE



6



# BEAM TABLE LAMP



**VISU CHAIR WOOD BASE**  
by Mika Tolvanen p. 72

**70/70 TABLE**  
by TAF Studio p. 62

**KINK VASE**  
by Earnest Studio p. 80

**GRAIN PENDANT LAMP**  
by Jens Fager p. 75

8



# HALVES SIDE TABLE





**LINEAR WOOD TABLE**  
by Thomas Bentzen p. 63

**FIBER SIDE CHAIR TUBE BASE**  
by Iskos-Berlin p. 67

**E27 PENDANT LAMP**  
by Mattias Ståhlbom p. 75

**KINK VASE**  
by Earnest Studio p. 80



**DOZE LOUNGE CHAIR**  
by Anderssen & Voll p. 62

**DOZE OTTOMAN**  
by Anderssen & Voll p. 62

**LEAF TABLE LAMP**  
by Broberg & Ridderstråle p. 76

**RIDGE VASE**  
by Studio Kaksikko p. 80







**Designed with soft, playful shapes, the Strand Pendant Lamp is created in a sprayed material of tiny strands for a complex, intriguing structure, giving the light an almost cloud-like expression and comfortable glow**



**NERD CHAIR**  
by David Geckeler p. 71

**BASE TABLE**  
by Mika Tolvanen p. 63

**UNDER THE BELL PENDANT LAMP**  
by Iskos-Berlin p. 75



**STACKED STORAGE SYSTEM**  
by Julien De Smedt p. 65

**ECHO POUF**  
by Anderssen & Voll p. 62

**BEAM TABLE LAMP**  
by Tom Chung p. 76



# TIP TABLE LAMP





**STACKED STORAGE SYSTEM**  
by Julien De Smedt p. 65

**DOZE LOUNGE CHAIR**  
by Anderssen & Voll p. 62

**DOZE OTTOMAN**  
by Anderssen & Voll p. 62

**POST FLOOR LAMP**  
by Earnest Studio p. 77





**LINEAR WOOD TABLE**  
by Thomas Bentzen p. 63

**OSLO SIDE CHAIR**  
by Anderssen & Voll p. 70

**STRAND PENDANT LAMP**  
by Benjamin Hubert p. 74

**KINK VASE**  
by Earnest Studio p. 80



# RIDGE VASE



17

WORKSHOP CHAIR  
by Cecilie Manz p. 70

RIDGE VASE  
by Studio Kaksikko p. 80

18



# RESTORE STORAGE SERIES

RESTORE BASKET & TRAY  
by Mika Tolvanen p. 79

LINEAR WOOD BENCH  
by Thomas Bentzen p. 63





**FIBER SIDE CHAIR SWIVEL BASE**  
by Iskos-Berlin p. 68

**70/70 TABLE**  
by TAF Studio p. 62

**FOLDED SHELVES**  
by Johan van Hengel p. 78

**POST WALL LAMP**  
by Earnest Studio p. 77



**ENFOLD SIDEBOARD**  
by Thomas Bentzen p. 66

**LINEAR WOOD SERIES**  
by Thomas Bentzen p. 63

**FIBER SIDE CHAIR WOOD BASE**  
by Iskos-Berlin p. 67

**UNFOLD PENDANT LAMP**  
by Form Us With Love p. 75



# LAYER CUSHION

LAYER CUSHION  
by Aiayu p. 82

RHYTHM THROW  
by Aiayu p. 81

WORKSHOP COFFEE TABLE  
by Cecilie Manz p. 64



22



# POST FLOOR LAMP



**POST FLOOR LAMP**  
by Earnest Studio p. 77

**OSLO LOUNGE CHAIR**  
by Anderssen & Voll p. 61

**OSLO SOFA 3-SEATER**  
by Anderssen & Voll p. 61

**KINK VASE**  
by Earnest Studio p. 80

24



# COVER LOUNGE CHAIR



Outline marries the ideals of simplicity and function to bring new perspectives on the Scandinavian design sofas of the 1960's. With its shape being a strong outline of a sofa, the Outline Series is clean and elegant on the outside with a deep seat and soft cushioning on its inside



**OUTLINE SOFA 3-SEATER**  
by Anderssen & Voll p. 60

**PEBBLE RUG**  
by Margrethe Odgaard p. 81

**AIRY COFFEE TABLE**  
by Cecilie Manz p. 64

**OUTLINE POUF**  
by Anderssen & Voll p. 60





**COVER SIDE CHAIR**  
by Thomas Bentzen p. 73

**70/70 TABLE**  
by TAF Studio p. 62

**PEBBLE RUG**  
by Margrethe Odgaard p. 81

**KINK VASE**  
by Earnest Studio p. 80





**STRAND PENDANT LAMP**  
by Benjamin Hubert p. 74

**TUB JUG**  
by Atelier BLI19 p. 79

**FIBER COUNTER STOOL**  
by Iskos-Berlin p. 69

# LINEAR STEEL SERIES

28



LINEAR STEEL SERIES  
by Thomas Bentzen p. 63

SILENT VASE  
by Andreas Engesvik p. 80





**LINEAR STEEL SERIES**  
by Thomas Bentzen p. 63

**TUB JUG**  
by Atelier BLI19 p. 79



30



# AMBIT WALL LAMP

AMBIT WALL LAMP  
by TAF Studio p. 77

WORKSHOP COFFEE TABLE  
by Cecilie Manz p. 64

PEBBLE RUG  
by Margrethe Odgaard p. 81

CONNECT MODULAR SOFA  
by Anderssen & Voll p. 61



**ATTACH COAT HOOK**  
by Dimitri Bähler p. 78

**RESTORE BASKET**  
by Mika Tolvanen p. 79

**COVER ARMCHAIR**  
by Thomas Bentzen p. 73

**PLY RUG**  
by Margrethe Odgaard p. 81



The Fiber Chair Family is made in an innovative composite of plastic and pine wood fibers, giving the design a uniquely deep surface and soft, matte touch. Though invisible to the eye when seen from afar, the natural details of the wood fibers are revealed when viewing the design up-close, paired with its simple and sculptural form language for an extensive comfort



**FIBER ARMCHAIR & SIDE CHAIR**  
by Iskos-Berlin p. 67

**SPLIT TABLE**  
by Staffan Holm p. 62

**PLY RUG**  
by Margrethe Odgaard p. 81

**UNDER THE BELL PENDANT LAMP**  
by Iskos-Berlin p. 75



33

# DOTS COAT HOOKS

DOTS METAL  
by Lars Tornøe p. 78

DOTS CERAMIC  
by Lars Tornøe p. 78





34

# TUB JUG

The Visu Bar Stool echoes the ideas of Scandinavian design through its elegant shape and friendly seat in form pressed wood veneer, adding a gentle yet contemporary feel to any space



**VISU BAR STOOL**  
by Mika Tolvanen p. 72

**AMBIT PENDANT LAMP**  
by TAF Studio s. 74

**CORKY CARAFE & GLASSES**  
by Andreas Engesvik p. 79



The Ambit Pendant Lamp is made in hand-spun aluminum across three sizes, designed with a timeless yet modern shape that works well on its own, in rows or clusters for a modern take on the chandelier

36





**COVER LOUNGE CHAIR**  
By Thomas Bentzen p. 73

**OUTLINE CORNER SOFA**  
by Anderssen & Voll p. 60

**WORKSHOP COFFEE TABLE**  
By Cecilie Manz p. 64

**FLUID PENDANT LAMP**  
by Claesson Koivisto Rune p. 74



The Oslo Side Chair combines modern, geometric lines with a contemporary expression and soft seat for a deep comfort and elegant character



**OSLO SIDE CHAIR**  
by Iskos-Berlin p. 70

**70/70 TABLE**  
by TAF Studio p. 62

**FLUID PENDANT LAMP**  
by Claesson Koivisto Rune p. 74

**OSLO SOFA 2-SEATER**  
by Anderssen & Voll p. 61



# LINEAR WOOD BENCH



40



# FIBER LOUNGE CHAIR



**CONNECT MODULAR SOFA**  
by Anderssen & Voll p. 61

**AROUND COFFEE TABLE**  
by Thomas Bentzen p. 64

**PULL FLOOR LAMP**  
by Whatswhat p. 77

**FIBER LOUNGE CHAIR TUBE BASE**  
by Iskos-Berlin p. 70



42



# FIBER STOOL

**FIBER STOOL TUBE BASE**  
by Iskos-Berlin p. 69

**DOTS WOOD**  
by Lars Tornøe p. 78

**PLY RUG**  
by Margrethe Odgaard p. 81



**WORKSHOP CHAIR**  
by Cecilie Manz p. 70

**BASE TABLE**  
by Mika Tolvanen p. 63

**UNDER THE BELL PENDANT LAMP**  
by Iskos-Berlin p. 75





**LOFT BAR STOOL**  
by Thomas Bentzen p. 71

**E27 PENDANT LAMP**  
by Mattias Ståhlbom p. 75

**CORKY CARAFE & GLASSES**  
by Andreas Engesvik p. 79

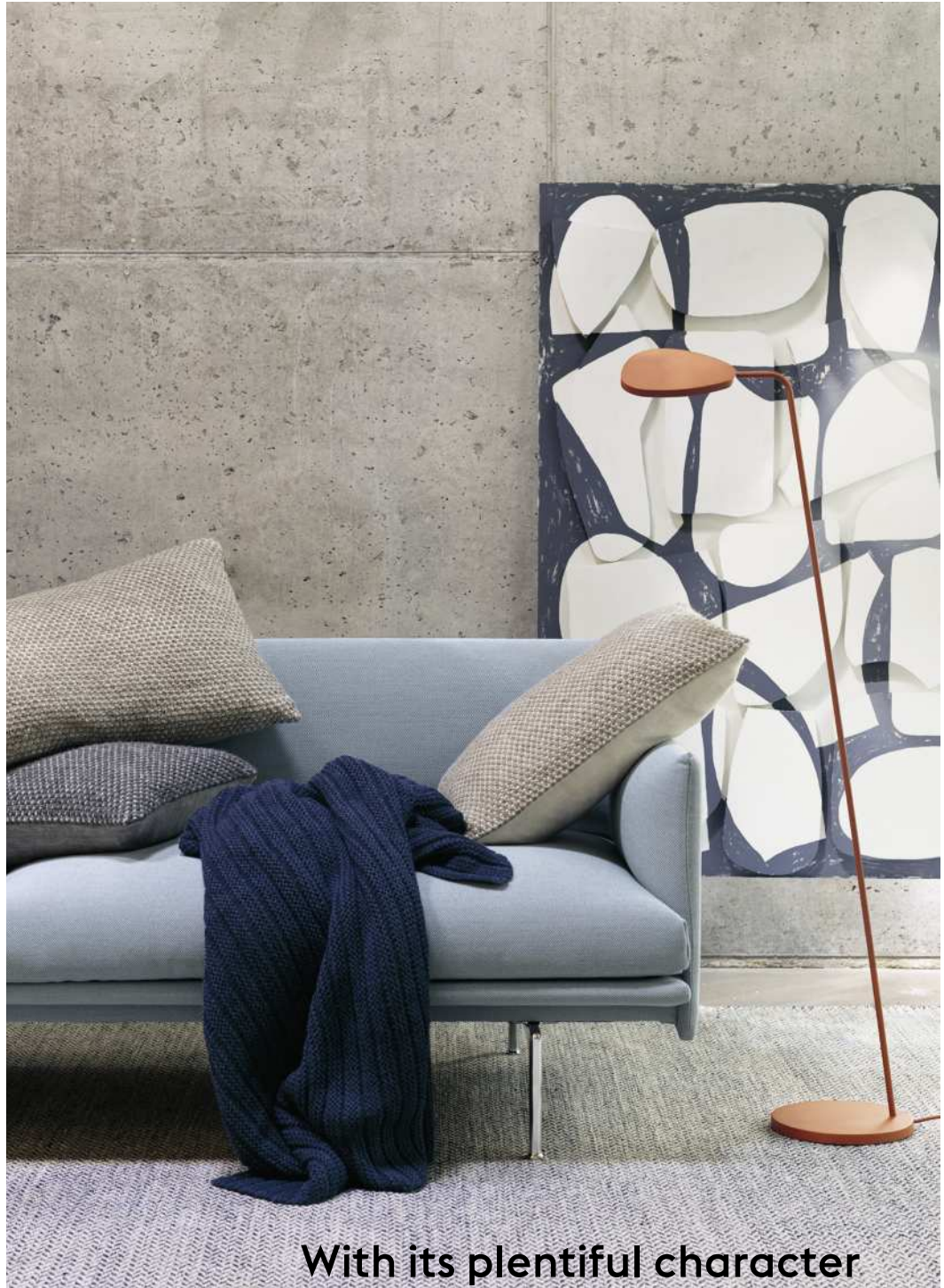

With its plentiful character and refined surface, the Ample Throw brings extensive comfort and warmth to its user through its ultra-soft materiality and elegant knit



46



# PULL FLOOR LAMP

OSLO SOFA 2-SEATER  
by Anderssen & Voll p. 61

PULL FLOOR LAMP  
by Whatswhat p. 77

RHYTHM THROW  
by Aiayu p. 81

VARJO RUG  
by Tina Ratzer p. 81



**ECHO POUF**  
by Anderssen & Voll p. 62

**STRAND PENDANT LAMP**  
by Benjamin Hubert p. 74

**HALVES SIDE TABLE**  
by MSDS Studio p. 64



48



# NERD BAR STOOL

NERD BAR STOOL  
by David Geckeler p. 71

GRAIN PENDANT LAMP  
by Jens Fager p. 75



**REST SOFA 3-SEATER**  
by Anderssen & Voll p. 61

**PLY RUG**  
by Margrethe Odgaard p. 81

**AIRY COFFEE TABLE**  
by Cecilie Manz p. 64

**COSY IN WHITE TABLE LAMP**  
by Harri Koskinen p. 76



The Loft Chair is a study of applying the ideas of refined simplicity to design. With its sturdy base and wooden seat, the Loft Chair combines the values of functionality, simplicity and craftsmanship into a single design



**LOFT CHAIR**  
by Thomas Bentzen p. 71

**AMBIT PENDANT LAMP**  
by TAF Studio p. 74

**BASE TABLE**  
by Mika Tolvanen p. 63



# RELATE SIDE TABLE

**RELATE SIDE TABLE**  
by Big-Game p. 64

**BEAM TABLE LAMP**  
by Tom Chung p. 76

**PEBBLE RUG**  
by Margrethe Odgaard p. 81





**REFLECT SIDEBOARD**  
by Søren Rose Studio p. 66

**OSLO SIDE CHAIR**  
by Anderssen & Voll p. 70

**LINEAR WOOD TABLE**  
by Thomas Bentzen p. 63

**AMBIT RAIL LAMP**  
by TAF Studio p. 74



# FOLDED SHELVES





# FRAMED MIRROR





**FIBER BAR STOOL TUBE BASE**  
by Iskos-Berlin p. 69

**AMBIT RAIL LAMP**  
by TAF Studio p. 74

**PLATFORM TRAY**  
by Sam Hecht & Kim Colin p. 80

**CORKY CARAFE & GLASSES**  
by Andreas Engesvik p. 79





**FIVE POUF**  
by Anderssen & Voll p. 69

**GRAIN PENDANT LAMP**  
by Jens Fager p. 75

**COMPILE SHELVING SYSTEM**  
by Cecilie Manz p. 66

**COMPILE BOOKEND**  
by Cecilie Manz p. 79



**FURNITURE**  
**60 — 73**

**LIGHTING**  
**74 — 77**

**ACCESSORIES**  
**78 — 82**





# CUSTOMIZE YOUR MUUTO DESIGN

## **READY-TO-SHIP OPTIONS**

Did you know that we have a vast number of variants across our collection of furniture, lighting and accessories, just waiting to be shipped on their way to you? To explore our Ready-To-Ship Options within your region, please visit [Muuto.com/Ready-To-Ship](https://muuto.com/Ready-To-Ship).

The Ready-To-Ship Options for each Muuto design are also shown on the specific product pages of this catalog from p. 60 onwards. Please note that Ready-To-Ship Options are subject to regional warehouse stock.

## **MADE-TO-ORDER INSPIRATION**

A selection of curated Made-To-Order options that bring new perspectives to the given product.

## **MADE-TO-ORDER OPTIONS**

Beyond our Ready-To-Ship Options and Made-To-Order Inspiration, you can select from a large variety of textile and leather upholsteries for your chosen Muuto design as a Made-To-Order Option, allowing you to select the exact upholstery that suits your personal preference and home.

Please consult your nearest Muuto dealer for further information and to learn more about the different options for a given Muuto product.





# FURNITURE

SPRING / SUMMER — 2020  
Prices are recommended retail prices

## OUTLINE SOFA SERIES by Anderssen & Voll

3 1/2-Seater

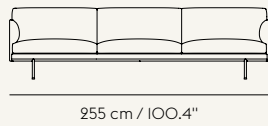

Corner Sofa

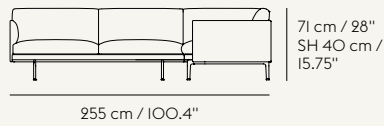

3-Seater

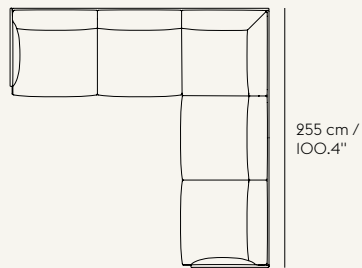
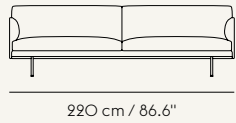

2-Seater

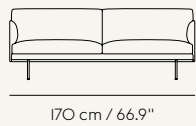

Chaise Longue

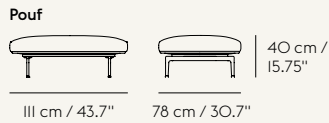
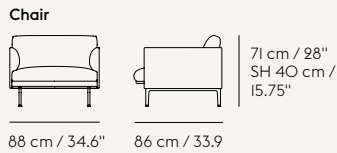
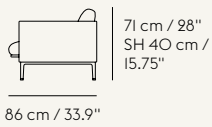
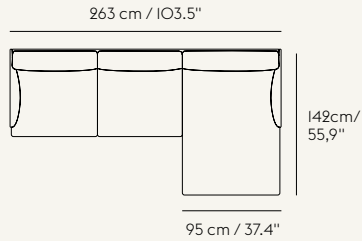

Studio Sofa

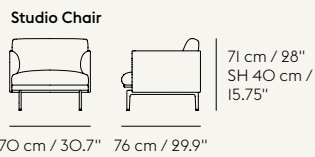
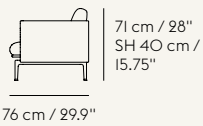
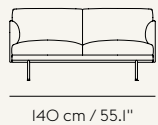

### READY-TO-SHIP OPTIONS

#### Textile upholstery/ Base



#### Leather upholstery/ Base



### MADE-TO-ORDER INSPIRATION

#### Textile upholstery/Base

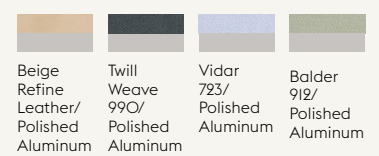

Outline Sofa 3-Seater p. 3 upholstered in Beige Refine Leather/Polished Aluminum

Outline Studio Chair p. 3 upholstered in Twill Weave 990/Polished Aluminum

Outline Sofa 3-Seater p. 25 upholstered in Cognac Refine Leather/Black

Outline Pouf p. 25 upholstered in Vidar 733/Black

Outline Corner Sofa p. 37 upholstered in Vidar 472/Black

Outline Sofa 3-Seater p. 45 upholstered in Steelcut Trio 713/Polished Aluminum

### MATERIAL

Powder coated or polished aluminum base. Wood and steel construction. Cold foam filling. All textiles from Kvadrat or Arve

### MADE-TO-ORDER OPTIONS

The Outline Corner, 3 1/2-Seater, Pouf, Chaise Longue and Studio versions are available as made-to-order. Chaise Longue available for left or right side. Other approved textiles and leather upholsterys are available as made-to-order. Polished Aluminum base is available for made-to-order versions

Please note that the Ready-To-Ship Options may be subject to regional stock. Consult your Muuto dealer or refer to price list for further information

## CONNECT MODULAR SOFA

by Anderssen & Voll

### End modules

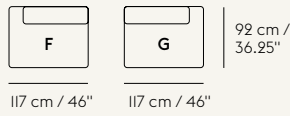
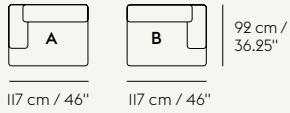

### Center & corner modules

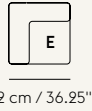
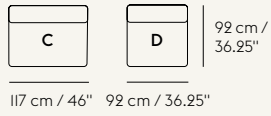

### End & lounge modules

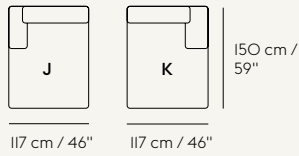

### Freestanding modules

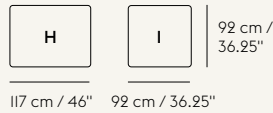

### READY-TO-SHIP OPTIONS



Connect Modular Sofa p. 30 upholstered in Remix 252

### MATERIAL

Cold foam, wooden frame. All textiles from Kvadrat, Nevotex, Fidertessile and Arve

### MADE-TO-ORDER OPTIONS

Combine your sofa setup from 11 different modules. Modules H, I, J & K are made-to-order. Other approved textiles are available as made-to-order

Please note that the Ready-To-Ship Options may be subject to regional stock. Consult your Muuto dealer or refer to price list for further information

## COMPOSE SOFA SERIES

by Anderssen & Voll

### 3-Seater

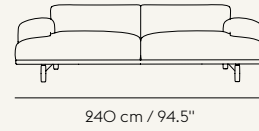

### 2-Seater

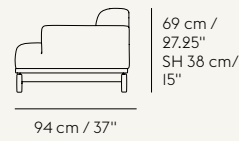
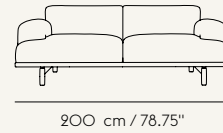

### MATERIAL

Wooden frame, steel rails and cold-foam filling. Base in natural or black lacquered oak. All textiles from Kvadrat, Fidertessile, Nevotex or Arve

### MADE-TO-ORDER OPTIONS

The entire Compose Sofa series is made-to-order. Other approved textiles are available as made-to-order

## REST SOFA SERIES

by Anderssen & Voll

### 3-Seater

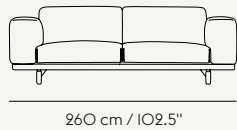

### 3-Seater

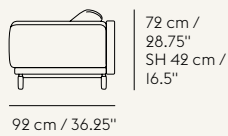
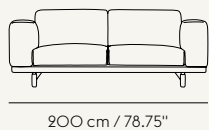

### Studio Sofa

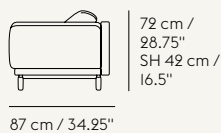
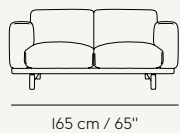

### Pouf



### READY-TO-SHIP OPTIONS

#### Textile Upholstery/Base

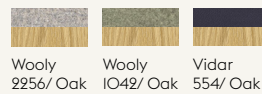

Rest Sofa 3-Seater p. 49 upholstered in Steelcut Trio 713/Oak

### MATERIAL

Steel base, wooden frame, cold foam and feather filling. Base in natural or painted grey or black oak. All textiles from Kvadrat, Nevotex and Arve

### MADE-TO-ORDER OPTIONS

The Rest Studio Sofa and Pouf are made-to-order versions. Other approved textile upholstery available as made-to-order

Please note that the Ready-To-Ship Options may be subject to regional stock. Consult your Muuto dealer or refer to price list for further information

## OSLO SOFA SERIES

by Anderssen & Voll

### 3-Seater

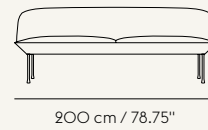

### 2-Seater

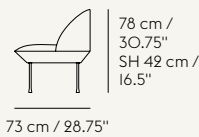

### Lounge Chair

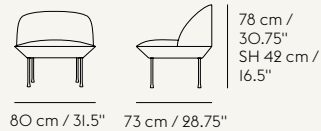

### Bench

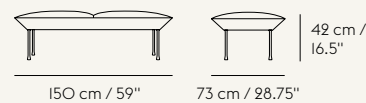

### Pouf

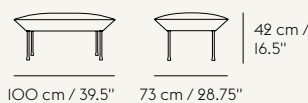

### READY-TO-SHIP OPTIONS

#### Textile Upholstery/Base



Oslo Lounge Chair & 3-Seater Sofa p. 23 upholstered in Vidar 772/Chrome

Oslo Sofa p. 38 upholstered in Fiord 551/Light Grey

Oslo Sofa 2-Seater p. 46 upholstered in Fiord 151/Dark Grey

### MATERIAL

Inner steel frame, base in powder coated aluminum and casted foam. All textiles from Kvadrat

### MADE-TO-ORDER OPTIONS

The Oslo Bench and Pouf are made-to-order. Other approved textiles and leather available as made-to-order. Option of dark grey, light grey, black, bunt yellow, navy blue or chrome base

Please note that the Ready-To-Ship Options may be subject to regional stock. Consult your Muuto dealer or refer to price list for further information



## DOZE LOUNGE CHAIR & OTTOMAN

by Anderssen & Voll

### Chair



106 cm / 41.7"  
SH 40 cm / 15.8"

95,5 cm / 37,6"

100 cm / 39,4"

### Ottoman



40 cm / 15.8"

64 cm / 25.2"

52 cm / 20.5"

Doze Lounge Chair & Ottoman p. 10 upholstered in Balder 782/Chrome

Doze Lounge Chair & Ottoman p. 15 upholstered Forest Nap 952/Dusty Green

### READY-TO-SHIP OPTIONS

#### Textile Upholstery/Base



### MADE-TO-ORDER INSPIRATION

#### Textile Upholstery/Base

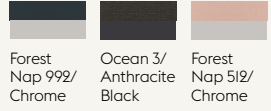

### MATERIAL

Steel construction with moulded foam filling

### MADE-TO-ORDER OPTIONS

Other approved textile upholsteries available as made-to-order

## ECHO POUF

by Anderssen & Voll

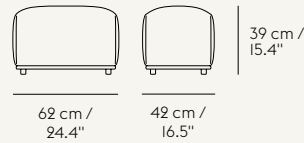

39 cm / 15.4"

62 cm / 24.4"

42 cm / 16.5"



39 cm / 15.4"

52 cm / 20.5"

52 cm / 20.5"



39 cm / 15.4"

52 cm / 20.5"

38 cm / 15"

### MADE-TO-ORDER INSPIRATION

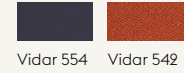
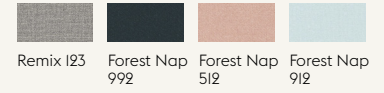

Echo Pouf 38 x 52 p. 13 upholstered in Remix 123

Echo Pouf p. 47 upholstered in Remix 123, Forest Nap 992, Forest Nap 512, Forest Nap 912, Vidar 554 & Vidar 542

### MATERIAL

Black wood frame and High-Resilience foam

### MADE-TO-ORDER OPTIONS

All Echo Pouf versions are made-to-order. Other approved textiles are available as made-to-order for the entire series

Please note that the Ready-To-Ship Options may be subject to regional stock. Consult your Muuto dealer or refer to price list for further information

## FIVE POUF

by Anderssen & Voll

### Large



45 cm / 17.75"

88 cm / 34.5"

53 cm / 21"

### Extra Large

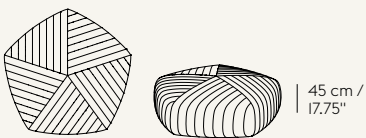

45 cm / 17.75"

140 cm / 55"

85 cm / 33.5"

### READY-TO-SHIP OPTIONS

#### Five Pouf Large



### MATERIAL

Wooden frame and molded foam. All textiles from Kvadrat

### MADE-TO-ORDER OPTIONS

Extra Large Pouf and other approved textiles are available as made-to-order options

Five Pouf p. 56 upholstered in Remix 773

Please note that the Ready-To-Ship Options may be subject to regional stock. Consult your Muuto dealer or refer to price list for further information

## 70/70 TABLE

by TAF Studio

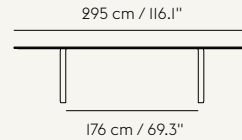

295 cm / 116.1"

176 cm / 69.3"



73 cm / 28.75"

108 cm / 42.5"

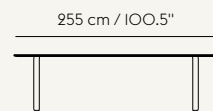

255 cm / 100.5"

205 cm / 80.7"



73 cm / 28.75"

108 cm / 42.5"

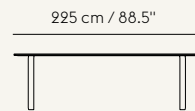

225 cm / 88.5"

175 cm / 68.9"

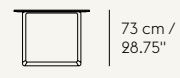

73 cm / 28.75"

90 cm / 35.5"

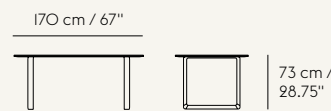

170 cm / 67"

120 cm / 47.2"

85 cm / 33.5"

73 cm / 28.75"

### READY-TO-SHIP OPTIONS

#### Tabletop

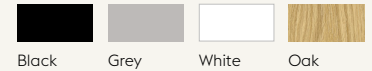

#### Frame

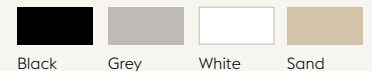

### MATERIAL

Tabletop in pine plywood with grey or black linoleum, white or sand laminate or oak veneer surface. Cast aluminum frame

### MADE-TO-ORDER OPTIONS

Tabletop finish in nanolaminat available as made-to-order in the colors Black, White and Grey

## SPLIT TABLE

by Staffan Holm

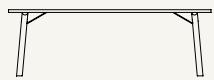

220 cm / 86.5"



73 cm / 28.75"

90 cm / 35.5"

### READY-TO-SHIP OPTIONS



Oak

### MATERIAL

Oiled Oak

Please note that Split Table is not available for sale in Japan, China, Korea, Hong Kong, Taiwan, India and Southeast Asia

**LINEAR WOOD SERIES**  
by Thomas Bentzen

**Tables**

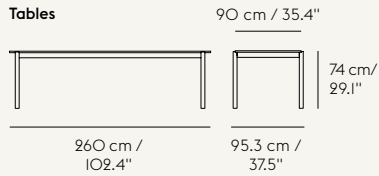

**READY-TO-SHIP OPTIONS**



Oak

**MATERIAL**

Top in lacquered oak veneer with solid oak legs

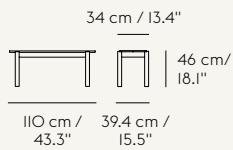
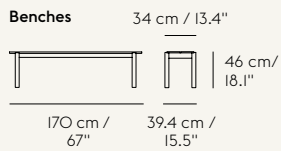
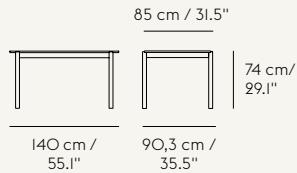
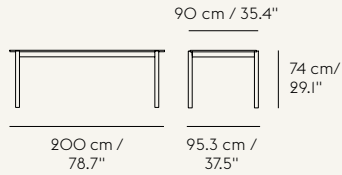

**LINEAR STEEL SERIES**  
by Thomas Bentzen

**Tables**

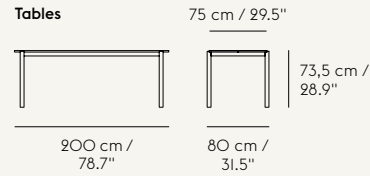

**READY-TO-SHIP OPTIONS**



Black

Off-White

Dark Green

Burnt Orange

**MATERIAL**

Weather-resistant powder coated steel, suitable for outdoor use

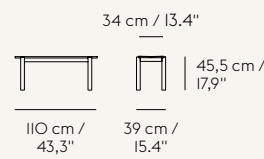
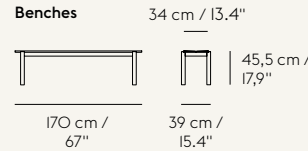
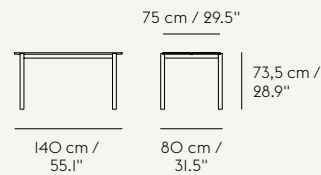

**BASE TABLE RECTANGULAR & ROUND**  
by Mika Tolvanen

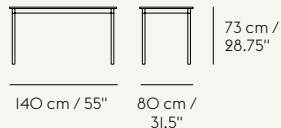

**READY-TO-SHIP OPTIONS**

**Tabletop**

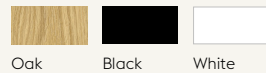

Oak

Black

White

**Frame**

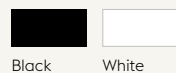

Black

White

**MATERIAL**

Frame in extruded aluminum with legs and stretcher in steel. Tabletop in either chip board with laminate surface and ABS edges, in plywood with linoleum surface or oak with veneer finish

**MADE-TO-ORDER OPTIONS**

More sizes available as made-to-order versions. Tabletop finish in nanolaminate available as made-to-order in the colors Black or White

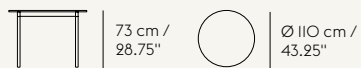
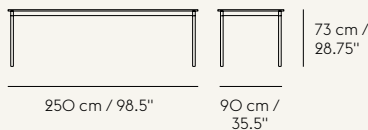
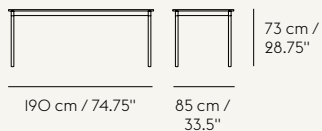

**BASE HIGH TABLE**  
by Mika Tolvanen

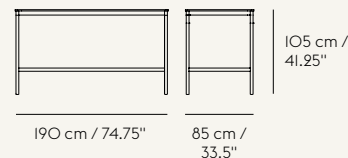

**READY-TO-SHIP OPTIONS**

**Tabletop**



Oak

Black

White

**Frame**

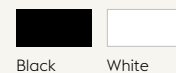

Black

White

**MATERIAL**

Frame in extruded aluminum with base and stretcher in steel. Tabletop in either chip board with laminate surface and ABS edges, in plywood with linoleum surface or oak with veneer finish

**MADE-TO-ORDER OPTIONS**

More sizes available as made-to-order versions. Tabletop finish in nanolaminate available as made-to-order in the colors Black or White

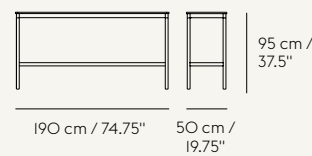
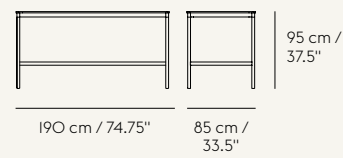
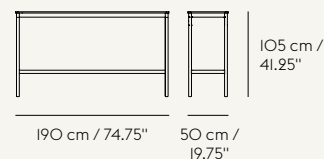



### STILL CAFÉ TABLE by Iskos-Berlin

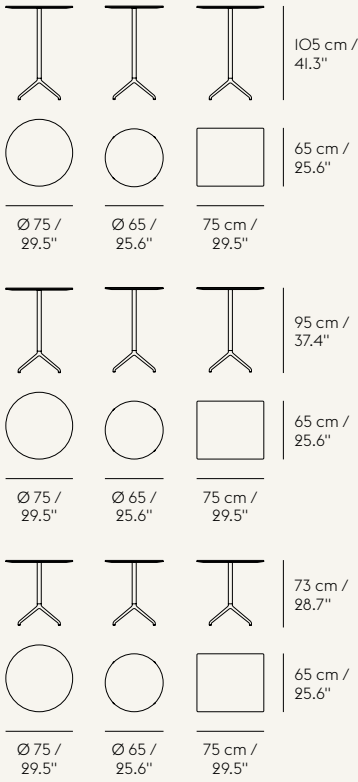

**READY-TO-SHIP OPTIONS**

Black/Black    White/White    Black/White    White/Black

**MATERIAL**  
Tabletop in MDF with the option of nanolaminate or linoleum finish. Edges are painted. Frame in powder coated aluminum. Mounting plate and tube in powder coated steel. Comes with 4 adjustable feet in plastic

**MADE-TO-ORDER OPTIONS**  
Linoleum surface is made-to-order. Tabletop in size Ø65 is available as made-to-order

### AIRY COFFEE TABLE by Cecilie Manz

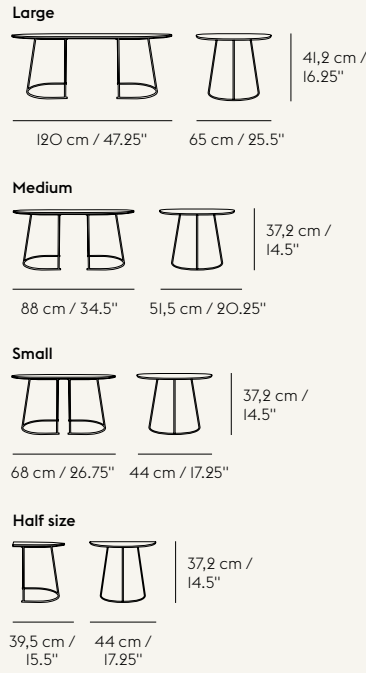

**READY-TO-SHIP OPTIONS**

Black    Grey    Off-White    Plum

**MATERIAL**  
Plywood tabletop with nanolaminate surface, powder coated solid steel frame

### AROUND COFFEE TABLE by Thomas Bentzen

64

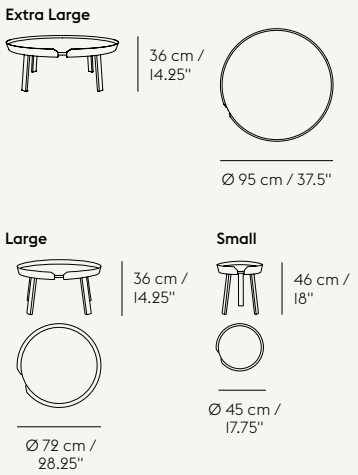

**READY-TO-SHIP OPTIONS**

Oak    Ash    Anthracite    Black

Grey    Dark Grey    White    Dusty Green

**MATERIAL**  
Tabletop made from ash or oak plywood. Legs made of solid lacquered ash or oak

### WORKSHOP COFFEE TABLE by Cecilie Manz

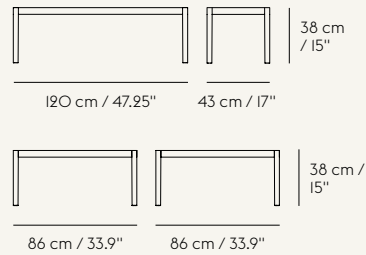

**READY-TO-SHIP OPTIONS**

Oak    Black

**MATERIAL**  
Legs and frame in solid wood. Tabletop in oak veneer. Black version comes in a lacquered oak. Oak version comes with a matte clear lacquer

### RELATE SIDE TABLE by Big-Game

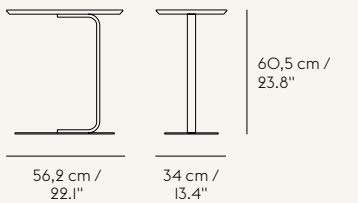

**READY-TO-SHIP OPTIONS**

Black    Off-White    Blue-Grey    Oak/Black

Oak/Off-White

**MATERIAL**  
Black, Off-White and Blue-Grey linoleum finish on MDF or high pressure laminate oak veneer on MDF. Frame in powder coated steel

### HALVES SIDE TABLE by MSDS Studio

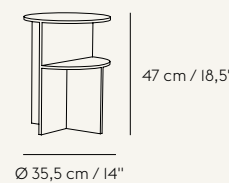

**READY-TO-SHIP OPTIONS**

Light Grey    Sand    Sage Green

**MATERIAL**  
Acrylic stone composite

## STACKED STORAGE SYSTEM

by Julien De Smedt

Inspiration for your Stacked Storage System

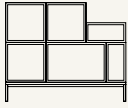

**Config. 1**  
 1 Small  
 1 Small w/ backboard  
 1 Medium  
 2 Medium w/ door  
 1 Large  
 1 Podium

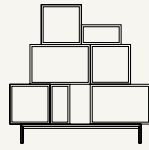

**Config. 2**  
 2 Small w/ backboard  
 1 Medium w/ backboard  
 2 Medium w/ door  
 2 Large  
 1 Podium

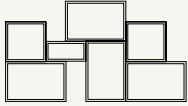

**Config. 3**  
 1 Small  
 2 Medium w/ backboard  
 2 Large  
 2 Large w/ backboard

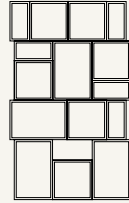

**Config. 4**  
 3 Small w/ backboard  
 2 Medium w/ backboard  
 3 Large w/ backboard  
 3 Small  
 2 Medium  
 1 Large  
 2 Medium w/ door

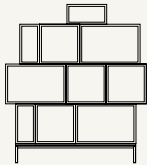

**Config. 5**  
 3 Small  
 3 Medium  
 1 Medium w/ backboard  
 1 Large  
 2 Large w/ backboard  
 1 Podium

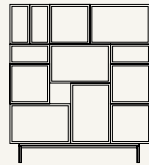

**Config. 6**  
 2 Small  
 2 Small w/ backboard  
 1 Medium  
 3 Medium w/ door  
 2 Large  
 2 Large w/ backboard  
 1 Podium

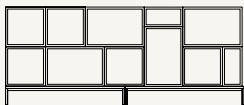

**Config. 7**  
 2 Small w/ backboard  
 2 Medium w/ backboard  
 3 Medium w/ door  
 4 Large w/ backboard  
 2 Podium

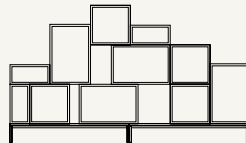

**Config. 8**  
 3 Small w/ backboard  
 2 Medium w/ backboard  
 2 Medium w/ door  
 4 Large w/ backboard  
 2 Podium

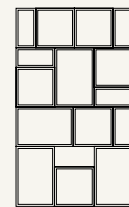
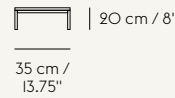
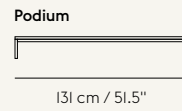
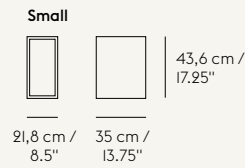
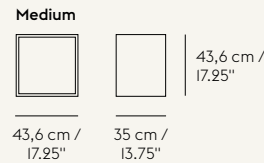
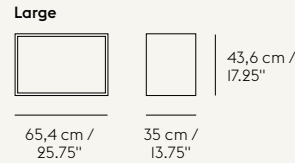

**Config. 9**  
 3 Small w/ backboard  
 2 Medium w/ backboard  
 3 Large w/ backboard  
 3 Small  
 2 Medium  
 1 Large  
 2 Medium w/ door

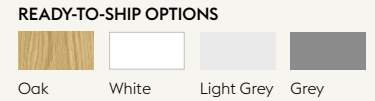

**MATERIAL**  
 Oak veneer or PU lacquered MDF.  
 Clips in painted steel

**EXTRA**  
 Each Stacked module comes with two clips. Extra clips available in Set of 5 in the colors White, Black, Dusty Green, Light Grey and Grey

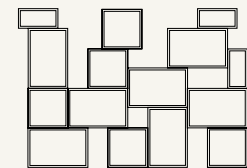

**Config. 10**  
 4 Small  
 5 Medium  
 7 Large

Create your own storage solution with the Muuto Stacked Configurator. See our configuration guidelines and design your own Stacked setup on [stackedconfigurator.muuto.com](http://stackedconfigurator.muuto.com)

The Stacked Storage System complies with the European requirements for safety, strength, durability and stability within storage — EN 16121:2013 and EN 16122:2012 — when following the assembly and configuration guidelines

## MINI STACKED STORAGE SYSTEM

by Julien De Smedt

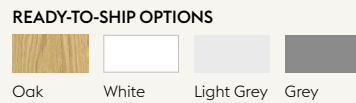
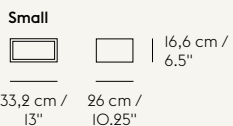
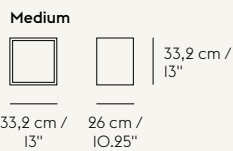
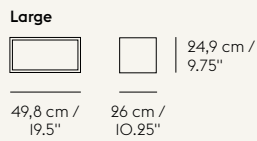

**MATERIAL**  
 Oak veneer or PU lacquered MDF.  
 Clips in painted steel

**EXTRA**  
 Each Mini Stacked module comes with one clip. Extra clips available in Set of 5 in the colors White, Dusty Green, Light Grey and Grey

## STACKED ACOUSTIC PANELS

by Julien De Smedt

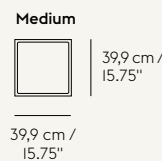
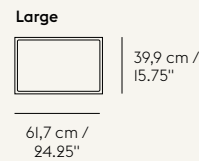

**MATERIAL**  
 Polymer felt



# COMPILE SHELVING SYSTEM

by Cecilie Manz

## Prearranged configurations

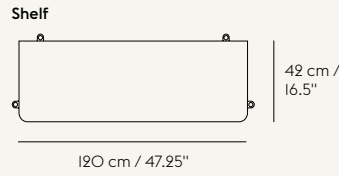
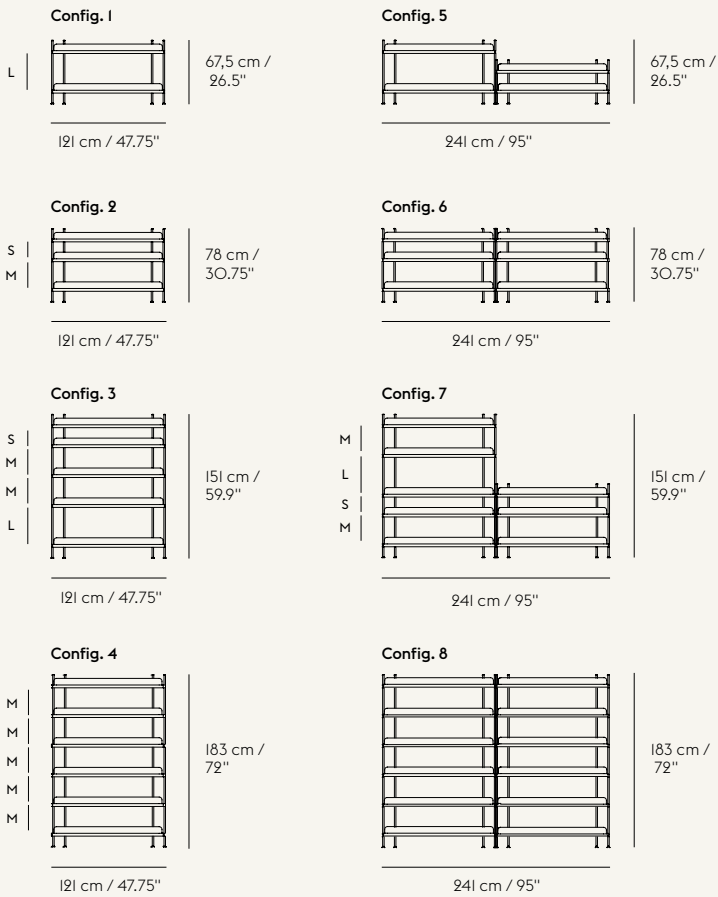

## READY-TO-SHIP OPTIONS

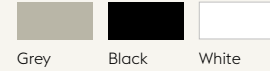

**MATERIAL**  
Powder coated steel

## MADE-TO-ORDER OPTIONS

Build personalized systems by assembling shelves with 3 sizes of dividers or choose between 8 prearranged configurations

## Dividers

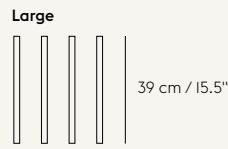

## Essentials Pack

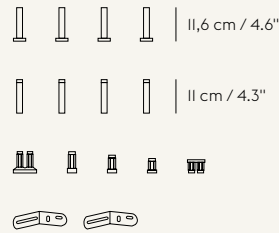

Furniture

**66** **WEIGHT & HEIGHT RECOMMENDATIONS**  
The Compile Shelving System should always be mounted to a wall using wall brackets (included in the essentials pack). A Compile Shelving System can hold up to 300 kg / 661 lb. The Compile Shelving Systems can be built as tall as wanted, as long as it is mounted to the wall using wall brackets. Muuto recommends not building configurations higher than 2,25 m / 88,5"

## ENFOLD SIDEBORD

by Thomas Bentzen

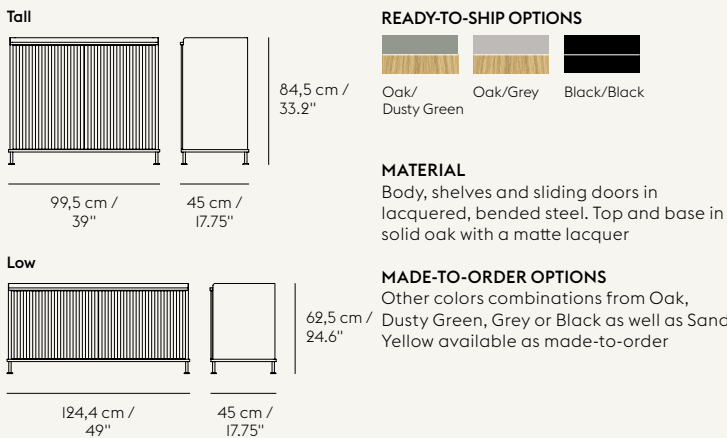

## REFLECT SIDEBORD & DRAWER

by Søren Rose Studio

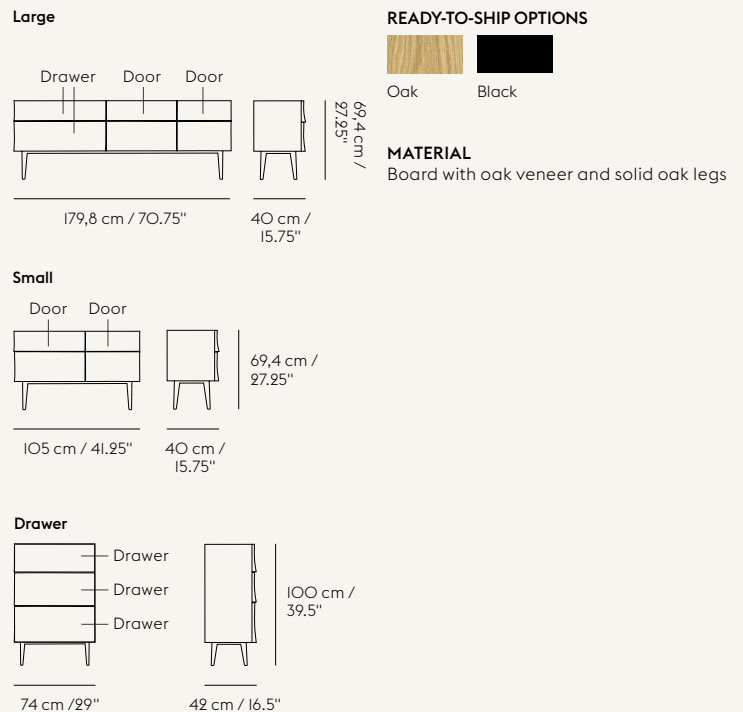

Please note that the Reflect Drawer is not available for sale in North America

**FIBER ARMCHAIR WOOD BASE**  
by Iskos-Berlin

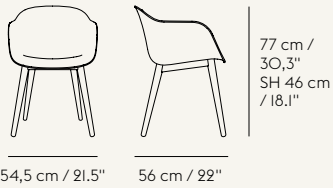

**READY-TO-SHIP OPTIONS**

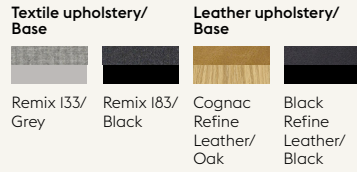
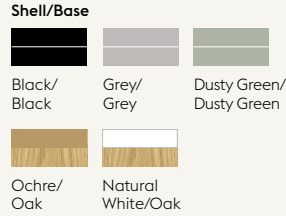

**MADE-TO-ORDER INSPIRATION**

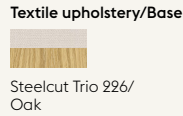

**MATERIAL**

The shell consists of a PP composition with up to 25% pine wood fibers and colored polypropylene. Option of approved textile and leather upholstered seat. Base in solid oak and plywood with a water-based lacquer

**MADE-TO-ORDER OPTIONS**

Front upholstery and full upholstery versions with other textiles and leather available as made-to-order options

Please note that the Ready-To-Ship Options may be subject to regional stock. Consult your Muuto dealer or refer to price list for further information

**FIBER SIDE CHAIR WOOD BASE**  
by Iskos-Berlin

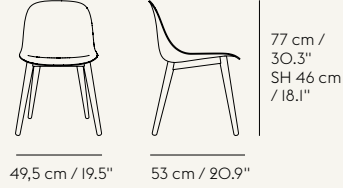

**READY-TO-SHIP OPTIONS**

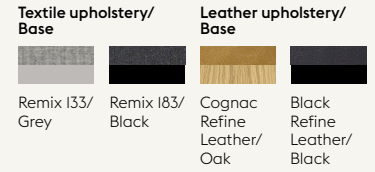
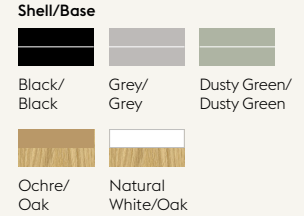

Fiber Side Chair Wood Base p. 20 upholstered in Canvas 414/Oak

**MADE-TO-ORDER INSPIRATION**



**MATERIAL**

The shell consists of a PP composition with up to 25% pine wood fibers and colored polypropylene. Option of textile and leather upholstered seat. Base in solid oak and plywood with a water-based lacquer

**MADE-TO-ORDER OPTIONS**

Other textiles and leather upholsteries available as made-to-order options

Please note that the Ready-To-Ship Options may be subject to regional stock. Consult your Muuto dealer or refer to price list for further information

**FIBER ARMCHAIR TUBE & SLED BASE**  
by Iskos-Berlin

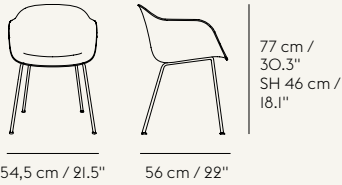

**READY-TO-SHIP OPTIONS**

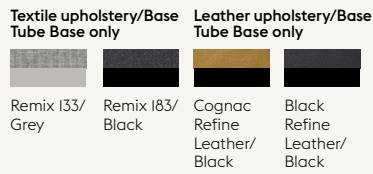
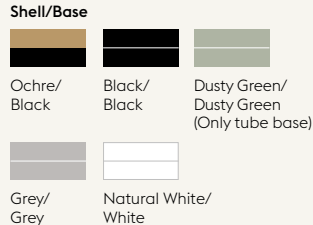

**MADE-TO-ORDER INSPIRATION**

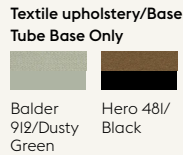

**MATERIAL**

The shell consists of a PP composition with up to 25% pine wood fibers and colored polypropylene. Option of textile and leather upholstered seat. Base in powder coated steel

**MADE-TO-ORDER OPTIONS**

Front upholstery and full upholstery versions with other approved textiles and leather available as made-to-order options

Please note that the Ready-To-Ship Options may be subject to regional stock. Consult your Muuto dealer or refer to price list for further information

**FIBER SIDE CHAIR TUBE & SLED BASE**  
by Iskos-Berlin

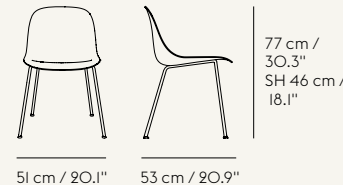

**READY-TO-SHIP OPTIONS**

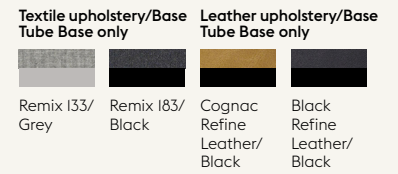
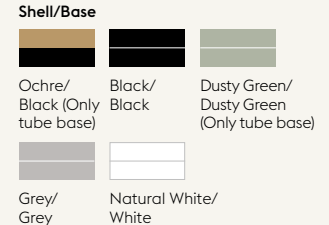

Fiber Side Chair Tube Base p. 9 upholstered in Forest Nap 912 & Forest Nap 552

**MADE-TO-ORDER INSPIRATION**

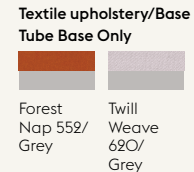

**MATERIAL**

The shell consists of a PP composition with up to 25% pine wood fibers and colored polypropylene. Option of textile and leather upholstered seat. Base in powder coated steel

**MADE-TO-ORDER OPTIONS**

Other approved textiles and leather upholsteries available as made-to-order options

Please note that the Ready-To-Ship Options may be subject to regional stock. Consult your Muuto dealer or refer to price list for further information



**FIBER ARMCHAIR SWIVEL BASE & SWIVEL BASE W. CASTORS**  
by Iskos-Berlin

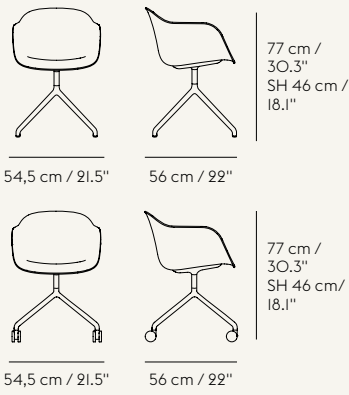

**READY-TO-SHIP OPTIONS**

**Shell/Base**

Ochre/Black	Black/Black	Dusty Green/Dusty Green
Grey/Grey	Natural White/White	

**Textile upholstery/Base Swivel Base only**

Remix 133/Grey	Remix 183/Black	Cognac Refine Leather/Black	Black Refine Leather/Black

**Leather upholstery/Base Swivel Base only**

**MADE-TO-ORDER INSPIRATION**

**Textile upholstery/base Swivel Base only**

Fiber Armchair Front Upholstery Swivel Base	Fiber Armchair Swivel Base
Balder 432/White	Balder 432/White

**MATERIAL**  
The shell consists of a PP composition with up to 25% pine wood fibers and colored polypropylene. Option of textile and leather upholstered seat. Base in powder coated aluminum or polished aluminum

**MADE-TO-ORDER OPTIONS**  
Front upholstery and full upholstery in other approved textiles or leather available made-to-order. Swivel Base w. Return, Swivel Base w. Castors and Swivel Base w. Castors and Gas Lift are made-to-order. Polished aluminum base available as made-to-order for EU versions w.o. Return and w. Return

Please note that the Ready-To-Ship Options may be subject to regional stock. Consult your Muuto dealer or refer to price list for further information

**FIBER SIDE CHAIR SWIVEL BASE & SWIVEL BASE W. CASTORS**  
by Iskos-Berlin

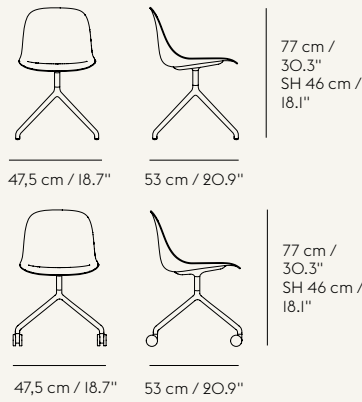

**READY-TO-SHIP OPTIONS**

**Shell/Base**

Ochre/Black	Black/Black	Dusty Green/Dusty Green
Grey/Grey	Natural White/White	

**Textile upholstery/Base Swivel Base only**

Remix 133/Grey	Remix 183/Black	Cognac Refine Leather/Black	Black Refine Leather/Black

**Leather upholstery/Base Swivel Base only**

Fiber Side Chair Swivel Base p. 4 upholstered in Twill Weave 780/Chrome

Fiber Side Chair Swivel Base p. 19 upholstered in Balder 432/White

**MADE-TO-ORDER INSPIRATION**

**Textile upholstery/base Swivel Base only**

Twill Weave 620/Grey	Twill Weave 780/Chrome	Balder 432/White

**MATERIAL**  
The shell consists of a PP composition with up to 25% pine wood fibers and colored polypropylene. Option of textile and leather upholstered seat. Base in powder coated aluminum or polished aluminum

**MADE-TO-ORDER OPTIONS**  
Full upholstery in other approved textiles or leather available made-to-order. Swivel Base w. Return, Swivel Base w. Castors and Swivel Base w. Castors and Gas Lift are made-to-order. Polished aluminum base available as made-to-order for EU versions w.o. Return and w. Return

Please note that the Ready-To-Ship Options may be subject to regional stock. Consult your Muuto dealer or refer to price list for further information

**FIBER COUNTER & BAR STOOL W. BACK TUBE BASE**  
by Iskos-Berlin



**READY-TO-SHIP OPTIONS**

**Shell/Base**

Black/Black	Grey/Grey	Natural White/White

**Leather upholstery/Base**

Cognac Refine Leather/Black	Black Refine Leather/Black

**MATERIAL**  
The shell consists of a PP composition with up to 25% pine wood fibers and colored polypropylene. Option of textile and leather upholstered seat. Base in powder coated steel

**MADE-TO-ORDER OPTIONS**  
Made-to-order textile and leather with base color option of Black, Grey, White, or Dusty Green

Please note that the Ready-To-Ship Options may be subject to regional stock. Consult your Muuto dealer or refer to price list for further information

**FIBER COUNTER & BAR STOOL W. BACK WOOD BASE**  
by Iskos-Berlin

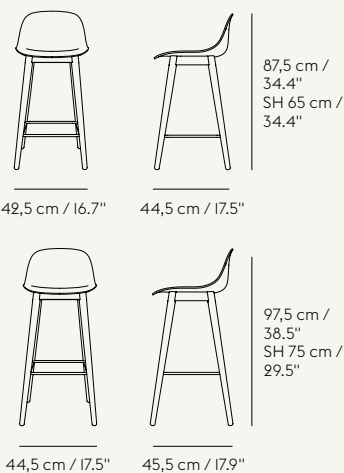

**READY-TO-SHIP OPTIONS**

**Shell/Base**

Black/Black	Grey/Grey	Natural White/Oak

**Leather upholstery/Base**

Cognac Refine Leather/Oak	Black Refine Leather/Black

**MATERIAL**  
The shell consists of a PP composition with up to 25% pine wood fibers and colored polypropylene. Option of textile and leather upholstered seat. Base in solid oak and plywood

**MADE-TO-ORDER OPTIONS**  
Made-to-order textile and leather with base color option of Black, Grey, Oak or Dusty Green

Please note that the Ready-To-Ship Options may be subject to regional stock. Consult your Muuto dealer or refer to price list for further information

**FIBER COUNTER & BAR STOOL TUBE BASE**  
by Iskos-Berlin



**READY-TO-SHIP OPTIONS**



**Leather upholstery/Base**



**MATERIAL**

The shell consists of a PP composition with up to 25% pine wood fibers and colored polypropylene. Option of textile and leather upholstered seat. Base in powder coated steel

**MADE-TO-ORDER OPTIONS**

Made-to-order textile and leather with base color option of Black, Grey, White, Dusty Green. Please consult your nearest Muuto dealer for further information

Please note that the Ready-To-Ship Options may be subject to regional stock. Consult your Muuto dealer or refer to price list for further information

**FIBER COUNTER & BAR STOOL WOOD BASE**  
by Iskos-Berlin



**READY-TO-SHIP OPTIONS**



**Leather upholstery/Base**

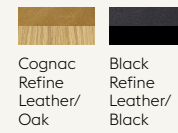

**MATERIAL**

The shell consists of a PP composition with up to 25% pine wood fibers and colored polypropylene. Option of textile and leather upholstered seat. Base in solid oak and plywood

**MADE-TO-ORDER OPTIONS**

Made-to-order textile and leather with base color option of black, grey, oak or dusty green. Please consult your nearest Muuto dealer for further information

Please note that the Ready-To-Ship Options may be subject to regional stock. Consult your Muuto dealer or refer to price list for further information

**FIBER STOOL TUBE BASE**  
by Iskos-Berlin



**READY-TO-SHIP OPTIONS**

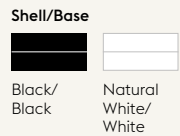

Fiber Stool Tube Base p. 42 upholstered in Cognac Refine Leather/Black

**MATERIAL**

The shell consists of a PP composition with up to 25% pine wood fibers and colored polypropylene. Option of textile and leather upholstered seat. Base in powder coated steel

**MADE-TO-ORDER OPTIONS**

Ochre/Black, Grey/Grey and Dusty Green/Dusty Green are available as made-to-order. Other approved textile upholstered versions available as made-to-order options

Please note that the Ready-To-Ship Options may be subject to regional stock. Consult your Muuto dealer or refer to price list for further information

**FIBER STOOL WOOD BASE**  
by Iskos-Berlin



**READY-TO-SHIP OPTIONS**



**MATERIAL**

The shell consists of a PP composition with up to 25% pine wood fibers and colored polypropylene. Option of textile and leather upholstered seat. Base in solid oak and plywood

**MADE-TO-ORDER OPTIONS**

Ochre/Oak, Grey/Grey and Dusty Green/Dusty Green are available as made-to-order. Other approved textile upholstered versions available as made-to-order options

Please note that the Ready-To-Ship Options may be subject to regional stock. Consult your Muuto dealer or refer to price list for further information



**FIBER LOUNGE CHAIR TUBE BASE**  
by Iskos-Berlin

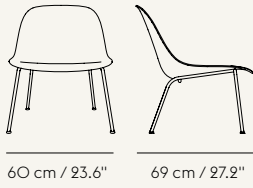

74,4 cm / 29.3"  
SH 38 cm / 15"

**READY-TO-SHIP OPTIONS**

**Shell/Base**



**Textile upholstery/Base**



**Leather upholstery/Base**

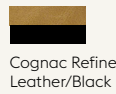

Fiber Lounge Chair Tube Base p. 40 upholstered in Cognac Refine Leather

**MATERIAL**

The shell consists of a PP composition with up to 25% pine wood fibers and colored polypropylene. Option of textile and leather upholstered seat. Base in powder coated steel

**MADE-TO-ORDER OPTIONS**

Other approved textiles or leather upholsteries available as made-to-order

Please note that the Ready-To-Ship Options may be subject to regional stock. Consult your Muuto dealer or refer to price list for further information

**FIBER LOUNGE CHAIR WOOD BASE**  
by Iskos-Berlin

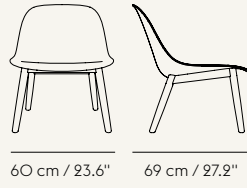

74,4 cm / 29.3"  
SH 38 cm / 15"

**READY-TO-SHIP OPTIONS**

**Shell/Base**



**Textile upholstery/Base**

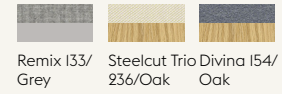

**Leather upholstery/Base**

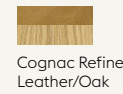

Fiber Lounge Chair Wood Base p. 40 upholstered in Steelcut Trio 236/Oak & Divina 154/Oak

**MATERIAL**

The shell consists of a PP composition with up to 25% pine wood fibers and colored polypropylene. Option of textile and leather upholstered seat. Base in solid oak and plywood

**MADE-TO-ORDER OPTIONS**

Other approved textiles or leather upholsteries available as made-to-order

Please note that the Ready-To-Ship Options may be subject to regional stock. Consult your Muuto dealer or refer to price list for further information

Furniture

**70 FIBER CHAIR SEAT PAD**  
by Iskos-Berlin

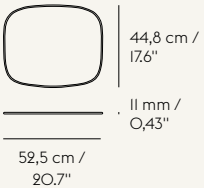

44,8 cm / 17.6"

11 mm / 0.43"

52,5 cm / 20.7"

**READY-TO-SHIP OPTIONS**



**MATERIAL**

Upholstered foam with black, anti-slip backing. Kvadrat textile or premium leather from European suppliers

Please note that the Ready-To-Ship Options may be subject to regional stock. Consult your Muuto dealer or refer to price list for further information

**OSLO SIDE CHAIR**  
by Anderssen & Voll

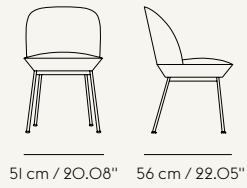

80,5 cm / 31.7"  
SH 45 cm / 17.75"

51 cm / 20.08" 56 cm / 22.05"

**READY-TO-SHIP OPTIONS**

**Textile upholstery/Base**



**MADE-TO-ORDER INSPIRATION**

**Textile upholstery/Base**



**MATERIAL**

Steel frame, moulded foam & textile from Kvadrat or Rohleder. Made-to-order textiles with option of anthracite black or chrome legs

**MADE-TO-ORDER OPTIONS**

Other approved textile upholsteries available as made-to-order

Please note that the Ready-To-Ship Options may be subject to regional stock. Consult your Muuto dealer or refer to price list for further information

**WORKSHOP CHAIR**  
by Cecilie Manz

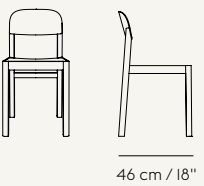

79 cm / 31"  
SH 45 cm / 17.75"

46 cm / 18"

**READY-TO-SHIP OPTIONS**



**MATERIAL**

Black lacquered oak, natural oak or Oregon Pine. Legs and frame made from solid wood. Back and seat made from veneer

**NERD CHAIR**  
by David Geckeler



**MATERIAL**  
Seat and back in form-pressed veneer. Legs in solid wood. All parts in water-based lacquer

**NERD COUNTER & BAR STOOL**  
by David Geckeler

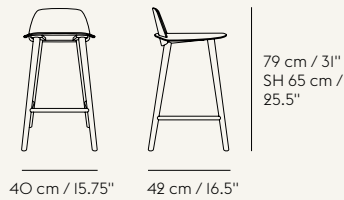

**MATERIAL**  
Seat and back in form-pressed veneer. Legs in solid wood. All parts in water-based lacquer

**MADE-TO-ORDER OPTIONS**  
Bar Stool in 75 cm, Counter stool in 65 cm seat height. Please consult your Muuto dealer for further information

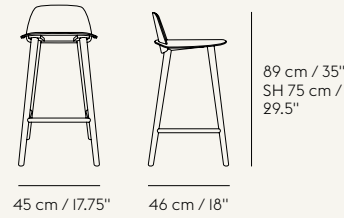

**LOFT CHAIR**  
by Thomas Bentzen

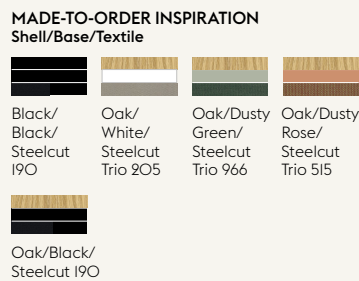
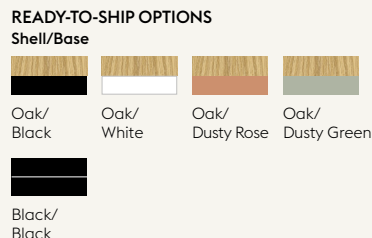
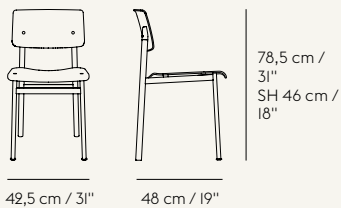

**MATERIAL**  
Back and seat in oak veneer. Frame in powder coated steel

**MADE-TO-ORDER OPTIONS**  
Variants with upholstered seat are available as made-to-order in a large range of approved textiles and colors

Please note that the Ready-To-Ship Options may be subject to regional stock. Consult your Muuto dealer or refer to price list for further information

**LOFT COUNTER & BAR STOOL**  
by Thomas Bentzen

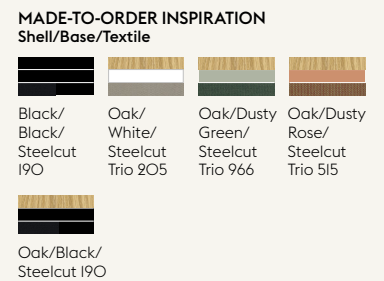
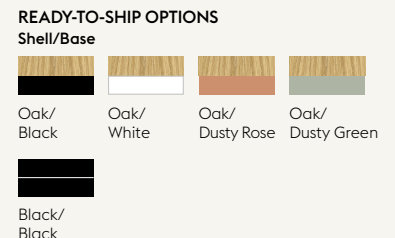
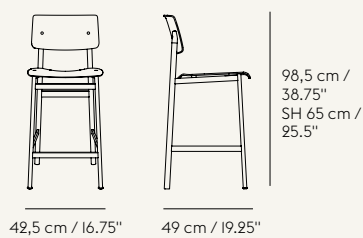

**MATERIAL**  
Back and seat in oak veneer. Frame in powder coated steel

**MADE-TO-ORDER OPTIONS**  
Variants with upholstered seat are available as made-to-order in a large range of approved textiles and colors

Please note that the Ready-To-Ship Options may be subject to regional stock. Consult your Muuto dealer or refer to price list for further information

**VISU CHAIR WOOD BASE**  
by Mika Tolvanen



78,5 cm / 31"  
SH 46 cm / 18"

46 cm / 18"      51 cm / 20"

**READY-TO-SHIP OPTIONS**

**Shell/Base**

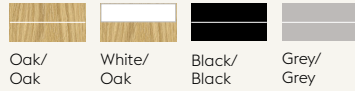

Sand/  
Sand

**MATERIAL**

Form-pressed ash or oak veneer shell and base, both in water-based lacquer with the option of textile or leather upholstery

**MADE-TO-ORDER OPTIONS**

Other approved textiles available as made-to-order options. Shell available with textile or leather upholstery

Please note that the Ready-To-Ship Options may be subject to regional stock. Consult your Muuto dealer or refer to price list for further information

**VISU CHAIR SLED BASE**  
by Mika Tolvanen

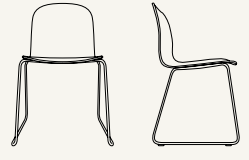

78 cm / 30.75"  
SH 46 cm / 18"

53,5 cm / 21"      50 cm / 19.5"

**READY-TO-SHIP OPTIONS**

**Shell/Base**



**MATERIAL**

Lacquered ash or oak veneer shell with the option of wood, textile or leather upholstered seat. Powder coated steel base. Up to 15 non-upholstered chairs can be stacked together

**MADE-TO-ORDER OPTIONS**

Approved textiles and leather available as made-to-order

Please note that the Ready-To-Ship Options may be subject to regional stock. Consult your Muuto dealer or refer to price list for further information

**VISU CHAIR TUBE BASE**  
by Mika Tolvanen



78 cm / 30.75"  
SH 46 cm / 18"

53,5 cm / 21"      50 cm / 19.75"

**READY-TO-SHIP OPTIONS**

**Shell/Base**



**MATERIAL**

Form-pressed ash or oak veneer shell in water-based lacquer with the option of textile or leather upholstery. Base in powder coated steel. Up to 15 non-upholstered chairs can be stacked together

Please note that the Ready-To-Ship Options may be subject to regional stock. Consult your Muuto dealer or refer to price list for further information

**VISU WIDE CHAIR WOOD BASE & SWIVEL BASE**  
by Mika Tolvanen



78,5 cm / 31"  
SH 45 cm / 17.75"

50 cm / 19.75"      55 cm / 21.75"

**MATERIAL**

Wood Base: Shell in ash or oak veneer shell with form-pressed veneer base, both in water-based lacquer

Swivel Base: Shell in ash or oak veneer with water-based lacquer. Swivel Base in powder coated aluminum. Castors from Tente

**MADE-TO-ORDER OPTIONS**

The Visu Wide Chair is a made-to-order design. Other approved textile or leather upholsteries are also available as made-to-order



78,5 cm / 31"  
SH 45 cm / 17.75"

50 cm / 19.75"      55 cm / 21.75"

Please note that the Ready-To-Ship Options may be subject to regional stock. Consult your Muuto dealer or refer to price list for further information

**VISU COUNTER & BAR STOOL**  
by Mika Tolvanen



78,5 cm / 31"  
SH 65 cm / 25.5"

42,7 cm / 16.75"      42,3 cm / 16.75"

**READY-TO-SHIP OPTIONS**

**Shell/Base**

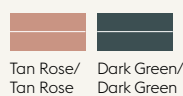
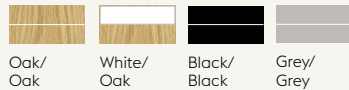

**MATERIAL**

Shell in form-pressed ash or oak veneer and base in solid wood—both in a water-based lacquer—alongside a powder coated or stainless steel footrest. Option of textile or leather upholstery.

**MADE-TO-ORDER OPTIONS**

Variants with upholstered seat are available as made-to-order in a large range of approved textiles and colors

Please note that the Ready-To-Ship Options may be subject to regional stock. Consult your Muuto dealer or refer to price list for further information

**VISU LOUNGE CHAIR**  
by Mika Tolvanen



69 cm / 27.25"  
SH 40 cm / 15.75"

60 cm / 23.5"      51 cm / 20"

**READY-TO-SHIP OPTIONS**

**Shell/Base**



**Textile upholstery/Base**



**MATERIAL**

Shell in ash or oak veneer with form-pressed veneer base, both in water-based lacquer

**MADE-TO-ORDER OPTIONS**

Other approved textiles available as made-to-order options

Please note that the Ready-To-Ship Options may be subject to regional stock. Consult your Muuto dealer or refer to price list for further information



**COVER ARMCHAIR**  
by Thomas Bentzen



**READY-TO-SHIP OPTIONS**

Oak	Black	Grey	Anthracite
Green			

**Upholstered seat/Leather**

Black	Cognac
Refine	Refine
Leather/	Leather/
Black	Oak

**Upholstered seat/Textile**

Remix 933/ Green	Remix 183/ Black	Remix 123/ Grey	Remix 252/ Oak

**MATERIAL**  
Backrest, armrest and seat in lacquered, form-pressed oak or ash veneer with frame in lacquered solid oak and beech wood

**MADE-TO-ORDER OPTIONS**  
Other approved textiles or leather upholsteries available as made-to-order

Please note that the Ready-To-Ship Options may be subject to regional stock. Consult your Muuto dealer or refer to price list for further information

**COVER LOUNGE CHAIR**  
by Thomas Bentzen

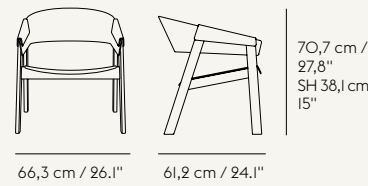

**READY-TO-SHIP OPTIONS**

Oak	Black	Grey

**Upholstered seat/Leather**

Black	Cognac
Refine	Refine
Leather/	Leather/
Black	Oak

**Upholstered seat/Textile**

Remix 123/ Grey

Cover Lounge Chair p. 37 in Cognac Refine Leather/Oak

**MATERIAL**  
Backrest, armrests and seat in lacquered oak or ash veneer. Frame in lacquered solid beech wood

**MADE-TO-ORDER OPTIONS**  
Other approved textiles or leather upholsteries available as made-to-order

Please note that the Ready-To-Ship Options may be subject to regional stock. Consult your Muuto dealer or refer to price list for further information

**COVER SIDE CHAIR**  
by Thomas Bentzen

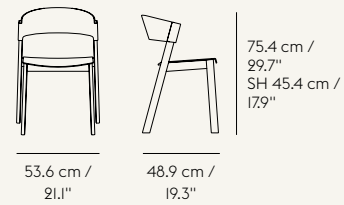

**READY-TO-SHIP OPTIONS**

Oak	Black	Grey	Green

**MADE-TO-ORDER INSPIRATION**  
**Upholstered seat/Leather**

Black	Cognac
Refine	Refine
Leather/	Leather/
Black	Oak

**Upholstered seat/Textile**

Remix 933/ Green	Remix 183/ Black	Remix 123/ Grey	Remix 252/ Oak

Cover Side Chair p. 27 in Cognac Refine Leather/Oak

**MATERIAL**  
Backrest and seat in form-pressed oak veneer. Base and legs in solid oak. All parts in a water-based lacquer. Non-upholstered Cover Side Chair stacks up to 5 chairs on the floor. Please note that upholstered chairs are not stackable

**MADE-TO-ORDER OPTIONS**  
Other approved textiles or leather upholsteries available as made-to-order

Please note that the Ready-To-Ship Options may be subject to regional stock. Consult your Muuto dealer or refer to price list for further information

# LIGHTING

## STRAND PENDANT LAMP by Benjamin Hubert

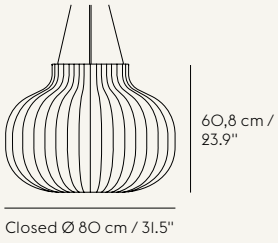

**MATERIAL**  
Steel structure covered with cocoon material. PVC cord, PVC covered steel wire

**LIGHT SOURCE**  
Ø28 & Ø40 Max. 40W  
Ø60 & Ø80 Max. 60W

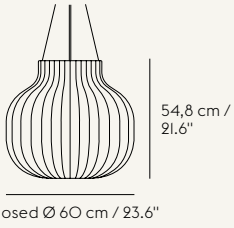

Lighting

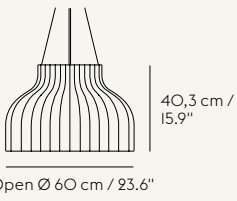

74



Please note that Strand Pendant Lamp Open Ø60, Closed Ø60 and Closed Ø80 come with a wire suspension system with three wires

## AMBIT PENDANT LAMP by TAF Studio

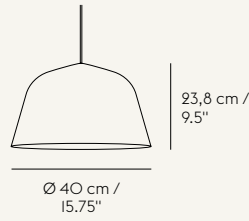

Ø 40 / Ø 25

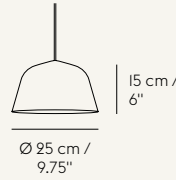

Ø 16,5

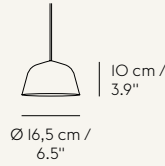
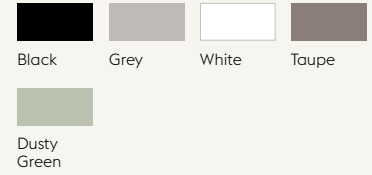

**MATERIAL**  
Spun aluminum shade, rubber cord

**LIGHT SOURCE**  
Ø16,5 cm EU version includes 3W LED bulb. Other sizes max 60W

Please note that Ø16,5 is not available in Beige-Green and that Ambit Pendant Lamp in Beige-Green all sizes are not available for sale in North America

## FLUID PENDANT LAMP by Claesson Koivisto Rune

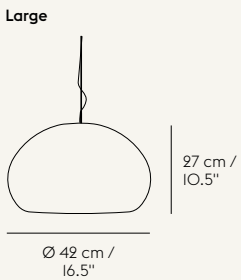

**MATERIAL**  
Silk matt opal glass, rubber cord, metal wire

**LIGHT SOURCE**  
Small: 3W LED bulb included  
Large: max. 60W, no bulb included

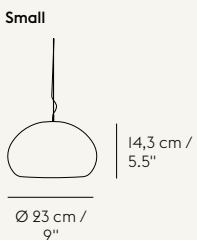

## AMBIT RAIL LAMP by TAF Studio

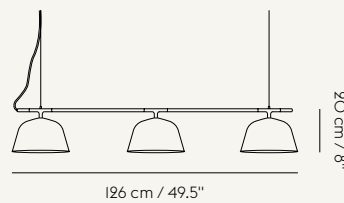

**MATERIAL**  
Rail made from cast and extruded aluminum. Shades in spun aluminum with a rubber cord and steel wires

**LIGHT SOURCE**  
Max. 60W

**E27 PENDANT LAMP**  
by Mattias Ståhlbom

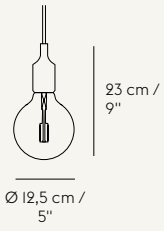

**MATERIAL**  
Silicone rubber

**LIGHT SOURCE**  
2W LED bulb included

**UNFOLD PENDANT LAMP**  
by Form Us With Love

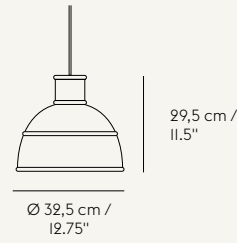

**MATERIAL**  
Silicone rubber

**LIGHT SOURCE**  
Max. 60W

**GRAIN PENDANT LAMP**  
by Jens Fager



**MATERIAL**  
Mixture of bamboo fibers and plastic, rubber cord

**LIGHT SOURCE**  
4W LED bulb included

**UNDER THE BELL PENDANT LAMP**  
by Iskos-Berlin

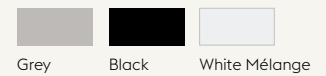
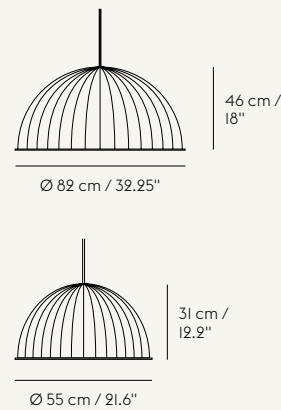

**MATERIAL**  
Recycled PET felt, rubber cord

**LIGHT SOURCE**  
Max. 30W

**STUDIO PENDANT LAMP**  
by Thomas Bernstrand

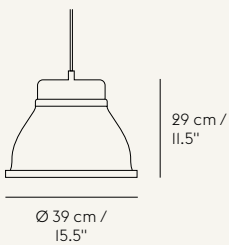

**MATERIAL**  
Solid aluminum, rubber cord

**LIGHT SOURCE**  
Max. 40W

Please note that Studio Pendant Lamp is not available for sale in North America



**COSY IN WHITE TABLE LAMP**  
by Harri Koskinen

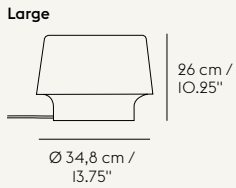

**MATERIAL**  
Mouth-blown opal glass, textile cord

**LIGHT SOURCE**  
Small: max. 40W  
Large: max. 60W

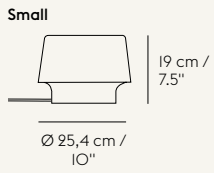

Please note that Cosy in White Lamp is not available for sale in North America

**COSY IN GREY TABLE LAMP**  
by Harri Koskinen

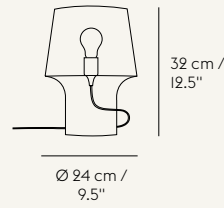

**MATERIAL**  
Mouth-blown soda lime glass, textile cord

**LIGHT SOURCE**  
Max. 60W

Please note that Cosy In Grey Lamp is not available for sale in North America

**TIP TABLE LAMP**  
by Jens Fager

Lighting

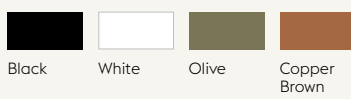
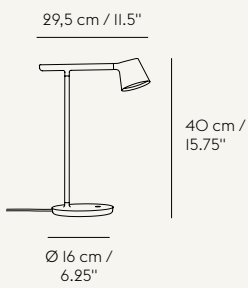

**MATERIAL**  
Casted aluminum, rubber cord

**LIGHT SOURCE**  
7W LED bulb integrated

**BEAM TABLE LAMP**  
by Tom Chung

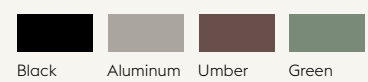
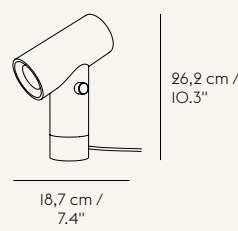

**MATERIAL**  
Extruded aluminum, PVC cord

**LIGHT SOURCE**  
Integrated IOW LED x 2

**76 FOCUS TABLE LAMP**  
by Andreas Bergsaker

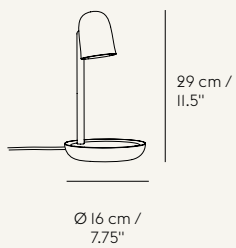

**MATERIAL**  
Turned ash wood, rubber cord

**LIGHT SOURCE**  
2W LED bulb integrated

Please note that Focus Table Lamp is not available for sale in North America

**WOOD TABLE LAMP**  
by TAF Studio

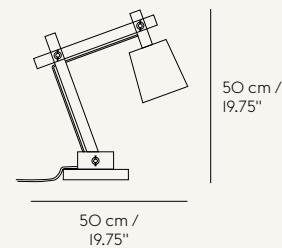

**MATERIAL**  
Pine wood, rubber cord

**LIGHT SOURCE**  
Max. 7W LED

Please note that Wood Table Lamp is not available for sale in North America

**CONTROL TABLE LAMP**  
by TAF Studio

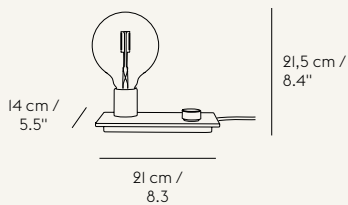

**MATERIAL**  
Casted aluminum, rubber cord

**LIGHT SOURCE**  
2W LED bulb included

**LEAF TABLE LAMP**  
by Broberg & Ridderstråle

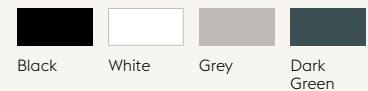
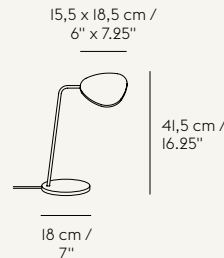

**MATERIAL**  
Aluminum, brass, rubber cord

**LIGHT SOURCE**  
8W LED bulb integrated

Please note that Leaf Table Lamp in Dark Green and Copper Brown is not available for sale in the Asian Pacific region

**LEAF FLOOR LAMP**  
by Broberg & Ridderstråle

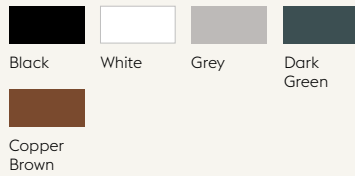
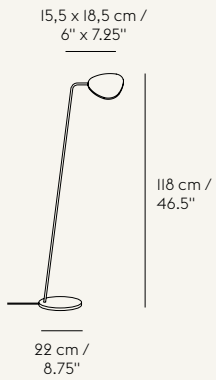

**MATERIAL**  
Aluminum, brass, rubber cord

**LIGHT SOURCE**  
8W LED bulb integrated

Please note that Leaf Floor Lamp in Dark Green and Copper Brown is not available for sale in the Asian Pacific region

**PULL FLOOR LAMP**  
by Whatswhat

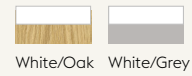
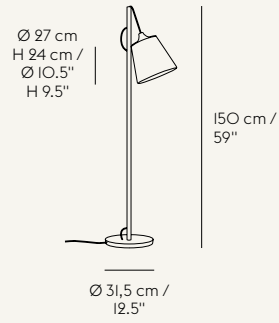

**MATERIAL**  
Oiled oak wood or grey lacquered oak wood, textile covered plastic shade, textile cord

**LIGHT SOURCE**  
Max. 60 W

Please note that Pull Floor Lamp is not available for sale in North America

**POST FLOOR LAMP**  
by Earnest Studio

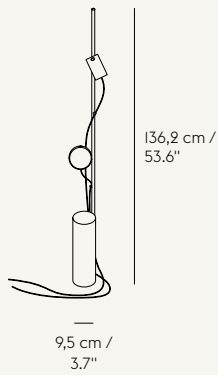

**MATERIAL**  
Base in powder coated steel. Lighting unit in powder coated magnesium with silicone cord and acrylic opal diffuser. Cable drops in powder coated plastic with magnet. Power hub in powder coated plastic with PVC cord

**LIGHT SOURCE**  
Integrated LED

**POST WALL LAMP**  
by Earnest Studio

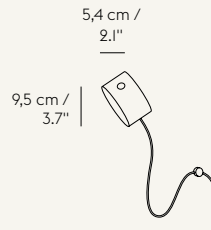

**MATERIAL**  
Lighting unit in powder coated magnesium with silicone cord and acrylic opal diffuser. Wall mounting bracket in powder coated steel. Wall cable drops in powder coated steel with magnet and repositionable adhesive tape. Power hub in powder coated plastic with PVC cord

**LIGHT SOURCE**  
Integrated LED

**AMBIT WALL LAMP**  
by TAF Studio

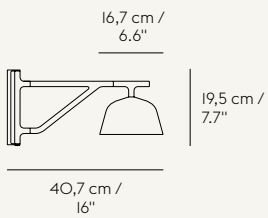

**MATERIAL**  
Handspun aluminum, PVC cord

**LIGHT SOURCE**  
5,5W LED bulb included

# ACCESSORIES

## DOTS WOOD by Lars Tornøe

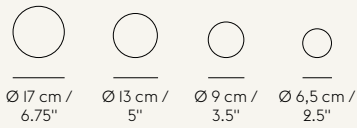

### MATERIAL

Oak, ash or walnut. Colored versions in ash wood

### AVAILABLE OPTIONS

All colors available in single packages. Oak, White, Black, Grey and Walnut also available in Set of 5 with 1 Ø17, 1 Ø13 and 3 Ø9 Dots

## DOTS METAL by Lars Tornøe

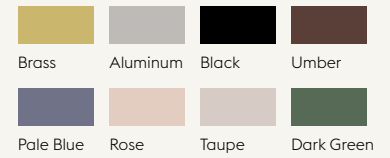

### MATERIAL

Solid brass, anodized solid aluminum or stainless steel with PVD vacuum treated surface

### AVAILABLE OPTIONS

All colors available in single packages and in a set of 5 with 1x Ø5, 1x Ø3,9 and 3x Ø2,7

## DOTS CERAMIC by Lars Tornøe

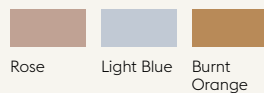
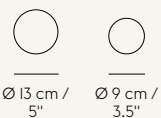

### MATERIAL

Earthenware with reactive glaze

### AVAILABLE OPTIONS

Both colors sold in single packages. Available in size Ø9 or Ø13.

## FOLDED SHELVES by Johan van Hengel

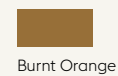
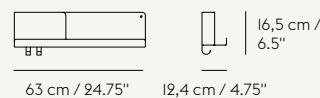
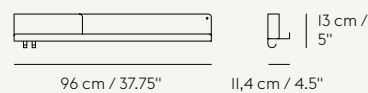

### MATERIAL

Acrylic powder coated steel

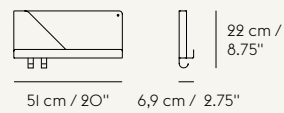

### EXTRA

All shelves come with two black bolts and two black hooks

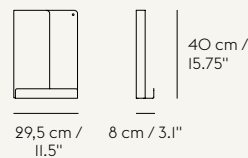

## ATTACH COAT HOOK by Dimitri Bähler

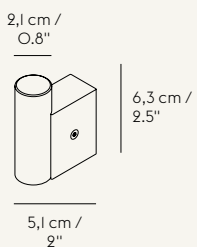

### MATERIAL

Base in aluminum, hook in oak

### AVAILABLE OPTIONS

Sold in set of two



**RESTORE BASKET**  
by Mika Tolvanen



35 x 48 cm /  
13.75" x 19"



**MATERIAL**  
Polymer PET felt

**RESTORE TRAY**  
by Mika Tolvanen



31 x 40 cm /  
12.25" x 15.75"



**MATERIAL**  
Polymer PET felt

**RESTORE ROUND BASKET**  
by Mika Tolvanen



Ø 51 cm /  
20"



**MATERIAL**  
Polymer PET felt

**COMPILE BOOKEND**  
by Cecilie Manz

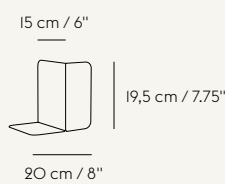

**MATERIAL**  
Powder coated steel

**FRAMED MIRROR**  
by Anderssen & Voll

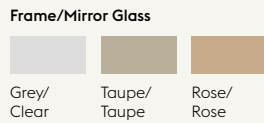
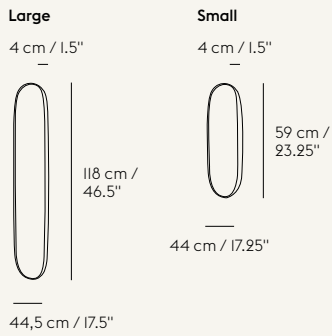

**MATERIAL**  
Powder coated steel, mirror glass sheet

**TUB JUG**  
by Atelier BL119

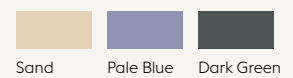
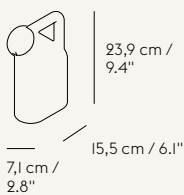

**MATERIAL**  
Stoneware with glaze

**CORKY CARAFE & GLASSES**  
by Andreas Engesvik

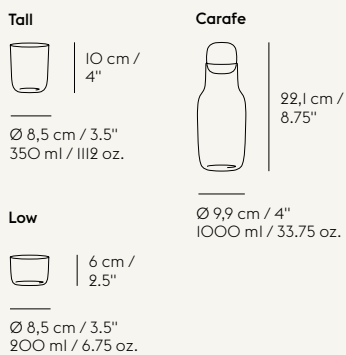

**MATERIAL**  
Glass, cork

## PLATFORM TRAY

by Sam Hecht & Kim Colin

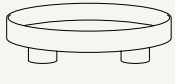

7,2 cm /  
2.75"

Ø 30 cm /  
11.75"

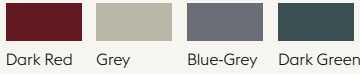

Dark Red Grey Blue-Grey Dark Green

### MATERIAL

Tray in ABS, insert in laminated oak veneer

## GROOVE TRIVET

by Hallgeir Homstvedt

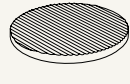

2 cm / 0.75"

Ø 21,6 cm / 8.5"



2 cm / 0.75"

Ø 16 cm / 6.25"

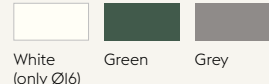

White  
(only Ø16) Green Grey

### MATERIAL

Solid marble

## OPEN CANDELABRA

by Jens Fager

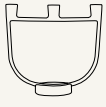

20 cm /  
7.5"

21 cm /  
8.25"

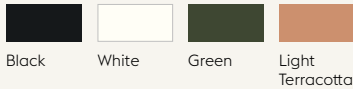

Black White Green Light  
Terracotta

### MATERIAL

Powder coated aluminum alloy

## FLOAT CANDLESTICK

by Anderssen & Voll



2,6 cm / 1"

15 x 11,4 cm /  
6" x 4.5"



Sand Yellow Tangerine

### MATERIAL

Cast aluminum

## ELEVATED VASE

by Thomas Bentzen



21,9 cm /  
8.5"

Ø 16,7 cm /  
6.5"



Green Grey Rose

### MATERIAL

Mouth blown glass, solid ash wood

## SILENT VASE

by Andreas Engesvik



19 cm /  
7.5"

Ø 15 cm /  
6"

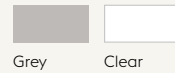

Grey Clear

### MATERIAL

Mouth-blown glass

## RIDGE VASE

by Studio Kaksikko



10,5 cm /  
4.3"

48,5 cm /  
19"

31 cm /  
12.2"

8,5 cm /  
3.4"

35 cm /  
13.8"

23 cm /  
9.2"

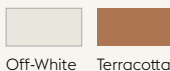

Off-White Terracotta

### MATERIAL

Terracotta made of terracotta. Off-White made of earthenware. Glazed inside, raw outside

## KINK VASE

by Earnest Studio

12,9 cm /  
5"



26,3 cm /  
10.3"

27,4 cm /  
10.8"



Sand Light Blue

### MATERIAL

Pigmented porcelain

## PEBBLE RUG

by Margrethe Odgaard

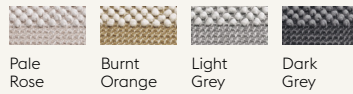
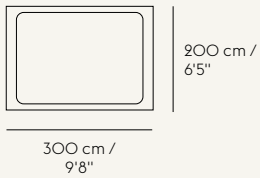

**MATERIAL**  
60% New Zealand wool & 40% jute

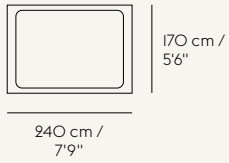

Please note that all sizes of the Pebble Rug have a sizing toleration of + / - 2%, meaning that the dimensions of the rug can differ by a maximum of 2%

## VARJO RUG

by Tina Ratzer

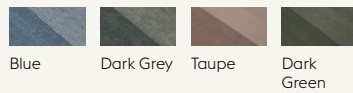
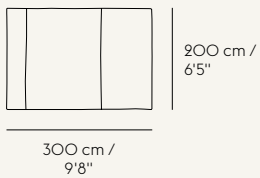

**MATERIAL**  
100% New Zealand wool

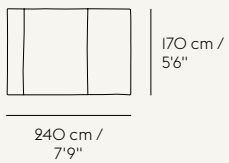

## RHYTHM THROW

by Aiayu

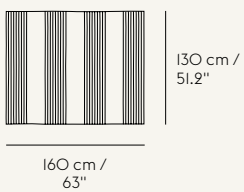

**MATERIAL**  
100% baby llama wool

## PLY RUG

by Margrethe Odgaard

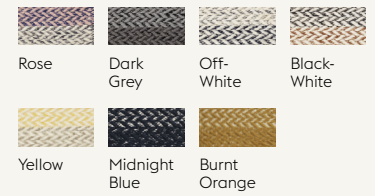
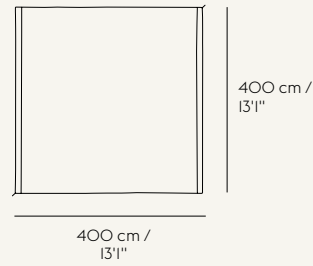

**MATERIAL**  
100% New Zealand wool

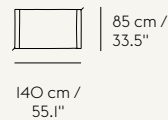
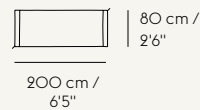
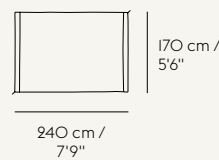
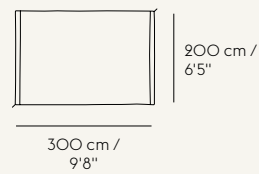
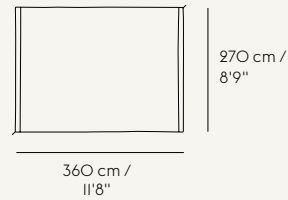

Please note that 400 x 400 and 270 x 360 are not available in Burnt Orange

## AMPLE THROW

by Aiayu

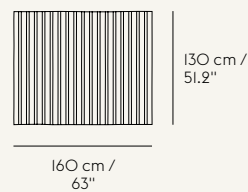

**MATERIAL**  
100% baby llama wool

## SWAY THROW

by Tina Ratzer

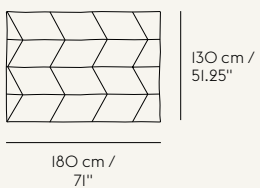

**MATERIAL**  
100% fine merino wool

## LOOM THROW

by Simon Key Bertman

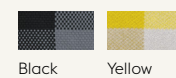
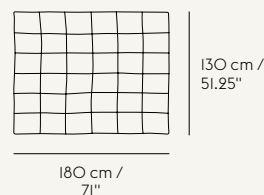

**MATERIAL**  
100% cotton



**RIPPLE THROW**  
by Margrethe Odgaard

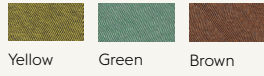
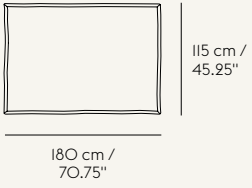

**MATERIAL**  
100% cotton

**ACCENT CUSHION**  
by Margrethe Odgaard

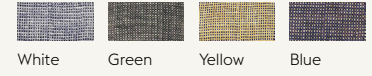
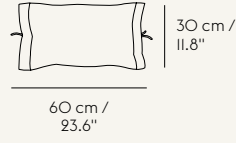

**MATERIAL**  
Fabric: 100% cotton with silk print  
Filling: Polyester

Accessories

**LAYER CUSHION**  
by Aiayu

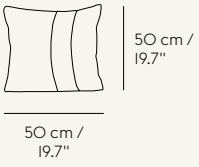

**MATERIAL**  
Fabric: 100% baby llama wool  
Inner Sham: 100% cotton  
Filling: Mix of feather and polyfiber

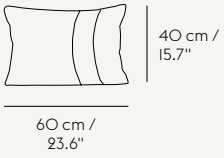

**TWINE CUSHION**  
by Aiayu

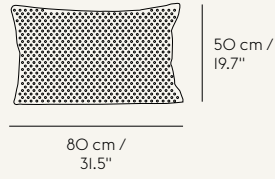

**MATERIAL**  
Fabric: 100% baby llama wool  
Inner Sham: 100% cotton  
Filling: Mix of feather and polyfiber

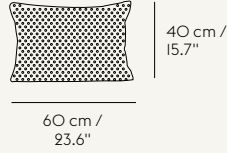

**TILE CUSHION**  
by Anderssen & Voll

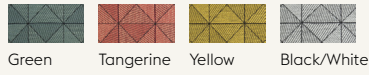
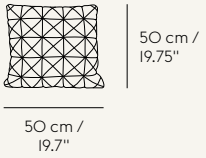

**MATERIAL**  
Fabric: 100% wool woven at Gudbrandsdalens Uldvarefabrik in Norway for Muuto.  
Filling: Mix of feather and polyester

Please note that Tile Cushion is not available for sale in North America

# QUALITY & ENVIRONMENT

## CRAFTING HIGH-QUALITY DESIGN

### MODERN MATERIALITY

Our products are designed to last through long-lasting expressions and high-quality production, factors that in themselves ease our impact on the environment. Working from an ambition to create new perspectives on Scandinavian design, we're motivated to work with innovative materials that lessen the burden on our planet. Take the Restore Series and Under The Bell Pendant Lamp, both made using recycled PET bottle fibers as well as our Fiber Chair Family, created with an innovative shell with up to 25% pine wood fibers. Adding to that, all wooden parts within the Fiber, Nerd and Visu Chair Series are made in an environmentally friendly, water-based lacquer. Being a Scandinavian design company, wood appears in many of our designs with oak, beech, pine and ash being the most common types, all of them being sorts that are non-endangered, sourced from sustainably managed forests.

### LONGEVITY IN DESIGN

We place the highest importance on creating products with a long lifespan in both their expression and quality. We source our raw materials with the greatest care and view sustainability as an integral part of our Scandinavian design ethos. Craftsmanship is a focal element in our design process while valuing the functional, long-lasting properties of our designs. To ensure that our designs have a high durability that will allow for them to be used in your home for many years into the future, extensive testing is at the heart of our development process alongside producing in accordance with ethical guidelines and environmental requirements.

### CERTIFICATES & TESTING

As an integral part of our design process, most of the furniture within the Muuto collection has passed extensive testing within the areas of strength and stability across various levels of the ANSI/BIFMA and EN-tests. As part of the aim to create products that lessen the impact on the environment, Muuto also participates in Declare with a selection of furniture being Living Building Challenge Compliant. Adding to that, a number of Muuto furniture designs are Global GreenTag GreenRate Level C certified.

We view responsible manufacturing processes as integral to our design philosophy. All manufacturers and suppliers of Muuto adhere to the United Nations principles of human rights, anti-corruption and non-use of child labor, as outlined in the United Nations Global Compact.

Visit [Muuto.com/Quality-Environment](https://Muuto.com/Quality-Environment) to learn more about our design approach, tests, certificates and more.







Artworks by

Andredottir & Bobek  
 Anne Brandhøj  
 Anne Nowak  
 Else-Rikke Brun  
 Grape  
 I Rosens Navn  
 Juliette Berthonneau  
 Kristine Mandsberg  
 Linda Weimann  
 Line Busch  
 Malene Bach  
 Mette Sandfær  
 Mette Vinther  
 Michael Lyngø  
 Noa Gammelgaard  
 Peter Holm  
 Pernille Hell  
 Tilde Grynnerup  
 Ursula Nistrup  
 Vic Wright

Muuto Head Office  
 Østergade 36-38  
 DK-1100 Copenhagen, Denmark

For more information  
 visit [muuto.com](http://muuto.com)

Join Us:

Sign up to our newsletter or follow us on social media to stay in the loop on new product releases, case stories and events.

[muuto.com/newsletter](http://muuto.com/newsletter)  
[instagram.com/muutodesign](https://www.instagram.com/muutodesign)  
[pinterest.com/muuto](https://www.pinterest.com/muuto)  
[facebook.com/muuto](https://www.facebook.com/muuto)  
[twitter.com/muutodesign](https://twitter.com/muutodesign)

Downloads:

Find 2D, 3D & Revit files, packshots, lifestyle images, product fact sheets and much more on our download site

[download.muuto.com](http://download.muuto.com)





By the leading  
contemporary designers:

Aiayu  
Anderssen & Voll  
Andreas Bergsaker  
Andreas Engesvik  
Atelier BLI19  
Benjamin Hubert  
Broberg & Ridderstråle  
Cecilie Manz  
Claesson Koivisto Rune  
David Geckeler  
Dimitri Bähler  
Earnest Studio  
Form Us With Love  
Hallgeir Homstvedt  
Harri Koskinen  
Iskos-Berlin  
Jens Fager  
Johan van Hengel  
Julien De Smedt  
Lars Tornøe  
Margrethe Odgaard  
Mattias Ståhlbom  
MSDS Studio  
Mika Tolvanen  
Normal Studio  
Sam Hecht & Kim Colin  
Simon Key Bertman  
Staffan Holm  
Studio Kaksikko  
Søren Rose Studio  
TAF Studio  
Thomas Bentzen  
Thomas Bernstrand  
Tina Ratzler  
Tom Chung  
Whatswhat

MULTI  
COM.

Styling:  
Pernille Vest

Photography:  
Petra Bindel / Mikkel Tjellesen / Gils

Printing:  
Narayana Press

Subject to printer's errors