



































OUTDOOR LIGHTING  
FRANCE



















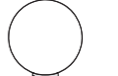











ROGER  
PRADIER

# Contemporary

	COLLECTION	PAGE	IP ≥ 55			
	Aubanne	120			Lampiook	22 •
	Bamboo	130	•		Loko	92
	Bermude	108			Mona	50 •
	Blok	88	•		Noctiluque	84 •
	Brick <sup>2</sup>	36			OL 1	134 •
	Duo	126			OL 2	138 •
	Equix	148	•		OL 3	142 •
	Factory	112			Picto	58 •
	Grumo	76	•		RP195	32 •
	Hugy	72	•		Séléné	68 •
	Ibuk	62	•		Sherlock	54 •
	Kent	100			Square	152 •
	Kerlouan	116			Stratos	80
	Kirlan	156	•		Surf	104
	Klint	28	•		Tank	96 •
	La Hutte	18	•		Tetra	42 •
					Tools	46 •

# Heritage

	COLLECTION	PAGE	IP ≥ 55		Contemporary
	Avenue 2	172			
	Avenue 3	178			Heritage
	Avenue 4	184	•		
	Belcour	270			Monaco
	Boléro	290			Montana
	Boréal	294			Moon
	Bristol	276			Newpark
	Chenonceau	166			Phoros
	Citadelle	218	•		Place des Vosges 1 Évolution
	Corum	262			Place des Vosges 1 Tradition
	Dallas	306			Place des Vosges 2
	Louis Philippe 1	190			Place des Vosges 3
	Louis Philippe 2	194			Trophy
	Louis Philippe 7	198			Victoria
	Louis XIII	212			Vieille France
	Louvre	224	•		Annexes Sockets, photosensors, accessories, colour chart

# Editorial

---

Roger Pradier® has been lighting the exteriors of houses, hotels and restaurants, and illuminating gardens, terraces and public spaces for over a century – following the one guiding principle of uncompromising quality.

Everyone in our team shares the desire to dream up designs for finished products that will serve you faithfully for a long time. Harking back to the traditional values of metalsmithing, our 25-year warranty against corrosion is a pledge of our commitment. We're tremendously proud that our outstanding craftsmanship has earned us the coveted Entreprises du Patrimoine Vivant label, which recognises businesses that keep alive the 'living artisanal and cultural heritage' of France. No wonder the Presidential Elysée Palace trusts us to light up its terraces...

When Tristan De Witte took the helm at Roger Pradier® in January 2017, he brought fresh ideas. A new Paris office that's set to open in early 2018. Bringing onboard the editing house for designer lighting, Artuce, whose designers Patrick Norguet, Normal Studio, Cédric Ragot, Philippe Nigro, and matali crasset's pieces feature in our 2018-2019 catalogue. A total digital transition, including a new product coding system. A stronger focus on marrying technology with design, spearheaded by our creative director Stéphane Joyeux and exemplified by products from a select few designers whose work enhances our brand. We also have international ambitions with plans to raise the profile of our brilliant brand with its touch of French je ne sais quoi.





# Roger Pradier® warranties



## 25 years anti-corrosion warranty

The Roger Pradier® company commits itself to replace any faulty part that shows sign of corrosion in a period of 25 years from the date of acquisition by the final client, upon presentation of the purchase invoice.

The guarantee applies only to the aluminium part of Roger Pradier® products installed above ground in accordance with industry standards and with the original surface treatment being intact.

Exclusions: products that are scratched, scored, covered with silicone, cement, or any other material, or that have suffered collision or various chemical treatments. This guarantee also excludes any phenomenon that may modify the aspect of the covering over time, natural dirt, deposits of all types, etc...

For the guarantee to be applied, it requires a return to the factory of the product(s) concerned. No exchange prior to that return can be considered. The Roger Pradier® company will replace only the damaged part and not the entire device, net of carriage costs as well as costs relating to the assembly and installation.

The Roger Pradier® company reserved the right to analyse or to have analysed, by any method of its choice, the damaged caused by corrosion, in order to determine the reliability and the conditions of the said damage.

In any event, this guarantee does not apply to the various electrical components and accessories of the product.

## 3 years technical warranty

Other than the specific 25-Year Anti-Corrosion Warranty, Roger Pradier® products are guaranteed for 3-years. The technical warranty covers over a 3-years period from the date from the acquisition date by the end client, upon presentations of the purchase receipt. This warranty shall only apply to products installed according to current practice and which are used in conformance with our recommendations. Any intervention or modification made to the product and its components is expressly excluded from this warranty.

In order to be applied, warranties require that the products concerned be returned to the factory where they came from. Prior to this, no exchange will be considered. Roger Pradier® will only replace the damaged part and not the whole device; shipping, dismantling and installation costs are excluded.

## Roger Pradier®'s sales commitment

- A century's worth of experience as a French manufacturer of outdoor lighting devices
- Widely acknowledged expertise
- A culture of quality
- External inspections  
(LCIE Bureau Veritas Laboratoire Central des Industries Electriques; CTIF Centre Technique Industriel Fonderie; INTERTEK Laboratoire International d'Inspection et Certification...).



# Know-how

- Research
- Creation
- Innovation
- Design
- Manufacturing
- Development
- Products control
- Tooling
- Bending
- Stamping
- Metal spinning
- Welding
- Surface treatment
- Painting
- Assembly
- Electrification assembly
- Shipments
- After-sales service
- Advice
- Tailor-made
- Photometric studies

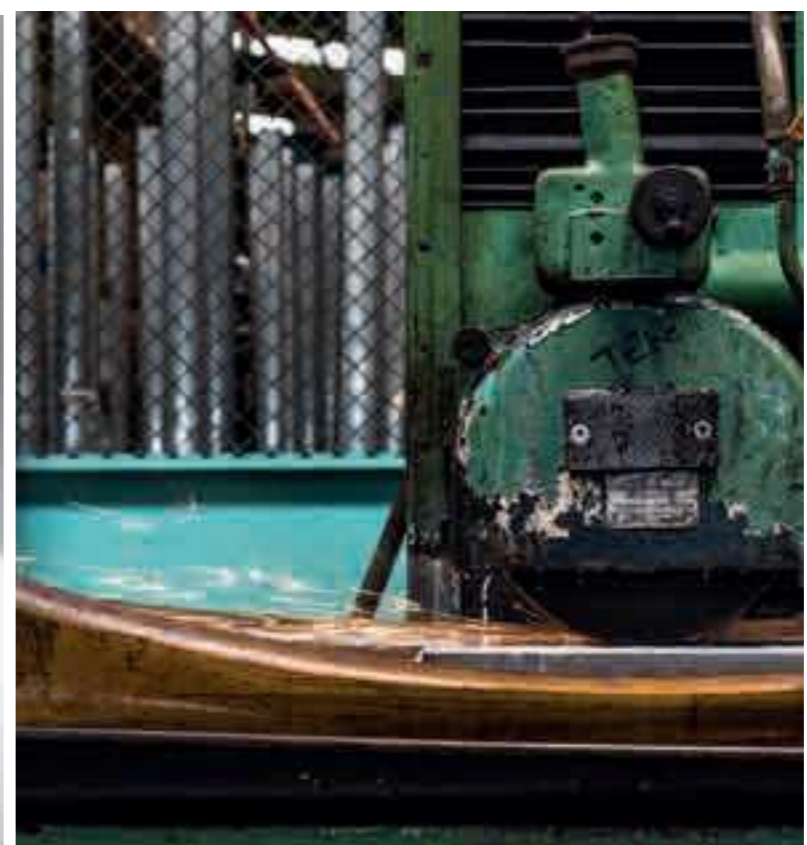
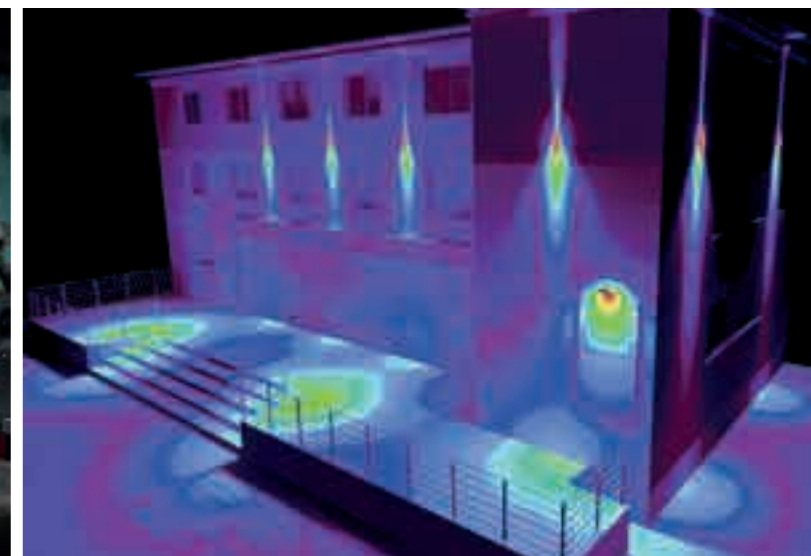
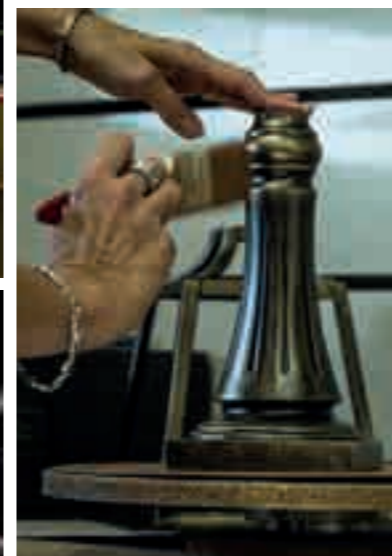

# The team

01. Alain Sales Administration Manager
02. Amandine Computer Graphics Designer
03. Aurélien IT & Industrial Tooling Manager
04. Bertrand Industrial Designer
05. Brigitte Spot Welding Machine Operator
06. Bruno Sales Manager - Northeastern region
07. Carole Assembly Operator
08. Cécile Sales Manager - Île-de-France region
09. Chamouini Welder
10. Christelle Assembly Operator
11. Christiane Assembly Operator
12. Christine Surface Treatment Operator
13. Christine Sales Manager - Southern region
14. Christophe Sales Manager - Central Southwestern region
15. Christophe Purchase Manager
16. Claudie Assembly Operator
17. Denis Assembly Operator
18. Eric Metalworking Manager
19. Fabien Order Picker
20. Fleur Export Sales Assistant
21. Guy Maintenance Manager
22. Guy Welder
23. Isabelle Assembly Operator
24. Jacky Client Invoicing Officer
25. Jérôme Surface Treatment Operator
26. Johann Surface Treatment Operator
27. Julie Assembly Operator
28. Julie Spot Welding Machine Operator
29. Julien Sales Manager - Rhône-Alpes region
30. Julina Sales Manager - Germany
31. Laurence Assembly Manager
32. Lionel Forklift Driver & Receiving Clerk
33. Manon Accountant
34. Marie Communication Manager
35. Mathilde Sales Assistant
36. Maud Sales Assistant
37. Nathalie Spot Welding Machine Operator
38. Pascal Administration & Finance Manager
39. Patrice Design Production Manager
40. Philippe Welder
41. Philippe Sales Manager - Western region
42. Régine Assembly Operator
43. Roland Press Machine Operator
44. Sébastien Press Machine Operator
45. Stéphane Creative Director
46. Thibaud Export Manager
47. Thierry Technical Director
48. Yvan Industrial Designer

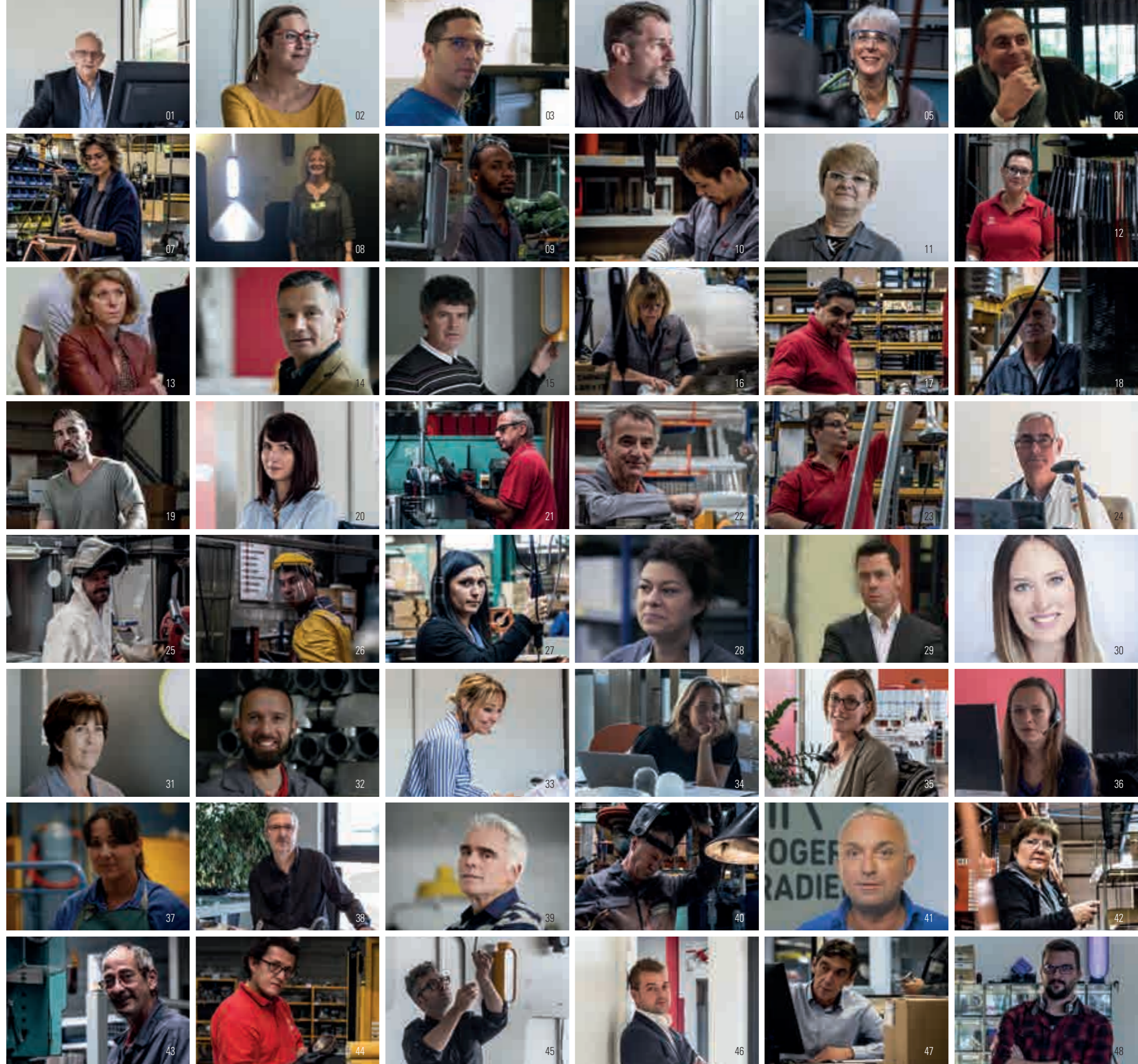

# Designers



© Le Goff & Gabarra

## Stéphane Joyeux

Creative Director of Roger Pradier® since 2001, Stéphane Joyeux holds a diploma from the Creapole-Esdi Design School.

With a solid grounding in every stage of the industrial design process – research, dimensional modelling, prototype testing – he’s an expert at developing technical solutions. He has undertaken collaborative gigs in the automotive, sports and electrical industries with the likes of Plasto Design, Salomon, and Arnould, so his intuitive approach is informed by additional know-how specific to these fields.

It was Stéphane who launched Roger Pradier®’s contemporary ranges of outdoor lighting. Taking the helm of the entire design process, he does his share of sketching and modelling, and provides creative oversight every step of the way.

Excellence and utility are his watchwords. He enjoys balancing ingenuity with design to address the ethical, environmental and sustainability issues inherent in lighting engineering. For Stéphane, every lamp represents an aesthetic challenge, embodying his personal commitment to design first-rate products that meet today’s standards on criteria like energy efficiency and longevity.

He’s known for the innovative form and playful feel of his lighting fixtures, including Equix, Picto, Grumo, Brick, Bamboo, Sherlock, RP195, and the Ibuk wall light, which won the 2015 VIA Award for its originality.

His design approach interweaves childhood memories and innovation with technical understanding, so that after the initial surprise, you see that utility is the only remaining reason...



© Julien Jouanjus

## matali crasset

La Hutte

matali crasset, an industrial designer by training, experiences design as a form of seeking. The offbeat stance she takes as her starting point informs her interventions in the everyday, and prompts imagined scenarios for the future.

Her knowledgeable – yet always fresh – worldview leads her to question the unassailable nature of conventions, all the better to break free of them. She operates in many spheres, her interventions always linked to her encounters. Eclectic collaborations – from handicrafts to contemporary art, from the textile industry to fair trade – have led to her working in scenography, furniture, architecture, graphic design and art. So far, her associates on various projects include artist Peter Halley, up-and-coming designer furniture companies, local authorities (Geneva Cité Library, the town of Istres) and local communities.

With this wealth of creative practice under her belt, matali is now veering towards increasingly participative projects, working at both local and global scale, and in rural as well as urban settings.

Her fictional inventions, her narratives, and the meaning of her work are essentially bound up with the question of community and living together.

matali crasset designed the La Hutte line for Roger Pradier®’s 2018-2019 catalogue.



© Dimitri Coste

## Patrick Norguet

Tools

French industrial designer Patrick Norguet has taken an unusual career path in his pursuit of the flawless line. He’s well known among the big names of high-end designer furniture, both in France and internationally. A fateful meeting with Giulio Cappellini in 1999 and the subsequent release of his famous Rainbow Chair propelled Patrick into the top ranks of the design elite.

There’s a very French elegance and ‘fittingness’ about his pieces, whether they’re intended for the masses or a more upscale market.

Norguet’s work has won a long string of awards, along with a place in the permanent collection of New York’s MoMA and in the Museum of Modern Art in Miami.

In creating his timeless, beautifully balanced objects, he draws inspiration from the world around him, and from the generous spirit of people he meets.



© Morgane Le Gall

## Normal Studio

Séléné

Working together as Normal Studio, design duo Jean-François Dingjian and Eloi Chafaï promote a kind of design stripped back to its most fundamental. Their name dissimulates a yearning for perfect form. The timeless objects they produce fly in the face of fashion and posturing, reflecting their strong belief in the social and cultural values of design.

By 2016 when Normal Studio celebrated its first decade on the French scene, it already had a pile of accolades to its name. The Design/Enterprise award at Designers’ Day 2010 honoured the team’s collaboration with Tolix, where they were creative directors from 2007 to 2013. They won 2010 Designer of the Year at Maison & Objet’s Now! Show, followed by the Elle Deco Design Award, and numerous VIA labels. Some of their products are now held in the collections of the French Museum of Decorative Arts and the Fonds National d’Art Contemporain (France’s state-owned contemporary art collection).

Normal Studio designed Séléné for Roger Pradier®, a range that was awarded the 2011 VIA Label.

# Designers



© VLappartement

## Philippe Nigro

Noctiluque

Philippe Nigro is a French designer who divides his time between France and Italy. His work is at the intersection of experimentation and pragmatic analysis, informed by the in-depth specialisms he’s picked up from the clients he works with.

Over the years his breadth of experience, shored up by a combination of Franco-Italian culture, has enabled him to navigate between projects of very varied types and scales – today he’s equally comfortable working with industry, furniture editors or craftspeople. With this background, he’s able to tackle a wide spectrum of design issues.

2014 saw him voted Designer of the Year at the Maison & Objet Paris show, and he was in charge of scenography for the Triennale Design Museum’s 7th edition expo, Italian Design Beyond the Crisis. He designed the Lexus exhibit for the 2015 Milan Furniture Fair, and also created an overall concept for the Japanese car company’s stand at the 2017 auto shows.



© Tristan Everhard

## Cédric Ragot

Tank

A multi-talented French designer influenced by contemporary art, Cédric Ragot has marked the design world with the sensitive, intuitive aesthetics of his sober objects.

This prolific designer set up Cédric Ragot Design Studio in 2002 to work alongside big-name brands on development and positioning.

A very intuitive designer, Ragot has been recognised with numerous accolades. Some of his pieces are in the Fonds National d’Art Contemporain and on display in Paris, Hannover, Vienna, New York, or Milan.

With his latest design, Tank, he leaves the abiding imprint of his talent on Roger Pradier®.



# Contemporary

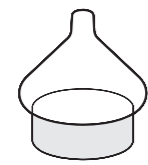

La Hutte  
p. 18

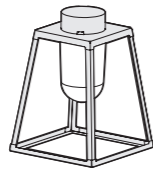

Lampiok  
p. 22

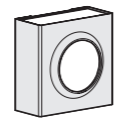

Klint  
p. 28

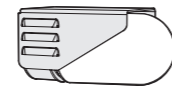

RP195  
p. 32



Brick²  
p. 36



Tetra  
p. 42



Tools  
p. 46



Mona  
p. 50

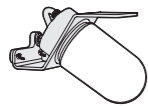

Sherlock  
p. 54



Picto  
p. 58

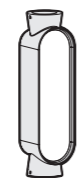

Ibuk  
p. 62

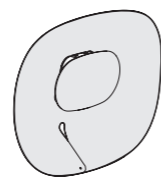

Séléne  
p. 68

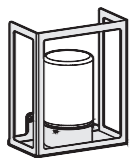

Hugy  
p. 72



Grumo  
p. 76

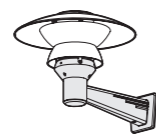

Stratos  
p. 80

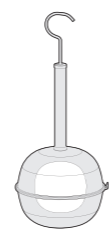

Noctiluque  
p. 84

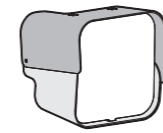

Blok  
p. 88



Loko  
p. 92



Tank  
p. 96

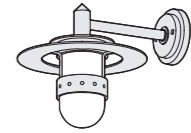

Kent  
p. 100

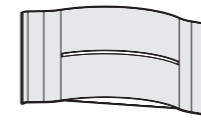

Surf  
p. 104

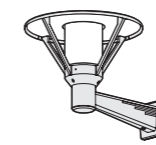

Bermude  
p. 108

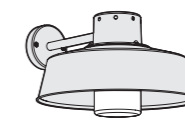

Faktory  
p. 112

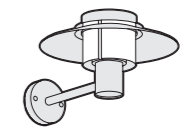

Kerlouan  
p. 116

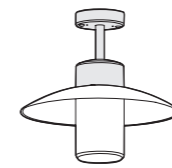

Aubanne  
p. 120



Duo  
p. 126

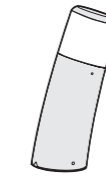

Bamboo  
p. 130

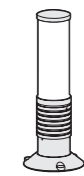

OL 1  
p. 134

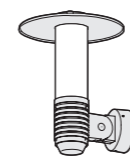

OL 2  
p. 138

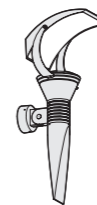

OL 3  
p. 142

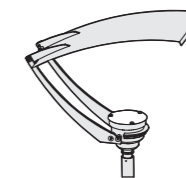

Equix  
p. 148

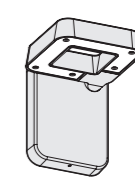

Square  
p. 152

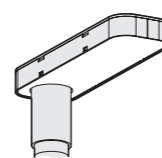

Kirlan  
p. 156

# La Hutte

Design by Matali Crasset

---

The "La Hutte" lamp draws inspiration from the shape of a primitive hut, a circular shelter built around the fire that was essential to life.

Its protective glass casing is like the walls of a house, storing and then releasing photons. "La Hutte" is a shelter, a kindly presence that reproduces the warmth and light of a home fire.

The lamp consists of two elements: a metal base available in all colours, and a transparent blown glass upper.

The design comes in three versions, either a table lamp, a model you can put on the floor, or a floor lamp.



# La Hutte

IP65  
IP20 (version with switch available on request)  
Class 2

Aluminium  
Clear glass diffuser

## SOURCE

E27 - 23W max

## MODELS

height / width / depth

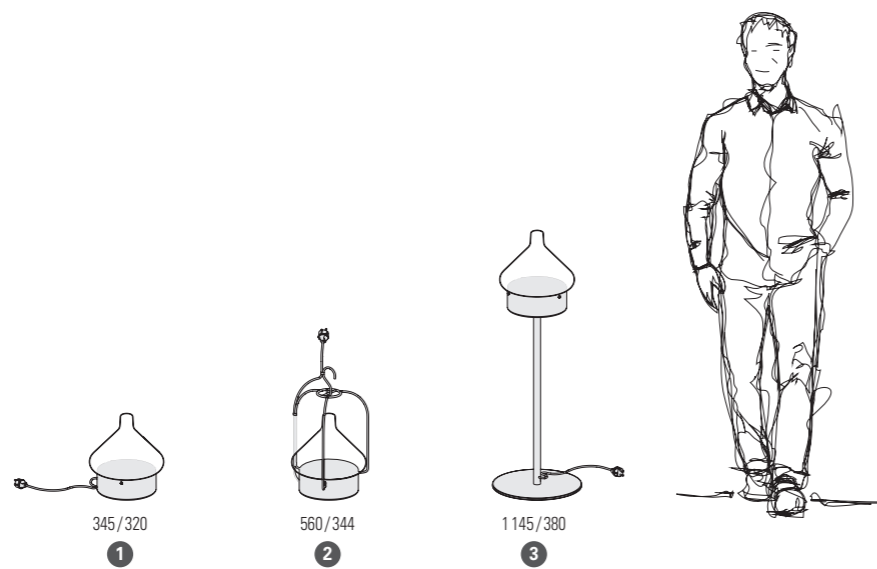
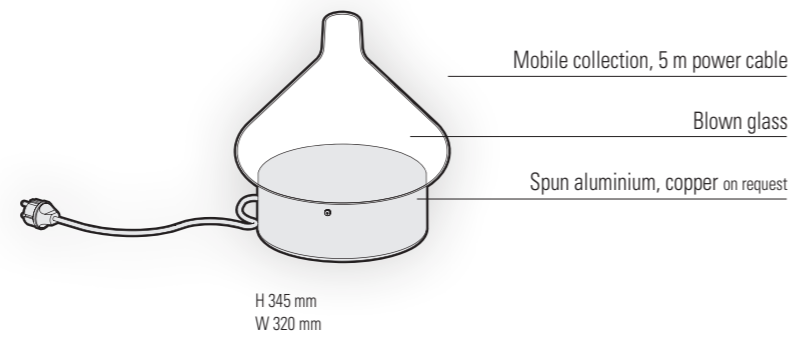

## REFERENCES

Replace ●●● with the colour code / replace (●) with the country's electrical plug code

MODELS	E27	SPARE DIFFUSER
1	166 001 ●●● (●)	165 085 609
2	166 002 ●●● (●)	165 085 609
3	166 003 ●●● (●)	165 085 609

## COLOURS CODES

Replace ●●● with the colour code

■	RAL 7021 BLACK GREY	107	■	RAL 3013 TOMATO RED	110
■	RAL 9010 PURE WHITE	101	■	RAL 2004 PURE ORANGE	014
■	BLUE	111	■	RAL 6025 FERN GREEN	109

Other colours on request

## PLUGS CODES

Except for French plugs, replace (●) with the country's plug code

Ⓢ	UK PLUG UK type G	Ⓢ	SWISS PLUG CH type J
---	----------------------	---	-------------------------



# Lampio

Design by Stéphane Joyeux

---





# Lampiock

IP65 (lantern)  
Class 2  
Class 1 (models 7, 8)

Aluminium or tinted lacquered brass or patinated lacquered copper  
Cup, rod, brackets and poles: black grey 107 (RAL 7021)  
Clear or frosted glass diffuser

## SOURCE

E27 - 52W max Ø66 mm - H150 mm max



E27 (2450 lm)  
Real light output/frosted - 1558 lm  
Real light output/clear - 1673 lm

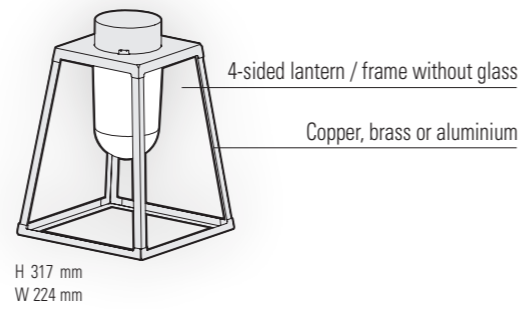

## MODELS

height / width / depth

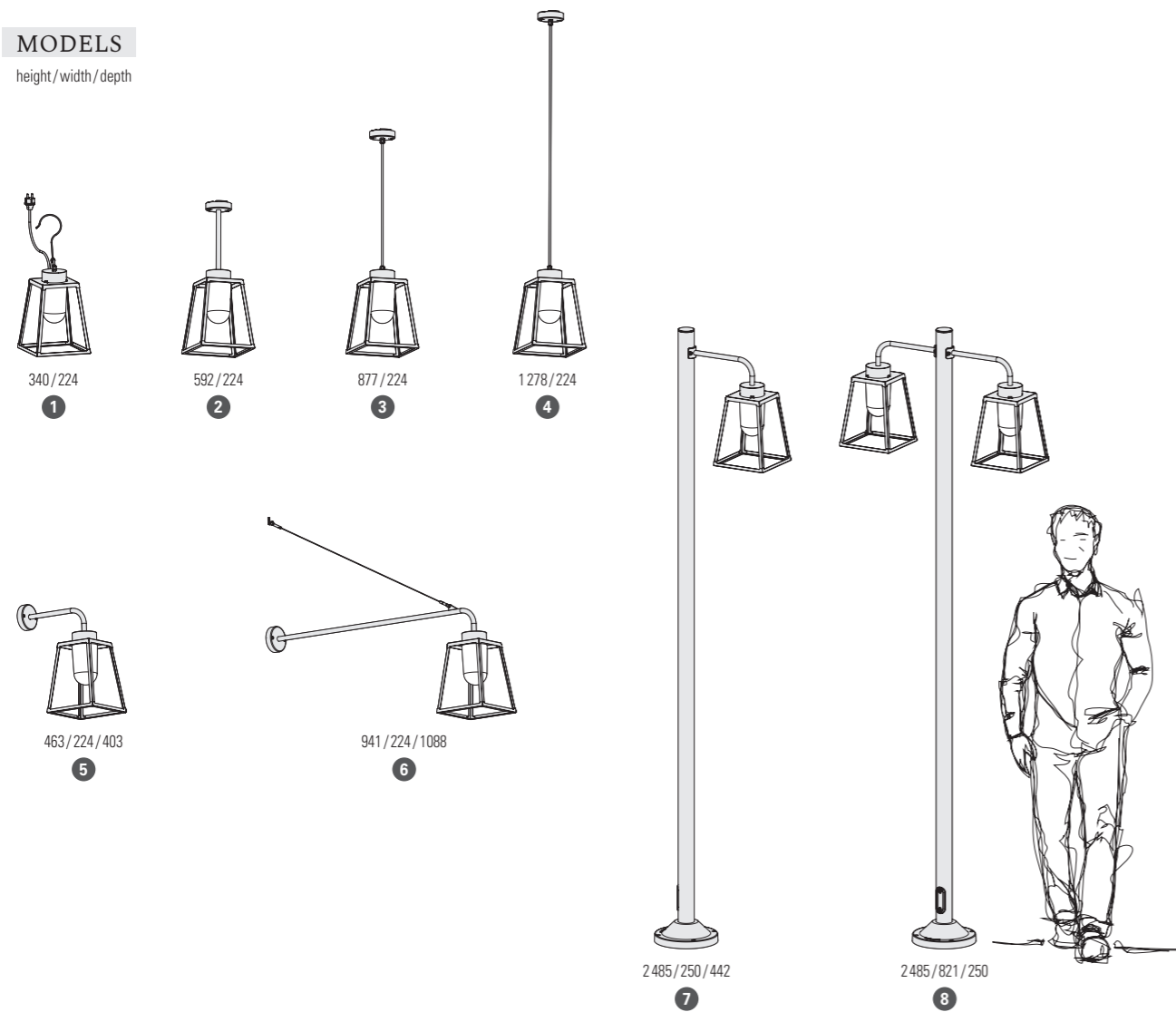

# Lampiock

## REFERENCES

Replace ●●● with the colour code or material code / replace ● with the country's electrical plug code

MODELS	DIFFUSERS	E27	CORNER PLATE p.319	SPARE DIFFUSERS
1	CLEAR GLASS	131 001 ●●●(●)		165 035 609
	FROSTED GLASS	131 002 ●●●(●)		165 035 610
2	CLEAR GLASS	131 003 ●●●		165 035 609
	FROSTED GLASS	131 004 ●●●		165 035 610
3	CLEAR GLASS	131 005 ●●●		165 035 609
	FROSTED GLASS	131 006 ●●●		165 035 610
4	CLEAR GLASS	131 007 ●●●		165 035 609
	FROSTED GLASS	131 008 ●●●		165 035 610
5	CLEAR GLASS	131 009 ●●●	147 005 ●●●	165 035 609
	FROSTED GLASS	131 010 ●●●		165 035 610
6	CLEAR GLASS	131 011 ●●●		165 035 609
	FROSTED GLASS	131 012 ●●●		165 035 610
7	CLEAR GLASS	131 013 ●●●		165 035 609
	FROSTED GLASS	131 014 ●●●		165 035 610
8	CLEAR GLASS	131 015 ●●●		165 035 609
	FROSTED GLASS	131 016 ●●●		165 035 610

## COLOURS CODES

Replace ●●● with the colour code

	RAL 7021 BLACK GREY 107		RAL 3013 TOMATO RED 110
	RAL 7044 SILK GREY 105		RAL 2004 PURE ORANGE 014
	RAL 9010 PURE WHITE 101		RAL 1016 SULFUR YELLOW 068
	BLUE 111		RAL 6025 FERN GREEN 109

Other colours on request

## MATERIAL CODES

	TINTED LACQUERED BRASS 070
	COPPER 080
	patinated lacquered

## PLUGS CODES

Except for French plugs, replace ● with the country's plug code

	UK PLUG UK type G		SWISS PLUG CH type J
--	----------------------	--	-------------------------

## MOUNTING

Wiring entry points in grey - Fixing kit included

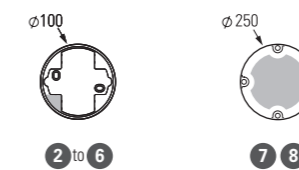

# Klint

Design by Stéphane Joyeux

---

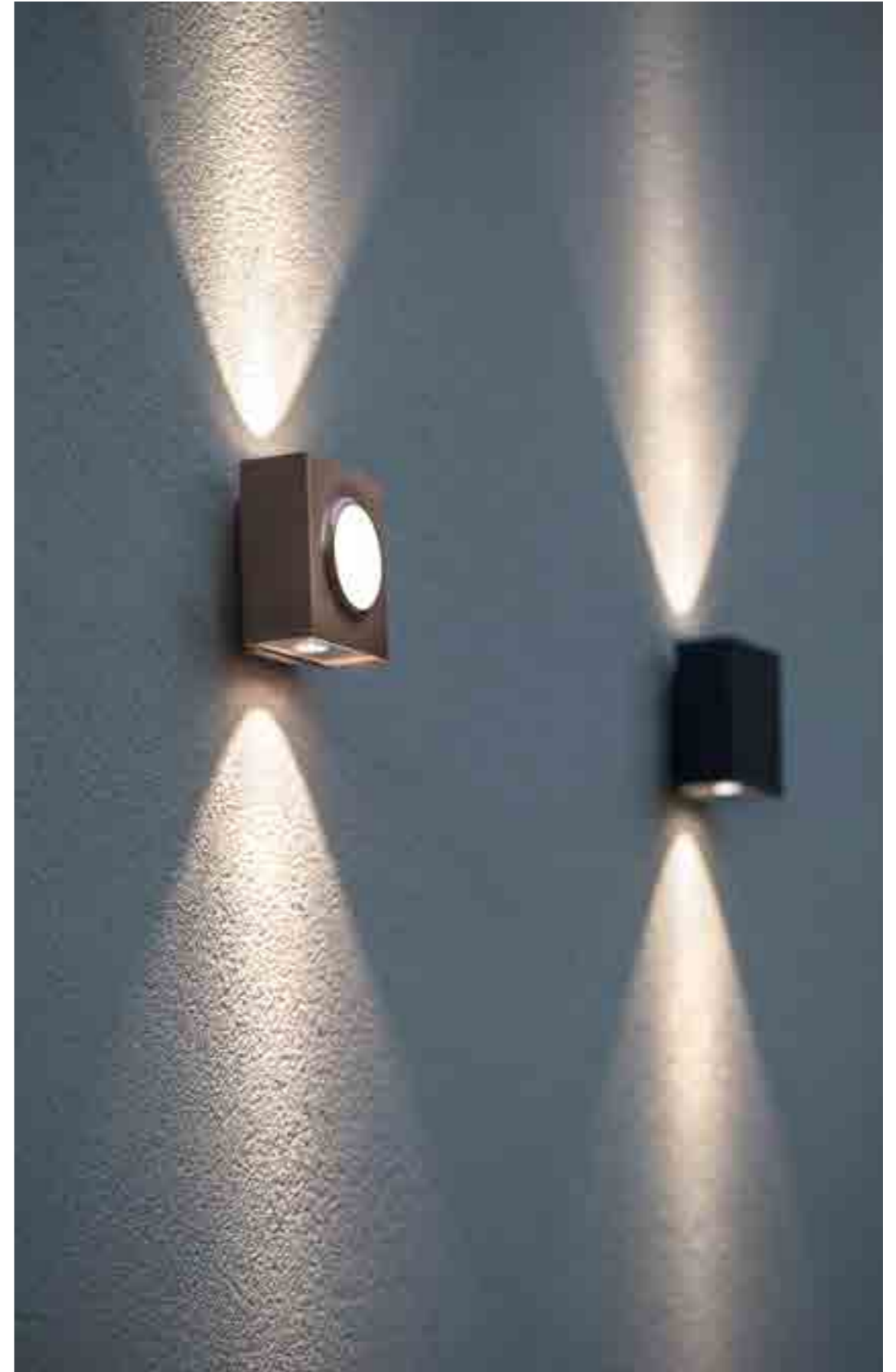

# Klint

IP65  
Class 2

Aluminium  
Clear PMMA diffuser

## SOURCES

LED 2x2W - 2800K warm white  
LED 2x2W - 4000K neutral white

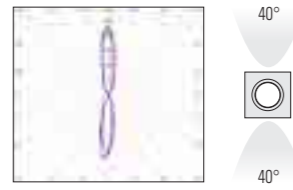

LED 2x2W - 40/40°  
Real light output - 414 lm  
IRC > 80

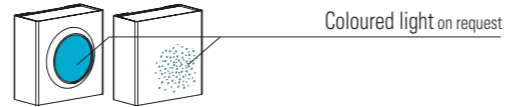
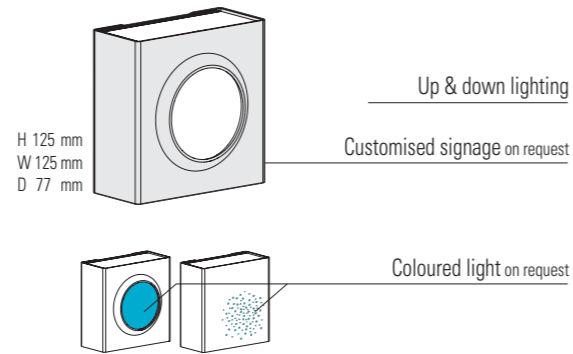

## MODELS

height / width / depth



125 / 125 / 77

125 / 125 / 70

125 / 125 / 70



Customizable signage  
In red, printing on diffuser



4 5 6

- 4 Square cut out 80x80mm + printing on diffuser
- 5 Laser cutting
- 6 Laser cutting + printing on diffuser

## REFERENCES

Replace ... with the colour code

MODELS	LED 2x2W 3300K warm white	LED 2x2W 4500K neutral white
1	167 001 ...	167 002 ...
2	167 003 ...	167 004 ...
3	167 005 ...	167 006 ...

Customizable signage

MODELS	LED 2x2W 3300K warm white	LED 2x2W 4500K neutral white
4	167 007 ...	167 008 ...
5	167 403 ...	167 404 ...
6	167 405 ...	167 406 ...

## COLOURS CODES

Replace ... with the colour code

	VELVET BLACK 113		RAL 3020 TRAFFIC RED 056
	RAL 7021 BLACK GREY 107		RAL 2004 PURE ORANGE 014
	RAL 7044 SILK GREY 105		RAL 1016 SULFUR YELLOW 068
	RAL 9010 PURE WHITE 101		RAL 6025 FERN GREEN 109
Other colours on request			BLUE 111

## MATERIAL CODES

Replace ... with the material code

	BRUSHED LACQUERED COPPER 084
	BRUSHED STAINLESS STEEL 018

## MOUNTING

Wiring entry point in grey  
Fixing kit included

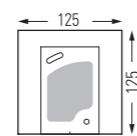

1

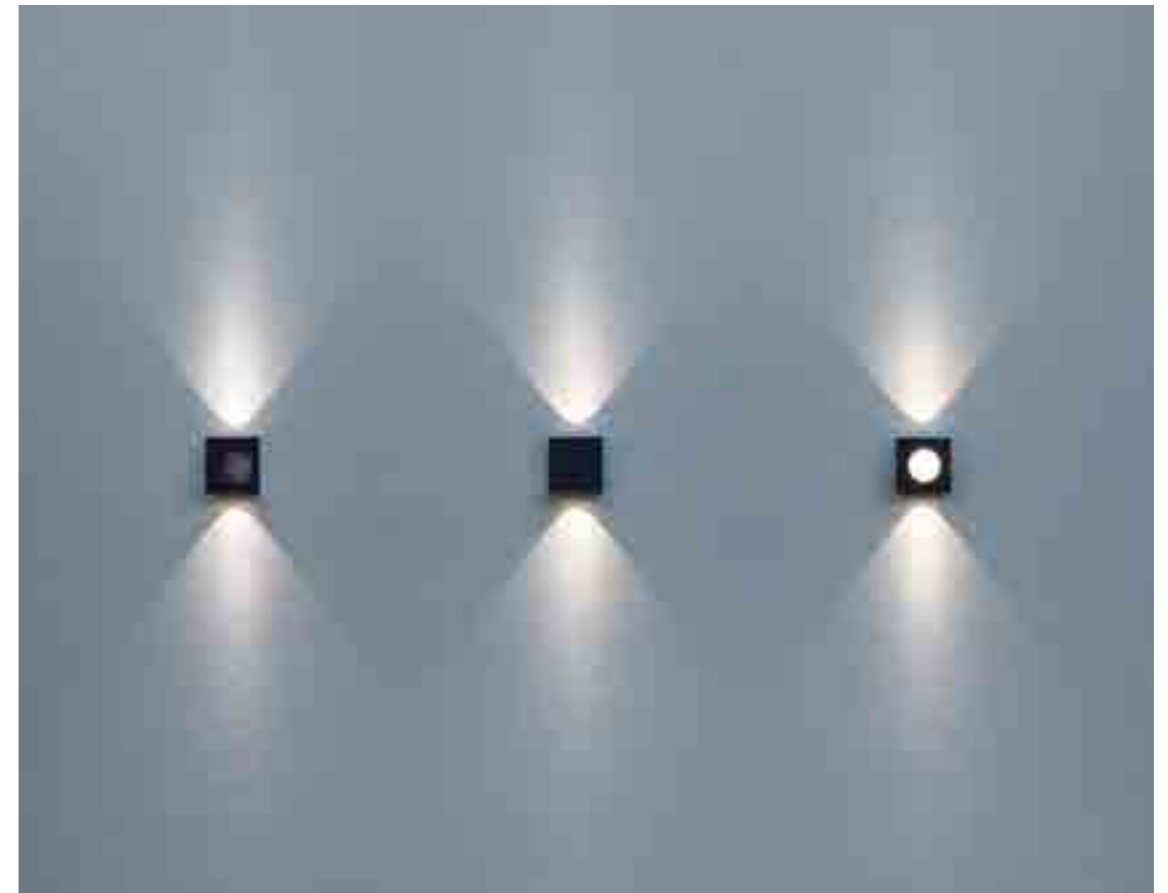



# RP195

Design by Stéphane Joyeux

---

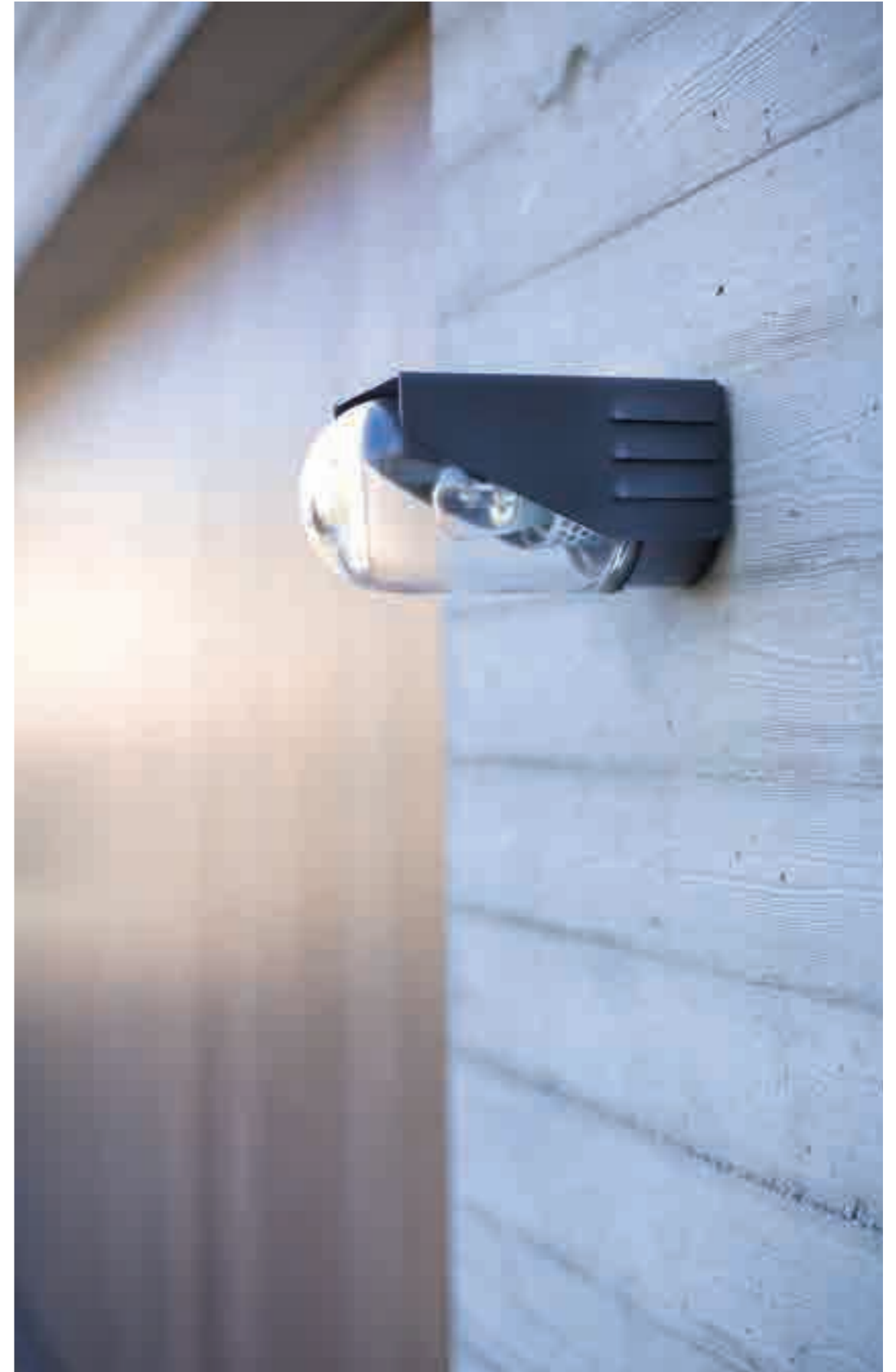

# RP195

IP65  
Class 2

Aluminium or raw copper or corten steel  
Clear or frosted glass diffuser

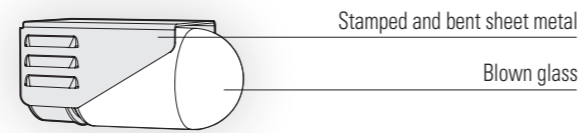

H 103 mm  
W 114 mm  
D 203 mm

## SOURCES

E27 - 52W max (model 1) Ø66 mm - H 150 mm max  
E27 - 70W max (model 2) Ø66 mm - H 150 mm max

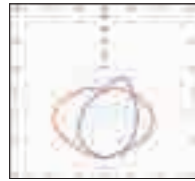

Model 1

E27 (2450 lm)  
Real light output/frosted - 1106 lm  
Real light output/clear - 1085 lm

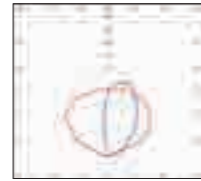

Model 2

E27 (2450 lm)  
Real light output/frosted - 1024 lm  
Real light output/clear - 977 lm



## MODELS

height / width / depth



103/114/203

1

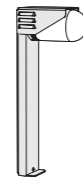

552/114/206

2

## REFERENCES

Replace ●●● with the colour code or material code

MODELS	DIFFUSERS	E27	SPARE DIFFUSERS
1	CLEAR GLASS	153 001 ●●●	165 035 609
	FROSTED GLASS	153 002 ●●●	165 035 610
2	CLEAR GLASS	153 003 ●●●	165 035 609
	FROSTED GLASS	153 004 ●●●	165 035 610

## COLOURS CODES

Replace ●●● with the colour code

	DARK GREY 006		RAL 3020 TRAFFIC RED 056
	SLATE GREY 059		RAL 2004 PURE ORANGE 014
	RAL 7044 SILK GREY 105		RAL 1016 SULFUR YELLOW 068
	OLD RUSTIC 046		RAL 6025 FERN GREEN 109

Other colours on request

## MATERIAL CODES

	RAW COPPER 082 (Black aluminium bollard)
	STAINLESS STEEL 018

## MOUNTING

Wiring entry points in grey  
Fixing kit included

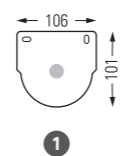

1

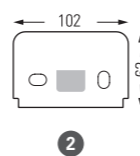

2



# Brick<sup>2</sup>

Design by Stéphane Joyeux

---





# Brick<sup>2</sup>

IP44  
Class 2

Aluminium  
Clear glass diffuser  
Satin-finish polycarbonate bulb cover (model 1)  
Satin-finish PMMA bulb cover (models 2, 3)

## SOURCE

E27 - 23W max Ø66 mm - H 175 mm max (model 1)  
Ø60 mm - H 180 mm max (models 2, 3)



Model 1  
E27 (2450 lm)  
Real light output - 1180 lm



Models 2, 3  
E27 (2450 lm)  
Real light output - 2100 lm

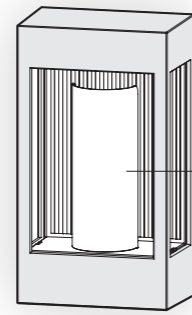

«Easycap» quick-connect system p. 321

Removable bulb cover

Ventilation filter

H 303 mm  
W 169 mm  
D 110 mm

## MODELS

height / width / depth



303 / 169 / 110

1

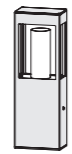

500 / 170 / 100

2



800 / 170 / 100

3



## REFERENCES

Replace ●●● with the colour code

MODELS	E27	SPARE GLASSES	SPARE BULB COVERS
1	108 001 ●●●	165 013 609	165 071 611
2	108 002 ●●●	165 014 609	165 072 612
3	108 003 ●●●	165 014 609	165 072 612

## COLOURS CODES

Replace ●●● with the colour code

	RAL 7021 BLACK GREY 107
	RAL 7044 SILK GREY 105
	RAL 9010 PURE WHITE 101
	RAL 5011 STEEL BLUE 065
	RAL 3005 WINE RED 066
	RAL 3013 TOMATO RED 110
	RAL 3020 TRAFFIC RED 056
	RAL 2004 PURE ORANGE 014
	RAL 6025 FERN GREEN 109

	DARK GREY 006
	SLATE GREY 059
	WHITE 001
	BLUE 111
	LIMESTONE 053
	SANDSTONE 054
	OLD RUSTIC 046

Other colours on request

## MOUNTING

Wiring entry points in grey  
Fixing kit included

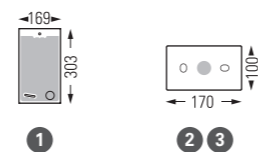

1

2 3

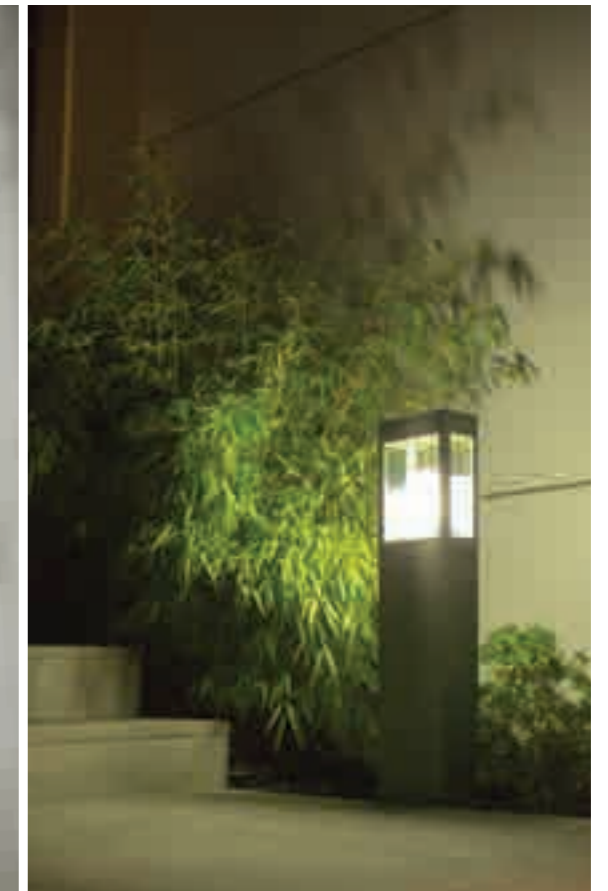
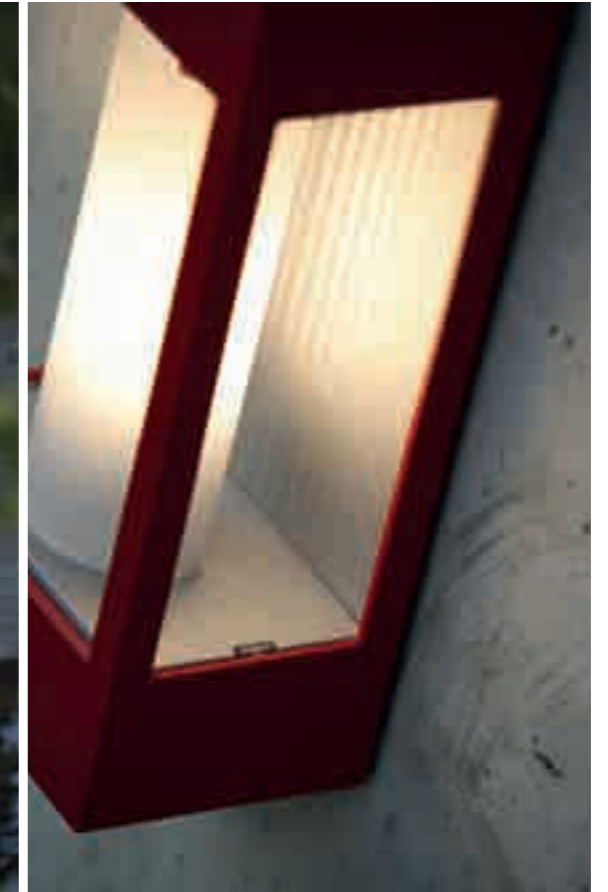
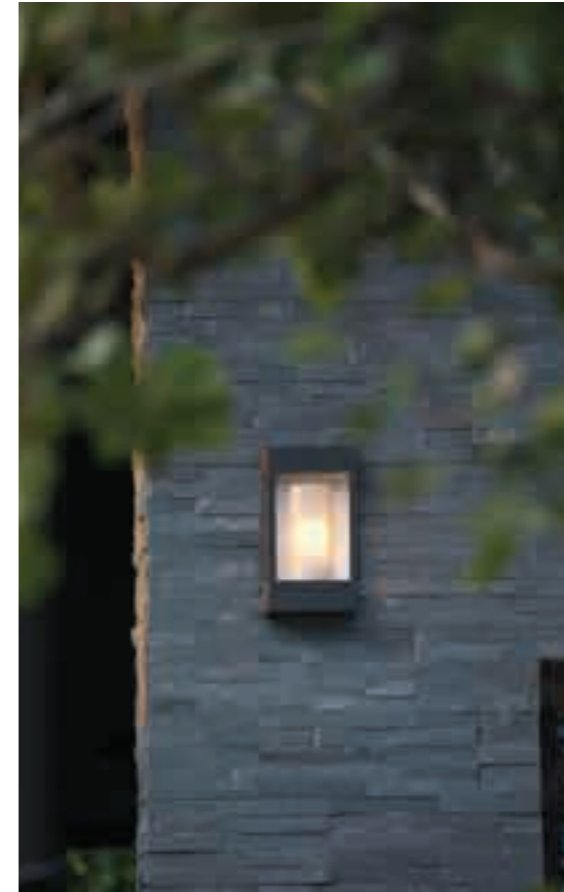

# Tetra

Design by Stéphane Joyeux

---



# Tetra

IP65  
IK10  
Class 1

Aluminium  
Clear polycarbonate diffuser  
Stainless steel bulb cover (version E27 and G24q-3)

## SOURCES

LED 20W - 2900K warm white  
LED 20W - 4500K neutral white  
G24q-3 - 26W  
E27 - 70W max Ø66 mm - H175 mm max  
GU6,5 IM on request



4-sided light

Extruded aluminium profile

H 300 mm  
W 170 mm  
D 116 mm



E27 (2450 lm)  
Real light output - 609 lm



LED 20W  
Real light output - 743 lm  
CRI > 80

## MODELS

height / width / depth

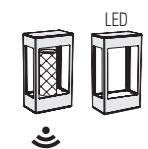

300/170/116

1

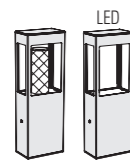

500/170/100

2

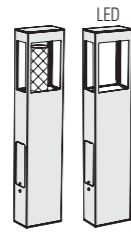

800/170/100

3

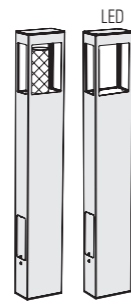

1100/170/100

4

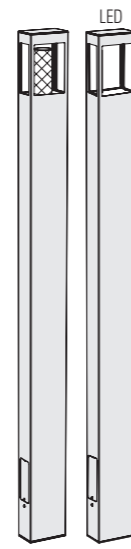

2100/170/100

5



## REFERENCES

Replace ●●● with the colour code

MODELS	E27	G24q-3	LED 20W 2900K warm white	LED 20W 4500K neutral white	☺ E27 + SENSOR	SPARE DIFFUSER	SPARE BULB COVER
1	162 001 ●●●	162 004 ●●●	162 006 ●●●	162 005 ●●●	162 002 ●●●	165 066 601	165 075 018
2	162 007 ●●●	162 009 ●●●	162 011 ●●●	162 010 ●●●		165 066 601	165 075 018
3	162 012 ●●●	162 014 ●●●	162 016 ●●●	162 015 ●●●		165 066 601	165 075 018
4	162 017 ●●●	162 019 ●●●	162 021 ●●●	162 020 ●●●		165 066 601	165 075 018
5	162 022 ●●●	162 024 ●●●	162 026 ●●●	162 025 ●●●		165 066 601	165 075 018

## COLOURS CODES

Replace ●●● with the colour code

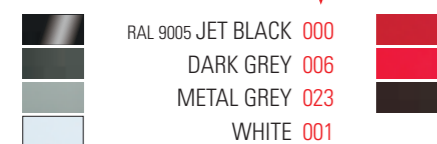

RAL 9005 JET BLACK 000  
DARK GREY 006  
METAL GREY 023  
WHITE 001  
RAL 3013 TOMATO RED 110  
RAL 3020 TRAFFIC RED 056  
OLD RUSTIC 046

Other colours on request

## MOUNTING

Wiring entry points in grey - Fixing kit included  
Anchor bolts on request (model 5) p.318

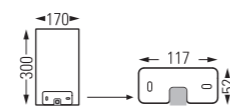

1

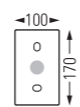

2 to 5



# Tools

Design by Patrick Norguet

More than just a light, Tools is a system. This object can be used in a variety of settings, both inside and outside the house: dinner, reading, receiving guests, indicating, etc. The lamp can be fixed to the corner of a table thanks to its clamp base, or it can be stuck into the lawn or the drive to light up summer nights. Tools comes as a standard lamp, footlight, and wall light.

"The aesthetic used – aluminium and wood – as well as the construction details of the object are a seamless evocation of the simple, functional universe of garden tools," says Patrick Norguet.





# Tools

IP65  
IP20 (version with switch available on request)  
Class 2

Aluminium and acacia wood  
Satin-finish polycarbonate diffuser

## SOURCES

LED 13W - 2900K warm white  
LED 21W - 4000K neutral white

## MODELS

height / width / depth

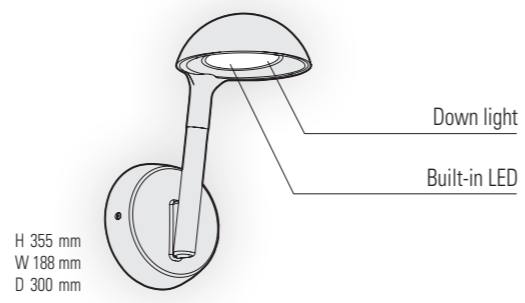
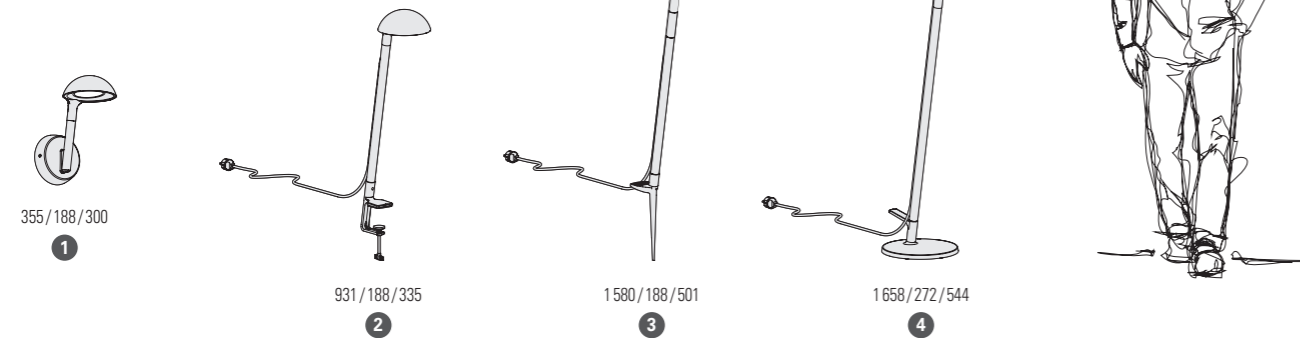

## REFERENCES

Replace ●●● with the colour code / replace (●) with the country's electrical plug code

MODELS	LED 13W - 2900K warm white	LED 21W - 4000K neutral white
1	160 001 ●●●	160 002 ●●●
2	160 003 ●●● (●)	160 004 ●●● (●)
3	160 005 ●●● (●)	160 006 ●●● (●)
4	160 007 ●●● (●)	160 008 ●●● (●)

## COLOURS CODES

Replace ●●● with the colour code

	RAL 7021 BLACK GREY 107		RAL 3013 TOMATO RED 110
	RAL 7044 SILK GREY 105		RAL 6025 FERN GREEN 109
	RAL 9010 PURE WHITE 101		

Other colours on request

## PLUGS CODES

Except for French plugs, replace (●) with the country's plug code

	UK PLUG UK type G		SWISS PLUG CH type J
--	----------------------	--	-------------------------

## MOUNTING

Wiring entry point in grey - Fixing kit included

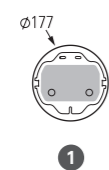

# Mona

Design by Stéphane Joyeux

---



# Mona

IP65  
IK10  
Class 2

Aluminium  
Opal polycarbonate diffuser

## SOURCES

2Gx13 FLC 22W  
LED 35W - 2700K warm white - triac dimmable LED module  
LED 35W - 4500K neutral white - triac dimmable LED module



LED 35W  
Real light output - 1349 lm  
CRI > 80

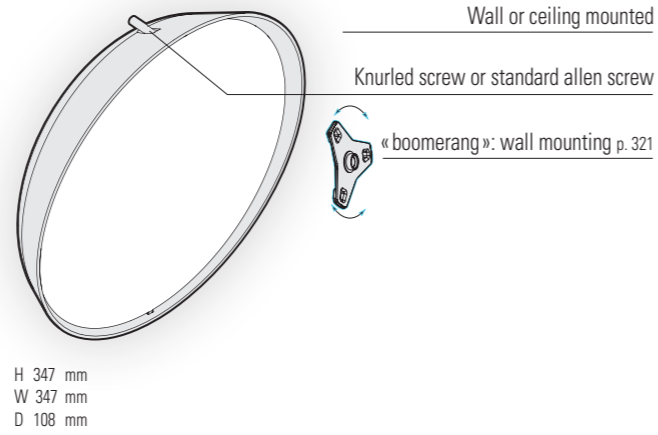

## REFERENCES

Replace ●●● with the colour code

MODEL	2Gx13 FLC 22W	LED 35W 2700K warm white	LED 35W 4500K neutral white	SPARE DIFFUSER
1	137 001 ●●●	137 002 ●●●	137 003 ●●●	165 043 602

## COLOURS CODES

Replace ●●● with the colour code

	RAL 9005 JET BLACK 000		RAL 5011 STEEL BLUE 065
	VELVET BLACK 113		BLUE 111
	RAL 7021 BLACK GREY 107		SANDSTONE 054
	RAL 7044 SILK GREY 105		
	WHITE 001		
	RAL 3013 TOMATO RED 110		
	RAL 2004 PURE ORANGE 014		
	RAL 1016 SULFUR YELLOW 068		

Other colours on request



## MOUNTING

Wiring entry point in grey - Fixing kit included

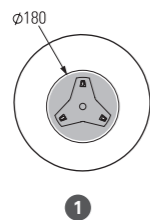

# Sherlock

Design by Stéphane Joyeux

---



# Sherlock

IP65  
Class 2

Aluminium  
Clear or frosted glass diffuser

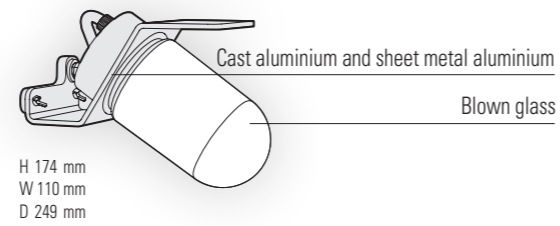

## SOURCE

E27 - 42W max Ø66 mm - H 150 mm max



Model 1

E27 (2450 lm)  
Real light output/frosted - 1757 lm  
Real light output/clear - 1857 lm



Model 2

E27 (2450 lm)  
Real light output/frosted - 1624 lm  
Real light output/clear - 1698 lm

## MODELS

height / width / depth

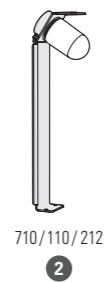

## REFERENCES

Replace ●●● with the colour code

MODELS	DIFFUSERS	E27	SPARE DIFFUSERS
1	CLEAR GLASS	154 001 ●●●	165 035 609
	FROSTED GLASS	154 002 ●●●	165 035 610
2	CLEAR GLASS	154 003 ●●●	165 035 609
	FROSTED GLASS	154 004 ●●●	165 035 610

## COLOURS CODES

Replace ●●● with the colour code

RAL 7021 BLACK GREY 107  
 DARK GREY 006  
 SLATE GREY 059  
 RAL 7044 SILK GREY 105  
 OLD RUSTIC 046

Other colours on request

RAL 3020 TRAFFIC RED 056  
 RAL 2004 PURE ORANGE 014  
 RAL 1016 SULFUR YELLOW 068  
 RAL 6025 FERN GREEN 109

## MOUNTING

Wiring entry points in grey  
Fixing kit included

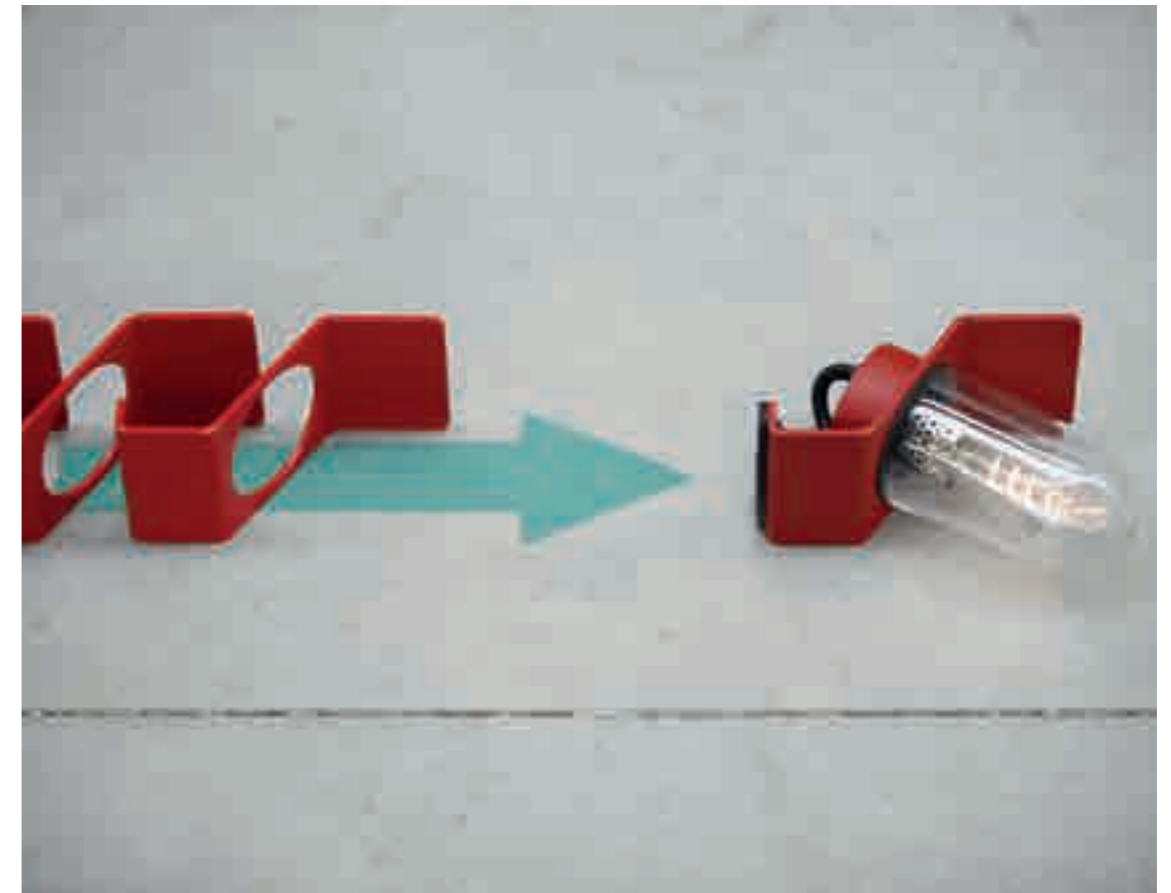
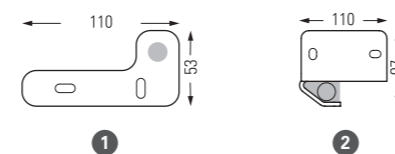

# Picto

Design by Stéphane Joyeux

---



# Picto

IP44 (model 1)  
IP65 (model 2)  
Class 2

Aluminium or clear PMMA body  
Clear polycarbonate diffuser

## SOURCE

GX53 - 9W max Ø75 mm - H 26 mm max

## MODELS

height / width / depth

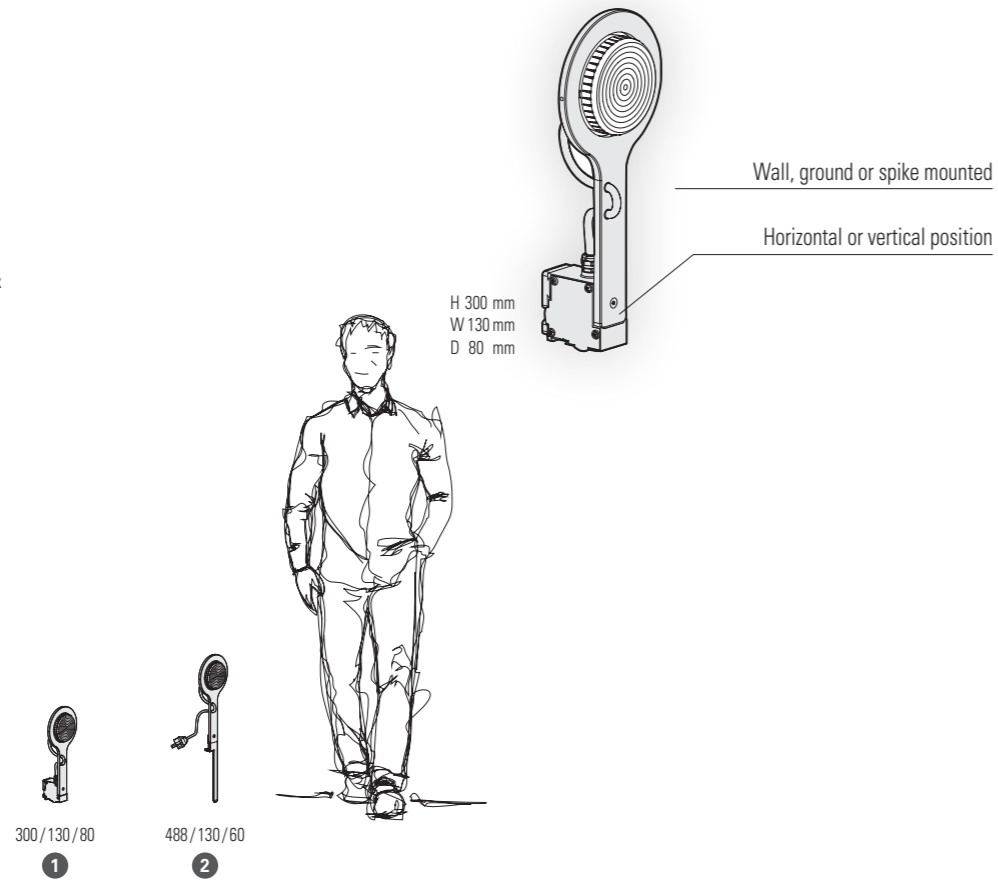

## REFERENCES

Replace ●●● with the colour code / replace (●) with the country's electrical plug code

MODELS	ALUMINIUM BODY GX53	CLEAR PMMA BODY GX53
1	146 001 ●●●	146 002 605
2	146 003 ●●●(●)	

## COLOURS CODES

Replace ●●● with the colour code ↴

	RAL 7021 BLACK GREY 107		RAL 3020 TRAFFIC RED 056
	RAL 7044 SILK GREY 105		RAL 2004 PURE ORANGE 014
	RAL 5011 STEEL BLUE 065		RAL 6018 YELLOW GREEN 015
	OLD RUSTIC 046		

Other colours on request

## PLUGS CODES

Except for French plugs, replace (●) with the country's plug code ↴

	UK PLUG <b>UK</b> type G		SWISS PLUG <b>CH</b> type J
---	-----------------------------	---	--------------------------------

## MOUNTING

Wiring entry point in grey - Fixing kit included

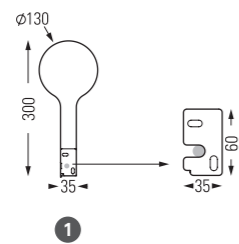

# Ibuk

Design by Stéphane Joyeux



*VIA Label 2015 Award*

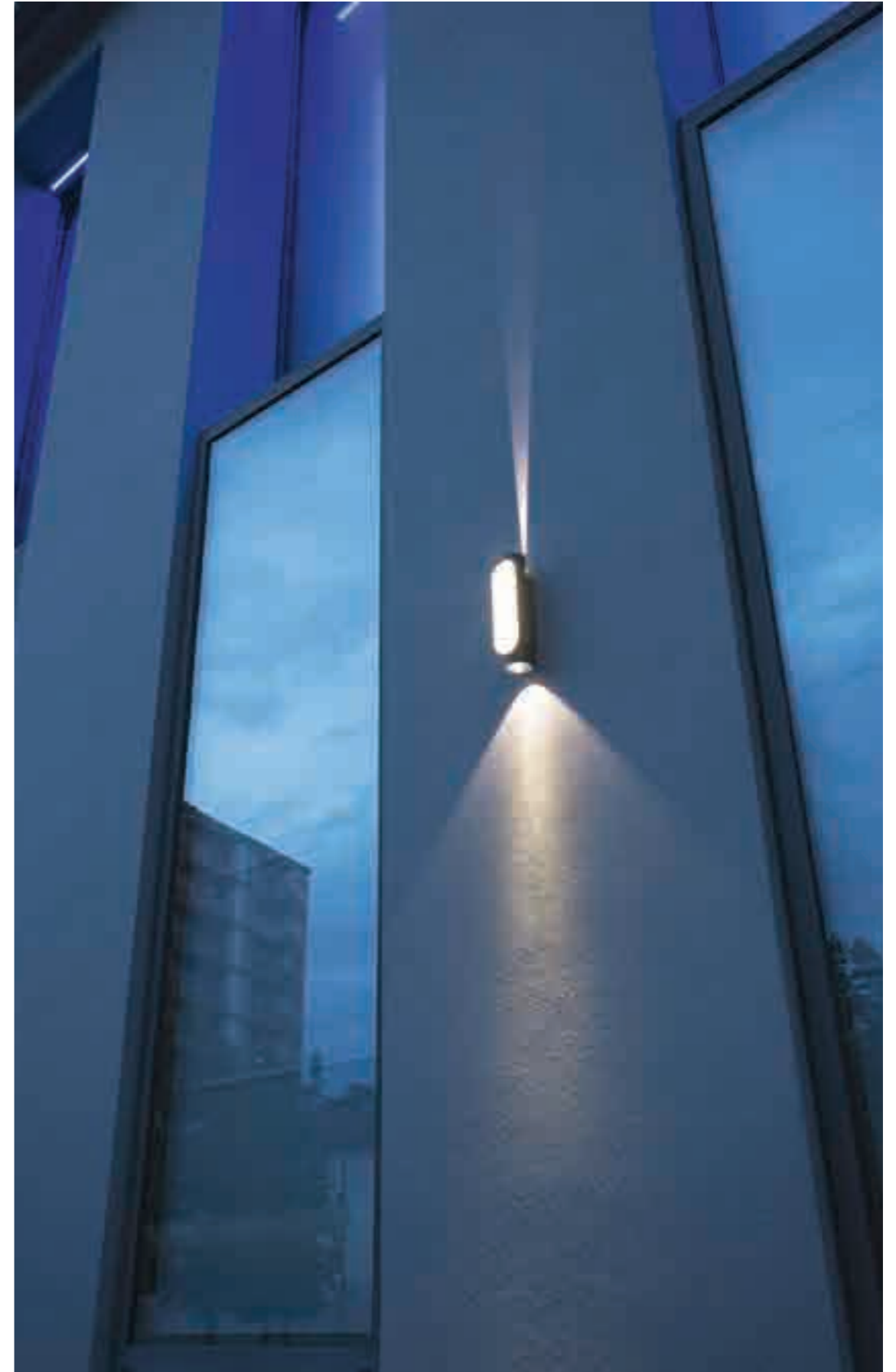





# Ibuk

IP65  
IK10  
Class 2

Aluminium  
Black or white polycarbonate front diffuser  
Clear polycarbonate Up & Down diffusers Ø 80

## SOURCES

LED 3x4,5W - 3000K warm white  
LED 3x4,5W - 4300K neutral white

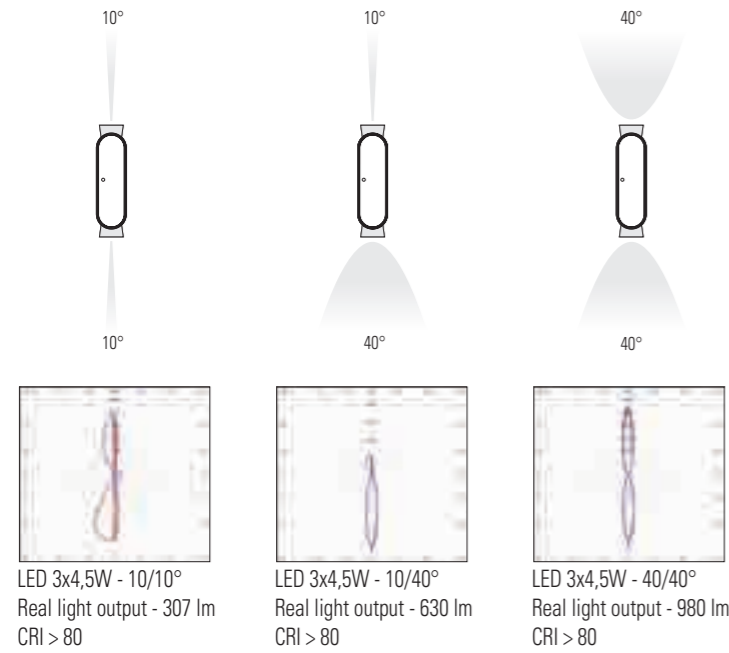

## MODELS

height / width / depth



## DIFFUSERS

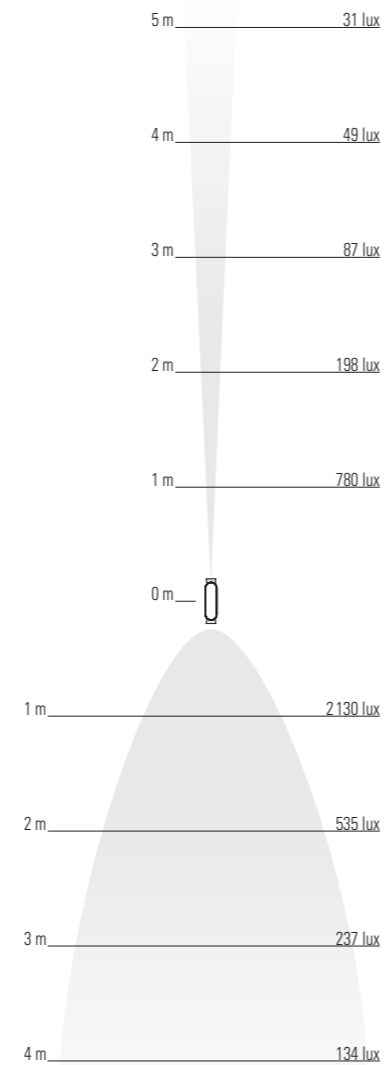
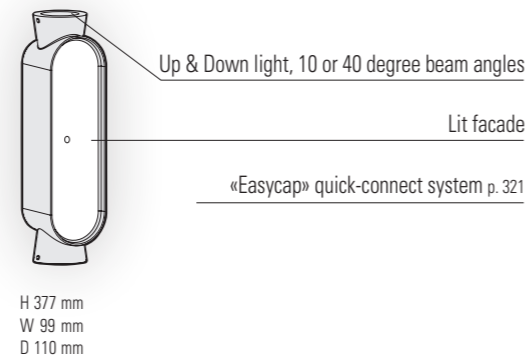
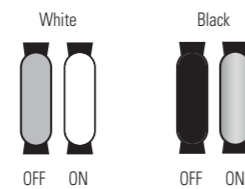

# Ibuk

## REFERENCES

Replace ●●● with the colour code

Warm white

MODEL	FRONT DIFFUSER	LED 3x4,5W - 10/10° 3000K warm white	LED 3x4,5W - 10/40° 3000K warm white	LED 3x4,5W - 40/40° 3000K warm white
1	WHITE POLYCARBONATE	126 001 ●●●	126 002 ●●●	126 003 ●●●
	BLACK POLYCARBONATE	126 004 ●●●	126 005 ●●●	126 006 ●●●

Neutral white

MODEL	FRONT DIFFUSER	LED 3x4,5W - 10/10° 4300K neutral white	LED 3x4,5W - 10/40° 4300K neutral white	LED 3x4,5W - 40/40° 4300K neutral white
1	WHITE POLYCARBONATE	126 007 ●●●	126 008 ●●●	126 009 ●●●
	BLACK POLYCARBONATE	126 010 ●●●	126 011 ●●●	126 012 ●●●

## COLOURS CODES

Replace ●●● with the colour code

	RAL 7021 BLACK GREY 107		VELVET BLACK 113
	RAL 7044 SILK GREY 105		DARK GREY 006
	RAL 9010 PURE WHITE 101		BLUE 111
	RAL 3005 WINE RED 066		SANDSTONE 054
	RAL 3013 TOMATO RED 110		
	RAL 3020 TRAFFIC RED 056		
	RAL 2004 PURE ORANGE 014		
	RAL 1016 SULFUR YELLOW 068		
	RAL 6025 FERN GREEN 109		

Other colours on request

## MOUNTING

Wiring entry point in grey - Fixing kit included



## Séléné

Design by Normal Studio

---

Séléné has a presence that is almost sculptural. This range, which comes with pureness of line, was born of close observation of the know-how gained from the techniques of tin-smithing. "The generosity of the form calls to mind the leaf of the water lily. The velvety appearance of the colours chosen is a counterpart to the downy surfaces of some plants," say Jean-François Dingjian and Eloi Chafai. The masked light source gives out a beautiful luminous halo that plays with the colour of the support. *Awarded with the VIA Label 2011*



# Séléné

IP65  
Class 2

Aluminium  
Opal polycarbonate diffuser

## SOURCES

LED 13W - 2900K warm white  
LED 21W - 4000K neutral white

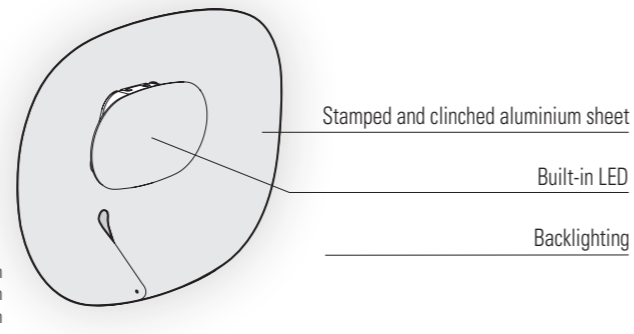

## MODELS

height / width / depth

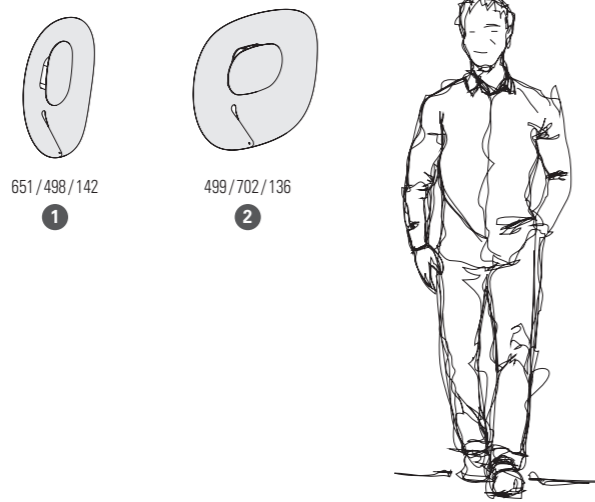

## REFERENCES

Replace ●●● with the colour code

MODELS	LED 13W 2900K warm white	LED 21W 4000K neutral white
1	155 001 ●●●	155 002 ●●●
2	155 003 ●●●	155 004 ●●●

## COLOURS CODES

Replace ●●● with the colour code

	RAL 7044 SILK GREY 105		RAL 2004 PURE ORANGE 014
	RAL 9010 PURE WHITE 101		RAL 1016 SULFUR YELLOW 068
	BLUE 111	Other colours on request	

## MOUNTING

Wiring entry points in grey - Fixing kit included

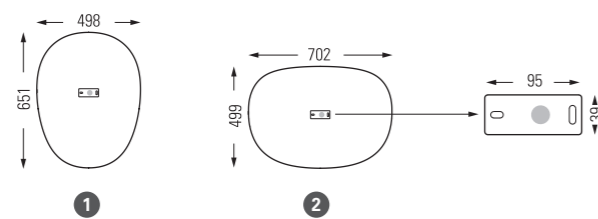

# Hugy

Design by Stéphane Joyeux

---



# Hugy

IP65  
Class 2

Aluminium  
Clear or frosted glass diffuser

## SOURCE

E27 - 42W max Ø66 mm - H 130 mm max



E27 (2450 lm)  
Real light output/frosted - 2286 lm  
Real light output/clear - 1939 lm

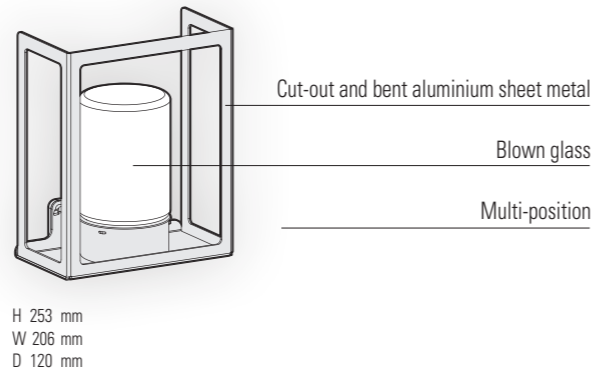

## REFERENCES

Replace ●●● with the colour code

MODEL	DIFFUSERS	E27	SPARE DIFFUSERS
1	CLEAR GLASS	125 001 ●●●	165 001 609
	FROSTED GLASS	125 002 ●●●	165 001 610

## COLOURS CODES

Replace ●●● with the colour code

	RAL 7021 BLACK GREY 107		RAL 3020 TRAFFIC RED 056
	DARK GREY 006		RAL 2004 PURE ORANGE 014
	SLATE GREY 059		RAL 6025 FERN GREEN 109
	RAL 7044 SILK GREY 105		RAL 1016 SULFUR YELLOW 068
	OLD RUSTIC 046		

Other colours on request

## MATERIAL CODE

STAINLESS STEEL 018

## MOUNTING

Wiring entry point in grey - Fixing kit included

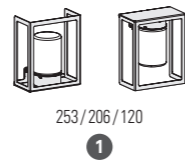
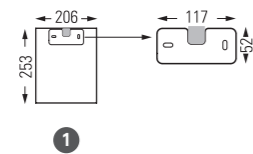

# Grumo

Design by Stéphane Joyeux

---



# Grumo

IP65  
IK09  
Class 1

Aluminium  
Opal polycarbonate diffuser

## SOURCE

E27 - 52W max Ø 120 mm - H 280 mm max



E27 (2450 lm)  
Real light output - 1572 lm

## MODELS

height / width / depth

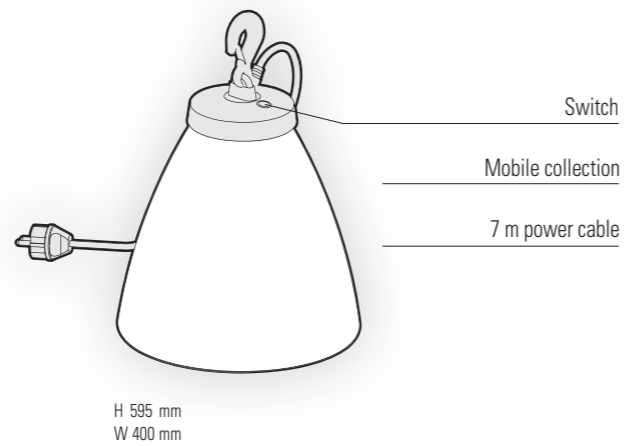
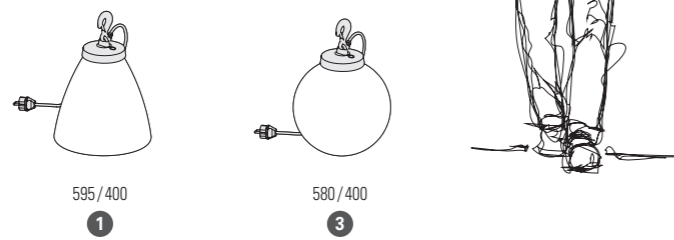

## REFERENCES

Replace **•••** with the colour code / replace **(•)** with the country's electrical plug code

MODELS	E27	SPARE DIFFUSERS
1	124 001 <b>•••(•)</b>	165 027 602
3	124 002 <b>•••(•)</b>	165 028 602

## COLOURS CODES

Replace **•••** with the colour code ↴

	RAL 7021 BLACK GREY 107		RAL 3020 TRAFFIC RED 056
	RAL 7044 SILK GREY 105		RAL 2004 PURE ORANGE 014
	RAL 5011 STEEL BLUE 065		RAL 6018 YELLOW GREEN 015

Other colours on request

## PLUGS CODES

Except for French plug, replace **(•)** with the country's plug code ↴

	UK PLUG <b>UK</b> type G		SWISS PLUG <b>CH</b> type J
---	-----------------------------	---	--------------------------------





# Stratos

Design by Stéphane Joyeux

---



# Stratos

IP44  
Class 1

Aluminium  
Frosted glass inner diffuser  
PMMA reflectors

## SOURCE

E27 - 70W max Ø66 mm - H 180 mm max

## MODELS

height / width / depth

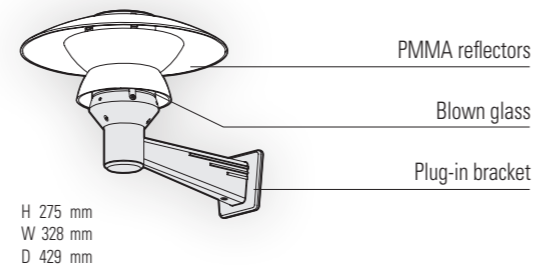
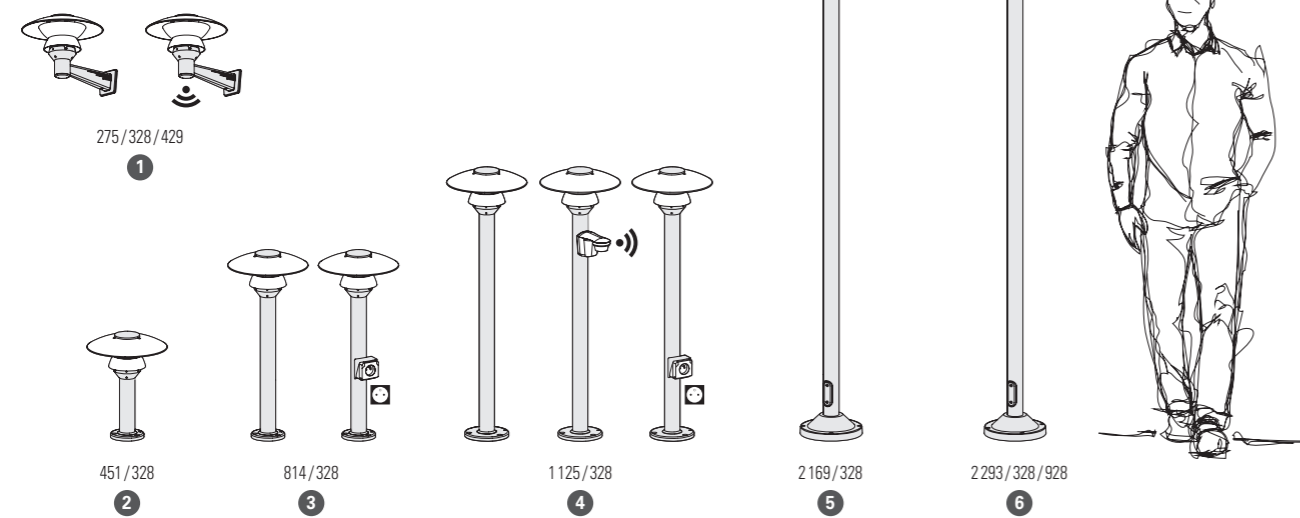

## REFERENCES

Replace ●●● with the colour code / replace (●) with the country's electrical socket code

MODELS	E27	E27 + SENSOR	SOCKET	CORNER PLATE p.319	SPARE INNER DIFFUSER	SPARE UPPER REFLECTOR
1	157 001 ●●●	157 002 ●●●		147 006 ●●●	165 019 ●●●	165 077 606
2	157 003 ●●●				165 019 ●●●	165 077 606
3	157 004 ●●●		157 005 ●●● (●)		165 019 ●●●	165 077 606
4	157 006 ●●●	157 007 ●●●	157 008 ●●● (●)		165 019 ●●●	165 077 606
5	157 009 ●●●				165 019 ●●●	165 077 606
6	157 010 ●●●				165 019 ●●●	165 077 606

## COLOURS CODES

Replace ●●● with the colour code

	RAL 7021 BLACK GREY	107		RAL 3013 TOMATO RED	110
	DARK GREY	006		RAL 5011 STEEL BLUE	065
	METAL GREY	023		RAL 6025 FERN GREEN	109
	RAL 9010 PURE WHITE	101		OLD RUSTIC	046

Other colours on request

## SOCKETS CODES

Except for French socket, replace (●) with country's socket code

	SCHUKO SOCKET SK	SWISS SOCKET CH
	type F	type J

## MOUNTING

Wiring entry points in grey  
Fixing kit included

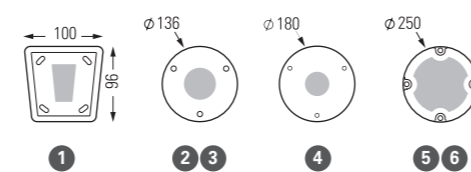

# Noctiluque

Design by Philippe Nigro

---

Noctiluque is a lighting family based on a common principle of a double protective skin. The hook reinforces the reference to the portable light, which – by definition – comes with a protective grille and a long wire. Here, however, Philippe Nigro goes beyond the archetype to invent an object that is at once curious and elegant. "A semi-transparent box surrounds the luminous, precious heart made of moulded polypropylene, which seems to levitate," says Philippe Nigro. This shell in expanded sheet-metal follows but never touches the internal structure, which blends function and technique.



# Noctilique

IP55  
 IP20 (version with switch available on request)  
 Class 2

Treated steel  
 Extrusion blow-moulded opal polypropylene diffuser

## SOURCE

E27 - 23W max - Ø55 mm - H150 mm max

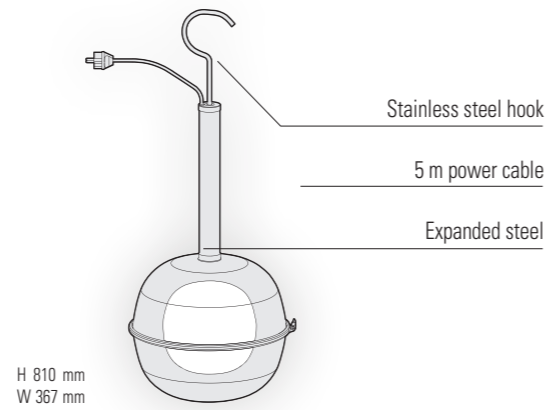

## MODELS

height / width / depth

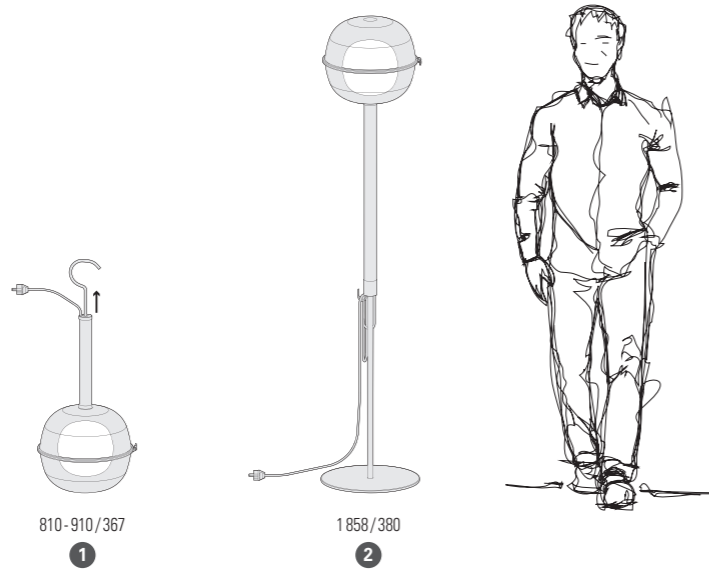

## REFERENCES

Replace ●●● with the colour code / replace (●) with the country's electrical plug code

MODELS	E27
1	140 001 ●●●(●)
2	140 002 ●●●(●)

## COLOURS CODES

Replace ●●● with the colour code

	RAL 7021 BLACK GREY	107		RAL 3005 WINE RED	066
	RAL 7044 SILK GREY	105		RAL 6025 FERN GREEN	109
	RAL 9010 PURE WHITE	101			

Other colours on request

## PLUGS CODES

Except for French plug, replace (●) with the country's plug code

	UK PLUG <b>UK</b> type G		SWISS PLUG <b>CH</b> type J
--	-----------------------------	--	--------------------------------

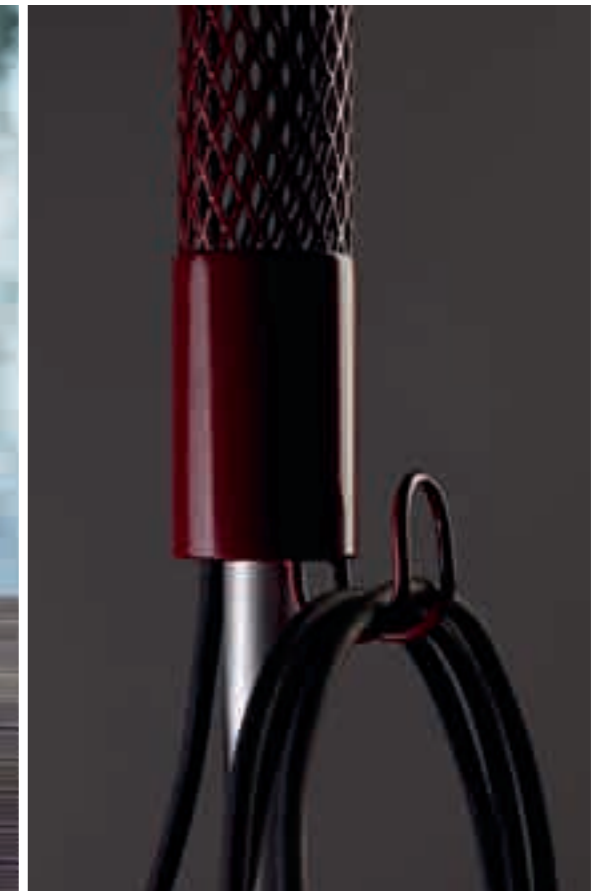
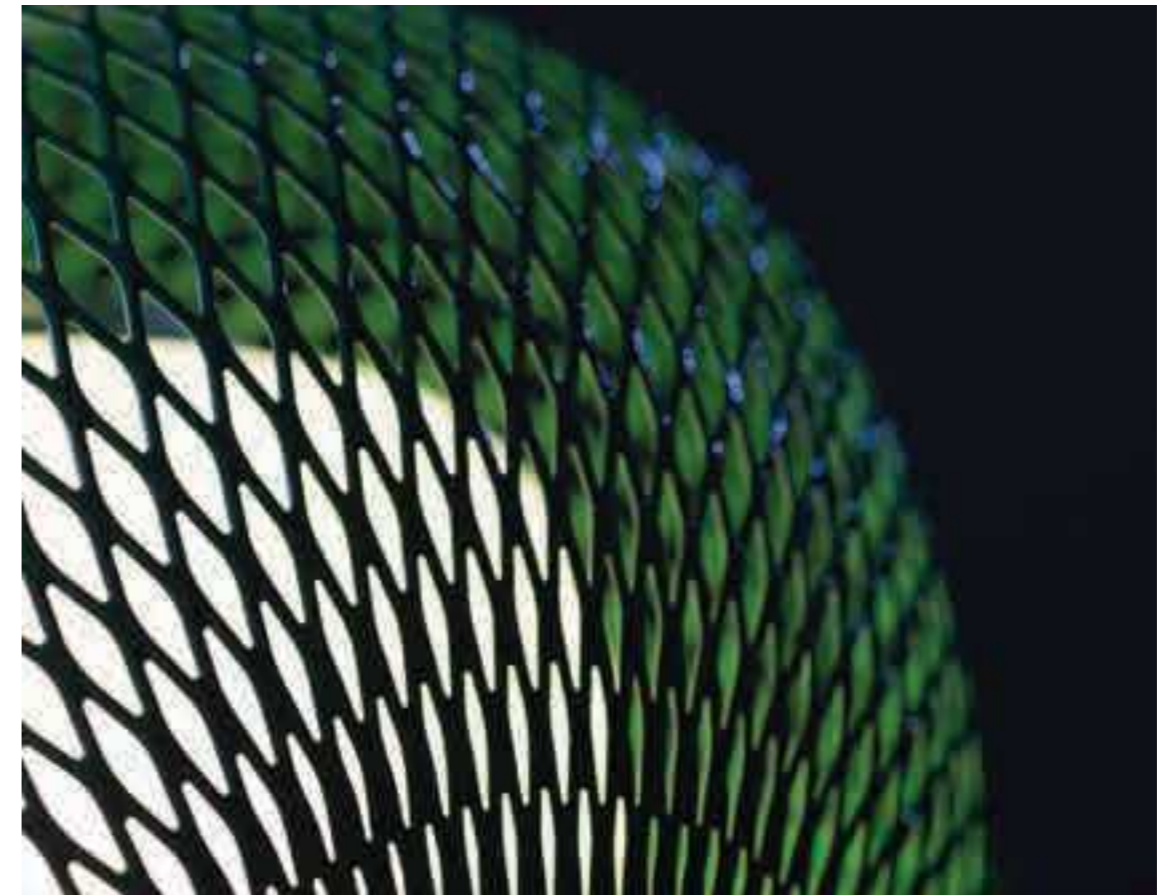

# Blok

Design by Stéphane Joyeux

---



# Blok

IP65  
IK10  
Class 2

Aluminium or stainless steel  
Satin-finish PMMA front diffuser  
Opal polycarbonate back diffuser

## SOURCES

LED 9W - 3000K warm white  
LED 9W - 4000K neutral white



LED 9W  
Real light output - 238 lm  
CRI > 80

## REFERENCES

Replace ●●● with the colour code or material code

MODEL	LED 9W 3000K warm white	LED 9W 4000K neutral white
1	113 001 ●●●	113 002 ●●●

## COLOURS CODES

Replace ●●● with the colour code

	VELVET BLACK 113		RAL 3020 TRAFFIC RED 056
	RAL 9010 PURE WHITE 101		RAL 2004 PURE ORANGE 014
	BLUE 111		RAL 1016 SULFUR YELLOW 068

Other colours on request

## MATERIAL CODE

 STAINLESS STEEL 018

## MOUNTING

Wiring entry point in grey - Fixing kit included

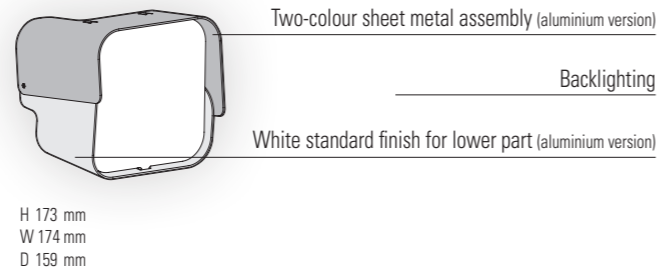
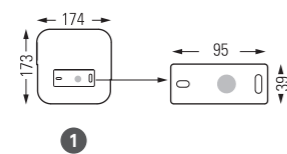

# Loko

Design by Stéphane Joyeux

---



# Loko

IP44  
IK10  
Class 2

Aluminium  
Satin-finish ridged polycarbonate diffuser

## SOURCE

E27 - 23W max - Ø75 mm - H150 mm max



E27 (2450 lm)  
Real light output - 1353 lm

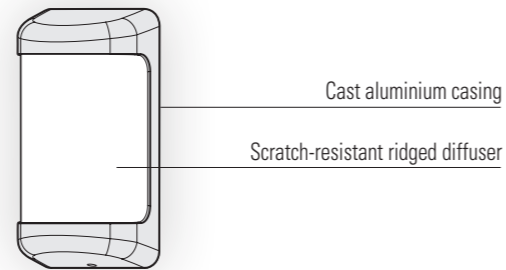

H 307 mm  
W 168 mm  
D 106 mm

## REFERENCE

Replace ●●● with the colour code

MODEL	E27
1	132 001 ●●●

## COLOURS CODES

Replace ●●● with the colour code

	RAL 7021 BLACK GREY 107		RAL 3013 TOMATO RED 110
	SLATE GREY 059		RAL 6025 FERN GREEN 109
	RAL 7044 SILK GREY 105		RAL 1016 SULFUR YELLOW 068
	RAL 9010 PURE WHITE 101		SANDSTONE 054
	BLUE 111		OLD RUSTIC 046
	RAL 5011 STEEL BLUE 065		

Other colours on request

## MOUNTING

Wiring entry point in grey - Fixing kit included

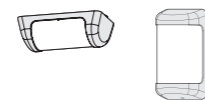
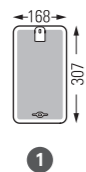

307 / 168 / 106  
1

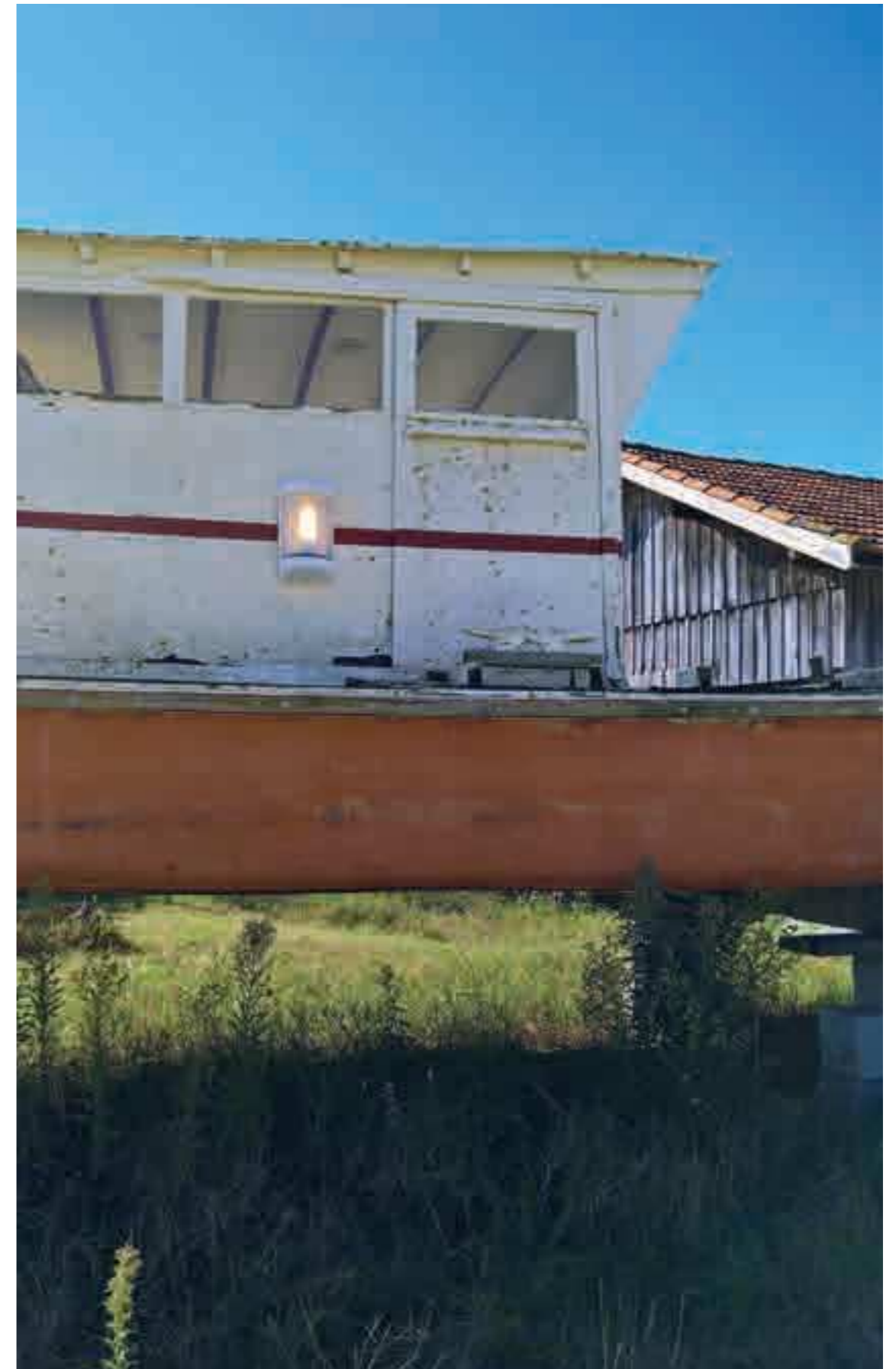



# Tank

Design by Cédric Ragot

---

Inspired by the New York water tanks, the Tank lamps are such as light storehouses. Almost larger than life, contrasted finishes with opalescent diffuser and a wooden base, Tank lamps blend industrial codes and the habitat world to multiply usages.  
One lampshade, three geometrics base thus allowing four different usages.



# Tank

IP65  
 IP20 (version with switch available on request)   
 Class 2

Retified wood, sandblasted stainless steel  
 Opal polypropylène diffuser

## SOURCE

E27 - 60W max Ø80 mm - H280 mm max

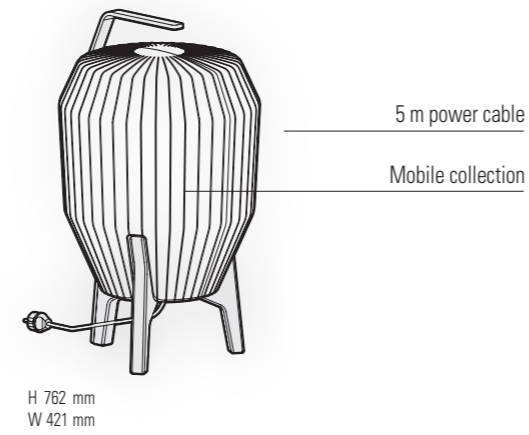

## MODELS

height / width / depth



## REFERENCES

Replace (•) with the country's electrical plug code

MODELS	E27
2	159 002 998 (•)
3	159 003 998 (•)

## PLUGS CODES

Except for French plug, replace (•) with the country's plug code ↴



UK PLUG **UK**  
 type G

SWISS PLUG **CH**  
 type J



Kent

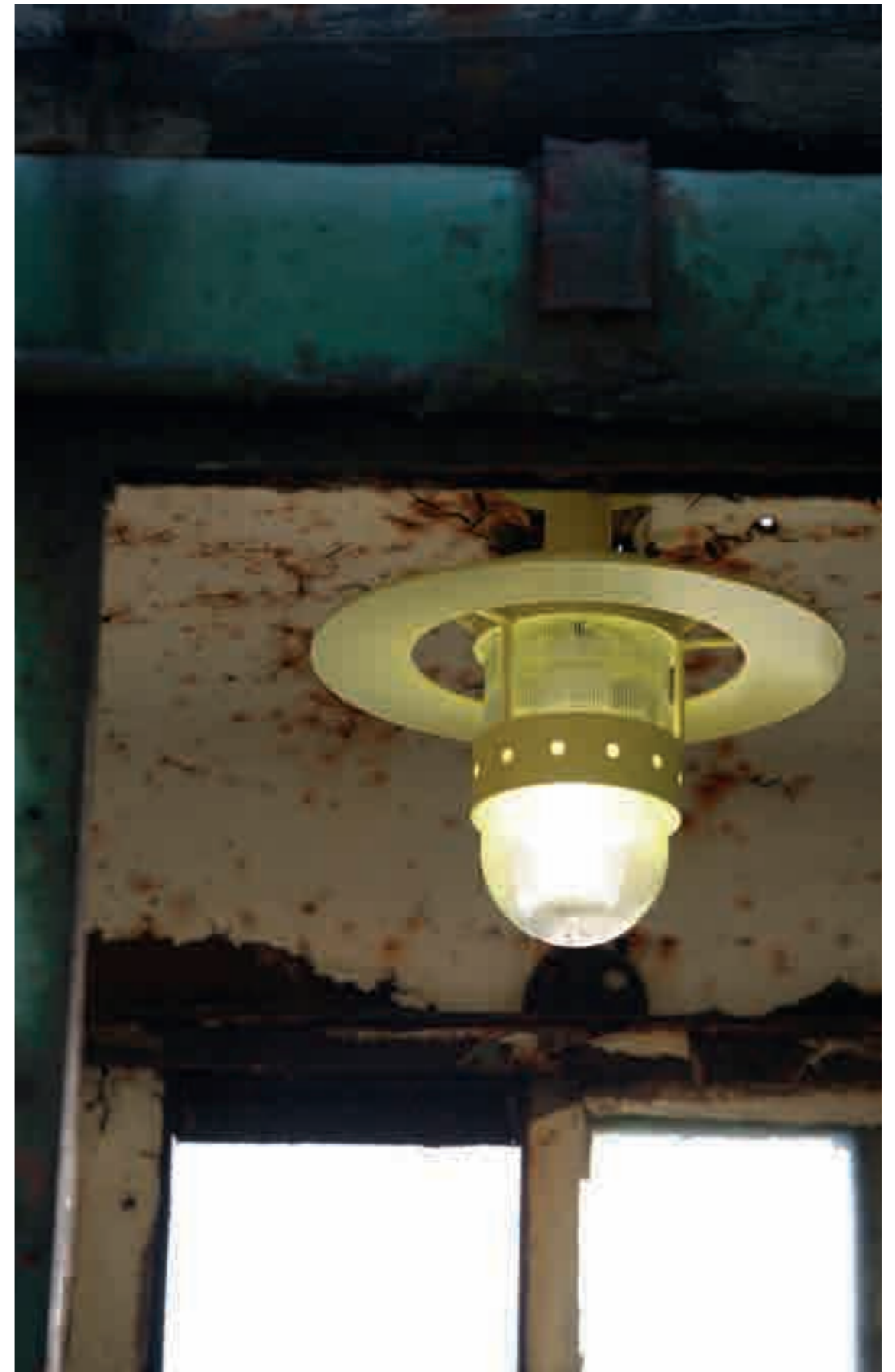

# Kent

IP44  
Class 1

Aluminium  
Clear prismatic glass diffuser

## SOURCE

E27 - 105W max Ø 80 mm - H140 mm max



E27 (2450 lm)  
Real light output - 2055 lm

## MODELS

height / width / depth



330 / 320

1

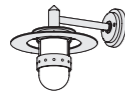

339 / 320 / 430

2

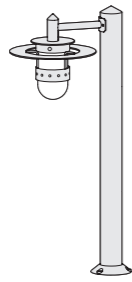

1 001 / 320 / 517

3

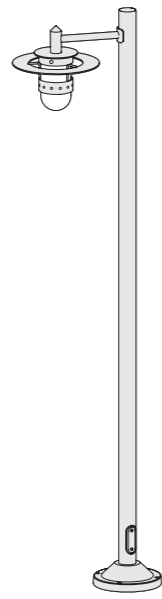

2 185 / 320 / 559

4

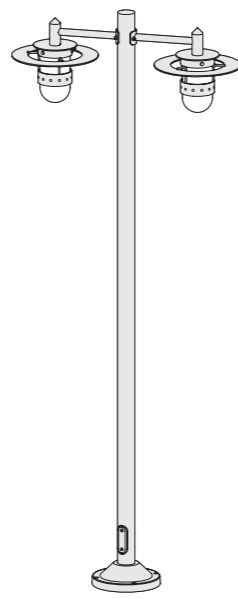

2 185 / 320 / 869

5

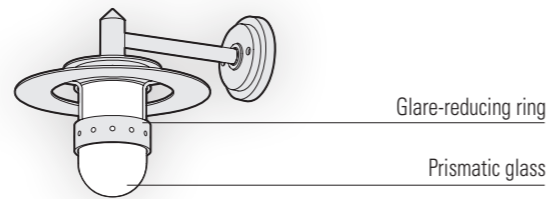

Glare-reducing ring

Prismatic glass

H 339 mm  
W 320 mm  
D 430 mm

## REFERENCES

Replace ●●● with the colour code

MODELS	E27	SPARE DIFFUSER
1	127 001 ●●●	165 030 609
2	127 002 ●●●	165 030 609
3	127 003 ●●●	165 030 609
4	127 004 ●●●	165 030 609
5	127 005 ●●●	165 030 609

## COLOURS CODES

Replace ●●● with the colour code

RAL 7021 BLACK GREY 107  
 DARK GREY 006  
 SLATE GREY 059  
 RAL 7044 SILK GREY 105  
 RAL 9010 PURE WHITE 101

Other colours on request

RAL 3013 TOMATO RED 110  
 RAL 5011 STEEL BLUE 065  
 BLUE 111  
 OLD RUSTIC 046

## MOUNTING

Wiring entry points in grey  
Fixing kit included

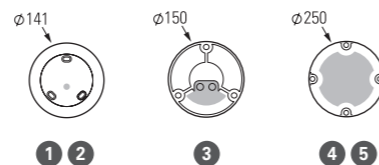

# Surf



# Surf

IP44  
IK09  
Class 1

Aluminium  
Polycarbonate diffuser

## SOURCES

E27 - 75W max      Ø 60 mm - H 135 mm max  
GU10 PAR16 LED - 2x7W max      H 58 mm max



GU10 (350 lm)  
Real light output - 2x298 lm

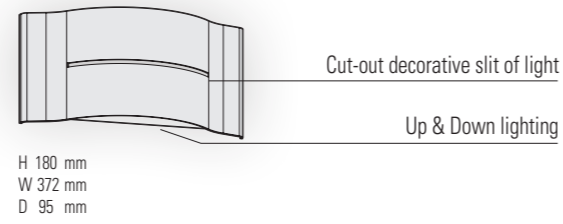

## REFERENCES

Replace ●●● with the colour code

MODEL	E27	GU10 PAR16 LED
1	158 001 ●●●	158 004 ●●●

## COLOURS CODES

Replace ●●● with the colour code

	RAL 7021 BLACK GREY 107		WHITE 001
	DARK GREY 006		LIMESTONE 053
	SLATE GREY 059		SANDSTONE 054
	RAL 7044 SILK GREY 105		OLD RUSTIC 046

Other colours on request

## MOUNTING

Wiring entry point in grey - Fixing kit included

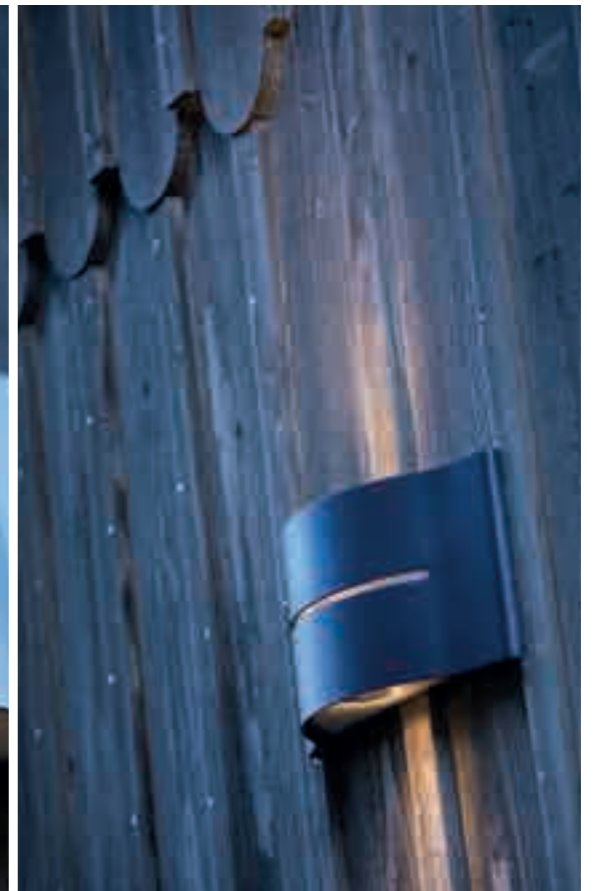
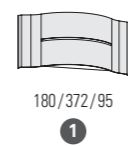
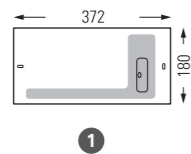

# Bermude

Design by Stéphane Joyeux

---



# Bermude

IP44  
Class 1

Aluminium  
Frosted glass diffuser

## SOURCE

E27 - 105W max Ø66 mm - H180 mm max



E27 (2450 lm)  
Real light output - 1230 lm

## MODELS

height / width / depth

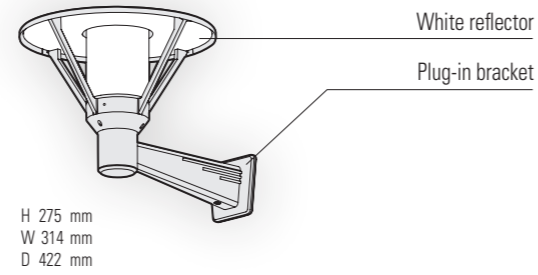
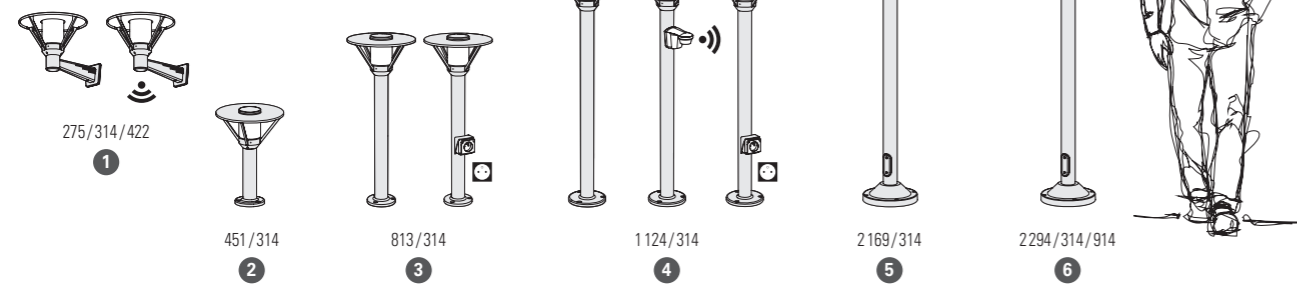

## REFERENCES

Replace ●●● with the colour code / replace ● with the country's electrical socket code

MODELS	E27	E27 + SENSOR	SOCKET	CORNER PLATE p.319	SPARE DIFFUSER
1	115 001 ●●●	115 002 ●●●		147 006 ●●●	165 019 ●●●
2	115 003 ●●●				165 019 ●●●
3	115 004 ●●●		115 005 ●●● (●)		165 019 ●●●
4	115 006 ●●●	115 007 ●●●	115 008 ●●● (●)		165 019 ●●●
5	115 009 ●●●				165 019 ●●●
6	115 010 ●●●				165 019 ●●●

## COLOURS CODES

Replace ●●● with the colour code

	RAL 7021 BLACK GREY 107		RAL 6009 FIR GREEN 067
	DARK GREY 006		RAL 5011 STEEL BLUE 065
	RAL 7044 SILK GREY 105		OLD RUSTIC 046
	WHITE 001		

Other colours on request

## MOUNTING

Wiring entry points in grey  
Fixing kit included

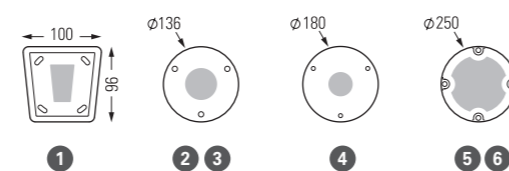

## SOCKETS CODES

Except for French socket, replace ● with country's socket code

	SCHUKO SOCKET SK		SWISS SOCKET CH
	type F		type J





# Factory

Design by Stéphane Joyeux

---



# Faktory

IP44  
Class 1

Aluminium - white reflector  
Lacquered copper or raw zinc - black reflector  
Clear glass diffuser

## SOURCE

E27 - 70W max    Ø66 mm - H 160 mm max



E27 (2450 lm)  
Real light output - 1530 lm

## MODELS

height / width / depth



223 / 346 / 438

500 / 346

2000 / 346

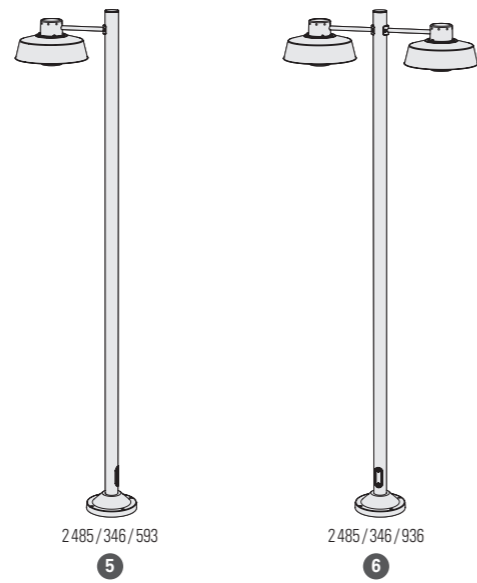

2485 / 346 / 593

2485 / 346 / 936

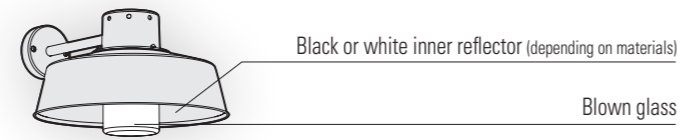

Black or white inner reflector (depending on materials)

Blown glass

H 223 mm  
W 346 mm  
D 438 mm

## REFERENCES

Replace **•••** with the colour code or material code

MODELS	E27	CORNER PLATE p.319	SPARE DIFFUSER
1	122 001 •••	147 005 •••	165 001 609
2	122 002 •••		165 001 609
3	122 003 •••		165 001 609
5	122 004 •••		165 001 609
6	122 005 •••		165 001 609

## COLOURS CODES

Replace **•••** with the colour code

	RAL 7021 BLACK GREY <b>107</b>		RAL 9010 PURE WHITE <b>101</b>
	SLATE GREY <b>059</b>		RAL 3013 TOMATO RED <b>110</b>
	RAL 7044 SILK GREY <b>105</b>		OLD RUSTIC <b>046</b>

Other colours on request

## MOUNTING

Wiring entry points in grey  
Fixing kit included

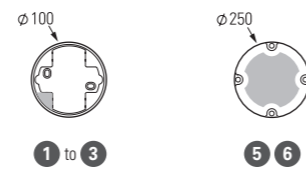

## MATERIAL CODES

	LACQUERED COPPER <b>084</b> (Black aluminium base)
	RAW ZINC <b>092</b> (Black aluminium base)



# Kerlouan

Design by Stéphane Joyeux

---



# Kerlouan

IP44  
Class 1

Aluminium  
Polycarbonate diffuser

## SOURCE

E27 - 105W max Ø66 mm - H145 mm max



E27 (2450 lm)  
Real light output - 493 lm

## MODELS

height / width / depth

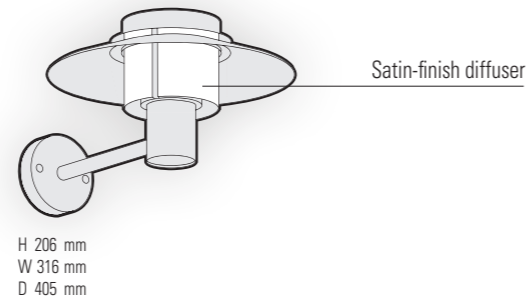
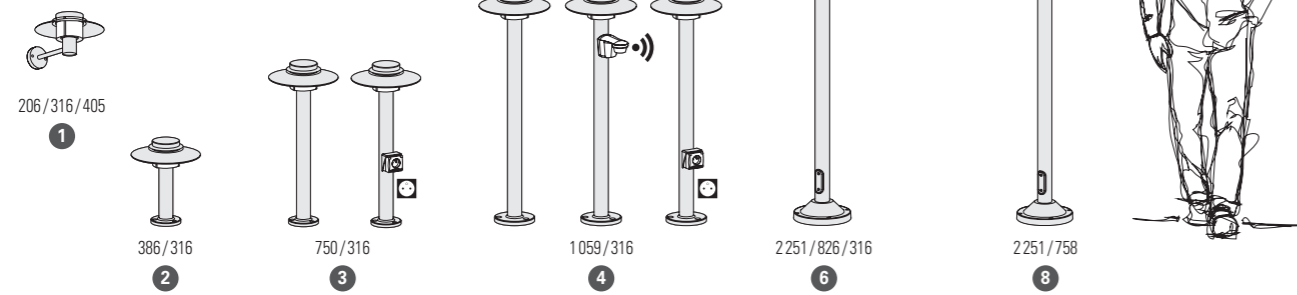

## REFERENCES

Replace ●●● with the colour code / replace (●) with the country's electrical socket code

MODELS	E27	E27 + SENSOR	SOCKET	CORNER PLATE p.319	SPARE DIFFUSER
1	128 001 ●●●			147 005 ●●●	165 031 601
2	128 002 ●●●				165 031 601
3	128 003 ●●●		128 004 ●●●(●)		165 031 601
4	128 005 ●●●	128 007 ●●●	128 006 ●●●(●)		165 031 601
6	128 008 ●●●				165 031 601
8	128 009 ●●●				165 031 601

## COLOURS CODES

Replace ●●● with the colour code

	DARK GREY 006		RAL 6009 BRITISH GREEN 019
	SLATE GREY 059		RAL 6009 FIR GREEN 067
	METAL GREY 023		RAL 5011 STEEL BLUE 065
	WHITE 001		OLD RUSTIC 046

Other colours on request

## MOUNTING

Wiring entry points in grey  
Fixing kit included

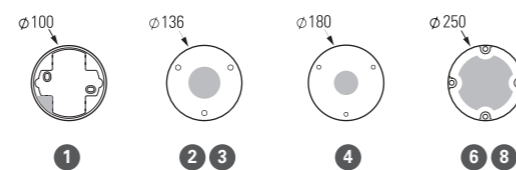

## SOCKETS CODES

Except for French socket, replace (●) with country's socket code

SCHUKO SOCKET SK type F  
 SWISS SOCKET CH type J



# Aubanne

Design by Stéphane Joyeux

---





# Aubanne

IP44  
Class 1

Aluminium  
Frosted or clear glass diffuser  
Opal polycarbonate reflector

## SOURCE

E27 - 23W max Ø66mm - H150mm max



E27 (2450 lm)  
Real light output/frosted - 1633 lm

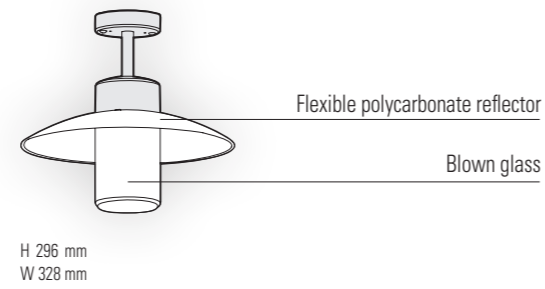

## MODELS

height / width / depth

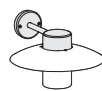

220 / 328 / 391  
1



296 / 328  
2



961 / 328 / 489  
3

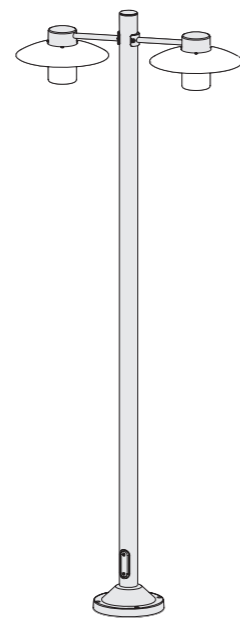

2185 / 328 / 559  
4

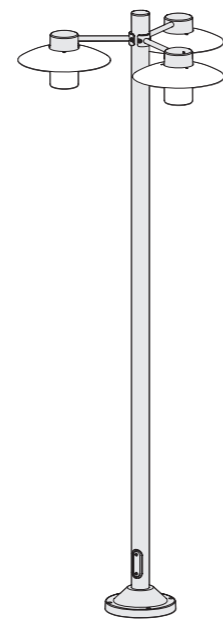

2185 / 828 / 328  
5



2185 / 796  
6

# Aubanne

## REFERENCES

Replace ... with the colour code

MODELS	DIFFUSERS	E27	CORNER PLATE p.319	SPARE DIFFUSERS
1	CLEAR GLASS	101 001 ...	147 005 ...	165 001 609
	FROSTED GLASS	101 002 ...		165 001 610
2	CLEAR GLASS	101 003 ...		165 001 609
	FROSTED GLASS	101 004 ...		165 001 610
3	CLEAR GLASS	101 005 ...		165 001 609
	FROSTED GLASS	101 006 ...		165 001 610
4	CLEAR GLASS	101 007 ...		165 001 609
	FROSTED GLASS	101 008 ...		165 001 610
5	CLEAR GLASS	101 009 ...		165 001 609
	FROSTED GLASS	101 010 ...		165 001 610
6	CLEAR GLASS	101 011 ...		165 001 609
	FROSTED GLASS	101 012 ...		165 001 610

## COLOURS CODES

Replace ... with the colour code

	RAL 9010 PURE WHITE	101
	DARK GREY	006
	SLATE GREY	059
	METAL GREY	023
	SANDSTONE	054
	OLD RUSTIC	046
	RAL 5011 STEEL BLUE	065

Other colours on request

## MOUNTING

Wiring entry points in grey - Fixing kit included

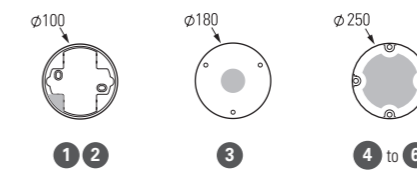

Duo

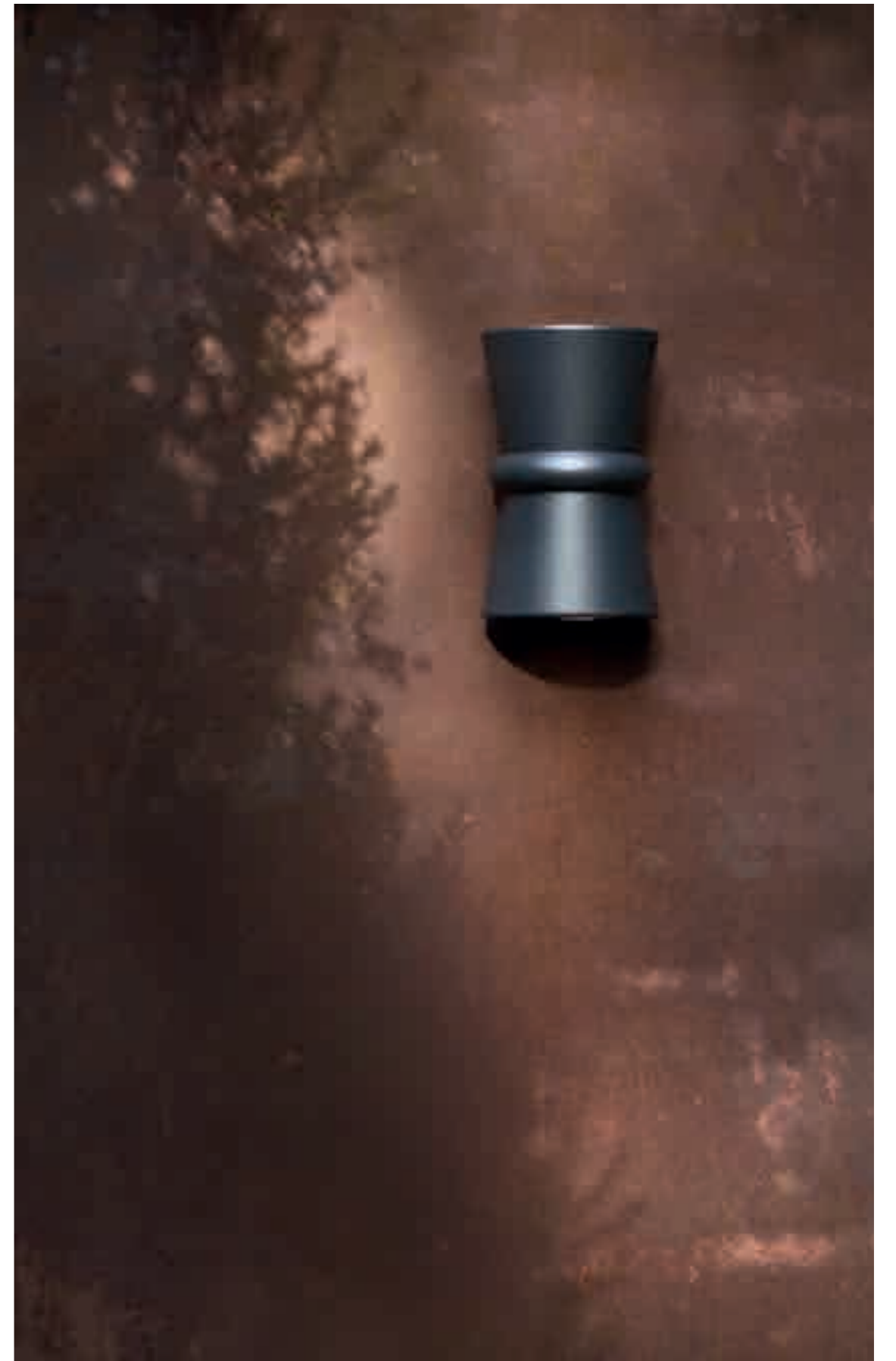



# Duo

IP44  
Class 1

Aluminium  
Clear tempered glass diffuser

## SOURCE

GU10 PAR16 LED - 2x23W max H 80 mm max

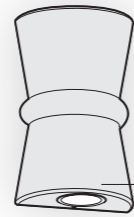

Up and Down lighting  
Bulb sockets are height-adjustable

H 300 mm  
W 186 mm  
D 132 mm

## REFERENCE

Replace ●●● with the colour code

MODEL	GU10 PAR16 LED
1	120 001 ●●●

## COLOURS CODES

Replace ●●● with the colour code

	DARK GREY 006
	SLATE GREY 059
	RAL 7044 SILK GREY 105
	RAL 9010 PURE WHITE 101

Other colours on request

	SANDSTONE 054
	OLD RUSTIC 046
	GOLD PATINA 009

## MOUNTING

Wiring entry point in grey - Fixing kit included

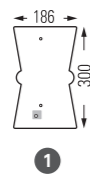

300/186/132

1



# Bamboo

Design by Stéphane Joyeux

---



# Bamboo

IP44 (models 1 et 2)  
 IP54 (model 3)  
 IP65 (model 3) on request  
 Class 1

Aluminium  
 Clear or opal polycarbonate diffuser

## SOURCE

GU10 PAR16 LED - 23W max H 80 mm max



MODELS 1, 2, 3

GU10 (575 lm)  
 Real light output/clear - 487 lm

## MODELS

height / width / depth

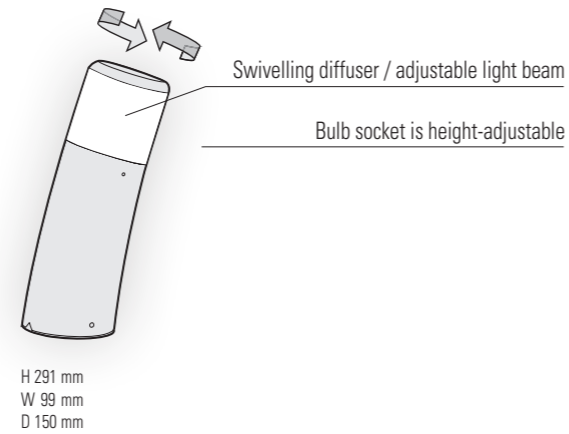
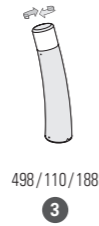

## REFERENCES

Replace ●●● with the colour code

MODELS	DIFFUSERS	GU10 PAR16 LED	SPARE DIFFUSERS
1	CLEAR POLYCARBONATE	105 001 ●●●	165 011 601
	OPAL POLYCARBONATE	105 002 ●●●	165 011 602
2	CLEAR POLYCARBONATE	105 003 ●●●	165 011 601
	OPAL POLYCARBONATE	105 004 ●●●	165 011 602
3	CLEAR POLYCARBONATE	105 005 ●●●	165 011 601
	OPAL POLYCARBONATE	105 006 ●●●	165 011 602

## COLOURS CODES

Replace ●●● with the colour code

	DARK GREY 006		RAL 3020 TRAFFIC RED 056
	SLATE GREY 059		RAL 2004 PURE ORANGE 014
	RAL 7044 SILK GREY 105		RAL 6018 YELLOW GREEN 015
	RAL 9010 PURE WHITE 101		SANDSTONE 054
Other colours on request			OLD RUSTIC 046

## MOUNTING

Wiring entry points in grey  
 Fixing kit included

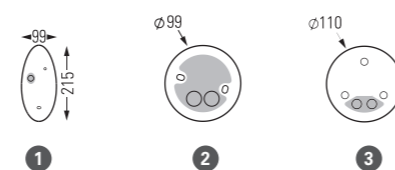

OL 1



# OL 1

IP55  
Class 1

Aluminium  
Satin-finish PMMA diffuser

## SOURCES

E27 - 30W max Ø64 mm - H 200 mm max  
G24d-3 - 26W



E27 (2450 lm)  
Real light output - 1719 lm

## MODELS

height / width / depth

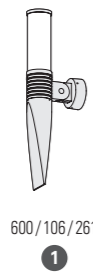

600 / 106 / 261  
1



339 / 106 / 195  
2



384 / 150  
3

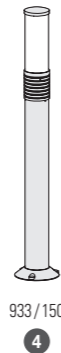

933 / 150  
4

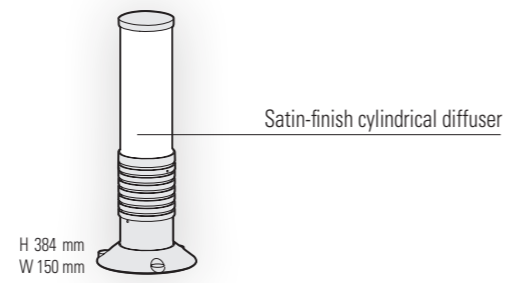

## REFERENCES

Replace ●●● with the colour code

MODELS	E27	G24d-3
1	142 001 ●●●	142 002 ●●●
2	142 003 ●●●	142 004 ●●●
3	142 005 ●●●	142 006 ●●●
4	142 007 ●●●	142 008 ●●●

## COLOURS CODES

Replace ●●● with the colour code

RAL 7021 BLACK GREY 107  
RAL 7044 SILK GREY 105  
RAL 9010 PURE WHITE 101

Other colours on request

LIMESTONE 053  
RAL 3013 TOMATO RED 110  
OLD RUSTIC 046

## MOUNTING

Wiring entry points in grey  
Fixing kit included

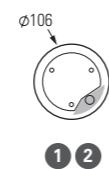

1 2

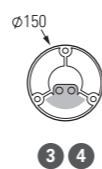

3 4



OL 2



# OL 2

IP55  
Class 1

Aluminium  
Clear PMMA diffuser

## SOURCE

GU10 PAR16 LED - 23W max H65 mm max

## MODELS

height / width / depth

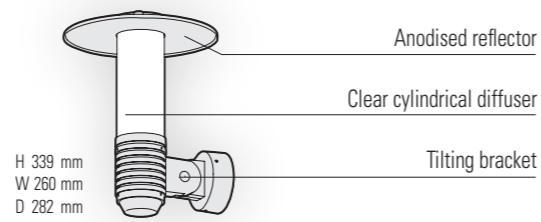
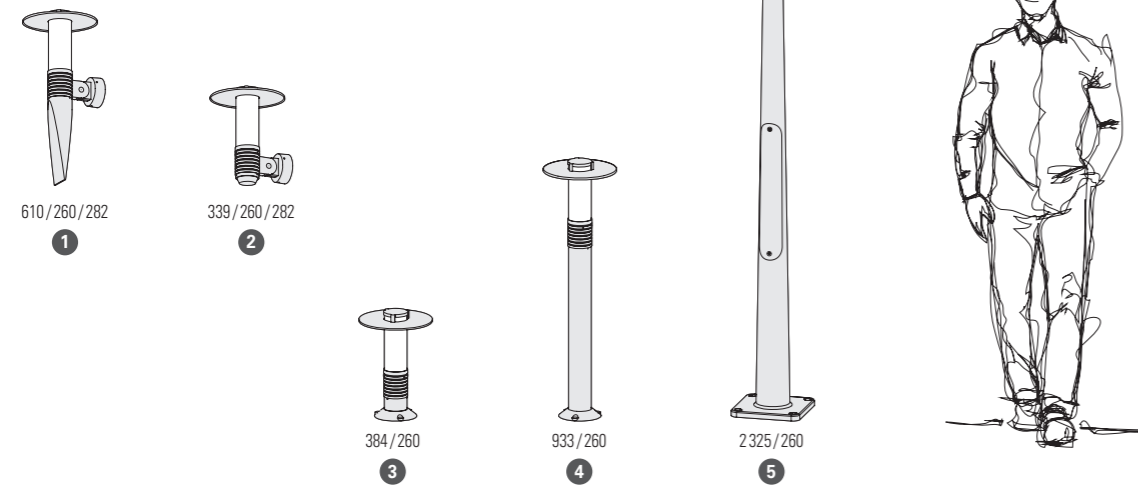

## REFERENCES

Replace ●●● with the colour code

MODELS	GU10
1	143 001 ●●●
2	143 002 ●●●
3	143 003 ●●●
4	143 004 ●●●
5	143 005 ●●●

## COLOURS CODES

Replace ●●● with the colour code

	RAL 7021 BLACK GREY	107		LIMESTONE	053
	RAL 7044 SILK GREY	105		RAL 3013 TOMATO RED	110
	RAL 9010 PURE WHITE	101		OLD RUSTIC	046

Other colours on request

## MOUNTING

Wiring entry points in grey - Fixing kit included - Anchor bolts on request (model 5) p.318

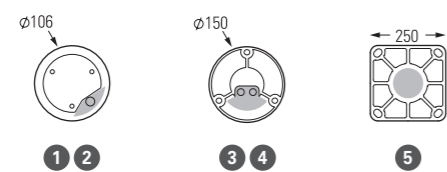

OL 3







# OL 3

IP55  
Class 1

Aluminium  
Frosted tempered glass diffuser

## SOURCES

LED 28W - 3000K warm white  
LED 28W - 4500K neutral white  
E27 - 23W max Ø66 mm - H 145 mm max  
E27 PAR30 - 75W max  
G12 IM on request



LED 28W  
Real light output - 1303 lm  
CRI > 80

## MODELS

height / width / depth

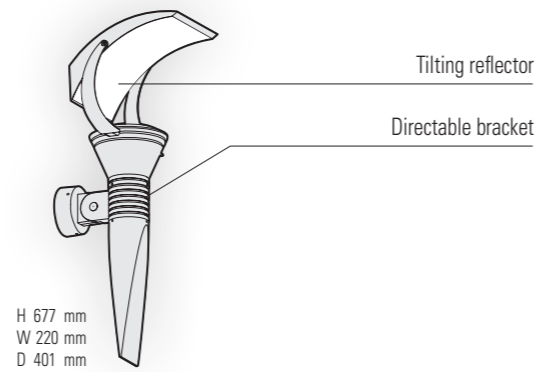
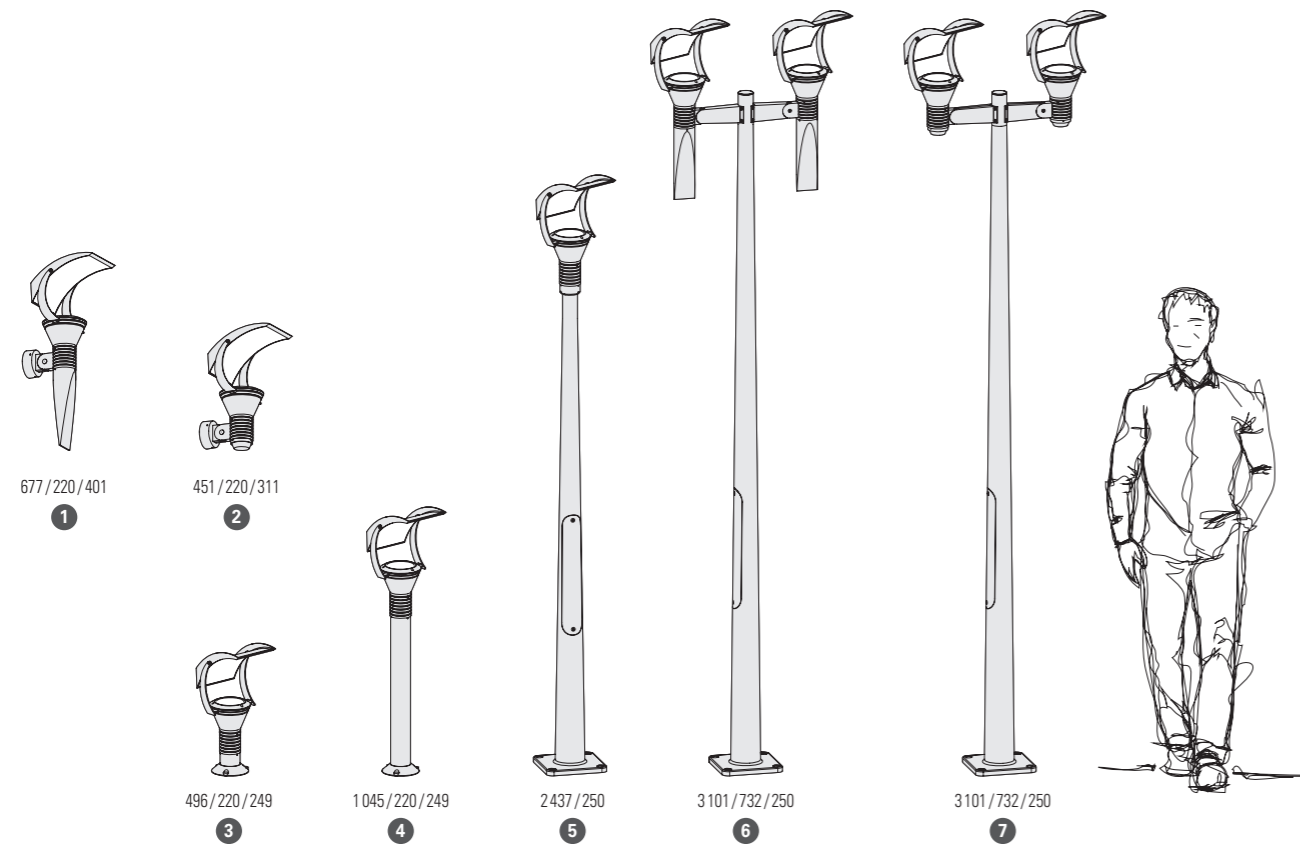

# OL 3

## REFERENCES

Replace ... with the colour code

MODELS	E27	E27 PAR30	LED 28W 3000K warm white	LED 28W 4500K neutral white
1	144 001 ...	144 002 ...	144 005 ...	144 004 ...
2	144 006 ...	144 007 ...		
3	144 008 ...	144 009 ...		
4	144 010 ...	144 011 ...	144 014 ...	144 013 ...
5	144 015 ...	144 016 ...	144 019 ...	144 018 ...
6	144 020 ...	144 021 ...	144 024 ...	144 023 ...
7	144 025 ...	144 026 ...		

## COLOURS CODES

Replace ... with the colour code

	RAL 7021 BLACK GREY	107
	RAL 7044 SILK GREY	105
	RAL 9010 PURE WHITE	101
	LIMESTONE	053
	RAL 3013 TOMATO RED	110
	OLD RUSTIC	046

Other colours on request

## MOUNTING

Wiring entry points in grey - Fixing kit included - Anchor bolts on request (model 5 to 7) p. 318

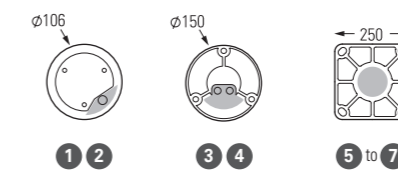

# Equix

Design by Stéphane Joyeux

---



# Equix

IP55  
Class 1

Aluminium head and pole  
Bichromated steel base  
Toughened borosilicate glass diffuser

## SOURCES

LED 35W - 4000K neutral white  
Initial flux - 5500 lm  
CRI > 80

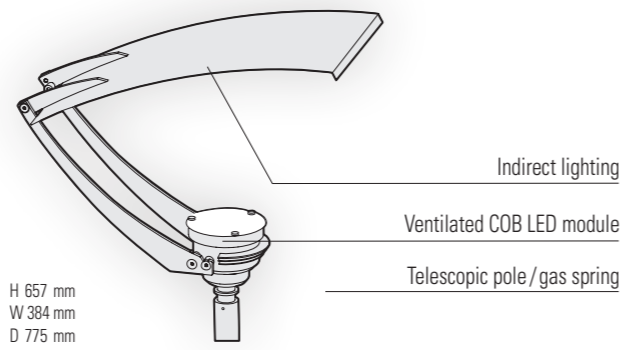

## MODELS

height / width / depth

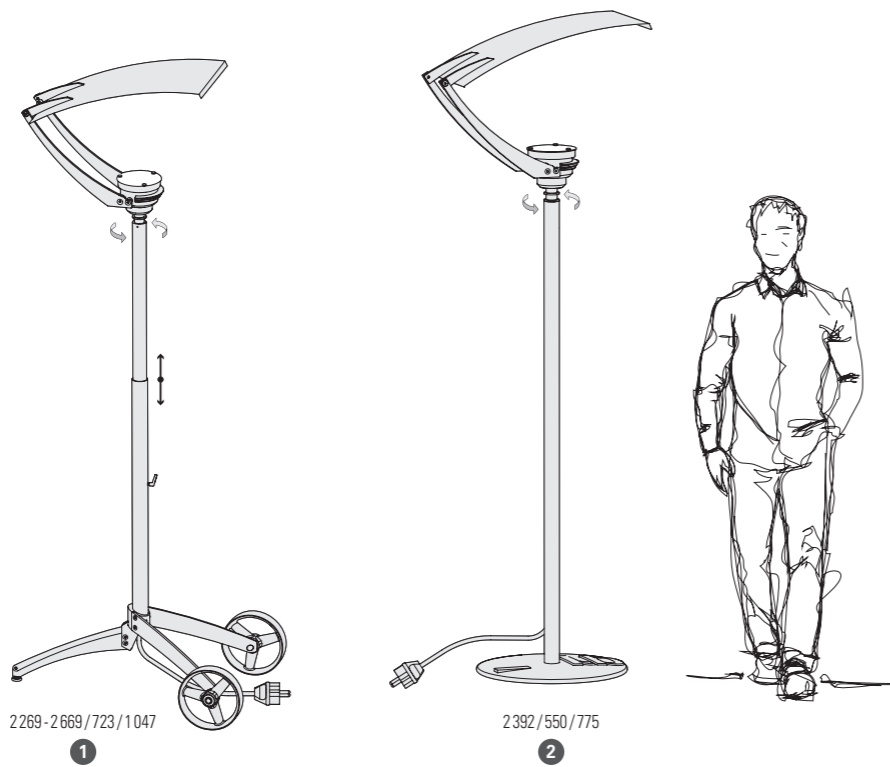

## REFERENCES

Replace ●●● with the colour code / replace (●) with the country's electrical plug code

MODELS	LED 35W 4000K neutral white	SPARE DIFFUSER
1	121 001 ●●●(●)	165 026 610
2	121 002 ●●●(●)	165 026 610

## COLOURS CODES

Replace ●●● with the colour code ↴

	RAL 7021 BLACK GREY 107
	RAL 7044 SILK GREY 105
	RAL 3005 WINE RED 066
	RAL 5011 STEEL BLUE 065

Other colours on request

## PLUGS CODES

Except for French plug, replace (●) with the country's plug code ↴

	SCHUKO PLUG <b>SK</b> type F	UK PLUG <b>UK</b> type G	SWISS PLUG <b>CH</b> type J
--	---------------------------------	-----------------------------	--------------------------------



# Square

Design by Patrick Norguet

---

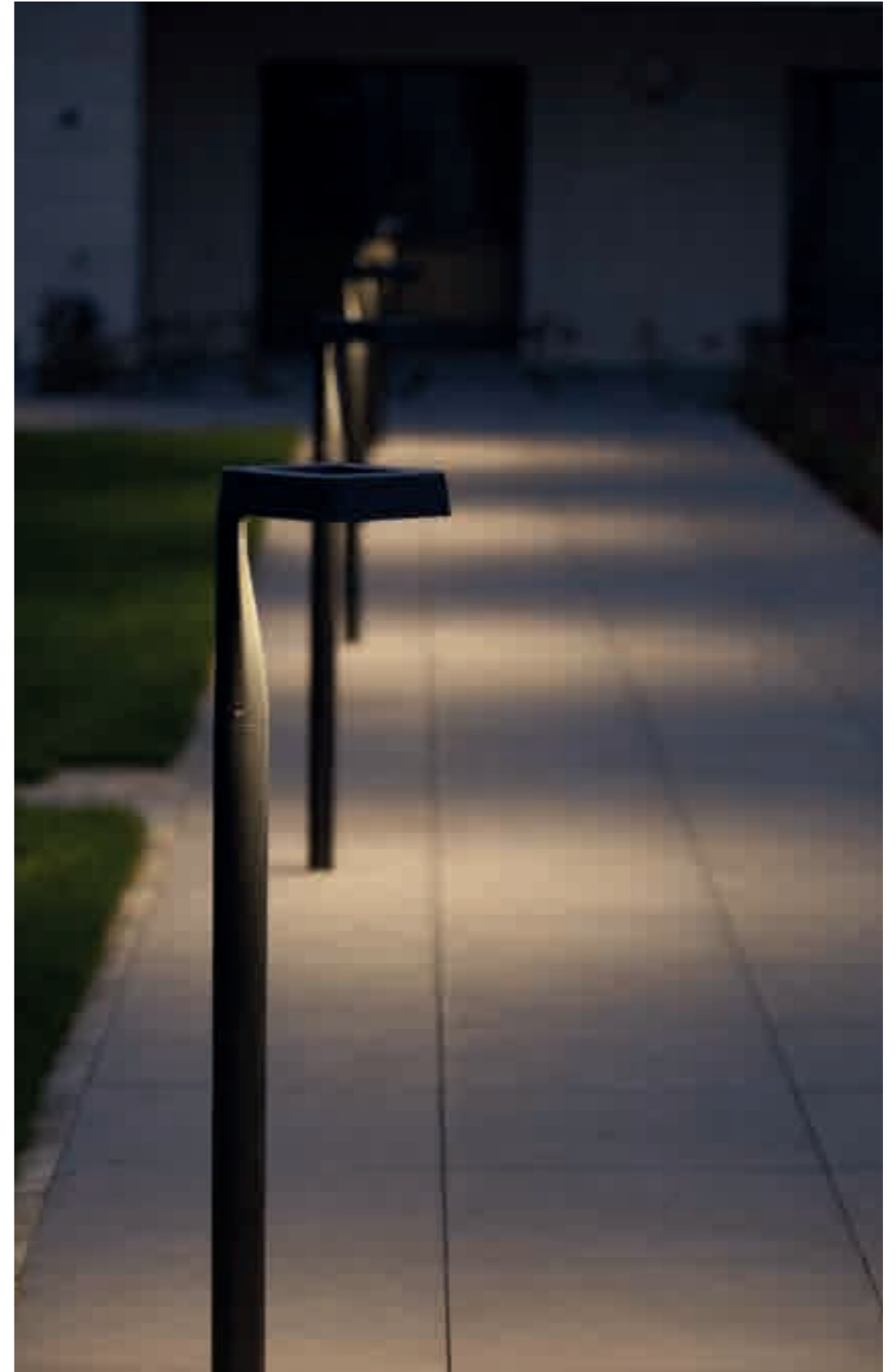

# Square

IP65  
IK09  
Class 1

Aluminium  
Satin-finish polycarbonate diffuser

## SOURCES

LED 30W - 2700K warm white  
LED 30W - 4000K neutral white



Model 1

LED 30W  
Real light output - 2716 lm  
CRI > 80



Models 2 to 4

LED 30W  
Real light output - 2691 lm  
CRI > 80

## MODELS

height / width / depth



1

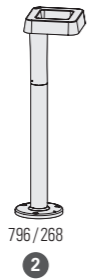

2

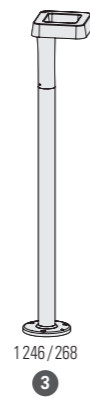

3

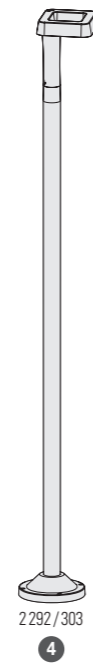

4

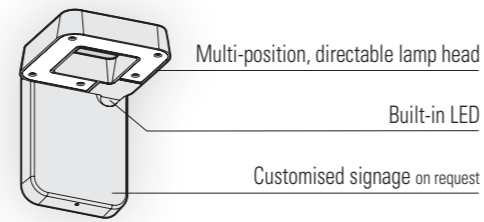

H 259 mm  
W 226 mm  
D 271 mm

## REFERENCES

Replace ●●● with the colour code

MODELS	LED 30W	LED 30W
	2700K warm white	4000K neutral white
1	156 002 ●●●	156 001 ●●●
2	156 004 ●●●	156 003 ●●●
3	156 006 ●●●	156 005 ●●●
4	156 008 ●●●	156 007 ●●●

## COLOURS CODES

Replace ●●● with the colour code

	RAL 7021 BLACK GREY 107		WHITE 001
	DARK GREY 006		RAL 3013 TOMATO RED 110
	RAL 7044 SILK GREY 105		LIMESTONE 053

Other colours on request

## MOUNTING

Wiring entry points in grey  
Fixing kit included

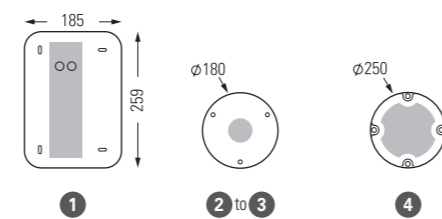

# Kirlan

Design by Stéphane Joyeux

---

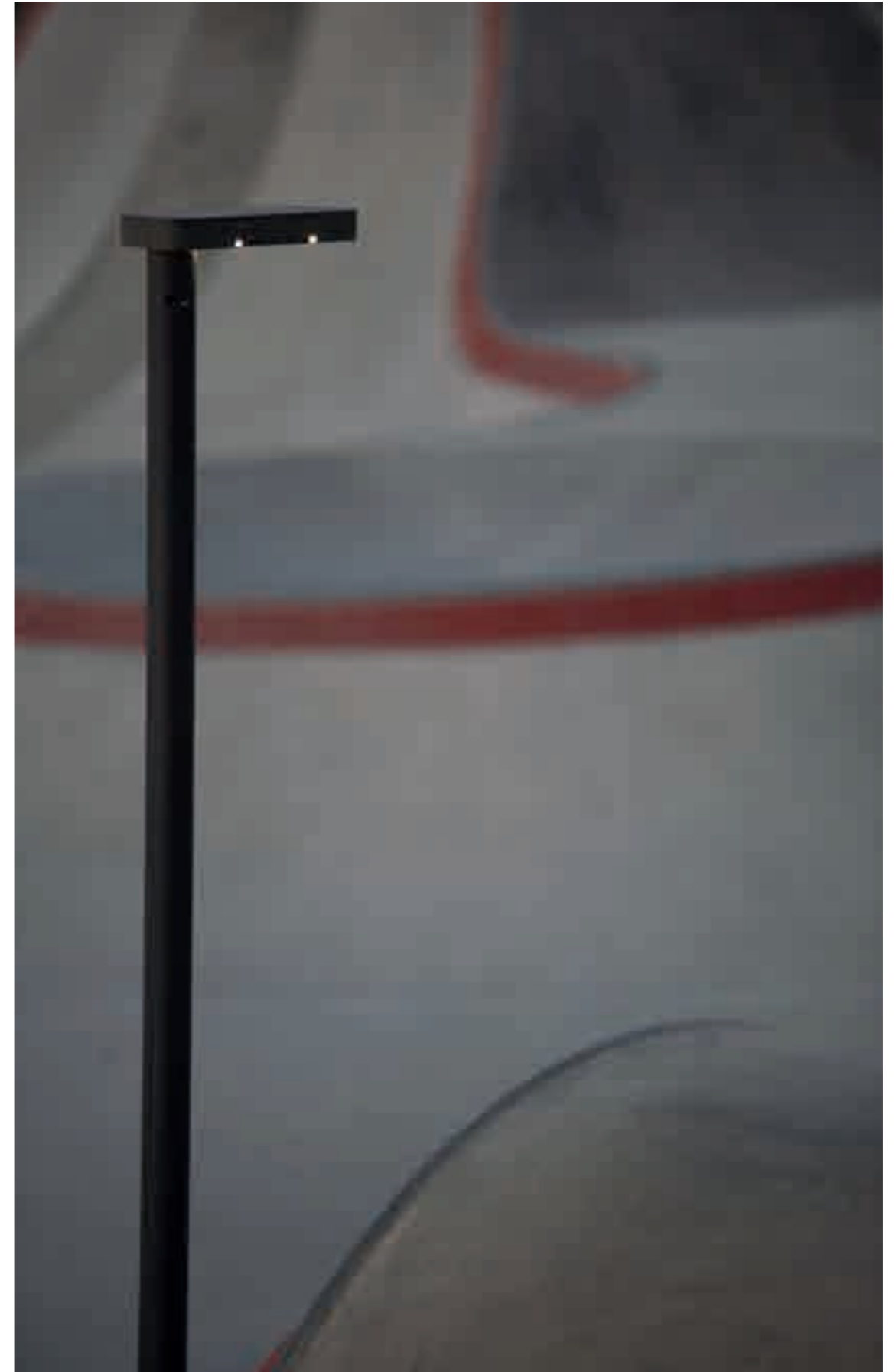

# Kirlan

IP65  
Class 1

Aluminium  
Satin-finish PMMA diffuser

## SOURCES

LED 35W - 4000K neutral white

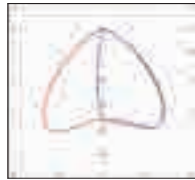

LED 35W  
Real light output - 3217 lm  
CRI > 80

## MODELS

height / width / depth

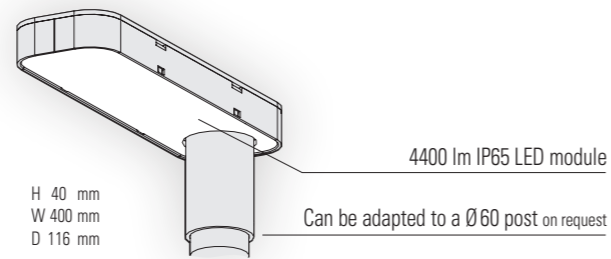
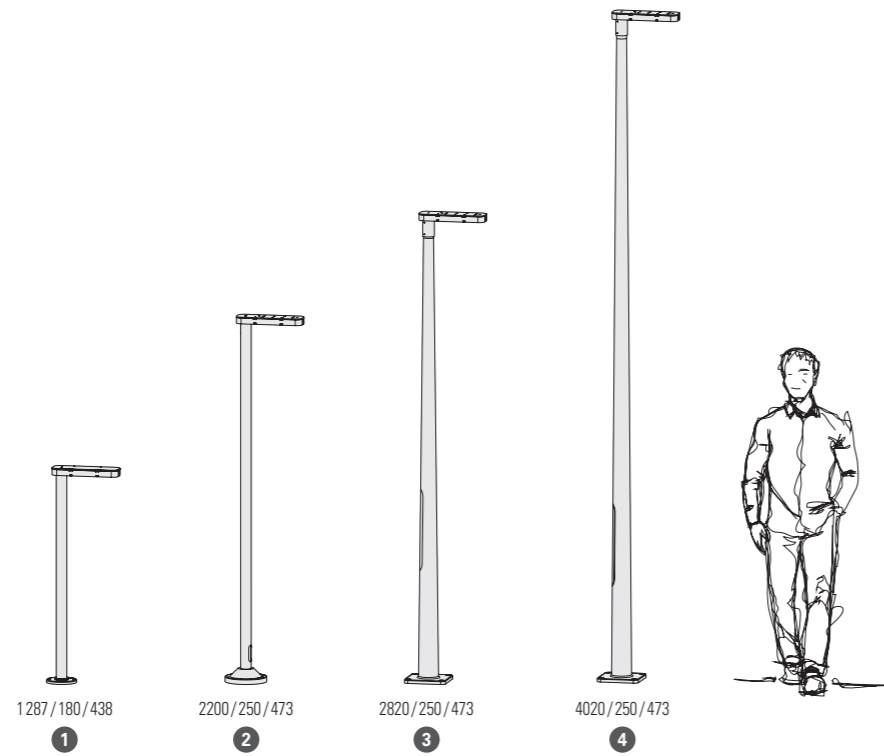

## REFERENCES

Replace **•••** with the colour code

MODELS	LED 35W 4000K neutral white
1	168 003 •••
2	168 007 •••
3	168 011 •••
4	168 015 •••

## COLOURS CODES

Replace **•••** with the colour code

	RAL 9005 JET BLACK 000		RAL 9010 PURE WHITE 101
	RAL 7021 BLACK GREY 107		RAL 3013 TOMATO RED 110
	RAL 7044 SILK GREY 105		OLD RUSTIC 046

Other colours on request

## MOUNTING

Wiring entry points in grey - Fixing kit included  
Anchor bolts on request (models 3, 4) p. 318

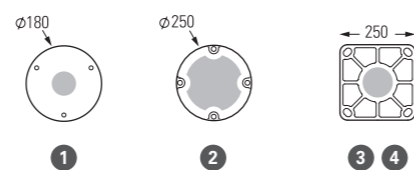



# Heritage

---



Chenonceau  
p. 166



Avenue 2  
p. 172



Avenue 3  
p. 178



Avenue 4  
p. 184



Louis Philippe 1  
p. 190

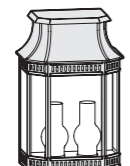

Louis Philippe 2  
p. 194



Louis Philippe 7  
p. 198



Vieille France  
p. 202



Victoria  
p. 206



Louis XIII  
p. 212



Citadelle  
p. 218



Louvre  
p. 224



Place des Vosges 1  
Évolution  
p. 230



Place des Vosges 1  
Tradition  
p. 236



Place des Vosges 2  
p. 242



Place des Vosges 3  
p. 248



Phoros  
p. 254



Monaco  
p. 258



Corum  
p. 262

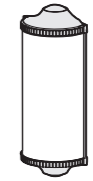

Trophy  
p. 266

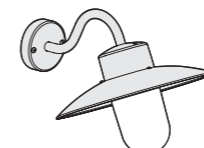

Belcour  
p. 270

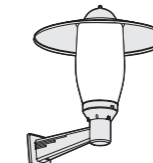

Bristol  
p. 276

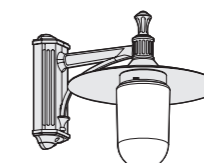

Montana  
p. 280

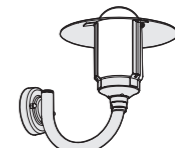

Newpark  
p. 284



Boléro  
p. 290

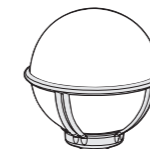

Boréal  
p. 294

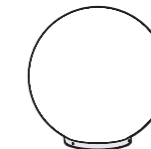

Moon  
p. 300

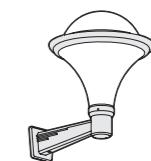

Dallas  
p. 306

## 4 sided lanterns

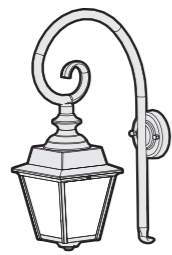

Chenonceau  
p. 166

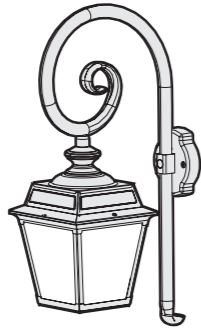

Place des Vosges 1  
Tradition  
p. 236

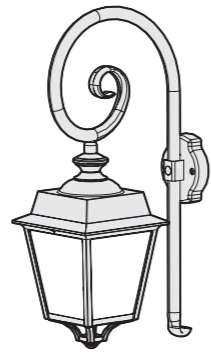

Place des Vosges 1  
Évolution  
p. 230

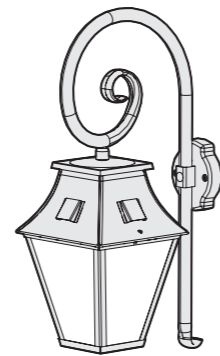

Vieille France  
p. 202

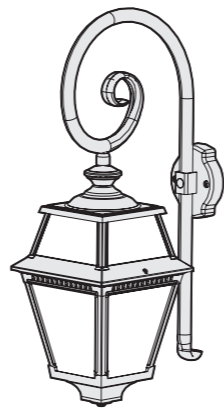

Place des Vosges 2  
p. 242

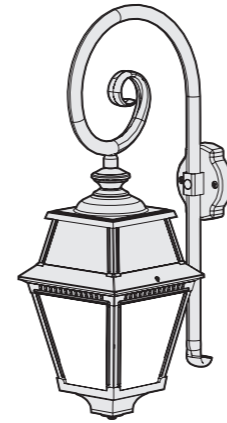

Avenue 2  
p. 172

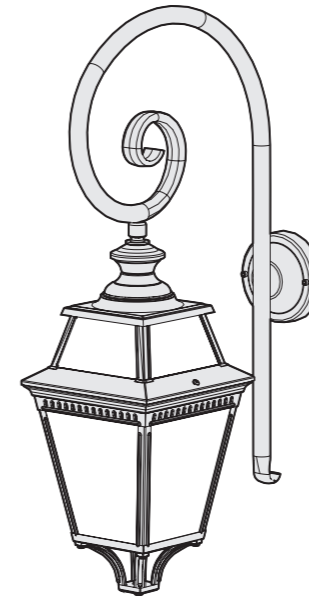

Place des Vosges 3  
p. 248

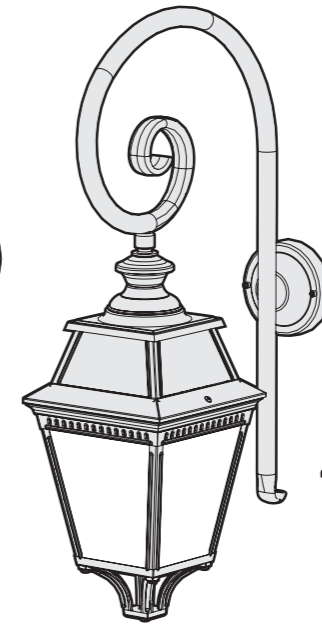

Avenue 3  
p. 178

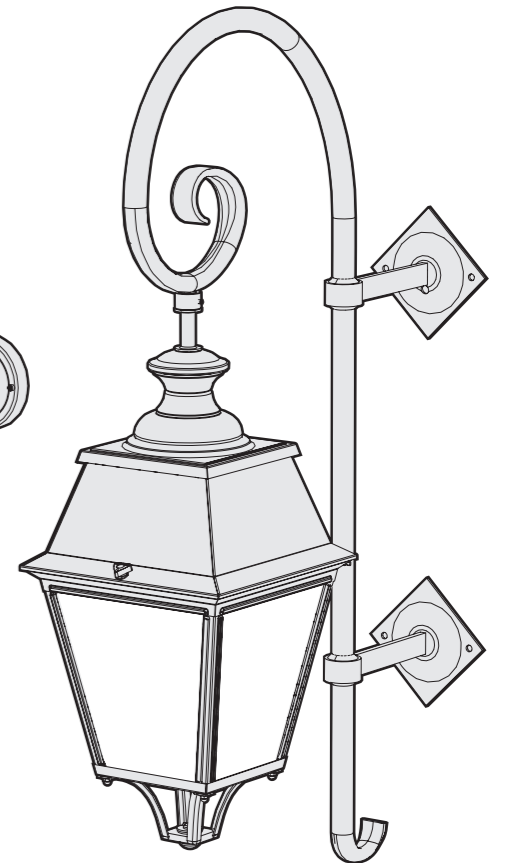

Avenue 4  
p. 184

## 6 sided lanterns

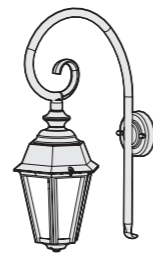

Monaco  
p. 258

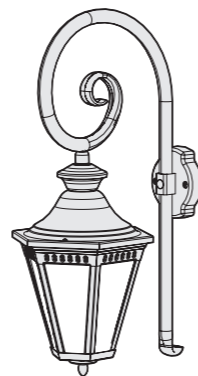

Victoria  
p. 206

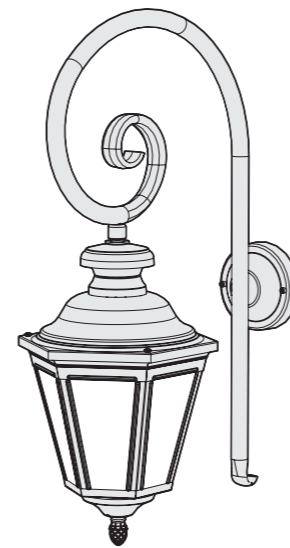

Louis XIII  
p. 212

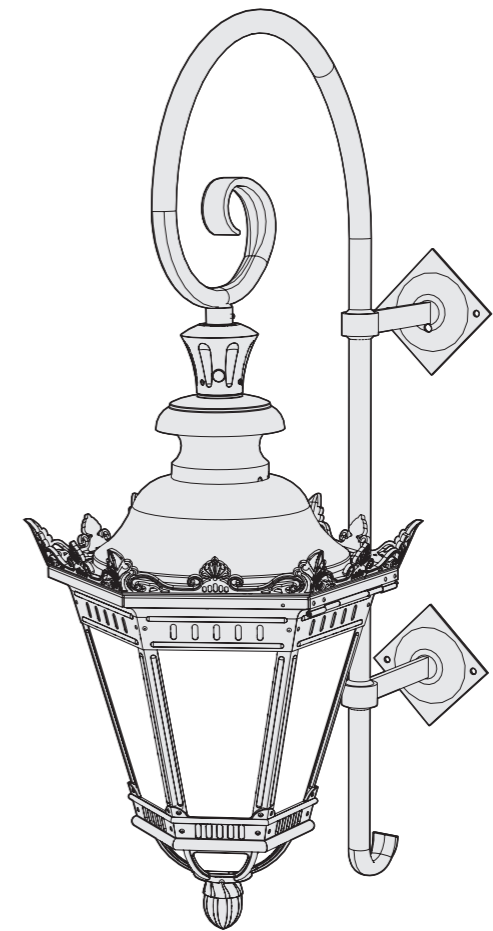

Citadelle  
p. 218

# Chenonceau

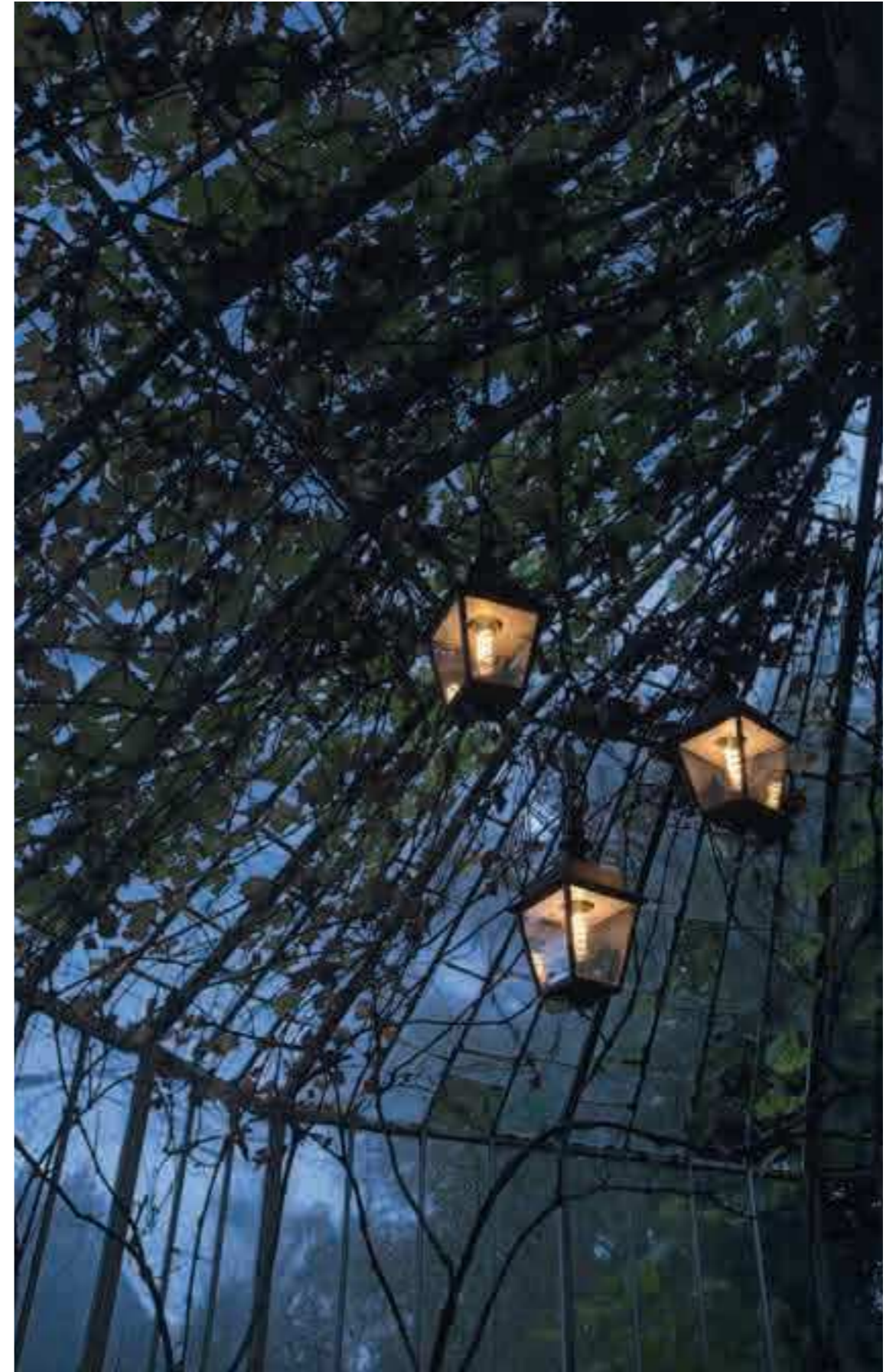



# Chenonceau

IP44  
Class 1

Aluminium  
Clear glass diffuser

## SOURCE

E27 - 75W max H 160 mm max

## MODELS

height/width/depth

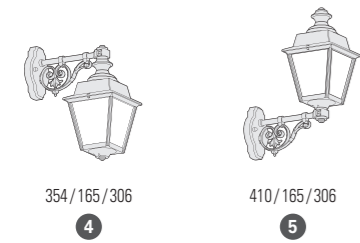
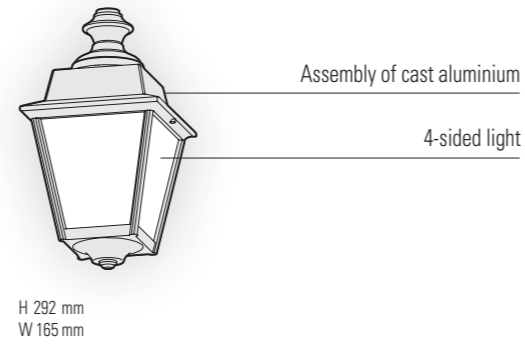

## REFERENCES

Replace ●●● with the colour code

MODELS	E27	CORNER PLATE p.319	SPARE DIFFUSER
1	117 001 ●●●		165 022 609
2	117 002 ●●●	147 002 ●●●	165 022 609
3	117 003 ●●●	147 002 ●●●	165 022 609
4	117 004 ●●●	147 002 ●●●	165 022 609
5	117 005 ●●●	147 002 ●●●	165 022 609
6	117 006 ●●●		165 022 609
7	117 007 ●●●		165 022 609
8	117 008 ●●●		165 022 609

## COLOURS CODES

Replace ●●● with the colour code

	RAL 9005 JET BLACK	000
	SLATE GREY	059
	WHITE	001
	RAL 6009 BRITISH GREEN	019
	RAL 6009 FIR GREEN	067
	SANDSTONE	054
	OLD RUSTIC	046
	GREEN PATINA	008
	GOLD PATINA	009

Other colours on request

## MOUNTING

Wiring entry points in grey - Fixing kit included

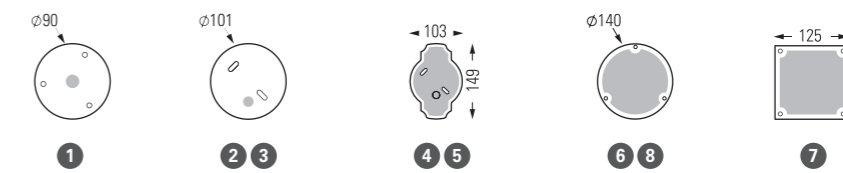

## Avenue 2

---







# Avenue 2

IP44  
Class 1

Aluminium or tinted lacquered brass  
Clear glass or opal PMMA diffuser

## SOURCES

LED 13W - 3000K warm white  
E27 - 105W max H 200 mm max (except model 3)  
Ø 66 mm - H 200 mm max (model 3)

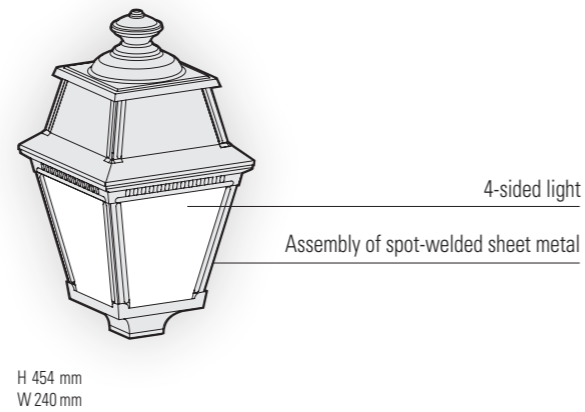

Model 1 to 11 except 3

LED 13W - IP65 module  
Real light output/opal - 384 lm  
Real light output/clear - 413 lm  
CRI > 80



Model 3

LED 13W - IP65 module  
Real light output - 477 lm  
CRI > 80



Models 1, 2, 4, 8

E27 (2450 lm)  
Real light output - 653 lm



Models 5, 6, 7, 9, 11

E27 (2450 lm)  
Real light output - 1463 lm



Model 3

E27 (1520 lm)  
Real light output - 771 lm

## MODELS

height / width / depth

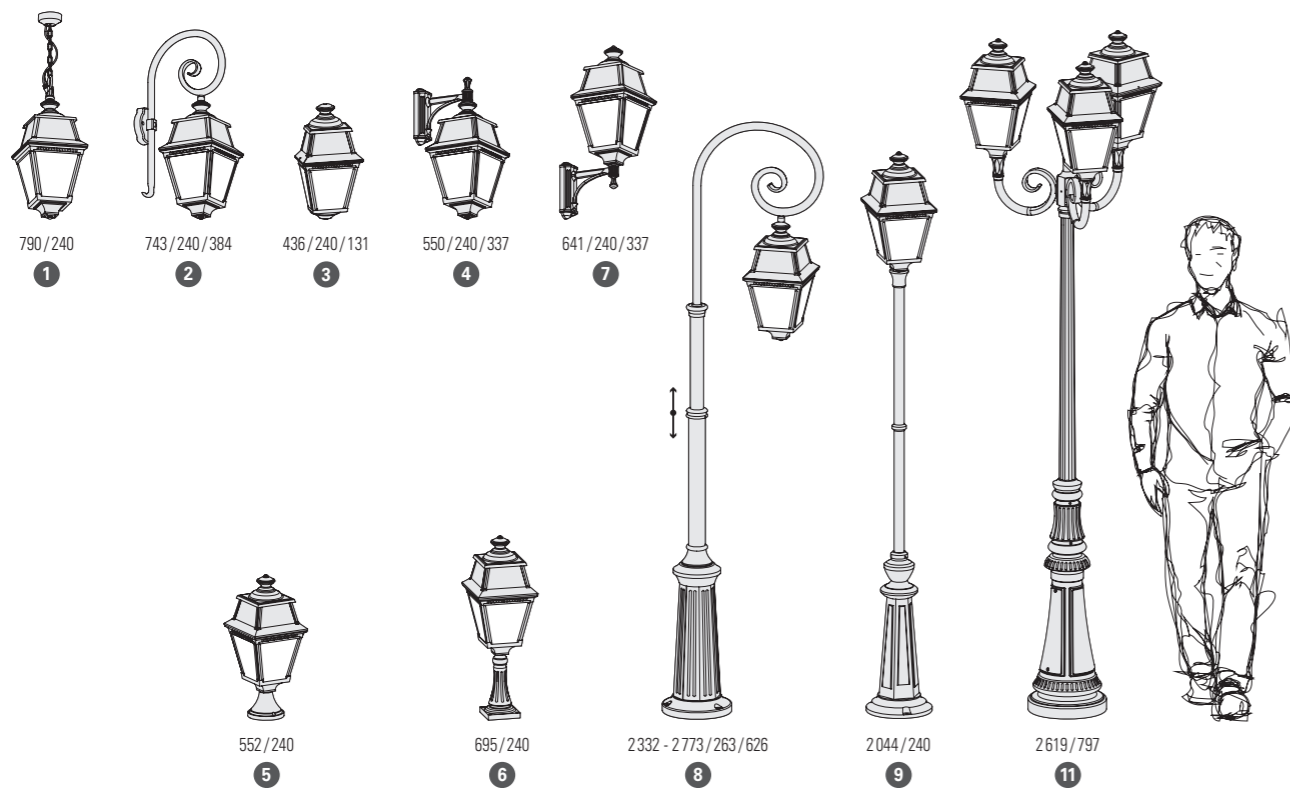

# Avenue 2

## REFERENCES

Replace ●●● with the colour code or material code

MODELS	DIFFUSERS	E27	LED 13W 3000K warm white	CORNER PLATES p.319	SPARE DIFFUSERS
1	CLEAR GLASS	102 001 ●●●	102 002 ●●●		165 003 609
	OPAL PMMA		102 003 ●●●		165 003 606
2	CLEAR GLASS	102 004 ●●●	102 005 ●●●	147 001 ●●●	165 003 609
	OPAL PMMA		102 006 ●●●		165 003 606
3	CLEAR GLASS	102 007 ●●●	102 008 ●●●		165 002 609
4	CLEAR GLASS	102 010 ●●●	102 011 ●●●	147 004 ●●●	165 003 609
	OPAL PMMA		102 012 ●●●		165 003 606
5	CLEAR GLASS	102 013 ●●●	102 014 ●●●		165 003 609
	OPAL PMMA		102 015 ●●●		165 003 606
6	CLEAR GLASS	102 016 ●●●	102 017 ●●●		165 003 609
	OPAL PMMA		102 018 ●●●		165 003 606
7	CLEAR GLASS	102 019 ●●●	102 020 ●●●	147 004 ●●●	165 003 609
	OPAL PMMA		102 021 ●●●		165 003 606
8	CLEAR GLASS	102 022 ●●●	102 023 ●●●		165 003 609
	OPAL PMMA		102 024 ●●●		165 003 606
9	CLEAR GLASS	102 025 ●●●	102 026 ●●●		165 003 609
	OPAL PMMA		102 027 ●●●		165 003 606
11	CLEAR GLASS	102 028 ●●●	102 029 ●●●		165 003 609
	OPAL PMMA		102 030 ●●●		165 003 606

## COLOURS CODES

Replace ●●● with the colour code



Other colours on request

## MATERIAL CODE

TINTED LACQUERED BRASS 070 (Black aluminium base)

## MOUNTING

Wiring entry points in grey - Fixing kit included - Anchor bolts on request (model 11) p. 318

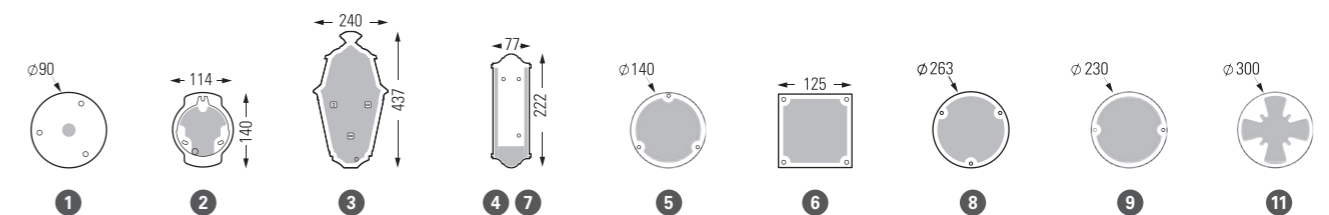

## Avenue 3

---





# Avenue 3

IP44  
Class 1

Aluminium  
Clear glass or opal PMMA diffuser

## SOURCES

LED 35W - 3000K warm white  
LED 35W - 4000K neutral white  
E27 - 105W max H 220 mm max (except model 2)  
Ø 66 mm - H 200 mm max (model 2)  
E27 SHP & IM on request

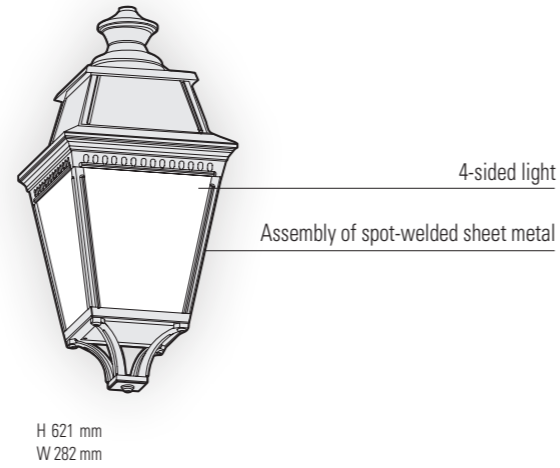

Models 1 to 12 except 2  
LED 35W - IP65 module  
Real light output/opal - 1727 lm  
Real light output/clear - 1444 lm  
CRI > 80



Model 2  
E27 (2450 lm)  
Real light output - 1304 lm



Models 4 to 8 and 10 to 12  
E27 (2450 lm)  
Real light output - 1603 lm



Models 1, 3, 9  
E27 (2450 lm)  
Real light output - 506 lm

## MODELS

height / width / depth



# Avenue 3

## REFERENCES

Replace ... with the colour code

MODELS	DIFFUSERS	E27	LED 35W - 3000K warm white	LED 35W - 4000K neutral white	CORNER PLATES p.319	SPARE DIFFUSERS
1	CLEAR GLASS	103 001 ...	103 002 ...	103 003 ...		165 005 609
	OPAL PMMA		103 004 ...	103 005 ...		165 005 606
2	CLEAR GLASS	103 006 ...				165 004 609
					147 003 ...	165 005 609
3	CLEAR GLASS	103 007 ...	103 008 ...	103 009 ...		165 005 609
	OPAL PMMA		103 010 ...	103 011 ...		165 005 606
4	CLEAR GLASS	103 012 ...	103 013 ...	103 014 ...		165 005 609
	OPAL PMMA		103 015 ...	103 016 ...	147 001 ...	165 005 606
5	CLEAR GLASS	103 017 ...	103 018 ...	103 019 ...		165 005 609
	OPAL PMMA		103 020 ...	103 021 ...		165 005 606
6	CLEAR GLASS	103 022 ...	103 023 ...	103 024 ...		165 005 609
	OPAL PMMA		103 025 ...	103 026 ...		165 005 606
12	CLEAR GLASS	103 052 ...	103 053 ...	103 054 ...		165 005 609
	OPAL PMMA		103 055 ...	103 056 ...		165 005 606

## COLOURS CODES

Replace ... with the colour code



## REFERENCES

Replace ... with the colour code

MODELS	DIFFUSERS	E27	LED 35W - 3000K warm white	LED 35W - 4000K neutral white	SPARE DIFFUSERS
10	CLEAR GLASS	103 042 ...	103 043 ...	103 044 ...	165 005 609
	OPAL PMMA		103 045 ...	103 046 ...	165 005 606
11	CLEAR GLASS	103 047 ...	103 048 ...	103 049 ...	165 005 609
	OPAL PMMA		103 050 ...	103 051 ...	165 005 606

## COLOURS CODES

Replace ... with the colour code



## REFERENCES

Replace ... with the colour code

MODELS	DIFFUSERS	E27	LED 35W - 3000K warm white	LED 35W - 4000K neutral white	SPARE DIFFUSERS
7	CLEAR GLASS	103 027 ...	103 028 ...	103 029 ...	165 005 609
	OPAL PMMA		103 030 ...	103 031 ...	165 003 606
8	CLEAR GLASS	103 032 ...	103 033 ...	103 034 ...	165 005 609
	OPAL PMMA		103 035 ...	103 036 ...	165 005 606
9	CLEAR GLASS	103 037 ...	103 038 ...	103 039 ...	165 005 609
	OPAL PMMA		103 040 ...	103 041 ...	165 005 606

## COLOURS CODES

Replace ... with the colour code

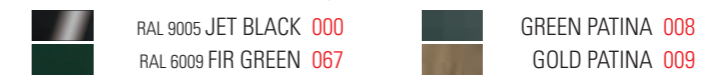

## MOUNTING

Wiring entry points in grey - Fixing kit included (except model 12) - Anchor bolts on request (models 7 to 11) p. 318

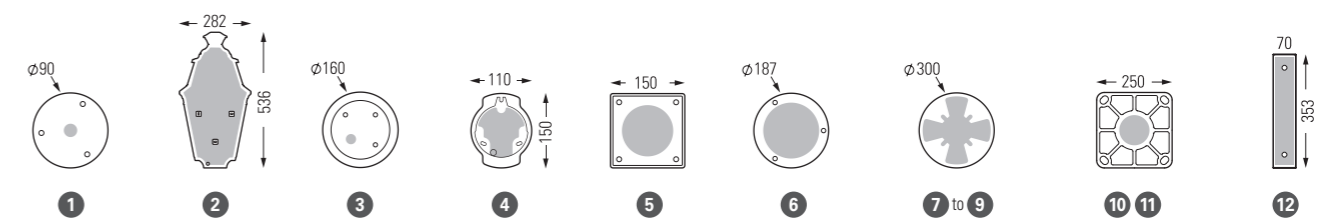

## Avenue 4

---





IP65 - LED (lantern)  
IP44 - E27 (IP65 version on request)  
Class 1

Aluminium  
Opal or clear structured PMMA diffusers for IP65 lanterns  
Opal or clear PMMA diffusers for IP44 lanterns

**SOURCES**

LED 35W - 3000K warm white (model 2 on request)  
LED 35W - 4000K neutral white (model 2 on request)  
LED 70W - 3000K warm white  
LED 70W - 4000K neutral white  
E27 - 105W max H280 mm max (except model 2)  
Ø80 mm - H160 mm max (model 2)  
E27 SHP & E40 SHP on request  
Asymmetric and dimmable LED module on request

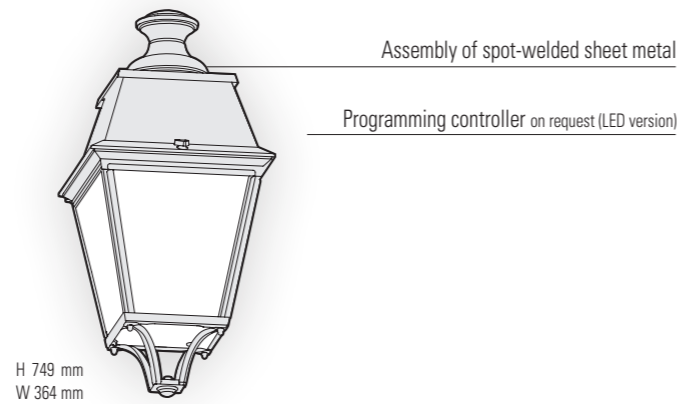

Models 1 to 9 except 2	Model 2	Models 1 to 9 except 2
LED 35W - IP65	LED 35W - IP65	LED 70W - IP65
Real light output/opal - 2693 lm	Real light output/opal - 2596 lm	Real light output/opal - 5868 lm
Real light output/clear - 2676 lm	Real light output/clear - 2229 lm	Real light output/clear - 5791 lm
CRI > 80	CRI > 80	CRI > 80

**MODELS**

height/width/depth

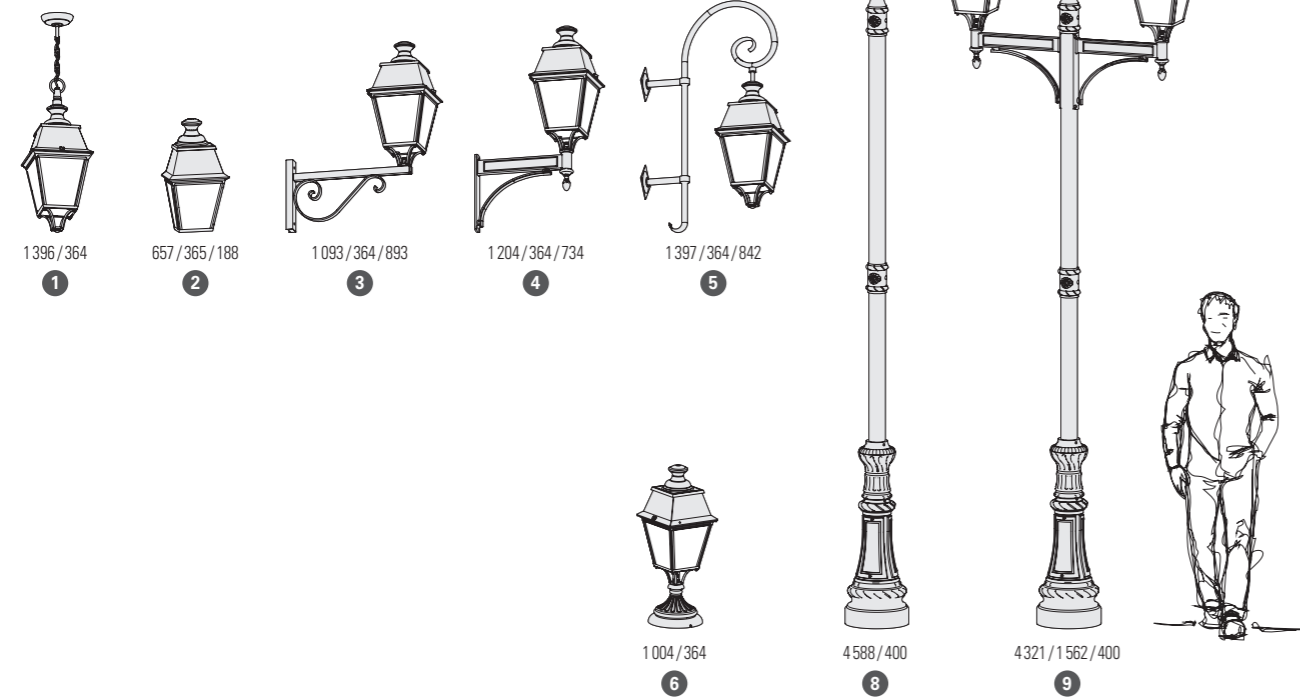

**REFERENCES**

Replace ●●● with the colour code or material code

E27 source

MODELS	DIFFUSERS	E27	IP44 SPARE DIFFUSERS
1	CLEAR PMMA	104 001 ●●●	165 007 605
	OPAL PMMA	104 018 ●●●	165 007 606
2	OPAL PMMA	104 040 ●●●	165 006 606
3	CLEAR PMMA	104 045 ●●●	165 008 605
	OPAL PMMA	104 062 ●●●	165 008 606
4	CLEAR PMMA	104 079 ●●●	165 008 605
	OPAL PMMA	104 096 ●●●	165 008 606
5	CLEAR PMMA	104 113 ●●●	165 007 605
	OPAL PMMA	104 130 ●●●	165 007 606
6	CLEAR PMMA	104 215 ●●●	165 008 605
	OPAL PMMA	104 232 ●●●	165 008 606
8	CLEAR PMMA	104 147 ●●●	165 008 605
	OPAL PMMA	104 164 ●●●	165 008 606
9	CLEAR PMMA	104 181 ●●●	165 008 605
	OPAL PMMA	104 198 ●●●	165 008 606

LED source

MODELS	DIFFUSERS	LED 35W 3000K warm white	LED 35W 4000K neutral white	LED 70W 3000K warm white	LED 70W 4000K neutral white	IP65 SPARE DIFFUSERS
1	CLEAR STRUCTURED PMMA	104 010 ●●●	104 012 ●●●	104 011 ●●●	104 013 ●●●	165 009 608
	OPAL PMMA	104 027 ●●●	104 029 ●●●	104 028 ●●●	104 030 ●●●	165 009 606
3	CLEAR STRUCTURED PMMA	104 054 ●●●	104 056 ●●●	104 055 ●●●	104 057 ●●●	165 010 608
	OPAL PMMA	104 071 ●●●	104 073 ●●●	104 072 ●●●	104 074 ●●●	165 010 606
4	CLEAR STRUCTURED PMMA	104 088 ●●●	104 090 ●●●	104 089 ●●●	104 091 ●●●	165 010 608
	OPAL PMMA	104 105 ●●●	104 107 ●●●	104 106 ●●●	104 108 ●●●	165 010 606
5	CLEAR STRUCTURED PMMA	104 122 ●●●	104 124 ●●●	104 123 ●●●	104 125 ●●●	165 009 608
	OPAL PMMA	104 139 ●●●	104 141 ●●●	104 140 ●●●	104 142 ●●●	165 009 606
6	CLEAR STRUCTURED PMMA	104 224 ●●●	104 226 ●●●	104 225 ●●●	104 227 ●●●	165 010 608
	OPAL PMMA	104 241 ●●●	104 243 ●●●	104 242 ●●●	104 244 ●●●	165 010 606
8	CLEAR STRUCTURED PMMA	104 156 ●●●	104 158 ●●●	104 157 ●●●	104 159 ●●●	165 010 608
	OPAL PMMA	104 173 ●●●	104 175 ●●●	104 174 ●●●	104 176 ●●●	165 010 606
9	CLEAR STRUCTURED PMMA	104 190 ●●●	104 192 ●●●	104 191 ●●●	104 193 ●●●	165 010 608
	OPAL PMMA	104 207 ●●●	104 209 ●●●	104 208 ●●●	104 210 ●●●	165 010 606

**COLOURS CODES**

Replace ●●● with the colour code

- RAL 9005 JET BLACK 000
- GREEN PATINA 008
- GOLD PATINA 009

Other colours on request

**MOUNTING**

Wiring entry points in grey - Fixing kit included (only for model 2) - Anchor bolts on request (models 6, 8, 9) p. 318

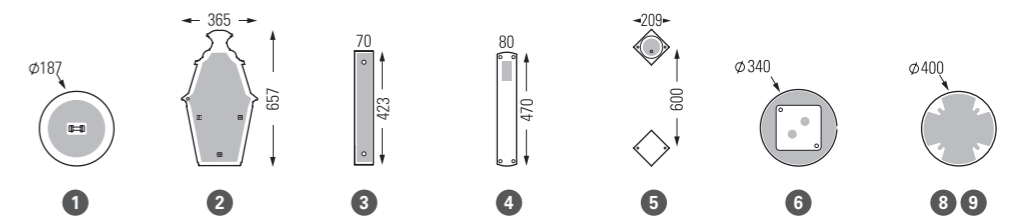

## Louis Philippe 1

---





# Louis Philippe 1

IP44  
Class 1

Aluminium or tinted lacquered brass or raw zinc  
Clear glass diffuser

## SOURCE

E27 - 75W max    Ø60 mm - H 200 mm max

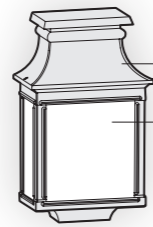

Assembly of spot-welded sheet metal

3-sided light

H 366 mm  
W 222 mm  
D 132 mm

## REFERENCE

Replace ●●● with the colour code or material code

MODEL	E27	SPARE DIFFUSER
1	134 001 ●●●	165 040 609

## COLOURS CODES

Replace ●●● with the colour code



RAL 9005 JET BLACK 000  
SLATE GREY 059  
WHITE 001

Other colours on request



SANDSTONE 054  
OLD RUSTIC 046  
GREEN PATINA 008  
GOLD PATINA 009

## MATERIAL CODES



TINTED LACQUERED BRASS 070  
RAW ZINC 092

## MOUNTING

Wiring entry point in grey - Fixing kit included

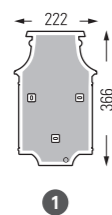

366 / 222 / 132



## Louis Philippe 2

---



# Louis Philippe 2

IP44  
Class 1

Aluminium or tinted lacquered brass or raw zinc  
Clear glass diffuser

## SOURCES

E27 - 2x105W max Ø40 mm - H145 mm max  
G9 - 2x75W max

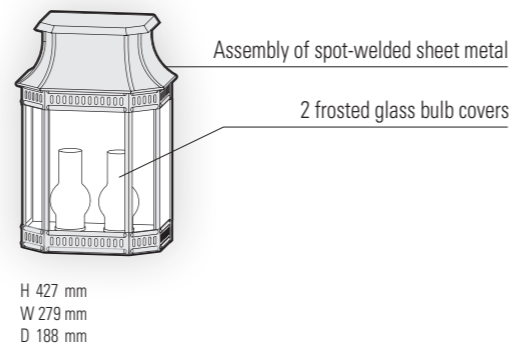

## REFERENCES

Replace ●●● with the colour code or material code

MODEL	E27	G9	SPARE SET OF CLEAR GLASS	SPARE FROSTED GLASS BULB COVER
1	135 001 ●●●	135 002 ●●●	165 041 609	165 076 610

## COLOURS CODES

Replace ●●● with the colour code

	RAL 9005 JET BLACK	000		SANDSTONE	054
	SLATE GREY	059		OLD RUSTIC	046
	WHITE	001		GREEN PATINA	008
Other colours on request				GOLD PATINA	009

## MATERIAL CODES

	TINTED LACQUERED BRASS	070
	RAW ZINC	092

## MOUNTING

Wiring entry point in grey - Fixing kit included

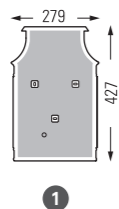

427 / 279 / 188

1



## Louis Philippe 7

---



# Louis Philippe 7

IP44  
Class 2

Aluminium  
Clear glass diffuser

## SOURCES

E27 - 23W max Ø40 mm - H145 mm max  
G9 - 40W max

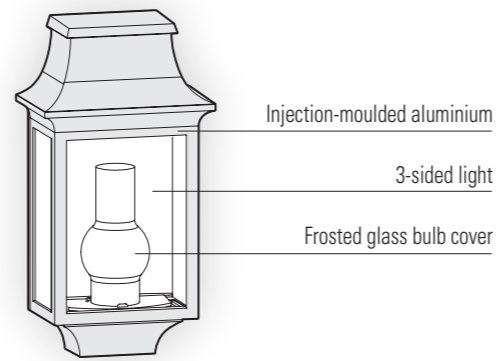

H 373 mm  
W 197 mm  
D 125 mm



## REFERENCES

Replace ●●● with the colour code

MODEL	E27	G9	SPARE SET OF CLEAR GLASS	SPARE FROSTED GLASS BULB COVER
1	136 001 ●●●	136 002 ●●●	165 042 609	165 076 610

## COLOURS CODES

Replace ●●● with the colour code

 RAL 9005 JET BLACK 000  
 SLATE GREY 059  
 WHITE 001  
 Other colours on request

 SANDSTONE 054  
 OLD RUSTIC 046  
 GREEN PATINA 008  
 GOLD PATINA 009

## MOUNTING

Wiring entry point in grey - Fixing kit included

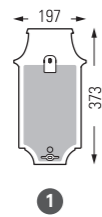

373 / 197 / 125

1



## Vieille France

---



# Vieille France

IP44  
Class 1

Aluminium or tinted lacquered brass  
Raw zinc (model 2)  
Clear glass diffuser

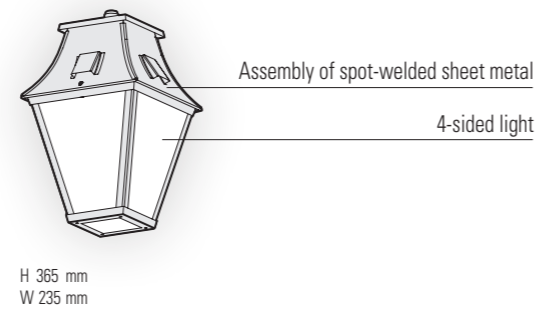

## SOURCES

E27 - 105W max (except model 2) H 200 mm max  
E27 - 75W max (model 2) Ø 66 mm - H 120 mm max

## MODELS

height / width / depth



## REFERENCES

Replace ●●● with the colour code or material code

MODELS	E27	CORNER PLATE p.319	SPARE DIFFUSERS
1	163 001 ●●●	147 001 ●●●	165 068 609
2	163 002 ●●●		165 067 609
3	163 003 ●●●		165 068 609
4	163 004 ●●●	147 001 ●●●	165 068 609
5	163 005 ●●●		165 068 609

## COLOURS CODES

Replace ●●● with the colour code

	RAL 9005 JET BLACK	000
	SANDSTONE	054
	OLD RUSTIC	046
	GREEN PATINA	008

Other colours on request

## MOUNTING

Wiring entry points in grey - Fixing kit included

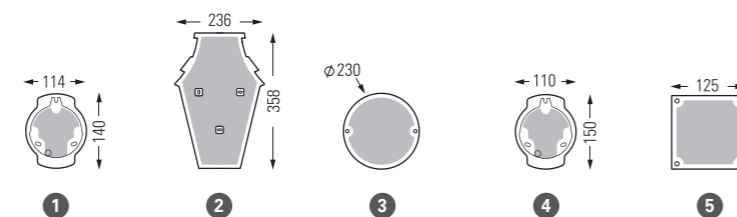

## MATERIAL CODES

	TINTED LACQUERED BRASS	070	(Black aluminium base)
	RAW ZINC	092	(model 2)



# Victoria

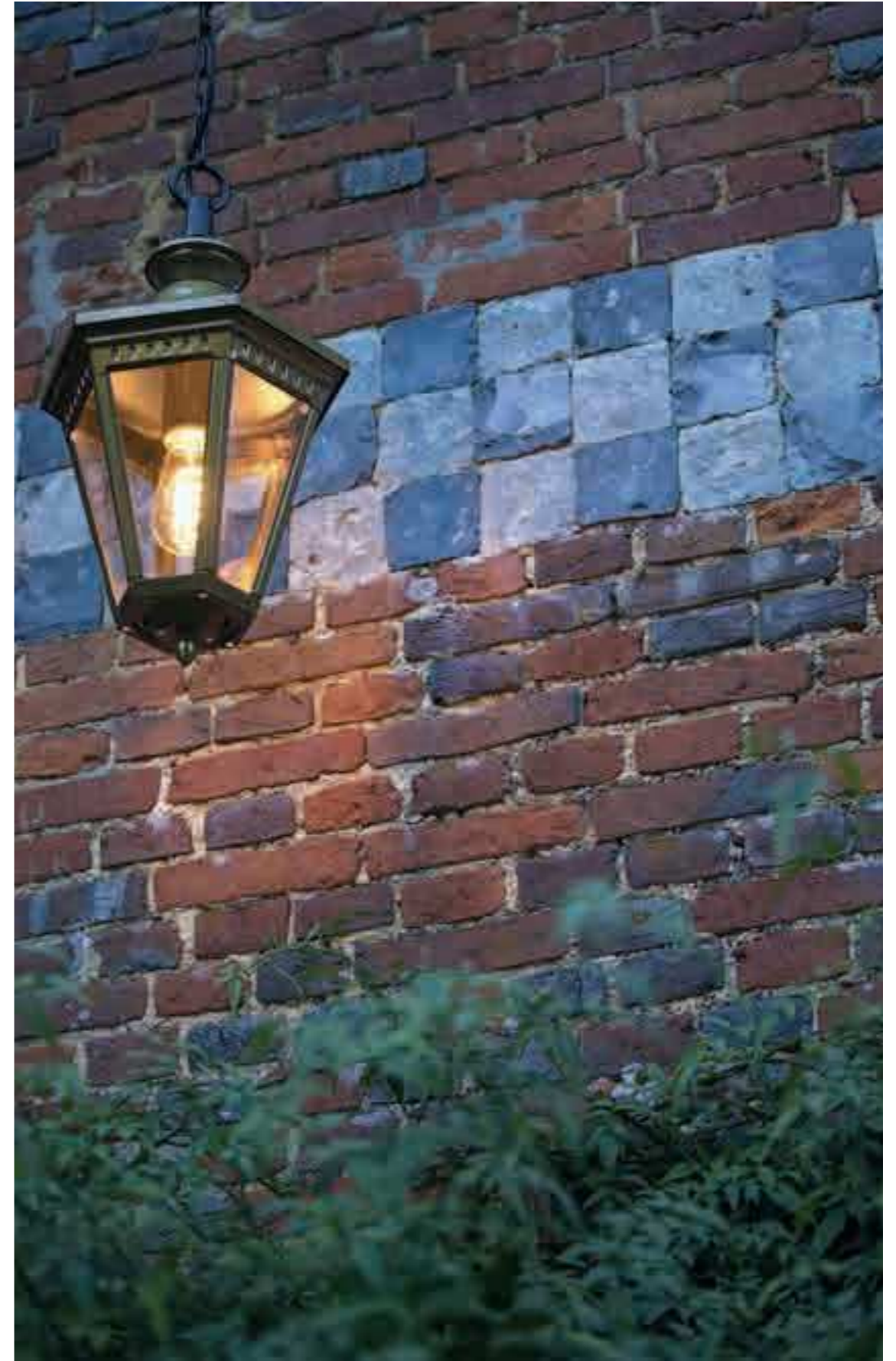





# Victoria

IP44  
Class 1

Aluminium or tinted lacquered brass  
Clear polycarbonate diffuser  
Opal polycarbonate diffuser on request

## SOURCES

E27 - 105W max (except model 1) H200 mm max  
E27 - 75W max (model 1) Ø63 mm - H120 mm max

## MODELS

height / width / depth

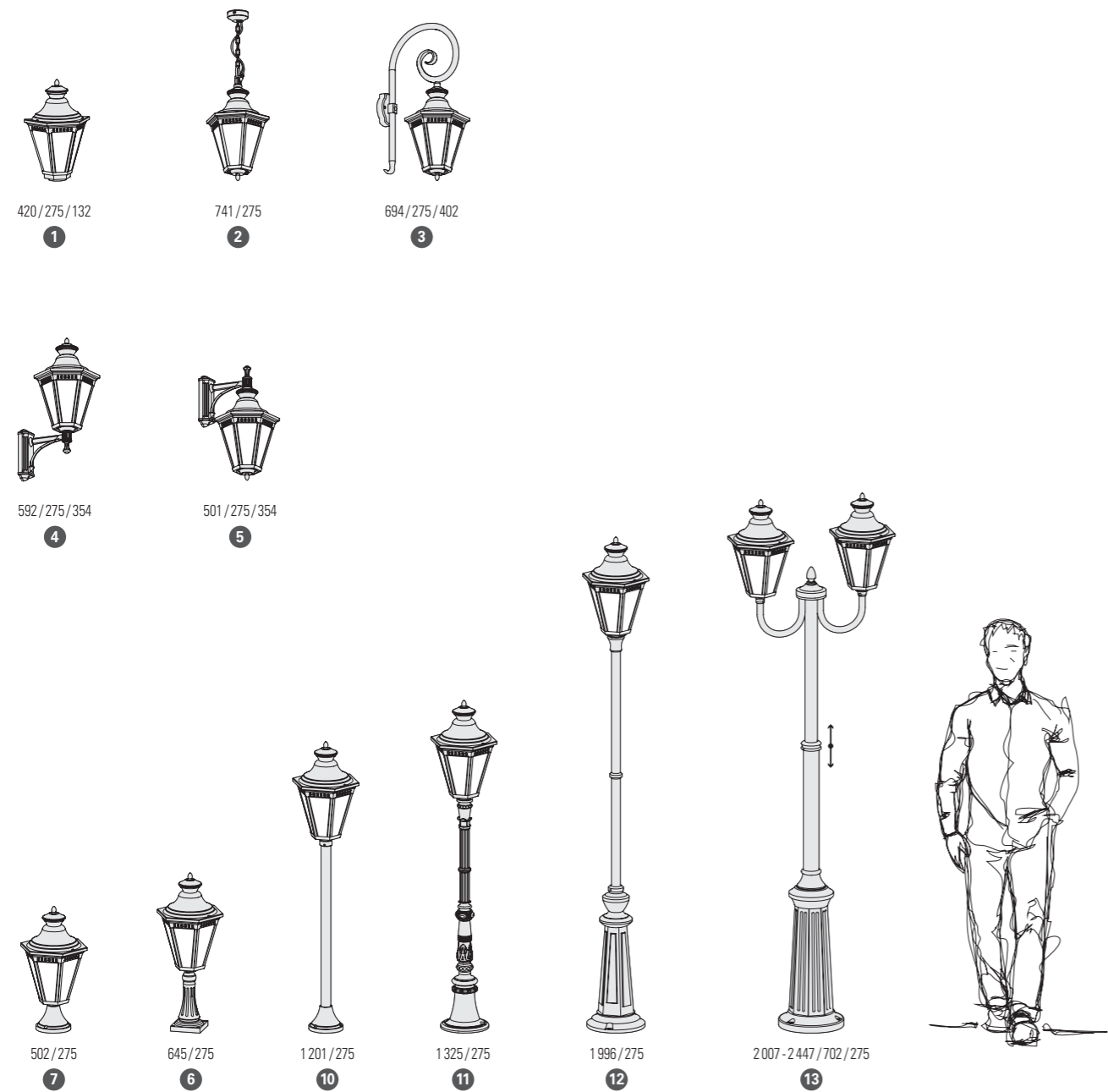

# Victoria

## REFERENCES

Replace ... with the colour code or material code

MODELS	E27	CORNER PLATES p.319	SPARE DIFFUSERS
1	164 001 ...		165 069 601
2	164 002 ...		165 070 601
3	164 003 ...	147 001 ...	165 070 601
4	164 004 ...	147 004 ...	165 070 601
5	164 005 ...	147 004 ...	165 070 601
6	164 006 ...		165 070 601
7	164 007 ...		165 070 601
10	164 008 ...		165 070 601
11	164 009 ...		165 070 601
12	164 010 ...		165 070 601
13	164 011 ...		165 070 601

## COLOURS CODES

Replace ... with the colour code

	RAL 9005 JET BLACK	000
	WHITE	001
	OLD RUSTIC	046
	GREEN PATINA	008
	GOLD PATINA	009

Other colours on request

## MATERIAL CODE

TINTED LACQUERED BRASS 070 (Black aluminium base)

## MOUNTING

Wiring entry points in grey - Fixing kit included

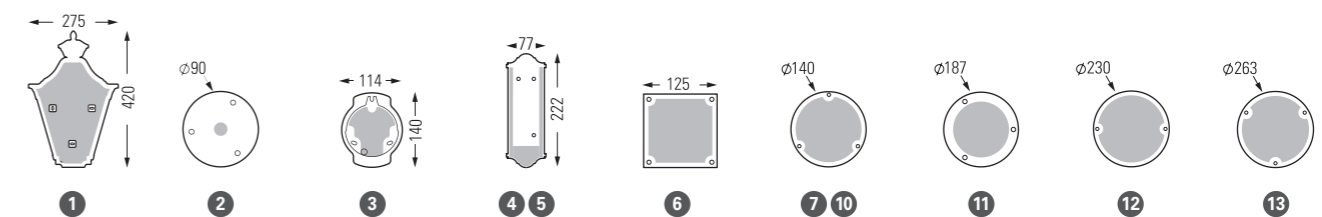

## Louis XIII





# Louis XIII

IP44  
Class 1

Aluminium or tinted lacquered brass  
Clear glass diffuser  
Opal PMMA diffuser on request

## SOURCES

LED 13W - 3000K warm white  
E27 - 105W max H 220 mm max (except model 2)  
Ø66 mm - H 200 mm max (model 2)

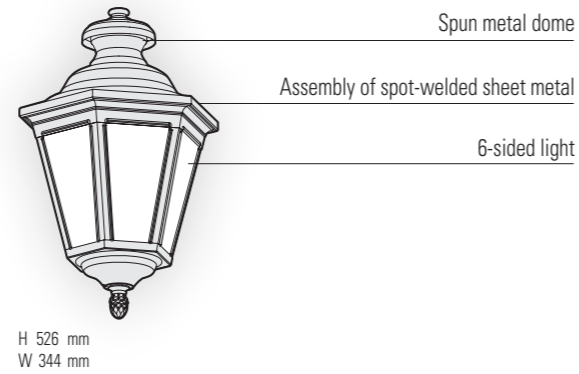

Models 1 to 9 except 2  
LED 13W - IP65  
Real light output - 361 lm  
CRI > 80



Model 2  
LED 13W - IP65  
Real light output - 473 lm  
CRI > 80

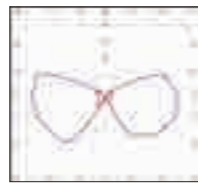

Models 1 to 3  
E27 (2450 lm)  
Real light output - 1220 lm



Models 4 to 9  
E27 (2450 lm)  
Real light output - 987 lm



Model 2  
E27 (1520 lm)  
Real light output - 729 lm

## MODELS

height / width / depth

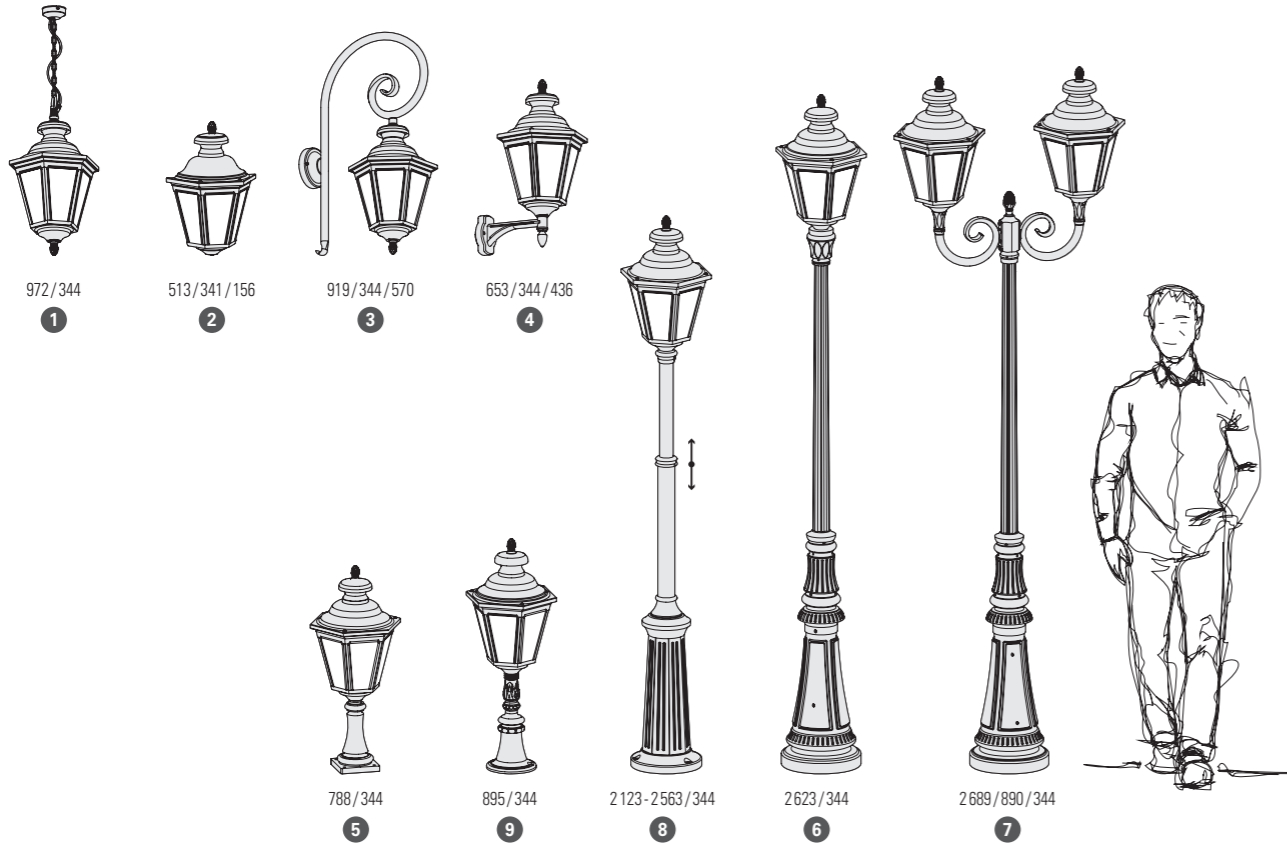

# Louis XIII

## REFERENCES

Replace ●●● with the colour code or material code

MODELS	E27	LED 13W 3000K warm white	CORNER PLATES p.319	SPARE DIFFUSERS
1	130 001 ●●●	130 002 ●●●		165 034 609
2	130 003 ●●●	130 004 ●●●		165 033 609
3	130 005 ●●●	130 006 ●●●	147 003 ●●●	165 034 609
4	130 007 ●●●	130 008 ●●●	147 001 ●●●	165 034 609
5	130 009 ●●●	130 010 ●●●		165 034 609
6	130 011 ●●●	130 012 ●●●		165 034 609
7	130 013 ●●●	130 014 ●●●		165 034 609
8	130 015 ●●●	130 016 ●●●		165 034 609
9	130 017 ●●●	130 018 ●●●		165 034 609

## COLOURS CODES

Replace ●●● with the colour code



Other colours on request

## MATERIAL CODE

TINTED LACQUERED BRASS 070 (Black aluminium base)

## MOUNTING

Wiring entry points in grey - Fixing kit included - Anchor bolts on request (MODELS 6, 7) p. 318

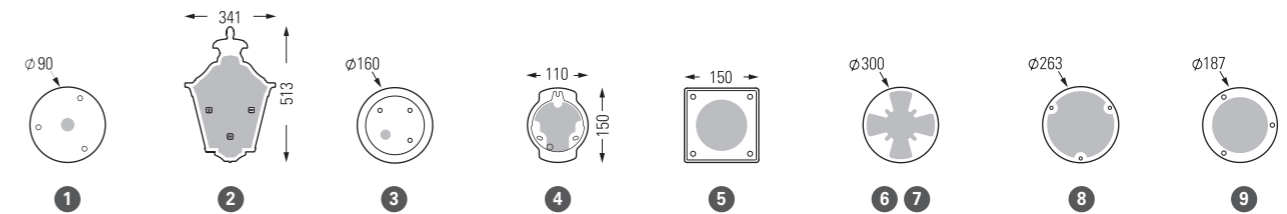

# Citadelle



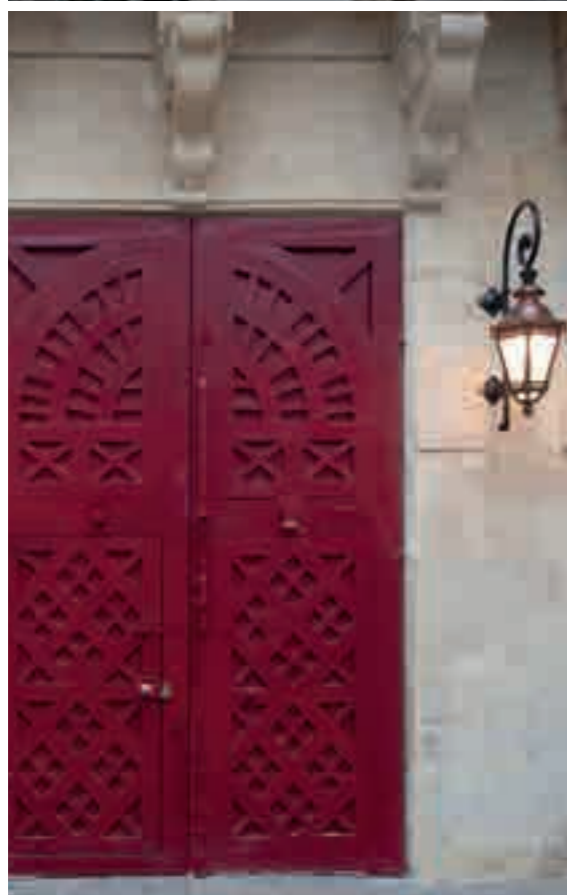

# Citadelle

IP66 (lantern)  
Class 1

Aluminium or patinated copper (unvarnished)  
Opal PMMA diffuser

## SOURCES

LED 35W - 3000K warm white  
LED 35W - 4000K neutral white  
LED 70W - 3000K warm white  
LED 70W - 4000K neutral white  
E27 - 105W max H280 mm max

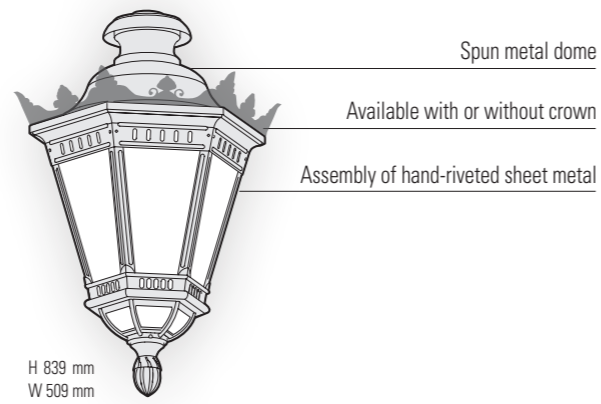

LED 35W  
Real light output - 2027 lm  
CRI > 80



LED 70W  
Real light output - 4482 lm  
CRI > 80

## MODELS

height / width / depth



1 468 / 509

1



1 294 / 509 / 805

2



1 397 / 509 / 914

3



1 083 / 509

4

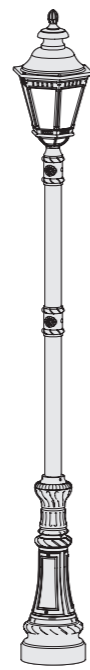

4 178 / 509

5

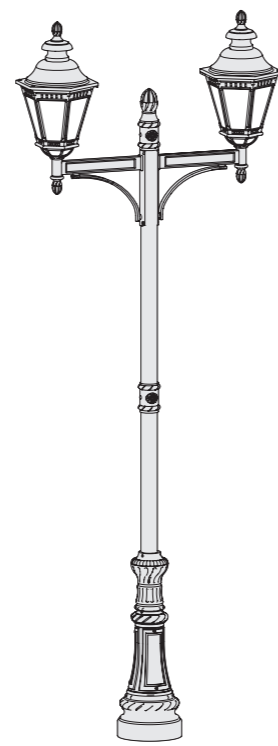

4 411 / 1 703 / 509

7



# Citadelle

## REFERENCES

Replace ●●● with the colour code or material code

Without crown

MODELS	E27	LED 35W 3000K warm white	LED 35W 4000K neutral white	LED 70W 3000K warm white	LED 70W 4000K neutral white	SPARE DIFFUSER (PMMA bowl)
1	116 001 ●●●	116 003 ●●●	116 005 ●●●	116 007 ●●●	116 009 ●●●	165 020 606
2	116 011 ●●●	116 013 ●●●	116 015 ●●●	116 017 ●●●	116 019 ●●●	165 021 606
3	116 021 ●●●	116 023 ●●●	116 025 ●●●	116 027 ●●●	116 029 ●●●	165 020 606
4	116 051 ●●●	116 053 ●●●	116 055 ●●●	116 057 ●●●	116 059 ●●●	165 021 606
5	116 031 ●●●	116 033 ●●●	116 035 ●●●	116 037 ●●●	116 039 ●●●	165 021 606
7	116 041 ●●●	116 043 ●●●	116 045 ●●●	116 047 ●●●	116 049 ●●●	165 021 606



With crown



MODELS	E27	LED 35W 3000K warm white	LED 35W 4000K neutral white	LED 70W 3000K warm white	LED 70W 4000K neutral white	SPARE DIFFUSER (PMMA bowl)
1	116 002 ●●●	116 004 ●●●	116 006 ●●●	116 008 ●●●	116 010 ●●●	165 020 606
2	116 012 ●●●	116 014 ●●●	116 016 ●●●	116 018 ●●●	116 020 ●●●	165 021 606
3	116 022 ●●●	116 024 ●●●	116 026 ●●●	116 028 ●●●	116 030 ●●●	165 020 606
4	116 052 ●●●	116 054 ●●●	116 056 ●●●	116 058 ●●●	116 060 ●●●	165 021 606
5	116 032 ●●●	116 034 ●●●	116 036 ●●●	116 038 ●●●	116 040 ●●●	165 021 606
7	116 042 ●●●	116 044 ●●●	116 046 ●●●	116 048 ●●●	116 050 ●●●	165 021 606

## COLOURS CODES

Replace ●●● with the colour code

 RAL 9005 JET BLACK 000  
 GREEN PATINA 008  
 GOLD PATINA 009  
 Other colours on request

## MATERIAL CODE

 PATINATED COPPER 083 (Black aluminium base)  
 unvarnished

## MOUNTING

Wiring entry points in grey - Fixing kit not included - Anchor bolts on request (models 4, 5, 7) p. 318

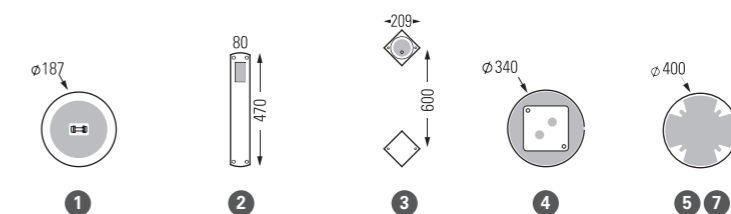



Louvre





# Louvre

IP44  
IP65 (lantern - on request except model 4)  
Class 1

Aluminium or patinated lacquered copper  
Clear glass diffuser  
Opal glass diffuser on request

## SOURCES

LED 13W - 3000K warm white  
E27 - 105W max H 200 mm max (except model 4)  
Ø 60 mm - H 200 mm max (model 4)

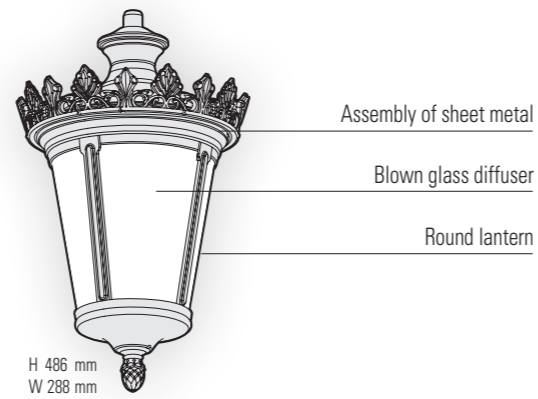

Models 1 to 11 except 4

LED 13W  
Real light output - 433 lm  
CRI > 80



Model 4

LED 13W  
Real light output - 447 lm  
CRI > 80



Models 1, 2, 6

E27 (2450 lm)  
Real light output - 1491 lm



Models 3, 5 and 7 to 11

E27 (2450 lm)  
Real light output - 1659 lm

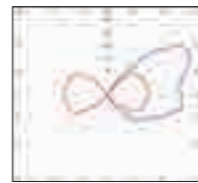

Model 4

E27 (1520 lm)  
Real light output - 879 lm

## MODELS

height / width / depth

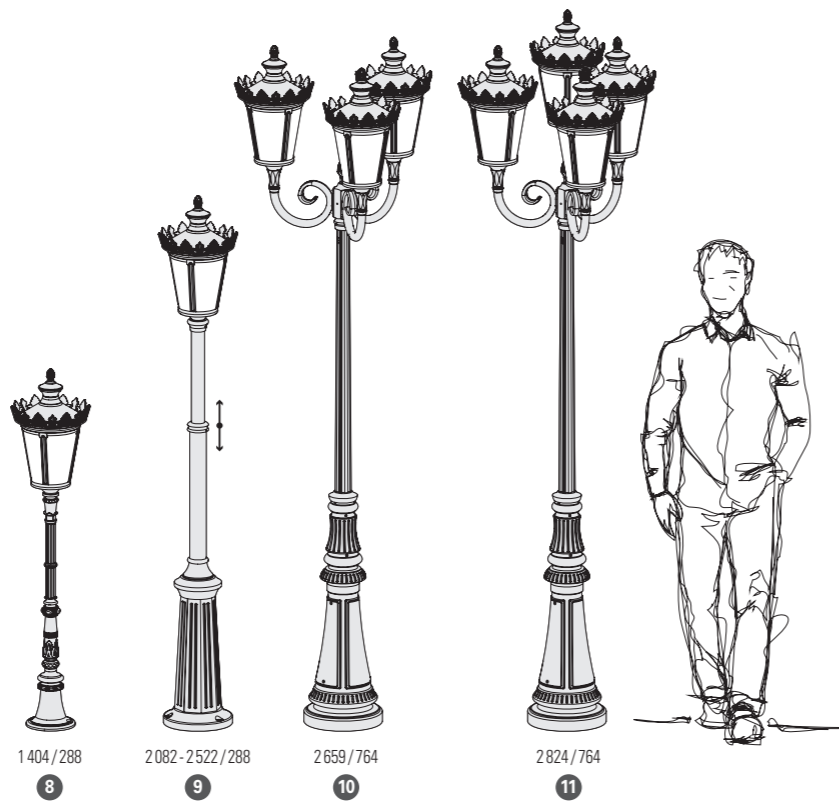
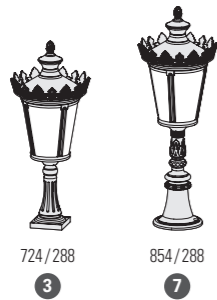
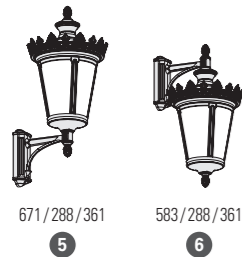
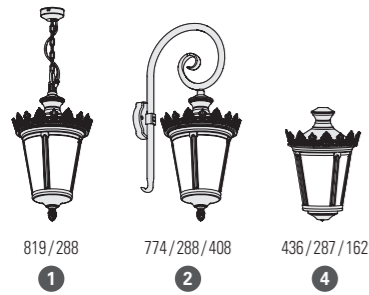

## REFERENCES

Replace ... with the colour code or material code

MODELS	E27	LED 13W 3000K warm white	CORNER PLATES p.319	SPARE DIFFUSERS
1	133 001 ...	133 002 ...		165 038 609
2	133 003 ...	133 004 ...	147 001 ...	165 038 609
3	133 005 ...	133 006 ...		E27 165 038 609 LED 165 039 609
4	133 007 ...	133 008 ...		165 037 609
5	133 009 ...	133 010 ...	147 004 ...	E27 165 038 609 LED 165 039 609
6	133 011 ...	133 012 ...	147 004 ...	165 038 609
7	133 013 ...	133 014 ...		E27 165 038 609 LED 165 039 609
8	133 015 ...	133 016 ...		E27 165 038 609 LED 165 039 609
9	133 017 ...	133 018 ...		E27 165 038 609 LED 165 039 609
10	133 019 ...	133 020 ...		E27 165 038 609 LED 165 039 609
11	133 021 ...	133 022 ...		E27 165 038 609 LED 165 039 609

## COLOURS CODES

Replace ... with the colour code

-  RAL 9005 JET BLACK 000
-  RAL 6009 BRITISH GREEN 019
-  RAL 6009 FIR GREEN 067
-  GREEN PATINA 008
-  GOLD PATINA 009

Other colours on request

## MATERIAL CODE

-  COPPER 080 (Black aluminium base)  
patinated lacquered

## MOUNTING

Wiring entry points in grey - Fixing kit included - Anchor bolts on request (models 10, 11) p. 318

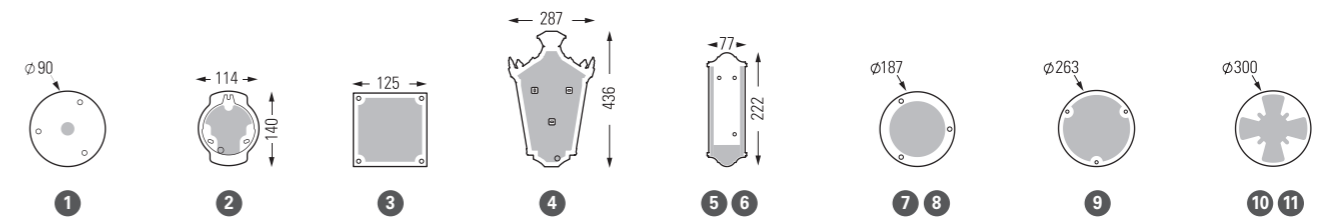

## Place des Vosges 1 Évolution

---





# Place des Vosges 1 Évolution

IP65 (lantern)  
Class 1

Aluminium  
Clear or opal PMMA diffuser

## SOURCES

E27 - 60W max (except model 2)      H 160 mm max  
E27 - 23W max (model 2)            Ø 66 mm - H 150 mm max  
GU10 PAR16 LED - 9W max (model 2)    H 60 mm max



Models 1 to 13 except 2  
E27 (2450 lm)  
Real light output - 1348 lm

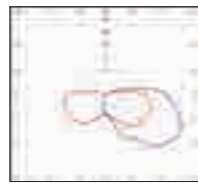

Model 2  
E27 (1520 lm)  
Real light output - 874 lm

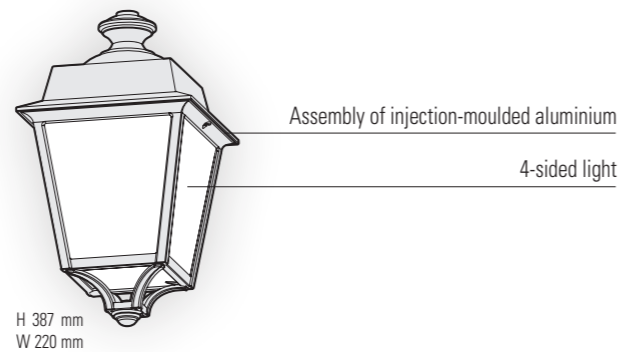

## MODELS

height / width / depth

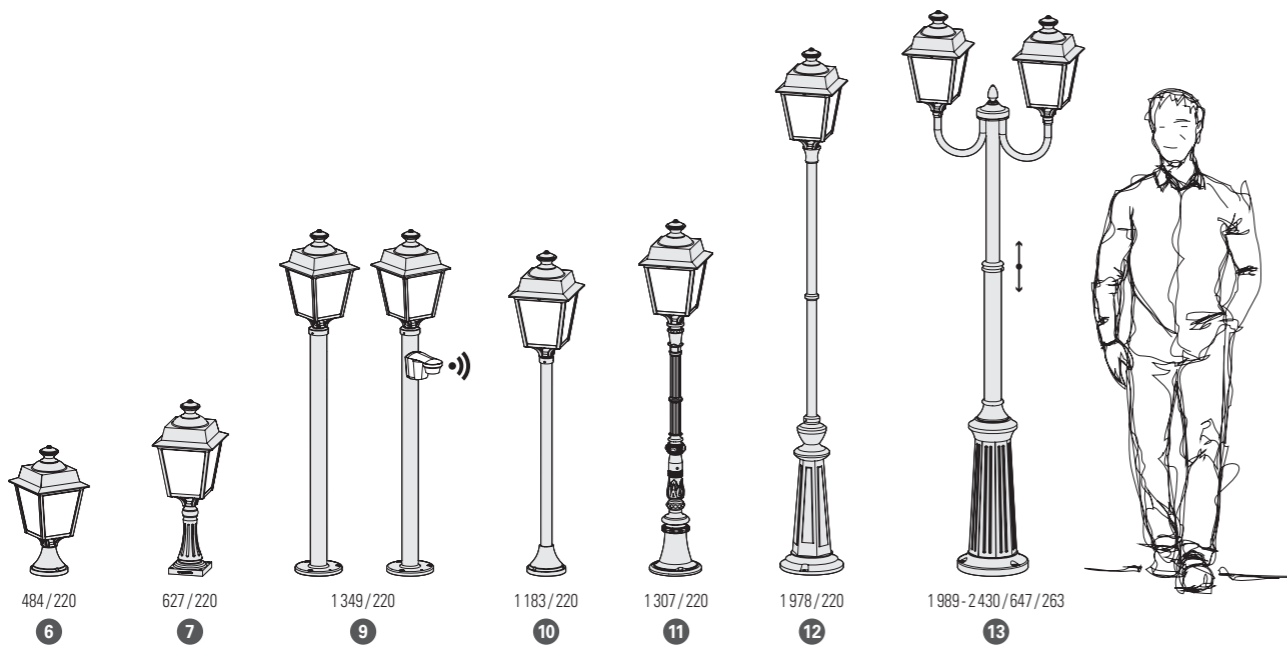

# Place des Vosges 1 Évolution

## REFERENCES

Replace ... with the colour code

MODELS	DIFFUSERS	E27	GU10 PAR16 LED	E27 + SENSOR	CORNER PLATES p.319	SPARE DIFFUSERS (PMMA bowl)
1	CLEAR PMMA	150 001 ...				165 056 605
	OPAL PMMA	150 002 ...				165 056 606
2	CLEAR PMMA	150 003 ...	150 005 ...	150 004 ...		165 055 605 165 074 605
	OPAL PMMA	150 006 ...	150 008 ...	150 007 ...		165 055 606 165 074 606
3	CLEAR PMMA	150 009 ...			147 004 ...	165 056 605
	OPAL PMMA	150 010 ...				165 056 606
4	CLEAR PMMA	150 011 ...		150 012 ...	147 004 ...	165 056 605
	OPAL PMMA	150 013 ...		150 014 ...		165 056 606
5	CLEAR PMMA	150 015 ...		150 016 ...	147 001 ...	165 056 605
	OPAL PMMA	150 017 ...		150 018 ...		165 056 606
6	CLEAR PMMA	150 019 ...				165 056 605
	OPAL PMMA	150 020 ...				165 056 606
7	CLEAR PMMA	150 021 ...				165 056 605
	OPAL PMMA	150 022 ...				165 056 606
9	CLEAR PMMA	150 023 ...		150 024 ...		165 056 605
	OPAL PMMA	150 025 ...		150 026 ...		165 056 606
10	CLEAR PMMA	150 027 ...				165 056 605
	OPAL PMMA	150 028 ...				165 056 606
11	CLEAR PMMA	150 029 ...				165 056 605
	OPAL PMMA	150 030 ...				165 056 606
12	CLEAR PMMA	150 031 ...				165 056 605
	OPAL PMMA	150 032 ...				165 056 606
13	CLEAR PMMA	150 033 ...				165 056 605
	OPAL PMMA	150 034 ...				165 056 606

## COLOURS CODES

Replace ... with the colour code

	RAL 9005 JET BLACK	000
	SLATE GREY	059
	WHITE	001
	SANDSTONE	054
	OLD RUSTIC	046
	GOLD PATINA	009
	RAL 6009 BRITISH GREEN	019
	RAL 6009 FIR GREEN	067
	GREEN PATINA	008

Other colours on request

## MOUNTING

Wiring entry points in grey - Fixing kit included

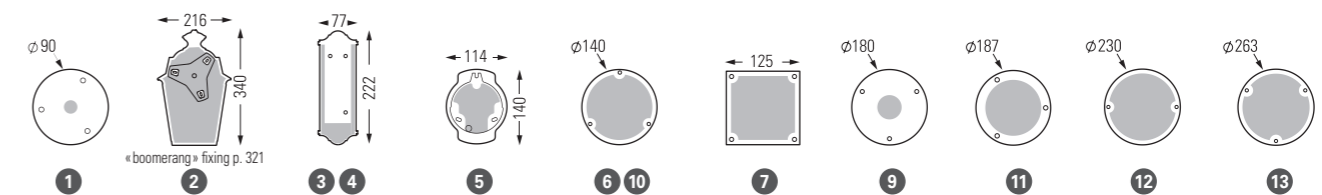

Place des Vosges 1  
Tradition

---







# Place des Vosges 1 Tradition

IP44  
Class 1

Aluminium or tinted lacquered brass  
Clear or frosted glass diffuser

## SOURCE

E27 - 105W max H 160 mm max (except model 2)  
Ø 63 mm - H 160 mm max (model 2)

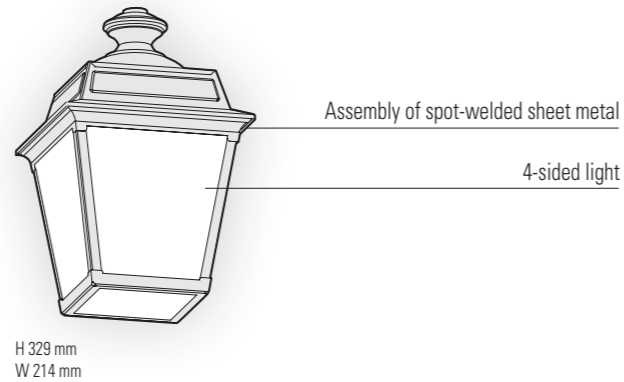

Models **1, 4, 5**  
E27 (2450 lm)  
Real light output - 1455 lm



Models **3 and 6 to 13**  
E27 (2450 lm)  
Real light output - 1098 lm



Model **2**  
E27 (1520 lm)  
Real light output - 921 lm

## MODELS

height / width / depth



664 / 214  
**1**



360 / 214 / 125  
**2**



562 / 214 / 324  
**3**



425 / 214 / 323  
**4**



685 / 214 / 371  
**5**



473 / 214  
**6**



616 / 214  
**7**

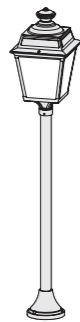

1172 / 214  
**10**



1296 / 214  
**11**

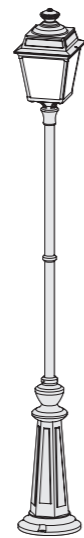

1967 / 230  
**12**

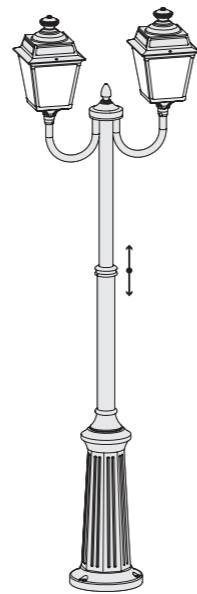

1977 - 2418 / 640 / 263  
**13**



## REFERENCES

Replace **•••** with the colour code or material code

MODELS	DIFFUSERS	E27	CORNER PLATES p.319	SPARE DIFFUSERS
<b>1</b>	CLEAR GLASS	151 001 •••		165 058 609
	FROSTED GLASS	151 002 •••		165 058 610
<b>2</b>	CLEAR GLASS	151 003 •••		165 057 609
	FROSTED GLASS	151 004 •••		165 057 610
<b>3</b>	CLEAR GLASS	151 005 •••	147 004 •••	165 058 609
	FROSTED GLASS	151 006 •••		165 058 610
<b>4</b>	CLEAR GLASS	151 007 •••	147 004 •••	165 058 609
	FROSTED GLASS	151 008 •••		165 058 610
<b>5</b>	CLEAR GLASS	151 009 •••	147 001 •••	165 058 609
	FROSTED GLASS	151 010 •••		165 058 610
<b>6</b>	CLEAR GLASS	151 011 •••		165 058 609
	FROSTED GLASS	151 012 •••		165 058 610
<b>7</b>	CLEAR GLASS	151 013 •••		165 058 609
	FROSTED GLASS	151 014 •••		165 058 610
<b>10</b>	CLEAR GLASS	151 015 •••		165 058 609
	FROSTED GLASS	151 016 •••		165 058 610
<b>11</b>	CLEAR GLASS	151 017 •••		165 058 609
	FROSTED GLASS	151 018 •••		165 058 610
<b>12</b>	CLEAR GLASS	151 019 •••		165 058 609
	FROSTED GLASS	151 020 •••		165 058 610
<b>13</b>	CLEAR GLASS	151 021 •••		165 058 609
	FROSTED GLASS	151 022 •••		165 058 610

## COLOURS CODES

Replace **•••** with the colour code

	RAL 9005 JET BLACK	<b>000</b>
	SLATE GREY	<b>059</b>
	WHITE	<b>001</b>
	SANDSTONE	<b>054</b>
	OLD RUSTIC	<b>046</b>
	GOLD PATINA	<b>009</b>
	RAL 6009 BRITISH GREEN	<b>019</b>
	RAL 6009 FIR GREEN	<b>067</b>
	GREEN PATINA	<b>008</b>

Other colours on request

## MATERIAL CODE

TINTED LACQUERED BRASS **070** (Black aluminium base)

## MOUNTING

Wiring entry points in grey - Fixing kit included

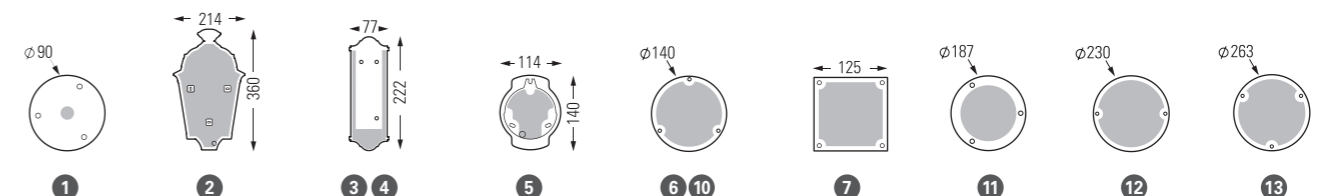

## Place des Vosges 2

---





# Place des Vosges 2

IP44  
Class 1

Aluminium or tinted lacquered brass  
Clear glass diffuser

## SOURCE

E27 - 105W max H 200 mm max (except model 3)  
Ø66 mm - H 200 mm max (model 3)

## MODELS

height / width / depth

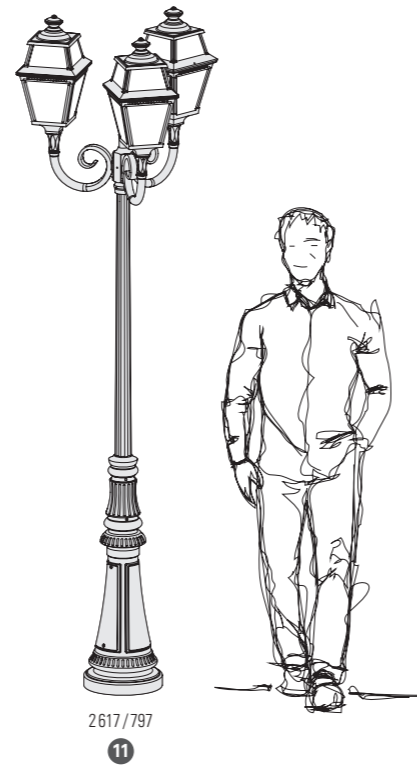
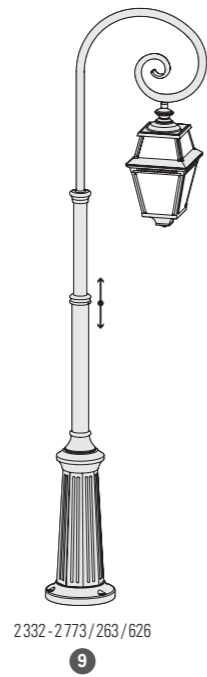
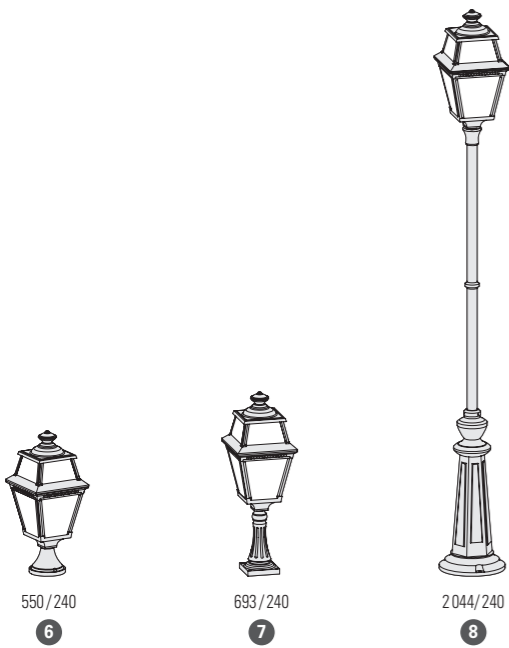
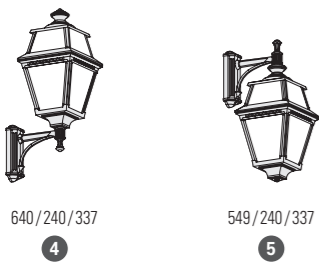
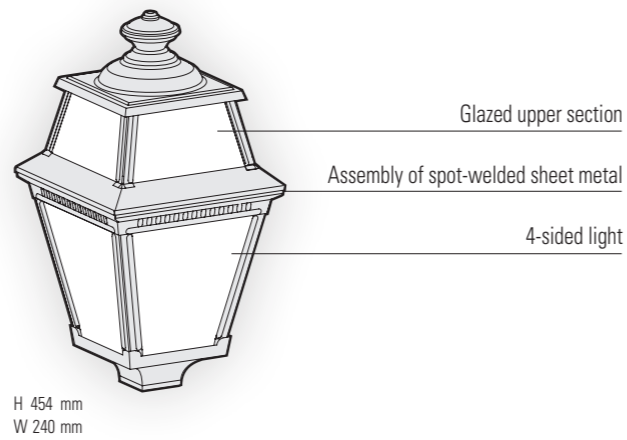

# Place des Vosges 2

## REFERENCES

Replace ... with the colour code or material code

MODELS	E27	CORNER PLATES p.319	SPARE DIFFUSERS
1	148 001 ...		165 052 609
2	148 002 ...	147 001 ...	165 052 609
3	148 003 ...		165 051 609
4	148 004 ...	147 004 ...	165 052 609
5	148 005 ...	147 004 ...	165 052 609
6	148 006 ...		165 052 609
7	148 007 ...		165 052 609
8	148 008 ...		165 052 609
9	148 009 ...		165 052 609
11	148 010 ...		165 052 609

## COLOURS CODES

Replace ... with the colour code

	RAL 9005 JET BLACK	000
	WHITE	001
	OLD RUSTIC	046
	GREEN PATINA	008
	GOLD PATINA	009

Other colours on request

## MATERIAL CODE

TINTED LACQUERED BRASS 070 (Black aluminium base)

## MOUNTING

Wiring entry points in grey - Fixing kit included - Anchor bolts on request (model 11) p. 318

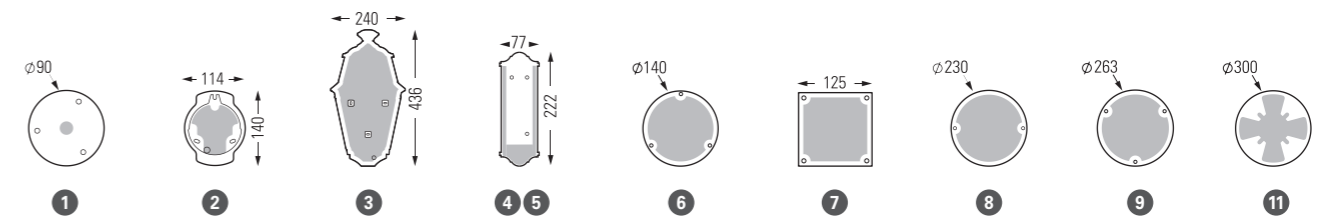

## Place des Vosges 3

---





# Place des Vosges 3

IP44  
Class 1

Aluminium or tinted lacquered brass  
Clear glass diffuser

## SOURCE

E27 - 105W max H 220 mm max (except model 2)  
Ø66 mm - H 200 mm max (model 2)

## MODELS

height/width/depth

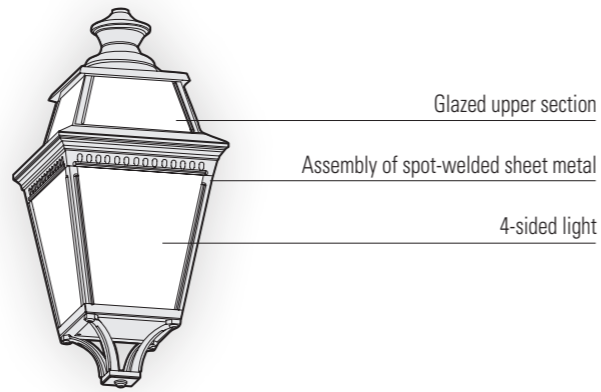

H 621 mm  
W 282 mm



1060/282

1



536/282/152

2



1009/282/563

3



740/282/405

4

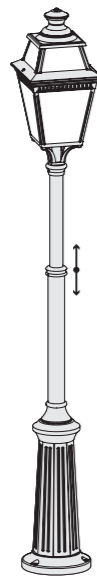

2110-2650/282

6

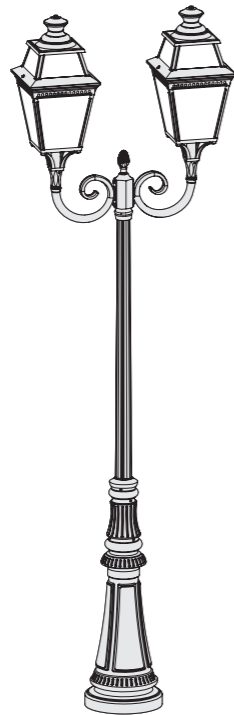

2775/826/300

7

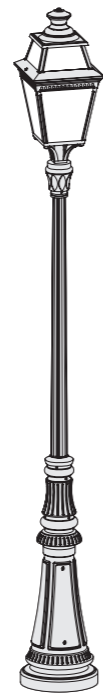

2709/300

8

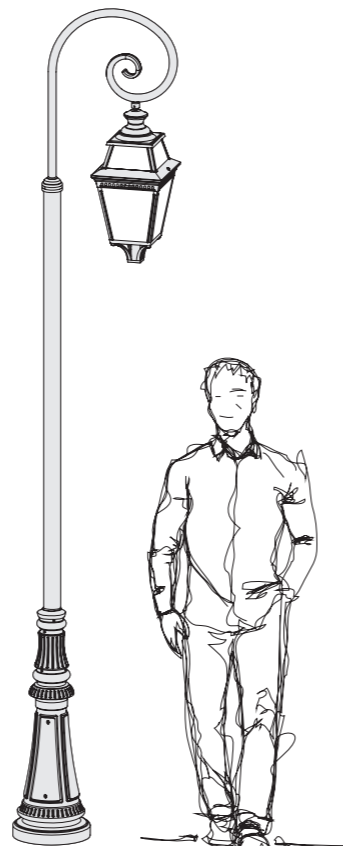

3300/300/645

10



874/282

5



981/282

9

# Place des Vosges 3

## REFERENCES

Replace ... with the colour code or material code

MODELS	E27	CORNER PLATES p.319	SPARE DIFFUSERS
1	149 001 ...		165 054 609
2	149 002 ...		165 053 609
3	149 003 ...	147 003 ...	165 054 609
4	149 004 ...	147 001 ...	165 054 609
5	149 005 ...		165 054 609
6	149 006 ...		165 054 609
7	149 007 ...		165 054 609
8	149 008 ...		165 054 609
9	149 009 ...		165 054 609
10	149 010 ...		165 054 609

## COLOURS CODES

Replace ... with the colour code

	RAL 9005 JET BLACK	000
	WHITE	001
	OLD RUSTIC	046
	GREEN PATINA	008
	GOLD PATINA	009

Other colours on request

## MATERIAL CODE

TINTED LACQUERED BRASS 070 (Black aluminium base)

## MOUNTING

Wiring entry points in grey - Fixing kit included - Anchor bolts on request (models 7, 8, 10) p. 318

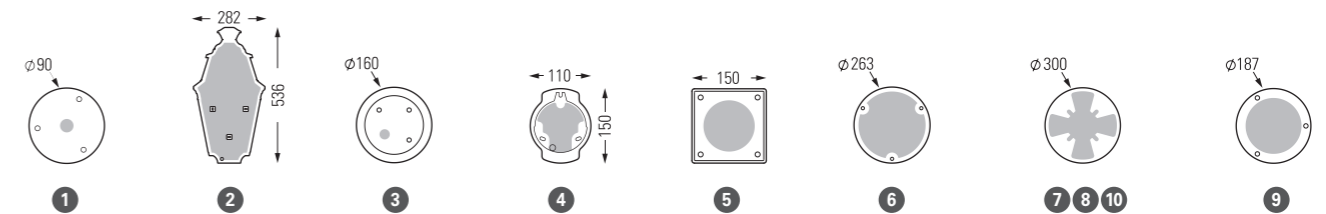

# Phoros





# Phoros

IP44  
IK09  
Class 1

Aluminium  
Clear polycarbonate diffuser

## SOURCE

E27 - 75W max Ø70 mm - H200 mm max

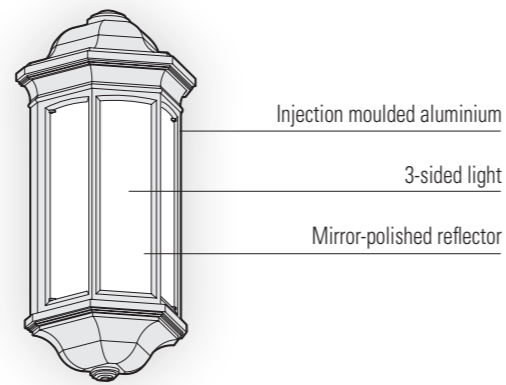

H 398 mm  
W 190 mm  
D 113 mm



## REFERENCE

Replace ●●● with the colour code

MODEL	E27	SPARE DIFFUSER
1	145 001 ●●●	165 049 601

## COLOURS CODES

Replace ●●● with the colour code

	RAL 9005 JET BLACK	000		OLD RUSTIC	046
	WHITE	001		GREEN PATINA	008
	LIMESTONE	053		GOLD PATINA	009

Other colours on request

## MOUNTING

Wiring entry point in grey - Fixing kit included

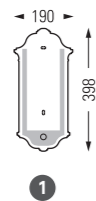

398 / 190 / 113



# Monaco



# Monaco

IP44  
Class 1

Aluminium  
Clear glass diffuser

## SOURCE

E27 - 60W max H 180 mm max

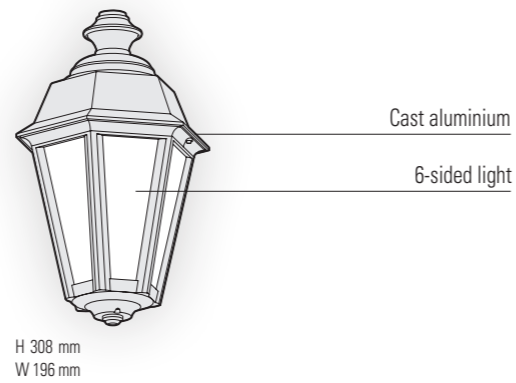

## MODELS

height / width / depth

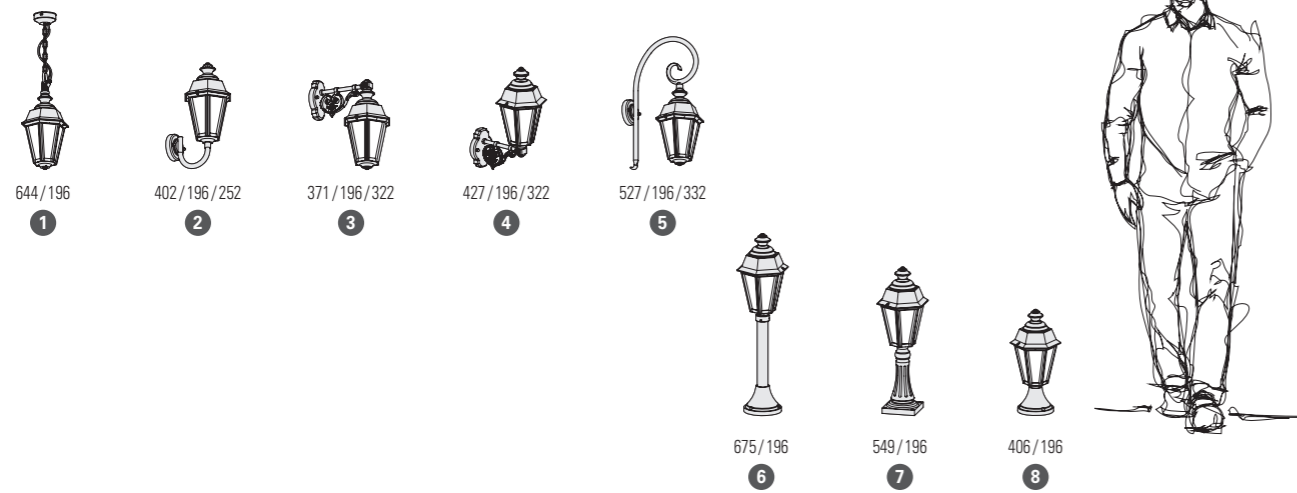

## REFERENCES

Replace ●●● with the colour code

MODELS	E27	CORNER PLATE p.319	SPARE DIFFUSER
1	138 001 ●●●		165 044 609
2	138 002 ●●●	147 002 ●●●	165 044 609
3	138 003 ●●●	147 002 ●●●	165 044 609
4	138 004 ●●●	147 002 ●●●	165 044 609
5	138 005 ●●●	147 002 ●●●	165 044 609
6	138 006 ●●●		165 044 609
7	138 007 ●●●		165 044 609
8	138 008 ●●●		165 044 609

## COLOURS CODES

Replace ●●● with the colour code

	RAL 9005 JET BLACK	000
	WHITE	001
	OLD RUSTIC	046
	GREEN PATINA	008
	GOLD PATINA	009

Other colours on request

## MOUNTING

Wiring entry points in grey - Fixing kit included

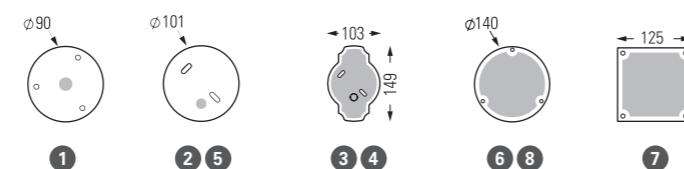

# Corum



# Corum

IP44  
IK10  
Class 1

Aluminium  
Polycarbonate diffuser

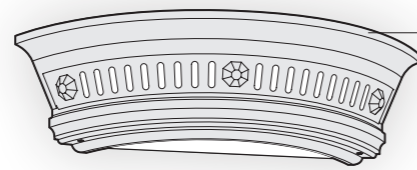

Cast aluminium

Up and Down light

H 115 mm  
W 400 mm  
D 134 mm

## SOURCES

E27 - 75W max Ø60 mm - H150 mm max  
GU5.3 MR16 LED - 2x5W max H48 mm max

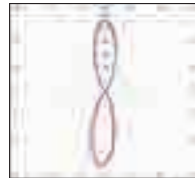

GU5.3 (350 lm)  
Real light output - 2x318 lm



## REFERENCES

Replace ●●● with the colour code

MODEL	E27	GU5.3 MR16 LED
1	118 001 ●●●	118 002 ●●●

## COLOURS CODES

Replace ●●● with the colour code

	RAL 7021 BLACK GREY 107		LIMESTONE 053
	SLATE GREY 059		SANDSTONE 054
	RAL 9010 PURE WHITE 101		OLD RUSTIC 046

Other colours on request

## MOUNTING

Wiring entry point in grey - Fixing kit included

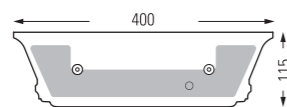

1



115/400/134

1



# Trophy



# Trophy

IP44  
IK10  
Class 1

Aluminium  
Opal polycarbonate diffuser

## SOURCES

E27 - 40W max (models 1, 2)    Ø60 mm - H120 mm max  
E27 - 60W max (model 3)    Ø60 mm - H200 mm max

## MODELS

height / width / depth

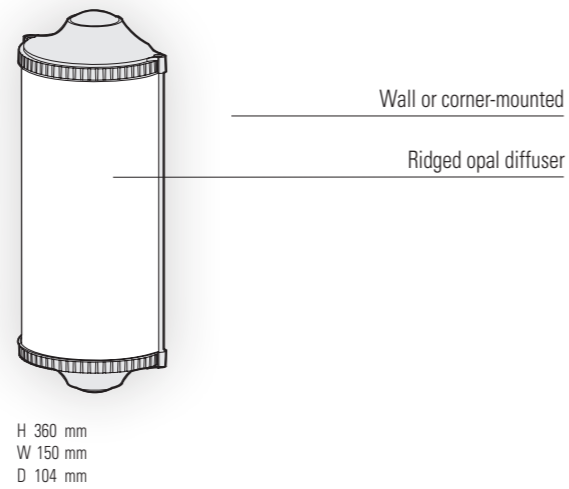
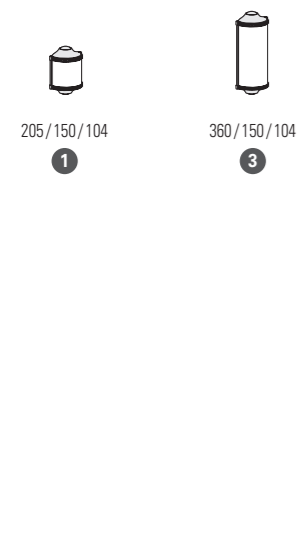

## REFERENCES

Replace ●●● with the colour code

MODELS	E27	SPARE DIFFUSERS
1	161 001 ●●●	165 064 602
2	161 002 ●●●	165 064 602
3	161 003 ●●●	165 065 602

## COLOURS CODES

Replace ●●● with the colour code

	DARK GREY 006		RAL 3005 WINE RED 066
	SLATE GREY 059		OLD RUSTIC 046
	RAL 7044 SILK GREY 105		SANDSTONE 054
	WHITE 001		LIMESTONE 053

Other colours on request

## MOUNTING

Wiring entry points in grey  
Fixing kit included

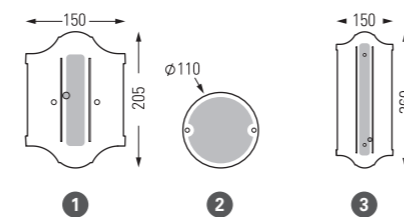

# Belcour

Design by Stéphane Joyeux

---





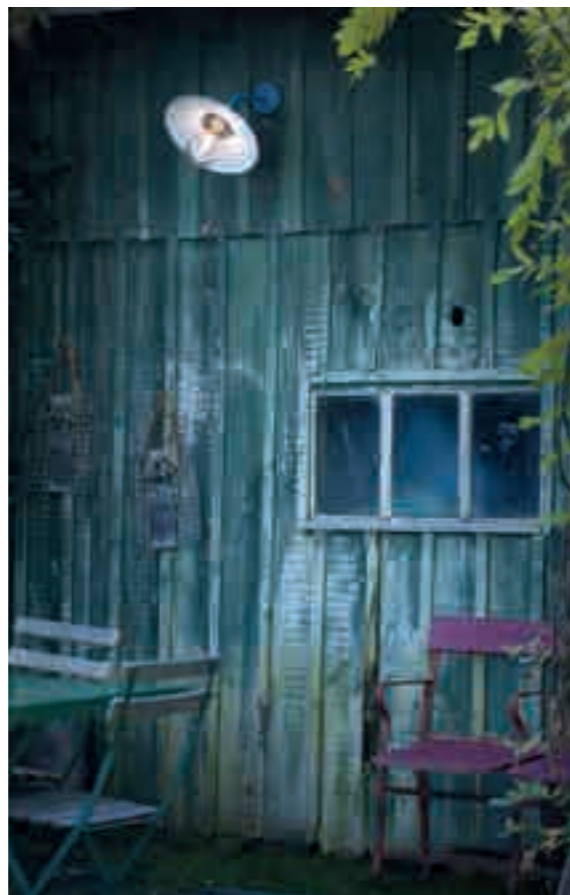

# Belcour

IP44  
Class 1

Aluminium, lacquered brushed copper or brushed raw zinc  
Clear or frosted glass diffuser

## SOURCE

E27 - 60W max Ø66 mm - H160 mm max



E27 (2450 lm)  
Real light output/frosted - 1585 lm  
Real light output/clear - 1583 lm

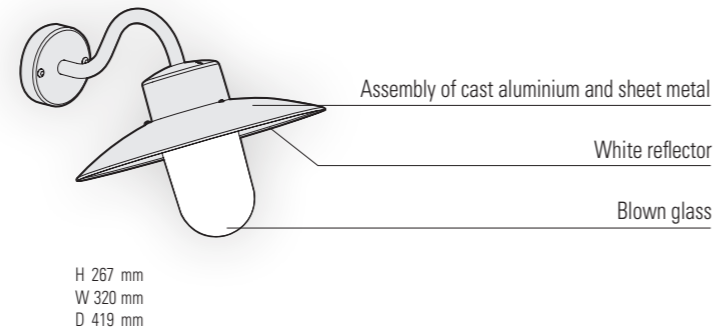

## MODELS

height / width / depth

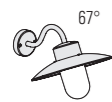

267 / 320 / 419  
1



398 / 320  
2



295 / 320 / 421  
8

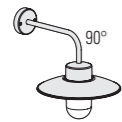

385 / 320 / 466  
9

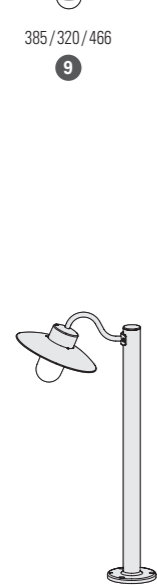

1016 / 320 / 517  
3

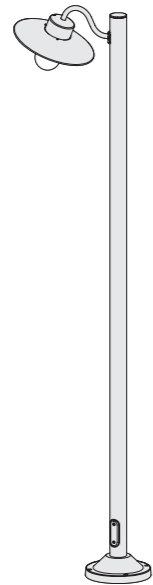

2 196 / 320 / 552  
4

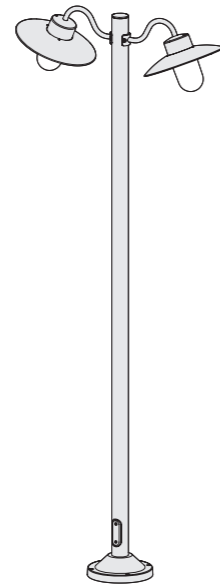

2 196 / 855 / 320  
5

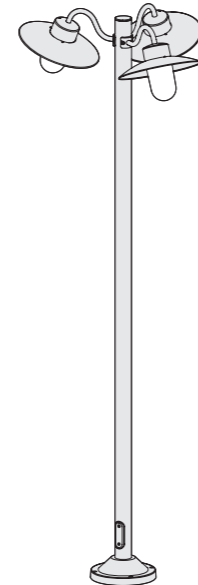

2 196 / 786  
6



## REFERENCES

Replace ●●● with the colour code

MODELS	DIFFUSERS	E27	CORNER PLATE p.319	SPARE DIFFUSERS
1	CLEAR GLASS	106 001 ●●●	147 005 ●●●	165 035 609
	FROSTED GLASS	106 002 ●●●		165 035 610
2	CLEAR GLASS	106 003 ●●●		165 035 609
	FROSTED GLASS	106 004 ●●●		165 035 610
3	CLEAR GLASS	106 005 ●●●		165 035 609
	FROSTED GLASS	106 006 ●●●		165 035 610
4	CLEAR GLASS	106 007 ●●●		165 035 609
	FROSTED GLASS	106 008 ●●●		165 035 610
5	CLEAR GLASS	106 009 ●●●		165 035 609
	FROSTED GLASS	106 010 ●●●		165 035 610
6	CLEAR GLASS	106 011 ●●●		165 035 609
	FROSTED GLASS	106 012 ●●●		165 035 610
8	CLEAR GLASS	106 013 ●●●	147 005 ●●●	165 035 609
	FROSTED GLASS	106 014 ●●●		165 035 610
9	CLEAR GLASS	106 015 ●●●	147 005 ●●●	165 035 609
	FROSTED GLASS	106 016 ●●●		165 035 610

## COLOURS CODES

Replace ●●● with the colour code

	RAL 9005 JET BLACK	000
	SLATE GREY	059
	METAL GREY	023
	RAL 6009 BRITISH GREEN	019
	RAL 6009 FIR GREEN	067
	WHITE	001
	RAL 3020 TRAFFIC RED	056
	RAL 6018 YELLOW GREEN	015
	RAL 5009 AZURE BLUE	058
	SANDSTONE	054
	OLD RUSTIC	046

Other colours on request

## MATERIALS CODES

	LACQUERED BRUSHED COPPER	084	(Velvet black 113 aluminium bracket and pole)
	BRUSHED RAW ZINC	092	(Velvet black 113 aluminium bracket and pole)

## MOUNTING

Wiring entry points in grey - Fixing kit included

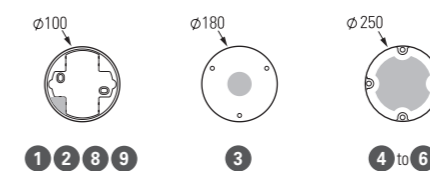

# Bristol



# Bristol

IP44  
IK08  
Class 1

Aluminium  
Clear PMMA diffuser

## SOURCE

E27 - 75W max Ø80 mm - H220 mm max



E27 (2450 lm)  
Real light output - 1570 lm

## MODELS

height / width / depth

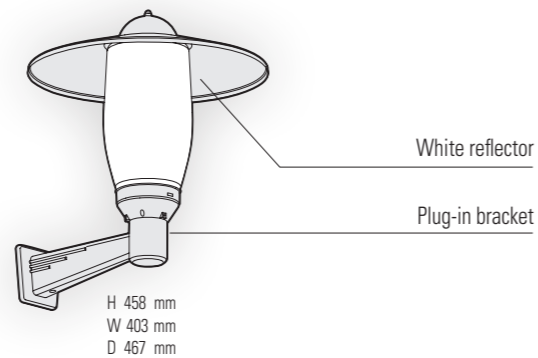
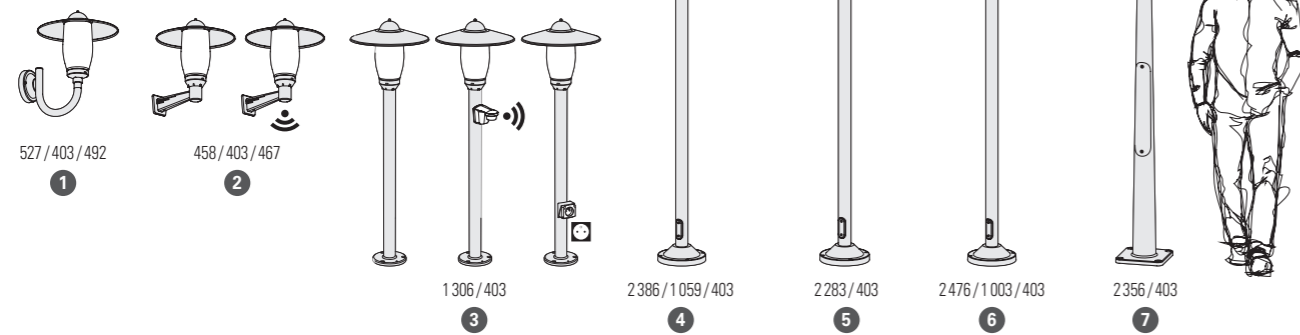

## REFERENCES

Replace ●●● with the colour code / replace (●) with the country's electrical socket code

MODELS	E27	E27 + SENSOR	SOCKET	CORNER PLATES p.319	SPARE DIFFUSER
1	114 001 ●●●			147 003 ●●●	165 018 605
2	114 002 ●●●	114 003 ●●●		147 006 ●●●	165 018 605
3	114 004 ●●●	114 005 ●●●	114 006 ●●●(●)		165 018 605
4	114 007 ●●●				165 018 605
5	114 008 ●●●				165 018 605
6	114 009 ●●●				165 018 605
7	114 010 ●●●				165 018 605

## COLOURS CODES

Replace ●●● with the colour code

■	DARK GREY 006	■	RAL 6009 BRITISH GREEN 019
■	SLATE GREY 059	■	RAL 6009 FIR GREEN 067
■	METAL GREY 023	■	RAL 3005 WINE RED 066
■	WHITE 001	■	SANDSTONE 054

Other colours on request

## MOUNTING

Wiring entry points in grey - Fixing kit included  
Anchor bolts on request (models 7) p. 318

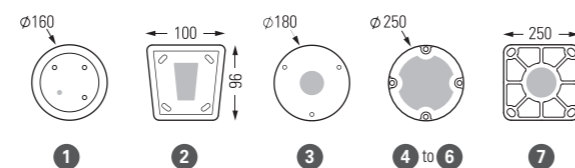

## SOCKETS CODES

Except for French socket, replace (●) with country's socket code

●	SCHUKO SOCKET SK	●	SWISS SOCKET CH
	type F		type J



# Montana



# Montana

IP44  
Class 1

Aluminium  
Clear or frosted glass diffuser

## SOURCE

E27 - 105W max Ø66 mm - H120 mm max

## MODELS

height / width / depth

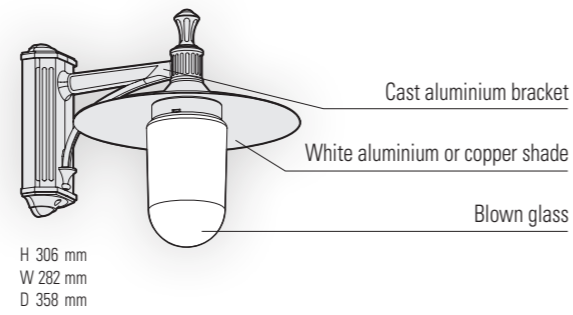

## REFERENCES

Replace ●●● with the colour code

MODELS	DIFFUSERS	WHITE ALUMINIUM SHADE E27	LACQUERED COPPER SHADE E27	CORNER PLATES p.319	SPARE DIFFUSERS
1	CLEAR GLASS	139 001 ●●●	139 002 ●●●		165 012 609
	FROSTED GLASS	139 003 ●●●	139 004 ●●●		165 012 610
2	CLEAR GLASS	139 005 ●●●	139 006 ●●●	147 002 ●●●	165 012 609
	FROSTED GLASS	139 007 ●●●	139 008 ●●●		165 012 610
3	CLEAR GLASS	139 009 ●●●	139 010 ●●●	147 004 ●●●	165 012 609
	FROSTED GLASS	139 011 ●●●	139 012 ●●●		165 012 610
4	CLEAR GLASS	139 013 ●●●	139 014 ●●●		165 012 609
	FROSTED GLASS	139 015 ●●●	139 016 ●●●		165 012 610

## COLOURS CODES

Replace ●●● with the colour code

	RAL 7021 BLACK GREY 107		RAL 6009 BRITISH GREEN 019
	SLATE GREY 059		RAL 6009 FIR GREEN 067
	WHITE 001		GREEN PATINA 008
	RAL 5011 STEEL BLUE 065		RAL 3005 WINE RED 066

Other colours on request

## MOUNTING

Wiring entry points in grey - Fixing kit included

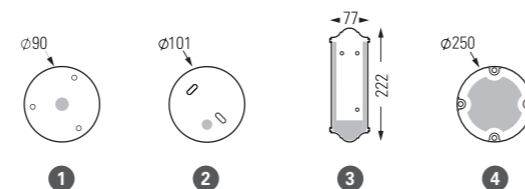

# Newpark

---







# Newpark

IP44  
Class 1

Aluminium  
Clear or frosted glass diffuser

## SOURCE

E27 - 105W max Ø 66 mm - H 120 mm max

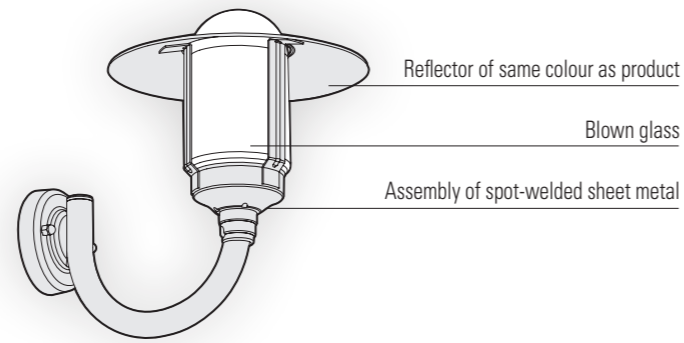

H 329 mm  
W 251 mm  
D 340 mm

## MODELS

height / width / depth



329 / 251 / 340

1



328 / 251 / 280

2

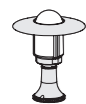

316 / 251

3

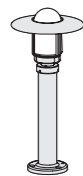

571 / 251

4

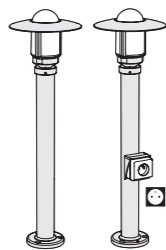

851 / 251

5

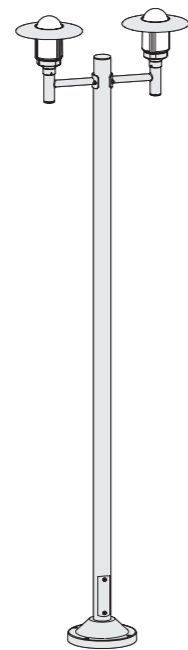

2358 / 664 / 251

6

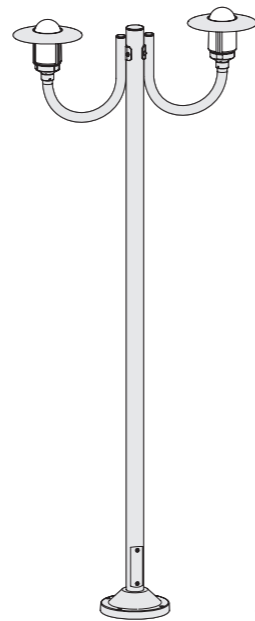

2238 / 908 / 251

7



# Newpark

## REFERENCES

Replace ●●● with the colour code / replace (●) with the country's electrical socket code

MODELS	DIFFUSERS	E27	SOCKET	CORNER PLATE p.319	SPARE DIFFUSERS
1	CLEAR GLASS	141 001 ●●●		147 002 ●●●	165 035 609
	FROSTED GLASS	141 002 ●●●			165 035 610
2	CLEAR GLASS	141 003 ●●●		147 002 ●●●	165 035 609
	FROSTED GLASS	141 004 ●●●			165 035 610
3	CLEAR GLASS	141 005 ●●●			165 035 609
	FROSTED GLASS	141 006 ●●●			165 035 610
4	CLEAR GLASS	141 007 ●●●			165 035 609
	FROSTED GLASS	141 008 ●●●			165 035 610
5	CLEAR GLASS	141 009 ●●●	141 010 ●●●(●)		165 035 609
	FROSTED GLASS	141 011 ●●●	141 012 ●●●(●)		165 035 610
6	CLEAR GLASS	141 013 ●●●			165 035 609
	FROSTED GLASS	141 014 ●●●			165 035 610
7	CLEAR GLASS	141 015 ●●●			165 035 609
	FROSTED GLASS	141 016 ●●●			165 035 610

## COLOURS CODES

Replace ●●● with the colour code

	RAL 9005 JET BLACK	000
	SLATE GREY	059
	METAL GREY	023
	WHITE	001
	BLUE	111
	RAL 5011 STEEL BLUE	065
	RAL 6009 BRITISH GREEN	019
	RAL 6009 FIR GREEN	067
	RAL 3005 WINE RED	066

Other colours on request

## SOCKETS CODES

Except for French socket, replace (●) with country's socket code

	SCHUKO SOCKET SK	SWISS SOCKET CH
	type F	type J

## MOUNTING

Wiring entry points in grey - Fixing kit included

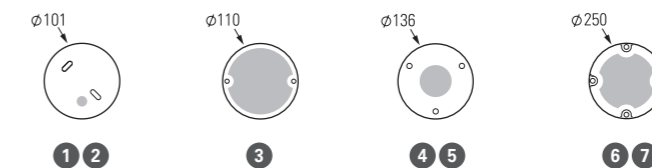

Boléro



# Boléro

IP23  
Class 1

Aluminium  
Clear prismatic glass diffuser

## SOURCE

E27 - 105W max H 150 mm max

## MODELS

height / width / depth

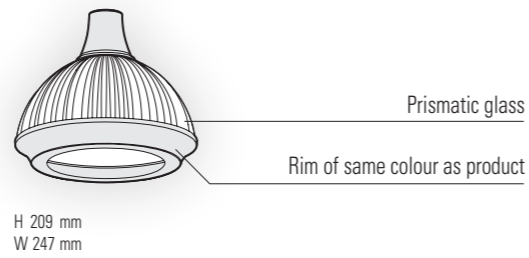
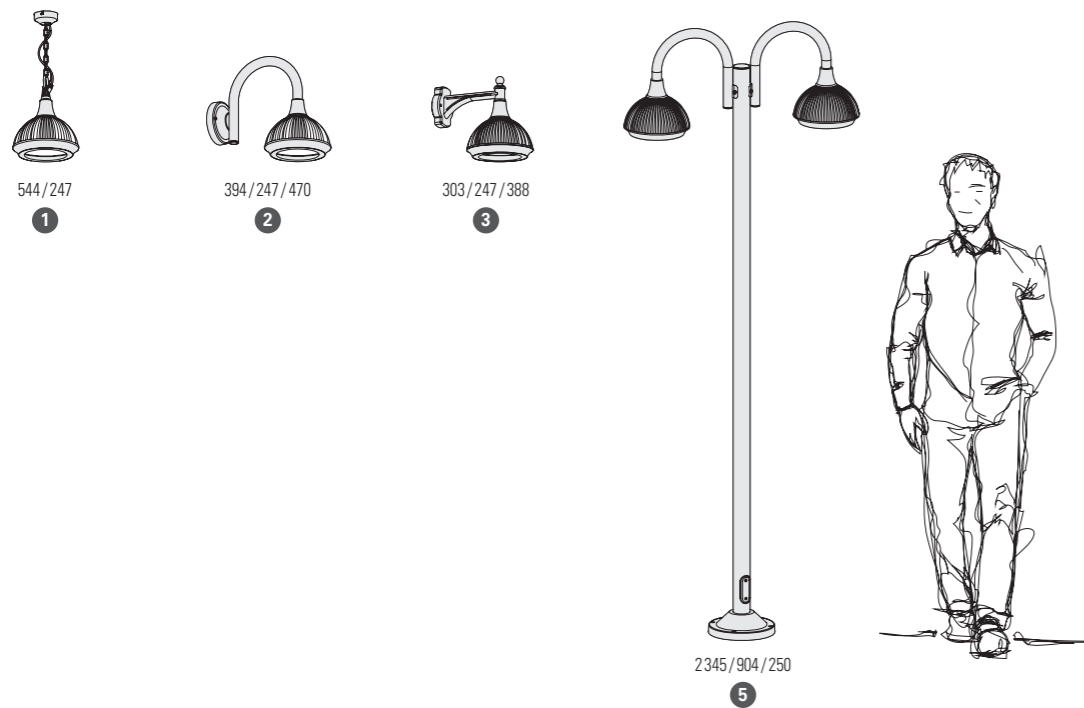

## REFERENCES

Replace ●●● with the colour code

MODELS	E27	CORNER PLATES p.319	SPARE DIFFUSER
1	152 001 ●●●		165 059 ●●●
2	152 002 ●●●	147 003 ●●●	165 059 ●●●
3	152 003 ●●●	147 001 ●●●	165 059 ●●●
5	152 004 ●●●		165 059 ●●●

## COLOURS CODES

Replace ●●● with the colour code

	RAL 9005 JET BLACK	000		RAL 6009 BRITISH GREEN	019
	SLATE GREY	059		RAL 6009 FIR GREEN	067
	WHITE	001		RAL 5011 STEEL BLUE	065
Other colours on request				LIMESTONE	053

## MOUNTING

Wiring entry points in grey - Fixing kit included

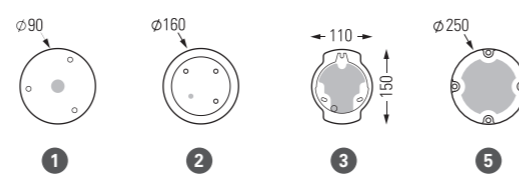

Boréal





# Boréal

IP44  
IK08  
Class 1

Aluminium  
Opal or smoked Ø 200 mm PMMA globe

## SOURCE

E27 - 60W max Ø70 mm - H150 mm max

## MODELS

height / width / depth

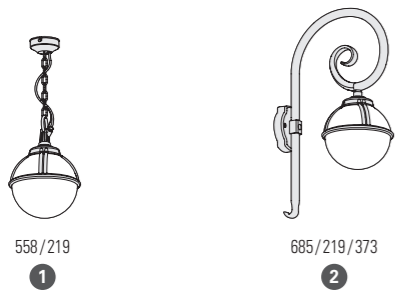

558 / 219

1

685 / 219 / 373

2

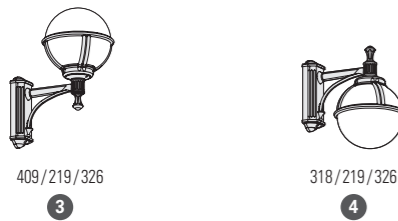

409 / 219 / 326

3

318 / 219 / 326

4



319 / 219

6

462 / 219

7

588 / 219

8

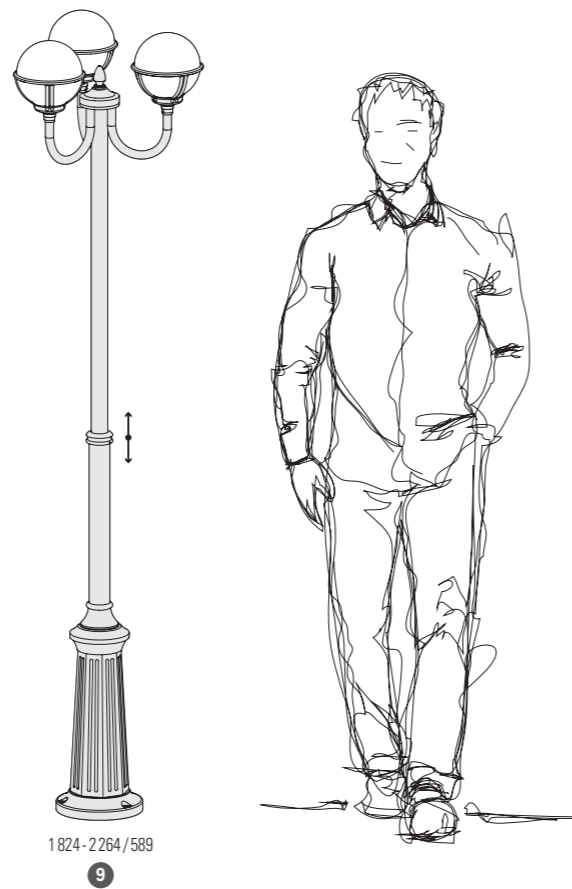

1824 - 2264 / 589

9

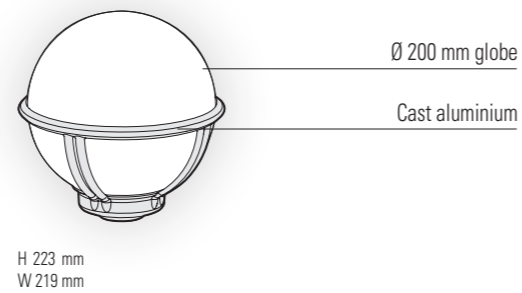

## REFERENCES

Replace ... with the colour code

MODELS	GLOBES	E27	CORNER PLATES p.319	SPARE GLOBES
1	OPAL PMMA	111 001 ...		165 015 606
	SMOKED PMMA	111 002 ...		165 015 607
2	OPAL PMMA	111 003 ...	147 001 ...	165 015 606
	SMOKED PMMA	111 004 ...		165 015 607
3	OPAL PMMA	111 005 ...	147 004 ...	165 015 606
	SMOKED PMMA	111 006 ...		165 015 607
4	OPAL PMMA	111 007 ...	147 004 ...	165 015 606
	SMOKED PMMA	111 008 ...		165 015 607
6	OPAL PMMA	111 009 ...		165 015 606
	SMOKED PMMA	111 010 ...		165 015 607
7	OPAL PMMA	111 011 ...		165 015 606
	SMOKED PMMA	111 012 ...		165 015 607
8	OPAL PMMA	111 013 ...		165 015 606
	SMOKED PMMA	111 014 ...		165 015 607
9	OPAL PMMA	111 015 ...		165 015 606
	SMOKED PMMA	111 016 ...		165 015 607

## COLOURS CODES

Replace ... with the colour code

	RAL 9005 JET BLACK	000
	METAL GREY	023
	RAL 6009 BRITISH GREEN	019
	RAL 6009 FIR GREEN	067
	WHITE	001
	OLD RUSTIC	046
	GREEN PATINA	008
	GOLD PATINA	009

Other colours on request

## MOUNTING

Wiring entry points in grey - Fixing kit included

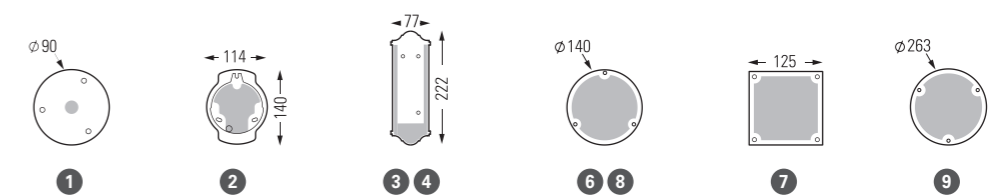

Moon







# Moon

IP44  
IK08  
Class 1

Aluminium  
Opal or smoked Ø 200 mm PMMA globe (models 1 to 4)  
Opal Ø 300 mm PMMA globe (models 5 to 13)

## SOURCE

E27 - 60W max (models 1 to 4)    Ø 70 mm - H 150 mm max  
E27 - 105W max (models 5 to 13)    Ø 80 mm - H 200 mm max

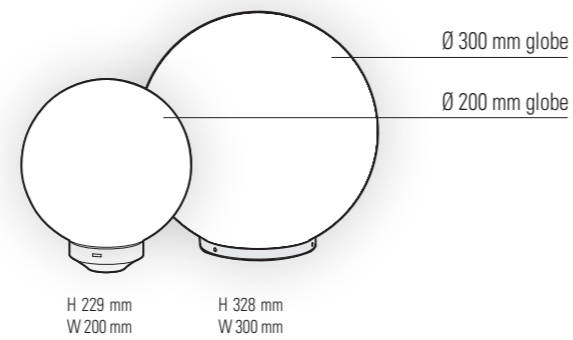

## MODELS Ø200 mm

height / width / depth

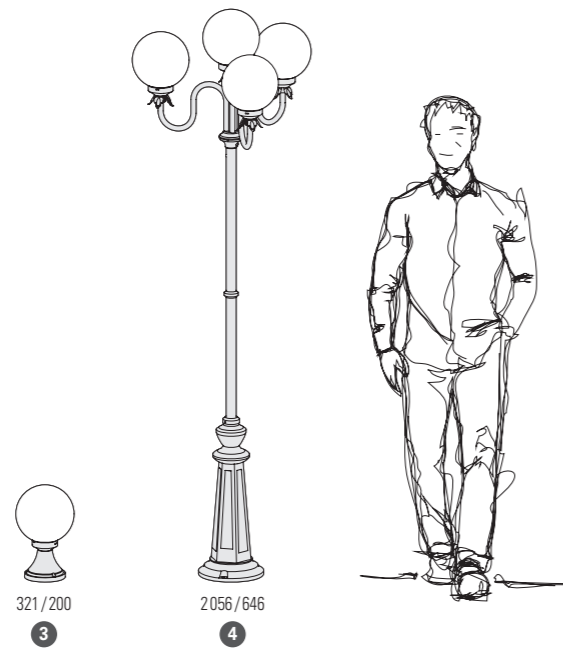
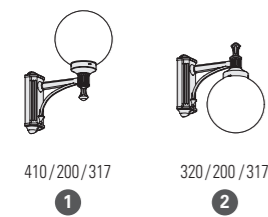

## MODELS Ø300 mm

height / width / depth

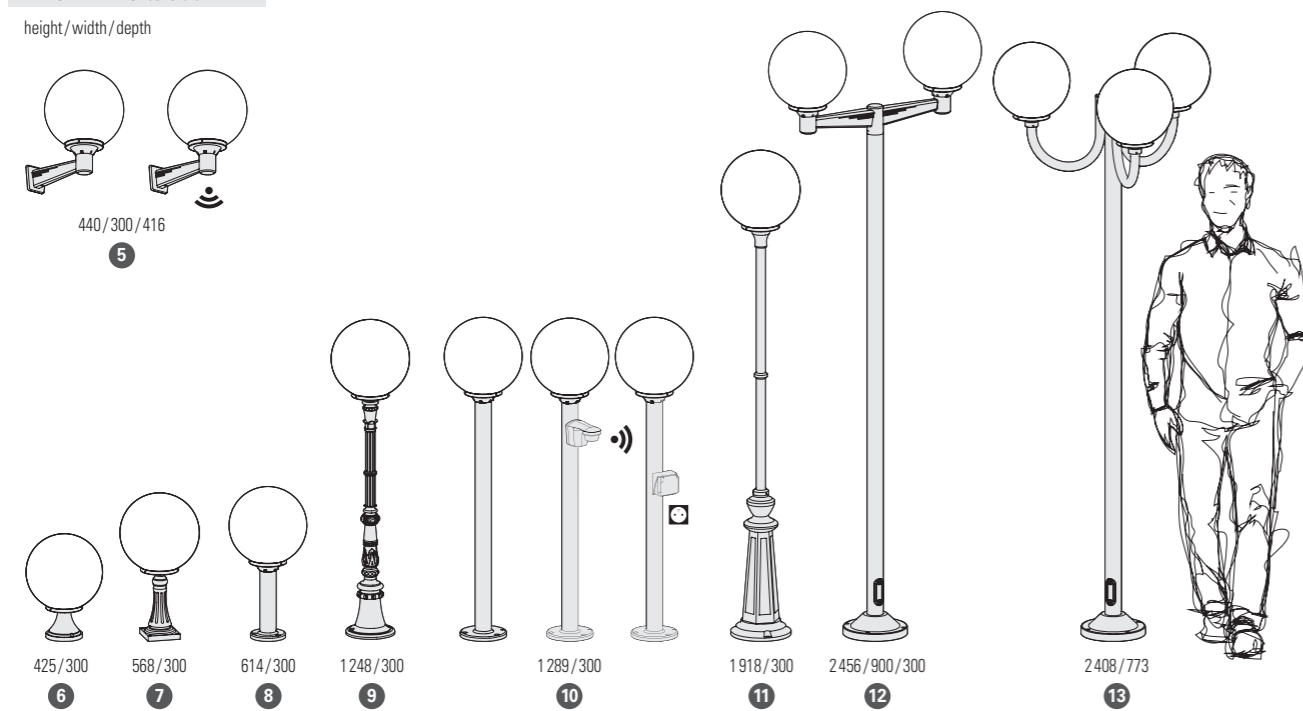

# Moon

## REFERENCES

Replace ●●● with the colour code / replace (●) with the country's electrical socket code

### Ø 200mm

MODELS	GLOBES	E27	CORNER PLATES p.319	SPARE GLOBES
1	SMOKED PMMA	109 001 ●●●	147 004 ●●●	165 015 607
	OPAL PMMA	109 002 ●●●		165 015 606
2	SMOKED PMMA	109 003 ●●●	147 004 ●●●	165 015 607
	OPAL PMMA	109 004 ●●●		165 015 606
3	SMOKED PMMA	109 007 ●●●		165 015 607
	OPAL PMMA	109 008 ●●●		165 015 606
4	SMOKED PMMA	109 011 ●●●		165 015 607
	OPAL PMMA	109 012 ●●●		165 015 606

### Ø 300mm

MODELS	E27	E27 + SENSOR	SOCKET	CORNER PLATE p.319	SPARE OPAL GLOBE
5	109 019 ●●●	109 020 ●●●		147 006 ●●●	165 016 606
6	109 013 ●●●				165 016 606
7	109 014 ●●●				165 016 606
8	109 017 ●●●				165 016 606
9	109 016 ●●●				165 016 606
10	109 021 ●●●	109 022 ●●●	109 023 ●●●(●)		165 016 606
11	109 015 ●●●				165 016 606
12	109 025 ●●●				165 016 606
13	109 024 ●●●				165 016 606

## COLOURS CODES

Replace ●●● with the colour code

	RAL 9005 JET BLACK	000		RAL 6009 BRITISH GREEN	019
	SLATE GREY	059		RAL 6009 FIR GREEN	067
	GREEN PATINA	008		SANDSTONE	054
	WHITE	001		LIMESTONE	053

Other colours on request

## SOCKETS CODES

Except for French socket, replace (●) with country's socket code

	SCHUKO SOCKET SK	SWISS SOCKET CH
	type F	type J

## MOUNTING

Wiring entry points in grey - Fixing kit included

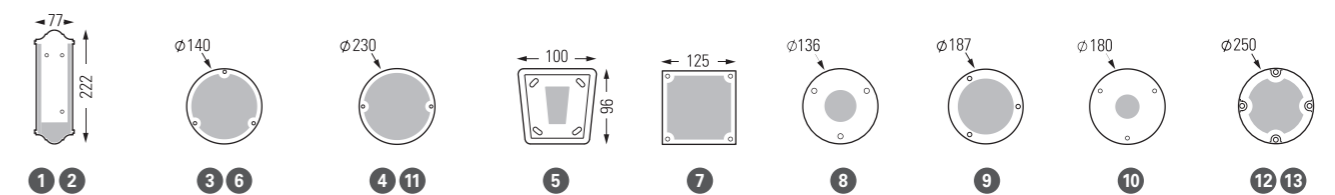

Dallas





# Dallas

IP44  
IK10  
Class 1

Aluminium  
Opal or smoked polycarbonate diffuser

## SOURCE

E27 - 75W max H 200 mm

## MODELS

height / width / depth

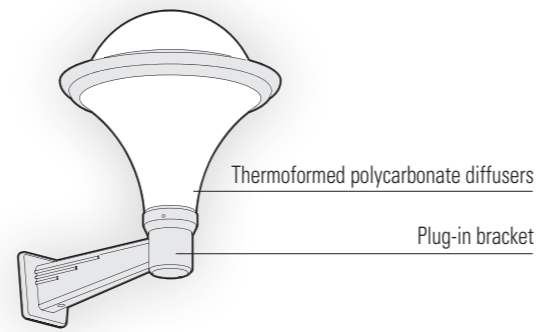
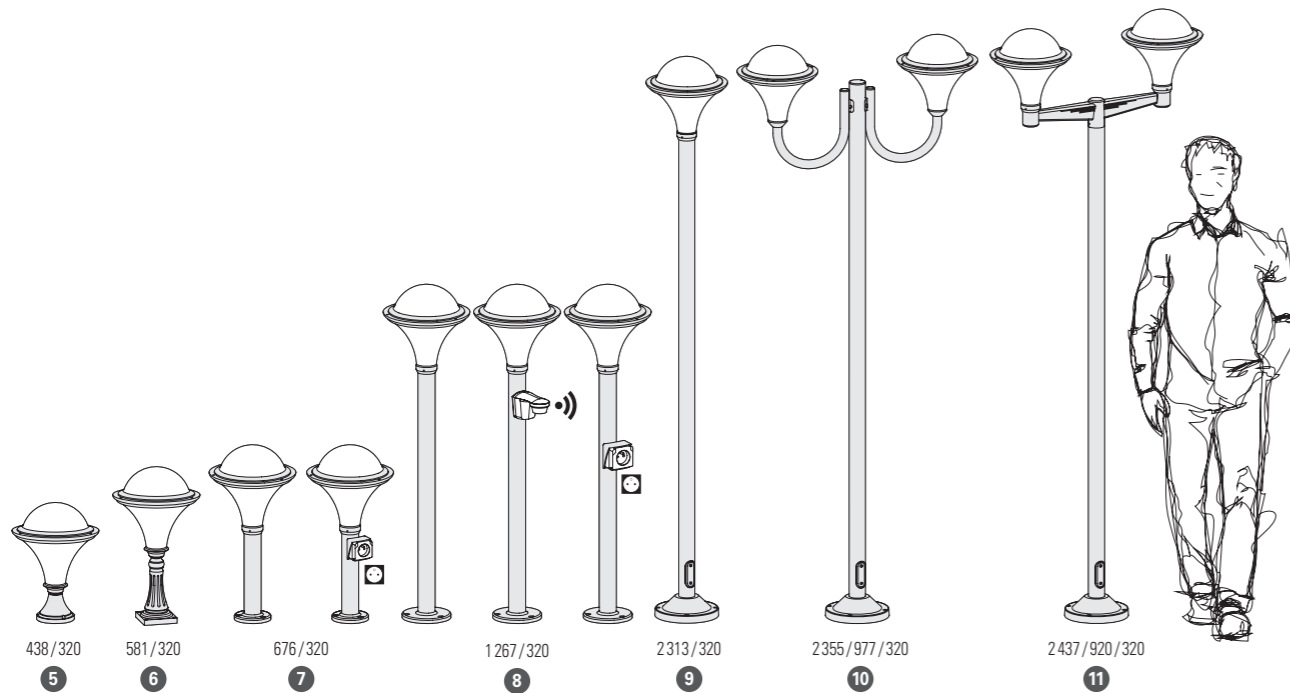
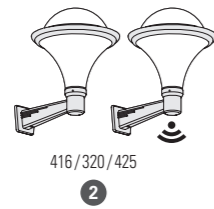

H 416 mm  
W 320 mm  
D 425 mm

# Dallas

## REFERENCES

Replace ●●● with the colour code / replace (●) with the country's electrical socket code

MODELS	DIFFUSERS	E27	E27 + SENSOR	SOCKET	CORNER PLATES p.319	SPARE UPPER DIFFUSERS	SPARE LOWER DIFFUSERS
1	OPAL POLYCARBONATE	119 001 ●●●			147 003 ●●●	165 024 602	165 073 602
	SMOKED POLYCARBONATE	119 002 ●●●				165 024 603	165 073 603
2	OPAL POLYCARBONATE	119 003 ●●●	119 004 ●●●		147 006 ●●●	165 024 602	165 073 602
	SMOKED POLYCARBONATE	119 005 ●●●	119 006 ●●●			165 024 603	165 073 603
3	OPAL POLYCARBONATE	119 021 ●●●			147 001 ●●●	165 024 602	165 073 602
	SMOKED POLYCARBONATE	119 022 ●●●				165 024 603	165 073 603
4	OPAL POLYCARBONATE	119 023 ●●●			147 001 ●●●	165 024 602	165 073 602
	SMOKED POLYCARBONATE	119 024 ●●●				165 024 603	165 073 603
5	OPAL POLYCARBONATE	119 025 ●●●				165 024 602	165 073 602
	SMOKED POLYCARBONATE	119 026 ●●●				165 024 603	165 073 603
6	OPAL POLYCARBONATE	119 027 ●●●				165 024 602	165 073 602
	SMOKED POLYCARBONATE	119 028 ●●●				165 024 603	165 073 603
7	OPAL POLYCARBONATE	119 007 ●●●		119 008 ●●●(●)		165 024 602	165 073 602
	SMOKED POLYCARBONATE	119 009 ●●●		119 010 ●●●(●)		165 024 603	165 073 603
8	OPAL POLYCARBONATE	119 011 ●●●	119 013 ●●●	119 012 ●●●(●)		165 024 602	165 073 602
	SMOKED POLYCARBONATE	119 014 ●●●	119 016 ●●●	119 015 ●●●(●)		165 024 603	165 073 603
9	OPAL POLYCARBONATE	119 029 ●●●				165 024 602	165 073 602
	SMOKED POLYCARBONATE	119 030 ●●●				165 024 603	165 073 603
10	OPAL POLYCARBONATE	119 017 ●●●				165 024 602	165 073 602
	SMOKED POLYCARBONATE	119 018 ●●●				165 024 603	165 073 603
11	OPAL POLYCARBONATE	119 019 ●●●				165 024 602	165 073 602
	SMOKED POLYCARBONATE	119 020 ●●●				165 024 603	165 073 603

## COLOURS CODES

Replace ●●● with the colour code

	RAL 9005 JET BLACK 000		RAL 5011 STEEL BLUE 065
	DARK GREY 006		RAL 6009 BRITISH GREEN 019
	SLATE GREY 059		RAL 6009 FIR GREEN 067
	WHITE 001		SANDSTONE 054

Other colours on request

## SOCKETS CODES

Except for French socket, replace (●) with country's socket code

	SCHUKO SOCKET SK type F		SWISS SOCKET CH type J
--	----------------------------	--	---------------------------

## MOUNTING

Wiring entry points in grey - Fixing kit included

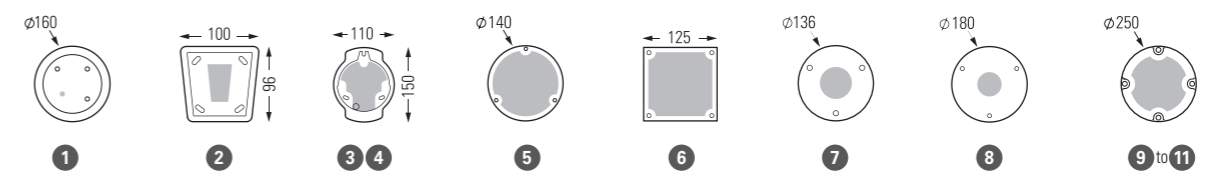

## Annexes

---

Bornéo : electrical sockets / motion and photosensor  
p. 314

---

Bollards with IP55 socket  
p. 315

---

Wall lights with motion and photosensor  
p. 316

---

Bollards with motion and photosensor  
p. 317

---

Accessories  
p. 318

---

Ingress Protection (IP) ratings  
p. 320

---

Glossary  
p. 321

---

Information  
p. 321

---

Acknowledgements  
p. 322

---

Colour chart  
p. 323

# Bornéo

Electrical sockets / motion and photosensor

IP44  
Class 1

Aluminium  
IP55 socket

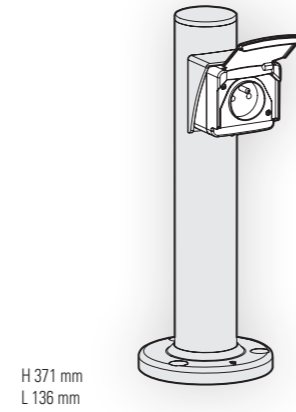

H 371 mm  
L 136 mm

## MODELS

height / width / depth



## REFERENCES

Replace ... with the colour code

MODELS	FRENCH SOCKET	SCHUKO SOCKET Type F	SWISS SOCKET Type J	SENSOR
1	107 001 ...	107 002 ...	107 004 ...	
2	107 006 ...	107 007 ...	107 009 ...	
3				107 011 ...

## COLOURS CODES

Replace ... with the colour code

	DARK GREY 006		RAL 5011 STEEL BLUE 065
	SLATE GREY 059		RAL 6009 BRITISH GREEN 019
	METAL GREY 023		RAL 6009 FIR GREEN 067
	WHITE 001		OLD RUSTIC 046
Other colours on request			SANDSTONE 054

## MOUNTING

Wiring entry points in grey  
Fixing kit included

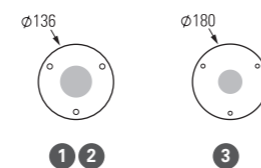

# Bollards with IP55 socket

Country-specific sockets  
Separate power supply (socket/light)

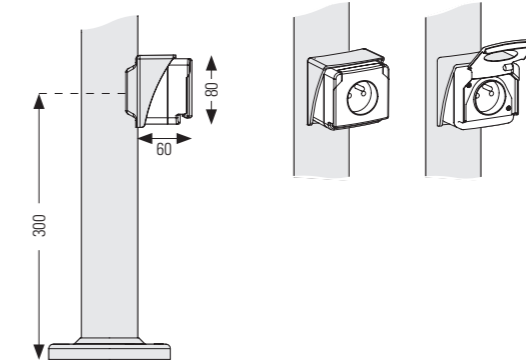

Exclusively on these models

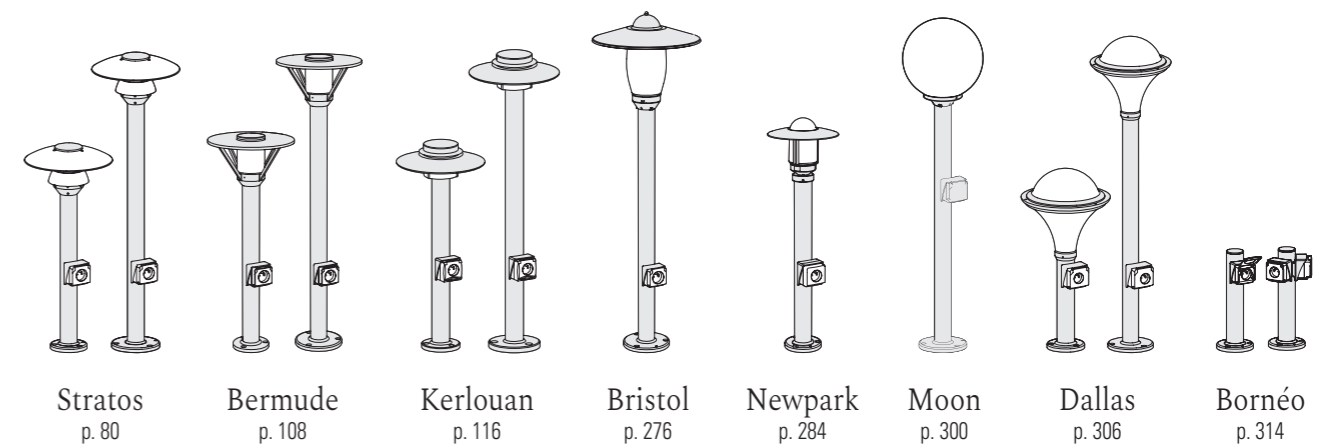

# Wall lights with motion and photosensor

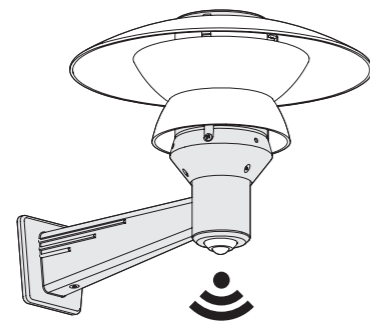

- Recommended mounting height 2,50 m
- Sensor range: depends on the mounting height
- Maximum range: 5 m
- Available settings via remote control:
  - Switch on time: from 15s to 30min
  - Trigger threshold: 20 lux to 1000 lux
  - Sensivity
  - Forced operation



# Bollards with motion and photosensor

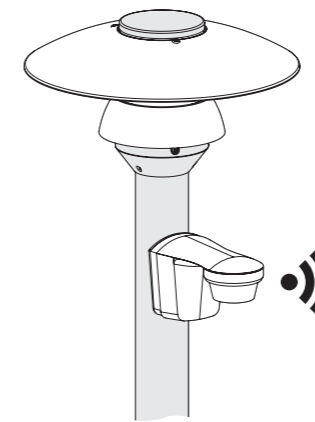

- Maximum range: 5 m
- Manual settings
- Switch on time: 1 s to 20 min
- Trigger threshold: 5 lux to 1 000 lux
- Adjustable sensivity
- 1 detector for several fixtures  
(up to 100W LED - 150W FLC - 2300W hal)
- White block detection for white products  
Black block detection for other colors
- Removable motion and photosensor

## Exclusively on these models

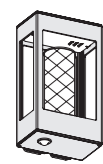

Tetra  
p. 42



Stratos  
p. 80

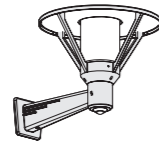

Bermude  
p. 108

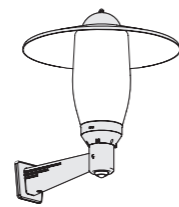

Bristol  
p. 276

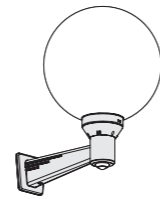

Moon  
p. 300

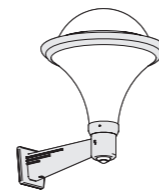

Dallas  
p. 306

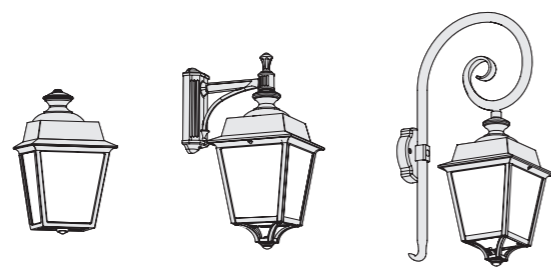

Place des Vosges 1 Évolution  
p. 230

## Exclusively on these models

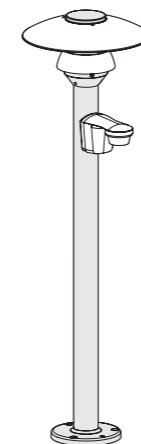

Stratos  
p. 80

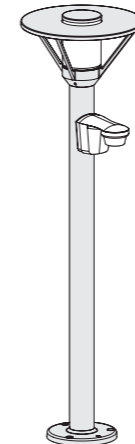

Bermude  
p. 108

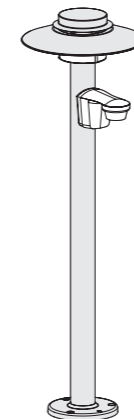

Kerlouan  
p. 116

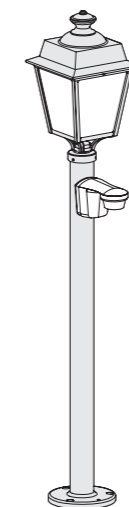

Place des Vosges 1 Évolution  
p. 230

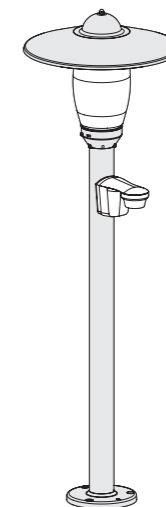

Bristol  
p. 276

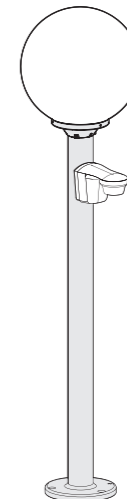

Moon  
p. 300

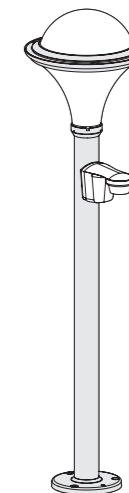

Dallas  
p. 306

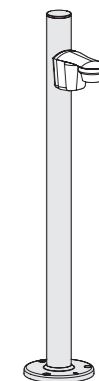

Bornéo  
p. 314

# Accessories

## IP68 waterproof connector box

Réf. 147 101 998

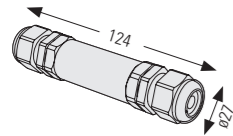

Réf. 147 102 998

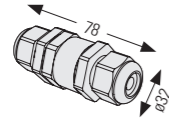

## IP68 waterproof connector box (1-in 2-out)

Réf. 147 103 998

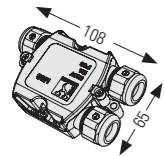

## Lamp ø75 base Gx53

Exclusively for the Picto collection

LED 3W Réf. 147 105 998

FLC 9W Réf. 147 104 998



## Lamp FLC 2Gx13

Exclusively for the Mona collection

FLC 22W Réf. 147 106 998



## Frosted PMMA Bulb cover

Exclusively for the Tetra collection

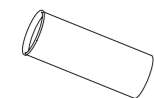

Réf. 165 075 606



## Anchor bolts on request

COLLECTIONS	MODELS	REFERENCES
TETRA	5	147 110 998
OL 2	5	147 108 998
OL 3	5, 6, 7	147 108 998
KIRLAN	3, 4	147 108 998
AVENUE 2	11	147 109 998
AVENUE 3	7, 8, 9	147 109 998
	10, 11	147 108 998
AVENUE 4	6	147 110 998
	8, 9	147 111 998
LOUIS XIII	6, 7	147 109 998
CITADELLE	4	147 110 998
	5, 7	147 111 998
LOUVRE	10, 11	147 109 998
PLACE DES VOSGES 2	11	147 109 998
PLACE DES VOSGES 3	7, 8, 10	147 109 998
BRISTOL	7	147 108 998

## Globes

MODELS	OPAL PMMA GLOBE	SMOKED PMMA GLOBE
 Diameter 200 mm Ø Int. : 76 mm Ø Ext. : 82 mm With thread 60W max.	165 015 606	165 015 607
 Diameter 300 mm Ø Int. : 87mm Ø Ext. : 100mm With bayonet system 100W max.	165 016 606	

# Accessories

## Corner plates

### MODELS

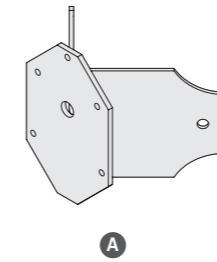

A

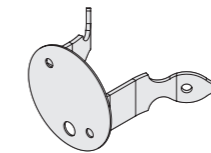

B

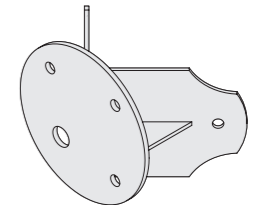

C

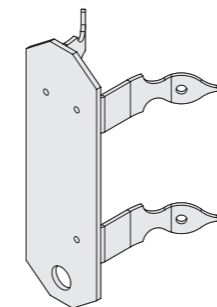

D

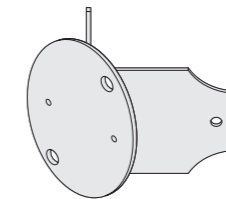

E

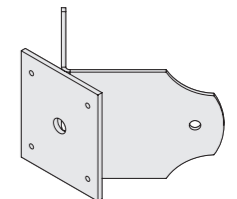

F

### REFERENCES













Replace ... with the colour code

### MODELS

A	B	C	D	E	F
147 001 ...	147 002 ...	147 003 ...	147 004 ...	147 005 ...	147 006 ...

### COLOURS CODES

Replace ... with the colour code

	RAL 9005 JET BLACK 000		RAL 3005 WINE RED 066
	DARK GREY 006		SANDSTONE 054
	METAL GREY 023		LIMESTONE 053
	WHITE 001		OLD RUSTIC 046
	RAL 6009 BRITISH GREEN 019		GREEN PATINA 008
	RAL 5011 STEEL BLUE 065		GOLD PATINA 009

Other colours on request



# Ingress Protection (IP) ratings

The degrees of protection (IP) are defined by the french standard NF EN 60-529

IP **X**\_: protection rating against solids

- IP **0**\_ No protection
- IP **1**\_ Protected against solid foreign objects over 50 mm in diameter (e.g. involuntary contact with the hand)
- IP **2**\_ Protected against solid foreign objects over 12 mm in diameter (e.g. finger)
- IP **3**\_ Protected against solid foreign objects over 2,5 mm in diameter (e.g. tools and wires)
- IP **4**\_ Protected against solid foreign objects over 1 mm in diameter (e.g. small tools and wires)
- IP **5**\_ Dust-protected (no harmful deposits)
- IP **6**\_ Totally protected against dust

IP **\_X**: protection rating against liquids

- IP **\_0** No protection
- IP **\_1** Protected against vertically dripping water (e.g. condensation)
- IP **\_2** Protected against dripping water up to 15° from vertical
- IP **\_3** Protected against direct spray of water up to 60° from vertical
- IP **\_4** Protected against direct spray of water from all directions
- IP **\_5** Protected against jet of water from all directions applied by spray lance
- IP **\_6** Protected against direct sprays of water comparable to big waves
- IP **\_7** Protected against the effects of immersion
- IP **\_8** Protected against long periods of immersion under pressure

# Glossary

«Boomerang»: wall mounting plate



Can be easily and quickly fixed to any surface.  
Allows pre-mounting.  
Isolates the aluminium casing from the wall.  
Wall light can easily be rotated and locked in place.

«Easycap»: waterproof quick-connect system



«Easycap» is a patented membrane that allows wires to be directly connected.  
Solid-core wires can be directly pushed through the membrane.  
For stranded wires, the installer must crimp cable terminals first.

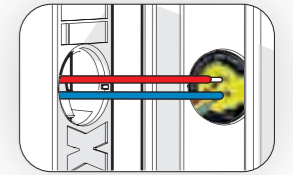

# Information

Each reference is a complete product.

Bulbs are not included.

All standard Roger Pradier®'s electrical plugs are Schuko type (mobile models).

Models in brass or copper are provided with black aluminium supports.

The steel supports (Equix base model 2, Noctiluque, Avenue 4 bracket model 13...) are not covered under warranty against corrosion.

The lining of the models in brass, copper, zinc, corten and stainless steel may be altered depending on the climate or the environment. They are not guaranteed against oxidation.

It is recommended to regularly maintain the fixtures in accordance with the recommendations of the installation instructions.

Our terms of sale are listed on the back of our delivery notes and bills.

To further improve its products, the company Roger Pradier® reserves the right to change without notice or compensation totally or any part of the material presented in this catalogue.

The images, dimensions and scenarios in the photographs in this catalogue cannot be regarded as contractual.

# Acknowledgements

We would like to extend our thanks to all those who supported, encouraged and assisted us in the production of this catalogue.

We couldn't have made such a great job of it without the positive reception we received in the following places to showcase Roger Pradier® lighting designs:

- Chez Boulan - Lège-Cap-Ferret
- Cercle Nautique du Ferret - Lège-Cap-Ferret
- La Cabane WHITEhe - Cap Ferret
- Le Jardin des sculptures, Château de Bois-Guilbert
- Le Rize, Centre Mémoires et Société - Villeurbanne
- Château de Villandry
- Château de Valençay
- Château d'Artigny - Montbazou
- Les Jardins de Poulaines
- École des Francs Bourgeois - Paris
- Le Cayola Restaurant - Le Château-d'Olonne
- Le Churchill's Pub - Moscou
- Regent Hôtel Porto Monténégro
- Hapimag Resort Château de Chabenay - Le Pont-Chrétien-Chabenay
- Maison Départementale des Sports - Châteauroux
- Monique Barge Architecte - Châteauroux

Our thanks also go out to our artistic collaborators on this project, Antoine Ricardou - Le Studio Be-Poles, Laetitia De Witte - Atelier Laete, for their invaluable advice and contributions.

A big thanks to Le Goff & Gabarra for the new Roger Pradier® graphic charter.

Lastly, and most importantly, we're indebted to everyone who works with us at Roger Pradier® for taking part so enthusiastically and with so much dedication – with an especially big thank you going out to computer graphics whizz Amandine Penot and creative director Stéphane Joyeux for their unflagging contributions.

## Photo Credits:

Arnaud Childéric | Kalice photographies - kalice.fr  
 Dimitri Coste | motelcoste.com  
 Marc Jauneaud | Image de Marc  
 Fabrice Poulpier | fabricepouplier.com  
 Camille Gabarra | Le Goff & Gabarra - lgetg.fr

Graphic Design & Production: Roger Pradier®

Legal deposit: November 2017  
 Printed in France by Centr'imprim in Issoudun

# Colour chart

## Colours

	VELVET BLACK	113
	RAL 9005 JET BLACK	000
	RAL 7021 BLACK GREY	107
	SLATE GREY	059
	DARK GREY	006
	METAL GREY	023
	RAL 7044 SILK GREY	105
	WHITE	001
	RAL 9010 PURE WHITE	101
	RAL 5011 STEEL BLUE	065
	RAL 5009 AZURE BLUE	058
	BLUE	111
	RAL 6009 BRITISH GREEN	019
	RAL 6009 FIR GREEN	067
	RAL 6025 FERN GREEN	109
	RAL 6018 YELLOW GREEN	015
	RAL 1016 SULFUR YELLOW	068
	RAL 2004 PURE ORANGE	014
	RAL 3020 TRAFFIC RED	056
	RAL 3013 TOMATO RED	110
	RAL 3005 WINE RED	066
	OLD RUSTIC	046
	SANDSTONE	054
	LIMESTONE	053
	GREEN PATINA	008
	GOLD PATINA	009

## Materials

	PATINATED & LACQUERED COPPER	080
	TINTED LACQUERED BRASS	070
	INOX	018
	RAW ZINC	092

Colours and finishes shown in this catalogue are merely indicative due to printing processes. Please refer to our real colourswatches for a more realistic rendering.





— Colour chart

**ROGER PRADIER**

France +33(0)2 54 53 56 54

Export +33(0)2 54 53 56 56

Fax +33(0)2 54 34 78 45

[info@roger-pradier.com](mailto:info@roger-pradier.com)

[roger-pradier.com](http://roger-pradier.com)

*Factory – Headquarters*

46 avenue d'Occitanie  
36250 Saint-Maur - France

*Trade office Paris*

12 rue Lamartine  
75009 Paris - France



Made  
in France