

# 2026

deutsch  
international

Alle Preise zzgl. ges. MwSt.

# LIVING THE LIGHT®

serien  
.lighting



<b>ANNEX</b>	Ceiling	2
	Suspension	5
<b>APP</b>	Wall	7
<b>CAVITY</b>	Ceiling	8
	Recessed	11
	Suspension	14
	Wall	16
<b>CLUB</b>	Floor	18
	Wall	19
<b>CRIB</b>	Wall	20
<b>CURLING</b>	Ceiling	21
	Suspension	26
	Wall	30
<b>DON</b>	Ceiling <small>new</small>	34
	Suspension <small>new</small>	37
	Wall <small>new</small>	40
<b>DRAFT</b>	Ceiling	42
	Suspension	45
<b>DRUM</b>	Ceiling	47
	Suspension	49
<b>JOB</b>	Table	51
<b>JONES</b>	Floor	52
<b>LYD</b>	Wall	53
<b>ONE EIGHTY</b>	Suspension	54
<b>POPPY</b>	Ceiling	55
	Suspension	57
	Table	58
	Floor	59
<b>REEF</b>	Ceiling	60
	Suspension	60
	Wall	61
<b>REFLEX<sup>2</sup></b>	Ceiling <small>new</small>	62
	Wall	73
	Table	73
	Floor	74
<b>ROD</b>	Wall	75
<b>SLICE<sup>2</sup></b>	Furniture	76
	Floor	78
<b>SLICE<sup>2</sup> PI</b>	Ceiling <small>new</small>	79
	Suspension <small>new</small>	84
	Wall <small>new</small>	94
<b>SML</b>	Wall	97
<b>SML<sup>2</sup></b>	Wall 150 - 300	99
	Wall 600 - 1200	102
<b>TWIN</b>	Suspension	105
<b>ZOOM</b>	Suspension	106

Info	Product information	108
	Luminaire features	109
	Lighting technology	110
	Contacts	111
	Awards	112
	Imprint	

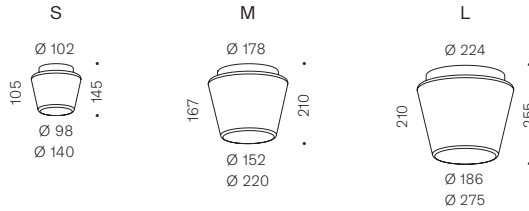
# ANNEX Ceiling





## ANNEX Ceiling S new





Abbildung figure	Beschreibung description	Leuchtmittel lamp	Regelung control	Leistung power	CCT	EEL EEC	Lumen lumen	Art.-Nr. art.-no.	€ netto DE excl. VAT	€ brutto DE incl. VAT
	Reflektor opal reflector opal	LED	TRIAC	9 W	2700 K	F	950lm	AN3201	352,94 €	420 €
					3000 K	E	1000lm	AN3202		
					4000 K <span style="color: blue;">new</span>	E	1030lm	AN3208		
					2700 K	F	950lm	AN3206		
					3000 K	E	1000lm	AN3207		
					4000 K	E	1030lm	AN3209		
			DALI <span style="color: blue;">new</span>	9 W	2700 K	F	950lm	AN3201C	378,15 €	450 €
					3000 K	E	1000lm	AN3202C		
					4000 K	E	1030lm	AN3208C		
					2700 K	F	950lm	AN3201C		
					3000 K	E	1000lm	AN3202C		
					4000 K	E	1030lm	AN3208C		
G9	TRIAC	max. 60 W		G	980lm	AN1013	273,11 €	325 €		
	Reflektor poliert reflector polished	LED	TRIAC	9 W	2700 K	F	950lm	AN3211	378,15 €	450 €
					3000 K	E	1000lm	AN3212		
					4000 K <span style="color: blue;">new</span>	E	1030lm	AN3213		
					2700 K	F	950lm	AN3216		
					3000 K	E	1000lm	AN3217		
					4000 K	E	1030lm	AN3218		
			DALI <span style="color: blue;">new</span>	9 W	2700 K	F	950lm	AN3211C	403,36 €	480 €
					3000 K	E	1000lm	AN3212C		
					4000 K	E	1030lm	AN3213C		
					2700 K	F	950lm	AN3211C		
					3000 K	E	1000lm	AN3212C		
					4000 K	E	1030lm	AN3213C		
G9	TRIAC	max. 60 W		G	980lm	AN1121	294,12 €	350 €		
	Reflektor Kristall reflector crystal	LED	TRIAC	9 W	2700 K	F	950lm	AN3221	449,58 €	535 €
					3000 K	E	1000lm	AN3222		
					4000 K <span style="color: blue;">new</span>	E	1030lm	AN3223		
					2700 K	F	950lm	AN3226		
					3000 K	E	1000lm	AN3227		
					4000 K	E	1030lm	AN3228		
			DALI <span style="color: blue;">new</span>	9 W	2700 K	F	950lm	AN3221C	474,79 €	565 €
					3000 K	E	1000lm	AN3222C		
					4000 K	E	1030lm	AN3223C		
					2700 K	F	950lm	AN3221C		
					3000 K	E	1000lm	AN3222C		
					4000 K	E	1030lm	AN3223C		
G9	TRIAC	max. 60 W		G	980lm	AN1043	369,75 €	440 €		

IP20     
protection class lamp included individual

LED     
dimmable CRI >97 SDCM 2



# ANNEX Ceiling M new

Abbildung figure	Beschreibung description	Leuchtmittel lamp	Regelung control	Leistung power	CCT	EEL EEC	Lumen lumen	Art.-Nr. art.-no.	€ netto DE excl. VAT	€ brutto DE incl. VAT		
	<b>Reflektor opal</b> reflector opal	LED	TRIAC	20 W	2700K	F	1910lm	AN3001	478,99 €	570 €		
					3000K	E	2010lm	AN3002				
					4000K <span style="background-color: #0070C0; color: white; padding: 2px;">new</span>	E	2080lm	AN3009				
			2700K	F	2900lm	AN3006	512,61 €	610 €				
			3000K	F	2750lm	AN3007						
			4000K <span style="background-color: #0070C0; color: white; padding: 2px;">new</span>	E	2910lm	AN3008						
			CASAMBI <span style="background-color: #0070C0; color: white; padding: 2px;">new</span>	20 W	2700K	F	1910lm	AN3001C			563,03 €	670 €
			3000K		E	2010lm	AN3002C					
			4000K		E	2080lm	AN3009C					
		B15d	TRIAC	max. 100W		G	1800lm	AN1066	352,94 €	420 €		
			<b>Reflektor poliert</b> reflector polished	LED	TRIAC	20 W	2700K	F	1910lm	AN3011	512,61 €	610 €
							3000K	E	2010lm	AN3012		
4000K <span style="background-color: #0070C0; color: white; padding: 2px;">new</span>	E						2080lm	AN3018				
2700K	F				2900lm	AN3015	546,22 €	650 €				
3000K	F				2750lm	AN3016						
4000K <span style="background-color: #0070C0; color: white; padding: 2px;">new</span>	E				2910lm	AN3017						
CASAMBI <span style="background-color: #0070C0; color: white; padding: 2px;">new</span>	20 W				2700K	F	1910lm	AN3011C	596,64 €	710 €		
3000K					E	2010lm	AN3012C					
4000K					E	2080lm	AN3018C					
B15d	TRIAC			max. 100W		G	1800lm	AN1078	386,55 €	460 €		
	<b>Reflektor Kristall</b> reflector crystal			LED	TRIAC	20 W	2700K	F	1910lm	AN3021	621,85 €	740 €
							3000K	E	2010lm	AN3022		
		4000K <span style="background-color: #0070C0; color: white; padding: 2px;">new</span>	E				2080lm	AN3028				
		2700K	F		2900lm	AN3025	655,46 €	780 €				
		3000K	F		2750lm	AN3026						
		4000K <span style="background-color: #0070C0; color: white; padding: 2px;">new</span>	E		2910lm	AN3027						
		CASAMBI <span style="background-color: #0070C0; color: white; padding: 2px;">new</span>	20 W		2700K	F	1910lm	AN3021C	705,88 €	840 €		
		3000K			E	2010lm	AN3022C					
		4000K			E	2080lm	AN3028C					
		B15d	TRIAC	max. 100W		G	1800lm	AN1073	495,80 €	590 €		

**IP20**  protection class  
 through wiring  
 emergency light option  
 individual

**LED**  dimmable  
 CRI >97  
 SDCM 2

# ANNEX Ceiling L new

Abbildung figure	Beschreibung description	Leuchtmittel lamp	Regelung control	Leistung power	CCT	EEK EEC	Lumen lumen	Art.-Nr. art.-no.	€ netto DE excl. VAT	€ brutto DE incl. VAT
	<b>Reflektor opal</b> reflector opal	LED	TRIAC	34 W	2700 K	F	3510lm	AN3047	554,62 €	660 €
					3000 K	E	3710lm	AN3048		
					4000 K <span style="color: #0070C0;">new</span>	E	3830lm	AN3093		
			DALI	41 W	2700 K	F	4060lm	AN3051	596,64 €	710 €
					3000 K	E	4270lm	AN3052		
					4000 K <span style="color: #0070C0;">new</span>	E	4410lm	AN3094		
			CASAMBI <span style="color: #0070C0;">new</span>	34 W	2700 K	F	3510lm	AN3047C	634,45 €	755 €
					3000 K	E	3710lm	AN3048C		
					4000 K	E	3830lm	AN3093C		
	<b>Reflektor poliert</b> reflector polished	LED	TRIAC	34 W	2700 K	F	3510lm	AN3053	596,64 €	710 €
					3000 K	E	3710lm	AN3054		
					4000 K <span style="color: #0070C0;">new</span>	E	3830lm	AN3095		
			DALI	41 W	2700 K	F	4060lm	AN3057	638,66 €	760 €
					3000 K	E	4270lm	AN3058		
					4000 K <span style="color: #0070C0;">new</span>	E	4410lm	AN3096		
			CASAMBI <span style="color: #0070C0;">new</span>	34 W	2700 K	F	3510lm	AN3053C	680,67 €	810 €
					3000 K	E	3710lm	AN3054C		
					4000 K	E	3830lm	AN3095C		
	<b>Reflektor Kristall</b> reflector crystal	LED	TRIAC	34 W	2700 K	F	3510lm	AN3041	760,50 €	905 €
					3000 K	E	3710lm	AN3042		
					4000 K <span style="color: #0070C0;">new</span>	E	3830lm	AN3097		
			DALI	41 W	2700 K	F	4060lm	AN3045	806,72 €	960 €
					3000 K	E	4270lm	AN3046		
					4000 K <span style="color: #0070C0;">new</span>	E	4410lm	AN3098		
			CASAMBI <span style="color: #0070C0;">new</span>	34 W	2700 K	F	3510lm	AN3041C	844,54 €	1.005 €
					3000 K	E	3710lm	AN3042C		
					4000 K	E	3830lm	AN3097C		



 IP20 protection class  
 through wiring  
 emergency light option  
 battery option  
 individual



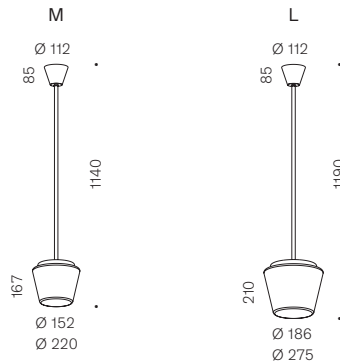

 LED  
 dimmable  
 Zhaga standard  
 CRI >97  
 SDCM 2

# ANNEX Suspension





## ANNEX Suspension M new

Abbildung figure	Beschreibung description	Regelung control	Leistung power	CCT	EEL EEC	Lumen	Art.-Nr. art.-no.	€ netto DE excl. VAT	€ brutto DE incl. VAT
	Reflektor opal reflector opal	TRIAC	20 W	2700K	F	1910lm	AN3101	634,45 €	755 €
				3000K	E	2010lm	AN3102		
				4000K <span style="background-color: #0070C0; color: white; padding: 2px;">new</span>	E	2080lm	AN3187		
		DALI	27 W	2700K	F	2900lm	AN3105	672,27 €	800 €
				3000K	F	2750lm	AN3106		
				4000K <span style="background-color: #0070C0; color: white; padding: 2px;">new</span>	E	2910lm	AN3188		
CASAMBI <span style="background-color: #0070C0; color: white; padding: 2px;">new</span>	20 W	2700K	F	1910lm	AN3101C	718,49 €	855 €		
		3000K	E	2010lm	AN3102C				
		4000K	E	2080lm	AN3187C				
	Reflektor poliert reflector polished	TRIAC	20 W	2700K	F	1910lm	AN3111	672,27 €	800 €
				3000K	E	2010lm	AN3112		
				4000K <span style="background-color: #0070C0; color: white; padding: 2px;">new</span>	E	2080lm	AN3189		
		DALI	27 W	2700K	F	2900lm	AN3116	705,88 €	840 €
				3000K	F	2750lm	AN3117		
				4000K <span style="background-color: #0070C0; color: white; padding: 2px;">new</span>	E	2910lm	AN3190		
CASAMBI <span style="background-color: #0070C0; color: white; padding: 2px;">new</span>	20 W	2700K	F	1910lm	AN3111C	752,10 €	895 €		
		3000K	E	2010lm	AN3112C				
		4000K	E	2080lm	AN3189C				
	Reflektor Kristall reflector crystal	TRIAC	20 W	2700K	F	1910lm	AN3121	781,51 €	930 €
				3000K	E	2010lm	AN3122		
				4000K <span style="background-color: #0070C0; color: white; padding: 2px;">new</span>	E	2080lm	AN3191		
		DALI	27 W	2700K	F	2900lm	AN3125	815,13 €	970 €
				3000K	F	2750lm	AN3126		
				4000K <span style="background-color: #0070C0; color: white; padding: 2px;">new</span>	E	2910lm	AN3192		
CASAMBI <span style="background-color: #0070C0; color: white; padding: 2px;">new</span>	20 W	2700K	F	1910lm	AN3121C	861,34 €	1.025 €		
		3000K	E	2010lm	AN3122C				
		4000K	E	2080lm	AN3191C				

- IP20 protection class
-  through wiring
-  tube cuttable
-  + length option
-  emergency light option
-  individual

- LED
-  dimmable
-  CRI >97
-  SDCM 3

# ANNEX Suspension L new

Abbildung figure	Beschreibung description	Regelung control	Leistung power	CCT	EK EEC	Lumen lumen	Art.-Nr. art.-no.	€ netto DE excl. VAT	€ brutto DE incl. VAT
	<b>Reflektor opal</b> reflector opal	TRIAC	34 W	2700 K	F	3510lm	AN3147	710,08 €	845 €
				3000 K	E	3710lm	AN3148		
				4000 K <span style="background-color: #0070C0; color: white; padding: 2px;">new</span>	E	3830lm	AN3193		
		DALI	41 W	2700 K	F	4060lm	AN3151	752,10 €	895 €
				3000 K	E	4270lm	AN3152		
				4000 K <span style="background-color: #0070C0; color: white; padding: 2px;">new</span>	E	4410lm	AN3194		
		CASAMBI <span style="background-color: #0070C0; color: white; padding: 2px;">new</span>	34 W	2700 K	F	3510lm	AN3147C	794,12 €	945 €
				3000 K	E	3710lm	AN3148C		
				4000 K	E	3830lm	AN3193C		
	<b>Reflektor poliert</b> reflector polished	TRIAC	34 W	2700 K	F	3510lm	AN3153	752,10 €	895 €
				3000 K	E	3710lm	AN3154		
				4000 K <span style="background-color: #0070C0; color: white; padding: 2px;">new</span>	E	3830lm	AN3195		
		DALI	41 W	2700 K	F	4060lm	AN3157	798,32 €	950 €
				3000 K	E	4270lm	AN3158		
				4000 K <span style="background-color: #0070C0; color: white; padding: 2px;">new</span>	E	4410lm	AN3196		
		CASAMBI <span style="background-color: #0070C0; color: white; padding: 2px;">new</span>	34 W	2700 K	F	3510lm	AN3153C	836,13 €	995 €
				3000 K	E	3710lm	AN3154C		
				4000 K	E	3830lm	AN3195C		
	<b>Reflektor Kristall</b> reflector crystal	TRIAC	34 W	2700 K	F	3510lm	AN3141	920,17 €	1.095 €
				3000 K	E	3710lm	AN3142		
				4000 K <span style="background-color: #0070C0; color: white; padding: 2px;">new</span>	E	3830lm	AN3197		
		DALI	41 W	2700 K	F	4060lm	AN3145	962,18 €	1.145 €
				3000 K	E	4270lm	AN3146		
				4000 K <span style="background-color: #0070C0; color: white; padding: 2px;">new</span>	E	4410lm	AN3198		
		CASAMBI <span style="background-color: #0070C0; color: white; padding: 2px;">new</span>	34 W	2700 K	F	3510lm	AN3141C	1.004,20 €	1.195 €
				3000 K	E	3710lm	AN3142C		
				4000 K	E	3830lm	AN3197C		

-  **IP20**  
protection class
-  **through wiring**
-  **tube cuttable**
-  **+ length option**
-  **emergency light option**
-  **battery option**
-  **individual**

-  **LED**
-  **dimmable**
-  **Zhaga standard**
-  **CRI >97**
-  **SDCM 3**

# APP Wall

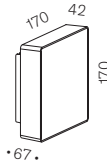

## APP Wall

Abbildung figure	Beschreibung description	Regelung control	Leistung power	CCT	EEL EEC	Lumen lumen	Art.-Nr. art.-no.	€ netto DE excl. VAT	€ brutto DE incl. VAT	
	<b>Leuchteneinheit APP</b> lighting unit APP	TRIAC	16 W	2700 K	E	1930 lm	AP1001	294,12 €	350 €	
				3000 K	E	1970 lm	AP1002			
		DALI	22 W	2700 K	E	2750 lm	AP1005	336,13 €	400 €	
				3000 K	E	2810 lm	AP1006			
	<b>Front Rippe</b> front ribbed						AP1101			
	<b>Front Pyramide</b> front pyramid						AP1102			
	<b>Front Wabe</b> front honeycomb						AP1103			
	<b>Front Eiskristall</b> front cracked ice						AP1104	84,03 €	100 €	
	<b>Front Weiß</b> front white						AP1105			
	<b>Front Grau</b> front grey						AP1107			
	<b>Front fluoreszierend Grün</b> front fluorescent green						AP1108			
	<b>Front Echtglasspiegel</b> front genuine glass mirror						AP1106	105,04 €	125 €	
	<b>IP40</b>						<b>LED</b>			
modular article	protection class	through wiring	individual					dimnable	CRI >90	SDCM 3

## Zubehör/Accessories

Abbildung figure	Beschreibung description	Art.-Nr. art.-no.	€ netto DE excl. VAT	€ brutto DE incl. VAT
	<b>Spiegeladapter Set</b> mirror adapter set	ZB1001	37,82 €	45 €

# CAVITY Ceiling

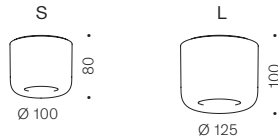

## CAVITY Ceiling S Linse 46° new

Abbildung figure	Beschreibung description	Regelung control	Leistung power	CCT	EEK EEC	Lumen lumen	Art.-Nr. art.-no.	€ netto DE excl. VAT	€ brutto DE incl. VAT
●	schwarz black	TRIAC	10W	2700K	E	950lm	CA1001L	214,29 €	255 €
				3000K	E	1000lm	CA1002L		
		DALI <span style="color: blue; font-weight: bold;">new</span>	10W	2700K	E	950lm	CA1011L	260,50 €	310 €
				3000K	E	1000lm	CA1012L		
		CASAMBI <span style="color: blue; font-weight: bold;">new</span>	10W	2700K	E	950lm	CA1011LC	294,12 €	350 €
				3000K	E	1000lm	CA1012LC		
○	weiß white	TRIAC	10W	2700K	E	950lm	CA1003L	214,29 €	255 €
				3000K	E	1000lm	CA1004L		
		DALI <span style="color: blue; font-weight: bold;">new</span>	10W	2700K	E	950lm	CA1013L	260,50 €	310 €
				3000K	E	1000lm	CA1014L		
		CASAMBI <span style="color: blue; font-weight: bold;">new</span>	10W	2700K	E	950lm	CA1013LC	294,12 €	350 €
				3000K	E	1000lm	CA1014LC		
●	Aluminiumglanz finish aluminum gloss finish	TRIAC	10W	2700K	E	950lm	CA1005L	247,90 €	295 €
				3000K	E	1000lm	CA1006L		
		DALI <span style="color: blue; font-weight: bold;">new</span>	10W	2700K	E	950lm	CA1015L	281,51 €	335 €
				3000K	E	1000lm	CA1016L		
		CASAMBI <span style="color: blue; font-weight: bold;">new</span>	10W	2700K	E	950lm	CA1005LC	323,53 €	385 €
				3000K	E	1000lm	CA1006LC		
●	Bronze finish bronze finish	TRIAC	10W	2700K	E	950lm	CA1007L	247,90 €	295 €
				3000K	E	1000lm	CA1008L		
		DALI <span style="color: blue; font-weight: bold;">new</span>	10W	2700K	E	950lm	CA1017L	281,51 €	335 €
				3000K	E	1000lm	CA1018L		
		CASAMBI <span style="color: blue; font-weight: bold;">new</span>	10W	2700K	E	950lm	CA1007LC	323,53 €	385 €
				3000K	E	1000lm	CA1008LC		

IP40  
protection  
class

glass  
lens

individual

LED

dimmable

Zhaga  
standard

CRI >97

SDCM 2

## CAVITY Ceiling S new

Abbildung figure	Beschreibung description	Regelung control	Leistung power	CCT	EEL EEC	Lumen lumen	Art.-Nr. art.-no.	€ netto DE excl. VAT	€ brutto DE incl. VAT
●	schwarz black	TRIAC	10 W	2700 K	F	950 lm	CA1001	193,28 €	230 €
				3000 K	E	1000 lm	CA1002		
		DALI <span style="color: blue;">new</span>	10 W	2700 K	F	950 lm	CA1011	239,50 €	285 €
				3000 K	E	1000 lm	CA1012		
		CASAMBI <span style="color: blue;">new</span>	10 W	2700 K	F	950 lm	CA1011C	285,71 €	340 €
				3000 K	E	1000 lm	CA1012C		
○	weiß white	TRIAC	10 W	2700 K	F	950 lm	CA1003	193,28 €	230 €
				3000 K	E	1000 lm	CA1004		
		DALI <span style="color: blue;">new</span>	10 W	2700 K	F	950 lm	CA1013	239,50 €	285 €
				3000 K	E	1000 lm	CA1014		
		CASAMBI <span style="color: blue;">new</span>	10 W	2700 K	F	950 lm	CA1013C	285,71 €	340 €
				3000 K	E	1000 lm	CA1014C		
●	Aluminiumglanz finish aluminum gloss finish	TRIAC	10 W	2700 K	F	950 lm	CA1005	226,89 €	270 €
				3000 K	E	1000 lm	CA1006		
		DALI <span style="color: blue;">new</span>	10 W	2700 K	F	950 lm	CA1015	260,50 €	310 €
				3000 K	E	1000 lm	CA1016		
		CASAMBI <span style="color: blue;">new</span>	10 W	2700 K	F	950 lm	CA1015C	319,33 €	380 €
				3000 K	E	1000 lm	CA1016C		
●	Bronze finish bronze finish	TRIAC	10 W	2700 K	F	950 lm	CA1007	226,89 €	270 €
				3000 K	E	1000 lm	CA1008		
		DALI <span style="color: blue;">new</span>	10 W	2700 K	F	950 lm	CA1017	260,50 €	310 €
				3000 K	E	1000 lm	CA1018		
		CASAMBI <span style="color: blue;">new</span>	10 W	2700 K	F	950 lm	CA1017C	323,53 €	385 €
				3000 K	E	1000 lm	CA1018C		

IP40  
protection  
class

 glass  
diffusor

 individual

LED

 dimmable

 Zhaga  
standard

 CRI >97

 SDCM 2

## CAVITY Ceiling L Linse 60° new

Abbildung figure	Beschreibung description	Regelung control	Leistung power	CCT	EEL EEC	Lumen lumen	Art.-Nr. art.-no.	€ netto DE excl. VAT	€ brutto DE incl. VAT
●	schwarz black	TRIAC	20 W	2700 K	E	1910 lm	CA2001L	273,11 €	325 €
				3000 K	E	2010 lm	CA2002L		
		DALI	20 W	2700 K	E	1910 lm	CA2005L	323,53 €	385 €
				3000 K	E	2010 lm	CA2006L		
		CASAMBI <span style="color: blue;">new</span>	20 W	2700 K	E	1910 lm	CA2005LC	352,94 €	420 €
				3000 K	E	2010 lm	CA2006LC		
○	weiß white	TRIAC	20 W	2700 K	E	1910 lm	CA2007L	273,11 €	325 €
				3000 K	E	2010 lm	CA2008L		
		DALI	20 W	2700 K	E	1910 lm	CA2011L	323,53 €	385 €
				3000 K	E	2010 lm	CA2012L		
		CASAMBI <span style="color: blue;">new</span>	20 W	2700 K	E	1910 lm	CA2011LC	352,94 €	420 €
				3000 K	E	2010 lm	CA2012LC		
●	Aluminiumglanz finish aluminum gloss finish	TRIAC	20 W	2700 K	E	1910 lm	CA2013L	310,92 €	370 €
				3000 K	E	2010 lm	CA2014L		
		DALI	20 W	2700 K	E	1910 lm	CA2017L	365,55 €	435 €
				3000 K	E	2010 lm	CA2018L		
		CASAMBI <span style="color: blue;">new</span>	20 W	2700 K	E	1910 lm	CA2017LC	390,76 €	465 €
				3000 K	E	2010 lm	CA2018LC		

Abbildung figure	Beschreibung description	Regelung control	Leistung power	CCT	E EK EEC	Lumen lumen	Art.-Nr. art.-no.	€ netto DE excl. VAT	€ brutto DE incl. VAT
●	<b>Bronze finish</b> bronze finish	TRIAC	20W	2700K	E	1910lm	CA2019L	310,92 €	370 €
				3000K	E	2010lm	CA2020L		
		DALI	20W	2700K	E	1910lm	CA2023L	365,55 €	435 €
				3000K	E	2010lm	CA2024L		
		CASAMBI <small>new</small>	20W	2700K	E	1910lm	CA2023LC	390,76 €	465 €
				3000K	E	2010lm	CA2024LC		

IP40 protection class  
 through wiring  
 glass lens  
 emergency light option  
 individual

LED  
 dimmable  
 Zhaga standard  
 CRI >97  
 SDCM 2

## CAVITY Ceiling L new

Abbildung figure	Beschreibung description	Regelung control	Leistung power	CCT	E EK EEC	Lumen lumen	Art.-Nr. art.-no.	€ netto DE excl. VAT	€ brutto DE incl. VAT
●	<b>schwarz</b> black	TRIAC	20W	2700K	F	1910lm	CA2001	252,10 €	300 €
				3000K	E	2010lm	CA2002		
		DALI	20W	2700K	F	1910lm	CA2005	302,52 €	360 €
				3000K	E	2010lm	CA2006		
		CASAMBI <small>new</small>	20W	2700K	F	1910lm	CA2005C	352,94 €	420 €
				3000K	E	2010lm	CA2006C		
○	<b>weiß</b> white	TRIAC	20W	2700K	F	1910lm	CA2007	252,10 €	300 €
				3000K	E	2010lm	CA2008		
		DALI	20W	2700K	F	1910lm	CA2011	302,52 €	360 €
				3000K	E	2010lm	CA2012		
		CASAMBI <small>new</small>	20W	2700K	F	1910lm	CA2011C	352,94 €	420 €
				3000K	E	2010lm	CA2012C		
●	<b>Aluminiumglanz finish</b> aluminum gloss finish	TRIAC	20W	2700K	F	1910lm	CA2013	289,92 €	345 €
				3000K	E	2010lm	CA2014		
		DALI	20W	2700K	F	1910lm	CA2017	344,54 €	410 €
				3000K	E	2010lm	CA2018		
		CASAMBI <small>new</small>	20W	2700K	F	1910lm	CA2017C	390,76 €	465 €
				3000K	E	2010lm	CA2018C		
●	<b>Bronze finish</b> bronze finish	TRIAC	20W	2700K	F	1910lm	CA2019	289,92 €	345 €
				3000K	E	2010lm	CA2020		
		DALI	20W	2700K	F	1910lm	CA2023	344,54 €	410 €
				3000K	E	2010lm	CA2024		
		CASAMBI <small>new</small>	20W	2700K	F	1910lm	CA2023C	390,76 €	465 €
				3000K	E	2010lm	CA2024C		

IP40 protection class  
 through wiring  
 glass diffuser  
 emergency light option  
 individual

LED  
 dimmable  
 Zhaga standard  
 CRI >97  
 SDCM 2

# CAVITY Recessed

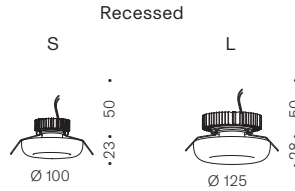

## CAVITY Recessed S Linse 46° new

Abbildung figure	Beschreibung description	Regelung control	Leistung power	CCT	EEL EEC	Lumen lumen	Art.-Nr. art.-no.	€ netto DE excl. VAT	€ brutto DE incl. VAT
●	schwarz black	TRIAC	12 W	2700K	E	1120lm	CA1301L	201,68 €	240 €
				3000K	E	1190lm	CA1302L		
		DALI <span style="color: blue; font-weight: bold;">new</span>	12 W	2700K	E	1120lm	CA1311L	239,50 €	285 €
				3000K	E	1190lm	CA1312L		
		CASAMBI <span style="color: blue; font-weight: bold;">new</span>	12 W	2700K	E	1120lm	CA1301LC	281,51 €	335 €
				3000K	E	1190lm	CA1302LC		
○	weiß white	TRIAC	12 W	2700K	E	1120lm	CA1303L	201,68 €	240 €
				3000K	E	1190lm	CA1304L		
		DALI <span style="color: blue; font-weight: bold;">new</span>	12 W	2700K	E	1120lm	CA1313L	239,50 €	285 €
				3000K	E	1190lm	CA1314L		
		CASAMBI <span style="color: blue; font-weight: bold;">new</span>	12 W	2700K	E	1120lm	CA1303LC	281,51 €	335 €
				3000K	E	1190lm	CA1304LC		
●	Aluminiumglanz finish aluminum gloss finish	TRIAC	12 W	2700K	E	1120lm	CA1305L	231,09 €	275 €
				3000K	E	1190lm	CA1306L		
		DALI <span style="color: blue; font-weight: bold;">new</span>	12 W	2700K	E	1120lm	CA1315L	264,71 €	315 €
				3000K	E	1190lm	CA1316L		
		CASAMBI <span style="color: blue; font-weight: bold;">new</span>	12 W	2700K	E	1120lm	CA1305LC	306,72 €	365 €
				3000K	E	1190lm	CA1306LC		
●	Bronze finish bronze finish	TRIAC	12 W	2700K	E	1120lm	CA1307L	231,09 €	275 €
				3000K	E	1190lm	CA1308L		
		DALI <span style="color: blue; font-weight: bold;">new</span>	12 W	2700K	E	1120lm	CA1317L	264,71 €	315 €
				3000K	E	1190lm	CA1318L		
		CASAMBI <span style="color: blue; font-weight: bold;">new</span>	12 W	2700K	E	1120lm	CA1307LC	306,72 €	365 €
				3000K	E	1190lm	CA1308LC		

IP40 protection class  
 through wiring  
 glass lens  
 cut 80mm  
 driver included  
 emergency light option  
 individual

LED LED  
 dimmable  
 Zhaga standard  
 CRI >97  
 SDCM 2

## CAVITY Recessed S new

Abbildung figure	Beschreibung description	Regelung control	Leistung power	CCT	EEL EEC	Lumen lumen	Art.-Nr. art.-no.	€ netto DE excl. VAT	€ brutto DE incl. VAT
●	schwarz black	TRIAC	12 W	2700 K	F	1120 lm	CA1301	180,67 €	215 €
				3000 K	E	1190 lm	CA1302		
		DALI <span style="color: #0070C0;">new</span>	12 W	2700 K	F	1120 lm	CA1311	214,29 €	255 €
				3000 K	E	1190 lm	CA1312		
		CASAMBI <span style="color: #0070C0;">new</span>	12 W	2700 K	F	1120 lm	CA1311C	260,50 €	310 €
				3000 K	E	1190 lm	CA1312C		
○	weiß white	TRIAC	12 W	2700 K	F	1120 lm	CA1303	180,67 €	215 €
				3000 K	E	1190 lm	CA1304		
		DALI <span style="color: #0070C0;">new</span>	12 W	2700 K	F	1120 lm	CA1313	214,29 €	255 €
				3000 K	E	1190 lm	CA1314		
		CASAMBI <span style="color: #0070C0;">new</span>	12 W	2700 K	F	1120 lm	CA1313C	260,50 €	310 €
				3000 K	E	1190 lm	CA1314C		
●	Aluminiumglanz finish aluminum gloss finish	TRIAC	12 W	2700 K	F	1120 lm	CA1305	205,88 €	245 €
				3000 K	E	1190 lm	CA1306		
		DALI <span style="color: #0070C0;">new</span>	12 W	2700 K	F	1120 lm	CA1315	243,70 €	290 €
				3000 K	E	1190 lm	CA1316		
		CASAMBI <span style="color: #0070C0;">new</span>	12 W	2700 K	F	1120 lm	CA1315C	285,71 €	340 €
				3000 K	E	1190 lm	CA1316C		
●	Bronze finish bronze finish	TRIAC	12 W	2700 K	F	1120 lm	CA1307	205,88 €	245 €
				3000 K	E	1190 lm	CA1308		
		DALI <span style="color: #0070C0;">new</span>	12 W	2700 K	F	1120 lm	CA1317	243,70 €	290 €
				3000 K	E	1190 lm	CA1318		
		CASAMBI <span style="color: #0070C0;">new</span>	12 W	2700 K	F	1120 lm	CA1317C	285,71 €	340 €
				3000 K	E	1190 lm	CA1318C		







 IP40 protection class  
 through wiring  
 glass diffuser  
 cut 80 mm  
 driver included  
 emergency light option  
 individual

 LED  
 dimmable  
 Zhaga standard  
 CRI >97  
 SDCM 2





## CAVITY Recessed L Linse 60° new

Abbildung figure	Beschreibung description	Regelung control	Leistung power	CCT	EEL EEC	Lumen lumen	Art.-Nr. art.-no.	€ netto DE excl. VAT	€ brutto DE incl. VAT
●	schwarz black	TRIAC	20 W	2700 K	E	1910 lm	CA2301L	260,50 €	310 €
				3000 K	E	2010 lm	CA2302L		
		DALI	20 W	2700 K	E	1910 lm	CA2305L	310,92 €	370 €
				3000 K	E	2010 lm	CA2306L		
		CASAMBI <span style="color: #0070C0;">new</span>	20 W	2700 K	E	1910 lm	CA2301LC	340,34 €	405 €
				3000 K	E	2010 lm	CA2302LC		
○	weiß white	TRIAC	20 W	2700 K	E	1910 lm	CA2307L	260,50 €	310 €
				3000 K	E	2010 lm	CA2308L		
		DALI	20 W	2700 K	E	1910 lm	CA2311L	310,92 €	370 €
				3000 K	E	2010 lm	CA2312L		
		CASAMBI <span style="color: #0070C0;">new</span>	20 W	2700 K	E	1910 lm	CA2307LC	340,34 €	405 €
				3000 K	E	2010 lm	CA2308LC		
●	Aluminiumglanz finish aluminum gloss finish	TRIAC	20 W	2700 K	E	1910 lm	CA2313L	298,32 €	355 €
				3000 K	E	2010 lm	CA2314L		
		DALI	20 W	2700 K	E	1910 lm	CA2317L	352,94 €	420 €
				3000 K	E	2010 lm	CA2318L		
		CASAMBI <span style="color: #0070C0;">new</span>	20 W	2700 K	E	1910 lm	CA2313LC	378,15 €	450 €
				3000 K	E	2010 lm	CA2314LC		

Abbildung figure	Beschreibung description	Regelung control	Leistung power	CCT	EEL EEC	Lumen lumen	Art.-Nr. art.-no.	€ netto DE excl. VAT	€ brutto DE incl. VAT
	<b>Bronze finish</b> bronze finish	TRIAC	20 W	2700 K	E	1910 lm	CA2319L	298,32 €	355 €
				3000 K	E	2010 lm	CA2320L		
		DALI	20 W	2700 K	E	1910 lm	CA2323L	352,94 €	420 €
				3000 K	E	2010 lm	CA2324L		
		CASAMBI <b>new</b>	20 W	2700 K	E	1910 lm	CA2319LC	378,15 €	450 €
				3000 K	E	2010 lm	CA2320LC		

 IP40 protection class	 through wiring	 glass lens	 cut 100 mm	 driver included	 emergency light option	 battery option	 individual	<b>LED</b>	 dimmable	 Zhaga standard	 CRI >97	 SDCM 2
--	--	--	--	---	--	--	--	------------	--	--	---	--

## CAVITY Recessed L **new**

Abbildung figure	Beschreibung description	Regelung control	Leistung power	CCT	EEL EEC	Lumen lumen	Art.-Nr. art.-no.	€ netto DE excl. VAT	€ brutto DE incl. VAT
	<b>schwarz</b> black	TRIAC	20 W	2700 K	F	1910 lm	CA2301	239,50 €	285 €
				3000 K	E	2010 lm	CA2302		
		DALI	20 W	2700 K	F	1910 lm	CA2305	289,92 €	345 €
				3000 K	E	2010 lm	CA2306		
		CASAMBI <b>new</b>	20 W	2700 K	F	1910 lm	CA2305C	315,13 €	375 €
				3000 K	E	2010 lm	CA2306C		
	<b>weiß</b> white	TRIAC	20 W	2700 K	F	1910 lm	CA2307	239,50 €	285 €
				3000 K	E	2010 lm	CA2308		
		DALI	20 W	2700 K	F	1910 lm	CA2311	289,92 €	345 €
				3000 K	E	2010 lm	CA2312		
		CASAMBI <b>new</b>	20 W	2700 K	F	1910 lm	CA2311C	315,13 €	375 €
				3000 K	E	2010 lm	CA2312C		
	<b>Aluminiumglanz finish</b> aluminum gloss finish	TRIAC	20 W	2700 K	F	1910 lm	CA2313	277,31 €	330 €
				3000 K	E	2010 lm	CA2314		
		DALI	20 W	2700 K	F	1910 lm	CA2317	327,73 €	390 €
				3000 K	E	2010 lm	CA2318		
		CASAMBI <b>new</b>	20 W	2700 K	F	1910 lm	CA2317C	357,14 €	425 €
				3000 K	E	2010 lm	CA2318C		
	<b>Bronze finish</b> bronze finish	TRIAC	20 W	2700 K	F	1910 lm	CA2319	277,31 €	330 €
				3000 K	E	2010 lm	CA2320		
		DALI	20 W	2700 K	F	1910 lm	CA2323	327,73 €	390 €
				3000 K	E	2010 lm	CA2324		
		CASAMBI <b>new</b>	20 W	2700 K	F	1910 lm	CA2323C	357,14 €	425 €
				3000 K	E	2010 lm	CA2324C		

 IP40 protection class	 through wiring	 glass diffuser	 cut 100 mm	 driver included	 emergency light option	 battery option	 individual	<b>LED</b>	 dimmable	 Zhaga standard	 CRI >97	 SDCM 2
--	--	--	--	---	--	--	--	------------	--	--	---	--

# CAVITY Suspension

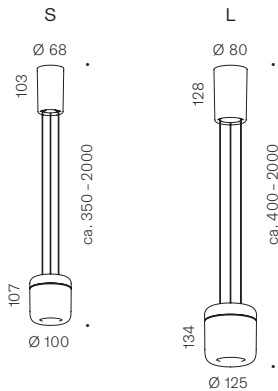

**Winkeladapter für Dachschrägen in weiß oder schwarz erhältlich – Montagehilfe für einfache Installation. Der Winkel kann individuell angefertigt werden – Sonderfarben auf Anfrage. Bestellungen (Art.-Nr.: weiß ZB1013, schwarz ZB1014) bitte in Abstimmung mit dem Vertrieb.**

Angle brackets for sloping roofs available in white or black - to assist with easy installation. The brackets can be made to measure - special colours available on request.

Please coordinate orders (art.-no.: white ZB1013, black ZB1014) with the sales department.

## CAVITY Suspension S new

Abbildung figure	Beschreibung description	Regelung control	Leistung power	CCT	EEL EEC	Lumen lumen	Art.-Nr. art.-no.	€ netto DE excl. VAT	€ brutto DE incl. VAT
●	schwarz black	TRIAC	12 W	2700 K	F	950 lm	CA1101	344,54 €	410 €
				3000 K	E	1000 lm	CA1102		
		DALI <span style="color: blue;">new</span>	12 W	2700 K	F	950 lm	CA1111	386,55 €	460 €
				3000 K	E	1000 lm	CA1112		
		CASAMBI <span style="color: blue;">new</span>	12 W	2700 K	F	950 lm	CA1101C	420,17 €	500 €
				3000 K	E	1000 lm	CA1102C		
○	weiß white	TRIAC	12 W	2700 K	F	950 lm	CA1103	344,54 €	410 €
				3000 K	E	1000 lm	CA1104		
		DALI <span style="color: blue;">new</span>	12 W	2700 K	F	950 lm	CA1113	386,55 €	460 €
				3000 K	E	1000 lm	CA1114		
		CASAMBI <span style="color: blue;">new</span>	12 W	2700 K	F	950 lm	CA1103C	420,17 €	500 €
				3000 K	E	1000 lm	CA1104C		
●	Aluminiumglanz finish aluminum gloss finish	TRIAC	12 W	2700 K	F	950 lm	CA1105	411,76 €	490 €
				3000 K	E	1000 lm	CA1106		
		DALI <span style="color: blue;">new</span>	12 W	2700 K	F	950 lm	CA1115	457,98 €	545 €
				3000 K	E	1000 lm	CA1116		
		CASAMBI <span style="color: blue;">new</span>	12 W	2700 K	F	950 lm	CA1105C	491,60 €	585 €
				3000 K	E	1000 lm	CA1106C		
●	Bronze finish bronze finish	TRIAC	12 W	2700 K	F	950 lm	CA1107	411,76 €	490 €
				3000 K	E	1000 lm	CA1108		
		DALI <span style="color: blue;">new</span>	12 W	2700 K	F	950 lm	CA1117	457,98 €	545 €
				3000 K	E	1000 lm	CA1118		
		CASAMBI <span style="color: blue;">new</span>	12 W	2700 K	F	950 lm	CA1107C	491,60 €	585 €
				3000 K	E	1000 lm	CA1108C		

IP40  
protection class

glass diffuser

LED

dimmable

Zhaga standard

CRI >97

SDCM 2

# CAVITY Suspension L new

Abbildung figure	Beschreibung description	Regelung control	Leistung power	CCT	E EK EEC	Lumen lumen	Art.-Nr. art.-no.	€ netto DE excl. VAT	€ brutto DE incl. VAT
●	<b>schwarz</b> black	TRIAC	20 W	2700 K	F	1910lm	CA2101	478,99 €	570 €
				3000 K	E	2010lm	CA2102		
		DALI <span style="color: blue; font-weight: bold;">new</span>	20 W	2700 K	F	1910lm	CA2105	533,61 €	635 €
				3000 K	E	2010lm	CA2106		
		CASAMBI <span style="color: blue; font-weight: bold;">new</span>	20 W	2700 K	F	1910lm	CA2101C	563,03 €	670 €
				3000 K	E	2010lm	CA2102C		
○	<b>weiß</b> white	TRIAC	20 W	2700 K	F	1910lm	CA2107	478,99 €	570 €
				3000 K	E	2010lm	CA2108		
		DALI <span style="color: blue; font-weight: bold;">new</span>	20 W	2700 K	F	1910lm	CA2111	533,61 €	635 €
				3000 K	E	2010lm	CA2112		
		CASAMBI <span style="color: blue; font-weight: bold;">new</span>	20 W	2700 K	F	1910lm	CA2107C	563,03 €	670 €
				3000 K	E	2010lm	CA2108C		
●	<b>Aluminiumglanz finish</b> aluminum gloss finish	TRIAC	20 W	2700 K	F	1910lm	CA2113	571,43 €	680 €
				3000 K	E	2010lm	CA2114		
		DALI <span style="color: blue; font-weight: bold;">new</span>	20 W	2700 K	F	1910lm	CA2117	626,05 €	745 €
				3000 K	E	2010lm	CA2118		
		CASAMBI <span style="color: blue; font-weight: bold;">new</span>	20 W	2700 K	F	1910lm	CA2113C	651,26 €	775 €
				3000 K	E	2010lm	CA2114C		
●	<b>Bronze finish</b> bronze finish	TRIAC	20 W	2700 K	F	1910lm	CA2119	571,43 €	680 €
				3000 K	E	2010lm	CA2120		
		DALI <span style="color: blue; font-weight: bold;">new</span>	20 W	2700 K	F	1910lm	CA2123	626,05 €	745 €
				3000 K	E	2010lm	CA2124		
		CASAMBI <span style="color: blue; font-weight: bold;">new</span>	20 W	2700 K	F	1910lm	CA2119C	651,26 €	775 €
				3000 K	E	2010lm	CA2120C		

IP40  
protection class

 glass diffuser

LED

 dimmable

 Zhaga standard

 CRI >97



 SDCM 2

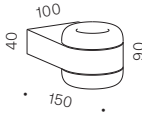



# CAVITY Wall



## CAVITY Wall S Linse 46° new

Abbildung figure	Beschreibung description	Regelung control	Leistung power	CCT	EEK EEC	Lumen lumen	Art.-Nr. art.-no.	€ netto DE excl. VAT	€ brutto DE incl. VAT
●	schwarz black	TRIAC	20W	2700K	E	1900lm	CA2401	315,13 €	375 €
				3000K	E	2000lm	CA2402		
		DALI <span style="color: #0070C0;">new</span>	20W	2700K	E	1900lm	CA2411	344,54 €	410 €
				3000K	E	2000lm	CA2412		
		CASAMBI <span style="color: #0070C0;">new</span>	20W	2700K	E	1900lm	CA2401C	424,37 €	505 €
				3000K	E	2000lm	CA2402C		
○	weiß white	TRIAC	20W	2700K	E	1900lm	CA2405	315,13 €	375 €
				3000K	E	2000lm	CA2406		
		DALI <span style="color: #0070C0;">new</span>	20W	2700K	E	1900lm	CA2415	344,54 €	410 €
				3000K	E	2000lm	CA2416		
		CASAMBI <span style="color: #0070C0;">new</span>	20W	2700K	E	1900lm	CA2405C	424,37 €	505 €
				3000K	E	2000lm	CA2406C		
○ ●	schwarz/weiß black/white	TRIAC	20W	2700K	E	1900lm	CA2461	315,13 €	375 €
				3000K	E	2000lm	CA2462		
		DALI <span style="color: #0070C0;">new</span>	20W	2700K	E	1900lm	CA2471	344,54 €	410 €
				3000K	E	2000lm	CA2472		
		CASAMBI <span style="color: #0070C0;">new</span>	20W	2700K	E	1900lm	CA2461C	424,37 €	505 €
				3000K	E	2000lm	CA2462C		
● ●	schwarz/aluminiumglanz finish black/aluminum gloss finish	TRIAC	20W	2700K	E	1900lm	CA2441	361,34 €	430 €
				3000K	E	2000lm	CA2442		
		DALI <span style="color: #0070C0;">new</span>	20W	2700K	E	1900lm	CA2451	386,55 €	460 €
				3000K	E	2000lm	CA2452		
		CASAMBI <span style="color: #0070C0;">new</span>	20W	2700K	E	1900lm	CA2441C	445,38 €	530 €
				3000K	E	2000lm	CA2442C		
● ●	schwarz/Bronze finish black/ bronze finish	TRIAC	20W	2700K	E	1900lm	CA2421	361,34 €	430 €
				3000K	E	2000lm	CA2422		
		DALI <span style="color: #0070C0;">new</span>	20W	2700K	E	1900lm	CA2431	386,55 €	460 €
				3000K	E	2000lm	CA2432		
		CASAMBI <span style="color: #0070C0;">new</span>	20W	2700K	E	1900lm	CA2421C	445,38 €	530 €
				3000K	E	2000lm	CA2422C		
● ○	weiß/schwarz white/white	TRIAC	20W	2700K	E	1900lm	CA2465	315,13 €	375 €
				3000K	E	2000lm	CA2466		
		DALI <span style="color: #0070C0;">new</span>	20W	2700K	E	1900lm	CA2475	344,54 €	410 €
				3000K	E	2000lm	CA2476		
		CASAMBI <span style="color: #0070C0;">new</span>	20W	2700K	E	1900lm	CA2465C	424,37 €	505 €
				3000K	E	2000lm	CA2466C		

Abbildung figure	Beschreibung description	Regelung control	Leistung power	CCT	EEL EEC	Lumen lumen	Art.-Nr. art.-no.	€ netto DE excl. VAT	€ brutto DE incl. VAT
	<b>weiß/aluminiumglanz finish</b> white/aluminum gloss finish	TRIAC	20 W	2700 K	E	1900 lm	CA2445	361,34 €	430 €
				3000 K	E	2000 lm	CA2446		
		DALI <small>new</small>	20 W	2700 K	E	1900 lm	CA2455	386,55 €	460 €
				3000 K	E	2000 lm	CA2456		
		CASAMBI <small>new</small>	20 W	2700 K	E	1900 lm	CA2445C	445,38 €	530 €
				3000 K	E	2000 lm	CA2446C		
	<b>weiß/ Bronze finish</b> white/bronze finish	TRIAC	20 W	2700 K	E	1900 lm	CA2425	361,34 €	430 €
				3000 K	E	2000 lm	CA2426		
		DALI <small>new</small>	20 W	2700 K	E	1900 lm	CA2435	386,55 €	460 €
				3000 K	E	2000 lm	CA2436		
		CASAMBI <small>new</small>	20 W	2700 K	E	1900 lm	CA2425C	445,38 €	530 €
				3000 K	E	2000 lm	CA2426C		

 IP40  
protection class
  through wiring
  glass lens
  individual

LED
  dimmable
  Zhaga standard
  CRI >97
  SDCM 2

# CLUB Floor

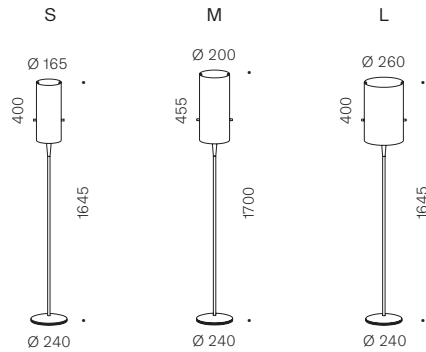

## CLUB Floor

Abbildung figure	Beschreibung description	Regelung control	Leistung power	CCT	EEL EEC	Lumen lumen	Art.-Nr. art.-no.	€ netto DE excl. VAT	€ brutto DE incl. VAT
	<b>S gebürstet, Chintz weiß</b> S brushed, Chintz white	integr.	20 W	2700 K	F	2060 lm	CL2101		
	<b>S schwarz, Chintz weiß</b> S black, Chintz white	integr.	20 W	2700 K	F	2060 lm	CL2102		
	<b>S gebürstet, Melange grau</b> S brushed, Melange grey	integr.	20 W	2700 K	F	2060 lm	CL2103		
	<b>S schwarz, Melange grau</b> S black, Melange grey	integr.	20 W	2700 K	F	2060 lm	CL2104	840,34 €	1.000 €
	<b>M gebürstet, Chintz weiß</b> M brushed, Chintz white	integr.	20 W	2700 K	F	2060 lm	CL2111		
	<b>M schwarz, Chintz weiß</b> M black, Chintz white	integr.	20 W	2700 K	F	2060 lm	CL2112		
	<b>M gebürstet, Melange grau</b> M brushed, Melange grey	integr.	20 W	2700 K	F	2060 lm	CL2113	840,34 €	1.000 €
	<b>M schwarz, Melange grau</b> M black, Melange grey	integr.	20 W	2700 K	F	2060 lm	CL2114		
	<b>L gebürstet, Chintz weiß</b> L brushed, Chintz white	integr.	20 W	2700 K	F	2060 lm	CL2121		
	<b>L schwarz, Chintz weiß</b> L black, Chintz white	integr.	20 W	2700 K	F	2060 lm	CL2122		
	<b>L gebürstet, Melange grau</b> L brushed, Melange grey	integr.	20 W	2700 K	F	2060 lm	CL2123	840,34 €	1.000 €
	<b>L schwarz, Melange grau</b> L black, Melange grey	integr.	20 W	2700 K	F	2060 lm	CL2124		

IP20  
protection  
class

LED



dimmable



Zhaga  
standard



CRI >97



SDCM 2

# CLUB Wall



## CLUB Wall

Abbildung figure	Beschreibung description	Fassung Socket	Regelung control	Leistung power	CCT	EEK EEC	Lumen lumen	Art.-Nr. art.-no.	€ netto DE excl. VAT	€ brutto DE incl. VAT
	<b>gebürstet, Chintz weiß</b> brushed, Chintz white	R7s	TRIAC	15 W	2700 K	E	2000lm	CL1075		
	<b>schwarz, Chintz weiß</b> black, Chintz white	R7s	TRIAC	15 W	2700 K	E	2000lm	CL1065	256,30 €	305 €
	<b>gebürstet, Melange grau</b> brushed, Melange grey	R7s	TRIAC	15 W	2700 K	E	2000lm	CL2131		
	<b>schwarz, Melange grau</b> black, Melange grey	R7s	TRIAC	15 W	2700 K	E	2000lm	CL2132		

IP20  
 protection class

through wiring

lamp included

dimmable

# CRIB Wall

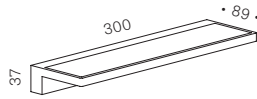

## CRIB Wall

Abbildung figure	Beschreibung description	Regelung control	Leistung power	CCT	EEK EEC	Lumen lumen	Art.-Nr. art.-no.	€ netto DE excl. VAT	€ brutto DE incl. VAT
	<b>schwarz</b> black	TRIAC	12 W	2700 K	F	1260lm	CR1001	386,55 €	460 €
	<b>weiß</b> white	TRIAC	12 W	2700 K	F	1260lm	CR1002		
	<b>Edelstahl finish</b> stainless steel finish	TRIAC	12 W	2700 K	F	1260lm	CR1003	428,57 €	510 €
	<b>Chrom finish</b> chrome finish	TRIAC	12 W	2700 K	F	1260lm	CR1005		

IP20 protection class  
 glass cover

LED dimmable CRI >90 SDCM 3

## Zubehör/Accessories

Abbildung figure	Beschreibung description	Art.-Nr. art.-no.	€ netto DE excl. VAT	€ brutto DE incl. VAT
	<b>Spiegeladapter Set</b> mirror adapter set	ZB1001	37,82 €	45 €

# CURLING Ceiling



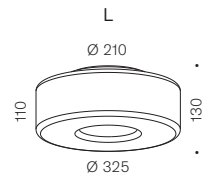
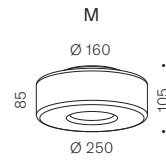
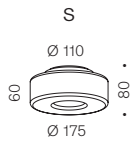
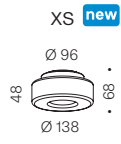



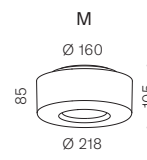
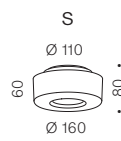
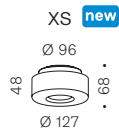

genuine glass







acrylic glass







## CURLING Ceiling XS new

Abbildung figure	Beschreibung description	Regelung control	Leistung power	CCT	EK EEC	Lumen lumen	Art.-Nr. art.-no.	€ netto DE excl. VAT	€ brutto DE incl. VAT
	<b>LIGHT ENGINE</b> Ceiling/Wall XS	TRIAC	8 W	2700 K	E	690 lm	LE015750	130,25 €	155 €
				3000 K	E	710 lm	LE015751		
		DALI	8 W	2700 K	E	690 lm	LE015753	151,26 €	180 €
				3000 K	E	710 lm	LE015754		
		CASAMBI	8 W	2700 K	E	690 lm	LE015753C	214,29 €	255 €
				3000 K	E	710 lm	LE015754C		
	<b>Glas XS klar</b> glass XS clear			<b>mit Optik Glaslinse eng 40°, Fassung Aluminium poliert</b> with optic glass lens narrow 40°, polished aluminium housing		CU014480	159,66 €	190 €	
				<b>mit Optik Glaslinse weit 55°, Fassung Aluminium poliert</b> with optic glass lens wide 55°, socket aluminium polished		CU014481			
	<b>Glas XS klar, Reflektor konisch</b> glass XS clear, reflector conical			<b>mit Echtglas Diffusor</b> with glass diffusor		CU014420	151,26 €	180 €	
	<b>Glas XS klar, Reflektor zylindrisch</b> glass XS clear, reflector cylindrical			<b>mit Echtglas Diffusor</b> with glass diffusor		CU014421			
	<b>Glas XS opal</b> glass XS opal			<b>mit Echtglas Diffusor</b> with glass diffusor		CU014418	134,45 €	160 €	
	<b>Glas XS neusilber</b> glass XS new silver			<b>mit Echtglas Diffusor</b> with glass diffusor		CU014430	205,88 €	245 €	
	<b>Acrylglas XS klar</b> acrylic glass XS clear			<b>mit Echtglas Diffusor</b> with glass diffusor		CU014424	54,62 €	65 €	
	<b>Acrylglas XS klar, Reflektor konisch</b> acrylic glass XS clear, reflector conical			<b>mit Echtglas Diffusor</b> with glass diffusor		CU014426	71,43 €	85 €	
	<b>Acrylglas XS klar, Reflektor zylindrisch</b> acrylic glass XS clear, reflector cylindrical			<b>mit Echtglas Diffusor</b> with glass diffusor		CU014427			

















 modular article  
 IP44 protection class  
 through wiring  
 glass diffusor

 LED  
 dimmable  
 Zhaga standard  
 CRI >97  
 SDCM 2





## CURLING Optik/optic XS new

Abbildung figure	Beschreibung description	Art.-Nr. art.-no.	€ netto DE excl. VAT	€ brutto DE incl. VAT	
	<b>Optik XS Glaslinse eng 40°, Fassung transluzent</b> optic XS glass lens narrow 40°, socket translucent	empfohlen für Ausführungen mit Reflektor recommended for versions with reflector	CU8549	30,25 €	36 €
	<b>Optik XS Glaslinse weit 55°, Fassung transluzent</b> optic XS glass lens wide 55°, socket translucent	empfohlen für Ausführungen mit Reflektor recommended for versions with reflector	CU8548		
	<b>Optik XS Glaslinse eng 40°, Fassung Aluminium poliert</b> optic XS glass lens narrow 40°, socket aluminium polished	empfohlen für Glas/Acrylglas klar recommended for glass/acrylic glass clear	CU8551	40,34 €	48 €
	<b>Optik XS Glaslinse weit 55°, Fassung Aluminium poliert</b> optic XS glass lens wide 55°, socket aluminium polished	empfohlen für Glas/Acrylglas klar recommended for glass/acrylic glass clear	CU8550		
	<b>Optik XS Microprismatik Kegelkuppen 60° entblendet</b> optic XS microprismatic cone domes 60° glare-free	für alle Versionen geeignet suitable for all versions	CU8557	21,85 €	26 €
	<b>Optik XS abgeblendet</b> optic XS deglared	für alle Versionen geeignet suitable for all versions	CU8547	18,49 €	22 €



















## CURLING Ceiling S new

Abbildung figure	Beschreibung description	Regelung control	Leistung power	CCT	EEL EEC	Lumen lumen	Art.-Nr. art.-no.	€ netto DE excl. VAT	€ brutto DE incl. VAT		
	<b>LIGHT ENGINE</b> Ceiling/Wall S	TRIAC	11 W	2700 K	E	1170 lm	LE015701	189,08 €	225 €		
				3000 K	E	1230 lm	LE015702				
				4000 K <span style="color: #0070C0;">new</span>	E	1280 lm	LE015733				
				1800-3000 K dim2warm	F	870 lm	LE015703			226,89 €	270 €
				2700 K	E	1170 lm	LE015730				
				3000 K	E	1230 lm	LE015731				
		4000 K <span style="color: #0070C0;">new</span>	E	1280 lm	LE015734						
		1800-3000 K dim2warm	F	870 lm	LE015732	252,10 €	300 €				
		CASAMBI <span style="color: #0070C0;">new</span>	11 W	2700 K	E	1170 lm	LE015701C	273,11 €	325 €		
				3000 K	E	1230 lm	LE015702C				
				4000 K	E	1280 lm	LE015733C				
				1800-3000 K dim2warm	F	870 lm	LE015703C			315,13 €	375 €
	<b>Glas S klar</b> glass S clear			mit Optik Glaslinse eng 32°, Fassung Aluminium poliert with optic glass lens narrow 32°, socket aluminium polished			CU014482	218,49 €	260 €		
				mit Optik Glaslinse weit 59°, Fassung Aluminium poliert with optic glass lens wide 59°, socket aluminium polished			CU014483				
	<b>Glas S klar, Reflektor konisch</b> glass S clear, reflector conical			mit Echtglas Diffusor with glass diffusor			CU014407	210,08 €	250 €		
	<b>Glas S klar, Reflektor zylindrisch</b> glass S clear, reflector cylindrical			mit Echtglas Diffusor with glass diffusor			CU014408				
	<b>Glas S opal</b> glass S opal			mit Echtglas Diffusor with glass diffusor			CU014405	180,67 €	215 €		
	<b>Glas S neusilber</b> glass S new silver			mit Echtglas Diffusor with glass diffusor			CU011201	268,91 €	320 €		
	<b>Acrylglas S klar</b> acrylic glass S clear			mit Optik Pure (entblendet) with optic Pure (glare-free)			CU011203	79,83 €	95 €		
	<b>Acrylglas S klar, Reflektor konisch</b> acrylic glass S clear, reflector conical			mit Echtglas Diffusor with glass diffusor			CU011204	96,64 €	115 €		
	<b>Acrylglas S klar, Reflektor zylindrisch</b> acrylic glass S clear, reflector cylindrical			mit Echtglas Diffusor with glass diffusor			CU011205				
 <b>IP40</b>	 <b>through wiring</b>			<b>LED</b>			 <b>dimmable</b>	 <b>Zhaga standard</b>	 <b>dim2warm</b>	 <b>CRI &gt;97</b>	 <b>SDCM 2</b>





## CURLING Optik/optic S new

Abbildung figure	Beschreibung description	Art.-Nr. art.-no.	€ netto DE excl. VAT	€ brutto DE incl. VAT	
	<b>Optik S Glaslinse eng 32°, Fassung transluzent</b> optic S glass lens narrow 32°, socket translucent	empfohlen für Ausführungen mit Reflektor recommended for versions with reflector	CU8543	38,66 €	46 €
	<b>Optik S Glaslinse weit 59°, Fassung transluzent</b> optic S glass lens wide 59°, socket translucent	empfohlen für Ausführungen mit Reflektor recommended for versions with reflector	CU8552		
	<b>Optik S Glaslinse eng 32°, Fassung Aluminium poliert</b> optic S glass lens narrow 32°, socket aluminium polished	empfohlen für Glas/Acrylglas klar recommended for glass/acrylic glass clear	CU8545	45,38 €	54 €
	<b>Optik S Glaslinse weit 59°, Fassung Aluminium poliert</b> optic S glass lens wide 59°, socket aluminium polished	empfohlen für Glas/Acrylglas klar recommended for glass/acrylic glass clear	CU8553		
	<b>Optik S Microprismatik Kegeldkuppen 60° entblendet</b> optic S microprismatic cone domes 60° glare-free	für alle Versionen geeignet suitable for all versions	CU8539	25,21 €	30 €
	<b>Optik S abgeblendet</b> optic S deglared	für alle Versionen geeignet suitable for all versions	CU8532	21,01 €	25 €















## CURLING Ceiling M new

Abbildung figure	Beschreibung description	Regelung control	Leistung power	CCT	EEL EEC	Lumen lumen	Art.-Nr. art.-no.	€ netto DE excl. VAT	€ brutto DE incl. VAT					
	<b>LIGHT ENGINE</b> Ceiling/Wall M	TRIAC	20 W	2700 K	F	1910 lm	LE015710	252,10 €	300 €					
				3000 K	E	2010 lm	LE015711							
				4000 K <span style="color: #0070C0;">new</span>	E	2080 lm	LE015770							
				1800-3000 K dim2warm	F	1540 lm	LE015712			252,10 €	300 €			
				2700 K	F	1910 lm	LE015713							
				3000 K	E	2010 lm	LE015714							
		DALI	20 W	4000 K <span style="color: #0070C0;">new</span>	E	2080 lm	LE015771	277,31 €	330 €					
				1800-3000 K dim2warm	F	1540 lm	LE015715			310,92 €	370 €			
				2700 K	F	1910 lm	LE015713C							
				3000 K	E	2010 lm	LE015714C							
				4000 K	E	2080 lm	LE015770C							
				1800-3000 K dim2warm	F	1540 lm	LE015715C			394,96 €	470 €			
	<b>Glas M klar</b> glass M clear	mit Optik Glaslinse eng 35°, Fassung Aluminium poliert with optic glass lens narrow 35°, socket aluminium polished					CU014484	273,11 €	325 €					
		mit Optik Glaslinse weit 48°, Fassung Aluminium poliert with optic glass lens wide 48°, socket aluminium polished					CU014485							
	<b>Glas M klar, Reflektor konisch</b> glass M clear, reflector conical	mit Echtglas Diffusor with glass diffuser					CU014403	264,71 €	315 €					
	<b>Glas M klar, Reflektor zylindrisch</b> glass M clear, reflector cylindrical	mit Echtglas Diffusor with glass diffuser					CU014404							
	<b>Glas M opal</b> glass M opal	mit Echtglas Diffusor with glass diffuser					CU014401	226,89 €	270 €					
	<b>Glas M neusilber</b> glass M new silver	mit Echtglas Diffusor with glass diffuser					CU011202	340,34 €	405 €					
	<b>Acrylglas M klar</b> acrylic glass M clear	mit Optik Pure (entblendet) with optic Pure (glare-free)					CU011206	105,04 €	125 €					
	<b>Acrylglas M klar, Reflektor konisch</b> acrylic glass M clear, reflector conical	mit Echtglas Diffusor with glass diffuser					CU011207	134,45 €	160 €					
	<b>Acrylglas M klar, Reflektor zylindrisch</b> acrylic glass M clear, reflector cylindrical	mit Echtglas Diffusor with glass diffuser					CU011208							
	IP40				LED									
modular article	protection class	through wiring	emergency light option	battery option						dimmable	Zhaga standard	dim2warm	CRI >97	SDCM 2





## CURLING Optik/optic M new

Abbildung figure	Beschreibung description	Art.-Nr. art.-no.	€ netto DE excl. VAT	€ brutto DE incl. VAT	
	<b>Optik M/L Glaslinse eng 35°, Fassung transluzent</b> optic M/L glass lens narrow 35°, socket translucent	empfohlen für Ausführungen mit Reflektor recommended for versions with reflector	CU8555	46,22 €	55 €
	<b>Optik M/L Glaslinse weit 48°, Fassung transluzent</b> optic M/L glass lens wide 48°, socket translucent	empfohlen für Ausführungen mit Reflektor recommended for versions with reflector	CU8542		
	<b>Optik M/L Glaslinse eng 35°, Fassung Aluminium poliert</b> optic M/L glass lens narrow 35°, socket aluminium polished	empfohlen für Glas/Acrylglas klar recommended for glass/acrylic glass clear	CU8554	54,62 €	65 €
	<b>Optik M/L Glaslinse weit 48°, Fassung Aluminium poliert</b> optic M/L glass lens wide 48°, socket aluminium polished	empfohlen für Glas/Acrylglas klar recommended for glass/acrylic glass clear	CU8546		
	<b>Optik M Microprismatik Kegelkuppen 60° entblendet</b> optic M microprismatic cone domes 60° glare-free	für alle Versionen geeignet suitable for all versions	CU8536	40,34 €	48 €
	<b>Optik M abgeblendet</b> optic M deglared	für alle Versionen geeignet suitable for all versions	CU8535	35,29 €	42 €

## CURLING Ceiling L new

Abbildung figure	Beschreibung description	Regelung control	Leistung power	CCT	EEK EEC	Lumen lumen	Art.-Nr. art.-no.	€ netto DE excl. VAT	€ brutto DE incl. VAT
	<b>LIGHT ENGINE</b> Ceiling/Wall L	TRIAC	34 W	2700 K	F	3300 lm	LE014480	302,52 €	360 €
				3000 K	F	3450 lm	LE014483		
				4000 K <span style="color: #0070C0;">new</span>	F	3570 lm	LE015762		
		DALI	34 W	2700 K	F	3300 lm	LE014478	327,73 €	390 €
				3000 K	F	3450 lm	LE014481		
				4000 K <span style="color: #0070C0;">new</span>	F	3570 lm	LE015763		
CASAMBI <span style="color: #0070C0;">new</span>	34 W	2700 K	F	3300 lm	LE014480C	386,55 €	460 €		
		3000 K	F	3450 lm	LE014483C				
		4000 K	F	3570 lm	LE015763C				
	<b>Glas L klar</b> glass L clear	<b>mit Optik Glaslinse eng 35°, Fassung Aluminium poliert</b> with optic glass lens narrow 35°, socket aluminium polished					CU014486	369,75 €	440 €
		<b>mit Optik Glaslinse weit 48°, Fassung Aluminium poliert</b> with optic glass lens wide 48°, socket aluminium polished					CU014487		
	<b>Glas L klar, Reflektor konisch</b> glass L clear, reflector conical	<b>mit Echtglas Diffusor</b> with glass diffusor					CU014476	361,34 €	430 €
	<b>Glas L klar, Reflektor zylindrisch</b> glass L clear, reflector cylindrical	<b>mit Echtglas Diffusor</b> with glass diffusor					CU014477		
	<b>Glas L opal</b> glass L opal	<b>mit Echtglas Diffusor</b> with glass diffusor					CU014479	348,74 €	415 €
	<b>Glas L neusilber</b> glass L new silver	<b>mit Echtglas Diffusor</b> with glass diffusor					CU014478	415,97 €	495 €
	<b>IP40</b>								
modular article	protection class	through wiring	emergency light option	battery option					
					<b>LED</b>				
						dimmable	Zhaga standard	CRI >97	SDCM 2

## CURLING Optik/optic L new

Abbildung figure	Beschreibung description	Art.-Nr. art.-no.	€ netto DE excl. VAT	€ brutto DE incl. VAT	
	<b>Optik M/L Glaslinse eng 35°, Fassung transluzent</b> optic M/L glass lens, narrow 35°, socket translucent	<b>empfohlen für Ausführungen mit Reflektor</b> recommended for versions with reflector	CU8555	46,22 €	55 €
	<b>Optik M/L Glaslinse weit 48°, Fassung transluzent</b> optic M/L glass lens wide 48°, socket translucent	<b>empfohlen für Ausführungen mit Reflektor</b> recommended for versions with reflector	CU8542		
	<b>Optik M/L Glaslinse eng 35°, Fassung Aluminium poliert</b> optic M/L glass lens narrow 35°, socket aluminium polished	<b>empfohlen für Glas/Acrylglas klar</b> recommended for glass/acrylic glass clear	CU8554	54,62 €	65 €
	<b>Optik M/L Glaslinse weit 48°, Fassung Aluminium poliert</b> optic M/L glass lens wide 48°, socket aluminium polished	<b>empfohlen für Glas/Acrylglas klar</b> recommended for glass/acrylic glass clear	CU8546		
	<b>Optik L Microprismatik Kegelkuppen 60° entblendet</b> optic L microprismatic cone domes 60° glare-free	<b>für alle Versionen geeignet</b> suitable for all versions	CU8541	47,90 €	57 €
	<b>Optik L abgeblendet</b> optic L deglared	<b>für alle Versionen geeignet</b> suitable for all versions	CU8537	42,02 €	50 €

# CURLING Suspension

genuine glass

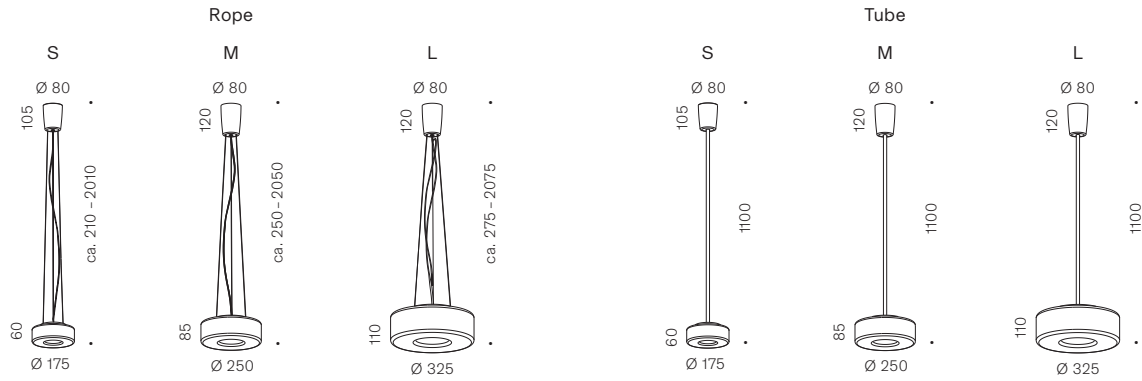

acrylic glass



**Winkeladapter für Dachschrägen in weiß erhältlich – Montagehilfe für einfache Installation.**

**Der Winkel kann individuell angefertigt werden – Sonderfarben auf Anfrage.**

**Bestellungen (Art.-Nr.: ZB1012) bitte in Abstimmung mit dem Vertrieb.**











Angle brackets for sloping roofs available in white – to assist with easy installation.





The brackets can be made to measure – special colours available on request.

Please coordinate orders (art.-no.: ZB1012) with the sales department.





## CURLING Suspension S new

Abbildung figure	Beschreibung description	Regelung control	Leistung power	CCT	EEL EEC	Lumen lumen	Art.-Nr. art.-no.	€ netto DE excl. VAT	€ brutto DE incl. VAT		
	LIGHT ENGINE Suspension Rope S	TRIAC	11 W	2700 K	E	1170 lm	LE015704	369,75 €	440 €		
				3000 K	E	1230 lm	LE015705				
				4000 K <span style="color: #0070C0;">new</span>	E	1280 lm	LE015738				
				1800-3000 K dim2warmF	870 lm	LE015706	399,16 €			475 €	
		DALI	11 W	DALI	11 W	2700 K	E	1170 lm	LE015735	399,16 €	475 €
						3000 K	E	1230 lm	LE015736		
						4000 K <span style="color: #0070C0;">new</span>	E	1280 lm	LE015739		
						1800-3000 K dim2warmF	870 lm	LE015737	428,57 €		
		CASAMBI <span style="color: #0070C0;">new</span>	11 W	CASAMBI <span style="color: #0070C0;">new</span>	11 W	2700 K	E	1170 lm	LE015704C	453,78 €	540 €
						3000 K	E	1230 lm	LE015736C		
						4000 K	E	1280 lm	LE015738C		
						1800-3000 K dim2warmF	870 lm	LE015737C	474,79 €		
	LIGHT ENGINE Suspension Tube S	TRIAC	11 W	2700 K	E	1170 lm	LE015707	327,73 €	390 €		
				3000 K	E	1230 lm	LE015708				
				4000 K <span style="color: #0070C0;">new</span>	E	1280 lm	LE015743				
				1800-3000 K dim2warmF	870 lm	LE015709	361,34 €			430 €	
		DALI	11 W	DALI	11 W	2700 K	E	1170 lm	LE015740	361,34 €	430 €
						3000 K	E	1230 lm	LE015741		
						4000 K <span style="color: #0070C0;">new</span>	E	1280 lm	LE015744		
						1800-3000 K dim2warmF	870 lm	LE015742	390,76 €		
		CASAMBI <span style="color: #0070C0;">new</span>	11 W	CASAMBI <span style="color: #0070C0;">new</span>	11 W	2700 K	E	1170 lm	LE015740C	411,76 €	490 €
						3000 K	E	1230 lm	LE015741C		
						4000 K	E	1280 lm	LE015743C		
						1800-3000 K dim2warmF	870 lm	LE015742C	445,38 €		
	<b>Glas S klar</b> glass S clear			mit Optik Glaslinse weit 59°, Fassung Aluminium poliert with optic glass lens wide 59°, socket aluminium polished		CU014483	218,49 €	260 €			
	<b>Glas S klar, Reflektor konisch</b> glass S clear, reflector conical			mit Echtglas Diffusor with glass diffuser		CU014407	210,08 €	250 €			
	<b>Glas S klar, Reflektor zylindrisch</b> glass S clear, reflector cylindrical			mit Echtglas Diffusor with glass diffuser		CU014408					
	<b>Glas S opal</b> glass S opal			mit Echtglas Diffusor with glass diffuser		CU014405	180,67 €	215 €			
	<b>Glas S neusilber</b> glass S new silver			mit Echtglas Diffusor with glass diffuser		CU011201	268,91 €	320 €			
	<b>Acrylglas S klar</b> acrylic glass S clear			mit Optik Pure (entblendet) with optic Pure (glare-free)		CU011203	79,83 €	95 €			
	<b>Acrylglas S klar, Reflektor konisch</b> acrylic glass S clear, reflector conical			mit Echtglas Diffusor with glass diffuser		CU011204	96,64 €	115 €			
	<b>Acrylglas S klar, Reflektor zylindrisch</b> acrylic glass S clear, reflector cylindrical			mit Echtglas Diffusor with glass diffuser		CU011205					











 modular article
  IP20 protection class
  through wiring
  tube cuttable
  + length option







LED  dimmable
  Zhaga standard
  dim2warm
  CRI >97
  SDCM 3

## CURLING Optik/optic S new

Abbildung figure	Beschreibung description	Art.-Nr. art.-no.	€ netto DE excl. VAT	€ brutto DE incl. VAT
	<b>Optik S Glaslinse eng 32°, Fassung transluzent</b> optic S glass lens narrow 32°, socket translucent	CU8543	38,66 €	46 €
	<b>Optik S Glaslinse weit 59°, Fassung transluzent</b> optic S glass lens wide 59°, socket translucent	CU8552		
	<b>Optik S Glaslinse eng 32°, Fassung Aluminium poliert</b> optic S glass lens narrow 32°, socket aluminium polished	CU8545	45,38 €	54 €
	<b>Optik S Glaslinse weit 59°, Fassung Aluminium poliert</b> optic S glass lens wide 59°, socket aluminium polished	CU8553		
	<b>Optik S Microprismatik Kegelkuppen 60° entblendet</b> optic S microprismatic cone domes 60° glare-free	CU8539	25,21 €	30 €



## CURLING Suspension M new

Abbildung figure	Beschreibung description	Regelung control	Leistung CCT power	EEL EEC	Lumen lumen	Art.-Nr. art.-no.	€ netto DE excl. VAT	€ brutto DE incl. VAT		
	LIGHT ENGINE Suspension Rope M	TRIAC	2700 K	F	1910 lm	LE015716				
			3000 K	E	2010 lm	LE015717	445,38 €	530 €		
			4000 K <span style="color: #0070C0;">new</span>	E	2080 lm	LE015772				
			1800-3000 K dim2warm	F	1540 lm	LE015718	483,19 €	575 €		
		DALI	2700 K	F	1910 lm	LE015719				
			3000 K	E	2010 lm	LE015720	474,79 €	565 €		
			4000 K <span style="color: #0070C0;">new</span>	E	2080 lm	LE015773				
			1800-3000 K dim2warm	F	1540 lm	LE015721	512,61 €	610 €		
		CASAMBI <span style="color: #0070C0;">new</span>	2700 K	F	1910 lm	LE015716C				
			3000 K	E	2010 lm	LE015720C	525,21 €	625 €		
			4000 K	E	2080 lm	LE015773C				
			1800-3000 K dim2warm	F	1540 lm	LE015718C	567,23 €	675 €		
	LIGHT ENGINE Suspension Tube M	TRIAC	2700 K	F	1910 lm	LE015722				
			3000 K	E	2010 lm	LE015723	399,16 €	475 €		
			4000 K <span style="color: #0070C0;">new</span>	E	2080 lm	LE015728				
			1800-3000 K dim2warm	F	1540 lm	LE015724	436,97 €	520 €		
		DALI	2700 K	F	1910 lm	LE015725				
			3000 K	E	2010 lm	LE015726	428,57 €	510 €		
			4000 K <span style="color: #0070C0;">new</span>	E	2080 lm	LE015729				
			1800-3000 K dim2warm	F	1540 lm	LE015727	470,59 €	560 €		
		CASAMBI <span style="color: #0070C0;">new</span>	2700 K	F	1910 lm	LE015722C				
			3000 K	E	2010 lm	LE015723C	474,79 €	565 €		
			4000 K	E	2080 lm	LE015729C				
			1800-3000 K dim2warm	F	1540 lm	LE015724C	504,20 €	600 €		
	<b>Glas M klar</b> glass M clear		mit <b>Optik Glaslinse</b> weit 48°, Fassung Aluminium poliert with optic glass lens wide 48°, socket aluminium polished		CU014485	273,11 €	325 €			
	<b>Glas M klar, Reflektor konisch</b> glass M clear, reflector conical		mit <b>Echtglas Diffusor</b> with glass diffuser		CU014403	264,71 €	315 €			
	<b>Glas M klar, Reflektor zylindrisch</b> glass M clear, reflector cylindrical		mit <b>Echtglas Diffusor</b> with glass diffuser		CU014404					
	<b>Glas M opal</b> glass M opal		mit <b>Echtglas Diffusor</b> with glass diffuser		CU014401	226,89 €	270 €			
	<b>Glas M neusilber</b> glass M new silver		mit <b>Echtglas Diffusor</b> with glass diffuser		CU011202	340,34 €	405 €			
	<b>Acrylglas M klar</b> acrylic glass M clear		mit <b>Optik Pure (entblendet)</b> with optic Pure (glare-free)		CU011206	105,04 €	125 €			
	<b>Acrylglas M klar, Reflektor konisch</b> acrylic glass M clear, reflector conical		mit <b>Echtglas Diffusor</b> with glass diffuser		CU011207	134,45 €	160 €			
	<b>Acrylglas M klar, Reflektor zylindrisch</b> acrylic glass M clear, reflector cylindrical		mit <b>Echtglas Diffusor</b> with glass diffuser		CU011208					







 modular article
  IP20 protection class
  through wiring
  tube cuttable
  + length option
  emergency light option

LED
  dimmable
  Zhaga standard
  dim2warm
  CRI >97
  SDCM 3

## CURLING Optik/optic M new

Abbildung figure	Beschreibung description	Art.-Nr. art.-no.	€ netto DE excl. VAT	€ brutto DE incl. VAT
	<b>Optik M/L Glaslinse eng 35°, Fassung transluzent</b> optic M/L glass lens narrow 35°, socket translucent	CU8555	46,22 €	55 €
	<b>Optik M/L Glaslinse weit 48°, Fassung transluzent</b> optic M/L glass lens wide 48°, socket translucent	CU8542		
	<b>Optik M/L Glaslinse eng 35°, Fassung Aluminium poliert</b> optic M/L glass lens narrow 35°, socket aluminium polished	CU8554	54,62 €	65 €
	<b>Optik M/L Glaslinse weit 48°, Fassung Aluminium poliert</b> optic M/L glass lens wide 48°, socket aluminium polished	CU8546		
	<b>Optik M Microprismatik Kegelkuppen 60° entblendet</b> optic M microprismatic cone domes 60° glare-free	CU8536	40,34 €	48 €



## CURLING Suspension L new

Abbildung figure	Beschreibung description	Regelung control	Leistung power	CCT	EЕК EEC	Lumen lumen	Art.-Nr. art.-no.	€ netto DE excl. VAT	€ brutto DE incl. VAT		
	<b>LIGHT ENGINE</b> Suspension Rope L	TRIAC	34 W	2700 K	F	3300lm	LE014486	483,19 €	575 €		
				3000 K	F	3450lm	LE014489	483,19 €	575 €		
				4000 K <span style="color: #0070C0;">new</span>	F	3570lm	LE015764	483,19 €	575 €		
		DALI	34 W	2700 K	F	3300lm	LE014484	521,01 €	620 €		
				3000 K	F	3450lm	LE014487	521,01 €	620 €		
				4000 K <span style="color: #0070C0;">new</span>	F	3570lm	LE015765	521,01 €	620 €		
		CASAMBI <span style="color: #0070C0;">new</span>	34 W	2700 K	F	3300lm	LE014486C	567,23 €	675 €		
				3000 K	F	3450lm	LE014489C	567,23 €	675 €		
				4000 K	F	3570lm	LE015764C	567,23 €	675 €		
			<b>LIGHT ENGINE</b> Suspension Tube L	TRIAC	34 W	2700 K	F	3300lm	LE014492	432,77 €	515 €
						3000 K	F	3450lm	LE014495	432,77 €	515 €
						4000 K <span style="color: #0070C0;">new</span>	F	3570lm	LE015766	432,77 €	515 €
DALI	34 W			2700 K	F	3300lm	LE014490	474,79 €	565 €		
				3000 K	F	3450lm	LE014493	474,79 €	565 €		
				4000 K <span style="color: #0070C0;">new</span>	F	3570lm	LE015767	474,79 €	565 €		
CASAMBI <span style="color: #0070C0;">new</span>	34 W			2700 K	F	3300lm	LE014492C	516,81 €	615 €		
				3000 K	F	3450lm	LE014495C	516,81 €	615 €		
				4000 K	F	3570lm	LE015766C	516,81 €	615 €		
	<b>Glas L klar</b> glass clear					<b>mit Optik Glaslinse weit 48°, Fassung Aluminium poliert</b> with optic glass lens wide 48°, socket aluminium polished		CU014487	369,75 €	440 €	
	<b>Glas L klar, Reflektor konisch</b> glass clear, reflector conical					<b>mit Echtglas Diffusor</b> with glass diffusor		CU014476	361,34 €	430 €	
	<b>Glas L klar, Reflektor zylindrisch</b> glass clear, reflector cylindrical					<b>mit Echtglas Diffusor</b> with glass diffusor		CU014477			
	<b>Glas L opal</b> glass L opal			<b>mit Echtglas Diffusor</b> with glass diffusor		CU014479	348,74 €	415 €			
	<b>Glas L neusilber</b> glass L new silver			<b>mit Echtglas Diffusor</b> with glass diffusor		CU014478	415,97 €	495 €			

 modular article  
  IP20 protection class  
  through wiring  
  tube cuttable  
  + length option  
  emergency light option  
  battery option

LED  
  dimmable  
  Zhaga standard  
  CRI >97  
  SDCM 3

## CURLING Optik/optic L new

Abbildung figure	Beschreibung description	Art.-Nr. art.-no.	€ netto DE excl. VAT	€ brutto DE incl. VAT	
	<b>Optik M/L Glaslinse eng 35°, Fassung transluzent</b> optic M/L glass lens, narrow 35°, socket translucent	empfohlen für Ausführungen mit Reflektor recommended for versions with reflector	CU8555	46,22 €	55 €
	<b>Optik M/L Glaslinse weit 48°, Fassung transluzent</b> optic M/L glass lens wide 48°, socket translucent	empfohlen für Ausführungen mit Reflektor recommended for versions with reflector	CU8542		
	<b>Optik M/L Glaslinse eng 35°, Fassung Aluminium poliert</b> optic M/L glass lens narrow 35°, socket aluminium polished	empfohlen für Glas/Acrylglas klar recommended for glass/acrylic glass clear	CU8554	54,62 €	65 €
	<b>Optik M/L Glaslinse weit 48°, Fassung Aluminium poliert</b> optic M/L glass lens wide 48°, socket aluminium polished	empfohlen für Glas/Acrylglas klar recommended for glass/acrylic glass clear	CU8546		
	<b>Optik L Microprismatik Kegelkuppen 60° entblendet</b> optic L microprismatic cone domes 60° glare-free	für alle Versionen geeignet suitable for all versions	CU8541	47,90 €	57 €

# CURLING Wall

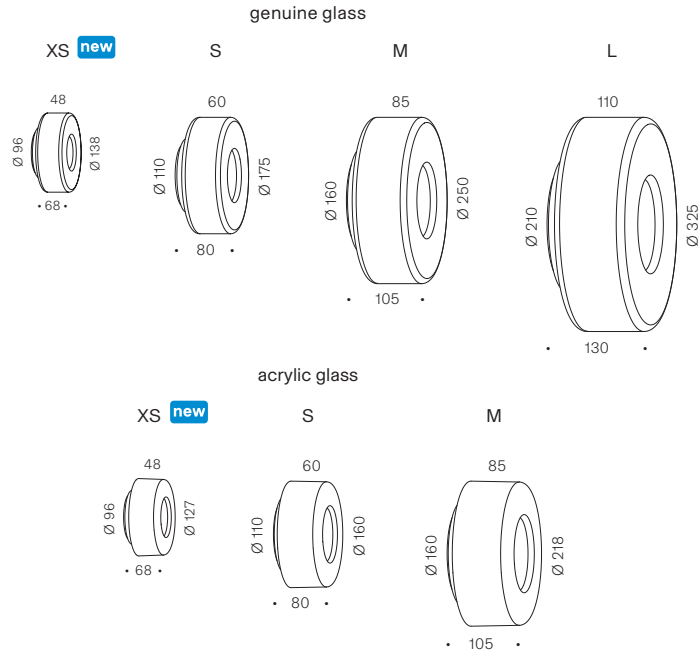









## CURLING Wall XS new

Abbildung figure	Beschreibung description	Regelung control	Leistung power	CCT	EEL EEC	Lumen lumen	Art.-Nr. art.-no.	€ netto DE excl. VAT	€ brutto DE incl. VAT
	<b>LIGHT ENGINE</b> Ceiling/Wall XS	TRIAC	8 W	2700 K	E	690 lm	LE015750	130,25 €	155 €
				3000 K	E	710 lm	LE015751		
		DALI	8 W	2700 K	E	690 lm	LE015753	151,26 €	180 €
				3000 K	E	710 lm	LE015754		
		CASAMBI	8 W	2700 K	E	690 lm	LE015753C	214,29 €	255 €
				3000 K	E	710 lm	LE015754C		
	<b>Glas XS klar</b> glass XS clear			<b>mit Optik XS abgeblendet</b> with optic XS deglared			CU014423	134,45 €	160 €
	<b>Glas XS klar, Reflektor konisch</b> glass XS clear, reflector conical			<b>mit Optik XS abgeblendet</b> with optic XS deglared			CU014428	151,26 €	180 €
	<b>Glas XS klar, Reflektor zylindrisch</b> glass XS clear, reflector cylindrical			<b>mit Optik XS abgeblendet</b> with optic XS deglared			CU014429		
	<b>Glas XS opal</b> glass XS opal			<b>mit Optik XS abgeblendet</b> with optic XS deglared			CU011240	134,45 €	160 €
	<b>Glas XS neusilber</b> glass XS new silver			<b>mit Optik XS verspiegelt</b> with optic XS mirrored			CU011244	205,88 €	245 €
	<b>Acrylglas XS klar</b> acrylic glass XS clear			<b>mit Optik XS abgeblendet</b> with optic XS deglared			CU014425	54,62 €	65 €
	<b>Acrylglas XS klar, Reflektor konisch</b> acrylic glass XS clear, reflector conical			<b>mit Optik XS abgeblendet</b> with optic XS deglared			CU011238	71,43 €	85 €
	<b>Acrylglas XS klar, Reflektor zylindrisch</b> acrylic glass XS clear, reflector cylindrical			<b>mit Optik XS abgeblendet</b> with optic XS deglared			CU011239		

modular article  
 IP44 protection class  
 through wiring

LED  
 dimmable  
 Zhaga standard  
 CRI >97  
 SDCM 2



## CURLING Wall S new

Abbildung figure	Beschreibung description	Regelung control	Leistung power	CCT	EЕК EEC	Lumen lumen	Art.-Nr. art.-no.	€ netto DE excl. VAT	€ brutto DE incl. VAT		
	<b>LIGHT ENGINE</b> Ceiling/Wall S	TRIAC	11 W	2700 K	E	1170 lm	LE015701	189,08 €	225 €		
				3000 K	E	1230 lm	LE015702				
				4000 K <span style="color: #0070C0;">new</span>	E	1280 lm	LE015733				
				1800-3000 K dim2warm	F	870 lm	LE015703			226,89 €	270 €
				2700 K	E	1170 lm	LE015730			214,29 €	255 €
				3000 K	E	1230 lm	LE015731				
		4000 K <span style="color: #0070C0;">new</span>	E	1280 lm	LE015734						
		1800-3000 K dim2warm	F	870 lm	LE015732	252,10 €	300 €				
		2700 K	E	1170 lm	LE015701C	273,11 €	325 €				
		3000 K	E	1230 lm	LE015702C						
		4000 K	E	1280 lm	LE015733C						
				CASAMBI <span style="color: #0070C0;">new</span>	11 W	1800-3000 K dim2warm	F	870 lm	LE015703C	315,13 €	375 €
	<b>Glas S klar</b> glass S clear			mit Optik S abgeblendet with optic S deglared			CU011212	210,08 €	250 €		
	<b>Glas S klar, Reflektor konisch</b> glass S clear, reflector conical			mit Optik S abgeblendet with optic S deglared			CU011225	235,29 €	280 €		
	<b>Glas S klar, Reflektor zylindrisch</b> glass S clear, reflector cylindrical			mit Optik S abgeblendet with optic S deglared			CU011226				
	<b>Glas S opal</b> glass S opal			mit Optik S abgeblendet with optic S deglared			CU011241	180,67 €	215 €		
	<b>Glas S neusilber</b> glass S new silver			mit Optik S verspiegelt with optic S mirrored			CU011245	294,12 €	350 €		
	<b>Acrylglas S klar</b> acrylic glass S clear			mit Optik S abgeblendet with optic S deglared			CU011220	105,04 €	125 €		
	<b>Acrylglas S klar, Reflektor konisch</b> acrylic glass S clear, reflector conical			mit Optik S abgeblendet with optic S deglared			CU011232	130,25 €	155 €		
	<b>Acrylglas S klar, Reflektor zylindrisch</b> acrylic glass S clear, reflector cylindrical			mit Optik S abgeblendet with optic S deglared			CU011233				



 IP40  
modular article protection class

LED  dimmable  Zhaga standard  dim2warm  CRI >97  SDCM 2









## CURLING Optik/optic XS new





Abbildung figure	Beschreibung description	Art.-Nr. art.-no.	€ netto DE excl. VAT	€ brutto DE incl. VAT
 <span style="color: #0070C0;">new</span>	<b>Optik XS abgeblendet</b> optic XS deglared		für alle Versionen geeignet suitable for all versions	
 <span style="color: #0070C0;">new</span>	<b>Optik XS verspiegelt</b> optic XS mirrored		für alle Versionen geeignet suitable for all versions	

## CURLING Optik/optic S new

Abbildung figure	Beschreibung description	Art.-Nr. art.-no.	€ netto DE excl. VAT	€ brutto DE incl. VAT
 <span style="color: #0070C0;">new</span>	<b>Optik S abgeblendet</b> optic S deglared		für alle Versionen geeignet suitable for all versions	
 <span style="color: #0070C0;">new</span>	<b>Optik S verspiegelt</b> optic S mirrored		für alle Versionen geeignet suitable for all versions	

## CURLING Wall M new

Abbildung figure	Beschreibung description	Regelung control	Leistung power	CCT	EEL EEC	Lumen lumen	Art.-Nr. art.-no.	€ netto DE excl. VAT	€ brutto DE incl. VAT		
	<b>LIGHT ENGINE</b> Ceiling/Wall M	TRIAC	20W	2700K	F	1910lm	LE015710	252,10 €	300 €		
				3000K	E	2010lm	LE015711				
				4000K <span style="color: #0070C0;">new</span>	E	2080lm	LE015770				
				1800-3000K dim2warm	F	1540lm	LE015712			252,10 €	300 €
				2700K	F	1910lm	LE015713			277,31 €	330 €
				3000K	E	2010lm	LE015714				
		4000K <span style="color: #0070C0;">new</span>	E	2080lm	LE015771						
		1800-3000K dim2warm	F	1540lm	LE015715	310,92 €	370 €				
		2700K	F	1910lm	LE015713C	361,34 €	430 €				
		3000K	E	2010lm	LE015714C						
		4000K	E	2080lm	LE015770C						
		1800-3000K dim2warm	F	1540lm	LE015715C			394,96 €	470 €		
	<b>Glas M klar</b> glass M clear			<b>mit Optik M abgeblendet</b> with optic M deglared				CU011209	247,90 €	295 €	
	<b>Glas M klar, Reflektor konisch</b> glass M clear, reflector conical			<b>mit Optik M abgeblendet</b> with optic M deglared				CU011227	264,71 €	315 €	
	<b>Glas M klar, Reflektor zylindrisch</b> glass M clear, reflector cylindrical			<b>mit Optik M abgeblendet</b> with optic M deglared		CU011228					
	<b>Glas M opal</b> glass M opal			<b>mit Optik M abgeblendet</b> with optic M deglared		CU011242	226,89 €	270 €			
	<b>Glas M neusilber</b> glass M new silver			<b>mit Optik M verspiegelt</b> with optic M mirrored		CU011246	352,94 €	420 €			
	<b>Acrylglas M klar</b> acrylic glass M clear			<b>mit Optik M abgeblendet</b> with optic M deglared		CU011223	134,45 €	160 €			
	<b>Acrylglas M klar, Reflektor konisch</b> acrylic glass M clear, reflector conical			<b>mit Optik M abgeblendet</b> with optic M deglared		CU011234	159,66 €	190 €			
	<b>Acrylglas M klar, Reflektor zylindrisch</b> acrylic glass M clear, reflector cylindrical			<b>mit Optik M abgeblendet</b> with optic M deglared		CU011235					







 modular article  
  IP40 protection class  
  through wiring  
  emergency light option  
  battery option





LED  
  dimmable  
  Zhaga standard  
  dim2warm  
  CRI >97  
  SDCM 2

## CURLING Optik/optic M new

Abbildung figure	Beschreibung description	Art.-Nr. art.-no.	€ netto DE excl. VAT	€ brutto DE incl. VAT
 <span style="color: #0070C0;">new</span>	<b>Optik M/L up/down, Aluminium weiß lackiert</b> optic M/L up/down, aluminium white painted	für alle Versionen geeignet suitable for all versions	CU8544	46,22 € 55 €
 <span style="color: #0070C0;">new</span>	<b>Optik M verspiegelt</b> optic M mirrored	für alle Versionen geeignet suitable for all versions	CU8561	40,34 € 48 €

## CURLING Wall L new

Abbildung figure	Beschreibung description	Regelung control	Leistung power	CCT	EEK EEC	Lumen lumen	Art.-Nr. art.-no.	€ netto DE excl. VAT	€ brutto DE incl. VAT	
	<b>LIGHT ENGINE</b> Ceiling/Wall L	TRIAC	34 W	2700 K	F	3300 lm	LE014480	302,52 €	360 €	
				3000 K	F	3450 lm	LE014483			
				4000 K <span style="color: #0070C0;">new</span>	F	3570 lm	LE015762			
		DALI	34 W	3000 K	3000 K	F	3450 lm	LE014481	327,73 €	390 €
						F	3570 lm	LE015763		
						F	3300 lm	LE014480C		
		CASAMBI <span style="color: #0070C0;">new</span>	34 W	3000 K	3000 K	F	3450 lm	LE014483C	386,55 €	460 €
						F	3570 lm	LE015763C		
						F	3300 lm	LE014480C		
	<b>Glas L klar</b> glass L clear			<b>mit Optik L abgeblendet</b> with optic L deglared			CU011210	352,94 €	420 €	
	<b>Glas L klar, Reflektor konisch</b> glass L clear, reflector conical			<b>mit Optik L abgeblendet</b> with optic L deglared			CU011230	361,34 €	430 €	
	<b>Glas L klar, Reflektor zylindrisch</b> glass L clear, reflector cylindrical			<b>mit Optik L abgeblendet</b> with optic L deglared			CU011231			
	<b>Glas L opal</b> glass L opal			<b>mit Optik M abgeblendet</b> with optic M deglared			CU011243	348,74 €	415 €	
	<b>Glas L neusilber</b> glass L new silver			<b>mit Optik L verspiegelt</b> with optic L mirrored			CU011247	445,38 €	530 €	

 modular article  
 IP40 protection class  
 through wiring  
 emergency light option  
 battery option

 LED  
 dimmable  
 Zhaga standard  
 CRI >97  
 SDCM 2



## CURLING Optik/optic L new

Abbildung figure	Beschreibung description	Art.-Nr. art.-no.	€ netto DE excl. VAT	€ brutto DE incl. VAT
	<b>Optik M/L up/down, Aluminium weiß lackiert</b> optic M/L up/down, aluminium white painted	für alle Versionen geeignet suitable for all versions	CU8544	46,22 € 55 €
	<b>Optik L verspiegelt</b> optic L mirrored	für alle Versionen geeignet suitable for all versions	CU8562	47,90 € 57 €

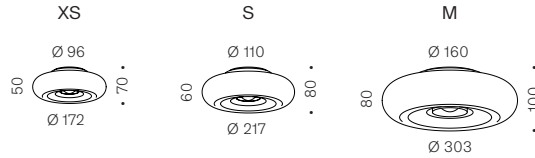
# DON Ceiling new



## DON Ceiling XS new



Abbildung figure	Beschreibung description	Regelung control	Leistung power	CCT	EELCC	Lumen lumen	Art.-Nr. art.-no.	€ netto DE excl. VAT	€ brutto DE incl. VAT
	<b>LIGHT ENGINE</b> Ceiling/Wall XS	TRIAC	8 W	2700 K	E	690 lm	LE015750	130,25 €	155 €
				3000 K	E	710 lm	LE015751		
		DALI	8 W	2700 K	E	690 lm	LE015753	151,26 €	180 €
				3000 K	E	710 lm	LE015754		
		CASAMBI	8 W	2700 K	E	690 lm	LE015753C	214,29 €	255 €
				3000 K	E	710 lm	LE015754C		
	<b>Glas XS klar</b> glass XS clear	<b>Optik XS Glaslinse eng 40°, Fassung Aluminium poliert</b> optic XS glass lens narrow 40°, socket aluminium polished					DO1001	159,66 €	190 €
		<b>Optik XS Glaslinse weit 55°, Fassung Aluminium poliert</b> optic XS glass lens wide 55°, socket aluminium polished					DO1002		
	<b>Glas XS neusilber</b> glass XS new silver	<b>Optik XS Glaslinse eng 40°, Fassung Aluminium poliert</b> optic XS glass lens narrow 40°, socket aluminium polished					DO1011	210,08 €	250 €
		<b>Optik XS Glaslinse weit 55°, Fassung Aluminium poliert</b> optic XS glass lens wide 55°, socket aluminium polished					DO1012		



## DON Optik/optic XS new

Abbildung figure	Beschreibung description	Art.-Nr. art.-no.	€ netto DE excl. VAT	€ brutto DE incl. VAT
	<b>Optik XS Microprismatik Kegelkuppen 60° entblendet</b> optic XS microprismatic cone domes 60° glare-free	für alle Versionen geeignet suitable for all versions	CU8557	21,85 € 26 €
	<b>Optik XS abgeblendet</b> optic XS deglared	für alle Versionen geeignet suitable for all versions	CU8547	18,49 € 22 €
	<b>Optik XS verspiegelt</b> optic XS mirrored	für alle Versionen geeignet suitable for all versions	CU8559	18,49 € 22 €

## DON Ceiling S new

Abbildung figure	Beschreibung description	Regelung control	Leistung power	CCT	EEK EEC	Lumen lumen	Art.-Nr. art.-no.	€ netto DE excl. VAT	€ brutto DE incl. VAT		
	<b>LIGHT ENGINE</b> Ceiling/Wall S	TRIAC	11 W	2700 K	E	1170 lm	LE015701	189,08 €	225 €		
				3000 K	E	1230 lm	LE015702				
				4000 K <span style="background-color: #0070C0; color: white; padding: 2px;">new</span>	E	1280 lm	LE015733				
				1800-3000 K dim2warm	F	870 lm	LE015703			226,89 €	270 €
				2700 K	E	1170 lm	LE015730			214,29 €	255 €
				3000 K	E	1230 lm	LE015731				
		4000 K <span style="background-color: #0070C0; color: white; padding: 2px;">new</span>	E	1280 lm	LE015734						
		1800-3000 K dim2warm	F	870 lm	LE015732	252,10 €	300 €				
		2700 K	E	1170 lm	LE015701C	273,11 €	325 €				
		3000 K	E	1230 lm	LE015702C						
		4000 K	E	1280 lm	LE015733C						
						1800-3000 K dim2warm	F	870 lm	LE015703C	315,13 €	375 €
	<b>Glas S klar</b> glass S clear	<b>Optik S Glaslinse eng 32°, Fassung Aluminium poliert</b> optic S glass lens narrow 32°, socket aluminium polished					DO1031	201,68 €	240 €		
		<b>Optik S Glaslinse weit 59°, Fassung Aluminium poliert</b> optic S glass lens wide 59°, socket aluminium polished					DO1032				
	<b>Glas S neusilber</b> glass S new silver	<b>Optik S Glaslinse eng 32°, Fassung Aluminium poliert</b> optic S glass lens narrow 32°, socket aluminium polished					DO1041	268,91 €	320 €		
		<b>Optik S Glaslinse weit 59°, Fassung Aluminium poliert</b> optic S glass lens wide 59°, socket aluminium polished					DO1042				



 modular article
  IP40 protection class
  through wiring





LED
  dimmable
  Zhaga standard
  dim2warm
  CRI >97
  SDCM 2

## DON Optik/optic S new

Abbildung figure	Beschreibung description	Art.-Nr. art.-no.	€ netto DE excl. VAT	€ brutto DE incl. VAT
	<b>Optik S Microprismatik Kegelkuppen 60° entblendet</b> optic S microprismatic cone domes 60° glare-free	für alle Versionen geeignet suitable for all versions	CU8539	25,21 € 30 €
	<b>Optik S abgeblendet</b> optic S deglared	für alle Versionen geeignet suitable for all versions	CU8532	21,01 € 25 €
	<b>Optik S verspiegelt</b> optic S mirrored	für alle Versionen geeignet suitable for all versions	CU8560	25,21 € 30 €



## DON Ceiling M new

Abbildung figure	Beschreibung description	Regelung control	Leistung power	CCT	EЕК EEC	Lumen lumen	Art.-Nr. art.-no.	€ netto DE excl. VAT	€ brutto DE incl. VAT		
	<b>LIGHT ENGINE</b> Ceiling/Wall M	TRIAC	20 W	2700 K	F	1910 lm	LE015710	252,10 €	300 €		
				3000 K	E	2010 lm	LE015711				
				4000 K <span style="color: #0070C0;">new</span>	E	2080 lm	LE015770				
				1800-3000 K dim2warm	F	1540 lm	LE015712			252,10 €	300 €
				2700 K	F	1910 lm	LE015713			277,31 €	330 €
				3000 K	E	2010 lm	LE015714				
		4000 K <span style="color: #0070C0;">new</span>	E	2080 lm	LE015771						
		1800-3000 K dim2warm	F	1540 lm	LE015715	310,92 €	370 €				
		2700 K	F	1910 lm	LE015713C	361,34 €	430 €				
		3000 K	E	2010 lm	LE015714C						
		4000 K	E	2080 lm	LE015770C						
		1800-3000 K dim2warm	F	1540 lm	LE015715C			394,96 €	470 €		
	<b>Glas M klar</b> glass M clear	<b>Optik M Glaslinse eng 35°, Fassung Aluminium poliert</b> optic M glass lens narrow 35°, socket aluminium polished						DO1061	243,70 €	290 €	
		<b>Optik M Glaslinse weit 48°, Fassung Aluminium poliert</b> optic M glass lens wide 48°, socket aluminium polished						DO1062			
	<b>Glas M neusilber</b> glass M new silver	<b>Optik M Glaslinse eng 35°, Fassung Aluminium poliert</b> optic M glass lens narrow 35°, socket aluminium polished					DO1071	327,73 €	390 €		
		<b>Optik M Glaslinse weit 48°, Fassung Aluminium poliert</b> optic M glass lens wide 48°, socket aluminium polished					DO1072				

 modular article  
 IP40 protection class  
 through wiring  
 emergency light option  
 battery option

 LED  
 dimmable  
 Zhaga standard  
 dim2warm  
 CRI >97  
 SDCM 2

## DON Optik/optic M new

Abbildung figure	Beschreibung description	Art.-Nr. art.-no.	€ netto DE excl. VAT	€ brutto DE incl. VAT
	<b>Optik M Microprismatik Kegelkuppen 60° entblendet</b> optic M microprismatic cone domes 60° glare-free	für alle Versionen geeignet suitable for all versions	CU8536	40,34 € 48 €
	<b>Optik M abgeblendet</b> optic M deglared	für alle Versionen geeignet suitable for all versions	CU8535	35,29 € 42 €
	<b>Optik M verspiegelt</b> optic M mirrored	für alle Versionen geeignet suitable for all versions	CU8561	40,34 € 48 €

## Rope

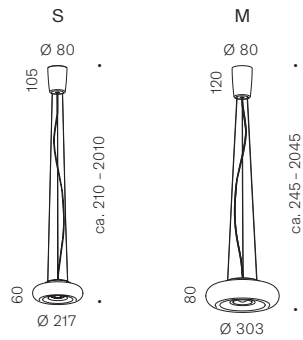

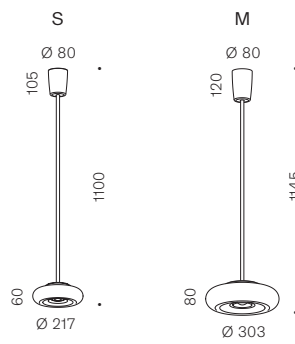

## Tube



Winkeladapter für Dachschrägen in weiß erhältlich – Montagehilfe für einfache Installation.  
 Der Winkel kann individuell angefertigt werden – Sonderfarben auf Anfrage.  
 Bestellungen (Art.-Nr.: ZB1012) bitte in Abstimmung mit dem Vertrieb.  
 Angle brackets for sloping roofs available in white – to assist with easy installation.  
 The brackets can be made to measure – special colours available on request.  
 Please coordinate orders (art.-no.: ZB1012) with the sales department.

## DON Suspension S new

Abbildung figure	Beschreibung description	Regelung control	Leistung power	CCT	EELCC	Lumen lumen	Art.-Nr. art.-no.	€ netto DE excl. VAT	€ brutto DE incl. VAT		
	<b>LIGHT ENGINE</b> Suspension Rope S	TRIAC	11 W	2700 K	E	1170 lm	LE015704	369,75 €	440 €		
				3000 K	E	1230 lm	LE015705				
				4000 K <span style="color: #0070C0;">new</span>	E	1280 lm	LE015738				
				1800-3000 K dim2warm	F	870 lm	LE015706			399,16 €	475 €
				2700 K	E	1170 lm	LE015735			399,16 €	475 €
				3000 K	E	1230 lm	LE015736				
		4000 K <span style="color: #0070C0;">new</span>	E	1280 lm	LE015739						
		1800-3000 K dim2warm	F	870 lm	LE015737	428,57 €	510 €				
		2700 K	E	1170 lm	LE015704C	453,78 €	540 €				
		3000 K	E	1230 lm	LE015736C						
		4000 K	E	1280 lm	LE015738C						
		1800-3000 K dim2warm	F	870 lm	LE015737C			474,79 €	565 €		
2700 K	E	1170 lm	LE015707	327,73 €	390 €						
3000 K	E	1230 lm	LE015708								
4000 K <span style="color: #0070C0;">new</span>	E	1280 lm	LE015743								
1800-3000 K dim2warm	F	870 lm	LE015709			361,34 €	430 €				
2700 K	E	1170 lm	LE015740			361,34 €	430 €				
3000 K	E	1230 lm	LE015741								
4000 K <span style="color: #0070C0;">new</span>	E	1280 lm	LE015744								
1800-3000 K dim2warm	F	870 lm	LE015742	390,76 €	465 €						
2700 K	E	1170 lm	LE015740C	411,76 €	490 €						
3000 K	E	1230 lm	LE015741C								
4000 K	E	1280 lm	LE015743C								
1800-3000 K dim2warm	F	870 lm	LE015742C			445,38 €	530 €				
	<b>Glas S klar</b> glass S clear	<b>Optik S Glaslinse eng 32°, Fassung Aluminium poliert</b> optic S glass lens narrow 32°, socket aluminium polished					DO1031	201,68 €	240 €		
		<b>Optik S Glaslinse weit 59°, Fassung Aluminium poliert</b> optic S glass lens wide 59°, socket aluminium polished					DO1032				
	<b>Glas S neusilber</b> glass S new silver	<b>Optik S Glaslinse eng 32°, Fassung Aluminium poliert</b> optic S glass lens narrow 32°, socket aluminium polished					DO1041	268,91 €	320 €		
		<b>Optik S Glaslinse weit 59°, Fassung Aluminium poliert</b> optic S glass lens wide 59°, socket aluminium polished					DO1042				



 modular article  
 IP20 protection class  
 through wiring  
 tube cuttable  
 + length option







LED  dimmable  Zhaga standard  dim2warm  CRI >97  SDCM 3

## DON Optik/optic S new

Abbildung figure	Beschreibung description	Art.-Nr. art.-no.	€ netto DE excl. VAT	€ brutto DE incl. VAT
	<b>Optik S Microprismatik Kegelkuppen 60° entblendet</b> optic S microprismatic cone domes 60° glare-free	CU8539	25,21 €	30 €

## DON Suspension M new

Abbildung figure	Beschreibung description	Regelung control	Leistung power	CCT	EEK EEC	Lumen lumen	Art.-Nr. art.-no.	€ netto DE excl. VAT	€ brutto DE incl. VAT		
	<b>LIGHT ENGINE</b> Suspension Rope M	TRIAC	27 W	2700K	F	1910lm	LE015716	445,38 €	530 €		
				3000K	E	2010lm	LE015717				
				4000K <span style="color: #0070C0;">new</span>	E	2080lm	LE015772				
				1800-3000K dim2warm	F	1540lm	LE015718			483,19 €	575 €
				2700K	F	1910lm	LE015719			474,79 €	565 €
				3000K	E	2010lm	LE015720				
		4000K <span style="color: #0070C0;">new</span>	E	2080lm	LE015773						
		1800-3000K dim2warm	F	1540lm	LE015721	512,61 €	610 €				
		2700K	F	1910lm	LE015716C	525,21 €	625 €				
		3000K	E	2010lm	LE015720C						
		4000K	E	2080lm	LE015773C						
		1800-3000K dim2warm	F	1540lm	LE015718C			567,23 €	675 €		
2700K	F	1910lm	LE015722	399,16 €	475 €						
3000K	E	2010lm	LE015723								
4000K <span style="color: #0070C0;">new</span>	E	2080lm	LE015728								
1800-3000K dim2warm	F	1540lm	LE015724			436,97 €	520 €				
2700K	F	1910lm	LE015725			428,57 €	510 €				
3000K	E	2010lm	LE015726								
4000K <span style="color: #0070C0;">new</span>	E	2080lm	LE015729								
1800-3000K dim2warm	F	1540lm	LE015727	470,59 €	560 €						
2700K	F	1910lm	LE015722C	474,79 €	565 €						
3000K	E	2010lm	LE015723C								
4000K	E	2080lm	LE015729C								
1800-3000K dim2warm	F	1540lm	LE015724C			504,20 €	600 €				
	<b>Glas M klar</b> glass M clear	<b>Optik M Glaslinse eng 35°, Fassung Aluminium poliert</b> optic M glass lens narrow 35°, socket aluminium polished					DO1061	243,70 €	290 €		
		<b>Optik M Glaslinse weit 48°, Fassung Aluminium poliert</b> optic M glass lens wide 48°, socket aluminium polished					DO1062				
	<b>Glas M neusilber</b> glass M new silver	<b>Optik M Glaslinse eng 35°, Fassung Aluminium poliert</b> optic M glass lens narrow 35°, socket aluminium polished					DO1071	327,73 €	390 €		
		<b>Optik M Glaslinse weit 48°, Fassung Aluminium poliert</b> optic M glass lens wide 48°, socket aluminium polished					DO1072				

 modular article  
  IP20 protection class  
  through wiring  
  tube cuttable  
  + length option  
  emergency light option

LED  
  dimmable  
  Zhaga standard  
  dim2warm  
  CRI >97  
  SDCM 3

## DON Optik/optic M new

Abbildung figure	Beschreibung description	Art.-Nr. art.-no.	€ netto DE excl. VAT	€ brutto DE incl. VAT
	<b>Optik M Microprismatik Kegelkuppen 60° entblendet</b> optic M microprismatic cone domes 60° glare-free	für alle Versionen geeignet suitable for all versions	CU8536	40,34 € 48 €

# DON Wall new

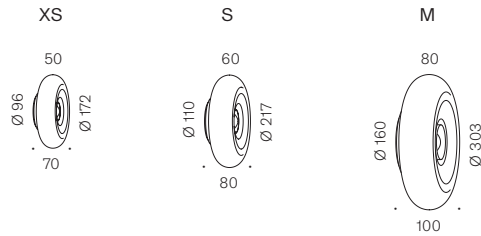

## DON Wall XS new

Abbildung figure	Beschreibung description	Regelung control	Leistung power	CCT	EEL EEC	Lumen lumen	Art.-Nr. art.-no.	€ netto DE excl. VAT	€ brutto DE incl. VAT
 <span style="background-color: #0070C0; color: white; padding: 2px;">new</span>	<b>LIGHT ENGINE</b> Ceiling/Wall XS	TRIAC	8 W	2700 K	E	690 lm	LE015750	130,25 €	155 €
				3000 K	E	710 lm	LE015751		
		DALI	8 W	2700 K	E	690 lm	LE015753	151,26 €	180 €
				3000 K	E	710 lm	LE015754		
		CASAMBI	8 W	2700 K	E	690 lm	LE015753C	214,29 €	255 €
				3000 K	E	710 lm	LE015754C		
 <span style="background-color: #0070C0; color: white; padding: 2px;">new</span>	<b>Glas XS klar</b> glass XS clear	Optik XS Spiegel optic XS mirror					DO1021	134,45 €	160 €
 <span style="background-color: #0070C0; color: white; padding: 2px;">new</span>	<b>Glas XS neusilber</b> glass XS new silver	Optik XS Spiegel optic XS mirror					DO1022	184,87 €	220 €

 modular article  
 IP44 protection class  
 through wiring

 LED  
 dimmable  
 Zhaga standard  
 CRI >97  
 SDCM 2



## DON Optik/optic XS new

Abbildung figure	Beschreibung description	Art.-Nr. art.-no.	€ netto DE excl. VAT	€ brutto DE incl. VAT
 <span style="background-color: #0070C0; color: white; padding: 2px;">new</span>	<b>Optik XS abgeblendet</b> optic XS deglared	für alle Versionen geeignet suitable for all versions	CU8547	18,49 € 22 €

## DON Optik/optic S new

Abbildung figure	Beschreibung description	Art.-Nr. art.-no.	€ netto DE excl. VAT	€ brutto DE incl. VAT
 <span style="background-color: #0070C0; color: white; padding: 2px;">new</span>	<b>Optik S abgeblendet</b> optic S deglared	für alle Versionen geeignet suitable for all versions	CU8532	25,21 € 30 €



## DON Wall S new





Abbildung figure	Beschreibung description	Regelung control	Leistung power	CCT	EEK EEC	Lumen lumen	Art.-Nr. art.-no.	€ netto DE excl. VAT	€ brutto DE incl. VAT			
	<b>LIGHT ENGINE</b> Ceiling/Wall S	TRIAC	11 W	2700K	E	1170lm	LE015701	189,08 €	225 €			
				3000K	E	1230lm	LE015702					
				4000K <span style="color: #0070C0;">new</span>	E	1280lm	LE015733					
				1800-3000K dim2warm	F	870lm	LE015703			226,89 €	270 €	
				2700K	E	1170lm	LE015730			214,29 €	255 €	
				3000K	E	1230lm	LE015731					
		4000K <span style="color: #0070C0;">new</span>	E	1280lm	LE015734							
		CASAMBI <span style="color: #0070C0;">new</span>	11 W		2700K	E	1170lm	LE015701C	273,11 €	325 €		
					3000K	E	1230lm	LE015702C				
					4000K	E	1280lm	LE015733C				
					1800-3000K dim2warm	F	870lm	LE015703C			252,10 €	300 €
					2700K	E	1170lm	LE015701C			315,13 €	375 €
3000K	E				1230lm	LE015702C						
4000K	E	1280lm	LE015733C									
	<b>Glas S klar</b> glass S clear	Optik S Spiegel optic S mirror					DO1051	180,67 €	215 €			
	<b>Glas S neusilber</b> glass S new silver	Optik S Spiegel optic S mirror					DO1052	239,50 €	285 €			

 IP40  
modular article protection class

LED       
dimmable Zhaga standard dim2warm CRI >97 SDCM 2

## DON Wall M new

Abbildung figure	Beschreibung description	Regelung control	Leistung power	CCT	EEK EEC	Lumen lumen	Art.-Nr. art.-no.	€ netto DE excl. VAT	€ brutto DE incl. VAT		
	<b>LIGHT ENGINE</b> Ceiling/Wall M	TRIAC	20 W	2700K	F	1910lm	LE015710	252,10 €	300 €		
				3000K	E	2010lm	LE015711				
				4000K <span style="color: #0070C0;">new</span>	E	2080lm	LE015770				
				1800-3000K dim2warm	F	1540lm	LE015712			252,10 €	300 €
				2700K	F	1910lm	LE015713			277,31 €	330 €
				3000K	E	2010lm	LE015714				
		4000K <span style="color: #0070C0;">new</span>	E	2080lm	LE015771						
		CASAMBI <span style="color: #0070C0;">new</span>	20 W		1800-3000K dim2warm	F	1540lm	LE015715	310,92 €	370 €	
					2700K	F	1910lm	LE015713C	361,34 €	430 €	
					3000K	E	2010lm	LE015714C			
					4000K	E	2080lm	LE015770C			
							1800-3000K dim2warm	F	1540lm	LE015715C	394,96 €
	<b>Glas M klar</b> glass M clear				Optik M Spiegel optic M mirror					DO1081	226,89 €
	<b>Glas M neusilber</b> glass M new silver	Optik M Spiegel optic M mirror					DO1082	302,52 €	360 €		

 IP40     
modular article protection class through wiring emergency light option battery option

LED       
dimmable Zhaga standard dim2warm CRI >97 SDCM 2



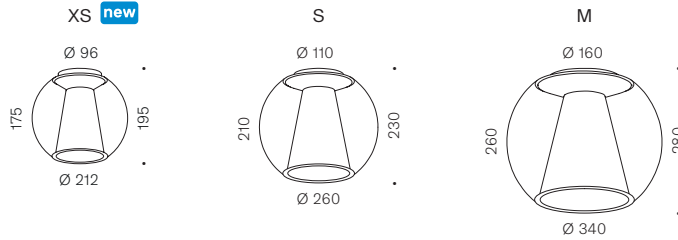

## DON Optik/optic M new

Abbildung figure	Beschreibung description	Art.-Nr. art.-no.	€ netto DE excl. VAT	€ brutto DE incl. VAT
	<b>Optik M/L up/down, Aluminium weiß lackiert</b> optic M/L up/down, aluminium white painted	für alle Versionen geeignet suitable for all versions	CU8544	46,22 € 55 €

# DRAFT Ceiling



## DRAFT Ceiling XS new

Abbildung figure	Beschreibung description	Regelung control	Leistung power	CCT	EEL EEC	Lumen lumen	Art.-Nr. art.-no.	€ netto DE excl. VAT	€ brutto DE incl. VAT
	<span style="color: blue;">new</span> <b>LIGHT ENGINE</b> Ceiling/Wall XS	TRIAC	8 W	2700 K	E	720lm	LE015750	130,25 €	155 €
				3000 K	E	760lm	LE015751		
		DALI	8 W	2700 K	E	720lm	LE015753	151,26 €	180 €
				3000 K	E	760lm	LE015754		
		CASAMBI	8 W	2700 K	E	720lm	LE015753C	214,29 €	255 €
				3000 K	E	760lm	LE015754C		
	<span style="color: blue;">new</span> <b>Glas XS klar mit Reflektor</b> glass XS clear with reflector						DR015720	172,27 €	205 €
	<span style="color: blue;">new</span> <b>Glas XS braun mit Reflektor</b> glass XS brown with reflector						DR015721		
	<span style="color: blue;">new</span> <b>Glas XS blau mit Reflektor</b> glass XS blue with reflector						DR015722	201,68 €	240 €

 modular article
  IP40 protection class
  through wiring

LED
  dimmable
  Zhaga standard
  CRI >97
  SDCM 2

# DRAFT Ceiling S new

Abbildung figure	Beschreibung description	Regelung control	Leistung power	CCT	EEK EEC	Lumen lumen	Art.-Nr. art.-no.	€ netto DE excl. VAT	€ brutto DE incl. VAT		
	<b>LIGHT ENGINE</b> Ceiling/Wall S	TRIAC	11 W	2700 K	E	1170 lm	LE015701	189,08 €	225 €		
				3000 K	E	1230 lm	LE015702				
				4000 K <span style="color: #0070C0;">new</span>	E	1280 lm	LE015733				
				1800-3000 K dim2warm	F	870 lm	LE015703			226,89 €	270 €
				2700 K	E	1170 lm	LE015730			214,29 €	255 €
				3000 K	E	1230 lm	LE015731				
		4000 K <span style="color: #0070C0;">new</span>	E	1280 lm	LE015734						
		CASAMBI <span style="color: #0070C0;">new</span>	11 W	DALI	11 W	1800-3000 K dim2warm	F	870 lm	LE015732	252,10 €	300 €
						2700 K	E	1170 lm	LE015701C	273,11 €	325 €
						3000 K	E	1230 lm	LE015702C		
						4000 K	E	1280 lm	LE015733C		
						1800-3000 K dim2warm	F	870 lm	LE015703C		

	<b>Glas S klar mit Reflektor</b> glass S clear with reflector						DR015728	260,50 €	310 €
---	--	--	--	--	--	--	----------	----------	-------

	<b>Glas S braun mit Reflektor</b> glass S brown with reflector						DR015729		
---	---	--	--	--	--	--	----------	--	--

	<b>Glas S blau mit Reflektor</b> glass S blue with reflector						DR015730	298,32 €	355 €
---	---	--	--	--	--	--	----------	----------	-------

 modular article
  IP40 protection class
  through wiring

LED
  dimmable
  Zhaga standard
  dim2warm
  CRI >97
  SDCM 2





# DRAFT Ceiling M new

Abbildung figure	Beschreibung description	Regelung control	Leistung power	CCT	EЕК EEC	Lumen lumen	Art.-Nr. art.-no.	€ netto DE excl. VAT	€ brutto DE incl. VAT	
	<b>LIGHT ENGINE</b> Ceiling/Wall M	TRIAC	20 W	2700 K	F	1910 lm	LE015710	252,10 €	300 €	
				3000 K	E	2010 lm	LE015711			
				4000 K <span style="color: #0070C0;">new</span>	E	2080 lm	LE015770			
				1800-3000 K dim2warm	F	1540 lm	LE015712			252,10 €
		DALI	20 W		2700 K	F	1910 lm	LE015713	277,31 €	330 €
					3000 K	E	2010 lm	LE015714		
					4000 K <span style="color: #0070C0;">new</span>	E	2080 lm	LE015771		
					1800-3000 K dim2warm	F	1540 lm	LE015715		
		CASAMBI <span style="color: #0070C0;">new</span>	20 W		2700 K	F	1910 lm	LE015713C	361,34 €	430 €
					3000 K	E	2010 lm	LE015714C		
					4000 K	E	2080 lm	LE015770C		
					1800-3000 K dim2warm	F	1540 lm	LE015715C		

	<b>Glas M klar mit Reflektor</b> glass M clear with reflector						DR015731	344,54 €	410 €
---	--	--	--	--	--	--	----------	----------	-------

	<b>Glas M braun mit Reflektor</b> glass M brown with reflector						DR015732		
---	---	--	--	--	--	--	----------	--	--

	<b>Glas M blau mit Reflektor</b> glass M blue with reflector						DR015733	390,76 €	465 €
---	---	--	--	--	--	--	----------	----------	-------



-  modular article
-  IP40 protection class
-  through wiring
-  emergency light option
-  battery option



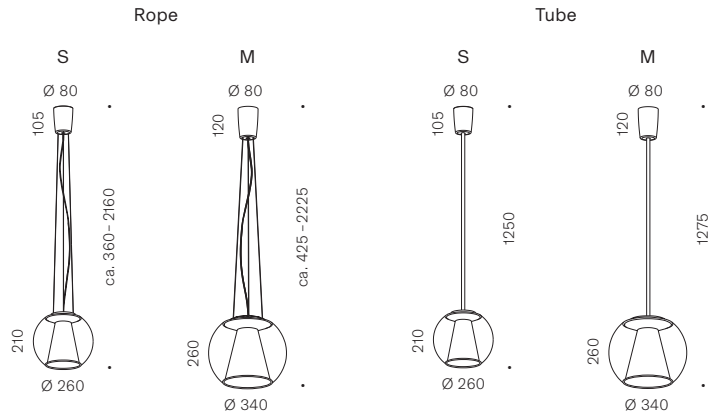

-  LED
-  dimmable
-  Zhaga standard
-  dim2warm
-  CRI >97
-  SDCM 2

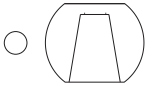
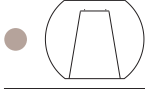
# DRAFT Suspension





## DRAFT Suspension S new





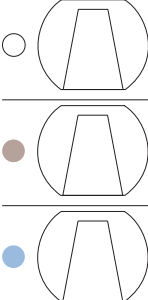

Abbildung figure	Beschreibung description	Regelung control	Leistung power	CCT	EEL EEC	Lumen lumen	Art.-Nr. art.-no.	€ netto DE excl. VAT	€ brutto DE incl. VAT		
	<b>LIGHT ENGINE</b> Suspension Rope S	TRIAC	11 W	2700K	E	1170 lm	LE015704	369,75 €	440 €		
				3000K	E	1230 lm	LE015705				
				4000K <span style="color: blue;">new</span>	E	1280 lm	LE015738				
				1800-3000K dim2warm	F	870 lm	LE015706			399,16 €	475 €
				2700K	E	1170 lm	LE015735			399,16 €	475 €
				3000K	E	1230 lm	LE015736				
		4000K <span style="color: blue;">new</span>	E	1280 lm	LE015739						
		DALI	11 W	1800-3000K dim2warm	F	870 lm	LE015737	428,57 €	510 €		
					2700K	E	1170 lm	LE015704C	453,78 €	540 €	
					3000K	E	1230 lm	LE015736C			
					4000K	E	1280 lm	LE015738C			
					CASAMBI <span style="color: blue;">new</span>	11 W	1800-3000K dim2warm	F	870 lm	LE015737C	474,79 €
2700K	E							1170 lm	LE015707	327,73 €	390 €
3000K	E	1230 lm	LE015708								
4000K <span style="color: blue;">new</span>	E	1280 lm	LE015743								
TRIAC	11 W	1800-3000K dim2warm	F	870 lm				LE015709	361,34 €	430 €	
			2700K	E				1170 lm	LE015740	361,34 €	430 €
			3000K	E	1230 lm	LE015741					
			4000K <span style="color: blue;">new</span>	E	1280 lm	LE015744					
			DALI	11 W	1800-3000K dim2warm	F	870 lm	LE015742	390,76 €	465 €	
						2700K	E	1170 lm	LE015740C	411,76 €	490 €
3000K	E	1230 lm				LE015741C					
4000K	E	1280 lm				LE015743C					
CASAMBI <span style="color: blue;">new</span>	11 W	1800-3000K dim2warm				F	870 lm	LE015742C	445,38 €	530 €	
	<b>Glas S klar mit Reflektor</b> glass S clear with reflector						DR015728	260,50 €	310 €		
	<b>Glas S braun mit Reflektor</b> glass S brown with reflector						DR015729	298,32 €	355 €		
	<b>Glas S blau mit Reflektor</b> glass S blue with reflector						DR015730				

-  modular article
-  IP20 protection class
-  through wiring
-  tube cuttable
-  + length option

- LED**
-  dimmable
-  Zhaga standard
-  dim2warm
-  CRI >97
-  SDCM 3

# DRAFT Suspension M new

Abbildung figure	Beschreibung description	Regelung control	Leistung power	CCT	EK EEC	Lumen lumen	Art.-Nr. art.-no.	€ netto DE excl. VAT	€ brutto DE incl. VAT	
	<b>LIGHT ENGINE</b> Suspension Rope M	TRIAC	27 W	2700 K	F	1910 lm	LE015716			
				3000 K	E	2010 lm	LE015717	445,38 €	530 €	
				4000 K <span style="background-color: #0070C0; color: white; padding: 2px;">new</span>	E	2080 lm	LE015772			
				1800-3000 K dim2warm	F	1540 lm	LE015718	483,19 €	575 €	
				2700 K	F	1910 lm	LE015719			
				3000 K	E	2010 lm	LE015720	474,79 €	565 €	
		DALI	27 W		4000 K <span style="background-color: #0070C0; color: white; padding: 2px;">new</span>	E	2080 lm	LE015773		
					1800-3000 K dim2warm	F	1540 lm	LE015721	512,61 €	610 €
					2700 K	F	1910 lm	LE015716C		
					3000 K	E	2010 lm	LE015720C	525,21 €	625 €
					4000 K	E	2080 lm	LE015773C		
					1800-3000 K dim2warm	F	1540 lm	LE015718C	567,23 €	675 €
	<b>LIGHT ENGINE</b> Suspension Tube M	TRIAC	27 W	2700 K	F	1910 lm	LE015722			
				3000 K	E	2010 lm	LE015723	399,16 €	475 €	
				4000 K <span style="background-color: #0070C0; color: white; padding: 2px;">new</span>	E	2080 lm	LE015728			
				1800-3000 K dim2warm	F	1540 lm	LE015724	436,97 €	520 €	
				2700 K	F	1910 lm	LE015725			
				3000 K	E	2010 lm	LE015726	428,57 €	510 €	
		DALI	27 W		4000 K <span style="background-color: #0070C0; color: white; padding: 2px;">new</span>	E	2080 lm	LE015729		
					1800-3000 K dim2warm	F	1540 lm	LE015727	470,59 €	560 €
					2700 K	F	1910 lm	LE015722C		
					3000 K	E	2010 lm	LE015723C	474,79 €	565 €
					4000 K	E	2080 lm	LE015729C		
					1800-3000 K dim2warm	F	1540 lm	LE015724C	504,20 €	600 €
	<b>Glas M klar mit Reflektor</b> glass M clear with reflector						DR015731	344,54 €	410 €	
		<b>Glas M braun mit Reflektor</b> glass M brown with reflector					DR015732			
									390,76 €	465 €
<b>Glas M blau mit Reflektor</b> glass M blue with reflector						DR015733				

-  modular article
-  IP20 protection class
-  through wiring
-  tube cuttable
-  + length option
-  emergency light option

- LED
-  dimmable
-  Zhaga standard
-  dim2warm
-  CRI >97
-  SDCM 3

**Winkeladapter für Dachschrägen in weiß erhältlich – Montagehilfe für einfache Installation.**

**Der Winkel kann individuell angefertigt werden – Sonderfarben auf Anfrage.**

**Bestellungen (Art.-Nr.: ZB1012) bitte in Abstimmung mit dem Vertrieb.**

Angle brackets for sloping roofs available in white – to assist with easy installation.

The brackets can be made to measure – special colours available on request.

Please coordinate orders (art.-no.: ZB1012) with the sales department.



# DRUM Ceiling

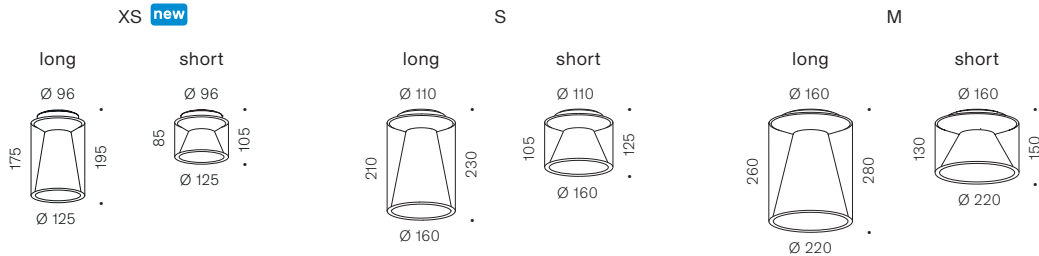



**Black Edition – Leuchtenkörper und Innenschirm in mattem Schwarz – für eine besonders eindrucksvolle, magische Lichtwirkung.**

**Bei Fragen zur Sonderedition wenden Sie sich bitte an den Vertrieb.**

Black Edition – Lamp body and inner shade in matt black – for a particularly striking, magical lighting effect.

If you have any questions about the special edition, please contact our sales department.



## DRUM Ceiling XS **new**

Abbildung figure	Beschreibung description	Regelung control	Leistung power	CCT	EEK EEC	Lumen lumen	Art.-Nr. art.-no.	€ netto DE excl. VAT	€ brutto DE incl. VAT
 <b>new</b>	<b>LIGHT ENGINE</b> Ceiling/Wall XS	TRIAC	8 W	2700 K	E	720 lm	LE015750	130,25 €	155 €
				3000 K	E	760 lm	LE015751		
		DALI	8 W	2700 K	E	720 lm	LE015753	151,26 €	180 €
				3000 K	E	760 lm	LE015754		
		CASAMBI	8 W	2700 K	E	720 lm	LE015753C	214,29 €	255 €
				3000 K	E	760 lm	LE015754C		
 <b>new</b>	<b>Glas XS long mit Reflektor</b> glass XS long with reflector						DU015806	163,87 €	195 €
 <b>new</b>	<b>Glas XS short mit Reflektor</b> glass XS short with reflector						DU015805	126,05 €	150 €

+ IP40  
modular article protection class

LED  dimmable  Zhaga standard  CRI >97  SDCM 2



## DRUM Ceiling S new



Abbildung figure	Beschreibung description	Regelung control	Leistung power	CCT	EEL EEC	Lumen lumen	Art.-Nr. art.-no.	€ netto DE excl. VAT	€ brutto DE incl. VAT		
	<b>LIGHT ENGINE</b> Ceiling/Wall S	TRIAC	11 W	2700 K	E	1170 lm	LE015701	189,08 €	225 €		
				3000 K	E	1230 lm	LE015702				
				4000 K <span style="color: #0070C0;">new</span>	E	1280 lm	LE015733				
				1800-3000 K dim2warm	F	870 lm	LE015703			226,89 €	270 €
				2700 K	E	1170 lm	LE015730			214,29 €	255 €
				3000 K	E	1230 lm	LE015731				
		4000 K <span style="color: #0070C0;">new</span>	E	1280 lm	LE015734						
		1800-3000 K dim2warm	F	870 lm	LE015732	252,10 €	300 €				
		2700 K	E	1170 lm	LE015701C	273,11 €	325 €				
		3000 K	E	1230 lm	LE015702C						
		4000 K	E	1280 lm	LE015733C						
				CASAMBI <span style="color: #0070C0;">new</span>	11 W	1800-3000 K dim2warm	F	870 lm	LE015703C	315,13 €	375 €
	<b>Glas S long mit Reflektor</b> glass S long with reflector						DU015801	197,48 €	235 €		
	<b>Glas S short mit Reflektor</b> glass S short with reflector						DU015802	151,26 €	180 €		





 **IP40**  
modular protection  
article class

**LED**  dimmable  Zhaga standard  dim2warm  CRI >97  SDCM 2

## DRUM Ceiling M new

Abbildung figure	Beschreibung description	Regelung control	Leistung power	CCT	Lu- men lumen	EEL EEC	Art.-Nr. art.-no.	€ netto DE excl. VAT	€ brutto DE incl. VAT		
	<b>LIGHT ENGINE</b> Ceiling/Wall M	TRIAC	20 W	2700 K	F	1910 lm	LE015710	252,10 €	300 €		
				3000 K	E	2010 lm	LE015711				
				4000 K <span style="color: #0070C0;">new</span>	E	2080 lm	LE015770				
				1800-3000 K dim2warm	F	1540 lm	LE015712			252,10 €	300 €
				2700 K	F	1910 lm	LE015713			277,31 €	330 €
				3000 K	E	2010 lm	LE015714				
		4000 K <span style="color: #0070C0;">new</span>	E	2080 lm	LE015771						
		1800-3000 K dim2warm	F	1540 lm	LE015715	310,92 €	370 €				
		2700 K	F	1910 lm	LE015713C	361,34 €	430 €				
		3000 K	E	2010 lm	LE015714C						
		4000 K	E	2080 lm	LE015770C						
				CASAMBI <span style="color: #0070C0;">new</span>	20 W	1800-3000 K dim2warm	F	1540 lm	LE015715C	394,96 €	470 €
	<b>Glas M long mit Reflektor</b> glass M long with reflector						DU015803	235,29 €	280 €		
	<b>Glas M short mit Reflektor</b> glass M short with reflector						DU015804	180,67 €	215 €		





 **IP40**  emergency light option  battery option  
modular protection emergency battery  
article class light option option

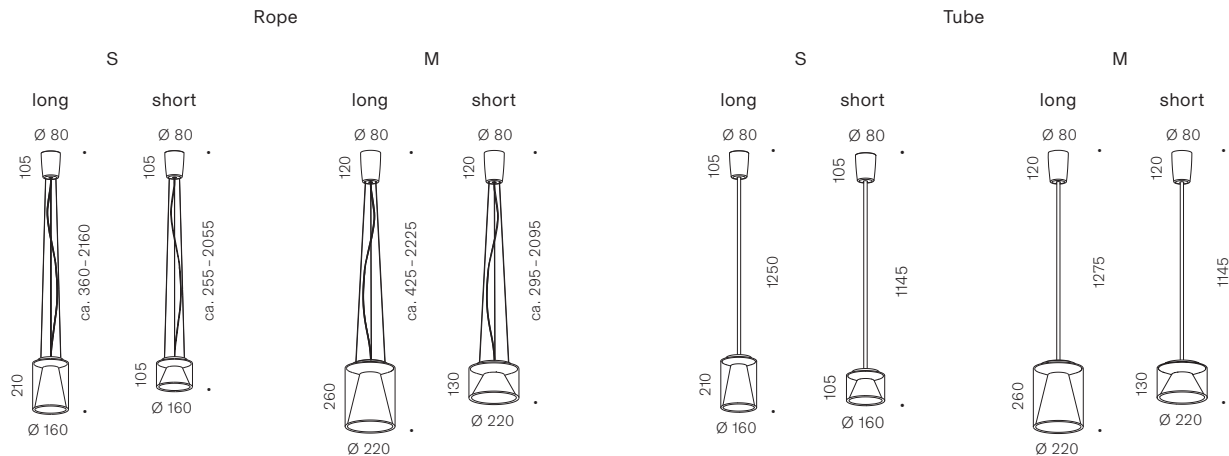



**LED**  dimmable  Zhaga standard  dim2warm  CRI >97  SDCM 2

# DRUM Suspension







## DRUM Suspension S new

Abbildung figure	Beschreibung description	Regelung control	Leistung power	CCT	EK EEC	Lumen lumen	Art.-Nr. art.-no.	€ netto DE excl. VAT	€ brutto DE incl. VAT							
	<b>LIGHT ENGINE</b> Suspension Rope S	TRIAC	11 W	2700K	E	1170 lm	LE015704									
				3000K	E	1230 lm	LE015705	369,75 €	440 €							
				4000K <span style="color: blue;">new</span>	E	1280 lm	LE015738									
				1800-3000K dim2warm	F	870 lm	LE015706	399,16 €	475 €							
				2700K	E	1170 lm	LE015735									
				3000K	E	1230 lm	LE015736	399,16 €	475 €							
		DALI	11 W	4000K <span style="color: blue;">new</span>	E	1280 lm	LE015739	LE015737	428,57 €	510 €						
											1800-3000K dim2warm	F	870 lm	LE015737	428,57 €	510 €
											2700K	E	1170 lm	LE015704C		
											3000K	E	1230 lm	LE015736C	453,78 €	540 €
											4000K	E	1280 lm	LE015738C		
											1800-3000K dim2warm	F	870 lm	LE015737C	474,79 €	565 €
	<b>LIGHT ENGINE</b> Suspension Tube S	TRIAC	11 W	2700K	E	1170 lm	LE015707									
				3000K	E	1230 lm	LE015708	327,73 €	390 €							
				4000K <span style="color: blue;">new</span>	E	1280 lm	LE015743									
				1800-3000K dim2warm	F	870 lm	LE015709	361,34 €	430 €							
				2700K	E	1170 lm	LE015740									
				3000K	E	1230 lm	LE015741	361,34 €	430 €							
		DALI	11 W	4000K <span style="color: blue;">new</span>	E	1280 lm	LE015744	LE015742	390,76 €	465 €						
											1800-3000K dim2warm	F	870 lm	LE015742	390,76 €	465 €
											2700K	E	1170 lm	LE015740C		
											3000K	E	1230 lm	LE015741C	411,76 €	490 €
											4000K	E	1280 lm	LE015743C		
											1800-3000K dim2warm	F	870 lm	LE015742C	445,38 €	530 €
	<b>Glas S long mit Reflektor</b> glass S long with reflector						DU015801	197,48 €	235 €							
	<b>Glas S short mit Reflektor</b> glass S short with reflector						DU015802	151,26 €	180 €							

 modular article  
 IP20 protection class  
 tube cuttable  
 + length option

 LED  
 dimmable  
 Zhaga standard  
 dim2warm  
 CRI >97  
 SDCM 3

# DRUM Suspension M new

Abbildung figure	Beschreibung description	Regelung control	Leistung power	CCT	EELCC	Lumen lumen	Art.-Nr. art.-no.	€ netto DE excl. VAT	€ brutto DE incl. VAT		
	<b>LIGHT ENGINE</b> Suspension Rope M	TRIAC	27 W	2700 K	F	1910 lm	LE015716	445,38 €	530 €		
				3000 K	E	2010 lm	LE015717				
				4000 K <span style="color: #0070C0;">new</span>	E	2080 lm	LE015772				
				1800-3000 K dim2warm	F	1540 lm	LE015718			483,19 €	575 €
				2700 K	F	1910 lm	LE015719			474,79 €	565 €
				3000 K	E	2010 lm	LE015720				
		4000 K <span style="color: #0070C0;">new</span>	E	2080 lm	LE015773						
		1800-3000 K dim2warm	F	1540 lm	LE015721	512,61 €	610 €				
		2700 K	F	1910 lm	LE015716C	525,21 €	625 €				
		3000 K	E	2010 lm	LE015720C						
		4000 K	E	2080 lm	LE015773C						
		1800-3000 K dim2warm	F	1540 lm	LE015718C			567,23 €	675 €		
	<b>LIGHT ENGINE</b> Suspension Tube M	TRIAC	27 W	2700 K	F			1910 lm	LE015722	399,16 €	475 €
				3000 K	E			2010 lm	LE015723		
				4000 K <span style="color: #0070C0;">new</span>	E	2080 lm	LE015728				
				1800-3000 K dim2warm	F	1540 lm	LE015724	436,97 €	520 €		
				2700 K	F	1910 lm	LE015725	428,57 €	510 €		
				3000 K	E	2010 lm	LE015726				
		4000 K <span style="color: #0070C0;">new</span>	E	2080 lm	LE015729						
		1800-3000 K dim2warm	F	1540 lm	LE015727	470,59 €	560 €				
		2700 K	F	1910 lm	LE015722C	474,79 €	565 €				
		3000 K	E	2010 lm	LE015723C						
		4000 K	E	2080 lm	LE015729C						
		1800-3000 K dim2warm	F	1540 lm	LE015724C			504,20 €	600 €		
	<b>Glas M long mit Reflektor</b> glass M long with reflector								DU015803	235,29 €	280 €
	<b>Glas M short mit Reflektor</b> glass M short with reflector								DU015804	180,67 €	215 €

 modular article

 IP20 protection class

 tube cuttable

 + length option

 emergency light option

LED

 dimmable

 Zhaga standard

 dim2warm

 CRI >97

 SDCM 3



**Black Edition – Leuchtenkörper und Innenschirm in mattem Schwarz – für eine besonders eindrucksvolle, magische Lichtwirkung. Bei Fragen zur Sonderedition wenden Sie sich bitte an den Vertrieb.**  
Black Edition – Lamp body and inner shade in matt black – for a particularly striking, magical lighting effect.  
If you have any questions about the special edition, please contact our sales department.



**Winkeladapter für Dachschrägen in weiß erhältlich – Montagehilfe für einfache Installation. Der Winkel kann individuell angefertigt werden – Sonderfarben auf Anfrage. Bestellungen (Art.-Nr.: ZB1012) bitte in Abstimmung mit dem Vertrieb.**  
Angle brackets for sloping roofs available in white – to assist with easy installation.  
The brackets can be made to measure – special colours available on request.  
Please coordinate orders (art.-no.: ZB1012) with the sales department.

# JOB Table

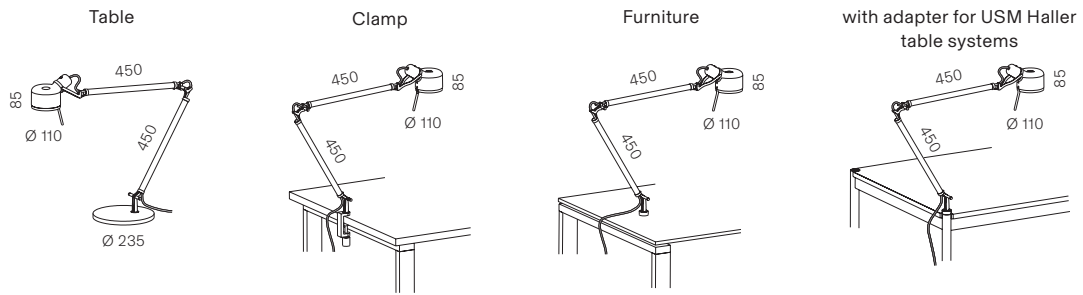

## JOB Table

Abbildung figure	Beschreibung description	Leuchtmittel lamp	Regelung control	Leistung power	CCT	EEK EEC	Lumen lumen	Art.-Nr. art.-no.	€ netto DE excl. VAT	€ brutto DE incl. VAT
	<b>Table</b>	LED E27	integr.	13 W	2200-2700 K dim2warm	E	1521 lm	JB1013	1.218,49 €	1.450 €
	<b>Clamp</b>	LED E27	integr.	13 W	2200-2700 K dim2warm	E	1521 lm	JB1014	1.025,21 €	1.220 €
	<b>Furniture</b>	LED E27	integr.	13 W	2200-2700 K dim2warm	E	1521 lm	JB1015	941,18 €	1.120 €
	<b>mit Adapter für USM Haller Tischsysteme with adapter for USM Haller table systems</b>	LED E27	integr.	13 W	2200-2700 K dim2warm	E	1521 lm	JB1016	941,18 €	1.120 €

IP20  
protection  
class

  
lamp  
included

 dimmable

 dim2warm

 CRI >90

# JONES Floor

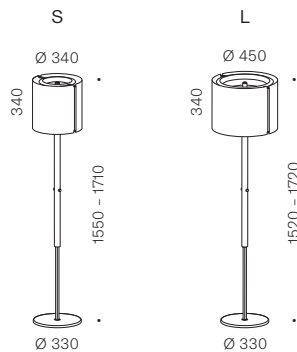

## JONES Floor

Abbildung figure	Beschreibung description	Leuchtmittel lamp	Regelung control	Leistung power	CCT	EEK EEC	Lumen lumen	Art.-Nr. art.-no.	€ netto DE excl. VAT	€ brutto DE incl. VAT
●	<b>S gebürstet</b> S brushed	LED	integr.	38 W	2700 K	E	3500lm	JO3006	1.672,27 €	1.990 €
		E27	integr.	max. 205 W	3000 K	G	4200lm	JO1010	1.252,10 €	1.490 €
●	<b>L gebürstet</b> L brushed	LED	integr.	38 W	2700 K	E	3500lm	JO3003	1.672,27 €	1.990 €
		E27	integr.	max. 205 W	3000 K	G	4200lm	JO1007	1.252,10 €	1.490 €
●	<b>S schwarz</b> S black	LED	integr.	38 W	2700 K	E	3500lm	JO3106	1.672,27 €	1.990 €
		E27	integr.	max. 205 W	3000 K	G	4200lm	JO1007		
●	<b>L schwarz</b> L black	LED	integr.	38 W	2700 K	E	3500lm	JO3103	1.672,27 €	1.990 €
		E27	integr.	max. 205 W	3000 K	G	4200lm	JO1007		



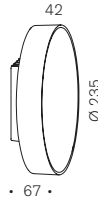

IP20  
protection  
class

 dimmable
  Zhaga  
standard
  CRI >97
  SDCM 2

# LYD Wall







## LYD Wall

Abbildung figure	Beschreibung description	Regelung control	Leistung power	CCT	EEK EEC	Lumen lumen	Art.-Nr. art.-no.	€ netto DE excl. VAT	€ brutto DE incl. VAT
	<b>Leuchteinheit LYD</b> lighting unit LYD	TRIAC	16 W	2700K	E	1970lm	LD1001	319,33 €	380 €
				3000K	E	2010lm	LD1002		
		DALI	22 W	2700K	E	1970lm	LD1005	357,14 €	425 €
				3000K	E	2010lm	LD1006		
	<b>Front Aluminium champagner eloxiert</b> front aluminium champagne anodized						LD1103	100,84 €	120 €
	<b>Front Aluminium silber eloxiert</b> front aluminium silver anodized						LD1104		
	<b>Front Echtglas opal</b> front genuine glass opal						LD1101	142,86 €	170 €
	<b>Front Spiegel</b> front genuine glass mirror						LD1102		



## LYD Wall IP44

Abbildung figure	Beschreibung description	Regelung control	Leistung power	CCT	EEK EEC	Lumen lumen	Art.-Nr. art.-no.	€ netto DE excl. VAT	€ brutto DE incl. VAT
	<b>Leuchteinheit LYD IP44</b> lighting unit LYD IP44	TRIAC	16 W	2700K	E	1970lm	LD1201	357,14 €	425 €
				3000K	E	2010lm	LD1202		
		DALI	22 W	2700K	E	1970lm	LD1205	382,35 €	455 €
				3000K	E	2010lm	LD1206		
	<b>IP44 Front Aluminium champagner eloxiert</b> front aluminium champagne anodized						LD1303	126,05 €	150 €
	<b>IP44 Front Aluminium silber eloxiert</b> front aluminium silver anodized						LD1304		
	<b>IP44 Front Echtglas opal</b> front genuine glass opal						LD1301	159,66 €	190 €
	<b>IP44 Front Spiegel</b> front genuine glass mirror						LD1302		



## Zubehör/Accessories

Abbildung figure	Beschreibung description	Art.-Nr. art.-no.	€ netto DE excl. VAT	€ brutto DE incl. VAT
	<b>Spiegeladapter Set</b> mirror adapter set	ZB1001	37,82 €	45 €

# ONE EIGHTY Suspension

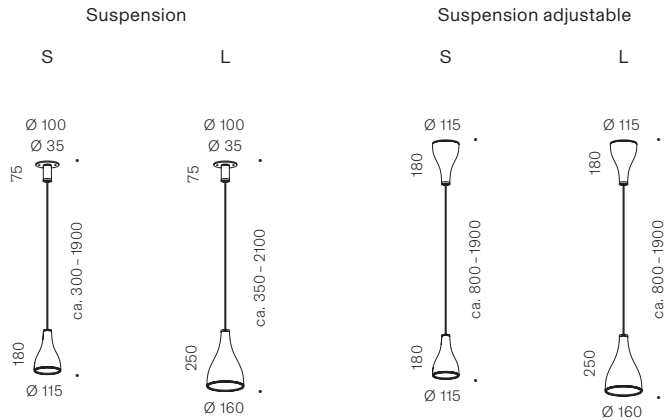

## ONE EIGHTY Suspension

Abbildung figure	Beschreibung description	Fassung socket	Regelung control	Leistung power	E EK EEC	Art.-Nr. art.-no.	€ netto DE excl. VAT	€ brutto DE incl. VAT
●	<b>S schwarz</b> S black	GU10	TRIAC	max. 60 W	G	OE1021	336,13 €	400 €
○	<b>S weiß</b> S white	GU10	TRIAC	max. 60 W	G	OE1003		
●	<b>S höhenverstellbar, schwarz</b> S adjustable, black	GU10	TRIAC	max. 60 W	G	OE1022	420,17 €	500 €
○	<b>S höhenverstellbar, weiß</b> S adjustable, white	GU10	TRIAC	max. 60 W	G	OE1004		
●	<b>L schwarz</b> L black	E27	TRIAC	max. 100 W	G	OE1023	378,15 €	450 €
○	<b>L weiß</b> L white	E27	TRIAC	max. 100 W	G	OE1007		
●	<b>L höhenverstellbar, schwarz</b> L adjustable, black	E27	TRIAC	max. 100 W	G	OE1024	478,99 €	570 €
○	<b>L höhenverstellbar, weiß</b> L adjustable, white	E27	TRIAC	max. 100 W	G	OE1008		

IP20  
protection  
class

  
dimmable

# POPPY Ceiling/Wall

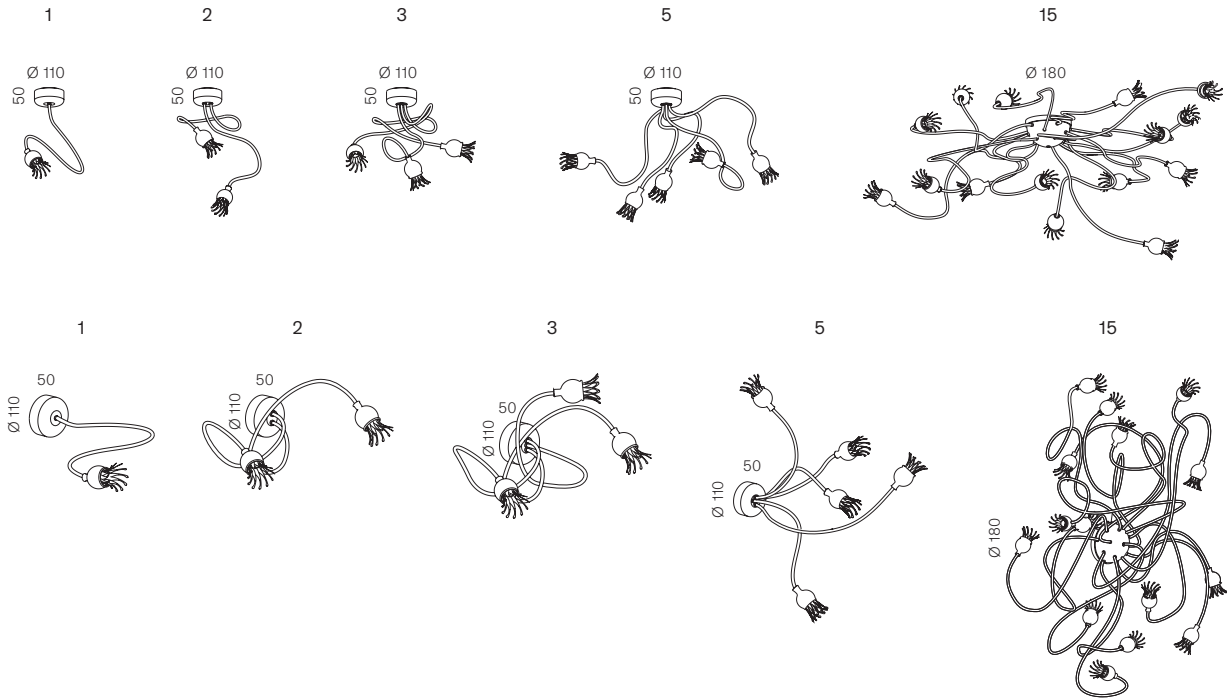

## POPPY Ceiling/Wall





































Abbildung figure	Beschreibung description	Fassung socket	Regelung control	Leistung power	E EK EEC	Art.-Nr. art.-no.	€ netto DE excl. VAT	€ brutto DE incl. VAT
	<b>1 Arm schwarz, Schirm keramik</b> 1 arm black, shade ceramic	G4	ON/OFF	max. 35 W	G	PO1025		
	<b>1 Arm schwarz, Schirm rubinrot</b> 1 arm black, shade ruby red	G4	ON/OFF	max. 35 W	G	PO1026		
	<b>1 Arm schwarz, Schirm violett</b> 1 arm black, shade violet	G4	ON/OFF	max. 35 W	G	PO1027		
	<b>1 Arm beige, Schirm keramik</b> 1 arm beige shade ceramic	G4	ON/OFF	max. 35 W	G	PO1028	394,96 €	470 €
	<b>1 Arm beige, Schirm rubinrot</b> 1 arm beige shade ruby red	G4	ON/OFF	max. 35 W	G	PO1029		
	<b>1 Arm beige, Schirm violett</b> 1 arm beige shade violet	G4	ON/OFF	max. 35 W	G	PO1030		
	<b>2 Arme schwarz, Schirme keramik</b> 2 arms black, shades ceramic	2 × G4	ON/OFF	max. 70 W	G	PO1031		
	<b>2 Arme schwarz, Schirme rubinrot</b> 2 arms black, shades ruby red	2 × G4	ON/OFF	max. 70 W	G	PO1032		
	<b>2 Arme schwarz, Schirme violett</b> 2 arms black, shades violet	2 × G4	ON/OFF	max. 70 W	G	PO1033		
	<b>2 Arme beige, Schirme keramik</b> 2 arms beige shades ceramic	2 × G4	ON/OFF	max. 70 W	G	PO1034	495,80 €	590 €
	<b>2 Arme beige, Schirme rubinrot</b> 2 arms beige shades ruby red	2 × G4	ON/OFF	max. 70 W	G	PO1035		
	<b>2 Arme beige, Schirme violett</b> 2 arms beige shades violet	2 × G4	ON/OFF	max. 70 W	G	PO1036		





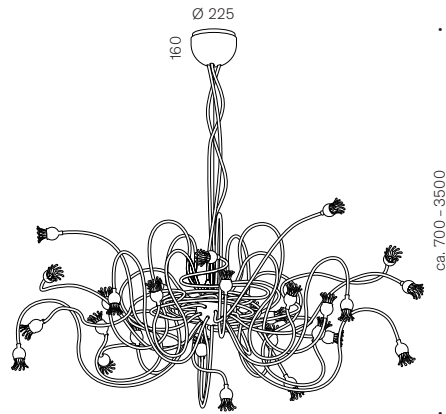

Abbildung figure	Beschreibung description	Fassung socket	Regelung control	Leistung power	EEK EEC	Art.-Nr. art.-no.	€ netto DE excl. VAT	€ brutto DE incl. VAT
	<b>3 Arme schwarz, Schirme keramik</b> 3 arms black, shades ceramic	3 × G4	ON/OFF	max. 105 W	G	PO1037		
	<b>3 Arme schwarz, Schirme rubinrot</b> 3 arms black, shades ruby red	3 × G4	ON/OFF	max. 105 W	G	PO1038		
	<b>3 Arme schwarz, Schirme violett</b> 3 arms black, shades violet	3 × G4	ON/OFF	max. 105 W	G	PO1039		
	<b>3 Arme beige, Schirme keramik</b> 3 arms beige shades ceramic	3 × G4	ON/OFF	max. 105 W	G	PO1040	596,64 €	710 €
	<b>3 Arme beige, Schirme rubinrot</b> 3 arms beige shades ruby red	3 × G4	ON/OFF	max. 105 W	G	PO1041		
	<b>3 Arme beige, Schirme violett</b> 3 arms beige shades violet	3 × G4	ON/OFF	max. 105 W	G	PO1042		
	<b>5 Arme schwarz, Schirme keramik</b> 5 arms black, shades ceramic	5 × G4	ON/OFF	max. 100 W	G	PO1043		
	<b>5 Arme schwarz, Schirme rubinrot</b> 5 arms black, shades ruby red	5 × G4	ON/OFF	max. 100 W	G	PO1044		
	<b>5 Arme schwarz, Schirme violett</b> 5 arms black, shades violet	5 × G4	ON/OFF	max. 100 W	G	PO1045		
	<b>5 Arme beige, Schirme keramik</b> 5 arms beige shades ceramic	5 × G4	ON/OFF	max. 100 W	G	PO1046	773,11 €	920 €
	<b>5 Arme beige, Schirme rubinrot</b> 5 arms beige shades ruby red	5 × G4	ON/OFF	max. 100 W	G	PO1047		
	<b>5 Arme beige, Schirme violett</b> 5 arms beige shades violet	5 × G4	ON/OFF	max. 100 W	G	PO1048		
	<b>15 Arme 75 cm schwarz, Schirme keramik</b> 15 arms 75 cm black, shades ceramic	15 × G4	ON/OFF	max. 300 W	G	PO1007		
	<b>15 Arme 75 cm schwarz, Schirme rubinrot</b> 15 arms 75 cm black, shades ruby red	15 × G4	ON/OFF	max. 300 W	G	PO1008		
	<b>15 Arme 75 cm schwarz, Schirme violett</b> 15 arms 75 cm black, shades violet	15 × G4	ON/OFF	max. 300 W	G	PO1009		
	<b>15 Arme 75 cm beige, Schirme keramik</b> 15 arms 75 cm beige, shades ceramic	15 × G4	ON/OFF	max. 300 W	G	PO1013	1.764,71 €	2.100 €
	<b>15 Arme 75 cm beige, Schirme rubinrot</b> 15 arms 75 cm beige, shades ruby red	15 × G4	ON/OFF	max. 300 W	G	PO1014		
	<b>15 Arme 75 cm beige, Schirme violett</b> 15 arms 75 cm beige, shades violet	15 × G4	ON/OFF	max. 300 W	G	PO1015		
	<b>15 Arme 150 cm schwarz, Schirme keramik</b> 15 arms 150 cm black, shades ceramic	15 × G4	ON/OFF	max. 300 W	G	PO1010		
	<b>15 Arme 150 cm schwarz, Schirme rubinrot</b> arms 150 cm black, shades ruby red	15 × G4	ON/OFF	max. 300 W	G	PO1011		
	<b>15 Arme 150 cm schwarz, Schirme violett</b> 15 arms 150 cm black, shades violet	15 × G4	ON/OFF	max. 300 W	G	PO1012		
	<b>15 Arme 150 cm beige, Schirme keramik</b> 15 arms 150 cm beige, shades ceramic	15 × G4	ON/OFF	max. 300 W	G	PO1016	1.848,74 €	2.200 €
	<b>15 Arme 150 cm beige, Schirme rubinrot</b> 15 arms 150 cm beige, shades ruby red	15 × G4	ON/OFF	max. 300 W	G	PO1017		
	<b>15 Arme 150 cm beige, Schirme violett</b> 15 arms 150 cm beige, shades violet	15 × G4	ON/OFF	max. 300 W	G	PO1018		

IP20   
protection class lamp included

# POPPY Suspension



## POPPY Suspension





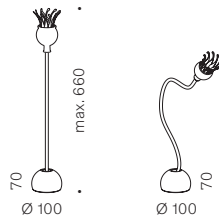

Abbildung figure	Beschreibung description	Fassung socket	Regelung control	Leistung power	E EK EEC	Art.-Nr. art.-no.	€ netto DE excl. VAT	€ brutto DE incl. VAT
	<b>30 Arme schwarz, Schirme keramik</b> 30 arms black, shades ceramic	30 × G4	ON/OFF	max. 600 W	G	PO1004		
	<b>30 Arme schwarz, Schirme rubinrot</b> 30 arms black, shades red	30 × G4	ON/OFF	max. 600 W	G	PO1005		
	<b>30 Arme schwarz, Schirme violett</b> 30 arms black, shades violet	30 × G4	ON/OFF	max. 600 W	G	PO1006		
	<b>30 Arme beige, Schirme keramik</b> 30 arms beige shades ceramic	30 × G4	ON/OFF	max. 600 W	G	PO1019	4.369,75 €	5.200 €
	<b>30 Arme beige, Schirme rubinrot</b> 30 arms beige shades red	30 × G4	ON/OFF	max. 600 W	G	PO1020		
	<b>30 Arme beige, Schirme violett</b> 30 arms beige shades violet	30 × G4	ON/OFF	max. 600 W	G	PO1021		

IP20   
protection class lamp included

# POPPY Table



## POPPY Table

Abbildung figure	Beschreibung description	Fassung socket	Regelung control	Leistung power	EEK EEC	Art.-Nr. art.-no.	€ netto DE excl. VAT	€ brutto DE incl. VAT
	<b>Arme schwarz, Schirm keramik</b> arms black, shade ceramic	G4	ON/OFF	max. 35 W	G	PO1001		
	<b>Arme schwarz, Schirm rubinrot</b> arms black, shade ruby red	G4	ON/OFF	max. 35 W	G	PO1002		
	<b>Arme schwarz, Schirm violett</b> arms black, shade violet	G4	ON/OFF	max. 35 W	G	PO1003		
	<b>Arme beige, Schirm keramik</b> arms beige shade ceramic	G4	ON/OFF	max. 35 W	G	PO1022	352,94 €	420 €
	<b>Arme beige, Schirm rubinrot</b> arms beige shade ruby red	G4	ON/OFF	max. 35 W	G	PO1023		
	<b>Arme beige, Schirm violett</b> arms beige shade violet	G4	ON/OFF	max. 35 W	G	PO1024		

IP20   
protection class lamp included

# POPPY Floor

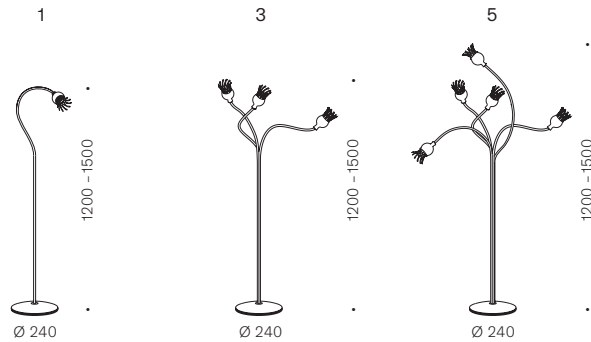

## POPPY Floor

Abbildung figure	Beschreibung description	Fassung lamp	Regelung control	Leistung power	E EK EEC	Art.-Nr. art.-no.	€ netto DE excl. VAT	€ brutto DE incl. VAT
	<b>1 Arm schwarz, Schirm keramik</b> 1 arm black, shade ceramic	G4 35 W	ON/OFF	35 W	G	PO1052	495,80 €	590 €
	<b>1 Arm schwarz, Schirm rubinrot</b> 1 arm black, shade red	G4 35 W	ON/OFF	35 W	G	PO1051		
	<b>1 Arm schwarz, Schirm violett</b> 1 arm black, shade violet	G4 35 W	ON/OFF	35 W	G	PO1050		
	<b>1 Arm beige, Schirm keramik</b> 1 arm beige shade ceramic	G4 35 W	ON/OFF	35 W	G	PO1055		
	<b>1 Arm beige, Schirm rubinrot</b> 1 arm beige shade red	G4 35 W	ON/OFF	35 W	G	PO1054		
	<b>1 Arm beige, Schirm violett</b> 1 arm beige shade violet	G4 35 W	ON/OFF	35 W	G	PO1053		
	<b>3 Arme schwarz, Schirme keramik</b> 3 arms black, shades ceramic	3 × G4 35 W	ON/OFF	105 W	G	PO1058	689,08 €	820 €
	<b>3 Arme schwarz, Schirme rubinrot</b> 3 arms black, shades red	3 × G4 35 W	ON/OFF	105 W	G	PO1057		
	<b>3 Arme schwarz, Schirme violett</b> 3 arms black, shades violet	3 × G4 35 W	ON/OFF	105 W	G	PO1056		
	<b>3 Arme beige, Schirme keramik</b> 3 arms beige shades ceramic	3 × G4 35 W	ON/OFF	105 W	G	PO1061		
	<b>3 Arme beige, Schirme rubinrot</b> 3 arms beige shades red	3 × G4 35 W	ON/OFF	105 W	G	PO1060		
	<b>3 Arme beige, Schirme violett</b> 3 arms beige shades violet	3 × G4 35 W	ON/OFF	105 W	G	PO1059		
	<b>5 Arme schwarz, Schirme keramik</b> 5 arms black, shades ceramic	5 × G4 20 W	ON/OFF	100 W	G	PO1064	873,95 €	1.040 €
	<b>5 Arme schwarz, Schirme rubinrot</b> 5 arms black, shades red	5 × G4 20 W	ON/OFF	100 W	G	PO1063		
	<b>5 Arme schwarz, Schirme violett</b> 5 arms black, shades violet	5 × G4 20 W	ON/OFF	100 W	G	PO1062		
	<b>5 Arme beige, Schirme keramik</b> 5 arms beige shades ceramic	5 × G4 20 W	ON/OFF	100 W	G	PO1067		
	<b>5 Arme beige, Schirme rubinrot</b> 5 arms beige shades red	5 × G4 20 W	ON/OFF	100 W	G	PO1066		
	<b>5 Arme beige, Schirme violett</b> 5 arms beige shades violet	5 × G4 20 W	ON/OFF	100 W	G	PO1065		

IP20 lamp  
protection class included

# REEF Ceiling

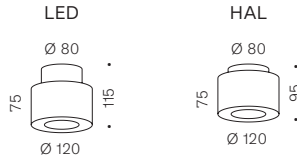

## REEF Ceiling

Abbildung figure	Beschreibung description	Leuchtmittel lamp	Regelung control	Leistung power	CCT	EEK EEC	Lumen lumen	Art.-Nr. art.-no.	€ netto DE excl. VAT	€ brutto DE incl. VAT
●	<b>gebürstet</b> brushed	LED	TRIAC	8 W	2700 K	F	680 lm	RF2007	336,13 €	400 €
		G9	TRIAC	max. 33 W	2700 K	G	460 lm	RF1012	210,08 €	250 €
●	<b>poliert</b> polished	LED	TRIAC	8 W	2700 K	E	680 lm	RF2009	344,54 €	410 €
		G9	TRIAC	max. 33 W	2700 K	F	460 lm	RF1017	218,49 €	260 €

IP20  
protection class



# REEF Suspension

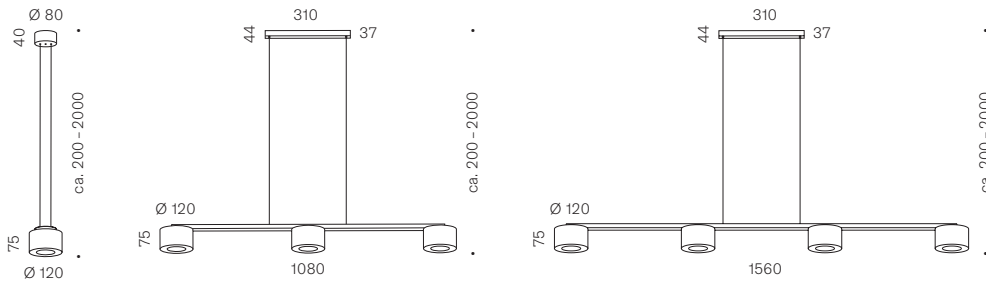

## REEF Suspension

Abbildung figure	Beschreibung description	Regelung control	Leistung power	CCT	EEK EEC	Lumen lumen	Art.-Nr. art.-no.	€ netto DE excl. VAT	€ brutto DE incl. VAT
●	<b>1 gebürstet</b> 1 brushed	TRIAC	8 W	2700 K	F	680 lm	RF2018	373,95 €	445 €
●	<b>1 poliert</b> 1 polished	TRIAC	8 W	2700 K	F	680 lm	RF2017		
●	<b>3 gebürstet</b> 3 brushed	LED	26 W	2700 K	F	2400 lm	RF2021	1.134,45 €	1.350 €
		3 × G9	TRIAC	max. 180 W	2700 K	F	2940 lm	RF1006	890,76 €
●	<b>4 gebürstet</b> 4 brushed	LED	38 W	2700 K	F	3190 lm	RF2031	1.302,52 €	1.550 €
		4 × G9	TRIAC	max. 240 W	2700 K	F	3020 lm	RF1008	991,60 €

IP20  
protection class



# REEF Wall

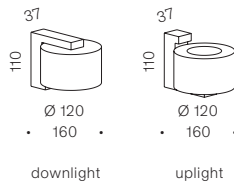

## REEF Wall

Abbildung figure	Beschreibung description	Leuchtmittel lamp	Regelung control	Leistung power	CCT	EEL EEC	Lumen lumen	Art.-Nr. art.-no.	€ netto DE excl. VAT	€ brutto DE incl. VAT
●	<b>gebürstet</b> brushed	LED	TRIAC	8 W	2700 K	F	680 lm	RF2057	386,55 €	460 €
		G9	TRIAC	max. 60 W	2700 K	G	740 lm	RF1002	289,92 €	345 €
●	<b>poliert</b> polished	LED	TRIAC	8 W	2700 K	F	680 lm	RF2058	411,76 €	490 €
		G9	TRIAC	max. 60 W	2700 K	G	740 lm	RF1001	310,92 €	370 €

IP20  
protection  
class

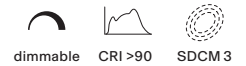

## Zubehör/Accessories

Abbildung figure	Beschreibung description	Art.-Nr. art.-no.	€ netto DE excl. VAT	€ brutto DE incl. VAT
	<b>Spiegeladapter Set ROD</b> mirror adapter set ROD	ZB1004	37,82 €	45 €

# REFLEX<sup>2</sup> Ceiling

S

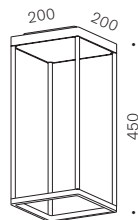
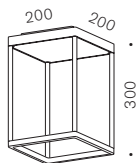
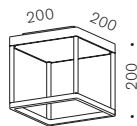
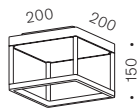

M

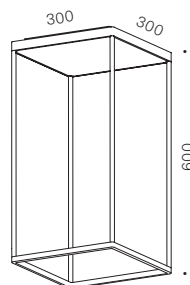
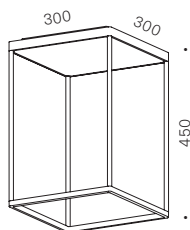
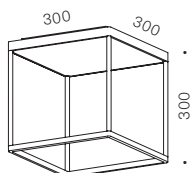
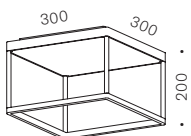
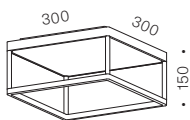

XL

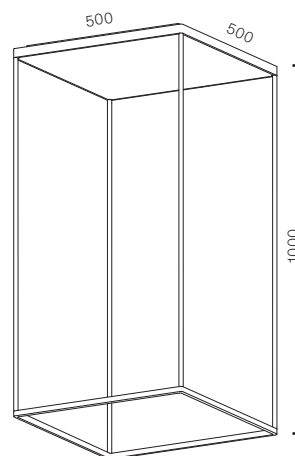
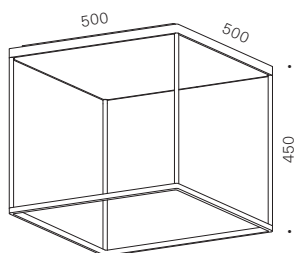
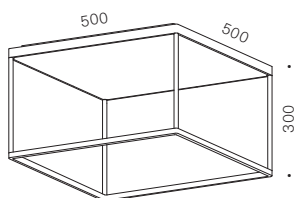
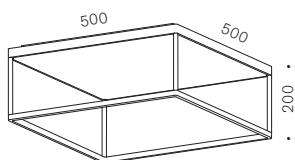

**REFLEX<sup>2</sup> Ceiling ist auch für die Wandmontage geeignet.**  
REFLEX<sup>2</sup> Ceiling is also suitable for wall mounting.

# REFLEX<sup>2</sup> Ceiling Cascade

Cascade M/S

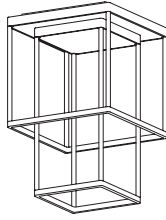

M



**REFLEX<sup>2</sup> Ceiling M**  
+ Reflektor Cascade M

S



**REFLEX<sup>2</sup> Ceiling S**  
+ Reflektor S

€ netto DE € brutto DE

ab 1.101,68 € 1.310 €

Cascade XL/M

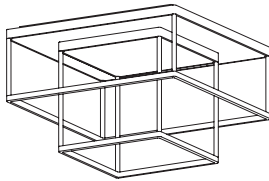

XL



**REFLEX<sup>2</sup> Ceiling XL**  
+ Reflektor Cascade XL

M



**REFLEX<sup>2</sup> Ceiling M**  
+ Reflektor M

€ netto DE € brutto DE

ab 1.525,21 € 1.815 €

Cascade XL/M/S

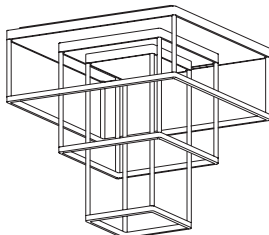

XL



**REFLEX<sup>2</sup> Ceiling XL**  
+ Reflektor Cascade XL

M



**REFLEX<sup>2</sup> Ceiling M**  
+ Reflektor Cascade M

S



**REFLEX<sup>2</sup> Ceiling S**  
+ Reflektor S

€ netto DE € brutto DE

ab 2.004,20 € 2.385 €

# REFLEX<sup>2</sup> Ceiling S new

Abbildung figure	Beschreibung description	Regelung control	Leistung power	CCT	E EK EEC	Lumen lumen	Art.-Nr. art.-no.	€ netto DE excl. VAT	€ brutto DE incl. VAT		
●	150 schwarz 150 black	TRIAC	33 W	2700 K	E	3640 lm	RE2450	344,54 €	410 €		
				3000 K	E	3800 lm	RE2451				
				2200-3000 K dim2warm	E	3640 lm	RE2401			382,35 €	455 €
		DALI	33 W	2700 K	E	3640 lm	RE2460	386,55 €	460 €		
				3000 K	E	3800 lm	RE2461				
				2200-3000 K dim2warm	E	3640 lm	RE2402			424,37 €	505 €
		CASAMBI	33 W	2200-5000 K tunable white <span style="color: #0070C0;">new</span>	E	3960 lm	RE2470	470,59 €	560 €		
				2700 K <span style="color: #0070C0;">new</span>	E	3640 lm	RE2460C	424,37 €	505 €		
				3000 K <span style="color: #0070C0;">new</span>	E	3800 lm	RE2461C				
		2200-3000 K dim2warm	E	3640 lm	RE2402C	462,18 €	550 €				
		CASAMBI	33 W	2200-5000 K tunable white <span style="color: #0070C0;">new</span>	E	3960 lm	RE2470C	508,40 €	605 €		
				○	150 weiß 150 white	TRIAC	33 W	2700 K	E	3640 lm	RE2452
3000 K	E							3800 lm	RE2453		
2200-3000 K dim2warm	E	3640 lm	RE2403					382,35 €	455 €		
DALI	33 W	2700 K	E			3640 lm	RE2462	386,55 €	460 €		
		3000 K	E			3800 lm	RE2463				
		2200-3000 K dim2warm	E			3640 lm	RE2404			424,37 €	505 €
CASAMBI	33 W	2200-5000 K tunable white <span style="color: #0070C0;">new</span>	E			3960 lm	RE2471	470,59 €	560 €		
		2700 K <span style="color: #0070C0;">new</span>	E			3640 lm	RE2462C	424,37 €	505 €		
		3000 K <span style="color: #0070C0;">new</span>	E			3800 lm	RE2463C				
2200-3000 K dim2warm	E	3640 lm	RE2404C			462,18 €	550 €				
CASAMBI	33 W	2200-5000 K tunable white <span style="color: #0070C0;">new</span>	E			3960 lm	RE2471C	508,40 €	605 €		
		●	200 schwarz 200 black			TRIAC	33 W	2700 K	E	3640 lm	RE2550
				3000 K	E			3800 lm	RE2551		
2200-3000 K dim2warm	E			3640 lm	RE2501			382,35 €	455 €		
DALI	33 W			2700 K	E	3640 lm	RE2560	386,55 €	460 €		
				3000 K	E	3800 lm	RE2561				
				2200-3000 K dim2warm	E	3640 lm	RE2502			424,37 €	505 €
CASAMBI	33 W			2200-5000 K tunable white <span style="color: #0070C0;">new</span>	E	3960 lm	RE2570	470,59 €	560 €		
				2700 K <span style="color: #0070C0;">new</span>	E	3640 lm	RE2560C	424,37 €	505 €		
				3000 K <span style="color: #0070C0;">new</span>	E	3800 lm	RE2561C				
2200-3000 K dim2warm	E			3640 lm	RE2502C	462,18 €	550 €				
CASAMBI	33 W			2200-5000 K tunable white <span style="color: #0070C0;">new</span>	E	3960 lm	RE2570C	508,40 €	605 €		
				○	200 weiß 200 white	TRIAC	33 W	2700 K	E	3640 lm	RE2552
		3000 K	E					3800 lm	RE2553		
2200-3000 K dim2warm	E	3640 lm	RE2503					382,35 €	455 €		
DALI	33 W	2700 K	E			3640 lm	RE2562	386,55 €	460 €		
		3000 K	E			3800 lm	RE2563				
		2200-3000 K dim2warm	E			3640 lm	RE2504			424,37 €	505 €
CASAMBI	33 W	2200-5000 K tunable white <span style="color: #0070C0;">new</span>	E			3960 lm	RE2571	470,59 €	560 €		
		2700 K <span style="color: #0070C0;">new</span>	E			3640 lm	RE2562C	424,37 €	505 €		
		3000 K <span style="color: #0070C0;">new</span>	E			3800 lm	RE2563C				
2200-3000 K dim2warm	E	3640 lm	RE2504C			462,18 €	550 €				
CASAMBI	33 W	2200-5000 K tunable white <span style="color: #0070C0;">new</span>	E			3960 lm	RE2571C	508,40 €	605 €		

# REFLEX<sup>2</sup> Ceiling S new

Abbildung figure	Beschreibung description	Regelung control	Leistung power	CCT	E EK EEC	Lumen lumen	Art.-Nr. art.-no.	€ netto DE excl. VAT	€ brutto DE incl. VAT	
●	300 schwarz 300 black	TRIAC	33 W	2700 K	E	3640 lm	RE2650	344,54 €	410 €	
				3000 K	E	3800 lm	RE2651			
				2200-3000 K dim2warm	E	3640 lm	RE2601	382,35 €	455 €	
		DALI	33 W	2700 K	E	3640 lm	RE2660			
				3000 K	E	3800 lm	RE2661	386,55 €	460 €	
				2200-3000 K dim2warm	E	3640 lm	RE2602	424,37 €	505 €	
		CASAMBI	33 W	2200-5000 K tunable white <span style="color: #0070C0;">new</span>	E	3960 lm	RE2670	470,59 €	560 €	
				2700 K <span style="color: #0070C0;">new</span>	E	3640 lm	RE2660C	424,37 €	505 €	
				3000 K <span style="color: #0070C0;">new</span>	E	3800 lm	RE2661C			
		CASAMBI	33 W	2200-3000 K dim2warm	E	3640 lm	RE2602C	462,18 €	550 €	
				2200-5000 K tunable white <span style="color: #0070C0;">new</span>	E	3960 lm	RE2670C	508,40 €	605 €	
				○	300 weiß 300 white	TRIAC	33 W	2700 K	E	3640 lm
3000 K	E	3800 lm	RE2653							
2200-3000 K dim2warm	E	3640 lm	RE2603					382,35 €	455 €	
DALI	33 W	2700 K	E			3640 lm	RE2662			
		3000 K	E			3800 lm	RE2663	386,55 €	460 €	
		2200-3000 K dim2warm	E			3640 lm	RE2604	424,37 €	505 €	
CASAMBI	33 W	2200-5000 K tunable white <span style="color: #0070C0;">new</span>	E			3960 lm	RE2671	470,59 €	560 €	
		2700 K <span style="color: #0070C0;">new</span>	E			3640 lm	RE2662C	424,37 €	505 €	
		3000 K <span style="color: #0070C0;">new</span>	E			3800 lm	RE2663C			
CASAMBI	33 W	2200-3000 K dim2warm	E			3640 lm	RE2604C	462,18 €	550 €	
		2200-5000 K tunable white <span style="color: #0070C0;">new</span>	E			3960 lm	RE2671C	508,40 €	605 €	
		●	450 schwarz 450 black			TRIAC	33 W	2700 K	E	3640 lm
3000 K	E			3800 lm	RE2751					
2200-3000 K dim2warm	E			3640 lm	RE2701			382,35 €	455 €	
DALI	33 W			2700 K	E	3640 lm	RE2760			
				3000 K	E	3800 lm	RE2761	386,55 €	460 €	
				2200-3000 K dim2warm	E	3640 lm	RE2702	424,37 €	505 €	
CASAMBI	33 W			2200-5000 K tunable white <span style="color: #0070C0;">new</span>	E	3960 lm	RE2770	470,59 €	560 €	
				2700 K <span style="color: #0070C0;">new</span>	E	3640 lm	RE2760C	424,37 €	505 €	
				3000 K <span style="color: #0070C0;">new</span>	E	3800 lm	RE2761C			
CASAMBI	33 W			2200-3000 K dim2warm	E	3640 lm	RE2702C	462,18 €	550 €	
				2200-5000 K tunable white <span style="color: #0070C0;">new</span>	E	3960 lm	RE2770C	508,40 €	605 €	
				○	450 weiß 450 white	TRIAC	33 W	2700 K	E	3640 lm
3000 K	E	3800 lm	RE2753							
2200-3000 K dim2warm	E	3640 lm	RE2703					382,35 €	455 €	
DALI	33 W	2700 K	E			3640 lm	RE2762			
		3000 K	E			3800 lm	RE2763	386,55 €	460 €	
		2200-3000 K dim2warm	E			3640 lm	RE2704	424,37 €	505 €	
CASAMBI	33 W	2200-5000 K tunable white <span style="color: #0070C0;">new</span>	E			3960 lm	RE2771	470,59 €	560 €	
		2700 K <span style="color: #0070C0;">new</span>	E			3640 lm	RE2762C	424,37 €	505 €	
		3000 K <span style="color: #0070C0;">new</span>	E			3800 lm	RE2763C			
CASAMBI	33 W	2200-3000 K dim2warm	E			3640 lm	RE2704C	462,18 €	550 €	
		2200-5000 K tunable white <span style="color: #0070C0;">new</span>	E			3960 lm	RE2771C	508,40 €	605 €	

Abbildung figure	Beschreibung description	Regelung control	Leistung power	CCT	E EK EEC	Lumen lumen	Art.-Nr. art.-no.	€ netto DE excl. VAT	€ brutto DE incl. VAT
●	600 schwarz 600 black	TRIAC	33 W	2700 K	E	3640 lm	RE2950	344,54 €	410 €
				3000 K	E	3800 lm	RE2951		
				2200-3000 K dim2warm	E	3640 lm	RE2901		
		DALI	33 W	2700 K	E	3640 lm	RE2960	386,55 €	460 €
				3000 K	E	3800 lm	RE2961		
				2200-3000 K dim2warm	E	3640 lm	RE2902		
		CASAMBI	33 W	2200-5000 K tunable white <small>new</small>	E	3960 lm	RE2870	470,59 €	560 €
				2700 K <small>new</small>	E	3640 lm	RE2960C	424,37 €	505 €
				3000 K <small>new</small>	E	3800 lm	RE2961C		
		2200-3000 K dim2warm	E	3640 lm	RE2902C	462,18 €	550 €		
		CASAMBI	33 W	2200-5000 K tunable white <small>new</small>	E	3960 lm	RE2870C	508,40 €	605 €
				TRIAC	33 W	2700 K	E	3640 lm	RE2952
3000 K	E					3800 lm	RE2953		
2200-3000 K dim2warm	E	3640 lm	RE2903			382,35 €	455 €		
DALI	33 W	2700 K	E	3640 lm	RE2962	386,55 €	460 €		
		3000 K	E	3800 lm	RE2963				
		2200-3000 K dim2warm	E	3640 lm	RE2904			424,37 €	505 €
CASAMBI	33 W	2200-5000 K tunable white <small>new</small>	E	3960 lm	RE2871	470,90 €	560 €		
		2700 K <small>new</small>	E	3640 lm	RE2962C	424,37 €	505 €		
		3000 K <small>new</small>	E	3800 lm	RE2963C				
2200-3000 K dim2warm	E	3640 lm	RE2904C	462,18 €	550 €				
CASAMBI	33 W	2200-5000 K tunable white <small>new</small>	E	3960 lm	RE2871C	508,40 €	605 €		

 modular article  
 IP20 protection class  
 emergency light option

LED  dimmable  dim2warm  tunable white  CRI >90  SDCM 3

## REFLEX<sup>2</sup> Ceiling S Reflektor

Abbildung figure	Beschreibung description	Art.-Nr. art.-no.	€ netto DE excl. VAT	€ brutto DE incl. VAT
○	Pyramidenstruktur weiß pyramid structure white	RE3051		
●	Pyramidenstruktur silber pyramid structure silver	RE3052		
●	Pyramidenstruktur gold pyramid structure gold	RE3053	84,03 €	100 €
○	matt weiß matte white	RE3054		

 modular article

# REFLEX<sup>2</sup> Ceiling M new





Abbildung figure	Beschreibung description	Regelung control	Leistung power	CCT	EЕК EEC	Lumen lumen	Art.-Nr. art.-no.	€ netto DE excl. VAT	€ brutto DE incl. VAT		
●	150 schwarz 150 black	TRIAC	40W	2700K	E	4840lm	RE2001	525,21 €	625 €		
				3000K	E	4920lm	RE2002				
		DALI	50W	2700K	E	6350lm	RE2003	571,43 €	680 €		
				3000K	E	6450lm	RE2004				
				2200-5000K tunable white	E	6580lm	RE2005				
		CASAMBI	50W	2700K <span style="background-color: #0070C0; color: white; padding: 2px;">new</span>	E	6350lm	RE2003C	651,26 €	775 €		
				3000K <span style="background-color: #0070C0; color: white; padding: 2px;">new</span>	E	6450lm	RE2004C				
				2200-5000K tunable white	E	6580lm	RE2005C				
		○	150 weiß 150 white	TRIAC	40W	2700K	E	4840lm	RE2006	525,21 €	625 €
						3000K	E	4920lm	RE2007		
DALI	50W			2700K	E	6350lm	RE2008	571,43 €	680 €		
				3000K	E	6450lm	RE2009				
				2200-5000K tunable white	E	6580lm	RE2010				
CASAMBI	50W			2700K <span style="background-color: #0070C0; color: white; padding: 2px;">new</span>	E	6350lm	RE2008C	651,26 €	775 €		
				3000K <span style="background-color: #0070C0; color: white; padding: 2px;">new</span>	E	6450lm	RE2009C				
				2200-5000K tunable white	E	6580lm	RE2010C				
●	200 schwarz 200 black			TRIAC	40W	2700K	E	4840lm	RE2801	525,21 €	625 €
						3000K	E	4920lm	RE2802		
		DALI	50W	2700K	E	6350lm	RE2803	571,43 €	680 €		
				3000K	E	6450lm	RE2804				
				2200-5000K tunable white	E	6580lm	RE2805				
		CASAMBI	50W	2700K <span style="background-color: #0070C0; color: white; padding: 2px;">new</span>	E	6350lm	RE2803C	651,26 €	775 €		
				3000K <span style="background-color: #0070C0; color: white; padding: 2px;">new</span>	E	6450lm	RE2804C				
				2200-5000K tunable white	E	6580lm	RE2805C				
		○	200 weiß 200 white	TRIAC	40W	2700K	E	4840lm	RE2806	525,21 €	625 €
						3000K	E	4920lm	RE2807		
DALI	50W			2700K	E	6350lm	RE2808	571,43 €	680 €		
				3000K	E	6450lm	RE2809				
				2200-5000K tunable white	E	6580lm	RE2810				
CASAMBI	50W			2700K <span style="background-color: #0070C0; color: white; padding: 2px;">new</span>	E	6350lm	RE2808C	651,26 €	775 €		
				3000K <span style="background-color: #0070C0; color: white; padding: 2px;">new</span>	E	6450lm	RE2809C				
				2200-5000K tunable white	E	6580lm	RE2810C				
●	300 schwarz 300 black			TRIAC	40W	2700K	E	4840lm	RE2101	525,21 €	625 €
						3000K	E	4920lm	RE2102		
		DALI	50W	2700K	E	6350lm	RE2103	571,43 €	680 €		
				3000K	E	6450lm	RE2104				
				2200-5000K tunable white	E	6580lm	RE2105				
		CASAMBI	50W	2700K <span style="background-color: #0070C0; color: white; padding: 2px;">new</span>	E	6350lm	RE2103C	651,26 €	775 €		
				3000K <span style="background-color: #0070C0; color: white; padding: 2px;">new</span>	E	6450lm	RE2104C				
				2200-5000K tunable white	E	6580lm	RE2105C				
		○	300 weiß 300 white	TRIAC	40W	2700K	E	4840lm	RE2106	525,21 €	625 €
						3000K	E	4920lm	RE2107		
DALI	50W			2700K	E	6350lm	RE2108	571,43 €	680 €		
				3000K	E	6450lm	RE2109				
				2200-5000K tunable white	E	6580lm	RE2110				
CASAMBI	50W			2700K <span style="background-color: #0070C0; color: white; padding: 2px;">new</span>	E	6350lm	RE2108C	651,26 €	775 €		
				3000K <span style="background-color: #0070C0; color: white; padding: 2px;">new</span>	E	6450lm	RE2109C				
				2200-5000K tunable white	E	6580lm	RE2110C				

Abbildung figure	Beschreibung description	Regelung control	Leistung power	CCT	EEL EEC	Lumen lumen	Art.-Nr. art.-no.	€ netto DE excl. VAT	€ brutto DE incl. VAT		
●	<b>450 schwarz</b> 450 black	TRIAC	40 W	2700 K	E	4840 lm	RE2201	525,21 €	625 €		
				3000 K	E	4920 lm	RE2202				
		DALI	50 W	2700 K	E	6350 lm	RE2203	571,43 €	680 €		
				3000 K	E	6450 lm	RE2204				
				2200–5000 K tunable white	E	6580 lm	RE2205				
		CASAMBI	50 W	2700 K <small>new</small>	E	6350 lm	RE2203C	651,26 €	775 €		
				3000 K <small>new</small>	E	6450 lm	RE2204C				
				2200–5000 K tunable white	E	6580 lm	RE2205C				
		○	<b>450 weiß</b> 450 white	TRIAC	40 W	2700 K	E	4840 lm	RE2206	525,21 €	625 €
						3000 K	E	4920 lm	RE2207		
DALI	50 W			2700 K	E	6350 lm	RE2208	571,43 €	680 €		
				3000 K	E	6450 lm	RE2209				
				2200–5000 K tunable white	E	6580 lm	RE2210				
CASAMBI	50 W			2700 K <small>new</small>	E	6350 lm	RE2208C	651,26 €	775 €		
				3000 K <small>new</small>	E	6450 lm	RE2209C				
				2200–5000 K tunable white	E	6580 lm	RE2210C				
●	<b>600 schwarz</b> 600 black			TRIAC	40 W	2700 K	E	4840 lm	RE2301	525,21 €	625 €
						3000 K	E	4920 lm	RE2302		
		DALI	50 W	2700 K	E	6350 lm	RE2303	571,43 €	680 €		
				3000 K	E	6450 lm	RE2304				
				2200–5000 K tunable white	E	6580 lm	RE2305				
		CASAMBI	50 W	2700 K <small>new</small>	E	6350 lm	RE2303C	651,26 €	775 €		
				3000 K <small>new</small>	E	6450 lm	RE2304C				
				2200–5000 K tunable white	E	6580 lm	RE2305C				
		○	<b>600 weiß</b> 600 white	TRIAC	40 W	2700 K	E	4840 lm	RE2306	525,21 €	625 €
						3000 K	E	4920 lm	RE2307		
DALI	50 W			2700 K	E	6350 lm	RE2308	571,43 €	680 €		
				3000 K	E	6450 lm	RE2309				
				2200–5000 K tunable white	E	6580 lm	RE2310				
CASAMBI	50 W			2700 K <small>new</small>	E	6350 lm	RE2308C	651,26 €	775 €		
				3000 K <small>new</small>	E	6450 lm	RE2309C				
				2200–5000 K tunable white	E	6580 lm	RE2310C				

 modular article  
 IP20 protection class  
 emergency light option  
 battery option  
 sensor option

 LED  
 dimmable  
 tunable white  
 CRI >90  
 SDCM 3

## REFLEX<sup>2</sup> Ceiling M Reflektor

Abbildung figure	Beschreibung description	Art.-Nr. art.-no.	€ netto DE excl. VAT	€ brutto DE incl. VAT
	<b>Pyramidenstruktur weiß</b> pyramid structure white	RE3001		
	<b>Pyramidenstruktur silber</b> pyramid structure silver	RE3002		
	<b>Pyramidenstruktur gold</b> pyramid structure gold	RE3003	96,64 €	115 €
	<b>matt weiß</b> matte white	RE3004		

+

modular  
article

## REFLEX<sup>2</sup> Ceiling M Reflektor Cascade

Abbildung figure	Beschreibung description	Art.-Nr. art.-no.	€ netto DE excl. VAT	€ brutto DE incl. VAT
	<b>Pyramidenstruktur weiß</b> pyramid structure white	RE3221		
	<b>Pyramidenstruktur silber</b> pyramid structure silver	RE3222		
	<b>Pyramidenstruktur gold</b> pyramid structure gold	RE3223	160,29 €	175 €
	<b>matt weiß</b> matte white	RE3224		

+

modular  
article

# REFLEX<sup>2</sup> Ceiling XL new



Abbildung figure	Beschreibung description	Regelung control	Leistung power	CCT	EK EEC	Lumen lumen	Art.-Nr. art.-no.	€ netto DE excl. VAT	€ brutto DE incl. VAT
●	<b>200 schwarz</b> 200 black	ON/OFF	82 W	2700 K	E	9790 lm	RE5500	714,29 €	850 €
				3000 K	E	10140 lm	RE5501		
		ON/OFF SENSOR	82 W	2700 K	E	9790 lm	RE5500S	798,32 €	950 €
				3000 K	E	10140 lm	RE5501S		
		DALI	85 W	2700 K	E	10310 lm	RE5507	764,71 €	910 €
				3000 K	E	10690 lm	RE5508		
		DALI SENSOR	82 W	2700 K	E	9790 lm	RE5507S	848,74 €	1010 €
				3000 K	E	10140 lm	RE5508S		
		CASAMBI	85 W	2700 K	E	10310 lm	RE5507C	798,32 €	950 €
				3000 K	E	10690 lm	RE5508C		
				2200-5000 K tunable white	E	11220 lm	RE5511C	899,16 €	1070 €
		○	<b>200 weiß</b> 200 white	ON/OFF	82 W	2700 K	E	9790 lm	RE5520
3000 K	E					10140 lm	RE5521		
ON/OFF SENSOR	82 W			2700 K	E	9790 lm	RE5520S	798,32 €	950 €
				3000 K	E	10140 lm	RE5521S		
DALI	85 W			2700 K	E	10310 lm	RE5527	764,71 €	910 €
				3000 K	E	10690 lm	RE5528		
DALI SENSOR	82 W			2700 K	E	9790 lm	RE5527S	848,74 €	1010 €
				3000 K	E	10140 lm	RE5528S		
CASAMBI	85 W			2700 K	E	10310 lm	RE5527C	798,32 €	950 €
				3000 K	E	10690 lm	RE5528C		
				2200-5000 K tunable white	E	11220 lm	RE5531C	899,16 €	1070 €
●	<b>300 schwarz</b> 300 black			ON/OFF	82 W	2700 K	E	9790 lm	RE5600
		3000 K	E			10140 lm	RE5601		
		ON/OFF SENSOR	82 W	2700 K	E	9790 lm	RE5600S	798,32 €	950 €
				3000 K	E	10140 lm	RE5601S		
		DALI	85 W	2700 K	E	10310 lm	RE5607	764,71 €	910 €
				3000 K	E	10690 lm	RE5608		
		DALI SENSOR	82 W	2700 K	E	9790 lm	RE5607S	848,74 €	1010 €
				3000 K	E	10140 lm	RE5608S		
		CASAMBI	85 W	2700 K	E	10310 lm	RE5607C	798,32 €	950 €
				3000 K	E	10690 lm	RE5608C		
				2200-5000 K tunable white	E	11220 lm	RE5611C	899,16 €	1070 €
		○	<b>300 weiß</b> 300 white	ON/OFF	82 W	2700 K	E	9790 lm	RE5620
3000 K	E					10140 lm	RE5621		
ON/OFF SENSOR	82 W			2700 K	E	9790 lm	RE5620S	798,32 €	950 €
				3000 K	E	10140 lm	RE5621S		
DALI	85 W			2700 K	E	10310 lm	RE5627	764,71 €	910 €
				3000 K	E	10690 lm	RE5628		
DALI SENSOR	82 W			2700 K	E	9790 lm	RE5627S	848,74 €	1010 €
				3000 K	E	10140 lm	RE5628S		
CASAMBI	85 W			2700 K	E	10310 lm	RE5627C	798,32 €	950 €
				3000 K	E	10690 lm	RE5628C		
				2200-5000 K tunable white	E	11220 lm	RE5631C	899,16 €	1070 €

Abbildung figure	Beschreibung description	Regelung control	Leistung power	CCT	EEL EEC	Lumen lumen	Art.-Nr. art.-no.	€ netto DE excl. VAT	€ brutto DE incl. VAT
●	<b>450 schwarz</b> 450 black	ON/OFF	82 W	2700 K	E	9790lm	RE5800	714,29 €	850 €
				3000 K	E	10140lm	RE5801		
		ON/OFF SENSOR	82 W	2700 K	E	9790lm	RE5800S	798,32 €	950 €
				3000 K	E	10140lm	RE5801S		
		DALI	85 W	2700 K	E	10310lm	RE5807	764,71 €	910 €
				3000 K	E	10690lm	RE5808		
				2200-5000 K tunable white	E	11220lm	RE5811		
		DALI SENSOR	82 W	2700 K	E	9790lm	RE5807S	848,74 €	1010 €
				3000 K	E	10140lm	RE5808S		
		CASAMBI	85 W	2700 K	E	10310lm	RE5807C	798,32 €	950 €
				3000 K	E	10690lm	RE5808C		
				2200-5000 K tunable white	E	11220lm	RE5811C		
○	<b>450 weiß</b> 450 white	ON/OFF	82 W	2700 K	E	9790lm	RE5820	714,29 €	850 €
				3000 K	E	10140lm	RE5821		
		ON/OFF SENSOR	82 W	2700 K	E	9790lm	RE5820S	798,32 €	950 €
				3000 K	E	10140lm	RE5821S		
		DALI	85 W	2700 K	E	10310lm	RE5827	764,71 €	910 €
				3000 K	E	10690lm	RE5828		
				2200-5000 K tunable white	E	11220lm	RE5831		
		DALI SENSOR	82 W	2700 K	E	9790lm	RE5827S	848,74 €	1010 €
				3000 K	E	10140lm	RE5828S		
		CASAMBI	85 W	2700 K	E	10310lm	RE5827C	798,32 €	950 €
				3000 K	E	10690lm	RE5828C		
				2200-5000 K tunable white	E	11220lm	RE5831C		
●	<b>1000 schwarz</b> 1000 black	ON/OFF	82 W	2700 K	E	9790lm	RE5200	714,29 €	850 €
				3000 K	E	10140lm	RE5201		
		ON/OFF SENSOR	82 W	2700 K	E	9790lm	RE5200S	798,32 €	950 €
				3000 K	E	10140lm	RE5201S		
		DALI	85 W	2700 K	E	10310lm	RE5207	764,71 €	910 €
				3000 K	E	10690lm	RE5208		
				2200-5000 K tunable white	E	11220lm	RE5211		
		DALI SENSOR	82 W	2700 K	E	9790lm	RE5207S	848,74 €	1010 €
				3000 K	E	10140lm	RE5208S		
		CASAMBI	85 W	2700 K	E	10310lm	RE5207C	798,32 €	950 €
				3000 K	E	10690lm	RE5208C		
				2200-5000 K tunable white	E	11220lm	RE5211C		
○	<b>1000 weiß</b> 1000 white	ON/OFF	82 W	2700 K	E	9790lm	RE5220	714,29 €	850 €
				3000 K	E	10140lm	RE5221		
		ON/OFF SENSOR	82 W	2700 K	E	9790lm	RE5220S	798,32 €	950 €
				3000 K	E	10140lm	RE5221S		
		DALI	85 W	2700 K	E	10310lm	RE5227	764,71 €	910 €
				3000 K	E	10690lm	RE5228		
				2200-5000 K tunable white	E	11220lm	RE5231		
		DALI SENSOR	82 W	2700 K	E	9790lm	RE5227S	848,74 €	1010 €
				3000 K	E	10140lm	RE5228S		
		CASAMBI	85 W	2700 K	E	10310lm	RE5227C	798,32 €	950 €
				3000 K	E	10690lm	RE5228C		
				2200-5000 K tunable white	E	11220lm	RE5231C		

 modular article  
 IP20 protection class  
 emergency light option  
 battery option  
 sensor option





 LED  
 dimmable  
 tunable white  
 CRI >90  
 SDCM 3

## REFLEX<sup>2</sup> Ceiling XL Reflektor

Abbildung figure	Beschreibung description	Art.-Nr. art.-no.	€ netto DE excl. VAT	€ brutto DE incl. VAT
	<b>Pyramidenstruktur weiß</b> pyramid structure white	RE3201		
	<b>Pyramidenstruktur silber</b> pyramid structure silver	RE3202		
	<b>Pyramidenstruktur gold</b> pyramid structure gold	RE3203	121,85 €	145 €
	<b>matt weiß</b> matte white	RE3204		



## REFLEX<sup>2</sup> Ceiling XL Reflektor Cascade

Abbildung figure	Beschreibung description	Art.-Nr. art.-no.	€ netto DE excl. VAT	€ brutto DE incl. VAT
	<b>Pyramidenstruktur weiß</b> pyramid structure white	RE3211		
	<b>Pyramidenstruktur silber</b> pyramid structure silver	RE3212		
	<b>Pyramidenstruktur gold</b> pyramid structure gold	RE3213	189,08 €	225 €
	<b>matt weiß</b> matte white	RE3214		



# REFLEX<sup>2</sup> Wall

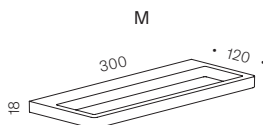

## REFLEX<sup>2</sup> Wall M

Abbildung figure	Beschreibung description	Regelung control	Leistung power	CCT	EEL EEC	Lumen lumen	Art.-Nr. art.-no.	€ netto DE excl. VAT	€ brutto DE incl. VAT
●	<b>schwarz</b> black	TRIAC	12 W	2700 K	E	1420 lm	RE4001	319,33 €	380 €
				3000 K	E	1470 lm	RE4003		
○	<b>weiß</b> white	TRIAC	12 W	2700 K	E	1420 lm	RE4002		
				3000 K	E	1470 lm	RE4004		

IP20  
protection  
class

LED     
dimmable CRI >90 SDCM 3

## Zubehör / Accessories

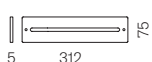
Abbildung figure	Beschreibung description	Art.-Nr. art.-no.	€ netto DE excl. VAT	€ brutto DE incl. VAT
	<b>Wandabdeckung M schwarz</b> wall cover M black	RE8520	29,41 €	35 €
	<b>Wandabdeckung M weiß</b> wall cover M white	RE8521		

# REFLEX<sup>2</sup> Table

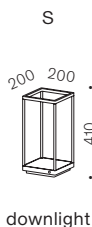

## REFLEX<sup>2</sup> Table

Abbildung figure	Beschreibung description	Regelung control	Leistung power	CCT	EEL EEC	Lumen lumen	Art.-Nr. art.-no.	€ netto DE excl. VAT	€ brutto DE incl. VAT
●	<b>schwarz</b> black	integr.	33 W	2200-3000 K dim2warm	E	3640 lm	RE3801	487,39 €	580 €
		CASAMBI	33 W	2200-3000 K dim2warm	E	3640 lm	RE3803	605,04 €	720 €
○	<b>weiß</b> white	integr.	33 W	2200-3000 K dim2warm	E	3640 lm	RE3802	487,39 €	580 €
		CASAMBI	33 W	2200-3000 K dim2warm	E	3640 lm	RE3804	605,04 €	720 €

IP20  
protection  
class

LED     
dimmable CRI >90 SDCM 3

# REFLEX<sup>2</sup> Floor

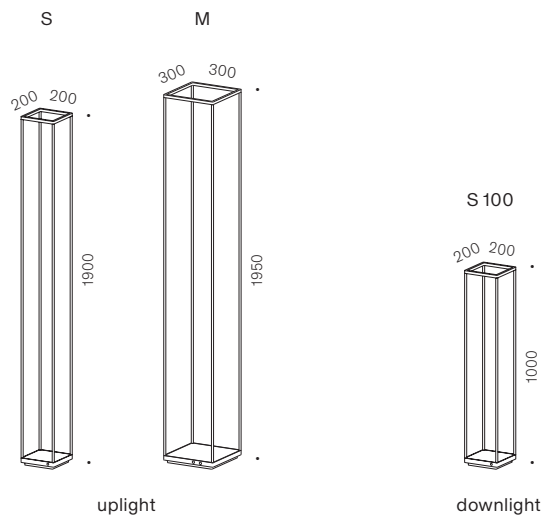

## REFLEX<sup>2</sup> Floor

Abbildung figure	Beschreibung description	Regelung control	Leistung power	CCT	EK EEC	Lumen lumen	Art.-Nr. art.-no.	€ netto DE excl. VAT	€ brutto DE incl. VAT
●	<b>S schwarz</b> S black	integr.	33 W	2200-3000 K dim2warm	E	3640lm	RE3501	823,53 €	980 €
		CASAMBI	33 W	2200-3000 K dim2warm	E	3640lm	RE3503	941,18 €	1.120 €
○	<b>S weiß</b> S white	integr.	33 W	2200-3000 K dim2warm	E	3640lm	RE3502	823,53 €	980 €
		CASAMBI	33 W	2200-3000 K dim2warm	E	3640lm	RE3504	941,18 €	1.120 €
●	<b>M schwarz</b> M black	integr.	50 W	2200-5000 K tunable white	E	6580lm	RE3603	1.058,82 €	1.260 €
		CASAMBI	50 W	2200-5000 K tunable white	E	6580lm	RE3605	1.168,07 €	1.390 €
○	<b>M weiß</b> M white	integr.	50 W	2200-5000 K tunable white	E	6580lm	RE3604	1.058,82 €	1.260 €
		CASAMBI	50 W	2200-5000 K tunable white	E	6580lm	RE3606	1.168,07 €	1.390 €
●	<b>S100 schwarz</b> S100 black	integr.	33 W	2200-3000 K dim2warm	E	3640lm	RE3701	571,43 €	680 €
		CASAMBI	33 W	2200-3000 K dim2warm	E	3640lm	RE3703	689,08 €	820 €
○	<b>S100 weiß</b> S100 white	integr.	33 W	2200-3000 K dim2warm	E	3640lm	RE3702	571,43 €	680 €
		CASAMBI	33 W	2200-3000 K dim2warm	E	3640lm	RE3704	689,08 €	820 €

IP20  
protection  
class

LED      
dimmmable dim2warm CRI >90 SDCM 3

# ROD Wall



## ROD Wall new

Abbildung figure	Beschreibung description	Regelung control	Leistung power	CCT	EEK EEC	Lumen lumen	Art.-Nr. art.-no.	€ netto DE excl. VAT	€ brutto DE incl. VAT
○	opal	TRIAC	27 W	2700 K	E	3350 lm	RD1001	491,60 €	585 €
				3000 K <span style="color: blue; font-weight: bold;">new</span>	E	3400 lm	RD1101		
		DALI	27 W	2700 K	E	3350 lm	RD1009	516,81 €	615 €
				3000 K <span style="color: blue; font-weight: bold;">new</span>	E	3400 lm	RD1109		
		CASAMBI <span style="color: blue; font-weight: bold;">new</span>	27 W	2700 K	E	3350 lm	RD1009C	600,84 €	715 €
				3000 K	E	3400 lm	RD1109C		
●	glanzverchromt chrome plated	TRIAC	27 W	2700 K	E	3350 lm	RD1002	491,60 €	585 €
				3000 K <span style="color: blue; font-weight: bold;">new</span>	E	3400 lm	RD1102		
		DALI	27 W	2700 K	E	3350 lm	RD1010	516,81 €	615 €
				3000 K <span style="color: blue; font-weight: bold;">new</span>	E	3400 lm	RD1110		
		CASAMBI <span style="color: blue; font-weight: bold;">new</span>	27 W	2700 K	E	3350 lm	RD1010C	600,84 €	715 €
				3000 K	E	3400 lm	RD1110C		
●	gold eloxiert gold anodized	TRIAC	27 W	2700 K	E	3350 lm	RD1018	491,60 €	585 €
				3000 K <span style="color: blue; font-weight: bold;">new</span>	E	3400 lm	RD1118		
		DALI	27 W	2700 K	E	3350 lm	RD1021	516,81 €	615 €
				3000 K <span style="color: blue; font-weight: bold;">new</span>	E	3400 lm	RD1121		
		CASAMBI <span style="color: blue; font-weight: bold;">new</span>	27 W	2700 K	E	3350 lm	RD1021C	600,84 €	715 €
				3000 K	E	3400 lm	RD1121C		

IP20   
 protection emergency  
 class light option individual

LED   
 dimmable CRI >90 SDCM 3

## Zubehör/Accessories

Abbildung figure	Beschreibung description	Art.-Nr. art.-no.	€ netto DE excl. VAT	€ brutto DE incl. VAT
	<b>Spiegeladapter Set ROD</b> mirror adapter set ROD	ZB1004	37,82 €	45 €

# SLICE<sup>2</sup> Furniture

Furniture

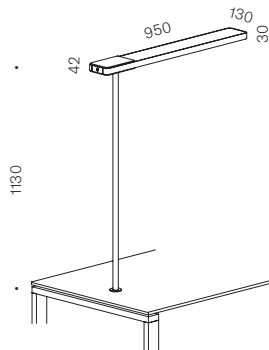

## SLICE<sup>2</sup> Furniture

Abbildung figure	Beschreibung description	Regelung control	Leistung power	CCT	EEK EEC	Lumen lumen	Art.-Nr. art.-no.	€ netto DE excl. VAT	€ brutto DE incl. VAT
●	glanzverchromt chrome plated	integr.	85 W	3000 K	C	12570 lm	SL4001	1.390,76 €	1.655 €
				4000 K	C	13340 lm	SL4002		
		Sensorik	85 W	3000 K	C	12570 lm	SL5001	1.567,23 €	1.865 €
				4000 K	C	13340 lm	SL5002		
●	schwarz black	integr.	85 W	3000 K	C	12570 lm	SL4101	1.302,52 €	1.550 €
				4000 K	C	13340 lm	SL4102		
		Sensorik	85 W	3000 K	C	12570 lm	SL5101	1.478,99 €	1.760 €
				4000 K	C	13340 lm	SL5102		
○	weiß white	integr.	85 W	3000 K	C	12570 lm	SL4201	1.302,52 €	1.550 €
				4000 K	C	13340 lm	SL4202		
		Sensorik	85 W	3000 K	C	12570 lm	SL5201	1.478,99 €	1.760 €
				4000 K	C	13340 lm	SL5202		
●	silber silver	integr.	85 W	3000 K	C	12570 lm	SL4301	1.302,52 €	1.550 €
				4000 K	C	13340 lm	SL4302		
		Sensorik	85 W	3000 K	C	12570 lm	SL5301	1.478,99 €	1.760 €
				4000 K	C	13340 lm	SL5302		

IP20  
protection  
class

LED

UGR  
<11



CRI >80



dimmable



SDCM 3

# SLICE<sup>2</sup> Furniture

Furniture with adapter for  
USM Haller table systems

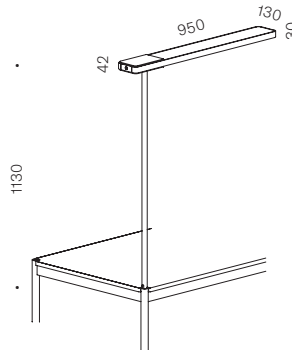

## SLICE<sup>2</sup> Furniture with adapter for USM Haller table systems

Abbildung figure	Beschreibung description	Regelung control	Leistung power	CCT	E EK EEC	Lumen lumen	Art.-Nr. art.-no.	€ netto DE excl. VAT	€ brutto DE incl. VAT
●	<b>glanzverchromt</b> chrome plated	integr.	85 W	3000K	C	12570lm	SL4011	1.390,76 €	1.655 €
				4000K	C	13340lm	SL4012		
		Sensorik	85 W	3000K	C	12570lm	SL5011	1.567,23 €	1.865 €
				4000K	C	13340lm	SL5012		
●	<b>schwarz</b> black	integr.	85 W	3000K	C	12570lm	SL4111	1.302,52 €	1.550 €
				4000K	C	13340lm	SL4112		
		Sensorik	85 W	3000K	C	12570lm	SL5111	1.478,99 €	1.760 €
				4000K	C	13340lm	SL5112		
○	<b>weiß</b> white	integr.	85 W	3000K	C	12570lm	SL4211	1.302,52 €	1.550 €
				4000K	C	13340lm	SL4212		
		Sensorik	85 W	3000K	C	12570lm	SL5211	1.478,99 €	1.760 €
				4000K	C	13340lm	SL5212		
●	<b>silber</b> silver	integr.	85 W	3000K	C	12570lm	SL4311	1.302,52 €	1.550 €
				4000K	C	13340lm	SL4312		
		Sensorik	85 W	3000K	C	12570lm	SL5311	1.478,99 €	1.760 €
				4000K	C	13340lm	SL5312		

IP20  
protection  
class

LED UGR <11 CRI >80 dimmable SDCM 3

# SLICE<sup>2</sup> Floor

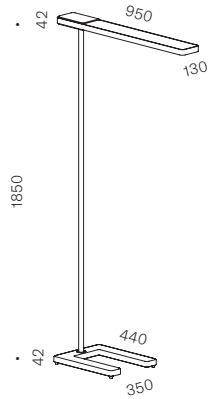

## SLICE<sup>2</sup> Floor

Abbildung figure	Beschreibung description	Regelung control	Leistung power	CCT	EEK EEC	Lumen lumen	Art.-Nr. art.-no.	€ netto DE excl. VAT	€ brutto DE incl. VAT
●	<b>glanzverchromt, Sockel silber</b> chrome plated, base silver	integr.	85 W	3000 K	C	12570 lm	SL2001	1.567,23 €	1.865 €
				4000 K	C	13340 lm	SL2002		
		Sensorik	85 W	3000 K	C	12570 lm	SL3001	1.739,50 €	2.070 €
				4000 K	C	13340 lm	SL3002		
●	<b>schwarz</b> black	integr.	85 W	3000 K	C	12570 lm	SL2101	1.478,99 €	1.760 €
				4000 K	C	13340 lm	SL2102		
		Sensorik	85 W	3000 K	C	12570 lm	SL3101	1.655,46 €	1.970 €
				4000 K	C	13340 lm	SL3102		
○	<b>weiß</b> white	integr.	85 W	3000 K	C	12570 lm	SL2201	1.478,99 €	1.760 €
				4000 K	C	13340 lm	SL2202		
		Sensorik	85 W	3000 K	C	12570 lm	SL3201	1.655,46 €	1.970 €
				4000 K	C	13340 lm	SL3202		
●	<b>silber</b> silver	integr.	85 W	3000 K	C	12570 lm	SL2301	1.478,99 €	1.760 €
				4000 K	C	13340 lm	SL2302		
		Sensorik	85 W	3000 K	C	12570 lm	SL3301	1.655,46 €	1.970 €
				4000 K	C	13340 lm	SL3302		

IP20  
protection  
class

LED

UGR  
<11



CRI >80



dimmable





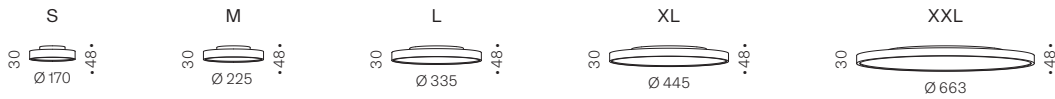

SDCM 3

# SLICE<sup>2</sup> PI Ceiling



**SLICE<sup>2</sup> PI Ceiling ist auch für die Wandmontage geeignet - bitte achten Sie dabei auf mögliche Direktblendung. Eine spezielle SLICE<sup>2</sup> PI Wall-Variante finden Sie ab Seite 94 - dekorativ entblendet und asymmetrisch-abstrahlend.**  
 SLICE<sup>2</sup> PI Ceiling is also suitable for wall mounting - please be aware of potential direct glare. You will find a special SLICE<sup>2</sup> PI Wall variant from page 94 onwards - with decorative anti-glare treatment and asymmetrical light distribution.





## SLICE<sup>2</sup> PI Ceiling S new

Abbildung figure	Beschreibung description	Regelung control	Leistung power	CCT	EEL EEC	Lumen lumen	Art.-Nr. art.-no.	€ netto DE excl. VAT	€ brutto DE incl. VAT
	<b>DRIVER ENGINE</b> Ceiling S	TRIAC	13 W				DE011001	67,23 €	80 €
		DALI	10 W				DE011002	84,03 €	100 €
		CASAMBI	10 W				DE011002C	168,07 €	200 €
	<b>Gehäuse S schwarz</b> housing S black			2700 K	D	1180-1420 lm	PI1001	239,50 €	285 €
				3000 K	C	1230-1470 lm	PI1002		
				4000 K <span style="color: blue; font-weight: bold;">new</span>	C	1260-1510 lm	PI1003		
				2700 K	D	1180-1420 lm	PI1011		
				3000 K	C	1230-1470 lm	PI1012		
				4000 K <span style="color: blue; font-weight: bold;">new</span>	C	1260-1510 lm	PI1013		
	<b>Gehäuse S weiß</b> housing S white			2700 K	D	1180-1420 lm	PI1021	239,50 €	285 €
				3000 K	C	1230-1470 lm	PI1022		
				4000 K <span style="color: blue; font-weight: bold;">new</span>	C	1260-1510 lm	PI1023		
				2700 K	D	1180-1420 lm	PI1031		
				3000 K	C	1230-1470 lm	PI1032		
				4000 K <span style="color: blue; font-weight: bold;">new</span>	C	1260-1510 lm	PI1033		
	<b>Gehäuse S glanzverchromt</b> housing S chrome-plated			2700 K	D	1180-1420 lm	PI1041	273,11 €	325 €
				3000 K	C	1230-1470 lm	PI1042		
				4000 K <span style="color: blue; font-weight: bold;">new</span>	C	1260-1510 lm	PI1043		
				2700 K	D	1180-1420 lm	PI1051		
				3000 K	C	1230-1470 lm	PI1052		
				4000 K <span style="color: blue; font-weight: bold;">new</span>	C	1260-1510 lm	PI1053		
	<b>Gehäuse S crémant</b> housing S crémant			2700 K	D	1180-1420 lm	PI1061	256,30 €	305 €
				3000 K	C	1230-1470 lm	PI1062		
				4000 K <span style="color: blue; font-weight: bold;">new</span>	C	1260-1510 lm	PI1063		
				2700 K	D	1180-1420 lm	PI1071		
				3000 K	C	1230-1470 lm	PI1072		
				4000 K <span style="color: blue; font-weight: bold;">new</span>	C	1260-1510 lm	PI1073		

 modular article  
 IP40 protection class  
 glass cover  
 chemically hardened

 LED  
 dimmable  
 CRI > 95  
 SDCM 3



# SLICE<sup>2</sup> PI Ceiling M new

Abbildung figure	Beschreibung description	Regelung control	Leistung power	CCT	EELCC	Lumen lumen	Art.-Nr. art.-no.	€ netto DE excl. VAT	€ brutto DE incl. VAT
	<b>DRIVER ENGINE</b> Ceiling M	TRIAC	15 W				DE011011	79,83 €	95 €
		DALI	15 W				DE011012	113,45 €	135 €
		CASAMBI <span style="background-color: #0070C0; color: white; padding: 2px;">new</span>	15 W				DE011012C	205,88 €	245 €
	<b>Gehäuse M schwarz</b> housing M black			2700 K	D	1900 lm	PI1101	327,73 €	390 €
				3000 K	C	1970 lm	PI1102		
				4000 K <span style="background-color: #0070C0; color: white; padding: 2px;">new</span>	C	2020 lm	PI1103		
				2700 K	D	1900 lm	PI1111		
				3000 K	C	1970 lm	PI1112		
				4000 K <span style="background-color: #0070C0; color: white; padding: 2px;">new</span>	C	2020 lm	PI1113		
	<b>Gehäuse M weiß</b> housing M white			2700 K	D	1900 lm	PI1121	327,73 €	390 €
				3000 K	C	1970 lm	PI1122		
				4000 K <span style="background-color: #0070C0; color: white; padding: 2px;">new</span>	C	2020 lm	PI1123		
				2700 K	D	1900 lm	PI1131		
				3000 K	C	1970 lm	PI1132		
				4000 K <span style="background-color: #0070C0; color: white; padding: 2px;">new</span>	C	2020 lm	PI1133		
	<b>Gehäuse M glanzverchromt</b> housing M chrome-plated			2700 K	D	1900 lm	PI1141	369,75 €	440 €
				3000 K	C	1970 lm	PI1142		
				4000 K <span style="background-color: #0070C0; color: white; padding: 2px;">new</span>	C	2020 lm	PI1143		
				2700 K	D	1900 lm	PI1151		
				3000 K	C	1970 lm	PI1152		
				4000 K <span style="background-color: #0070C0; color: white; padding: 2px;">new</span>	C	2020 lm	PI1153		
	<b>Gehäuse M crémant</b> housing M crémant			2700 K	D	1900 lm	PI1161	348,74 €	415 €
				3000 K	C	1970 lm	PI1162		
				4000 K <span style="background-color: #0070C0; color: white; padding: 2px;">new</span>	C	2020 lm	PI1163		
				2700 K	D	1900 lm	PI1171		
				3000 K	C	1970 lm	PI1172		
				4000 K <span style="background-color: #0070C0; color: white; padding: 2px;">new</span>	C	2020 lm	PI1173		

-  modular article
-  IP40 protection class
-  glass cover
-  chemically hardened

-  LED
-  dimmable
-  CRI > 95
-  SDCM 3

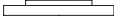
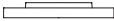



# SLICE<sup>2</sup> PI Ceiling L new







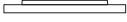

Abbildung figure	Beschreibung description	Regelung control	Leistung power	CCT	EELCC	Lumen lumen	Art.-Nr. art.-no.	€ netto DE excl. VAT	€ brutto DE incl. VAT
	<b>DRIVER ENGINE</b> Ceiling L	TRIAC	22 W				DE011021	105,04 €	125 €
		DALI	22 W				DE011022	142,86 €	170 €
		CASAMBI	22 W				DE011022C	243,70 €	290 €
		SENSORIK	22 W				DE011022S	210,08 €	250 €
	<b>Gehäuse L schwarz</b> housing L black			2700 K	D	2840 lm	PI1201	445,38 €	530 €
				3000 K	C	2950 lm	PI1202		
				4000 K <span style="background-color: #0070C0; color: white; padding: 2px;">new</span>	C	3030 lm	PI1203		
				2700 K	D	2840 lm	PI1211		
				3000 K	C	2950 lm	PI1212		
				4000 K <span style="background-color: #0070C0; color: white; padding: 2px;">new</span>	C	3030 lm	PI1213		
	<b>Gehäuse L weiß</b> housing L white			2700 K	D	2840 lm	PI1221	445,38 €	530 €
				3000 K	C	2950 lm	PI1222		
				4000 K <span style="background-color: #0070C0; color: white; padding: 2px;">new</span>	C	3030 lm	PI1223		
				2700 K	D	2840 lm	PI1231		
				3000 K	C	2950 lm	PI1232		
				4000 K <span style="background-color: #0070C0; color: white; padding: 2px;">new</span>	C	3030 lm	PI1233		
	<b>Gehäuse L glanzverchromt</b> housing L chrome-plated			2700 K	D	2840 lm	PI1241	504,20 €	600 €
				3000 K	C	2950 lm	PI1242		
				4000 K <span style="background-color: #0070C0; color: white; padding: 2px;">new</span>	C	3030 lm	PI1243		
				2700 K	D	2840 lm	PI1251		
				3000 K	C	2950 lm	PI1252		
				4000 K <span style="background-color: #0070C0; color: white; padding: 2px;">new</span>	C	3030 lm	PI1253		
	<b>Gehäuse L crémant</b> housing L crémant			2700 K	D	2840 lm	PI1261	470,58 €	560 €
				3000 K	C	2950 lm	PI1262		
				4000 K <span style="background-color: #0070C0; color: white; padding: 2px;">new</span>	C	3030 lm	PI1263		
				2700 K	D	2840 lm	PI1271		
				3000 K	C	2950 lm	PI1272		
				4000 K <span style="background-color: #0070C0; color: white; padding: 2px;">new</span>	C	3030 lm	PI1273		



-  modular article
-  IP40 protection class
-  through wiring
-  glass cover
-  chemically hardened
-  emergency light option
-  sensor option

- LED
-  dimmable
-  CRI >95
-  SDCM 3



# SLICE<sup>2</sup> PI Ceiling XL new







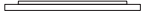

Abbildung figure	Beschreibung description	Regelung control	Leistung power	CCT	EELCC	Lumen lumen	Art.-Nr. art.-no.	€ netto DE excl. VAT	€ brutto DE incl. VAT
	<b>DRIVER ENGINE</b> Ceiling XL	TRIAC	30W				DE011031	126,05 €	150 €
		DALI	30W				DE011032	163,87 €	195 €
		CASAMBI	30W				DE011032C	268,90 €	320 €
		SENSORIK	30W				DE011032S	231,09 €	275 €
	<b>Gehäuse XL schwarz</b> housing XL black			2700K	D	3790lm	PI1301	588,24 €	700 €
				3000K	C	3930lm	PI1302		
				4000K <span style="color: #0070C0;">new</span>	C	4040lm	PI1303		
				2700K	D	3790lm	PI1311		
				3000K	C	3930lm	PI1312		
				4000K <span style="color: #0070C0;">new</span>	C	4040lm	PI1313		
	<b>Gehäuse XL weiß</b> housing XL white			2700K	D	3790lm	PI1321	588,24 €	700 €
				3000K	C	3930lm	PI1322		
				4000K <span style="color: #0070C0;">new</span>	C	4040lm	PI1323		
				2700K	D	3790lm	PI1331		
				3000K	C	3930lm	PI1332		
				4000K <span style="color: #0070C0;">new</span>	C	4040lm	PI1333		
	<b>Gehäuse XL glanzverchromt</b> housing XL chrome-plated			2700K	D	3790lm	PI1341	672,27 €	800 €
				3000K	C	3930lm	PI1342		
				4000K <span style="color: #0070C0;">new</span>	C	4040lm	PI1343		
				2700K	D	3790lm	PI1351		
				3000K	C	3930lm	PI1352		
				4000K <span style="color: #0070C0;">new</span>	C	4040lm	PI1353		
	<b>Gehäuse XL crémant</b> housing XL crémant			2700K	D	3790lm	PI1361	630,25 €	750 €
				3000K	C	3930lm	PI1362		
				4000K <span style="color: #0070C0;">new</span>	C	4040lm	PI1363		
				2700K	D	3790lm	PI1371		
				3000K	C	3930lm	PI1372		
				4000K <span style="color: #0070C0;">new</span>	C	4040lm	PI1373		

-  modular article
-  IP40 protection class
-  through wiring
-  glass cover
-  chemically hardened
-  emergency light option
-  battery option
-  sensor option

- LED
-  dimmable
-  CRI >95
-  SDCM 3

# SLICE<sup>2</sup> PI Ceiling XXL new

Abbildung figure	Beschreibung description	Regelung control	Leistung power	CCT	EELCC	Lumen lumen	Art.-Nr. art.-no.	€ netto DE excl. VAT	€ brutto DE incl. VAT
	<b>DRIVER ENGINE</b> Ceiling XXL	TRIAC	40W				DE011041	126,05 €	150 €
		DALI	40W				DE011042	163,87 €	195 €
		CASAMBI	40W				DE011042C	268,90 €	320 €
		SENSORIK	40W				DE011042S	231,09 €	275 €
	<b>Gehäuse XXL schwarz</b> housing XXL black			2700K	D	5685lm	PI1401	747,90 €	890 €
				3000K	C	5895lm	PI1402		
				4000K	C	6060lm	PI1403		
				2700K	D	5685lm	PI1411		
				3000K	C	5895lm	PI1412		
				4000K	C	6060lm	PI1413		
	<b>Gehäuse XXL weiß</b> housing XXL white			2700K	D	5685lm	PI1421	747,90 €	890 €
				3000K	C	5895lm	PI1422		
				4000K	C	6060lm	PI1423		
				2700K	D	5685lm	PI1431		
				3000K	C	5895lm	PI1432		
				4000K	C	6060lm	PI1433		
	<b>Gehäuse XXL crémant</b> housing XXL crémant			2700K	D	5685lm	PI1461	798,32 €	950 €
				3000K	C	5895lm	PI1462		
				4000K	C	6060lm	PI1463		
				2700K	D	5685lm	PI1471		
				3000K	C	5895lm	PI1472		
				4000K	C	6060lm	PI1473		

-  modular article
-  IP40 protection class
-  through wiring
-  glass cover
-  chemically hardened
-  emergency light option
-  battery option
-  sensor option

- LED**
-  dimmable
-  CRI >95
-  SDCM 3

# SLICE<sup>2</sup> PI Suspension new

## Cable

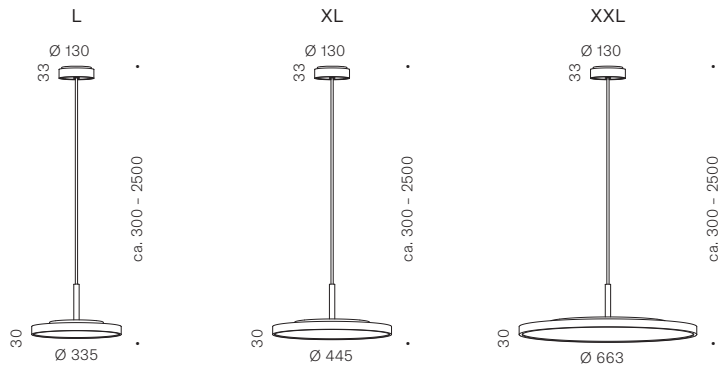

## Rope

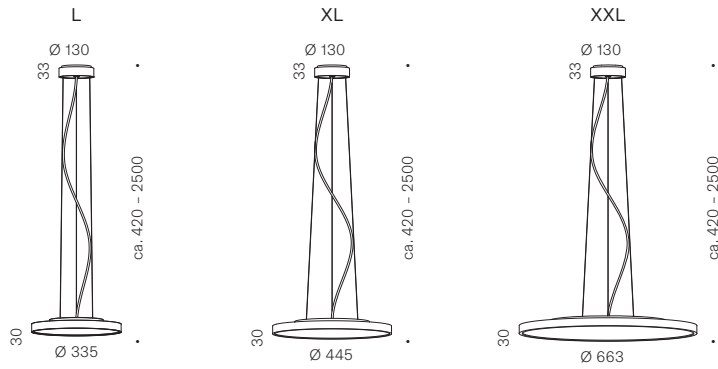

## Tube

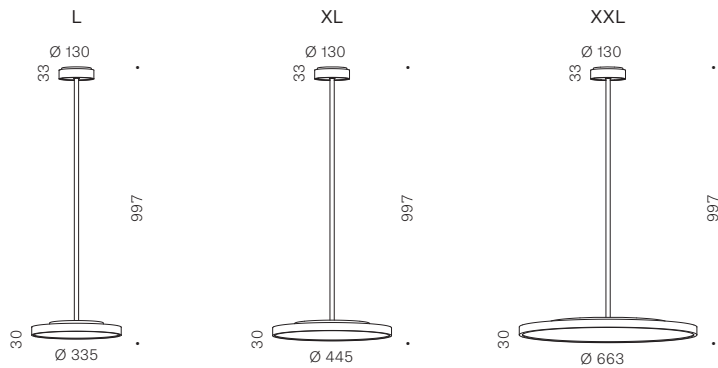

**Winkeladapter für Dachsträgen in weiß oder schwarz erhältlich – Montagehilfe für einfache Installation.**

**Der Winkel kann individuell angefertigt werden – Sonderfarben auf Anfrage.**

**Bestellungen (Art.-Nr.: weiß ZB1015, schwarz ZB1016) bitte in Abstimmung mit dem Vertrieb.**







Angle brackets for sloping roofs available in white or black – to assist with easy installation.









The brackets can be made to measure – special colours available on request.

Please coordinate orders (art.-no.: white ZB1015, black ZB1016) with the sales department.











# SLICE<sup>2</sup> PI Suspension Cable L new

Abbildung figure	Beschreibung description	Regelung control	Leistung power	CCT	EELCC	Lumen lumen	Art.-Nr. art.-no.	€ netto DE excl. VAT	€ brutto DE incl. VAT
	<b>DRIVER ENGINE</b> <b>Suspension Cable L schwarz</b> Suspension Cable L black	TRIAC	22 W				DE021111	247,90 €	295 €
		DALI	22 W				DE021211	285,71 €	340 €
		CASAMBI	22 W				DE021311	327,73 €	390 €
		SENSORIK	22 W				DE021411	352,94 €	420 €
	<b>DRIVER ENGINE</b> <b>Suspension Cable L weiß</b> Suspension Cable L white	TRIAC	22 W				DE021112	247,90 €	295 €
		DALI	22 W				DE021212	285,71 €	340 €
		CASAMBI	22 W				DE021312	327,73 €	390 €
		SENSORIK	22 W				DE021412	352,94 €	420 €
	<b>DRIVER ENGINE</b> <b>Suspension Cable L glanzverchromt</b> Suspension Cable L chrome	TRIAC	22 W				DE021113	289,92 €	345 €
		DALI	22 W				DE021213	327,73 €	390 €
		CASAMBI	22 W				DE021313	369,75 €	440 €
		SENSORIK	22 W				DE021413	394,96 €	470 €
	<b>DRIVER ENGINE</b> <b>Suspension Cable L crémant</b> Suspension Cable L crémant	TRIAC	22 W				DE021114	273,11 €	325 €
		DALI	22 W				DE021214	310,92 €	370 €
		CASAMBI	22 W				DE021314	352,94 €	420 €
		SENSORIK	22 W				DE021414	378,15 €	450 €
	<b>Gehäuse L schwarz</b> housing L black			2700 K	D	2840 lm	PI1211		
				3000 K	C	2950 lm	PI1212		
				4000 K <span style="color: #0070C0;">new</span>	C	3030 lm	PI1213	445,38 €	530 €
	<b>Gehäuse L weiß</b> housing L white			2700 K	D	2840 lm	PI1231		
				3000 K	C	2950 lm	PI1232		
				4000 K <span style="color: #0070C0;">new</span>	C	3030 lm	PI1233		
	<b>Gehäuse L glanzverchromt</b> housing L chrome-plated			2700 K	D	2840 lm	PI1251		
				3000 K	C	2950 lm	PI1252	504,20 €	600 €
				4000 K <span style="color: #0070C0;">new</span>	C	3030 lm	PI1253		
	<b>Gehäuse L crémant</b> housing L crémant			2700 K	D	2840 lm	PI1271		
				3000 K	C	2950 lm	PI1272	470,58 €	560 €
				4000 K <span style="color: #0070C0;">new</span>	C	3030 lm	PI1273		

-  modular article
-  IP40 protection class
-  through wiring
-  glass cover
-  chemically hardened
-  + length option
-  emergency light option
-  sensor option

-  LED
-  dimmable
-  CRI >95
-  SDCM 3







# SLICE<sup>2</sup> PI Suspension Cable XL new

Abbildung figure	Beschreibung description	Regelung control	Leistung power	CCT	EELCC	Lumen lumen	Art.-Nr. art.-no.	€ netto DE excl. VAT	€ brutto DE incl. VAT	
	<b>DRIVER ENGINE</b> <b>Suspension Cable XL schwarz</b> Suspension Cable XL black	TRIAC	30W				DE022111	285,71 €	340 €	
		DALI	30W				DE022211	331,93 €	395 €	
		CASAMBI	30W				DE022311	365,55 €	435 €	
		SENSORIK	30W				DE022411	390,76 €	465 €	
	<b>DRIVER ENGINE</b> <b>Suspension Cable XL weiß</b> Suspension Cable XL white	TRIAC	30W				DE022112	285,71 €	340 €	
		DALI	30W				DE022212	331,93 €	395 €	
		CASAMBI	30W				DE022312	365,55 €	435 €	
		SENSORIK	30W				DE022412	390,76 €	465 €	
	<b>DRIVER ENGINE</b> <b>Suspension Cable XL glanzverchromt</b> Suspension Cable XL chrome	TRIAC	30W				DE022113	344,54 €	410 €	
		DALI	30W				DE022213	390,76 €	465 €	
		CASAMBI	30W				DE022313	424,37 €	505 €	
		SENSORIK	30W				DE022413	449,58 €	535 €	
	<b>DRIVER ENGINE</b> <b>Suspension Cable XL crémant</b> Suspension Cable XL crémant	TRIAC	30W				DE022114	323,53 €	385 €	
		DALI	30W				DE022214	369,75 €	440 €	
		CASAMBI	30W				DE022314	403,36 €	480 €	
		SENSORIK	30W				DE022414	428,57 €	510 €	
	<b>Gehäuse XL schwarz</b> housing XL black			2700 K	D	3790 lm	PI1311			
				3000 K	C	3930 lm	PI1312			
				4000 K <span style="background-color: #0070C0; color: white; padding: 2px;">new</span>	C	4040 lm	PI1313		588,24 €	700 €
	<b>Gehäuse XL weiß</b> housing XL white			2700 K	D	3790 lm	PI1331			
				3000 K	C	3930 lm	PI1332			
				4000 K <span style="background-color: #0070C0; color: white; padding: 2px;">new</span>	C	4040 lm	PI1333			
	<b>Gehäuse XL glanzverchromt</b> housing XL chrome-plated			2700 K	D	3790 lm	PI1351			
				3000 K	C	3930 lm	PI1352		672,27 €	800 €
				4000 K <span style="background-color: #0070C0; color: white; padding: 2px;">new</span>	C	4040 lm	PI1353			
	<b>Gehäuse XL crémant</b> housing XL crémant			2700 K	D	3790 lm	PI1371			
				3000 K	C	3930 lm	PI1372		630,25 €	750 €
				4000 K <span style="background-color: #0070C0; color: white; padding: 2px;">new</span>	C	4040 lm	PI1373			

-  modular article
-  IP40 protection class
-  through wiring
-  glass cover
-  chemically hardened
-  + length option
-  emergency light option
-  battery option
-  sensor option

- LED
-  dimmable
-  CRI >95
-  SDCM 3

# SLICE<sup>2</sup> PI Suspension Cable XXL new



Abbildung figure	Beschreibung description	Regelung control	Leistung power	CCT	EEK EEC	Lumen lumen	Art.-Nr. art.-no.	€ netto DE excl. VAT	€ brutto DE incl. VAT
	<b>DRIVER ENGINE</b> <b>Suspension Cable XXL schwarz</b> Suspension Cable XXL black	TRIAC	40W				DE023111	310,92 €	370 €
		DALI	40W				DE023211	357,14 €	425 €
		CASAMBI	40W				DE023311	390,76 €	465 €
		SENSORIK	40W				DE023411	415,97 €	495 €
	<b>DRIVER ENGINE</b> <b>Suspension Cable XXL weiß</b> Suspension Cable XXL white	TRIAC	40W				DE023112	310,92 €	370 €
		DALI	40W				DE023212	357,14 €	425 €
		CASAMBI	40W				DE023312	390,76 €	465 €
		SENSORIK	40W				DE023412	415,97 €	495 €
	<b>DRIVER ENGINE</b> <b>Suspension Cable XXL crémant</b> Suspension Cable XXL crémant	TRIAC	40W				DE023114	361,34 €	430 €
		DALI	40W				DE023214	407,56 €	485 €
		CASAMBI	40W				DE023314	441,18 €	525 €
		SENSORIK	40W				DE023414	466,39 €	555 €
	<b>Gehäuse XXL schwarz</b> housing XXL black			2700 K	D	5685 lm	PI1411		
				3000 K	C	5895 lm	PI1412		
				4000 K	C	6060 lm	PI1413		
				2700 K	D	5685 lm	PI1431		747,90 €
	<b>Gehäuse XXL weiß</b> housing XXL white			3000 K	C	5895 lm	PI1432		
				4000 K	C	6060 lm	PI1433		
				2700 K	D	5685 lm	PI1471		
				3000 K	C	5895 lm	PI1472		798,32 €
	<b>Gehäuse XXL crémant</b> housing XXL crémant			4000 K	C	6060 lm	PI1473		









-  modular article
-  IP40 protection class
-  through wiring
-  glass cover
-  chemically hardened
-  + length option
-  emergency light option
-  battery option
-  sensor option

LED











# SLICE<sup>2</sup> PI Suspension Rope L new

Abbildung figure	Beschreibung description	Regelung control	Leistung power	CCT	EELCC	Lumen lumen	Art.-Nr. art.-no.	€ netto DE excl. VAT	€ brutto DE incl. VAT
	<b>DRIVER ENGINE</b> <b>Suspension Rope L schwarz</b> Suspension Rope L black	TRIAC	22 W				DE021121	239,50 €	285 €
		DALI	22 W				DE021221	277,31 €	330 €
		CASAMBI	22 W				DE021321	319,33 €	380 €
		SENSORIK	22 W				DE021421	344,54 €	410 €
	<b>DRIVER ENGINE</b> <b>Suspension Rope L weiß</b> Suspension Rope L white	TRIAC	22 W				DE021122	239,50 €	285 €
		DALI	22 W				DE021222	277,31 €	330 €
		CASAMBI	22 W				DE021322	319,33 €	380 €
		SENSORIK	22 W				DE021422	344,54 €	410 €
	<b>DRIVER ENGINE</b> <b>Suspension Rope L glanzverchromt</b> Suspension Rope L chrome	TRIAC	22 W				DE021123	281,51 €	335 €
		DALI	22 W				DE021223	319,33 €	380 €
		CASAMBI	22 W				DE021323	361,34 €	430 €
		SENSORIK	22 W				DE021423	386,55 €	460 €
	<b>DRIVER ENGINE</b> <b>Suspension Rope L crémant</b> Suspension Rope L crémant	TRIAC	22 W				DE021124	264,71 €	315 €
		DALI	22 W				DE021224	302,52 €	360 €
		CASAMBI	22 W				DE021324	344,54 €	410 €
		SENSORIK	22 W				DE021424	369,75 €	440 €
	<b>Gehäuse L schwarz</b> housing L black			2700 K	D	2840 lm	PI1211		
				3000 K	C	2950 lm	PI1212		
				4000 K <span style="color: #0070C0;">new</span>	C	3030 lm	PI1213	445,38 €	530 €
	<b>Gehäuse L weiß</b> housing L white			2700 K	D	2840 lm	PI1231		
				3000 K	C	2950 lm	PI1232		
				4000 K <span style="color: #0070C0;">new</span>	C	3030 lm	PI1233		
	<b>Gehäuse L glanzverchromt</b> housing L chrome-plated			2700 K	D	2840 lm	PI1251		
				3000 K	C	2950 lm	PI1252	504,20 €	600 €
				4000 K <span style="color: #0070C0;">new</span>	C	3030 lm	PI1253		
	<b>Gehäuse L crémant</b> housing L crémant			2700 K	D	2840 lm	PI1271		
				3000 K	C	2950 lm	PI1272	470,58 €	560 €
				4000 K <span style="color: #0070C0;">new</span>	C	3030 lm	PI1273		

-  modular article
-  IP40 protection class
-  through wiring
-  glass cover
-  chemically hardened
-  + length option
-  emergency light option
-  sensor option

- LED
-  dimmable
-  CRI >95
-  SDCM 3

# SLICE<sup>2</sup> PI Suspension Rope XL new

Abbildung figure	Beschreibung description	Regelung control	Leistung power	CCT	EEK EEC	Lumen lumen	Art.-Nr. art.-no.	€ netto DE excl. VAT	€ brutto DE incl. VAT	
	<b>DRIVER ENGINE</b> <b>Suspension Rope XL schwarz</b> Suspension Rope XL black	TRIAC	30W				DE022121	277,31 €	330 €	
		DALI	30W				DE022221	323,53 €	385 €	
		CASAMBI	30W				DE022321	357,14 €	425 €	
		SENSORIK	30W				DE022421	382,35 €	455 €	
	<b>DRIVER ENGINE</b> <b>Suspension Rope XL weiß</b> Suspension Rope XL white	TRIAC	30W				DE022122	277,31 €	330 €	
		DALI	30W				DE022222	323,53 €	385 €	
		CASAMBI	30W				DE022322	357,14 €	425 €	
		SENSORIK	30W				DE022422	382,35 €	455 €	
	<b>DRIVER ENGINE</b> <b>Suspension Rope XL glanzverchromt</b> Suspension Rope XL chrome	TRIAC	30W				DE022123	336,13 €	400 €	
		DALI	30W				DE022223	382,35 €	455 €	
		CASAMBI	30W				DE022323	415,97 €	495 €	
		SENSORIK	30W				DE022423	441,18 €	525 €	
	<b>DRIVER ENGINE</b> <b>Suspension Rope XL crémant</b> Suspension Rope XL crémant	TRIAC	30W				DE022124	323,53 €	385 €	
		DALI	30W				DE022224	369,75 €	440 €	
		CASAMBI	30W				DE022324	403,36 €	480 €	
		SENSORIK	30W				DE022424	428,57 €	510 €	
	<b>Gehäuse XL schwarz</b> housing XL black			2700 K	D	3790 lm	PI1311			
				3000 K	C	3930 lm	PI1312			
				4000 K <span style="background-color: #0070C0; color: white; padding: 2px;">new</span>	C	4040 lm	PI1313		588,24 €	700 €
	<b>Gehäuse XL weiß</b> housing XL white			2700 K	D	3790 lm	PI1331			
				3000 K	C	3930 lm	PI1332			
				4000 K <span style="background-color: #0070C0; color: white; padding: 2px;">new</span>	C	4040 lm	PI1333			
	<b>Gehäuse XL glanzverchromt</b> housing XL chrome-plated			2700 K	D	3790 lm	PI1351			
				3000 K	C	3930 lm	PI1352		672,27 €	800 €
				4000 K <span style="background-color: #0070C0; color: white; padding: 2px;">new</span>	C	4040 lm	PI1353			
	<b>Gehäuse XL crémant</b> housing XL crémant			2700 K	D	3790 lm	PI1371			
				3000 K	C	3930 lm	PI1372		630,25 €	750 €
				4000 K <span style="background-color: #0070C0; color: white; padding: 2px;">new</span>	C	4040 lm	PI1373			

-  modular article
-  IP40 protection class
-  through wiring
-  glass cover
-  chemically hardened
-  + length option
-  emergency light option
-  battery option
-  sensor option

LED









# SLICE<sup>2</sup> PI Suspension Rope XXL new

Abbildung figure	Beschreibung description	Regelung control	Leistung power	CCT	EELCC	Lumen lumen	Art.-Nr. art.-no.	€ netto DE excl. VAT	€ brutto DE incl. VAT
	<b>DRIVER ENGINE</b> <b>Suspension Rope XXL schwarz</b> Suspension Rope XXL black	TRIAC	40 W				DE023121	302,52 €	360 €
		DALI	40 W				DE023221	348,74 €	415 €
		CASAMBI	40 W				DE023321	382,35 €	455 €
		SENSORIK	40 W				DE023421	407,56 €	485 €
	<b>DRIVER ENGINE</b> <b>Suspension Rope XXL weiß</b> Suspension Rope XXL white	TRIAC	40 W				DE023122	302,52 €	360 €
		DALI	40 W				DE023222	348,74 €	415 €
		CASAMBI	40 W				DE023322	382,35 €	455 €
		SENSORIK	40 W				DE023422	407,56 €	485 €
	<b>DRIVER ENGINE</b> <b>Suspension Rope XXL crémant</b> Suspension Rope XXL crémant	TRIAC	40 W				DE023124	352,94 €	420 €
		DALI	40 W				DE023224	399,16 €	475 €
		CASAMBI	40 W				DE023324	432,77 €	515 €
		SENSORIK	40 W				DE023424	457,98 €	545 €
		<b>Gehäuse XXL schwarz</b> housing XXL black		2700 K	D	5685 lm	PI1411	747,90 €	890 €
		3000 K	C	5895 lm	PI1412				
		4000 K	C	6060 lm	PI1413				
		<b>Gehäuse XXL weiß</b> housing XXL white		2700 K	D	5685 lm	PI1431	798,32 €	950 €
		3000 K	C	5895 lm	PI1432				
		4000 K	C	6060 lm	PI1433				
		<b>Gehäuse XXL crémant</b> housing XXL crémant		2700 K	D	5685 lm	PI1471	798,32 €	950 €
		3000 K	C	5895 lm	PI1472				
		4000 K	C	6060 lm	PI1473				

- modular article
- IP40 protection class
- through wiring
- glass cover
- chemically hardened
- + length option
- emergency light option
- battery option
- sensor option

- LED
- dimmable
- CRI >95
- SDCM 3



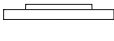
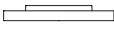





# SLICE<sup>2</sup> PI Suspension Tube L new













Abbildung figure	Beschreibung description	Regelung control	Leistung power	CCT	EELCC	Lumen lumen	Art.-Nr. art.-no.	€ netto DE excl. VAT	€ brutto DE incl. VAT
	<b>DRIVER ENGINE</b> <b>Suspension Tube L schwarz</b> Suspension Tube L black	TRIAC	22 W				DE021131	222,69 €	265 €
		DALI	22 W				DE021231	260,50 €	310 €
		CASAMBI	22 W				DE021331	302,52 €	360 €
		SENSORIK	22 W				DE021431	344,54 €	410 €
	<b>DRIVER ENGINE</b> <b>Suspension Tube L weiß</b> Suspension Tube L white	TRIAC	22 W				DE021132	222,69 €	265 €
		DALI	22 W				DE021232	260,50 €	310 €
		CASAMBI	22 W				DE021332	302,52 €	360 €
		SENSORIK	22 W				DE021432	344,54 €	410 €
	<b>DRIVER ENGINE</b> <b>Suspension Tube L glanzverchromt</b> Suspension Tube L chrome	TRIAC	22 W				DE021133	264,71 €	315 €
		DALI	22 W				DE021233	302,52 €	360 €
		CASAMBI	22 W				DE021333	344,54 €	410 €
		SENSORIK	22 W				DE021433	386,55 €	460 €
	<b>DRIVER ENGINE</b> <b>Suspension Tube L crémant</b> Suspension Tube L crémant	TRIAC	22 W				DE021134	247,90 €	295 €
		DALI	22 W				DE021234	285,71 €	340 €
		CASAMBI	22 W				DE021334	327,73 €	390 €
		SENSORIK	22 W				DE021434	369,75 €	440 €
	<b>Gehäuse L schwarz</b> housing L black			2700 K	D	2840 lm	PI1211		
				3000 K	C	2950 lm	PI1212		
				4000 K <span style="color: blue; font-weight: bold;">new</span>	C	3030 lm	PI1213		445,38 €
	<b>Gehäuse L weiß</b> housing L white			2700 K	D	2840 lm	PI1231		
				3000 K	C	2950 lm	PI1232		
				4000 K <span style="color: blue; font-weight: bold;">new</span>	C	3030 lm	PI1233		
	<b>Gehäuse L glanzverchromt</b> housing L chrome-plated			2700 K	D	2840 lm	PI1251		
				3000 K	C	2950 lm	PI1252	504,20 €	600 €
				4000 K <span style="color: blue; font-weight: bold;">new</span>	C	3030 lm	PI1253		
	<b>Gehäuse L crémant</b> housing L crémant			2700 K	D	2840 lm	PI1271		
				3000 K	C	2950 lm	PI1272	470,58 €	560 €
				4000 K <span style="color: blue; font-weight: bold;">new</span>	C	3030 lm	PI1273		

-  modular article
-  IP40 protection class
-  through wiring
-  glass cover
-  chemically hardened
-  tube cuttable
-  + length option
-  emergency light option
-  sensor option







- LED
-  dimmable
-  CRI >95
-  SDCM 3











# SLICE<sup>2</sup> PI Suspension Tube XL new

Abbildung figure	Beschreibung description	Regelung control	Leistung power	CCT	EELCC	Lumen lumen	Art.-Nr. art.-no.	€ netto DE excl. VAT	€ brutto DE incl. VAT
	<b>DRIVER ENGINE</b> <b>Suspension Tube XL schwarz</b> Suspension Tube XL black	TRIAC	30 W				DE022131	260,50 €	310 €
		DALI	30 W				DE022231	306,72 €	365 €
		CASAMBI	30 W				DE022331	340,34 €	405 €
		SENSORIK	30 W				DE022431	382,35 €	455 €
	<b>DRIVER ENGINE</b> <b>Suspension Tube XL weiß</b> Suspension Tube XL white	TRIAC	30 W				DE022132	260,50 €	310 €
		DALI	30 W				DE022232	306,72 €	365 €
		CASAMBI	30 W				DE022332	340,34 €	405 €
		SENSORIK	30 W				DE022432	382,35 €	455 €
	<b>DRIVER ENGINE</b> <b>Suspension Tube XL glanzverchromt</b> Suspension Tube XL chrome	TRIAC	30 W				DE022133	319,33 €	380 €
		DALI	30 W				DE022233	365,55 €	435 €
		CASAMBI	30 W				DE022333	399,16 €	475 €
		SENSORIK	30 W				DE022433	441,18 €	525 €
	<b>DRIVER ENGINE</b> <b>Suspension Tube XL crémant</b> Suspension Tube XL crémant	TRIAC	30 W				DE022134	306,72 €	365 €
		DALI	30 W				DE022234	352,94 €	420 €
		CASAMBI	30 W				DE022334	386,55 €	460 €
		SENSORIK	30 W				DE022434	428,57 €	510 €
	<b>Gehäuse XL schwarz</b> housing XL black			2700 K	D	3790 lm	PI1311		
				3000 K	C	3930 lm	PI1312		
				4000 K <span style="color: #0070C0;">new</span>	C	4040 lm	PI1313		588,24 €
	<b>Gehäuse XL weiß</b> housing XL white			2700 K	D	3790 lm	PI1331		
				3000 K	C	3930 lm	PI1332		
				4000 K <span style="color: #0070C0;">new</span>	C	4040 lm	PI1333		
	<b>Gehäuse XL glanzverchromt</b> housing XL chrome-plated			2700 K	D	3790 lm	PI1351		
				3000 K	C	3930 lm	PI1352	672,27 €	800 €
				4000 K <span style="color: #0070C0;">new</span>	C	4040 lm	PI1353		
	<b>Gehäuse XL crémant</b> housing XL crémant			2700 K	D	3790 lm	PI1371		
				3000 K	C	3930 lm	PI1372	630,25 €	750 €
				4000 K <span style="color: #0070C0;">new</span>	C	4040 lm	PI1373		



-  modular article
-  IP40 protection class
-  through wiring
-  glass cover
-  chemically hardened
-  tube cuttable
-  + length option
-  emergency light option
-  battery option
-  sensor option
- LED**
-  dimmable
-  CRI >95
-  SDCM 3

# SLICE<sup>2</sup> PI Suspension Tube XXL new

Abbildung figure	Beschreibung description	Regelung control	Leistung power	CCT	EEK EEC	Lumen lumen	Art.-Nr. art.-no.	€ netto DE excl. VAT	€ brutto DE incl. VAT
	<b>DRIVER ENGINE</b> <b>Suspension Tube XXL schwarz</b> Suspension Tube XXL black	TRIAC	40W				DE023131	285,71 €	340 €
		DALI	40W				DE023231	331,93 €	395 €
		CASAMBI	40W				DE023331	365,55 €	435 €
		SENSORIK	40W				DE023431	390,76 €	465 €
	<b>DRIVER ENGINE</b> <b>Suspension Tube XXL weiß</b> Suspension Tube XXL white	TRIAC	40W				DE023132	285,71 €	340 €
		DALI	40W				DE023232	331,93 €	395 €
		CASAMBI	40W				DE023332	365,55 €	435 €
		SENSORIK	40W				DE023432	390,76 €	465 €
	<b>DRIVER ENGINE</b> <b>Suspension Tube XXL crémant</b> Suspension Tube XXL crémant	TRIAC	40W				DE023134	336,13 €	400 €
		DALI	40W				DE023234	382,35 €	455 €
		CASAMBI	40W				DE023334	432,77 €	515 €
		SENSORIK	40W				DE023434	441,18 €	525 €
	<b>Gehäuse XXL schwarz</b> housing XXL black			2700 K	D	5685 lm	PI1411		
				3000 K	C	5895 lm	PI1412		
				4000 K	C	6060 lm	PI1413		
	<b>Gehäuse XXL weiß</b> housing XXL white			2700 K	D	5685 lm	PI1431		
				3000 K	C	5895 lm	PI1432		
				4000 K	C	6060 lm	PI1433		
	<b>Gehäuse XXL crémant</b> housing XXL crémant			2700 K	D	5685 lm	PI1471		
				3000 K	C	5895 lm	PI1472	798,32 €	950 €
				4000 K	C	6060 lm	PI1473		

-  modular article
-  IP40 protection class
-  through wiring
-  glass cover
-  chemically hardened
-  tube cuttable
-  + length option
-  emergency light option
-  battery option
-  sensor option

LED

-  dimmable
-  CRI >95
-  SDCM 3

# SLICE<sup>2</sup> PI Wall new

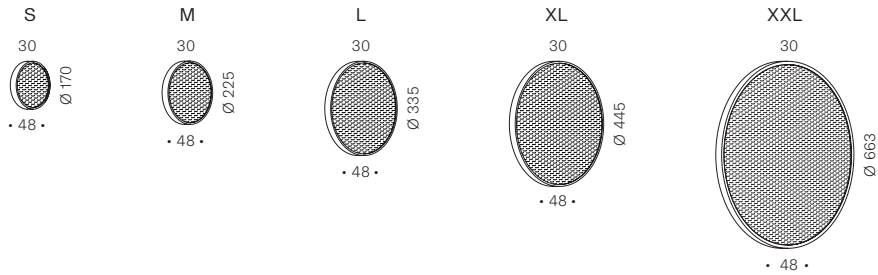

individual

Das asymmetrische Entblenderaster wird standardmäßig in weißer Pulverbeschichtung geliefert. Auf Anfrage kann die Vorderseite individuell farbig lackiert werden und ermöglicht so eine dekorative Gestaltung. Die Rückseite bleibt grundsätzlich weiß, um lichttechnisch optimale Eigenschaften sicherzustellen. Für eine individuelle Farbausführung kontaktieren Sie bitte den Vertrieb.





The asymmetrical anti-glare louvre is supplied as standard with a white powder-coated finish. On request, the front can be custom-painted in a colour of your choice, allowing for a decorative design. The rear remains white at all times to ensure optimal lighting performance. Please contact our sales department for custom colour options.



SLICE<sup>2</sup> PI Wall ist auch für die Deckenmontage geeignet- mit der asymmetrischen Abstrahlcharakteristik eines Wallwashers. Die rotationsymmetrisch nach unten abstrahlende Deckenleuchte finden Sie ab Seite 79.

SLICE<sup>2</sup> PI Wall is also suitable for ceiling mounting, allowing its asymmetrical beam pattern to be used as a wallwasher. You can find the rotationally symmetrical ceiling light with downward-facing light on page 79 onwards.





## SLICE<sup>2</sup> PI Wall S new

Abbildung figure	Beschreibung description	Regelung control	Leistung power	CCT	EEL EEC	Lumen lumen	Art.-Nr. art.-no.	€ netto DE excl. VAT	€ brutto DE incl. VAT
 <span style="background-color: #0056b3; color: white; padding: 2px;">new</span>	<b>DRIVER ENGINE</b> Wall S	TRIAC	13 W				DE021001	67,23 €	80 €
		DALI	10 W				DE021002	84,03 €	100 €
		CASAMBI	10 W				DE021002C	168,07 €	200 €
 <span style="background-color: #0056b3; color: white; padding: 2px;">new</span>	<b>Gehäuse S schwarz, asymmetrisches Entblenderaster</b> housing S black, asymmetrical anti-glare grid			2700K	D	1180-1420lm	PI2011	239,50 €	285 €
				3000K	C	1230-1470lm	PI2012		
				4000K	C	1260-1510lm	PI2013		
 <span style="background-color: #0056b3; color: white; padding: 2px;">new</span>	<b>Gehäuse S weiß, asymmetrisches Entblenderaster</b> housing S white, asymmetrical anti-glare grid			2700K	D	1180-1420lm	PI2031	273,11 €	325 €
				3000K	C	1230-1470lm	PI2032		
				4000K	C	1260-1510lm	PI2033		
 <span style="background-color: #0056b3; color: white; padding: 2px;">new</span>	<b>Gehäuse S glanzverchromt, asymmetrisches Entblenderaster</b> housing S chrome-plated, asymmetrical anti-glare grid			2700K	D	1180-1420lm	PI2051	256,30 €	305 €
				3000K	C	1230-1470lm	PI2052		
				4000K	C	1260-1510lm	PI2053		
 <span style="background-color: #0056b3; color: white; padding: 2px;">new</span>	<b>Gehäuse S crémant, asymmetrisches Entblenderaster</b> housing S crémant, asymmetrical anti-glare grid			2700K	D	1180-1420lm	PI2071		
				3000K	C	1230-1470lm	PI2072		
				4000K	C	1260-1510lm	PI2073		

 modular article  
 IP40 protection class  
 glass cover  
 chemically hardened  
 individual





LED  dimmable  CRI >95  SDCM 3

## SLICE<sup>2</sup> PI Wall M new

Abbildung figure	Beschreibung description	Regelung control	Leistung power	CCT	EEK EEC	Lumen lumen	Art.-Nr. art.-no.	€ netto DE excl. VAT	€ brutto DE incl. VAT
 <span style="color: #0070C0;">new</span>	<b>DRIVER ENGINE</b> Wall M	TRIAC	15 W				DE021011	79,83 €	95 €
		DALI	15 W				DE021012	113,45 €	135 €
		CASAMBI	15 W				DE021012C	205,88 €	245 €
 <span style="color: #0070C0;">new</span>	<b>Gehäuse M schwarz, asymmetrisches Entblenderaster</b> housing M black, asymmetrical anti-glare grid			2700 K	D	1900 lm	PI2111		
				3000 K	C	1970 lm	PI2112		
				4000 K	C	2020 lm	PI2113		
 <span style="color: #0070C0;">new</span>	<b>Gehäuse M weiß, asymmetrisches Entblenderaster</b> housing M white, asymmetrical anti-glare grid			2700 K	D	1900 lm	PI2131	327,73 €	390 €
				3000 K	C	1970 lm	PI2132		
				4000 K	C	2020 lm	PI2133		
 <span style="color: #0070C0;">new</span>	<b>Gehäuse M glanzverchromt, asymmetrisches Entblenderaster</b> housing M chrome-plated, asymmetrical anti-glare grid			2700 K	D	1900 lm	PI2151		
				3000 K	C	1970 lm	PI2152	369,75 €	440 €
				4000 K	C	2020 lm	PI2153		
 <span style="color: #0070C0;">new</span>	<b>Gehäuse M crémant, asymmetrisches Entblenderaster</b> housing M crémant, asymmetrical anti-glare grid			2700 K	D	1900 lm	PI2171		
				3000 K	C	1970 lm	PI2172	348,74 €	415 €
				4000 K	C	2020 lm	PI2173		



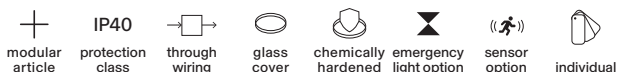

## SLICE<sup>2</sup> PI Wall L new

Abbildung figure	Beschreibung description	Regelung control	Leistung power	CCT	EEK EEC	Lumen lumen	Art.-Nr. art.-no.	€ netto DE excl. VAT	€ brutto DE incl. VAT
 <span style="color: #0070C0;">new</span>	<b>DRIVER ENGINE</b> Wall L	TRIAC	22 W				DE021021	105,04 €	125 €
		DALI	22 W				DE021022	142,86 €	170 €
		CASAMBI	22 W				DE021022C	243,70 €	290 €
		SENSORIK	22 W				DE021022S	210,08 €	250 €
 <span style="color: #0070C0;">new</span>	<b>Gehäuse L schwarz, asymmetrisches Entblenderaster</b> housing L black, asymmetrical anti-glare grid			2700 K	D	2840 lm	PI2211		
				3000 K	C	2950 lm	PI2212		
				4000 K	C	3030 lm	PI2213	445,38 €	530 €
 <span style="color: #0070C0;">new</span>	<b>Gehäuse L weiß, asymmetrisches Entblenderaster</b> housing L white, asymmetrical anti-glare grid			2700 K	D	2840 lm	PI2231		
				3000 K	C	2950 lm	PI2232		
				4000 K	C	3030 lm	PI2233		
 <span style="color: #0070C0;">new</span>	<b>Gehäuse L glanzverchromt, asymmetrisches Entblenderaster</b> housing L chrome-plated, asymmetrical anti-glare grid			2700 K	D	2840 lm	PI2251		
				3000 K	C	2950 lm	PI2252	504,20 €	600 €
				4000 K	C	3030 lm	PI2253		
 <span style="color: #0070C0;">new</span>	<b>Gehäuse L crémant, asymmetrisches Entblenderaster</b> housing L crémant, asymmetrical anti-glare grid			2700 K	D	2840 lm	PI2271		
				3000 K	C	2950 lm	PI2272	470,58 €	560 €
				4000 K	C	3030 lm	PI2273		

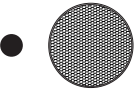
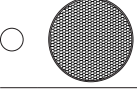

## SLICE<sup>2</sup> PI Wall XL new

Abbildung figure	Beschreibung description	Regelung control	Leistung power	CCT	EELCC	Lumen lumen	Art.-Nr. art.-no.	€ netto DE excl. VAT	€ brutto DE incl. VAT
	<b>DRIVER ENGINE</b> Wall XL	TRIAC	30 W				DE021031	126,05 €	150 €
		DALI	30 W				DE021032	163,87 €	195 €
		CASAMBI	30 W				DE021032C	268,90 €	320 €
		SENSORIK	30 W				DE021032S	231,09 €	275 €
	<b>Gehäuse XL schwarz, asymmetrisches Entblenderaster</b> housing XL black, asymmetrical anti-glare grid			2700 K	D	3790 lm	PI2311	588,24 €	700 €
				3000 K	C	3930 lm	PI2312		
				4000 K	C	4040 lm	PI2313		
	<b>Gehäuse XL weiß, asymmetrisches Entblenderaster</b> housing XL white, asymmetrical anti-glare grid			2700 K	D	3790 lm	PI2331	672,27 €	800 €
				3000 K	C	3930 lm	PI2332		
				4000 K	C	4040 lm	PI2333		
	<b>Gehäuse XL glanzverchromt, asymmetrisches Entblenderaster</b> housing XL chrome-plated, asymmetrical anti-glare grid			2700 K	D	3790 lm	PI2351	630,25 €	750 €
				3000 K	C	3930 lm	PI2352		
				4000 K	C	4040 lm	PI2353		
	<b>Gehäuse XL crémant, asymmetrisches Entblenderaster</b> housing XL crémant, asymmetrical anti-glare grid			2700 K	D	3790 lm	PI2371	630,25 €	750 €
				3000 K	C	3930 lm	PI2372		
				4000 K	C	4040 lm	PI2373		

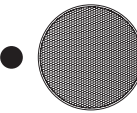
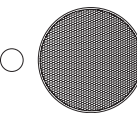
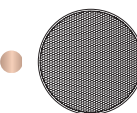

## SLICE<sup>2</sup> PI Wall XXL new

Abbildung figure	Beschreibung description	Regelung control	Leistung power	CCT	EELCC	Lumen lumen	Art.-Nr. art.-no.	€ netto DE excl. VAT	€ brutto DE incl. VAT
	<b>DRIVER ENGINE</b> Wall XXL	TRIAC	40 W				DE021041	126,05 €	150 €
		DALI	40 W				DE021042	163,87 €	195 €
		CASAMBI	40 W				DE021042C	268,90 €	320 €
		SENSORIK	40 W				DE021042S	231,09 €	275 €
	<b>Gehäuse XXL schwarz, asymmetrisches Entblenderaster</b> housing XXL black, asymmetrical anti-glare grid			2700 K	D	5685 lm	PI2411	747,90 €	890 €
				3000 K	C	5895 lm	PI2412		
				4000 K	C	6060 lm	PI2413		
	<b>Gehäuse XXL weiß, asymmetrisches Entblenderaster</b> housing XXL white, asymmetrical anti-glare grid			2700 K	D	5685 lm	PI2431	798,32 €	950 €
				3000 K	C	5895 lm	PI2432		
				4000 K	C	6060 lm	PI2433		
	<b>Gehäuse XXL crémant, asymmetrisches Entblenderaster</b> housing XXL crémant, asymmetrical anti-glare grid			2700 K	D	5685 lm	PI2471	798,32 €	950 €
				3000 K	C	5895 lm	PI2472		
				4000 K	C	6060 lm	PI2473		



# SML Wall

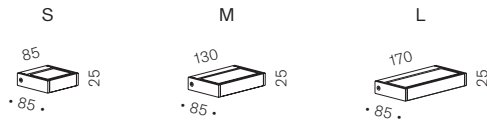



## SML Wall S



Abbildung figure	Beschreibung description	Fassung socket	Regelung control	Leistung power	EEK EEC	Art.-Nr. art.-no.	€ netto DE excl. VAT	€ brutto DE incl. VAT
●	<b>silber, satiniée/satiniée</b> silver, satiniée/satiniée	G9	TRIAC	max. 60 W	G	SM1172	243,70 €	290 €
	<b>silber, satiniée/Raster</b> silver, satiniée/raster	G9	TRIAC	max. 60 W	G	SM1199		
●	<b>glanzverchromt, satiniée/satiniée</b> chrome plated, satiniée/satiniée	G9	TRIAC	max. 60 W	G	SM3172	273,11 €	325 €
	<b>glanzverchromt, satiniée/Raster</b> chrome plated, satiniée/raster	G9	TRIAC	max. 60 W	G	SM3199		

IP20   
protection class glass cover

## Zubehör/Accessories



Abbildung figure	Beschreibung description	Art.-Nr. art.-no.	€ netto DE excl. VAT	€ brutto DE incl. VAT
	<b>Spiegeladapter Set</b> mirror adapter set	ZB1001	37,82 €	45 €
 22 75	<b>Wandabdeckung S silber eloxiert</b> wall cover S silver anodized	SM1053	31,09 €	37 €
	<b>Wandabdeckung S glanzverchromt</b> wall cover S chrome-plated	SM3053	45,38 €	54 €

## SML Wall M



Abbildung figure	Beschreibung description	Fassung socket	Regelung control	Leistung power	EEK EEC	Art.-Nr. art.-no.	€ netto DE excl. VAT	€ brutto DE incl. VAT
	<b>silber, satinée/satinée</b> silver, satinée/satinée	R7s	TRIAC	max. 120 W	G	SM1173	260,50 €	310 €
	<b>silber, satinée/Raster</b> silver, satinée/raster	R7s	TRIAC	max. 120 W	G	SM1198		
	<b>glanzverchromt, satinée/satinée</b> chrome plated, satinée/satinée	R7s	TRIAC	max. 120 W	G	SM3173	294,12 €	350 €
	<b>glanzverchromt, satinée/Raster</b> chrome plated, satinée/raster	R7s	TRIAC	max. 120 W	G	SM3177		

IP20   
protection class glass cover

## Zubehör/Accessories



Abbildung figure	Beschreibung description	Art.-Nr. art.-no.	€ netto DE excl. VAT	€ brutto DE incl. VAT
	<b>Spiegeladapter Set</b> mirror adapter set	ZB1001	37,82 €	45 €
	<b>Wandabdeckung M silber eloxiert</b> wall cover M silver anodized	SM1054	32,77 €	39 €
	<b>Wandabdeckung M glanzverchromt</b> wall cover M chrome-plated	SM3054	50,42 €	60 €

## SML Wall L

Abbildung figure	Beschreibung description	Fassung socket	Regelung control	Leistung power	EEK EEC	Art.-Nr. art.-no.	€ netto DE excl. VAT	€ brutto DE incl. VAT
	<b>silber, satinée/satinée</b> silver, satinée/satinée	R7s	TRIAC	max. 160 W	G	SM1174	285,71 €	340 €
	<b>silber, satinée/Raster</b> silver, satinée/raster	R7s	TRIAC	max. 160 W	G	SM1175		
	<b>glanzverchromt, satinée/satinée</b> chrome plated, satinée/satinée	R7s	TRIAC	max. 160 W	G	SM3174	323,53 €	385 €
	<b>glanzverchromt, satinée/Raster</b> chrome plated, satinée/raster	R7s	TRIAC	max. 160 W	G	SM3176		

IP20   
protection class glass cover

## Zubehör/Accessories

Abbildung figure	Beschreibung description	Art.-Nr. art.-no.	€ netto DE excl. VAT	€ brutto DE incl. VAT
	<b>Spiegeladapter Set</b> mirror adapter set	ZB1001	37,82 €	45 €
	<b>Wandabdeckung L silber eloxiert</b> wall cover L silver anodized	SM1055	37,82 €	45 €
	<b>Wandabdeckung L glanzverchromt</b> wall cover L chrome-plated	SM3055	54,62 €	65 €

# SML<sup>2</sup> Wall

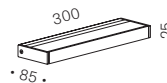
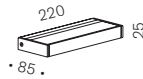
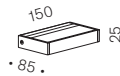



## SML<sup>2</sup> Wall 150

Abbildung figure	Beschreibung description	Regelung control	Leistung power	CCT	EEL EEC	Lumen lumen	Art.-Nr. art.-no.	€ netto DE excl. VAT	€ brutto DE incl. VAT		
●	<b>silber, satiniée/satiniée</b> silver, satiniée/satiniée	ON/OFF	10 W	2700 K	D	1420 lm	SM1325	348,74 €	415 €		
	3000 K			D	1450 lm	SM1227					
●	<b>silber, satiniée/Raster</b> silver, satiniée/raster	ON/OFF	10 W	2700 K	D	1420 lm	SM1326				
	3000 K			D	1450 lm	SM1228					
○	<b>weiß, satiniée/satiniée</b> white, satiniée/satiniée	ON/OFF	10 W	2700 K	D	1420 lm	SM1327			348,74 €	415 €
	3000 K			D	1450 lm	SM1229					
○	<b>weiß, satiniée/Raster</b> white, satiniée/raster	ON/OFF	10 W	2700 K	D	1420 lm	SM1328				
	3000 K			D	1450 lm	SM1230					
●	<b>schwarz, satiniée/satiniée</b> black, satiniée/satiniée	ON/OFF	10 W	2700 K	D	1420 lm	SM1329	348,74 €	415 €		
	3000 K			D	1450 lm	SM1231					
●	<b>schwarz, satiniée/Raster</b> black, satiniée/raster	ON/OFF	10 W	2700 K	D	1420 lm	SM1330				
	3000 K			D	1450 lm	SM1232					
●	<b>poliert, satiniée/satiniée</b> polished, satiniée/satiniée	ON/OFF	10 W	2700 K	D	1420 lm	SM1331			394,96 €	470 €
	3000 K			D	1450 lm	SM1233					
●	<b>poliert, satiniée/Raster</b> polished, satiniée/raster	ON/OFF	10 W	2700 K	D	1420 lm	SM1332				
	3000 K			D	1450 lm	SM1234					

IP20  
protection  
class

LED   
CRI >90

## Zubehör/Accessories

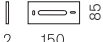
Abbildung figure	Beschreibung description	Art.-Nr. art.-no.	€ netto DE excl. VAT	€ brutto DE incl. VAT
	<b>Spiegeladapter Set</b> mirror adapter set	ZB1001	37,82 €	45 €
	<b>Wandadapter 150 silber</b> wall adapter 150 silver	SM8801	23,53 €	28 €
	<b>Wandadapter 150 weiß</b> wall adapter 150 white	SM8802		
	<b>Wandadapter 150 schwarz</b> wall adapter 150 black	SM8803		
	<b>Wandadapter 150 poliert</b> wall adapter 150 polished	SM8804		
	<b>Wandabdeckung 150 silber</b> wall cover 150 silver	SM4053	33,61 €	40 €
	<b>Wandabdeckung 150 weiß</b> wall cover 150 white	SM4056		
	<b>Wandabdeckung 150 schwarz</b> wall cover 150 black	SM4059		
	<b>Wandabdeckung 150 poliert</b> wall cover 150 polished	SM4062		

## SML<sup>2</sup> Wall 220

Abbildung figure	Beschreibung description	Regelung control	Leistung power	CCT	EEL EEC	Lumen lumen	Art.-Nr. art.-no.	€ netto DE excl. VAT	€ brutto DE incl. VAT
●	<b>silber, satinée/satinée</b> silver, satinée/satinée	TRIAC	15 W	2700 K	D	1960 lm	SM1333	436,97 €	520 €
	3000 K			D	2010 lm	SM1235			
●	<b>silber, satinée/Raster</b> silver, satinée/raster	TRIAC	15 W	2700 K	D	1960 lm	SM1334	436,97 €	520 €
	3000 K			D	2010 lm	SM1236			
○	<b>weiß, satinée/satinée</b> white, satinée/satinée	TRIAC	15 W	2700 K	D	1960 lm	SM1335	436,97 €	520 €
	3000 K			D	2010 lm	SM1237			
○	<b>weiß, satinée/Raster</b> white, satinée/raster	TRIAC	15 W	2700 K	D	1960 lm	SM1336	436,97 €	520 €
	3000 K			D	2010 lm	SM1238			
●	<b>schwarz, satinée/satinée</b> black, satinée/satinée	TRIAC	15 W	2700 K	D	1960 lm	SM1337	436,97 €	520 €
	3000 K			D	2010 lm	SM1239			
●	<b>schwarz, satinée/Raster</b> black, satinée/raster	TRIAC	15 W	2700 K	D	1960 lm	SM1338	436,97 €	520 €
	3000 K			D	2010 lm	SM1240			
●	<b>poliert, satinée/satinée</b> polished, satinée/satinée	TRIAC	15 W	2700 K	D	1960 lm	SM1339	478,99 €	570 €
	3000 K			D	2010 lm	SM1241			
●	<b>poliert, satinée/Raster</b> polished, satinée/raster	TRIAC	15 W	2700 K	D	1960 lm	SM1340	478,99 €	570 €
	3000 K			D	2010 lm	SM1242			

IP20

protection  
class

LED



dimmable CRI >90

## Zubehör/Accessories

Abbildung figure	Beschreibung description	Art.-Nr. art.-no.	€ netto DE excl. VAT	€ brutto DE incl. VAT
	<b>Spiegeladapter Set</b> mirror adapter set	ZB1001	37,82 €	45 €
	<b>Wandadapter 220 silber</b> wall adapter 220 silver	SM8805	26,89 €	32 €
	<b>Wandadapter 220 weiß</b> wall adapter 220 white	SM8806		
	<b>Wandadapter 220 schwarz</b> wall adapter 220 black	SM8807		
	<b>Wandadapter 220 poliert</b> wall adapter 220 polished	SM8808		
	<b>Wandabdeckung 220 silber</b> wall cover 220 silver	SM4054	37,82 €	45 €
	<b>Wandabdeckung 220 weiß</b> wall cover 220 white	SM4057		
	<b>Wandabdeckung 220 schwarz</b> wall cover 220 black	SM4060		
	<b>Wandabdeckung 220 poliert</b> wall cover 220 polished	SM4052		



# SML<sup>2</sup> Wall 300

Abbildung figure	Beschreibung description	Regelung control	Leistung power	CCT	EEK EEC	Lumen lumen	Art.-Nr. art.-no.	€ netto DE excl. VAT	€ brutto DE incl. VAT
●	<b>silber, satinée/satinée</b> silver, satinée/satinée	TRIAC	20 W	2700 K	D	2670 lm	SM1341	529,41 €	630 €
				3000 K	D	2730 lm	SM1243		
	DALI	20 W	2700 K	D	2670 lm	SM1601	554,62 €	660 €	
			3000 K	D	2730 lm	SM1602			
	<b>silber, satinée/Raster</b> silver, satinée/raster	TRIAC	20 W	2700 K	D	2670 lm	SM1342	529,41 €	630 €
				3000 K	D	2730 lm	SM1244		
DALI	20 W	2700 K	D	2670 lm	SM1603	554,62 €	660 €		
		3000 K	D	2730 lm	SM1604				
○	<b>weiß, satinée/satinée</b> white, satinée/satinée	TRIAC	20 W	2700 K	D	2670 lm	SM1343	529,41 €	630 €
				3000 K	D	2730 lm	SM1245		
	DALI	20 W	2700 K	D	2670 lm	SM1605	554,62 €	660 €	
			3000 K	D	2730 lm	SM1606			
	<b>weiß, satinée/Raster</b> white, satinée/raster	TRIAC	20 W	2700 K	D	2670 lm	SM1344	529,41 €	630 €
				3000 K	D	2730 lm	SM1246		
DALI	20 W	2700 K	D	2670 lm	SM1607	554,62 €	660 €		
		3000 K	D	2730 lm	SM1608				
●	<b>schwarz, satinée/satinée</b> black, satinée/satinée	TRIAC	20 W	2700 K	D	2670 lm	SM1345	529,41 €	630 €
				3000 K	D	2730 lm	SM1247		
	DALI	20 W	2700 K	D	2670 lm	SM1609	554,62 €	660 €	
			3000 K	D	2730 lm	SM1610			
	<b>schwarz, satinée/Raster</b> black, satinée/raster	TRIAC	20 W	2700 K	D	2670 lm	SM1346	529,41 €	630 €
				3000 K	D	2730 lm	SM1248		
DALI	20 W	2700 K	D	2670 lm	SM1611	554,62 €	660 €		
		3000 K	D	2730 lm	SM1612				
●	<b>poliert, satinée/satinée</b> polished, satinée/satinée	TRIAC	20 W	2700 K	D	2670 lm	SM1347	571,43 €	680 €
				3000 K	D	2730 lm	SM1249		
	DALI	20 W	2700 K	D	2670 lm	SM1613	596,64 €	710 €	
			3000 K	D	2730 lm	SM1614			
	<b>poliert, satinée/Raster</b> polished, satinée/raster	TRIAC	20 W	2700 K	D	2670 lm	SM1348	571,43 €	680 €
				3000 K	D	2730 lm	SM1250		
DALI	20 W	2700 K	D	2670 lm	SM1615	596,64 €	710 €		
		3000 K	D	2730 lm	SM1616				

IP20  
protection  
class

LED    
dimmable CRI >90

## Zubehör/Accessories

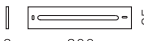
Abbildung figure	Beschreibung description	Art.-Nr. art.-no.	€ netto DE excl. VAT	€ brutto DE incl. VAT
	<b>Spiegeladapter Set</b> mirror adapter set	ZB1001	37,82 €	45 €
	<b>Wandadapter 300 silber</b> wall adapter 300 silver	SM8809	29,41 €	35 €
	<b>Wandadapter 300 weiß</b> wall adapter 300 white	SM8810		
	<b>Wandadapter 300 schwarz</b> wall adapter 300 black	SM8811		
	<b>Wandadapter 300 poliert</b> wall adapter 300 polished	SM8812		
	<b>Wandabdeckung 300 silber</b> wall cover 300 silver	SM4055	42,02 €	50 €
	<b>Wandabdeckung 300 weiß</b> wall cover 300 white	SM4058		
	<b>Wandabdeckung 300 schwarz</b> wall cover 300 black	SM4061		
	<b>Wandabdeckung 300 poliert</b> wall cover 300 polished	SM4048		

# SML<sup>2</sup> Wall

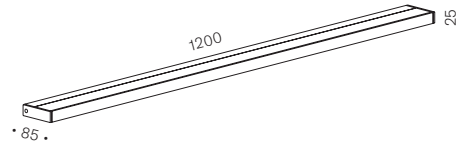
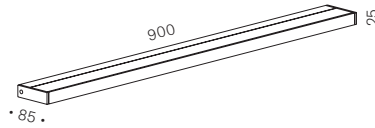
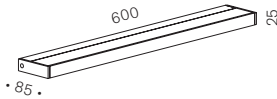

## SML<sup>2</sup> Wall 600

Abbildung figure	Beschreibung description	Regelung control	Leistung power	CCT	E EK EEC	Lumen lumen	Art.-Nr. art.-no.	€ netto DE excl. VAT	€ brutto DE incl. VAT		
●	<b>silber, satinée/satinée</b> silver, satinée/satinée	TRIAC	20 W	2700 K	D	2610 lm	SM1701	529,41 €	630 €		
				3000 K	D	2670 lm	SM1801				
				2700 K	D	2610 lm	SM1349				
		DALI	20 W	3000 K	D	2670 lm	SM1251				
				2700-5000 K tunable white	D	2820 lm	SM1501			571,43 €	680 €
				2700 K	D	2610 lm	SM1702			529,41 €	630 €
TRIAC	20 W	3000 K	D	2670 lm	SM1802						
		2700 K	D	2610 lm	SM1350						
		DALI	20 W	3000 K	D	2670 lm	SM1252				
2700-5000 K tunable white	D			2820 lm	SM1502	571,43 €	680 €				
○	<b>weiß, satinée/satinée</b> white, satinée/satinée			TRIAC	20 W	2700 K	D	2610 lm	SM1703		
		3000 K	D			2670 lm	SM1803				
		2700 K	D			2610 lm	SM1351				
		DALI	20 W	3000 K	D	2670 lm	SM1253				
				2700-5000 K tunable white	D	2820 lm	SM1503	571,43 €	680 €		
				●	<b>weiß, satinée/Raster</b> white, satinée/raster	TRIAC	20 W	2700 K	D	2610 lm	SM1704
3000 K	D	2670 lm	SM1804								
2700 K	D	2610 lm	SM1352								
DALI	20 W	3000 K	D			2670 lm	SM1254				
		2700-5000 K tunable white	D			2820 lm	SM1504	571,43 €	680 €		
		○	<b>schwarz, satinée/satinée</b> black, satinée/satinée			TRIAC	20 W	2700 K	D	2610 lm	SM1705
3000 K	D			2670 lm	SM1805						
2700 K	D			2610 lm	SM1353						
DALI	20 W			3000 K	D	2670 lm	SM1255				
				2700-5000 K tunable white	D	2820 lm	SM1505	571,43 €	680 €		
				●	<b>schwarz, satinée/Raster</b> black, satinée/raster	TRIAC	20 W	2700 K	D	2610 lm	SM1706
3000 K	D	2670 lm	SM1806								
2700 K	D	2610 lm	SM1354								
DALI	20 W	3000 K	D			2670 lm	SM1256				
		2700-5000 K tunable white	D			2820 lm	SM1506	571,43 €	680 €		
		○	<b>poliert, satinée/satinée</b> polished, satinée/satinée			TRIAC	20 W	2700 K	D	2610 lm	SM1707
3000 K	D			2670 lm	SM1807						
2700 K	D			2610 lm	SM1355						
DALI	20 W			3000 K	D	2670 lm	SM1257				
				2700-5000 K tunable white	D	2820 lm	SM1507	621,85 €	740 €		
				●	<b>poliert, satinée/Raster</b> polished, satinée/raster	TRIAC	20 W	2700 K	D	2610 lm	SM1708
3000 K	D	2670 lm	SM1808								
2700 K	D	2610 lm	SM1356								
DALI	20 W	3000 K	D			2670 lm	SM1258				
		2700-5000 K tunable white	D			2820 lm	SM1508	621,85 €	740 €		

IP30   
protection class through wiring

LED     
dimmable CRI > 90 tunable white

# SML<sup>2</sup> Wall 900

Abbildung figure	Beschreibung description	Regelung control	Leistung power	CCT	EEL EEC	Lumen lumen	Art.-Nr. art.-no.	€ netto DE excl. VAT	€ brutto DE incl. VAT		
●	<b>silber, satinée/satinée</b> silver, satinée/satinée	TRIAC	30 W	2700 K	D	3920 lm	SM1709	579,83 €	690 €		
				3000 K	D	4010 lm	SM1809				
				2700 K	D	3920 lm	SM1357				
		DALI	30 W	3000 K	D	4010 lm	SM1259				
				2700-5000 K tunable white	D	4180 lm	SM1511			647,06 €	770 €
				2700 K	D	3920 lm	SM1710			579,83 €	690 €
	TRIAC	30 W	3000 K	D	4010 lm	SM1810					
			2700 K	D	3920 lm	SM1358					
			DALI	30 W	3000 K	D	4010 lm	SM1260			
	2700-5000 K tunable white	D			4180 lm	SM1512	647,06 €	770 €			
	2700 K	D			3920 lm	SM1711	579,83 €	690 €			
	TRIAC	30 W	3000 K	D	4010 lm	SM1811					
2700 K			D	3920 lm	SM1359						
DALI			30 W	3000 K	D	4010 lm			SM1261		
	2700-5000 K tunable white	D		4180 lm	SM1513	647,06 €			770 €		
	2700 K	D		3920 lm	SM1712	579,83 €			690 €		
TRIAC	30 W	3000 K	D	4010 lm	SM1812						
		2700 K	D	3920 lm	SM1360						
		DALI	30 W	3000 K	D		4010 lm	SM1262			
2700-5000 K tunable white	D			4180 lm	SM1514		647,06 €	770 €			
2700 K	D			3920 lm	SM1713		579,83 €	690 €			
TRIAC	30 W	3000 K	D	4010 lm	SM1813						
		2700 K	D	3920 lm	SM1361						
		DALI	30 W	3000 K	D	4010 lm			SM1263		
2700-5000 K tunable white	D			4180 lm	SM1515	647,06 €			770 €		
2700 K	D			3920 lm	SM1714	579,83 €			690 €		
TRIAC	30 W	3000 K	D	4010 lm	SM1814						
		2700 K	D	3920 lm	SM1362						
		DALI	30 W	3000 K	D		4010 lm	SM1264			
2700-5000 K tunable white	D			4180 lm	SM1516		647,06 €	770 €			
2700 K	D			3920 lm	SM1715		621,85 €	740 €			
TRIAC	30 W	3000 K	D	4010 lm	SM1815						
		2700 K	D	3920 lm	SM1363						
		DALI	30 W	3000 K	D	4010 lm			SM1265		
2700-5000 K tunable white	D			4180 lm	SM1517	689,08 €			820 €		
2700 K	D			3920 lm	SM1716	621,85 €			740 €		
TRIAC	30 W	3000 K	D	4010 lm	SM1816						
		2700 K	D	3920 lm	SM1364						
		DALI	30 W	3000 K	D		4010 lm	SM1266			
2700-5000 K tunable white	D			4180 lm	SM1518		689,08 €	820 €			

IP30   
protection class through wiring

LED     
dimmable CRI >90 tunable white

## SML<sup>2</sup> Wall 1200

Abbildung figure	Beschreibung description	Regelung control	Leistung power	CCT	EK EEC	Lumen lumen	Art.-Nr. art.-no.	€ netto DE excl. VAT	€ brutto DE incl. VAT		
●	silber, satinée/satinée silver, satinée/satinée	TRIAC	40 W	2700 K	D	5230 lm	SM1717	663,87 €	790 €		
				3000 K	D	5350 lm	SM1817				
				2700 K	D	5230 lm	SM1365				
		DALI	40 W	3000 K	D	5350 lm	SM1267				
				2700-5000 K tunable white	D	5480 lm	SM1521			764,71 €	910 €
				2700 K	D	5230 lm	SM1718			663,87 €	790 €
TRIAC	40 W	3000 K	D	5350 lm	SM1818						
		2700 K	D	5230 lm	SM1366						
		DALI	40 W	3000 K	D	5350 lm	SM1268				
2700-5000 K tunable white	D			5480 lm	SM1522	764,71 €	910 €				
○	weiß, satinée/satinée white, satinée/satinée			TRIAC	40 W	2700 K	D	5230 lm	SM1719		
		3000 K	D			5350 lm	SM1819				
		2700 K	D			5230 lm	SM1367				
		DALI	40 W	3000 K	D	5350 lm	SM1269				
				2700-5000 K tunable white	D	5480 lm	SM1523	764,71 €	910 €		
				TRIAC	40 W	2700 K	D	5230 lm	SM1720	663,87 €	790 €
3000 K	D	5350 lm	SM1820								
2700 K	D	5230 lm	SM1368								
DALI	40 W	3000 K	D	5350 lm	SM1270						
		2700-5000 K tunable white	D	5480 lm	SM1524	764,71 €	910 €				
		●	schwarz, satinée/satinée black, satinée/satinée	TRIAC	40 W	2700 K	D	5230 lm	SM1721		
3000 K	D					5350 lm	SM1821				
2700 K	D					5230 lm	SM1369				
DALI	40 W			3000 K	D	5350 lm	SM1271				
				2700-5000 K tunable white	D	5480 lm	SM1525	764,71 €	910 €		
				TRIAC	40 W	2700 K	D	5230 lm	SM1722	663,87 €	790 €
3000 K	D	5350 lm	SM1822								
2700 K	D	5230 lm	SM1370								
DALI	40 W	3000 K	D	5350 lm	SM1272						
		2700-5000 K tunable white	D	5480 lm	SM1526	764,71 €	910 €				
		○	poliert, satinée/satinée polished, satinée/satinée	TRIAC	40 W	2700 K	D	5230 lm	SM1723		
3000 K	D					5350 lm	SM1823				
2700 K	D					5230 lm	SM1371				
DALI	40 W			3000 K	D	5350 lm	SM1273				
				2700-5000 K tunable white	D	5480 lm	SM1527	806,72 €	960 €		
				TRIAC	40 W	2700 K	D	5230 lm	SM1724	705,88 €	840 €
3000 K	D	5350 lm	SM1824								
2700 K	D	5230 lm	SM1372								
DALI	40 W	3000 K	D	5350 lm	SM1274						
		2700-5000 K tunable white	D	5480 lm	SM1528	806,72 €	960 €				

IP30 → □ →  
protection class through wiring

LED     
dimmable CRI >90 tunable white

## Zubehör/Accessories

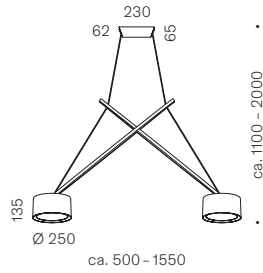

Abbildung figure	Beschreibung description	Art.-Nr. art.-no.	€ netto DE excl. VAT	€ brutto DE incl. VAT
	<b>Spiegeladapter Set</b> mirror adapter set	ZB1001	37,82 €	45 €



## TWIN

Abbildung figure	Beschreibung description	Leuchtmittel lamp	Regelung control	Leistung power	CCT	EEL EEC	Lumen lumen	Art.-Nr. art.-no.	€ netto DE excl. VAT	€ brutto DE incl. VAT
●	<b>schwarz, Acrylglas opal</b> black, acrylic glass opal	LED	TRIAC	23 W	2700 K	F	2240 lm	TW1103	1.260,50 €	1.500 €
					3000 K	E	2360 lm	TW1107		
		2 x G9	TRIAC	max. 120 W	2800 K	G	1960 lm	TW1003	936,97 €	1.115 €
●	<b>schwarz, Glas opal</b> black, glass opal	LED	TRIAC	23 W	2700 K	F	2240 lm	TW1303	1.478,99 €	1.760 €
					3000 K	E	2360 lm	TW1307		
		2 x G9	TRIAC	max. 120 W	2800 K	G	1960 lm	TW1203	1.130,25 €	1.345 €
●	<b>glanzverchromt, Acrylglas opal</b> chrome-plated, acrylic glass opal	LED	TRIAC	23 W	2700 K	F	2240 lm	TW1101	1.357,14 €	1.615 €
					3000 K	E	2360 lm	TW1105		
		2 x G9	TRIAC	max. 120 W	2800 K	G	1960 lm	TW1001	1.033,61 €	1.230 €
●	<b>glanzverchromt, Glas opal</b> chrome-plated, glass opal	LED	TRIAC	23 W	2700 K	F	2240 lm	TW1301	1.567,23 €	1.865 €
					3000 K	E	2360 lm	TW1305		
		2 x G9	TRIAC	max. 120 W	2800 K	G	1960 lm	TW1201	1.218,49 €	1.450 €

IP20  
protection  
class

 dimmable
  CRI >90
  SDCM 3

# ZOOM

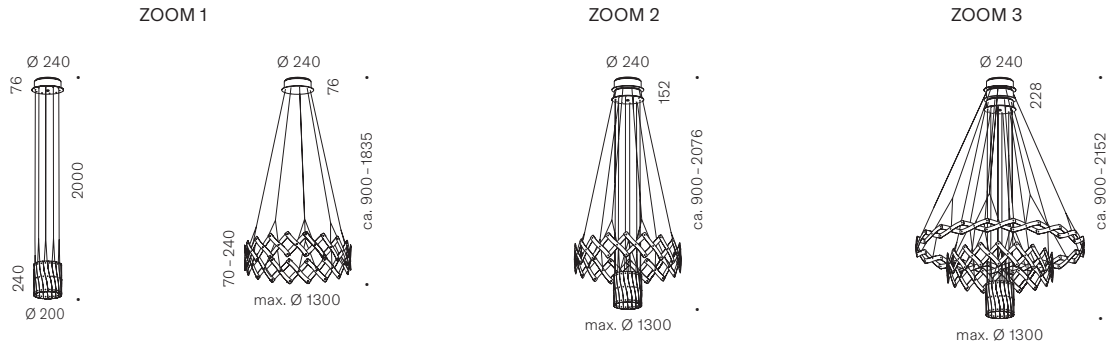

## ZOOM new

Abbildung figure	Beschreibung description	Leuchtmittel lamp	Regelung control	Leistung power	CCT	EEL EEC	Lumen lumen	Art.-Nr. art.-no.	€ netto DE excl. VAT	€ brutto DE incl. VAT	
●	1 gebürstet 1 brushed	LED	TRIAC	35 W	2700 K	F	2700lm	ZO3001	1.252,10 €	1.490 €	
			DALI	35 W	2700 K	F	2700lm	ZO3011	1.336,13 €	1.590 €	
			CASAMBI <span style="color: #0070C0;">new</span>	35 W	2700 K	F	2700lm	ZO3001C	1.411,76 €	1.680 €	
	2 gebürstet 2 brushed	LED	20 × G4	TRIAC	max. 200 W	2700 K	G	2600lm	ZO1001	882,35 €	1.050 €
				DALI	70 W	2700 K	F	5400lm	ZO3002	2.436,97 €	2.900 €
				CASAMBI <span style="color: #0070C0;">new</span>	70 W	2700 K	F	5400lm	ZO3002C	2.756,30 €	3.280 €
3 gebürstet 3 brushed	LED	40 × G4	TRIAC	max. 400 W	2700 K	G	5200lm	ZO1003	1.680,67 €	2.000 €	
			DALI	105 W	2700 K	F	8100lm	ZO3003	3.613,45 €	4.300 €	
			CASAMBI <span style="color: #0070C0;">new</span>	105 W	2700 K	F	8100lm	ZO3003C	4.092,44 €	4.870 €	
		60 × G4	TRIAC	max. 600 W	2700 K	G	7800lm	ZO1006	2.436,97 €	2.900 €	

IP20  
protection  
class

↑  
+ length  
option

individual

dimming

CRI >90

SDCM 3

## Zubehör/Accessories

Abbildung figure	Beschreibung description	Art.-Nr. art.-no.	€ netto DE excl. VAT	€ brutto DE incl. VAT
	<b>ZOOM Kristallglas Set (20 Stk.)</b> ZOOM Kristallglas Set (20 pcs.)	ZO1014	163,87 €	195 €

# ZOOM XL

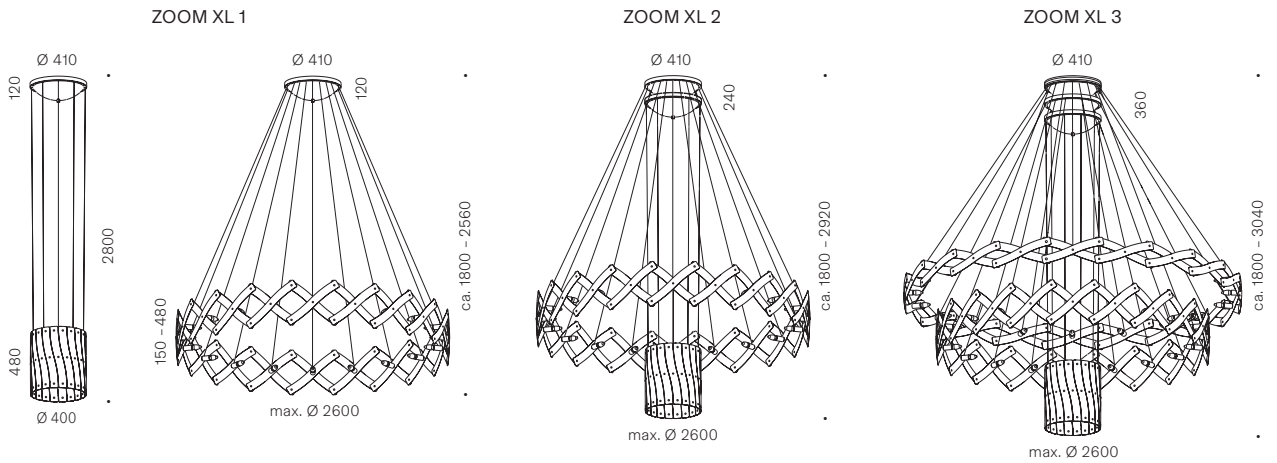

## ZOOM XL

Abbildung figure	Beschreibung description	Fassung socket	Regelung control	Leistung power	EEK EEC	Art.-Nr. art.-no.	€ netto DE excl. VAT	€ brutto DE incl. VAT
●	<b>1 gebürstet</b> 1 brushed	20 × E14	TRIAC	max. 560 W	G	ZO1002	2.605,04 €	3.100 €
	<b>2 gebürstet</b> 2 brushed	40 × E14	TRIAC	max. 1120 W	G	ZO1004	5.126,05 €	6.100 €
	<b>3 gebürstet</b> 3 brushed	60 × E14	TRIAC	max. 1680 W	G	ZO1005	7.647,06 €	9.100 €

IP20  
protection  
class

↑  
+ length  
option

individual

dimmable

## Zubehör/Accessories

Abbildung figure	Beschreibung description	Art.-Nr. art.-no.	€ netto DE excl. VAT	€ brutto DE incl. VAT
	<b>ZOOM XL Kristallglas Set (20 Stk.)</b> ZOOM XL Kristallglas Set (20 pcs.)	ZO1015	331,93 €	395 €

# Information



**Ein modularer Artikel ist eine Leuchte, die aus funktional getrennten Einzelkomponenten besteht und erst durch deren Kombination eine vollständige Leuchte bildet. Typische Bestandteile sind beispielsweise eine Lichteinheit (LED-Modul inkl. Vorschaltgerät) und ein optisches Element wie ein Glasschirm oder eine Abdeckung. Dieses modulare System ermöglicht eine flexible Konfiguration entsprechend technischer Anforderungen an Lichtverteilung oder Designvorgaben.**

A modular article is a luminaire that consists of functionally separate individual components and only forms a complete luminaire when they are combined. Typical components are, for example, a lighting unit (LED module incl. driver) and an optical element such as a glass shade or cover. This modular system enables flexible configuration according to technical requirements for light distribution or design specifications.



**Mit serien Individual haben Kunden die Möglichkeit, ihre Leuchten über das Standardsortiment hinaus in Farbe und Material individuell zu gestalten. Sonderausführungen mit anderen Lichtleistungen, Farbwiedergabeindizes, Oberflächen, Kabel- und Rohrlängen auf Anfrage. Für maßgeschneiderte Lösungen steht Ihnen unser Kundenservice gerne zur Verfügung.**

With serien Individual, customers have the option of customising the colour and material of their luminaires beyond the standard range.

Special versions with other light outputs, colour rendering indices, surfaces, cable and tube lengths on request. Our customer service team will be happy to help you with customised solutions.



**Unsere Produkte sind so konstruiert, dass beim Austausch von Lichtquellen nur eine qualifizierte Fachkraft sicherstellen kann, dass diese nicht verunreinigt und/oder beschädigt werden. Die Lebensdauer der Lichtquellen wird durch die Montageart mit Wärmeleitpads unmittelbar beeinflusst. Daher wird der nicht fachmännische Austausch von Lichtquellen und separaten Betriebsgeräten als nicht sinnvoll angesehen.**

Our products are designed in such a way that when light sources are replaced, only a qualified specialist can ensure that they are not contaminated and/or damaged. The service life of the light sources is directly affected by the mounting method with heat conducting pads. Therefore, the non-professional replacement of light sources and separate control gear is not considered appropriate.



**Eine Excel-Datei mit Artikelnummern und aktuellen Preisen stellen wir unseren Handelspartnern gerne zur Verfügung unter:**

**[www.serien.com/downloads](http://www.serien.com/downloads)**

We are happy to make the Excel file with article numbers and current prices available to our trade partners:

[www.serien.com/downloads](http://www.serien.com/downloads)



**Unter [www.serien.com/downloads](http://www.serien.com/downloads) finden Sie hilfreiche Informationen und die jeweils aktuellen technischen Daten:**













**Datenblätter, Kataloge, Preislisten, Lichttechnische Daten (EULUMDAT), 3D CAD-Daten, Konformitätserklärungen,**

**Retourenformular, FAQs, Montageanleitungen, Bohrschablonen und weitere Serviceanleitungen**







At [www.serien.com/downloads](http://www.serien.com/downloads) you will find helpful information and the latest technical data:

Data sheets, catalogues, price lists, lighting data (EULUMDAT), 3D CAD data, declarations of conformity, returns form, FAQs, assembly instructions, drilling templates and other service instructions.

# Luminaire features

 <p>IP20 protection class</p>	<p><b>Die Schutzart IP (International Protection Code) gibt an, wie gut ein elektrisches Gerät gegen das Eindringen von Fremdkörpern (z. B. Staub) und Wasser geschützt ist. Die Schutzart wird in der Norm DIN EN 60529 (VDE 0470-1) definiert.</b></p> <p>The IP (International Protection Code) rating indicates how well an electrical device is protected against the ingress of foreign bodies (e.g. dust) and water. The degree of protection is defined in the standard DIN EN 60529 (VDE 0470-1).</p>
 <p>glass lens</p>	<p><b>Die Abdeckung der LED erfolgt über eine hochwertige optische Echtglas-Sammellinse. Sie sorgt für eine präzise Lichtbündelung, minimiert Streuverluste und gewährleistet eine gleichmäßige Lichtverteilung bei gleichzeitig hoher Lichtausbeute. Durch die Verwendung von Echtglas bietet die Linse exzellente thermische und optische Eigenschaften sowie eine dauerhaft hohe Transparenz.</b></p> <p>The LED is covered by a high quality optical glass converging lens. It ensures precise light bundling, minimises scattering losses and guarantees uniform light distribution with high luminous efficacy. Thanks to the use of real glass, the lens offers excellent thermal and optical properties as well as permanently high transparency.</p>
 <p>chemically hardened</p>	<p><b>Chemisch gehärtetes Glas zeichnet sich durch eine hohe mechanische Festigkeit und Oberflächenhärte aus. Ein Ionenaustauschverfahren bewirkt eine deutlich erhöhte Beständigkeit gegen mechanische Beanspruchung, Temperaturschocks und Abrasion. Die veredelte Oberfläche sorgt zudem für eine optisch homogene Struktur mit hoher Lichttransmission und einem klaren, brillanten Erscheinungsbild.</b></p> <p>Chemically tempered glass is characterised by high mechanical strength and surface hardness. An ion exchange process significantly increases resistance to mechanical stress, temperature shocks and abrasion. The refined surface also ensures an optically homogeneous structure with high light transmission and a clear, brilliant appearance.</p>
 <p>cut 80 mm</p>	<p><b>Durchmesser des benötigten Deckenausschnitts für die Montage von Einbauleuchten in Hohldecken.</b></p> <p>Diameter of the cut-out required for the installation of recessed luminaires in hollow ceilings.</p>
 <p>tube cuttable</p>	<p><b>Das Pendelrohr der Leuchte ist in der Länge anpassbar und kann bei Bedarf durch den Kunden mit einer handelsüblichen Metallsäge individuell gekürzt werden. So lässt sich die Abpendelhöhe flexibel auf die jeweilige Einbausituation abstimmen.</b></p> <p>The pendant tube of the luminaire is adjustable in length and can be individually shortened by the customer using a standard metal saw if required. This allows the pendant height to be flexibly adapted to the respective installation situation.</p>
 <p>+ length option</p>	<p><b>Optional sind Abhängungen in Überlänge erhältlich. Für individuelle Anforderungen wenden Sie sich bitte an unseren Kundenservice.</b></p> <p>Extra-long suspensions are available as an option. For customised requirements, please contact our customer service.</p>
 <p>through wiring</p>	<p><b>Die Leuchten sind für eine Durchverdrahtung vorgesehen. Dadurch können mehrere Leuchten in Reihe geschaltet werden, ohne zusätzlichen Installationsaufwand. Dies gewährleistet eine schnelle, normgerechte und übersichtliche Elektroinstallation.</b></p> <p>The luminaires are designed for through-wiring. This means that several luminaires can be connected in a loop-through configuration without additional installation work. This ensures a quick, standardised and clear electrical installation.</p>
 <p>sensor option</p>	<p><b>Optional können die Leuchten mit intelligenten Sensoren ausgestattet werden, die Umgebungshelligkeit und/oder Anwesenheit von Personen erfassen. Dadurch wird die Beleuchtung bedarfsgerecht gesteuert, Energie eingespart und gleichzeitig der Komfort für die Nutzer erhöht.</b></p> <p>As an option, the luminaires can be equipped with intelligent sensors that detect the ambient brightness and/or the presence of people. This allows the lighting to be controlled as required, saving energy and increasing user comfort at the same time.</p>
 <p>battery option</p>	<p><b>Die Leuchten können optional mit einem integrierten Akku ausgestattet werden, um den Betrieb in Notbeleuchtungsanlagen sicherzustellen. Im Falle eines Netzausfalls schaltet die Leuchte automatisch in den Notbetrieb um und gewährleistet eine zuverlässige Grundbeleuchtung für die Dauer der vorgeschriebenen Überbrückungszeit.</b></p> <p>The luminaires can optionally be equipped with an integrated rechargeable battery to ensure operation in emergency lighting systems. In the event of a power failure, the luminaire automatically switches to emergency mode and ensures reliable basic lighting for the duration of the prescribed bridging time.</p>
 <p>emergency light option</p>	<p><b>Die DALI-Betriebsgeräte sind optional für den Einsatz in Notbeleuchtungsumgebungen geeignet und können problemlos in entsprechende Systeme eingebunden werden.</b></p> <p>The DALI control gear is optionally suitable for use in emergency lighting environments and can be easily integrated into corresponding systems.</p>
 <p>driver included</p>	<p><b>Alle Einbauleuchten sind standardmäßig mit einem passenden Betriebsgerät ausgestattet. Es entstehen keine zusätzlichen Kosten für externe Vorschaltgeräte, und die Leuchten können sofort nach der Installation in Betrieb genommen werden.</b></p> <p>All recessed luminaires are equipped with a suitable control gear as standard. There are no additional costs for external ballasts and the luminaires can be put into operation immediately after installation.</p>
 <p>lamp included</p>	<p><b>Die Leuchten werden werksseitig mit passendem Leuchtmittel geliefert und sind somit sofort betriebsbereit.</b></p> <p>The luminaires are supplied from the factory with a suitable light source and are therefore ready for immediate use.</p>

# Lighting technology

UGR <19	<p><b>Der UGR-Wert (Unified Glare Rating) gibt die Blendwirkung von Leuchten an. Je niedriger der Wert, desto geringer die psychologische Blendung. Für Bildschirmarbeitsplätze wird ein UGR ≤ 19 empfohlen. Unsere Leuchten sind so konzipiert, dass sie je nach Ausführung definierte UGR-Grenzwerte einhalten und hohen Sehkomfort bieten.</b></p> <p>The UGR value (Unified Glare Rating) indicates the glare effect of luminaires. The lower the value, the lower the psychological glare. A UGR ≤ 19 is recommended for VDU workstations. Our luminaires are designed to comply with defined UGR limit values and offer a high level of visual comfort, depending on the version.</p>
 dimmable	<p><b>Diese Leuchten sind dimmbar und erlauben eine flexible Anpassung der Lichtintensität. Je nach Modell werden unterschiedliche Dimmtechnologien unterstützt: Phasenabschnitt (TRIAC), DALI oder CASAMBI (Bluetooth). Für detaillierte Kompatibilitäts- und Steuerungs-Informationen wenden Sie sich bitte an unseren Kundenservice.</b></p> <p>These luminaires are dimmable and allow flexible adjustment of the light intensity. Depending on the model, different dimming technologies are supported: Trailing edge (TRIAC), DALI or CASAMBI (Bluetooth). For detailed compatibility and control information, please contact our customer service.</p>
 Zhaga standard	<p><b>Der Zhaga-Standard definiert herstellerübergreifende Schnittstellen für LED-Module, Treiber, Sensoren und Konnektoren. Er gewährleistet Interoperabilität, unterstützt modulare, zukunftssichere Leuchtendesigns und erleichtert Wartung sowie Austausch zur Steigerung der Systemlebensdauer und Nachhaltigkeit.</b></p> <p>The Zhaga standard defines manufacturer-independent interfaces for LED modules, drivers, sensors and connectors. It ensures interoperability, supports modular, future-proof luminaire designs and facilitates maintenance and replacement to increase system service life and sustainability.</p>
 tunable white	<p><b>Leuchten mit der Tunable White Funktionalität besitzen eine variable Farbtemperatursteuerung von warm- bis kaltweißem Licht.</b></p> <p>Luminaires with the tunable-white functionality have variable colour temperature control from warm to cool white light.</p>
 dim2warm	<p><b>Mit Dim2Warm wird eine Funktionalität der Leuchte bezeichnet, mit der das als angenehm empfundene Dimmverhalten von klassischen Glühfadenlampen imitiert wird. Beim Dimmen wird das Licht nicht nur dunkler, sondern ändert seine Lichtfarbe auch in den warmweißen Bereich.</b></p> <p>Dim2Warm refers to a luminaire functionality that imitates the pleasant dimming behavior of classic incandescent lamps. When dimmed, the light not only becomes darker, but also changes its colour to warm white tone.</p>
 CRI >97	<p><b>Der Farbwiedergabeindex wird zur Beurteilung der Qualität der Farbwiedergabe einer Lichtquelle herangezogen.</b></p> <p>The colour rendering index is used to assess the quality of the colour rendering of a light source.</p>
 SDCM 2	<p><b>Der SDCM-Wert (Standard Deviation of Color Matching) beschreibt die Farbkonsistenz von LEDs. Je niedriger der Wert, desto gleichmäßiger erscheint das Licht mehrerer Leuchten derselben Serie. Ein SDCM ≤ 3 steht für eine sehr hohe Farbtreue ohne sichtbare Farbunterschiede – ideal für anspruchsvolle Anwendungen mit hohem ästhetischem Anspruch.</b></p> <p>The SDCM value (Standard Deviation of Color Matching) describes the colour consistency of LEDs. The lower the value, the more uniform the light of several luminaires in the same series appears. An SDCM ≤ 3 stands for very high colour fidelity without visible colour differences - ideal for demanding applications with high aesthetic requirements.</p>
TRIAC	<p><b>Diese Leuchten sind mit einem handelsüblichen Phasenabschnittsdimmer regelbar – sie können sowohl ein- und ausgeschaltet als auch in der Helligkeit stufenlos geregelt werden. Dafür ist eine 3-adrige Standard-Netzzuleitung ausreichend.</b></p> <p>Luminaires with this feature can be controlled with a standard phase cut dimmer – it can be switched on and off and continuously dimmed. A 3-wire standard mains cable is sufficient.</p>
DALI	<p><b>5-adrige Netzzuleitung bei Regelung über DALI oder 0/1–10 V erforderlich.</b></p> <p>5-core mains cable required for control via DALI or 0/1-10 V.</p>
CASAMBI	<p><b>Die Leuchten können optional mit einem CASAMBI-Modul ausgestattet werden und lassen sich dadurch komfortabel per Smartphone, Tablet oder Wandschalter über Bluetooth steuern. CASAMBI ermöglicht eine smarte und kabellose Lichtsteuerung ohne zusätzliche Steuerleitungen oder aufwendige Installation. Weiterführende Informationen unter <a href="http://www.casambi.com">www.casambi.com</a>.</b></p> <p>The luminaires can be optionally equipped with a CASAMBI module and can therefore be conveniently controlled via smartphone, tablet or wall switch using Bluetooth. CASAMBI enables smart and wireless lighting control without additional control cables or complex installation. Further information can be found at <a href="http://www.casambi.com">www.casambi.com</a>.</p>
CCT	<p><b>LED-Leuchten mit einer Farbtemperatur von 2700 K liefern wir kurzfristig.</b></p> <p><b>LED-Leuchten mit einer Farbtemperatur von 3000 K und höher haben in der Regel längere Lieferzeiten.</b></p> <p>We supply LED luminaires with a colour temperature of 2700 K at short notice. LED luminaires with a color temperature of 3000 K and higher usually have longer delivery times.</p>
Lumen	<p><b>Die Angaben zu Lichtstrom (Lumen) sind Nominalwerte, das heißt reine Modul-Lichtstromwerte. Der Lichtstrom gibt an, wie viel Licht nach allen Seiten abstrahlt.</b></p> <p>The luminous flux (lumen) specifications are nominal values, i.e. pure module luminous flux values. The luminous flux indicates how much light is emitted in all directions.</p>

# Service

**Bei Fragen zu unseren Produkten, deren Lieferbedingungen und Verfügbarkeiten kontaktieren Sie bitte unser Serviceteam.**

For questions about our products, their delivery conditions and availabilities, please contact our customer service any time.

+49 6106 6909 0  
serien@serien.com  
www.serien.com

## Business Contacts

### Deutschland N/O

---

Dzenan Ganibegovic  
PLZ 0, 1 - 39, 48 - 49, 57 - 65, 99

serien Raumleuchten GmbH  
Hainhäuser Straße 3-7  
63110 Rodgau  
Germany

E dzenan.ganibegovic@serien.com  
M +49 151 5122 1212  
T +49 6106 6909 248

---

### Deutschland S/W

---

Helmuth Grischy  
PLZ 40 - 47, 50 - 56, 66 - 98

serien Raumleuchten GmbH  
Hainhäuser Straße 3-7  
63110 Rodgau  
Germany

E helmuth.grischy@serien.com  
M +49 151 5092 8656  
T +49 6106 6909 252

---

### Switzerland

---

wirzpartner GmbH  
für Leuchten und Licht

Im oberen Boden 142  
8049 Zürich  
Schweiz

E info@wirzpartner.ch  
M +41 79 290 30 08  
T +41 55 260 19 60

---

### Austria

---

Peter Salat

serien Raumleuchten GmbH  
Hainhäuser Straße 3-7  
63110 Rodgau  
Germany

E peter.salat@serien.com  
M +49 179 496 57 43  
T +49 6106 6909 232

---

### Brazil

---

FAS iluminação

Alameda Gabriel Monteiro da Silva,  
n° 413 Jardim America  
00.817.414/0001-08 - São Paulo  
Brazil

E atendimento@fasiluminacao.com.br  
T +55 11 30861661  
M +55 11 94713-9743

---

### Italy

---

Farelaluce  
Ulrich Jetzt

Hainhäuser Straße 3-7  
63110 Rodgau  
Germany

E ulrich@farelaluca.it  
T +39 353 4804731

---

### Netherlands

---

Trampoluce  
Paul van der Vegt

E info@trampoluce.nl  
M +31 620 601 661  
T +31 24 37 30 628

---

### Portugal

---

In-One  
Manuela Peres

EN 125  
8100-O68 Benfarras/Boliqueime  
Portugal

E manuelaperes@in-one.pt  
T +35 1938460199

---

### Worldwide

---

We are distributing worldwide.

Please contact our customer service for more information:

E serien@serien.com  
T +49 6106 6909 0

---

## ANNEX

2013	German Design Award, Nominierung
2012	Design Plus
2011	Internationaler Designpreis Baden-Württemberg, Focus Silber

## APP

2017	German Design Award, Special Mention
2016	Design Plus
2016	Iconic Award, Interior Innovation, Winner

## CAVITY

2019	German Design Award, Winner
2019	Nominierung Leuchte des Jahres

## CURLING

2020	Innovationspreis Architektur+Technik
2018	German Design Award, Winner
2016	Internationaler Designpreis Baden-Württemberg, Focus Silber
2016	Iconic Award, Interior Innovation, Best of Best

## CRIB

2019	German Design Award, Winner
------	-----------------------------

## ELANE

2012	Deutscher Designer Club, Gute Gestaltung, Bronze
------	--

## JOB

2011	Designpreis der Bundesrepublik Deutschland, Nominierung
2010	Deutscher Designer Club, Gute Gestaltung, Silber
2009	The Israel Museum, Collection

## JONES

1999	Red Dot Design Award
------	----------------------

## LID

2018	Iconic Award, Innovative Interior, Best of Best
------	---

## ONE EIGHTY

2011	Designpreis der Bundesrepublik Deutschland, Nominierung
2010	Red Dot Design Award, Winner

## PROPELLER

2009	Designpreis der Bundesrepublik Deutschland, Nominierung
2009	The Israel Museum, Collection
2008	Red Dot Design Award, Winner

## REEF

2006	Designpreis der Bundesrepublik Deutschland, Nominierung
2004	Red Dot Design Award, Winner
2004	Design Plus
2004	Designpreis der Bundesrepublik Deutschland, Nominierung
2003	Internationaler Designpreis Baden-Württemberg, Focus Silber

## ROD

2019	Iconic Award, Innovative Interior, Best of Best
------	---

## REFLEX<sup>2</sup>

2024	Internationaler Designpreis Baden-Württemberg, Gold
2022	Internationaler Designpreis Baden-Württemberg, Special Mention
2022	German Design Award, Winner (Floor)
2022	Iconic Award, Innovative Interior, Best of Best
2021	Stylepark Selected
2021	Internationaler Designpreis Baden-Württemberg, Special Mention
2020	Design Plus
2020	German Design Award, Winner (Ceiling)

## SEVENTY SEVEN

1991	iF Product Award
1991	Stedelijk Museum Amsterdam, Collection

## SLANT

2013	German Design Award, Nominierung
2012	Deutscher Designer Club, Gute Gestaltung, Silber

## SLICE

2015	German Design Award, Nominierung
------	----------------------------------

## SLICE<sup>2</sup> PI

2023	Internationaler Designpreis Baden-Württemberg, Focus Gold
------	---

## SML

2006	Designpreis der Bundesrepublik Deutschland, Nominierung
2004	Red Dot Design Award, Winner
2004	Designpreis der Bundesrepublik Deutschland
2003	Internationaler Designpreis Baden-Württemberg, Focus Silber

## SML<sup>2</sup>

2014	German Design Award, Nominierung
2013	Designpreis der Bundesrepublik Deutschland, Nominierung
2013	Red Dot Design Award, Winner

## SML T5

2004	Design Plus
2004	Designpreis der Bundesrepublik Deutschland
2004	iF Product Award, Winner
2003	Internationaler Designpreis Baden-Württemberg, Focus Silber

## TWIN

2015	German Design Award, Gold
2014	Design Plus

## ZOOM

2007	Designpreis der Bundesrepublik Deutschland, Nominierung
2004	Designpreis der Bundesrepublik Deutschland, Nominierung
2003	Red Dot Design Award, Winner
2003	Internationaler Designpreis Baden-Württemberg, Focus Gold

© 2026 serien Raumluchten GmbH

**Alle Rechte vorbehalten. Jede Verwertung außerhalb der Grenzen des Urheberrechtsgesetzes ist ohne Zustimmung des Herausgebers unzulässig. Keine Reproduktionen ohne vorherige schriftliche Zustimmung. Alle Marken sind registriert. Alle Produkte sind gesetzlich geschützt. Verstöße werden in vollem Umfang strafrechtlich verfolgt. Änderungen vorbehalten.**  
All rights reserved. Any use outside the limits of copyright law without the publisher's consent is prohibited. No reproduction may be made without prior written consent. All trademarks are registered. All products are protected by law. Violations will be prosecuted to the full extent of the law. Subject to change without notice.

serien Raumluchten GmbH | Hainhäuser Straße 3-7 | 63110 Rodgau | Germany | [www.serien.com](http://www.serien.com) | [serien@serien.com](mailto:serien@serien.com)

