

Tom Dixon.

Lookbook

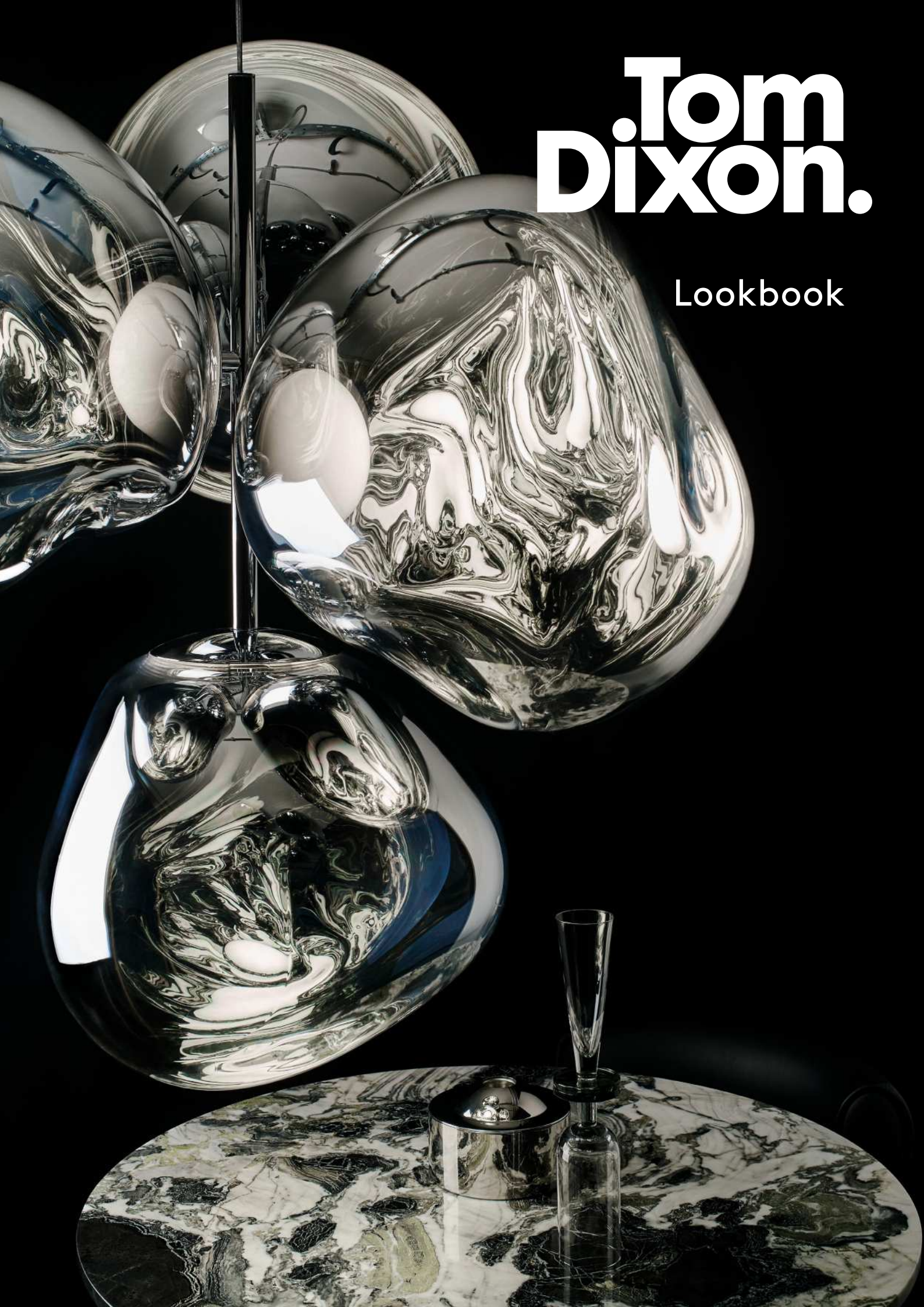

INTRO

Established in 2002, Tom Dixon is a British luxury design brand which is represented in 90 countries. Specialising in furniture, lighting and accessories, Tom Dixon has hubs in London, Milan, Hong Kong, New York, Tokyo, Hangzhou, Beijing and Shanghai. With an aesthetic that is intrinsically inspired by the brand's British roots, the products are internationally recognised and appreciated for their pioneering use of materials and techniques.

Founder and eponymous Creative Director Tom Dixon is a restless innovator who rose to prominence in the mid-1980s as a maverick, untrained designer with a line in welded salvage furniture.

While working with the Italian giant Cappellini he designed the widely acclaimed 'S' Chair. In the late 90s Tom became Creative Director at Habitat and rejuvenated the brand while maintaining Terence Conran's vision of enriching everyday life through simple, modern design.

In 2001, Tom was awarded an OBE by Her Majesty the Queen for his services to British design. In 2014 he was awarded 'Designer of The Year' at Maison & Objet, Paris. In 2019, he received a silver medal for Best Garden at the RHS Chelsea Flower Show and in the same year, was awarded the prestigious London Design Medal at the British Land Celebration of Design Awards.

Tom is one of the industry's most feted British designers and is internationally heralded as a significantly original talent.

Best-selling products such as Beat, Melt, S-Chair and Wingback are instantly recognisable and have been acquired by the world's most famous museums including the Victoria & Albert Museum, London; MOMA, New York; and the Centre Pompidou, Paris.



Tom Dixon HQ, The Coal Office London



LIGHTING

LED

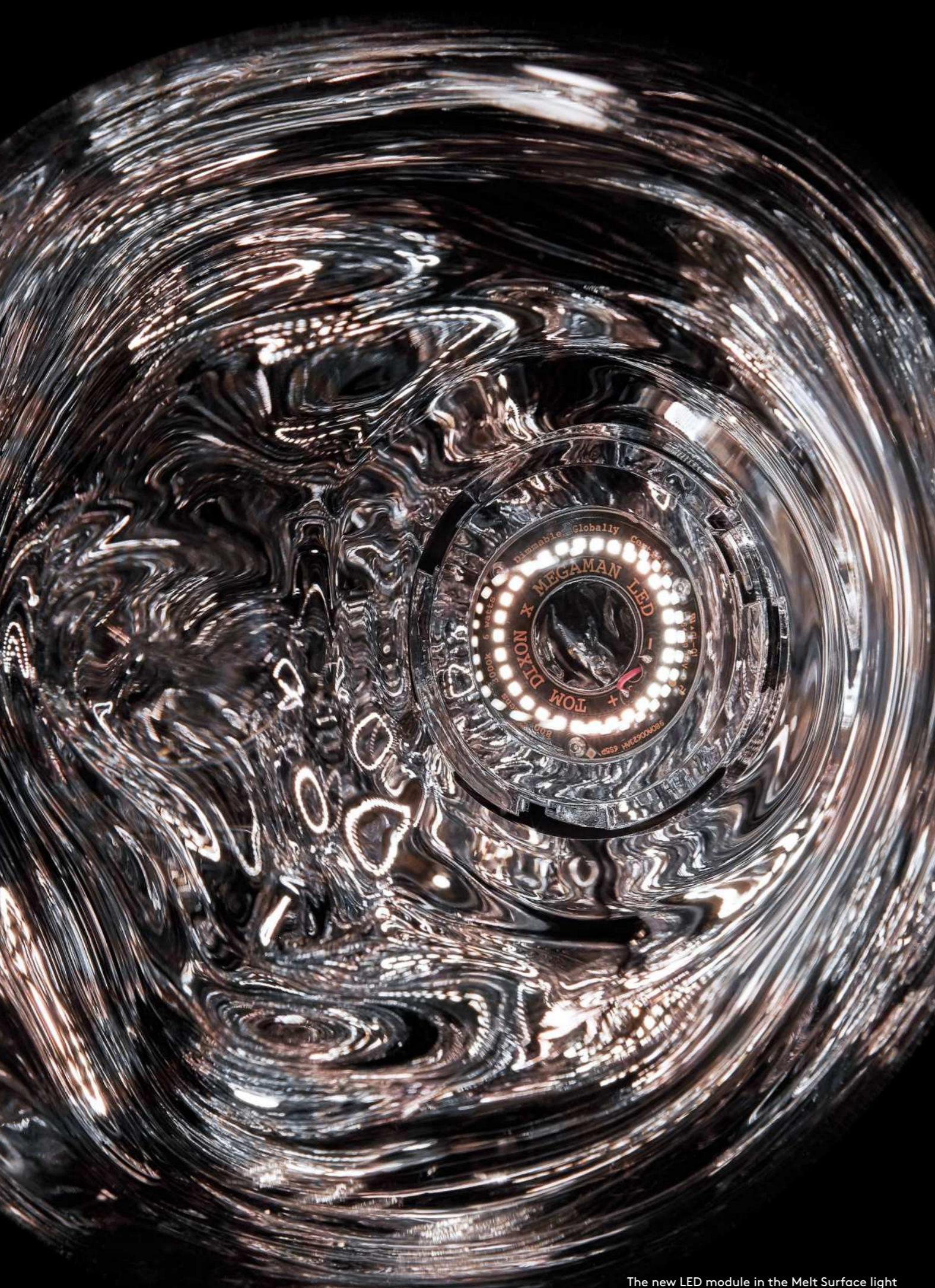

The new LED module in the Melt Surface light



Beat incandescent vs. Beat LED output

It has taken one hundred years for electro luminescence to become THE revolution that has reshaped the lighting world.

Ten years ago, LED lighting was seen as ugly, expensive and unsophisticated. Yet through government legislation, technological innovation, mass-production and the designing of new and inventive lighting objects, we have seen a sustainable revolution in luminosity.

For any designer, when technology progresses, new possibilities appear and we have embraced the LED on many levels. It allows us to design new shapes, to illuminate in a different way than was previously imaginable, and just as importantly, to make lights that use 80% less electricity.

When it comes to sustainability there is still a lot of work that needs to be done but one story

that is worth telling is LED. Although the underpinning technology has been around for almost a hundred years - it was in 1962 that the present format was patented - it has taken another 50 years for the price and quality of light to become acceptable to the consumer.

Recognising the demand and need for a more energy efficient future, in 2019, we introduced the latest in high performance LED technology to our expanding lighting range. A custom-made Tom Dixon LED ring and driver module was integrated into our existing best seller Melt and launched into two new collections, Spring and Opal.

In 2021, we have continued the upgrade and introduced the LED module into Beat, Copper, Mirror Ball and Void.

BURST

LED

For many years we have been making bigger clusters of pendant lamps, which seem to be replacing more conventional chandeliers in lobbies, in dining rooms or in entrance halls.



Burst Chrome Chandelier with the Fat Dining Chair, Cork Dining Table and Cloud Vessels

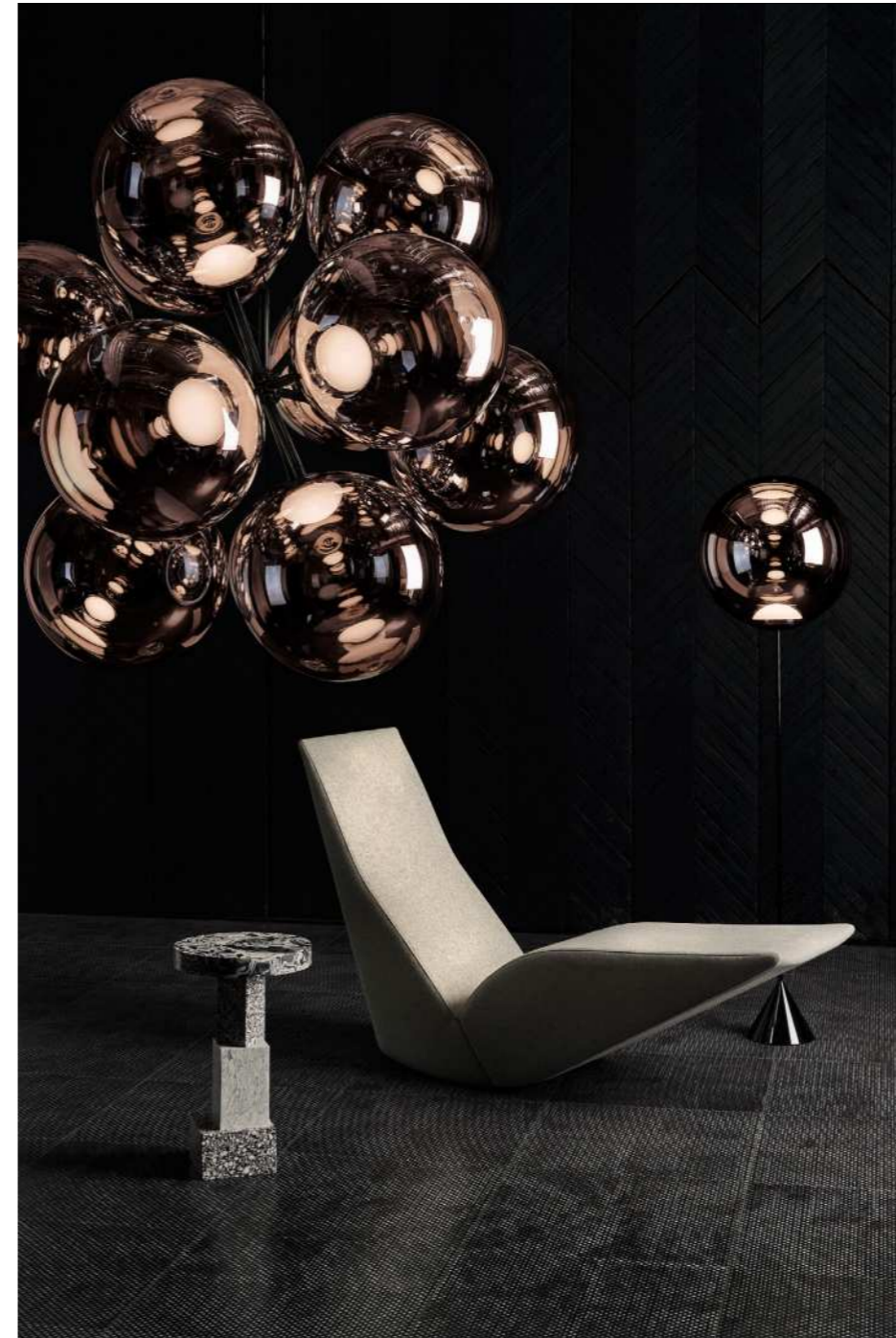

Burst Copper Chandelier with the Bird Chaise, Swirl Tall Table and Globe Copper Floor light

Burst is a way of getting an even more dynamic and three-dimensional array of lighting, without lots of dangling wires.

It's intended for filling larger spaces and ceiling voids and it was inspired by an interest in molecular structures and the forward-thinking space age.

With its chrome or copper aesthetic and geometric configuration, this enormous lighting fixture is of heroic proportions and impossible to ignore.

Large in scale and highly reflective, Burst is made up of 12 spherical orbs which explode from a single point construction to create a spectacular chandelier, available in copper and chrome finishes.

MATERIALITY
Polycarbonate, vacuum metallised surface

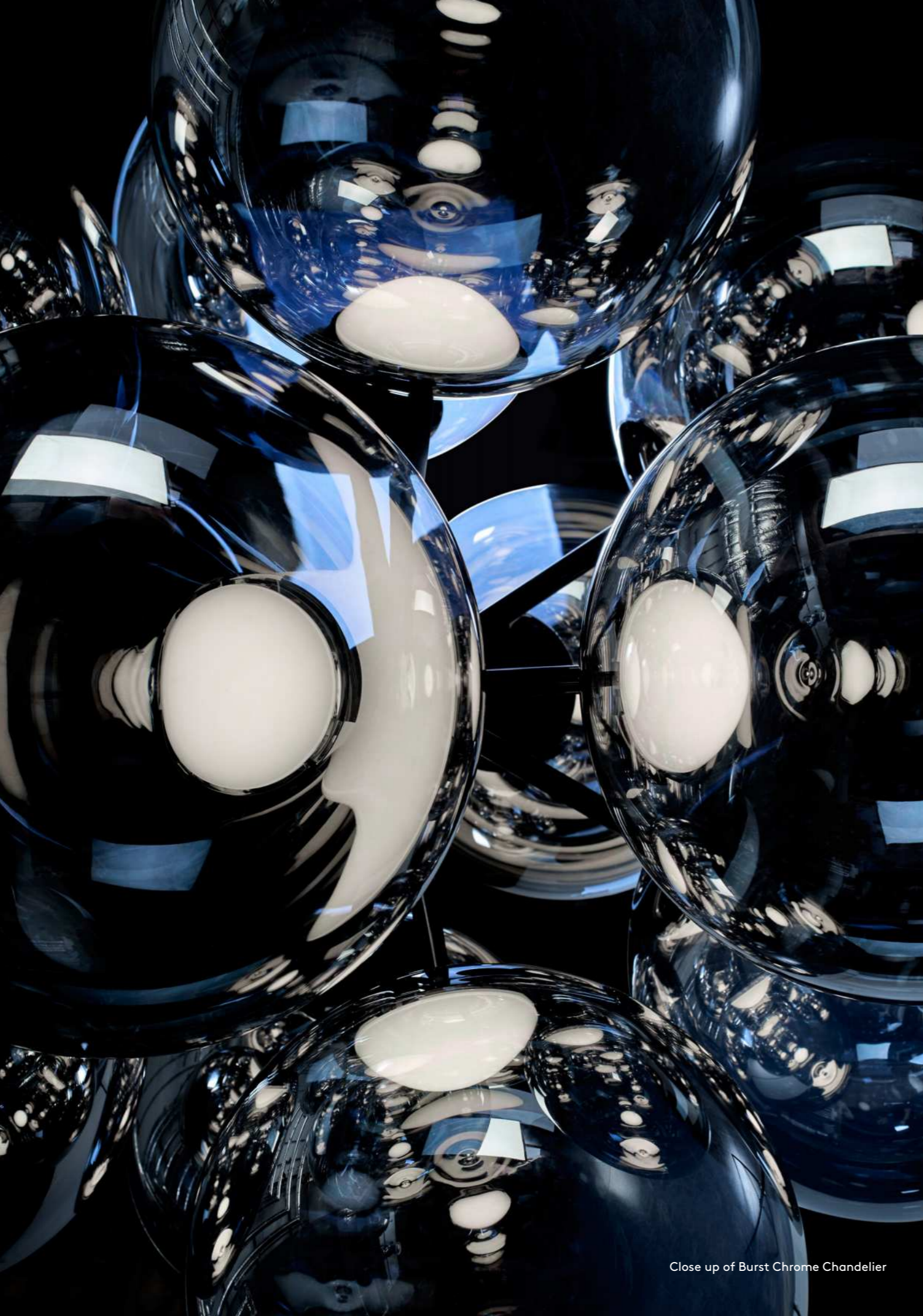

Close up of Burst Chrome Chandelier



Burst Chrome Chandelier with the LED diffuser

Burst Chrome Chandelier without the LED diffuser

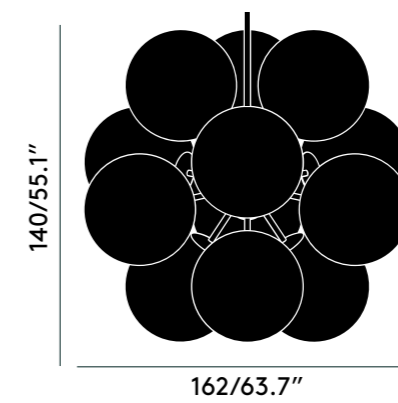

Burst Chandelier LED

COPPER

LED

Intended to create an extravagantly proportioned spotlight that could warm the greenish hue of early LEDs and create a more appealing luminosity, the Copper shade is an over-sized, blow moulded and perfectly reflective globe that kick started the craze for copper in interiors the world over.

The Copper shade is created by exploding a thin layer of pure metal onto the surface of a polycarbonate globe. Copper then achieves its perfect mirror finish by the technical process of vacuum metallisation.

The Copper family includes 25cm and 45cm diameter round pendants and a wide pendant in copper and black finishes.

MATERIALITY
Polycarbonate



Wingback Chair and Copper Wide Pendant



Copper Pendants 25cm and 45cm, S Chair, Screw Table and Spot Lights



Copper 25cm Pendant



Copper 25cm, 45cm and Wide Pendants, S Chair, Bell Table Light and Spot Lights

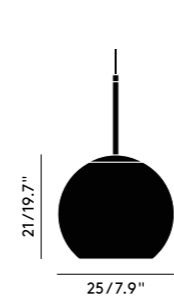

Copper LED 25cm

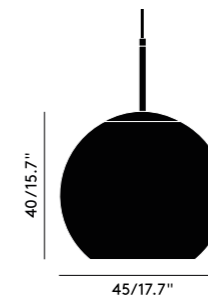

Copper LED 45cm

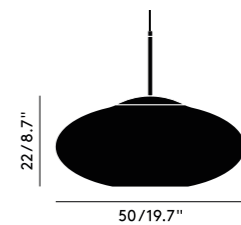

Copper Wide LED

GLOBE

LED

We are obsessed with spherical objects. In our perpetual quest for the purest forms, Globe stands out as the most minimal of the lot.

A spherical orb, highly mirrored and perfectly reflective during the day, when switched on reveals a multiplicity of internal reflections from the integral LED.

Reminiscent of ancient witch balls, hollowed spheres of coloured glass which were used to ward off evil spirits, Globe is available in copper and chrome finishes in pendant form, a floor light and a spectacular chandelier, Burst.

MATERIALITY

Polycarbonate, vacuum metallised surface



Globe Copper Pendant, Eclectic London Candle, S Chair



Globe Chrome Pendant, Globe Chrome Floor Light and Press Large Vase



Globe Chrome Pendant and Cloud Platter



Burst Chrome Chandelier, Fat Lounge Chair, Fat Chaise, Globe Chrome Floor Light, Flash Tables and Cloud Vessels

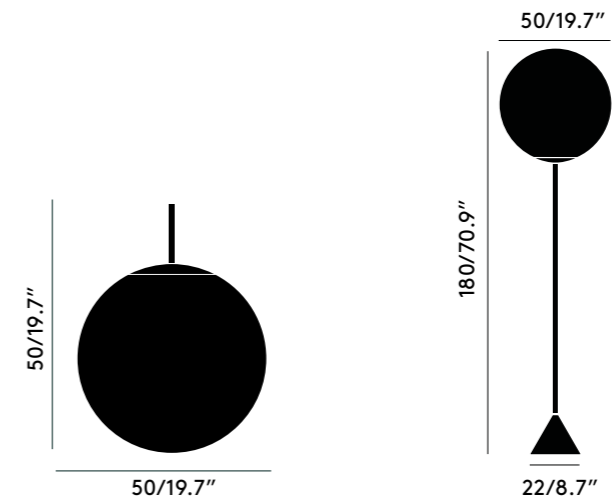

Globe 50cm LED Pendant

Globe Cone LED Floor

MELT

Obsessed with the idea of creating an imperfect, organic and naturalistic lighting object, Melt was created in collaboration with Front, a Swedish design collective.

With Melt, our experiments in the technologically advanced field of vacuum metallisation takes on a new twist.

The light bouncing and reflecting around the uneven surfaces creates an attractive, mildly hallucinogenic light, akin to molten glass, the interior of a melting glacier, or images of deep space.

The latest additions to the Melt family include the Melt large chandelier, a configuration of seven organic and imperfect orbs which explode from a central hub to create a dynamic lighting sculpture of infinite reflections.

Melt small chandelier features four orbs protruding from steel tubes and is one metre high.



Melt Chrome Small Chandelier, Primavera Marble Top, Puck Glasses, Brew Biscuit Tin

MATERIALITY

Polycarbonate, vacuum metallised surface



Melt Gold Large Chandelier and Wingback Chairs



Melt Gold Standing Chandelier and the S Chair

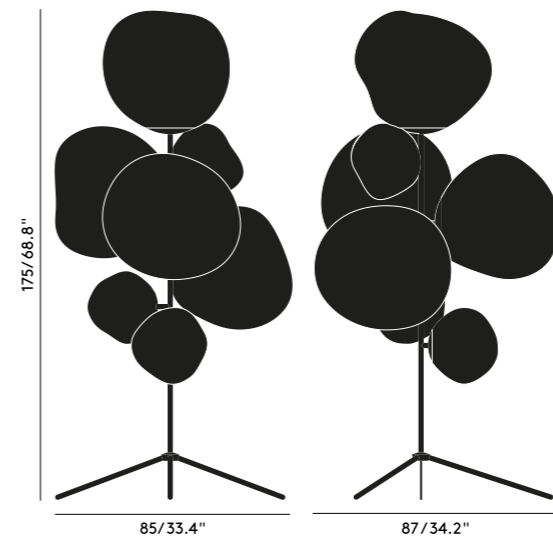

Melt Standing Chandelier

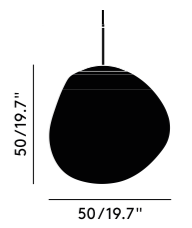

Melt Pendant LED



Melt Mini Pendant LED

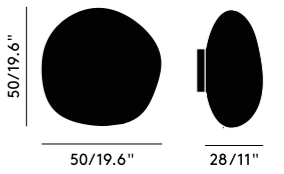

Melt Surface LED

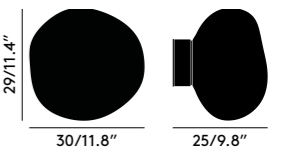

Melt Mini Surface LED

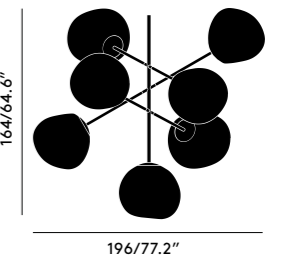

Melt Large Chandelier LED

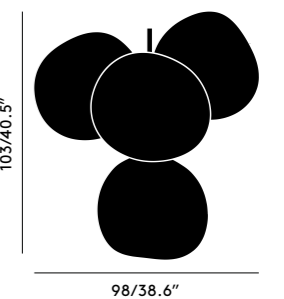

Melt Small Chandelier LED

MIRROR BALL

LED



Mirror Ball Chrome 50cm and 25cm Pendants

Sometimes your biggest failure could be your biggest success. For Mirror Ball, the aim was to produce a completely spherical, highly mirrored object that would disappear into its surroundings.

Instead, it does the opposite and is an ultra-visible, highly reflective object that mirrors its environment. One of the most identifiable Tom Dixon products, inspired by the famous space helmet and by disco balls.

Mirror Ball is lightweight yet robust and is created through a process of blow moulding and vacuum metallisation to achieve perfect spheres with abundant and unusual luminosity.

MATERIALITY

Polycarbonate, vacuum metallised surface



Mirror Ball Gold 50cm Pendant and Form Brass Teapot, Jug and Milk Jug



Mirror Ball Gold Pendant System with Melt Gold Surface Lights



Mirror Ball Chrome Pendants

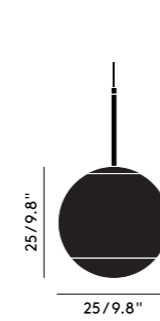

Mirror Ball 25cm LED

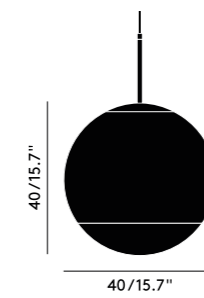

Mirror Ball 40cm LED

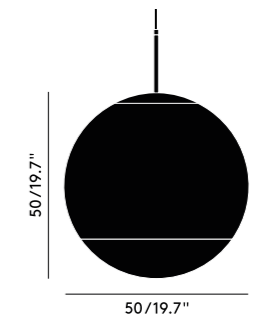

Mirror Ball 50cm LED

OPAL

LED



Opal Pendants, Opal Cone Floor Light and Cork Dining Table



Opal 50cm and 25cm Pendants with Puck Glasses

Opal is a family of translucent globes using our own custom recipe of tinted white opalescent polycarbonate.

Semi translucent, they maintain an ethereal ghostliness in the daylight and at night form a perfectly illuminated sphere.

Coupled with our Tom Dixon LED, the OPAL range emits a soft, diffused and flattering light. The softness of the lightbulb shape is achieved through a blow-moulded custom combination of opalescent plastic. This process works to achieve an organic form as well a delicate translucency.

MATERIALITY
Polycarbonate



Opal 25cm and 50cm Pendants, Floor Light and Surface Light with Slab Black Dining Table and Slab Upholstered Chairs

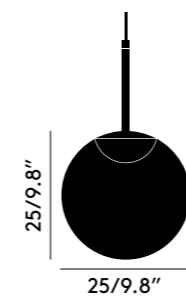

Opal Pendant 25cm LED

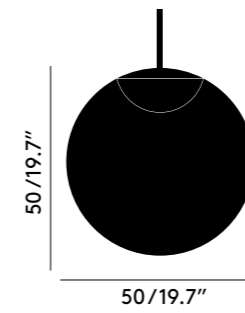

Opal Pendant 50cm LED

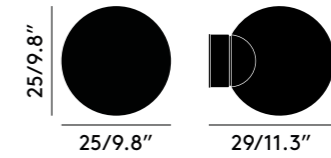

Opal Surface LED

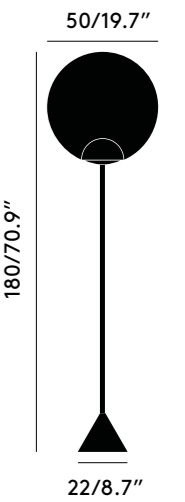

Opal Cone Floor LED

BEAT

Perpetuating the skills of artisan craftsmen in Northern India, Beat's origin is a re-purposed water vessel; hand-raised, welded, beaten and skimmed into functional silhouettes for the refraction of golden light.

Hand spun from solid sheets of brass; the interior of each piece bears the beaten marks of its maker. The creation of each Beat light is part of an ancient process that takes four days to complete.

Our Beat lights are recognised in homes, restaurants and hotels the world over and are available in a range of pendants, floor and table lights. The finishes include: black with a brass interior, brushed brass with a brass interior and white with a brass interior.

MATERIALITY

Coated brass shade, beaten by hand. Cast iron base



Beat Brass Tall Pendant with Beat Floor and Table Lights,



Beat Pendant System, Wingback Sofa, Armchair and Micro Armchair, Beat Vessels and Flash Brass Tables



Beat White Pendants, Tube Brass Dining Table with White Marble, Slab Natural Chairs

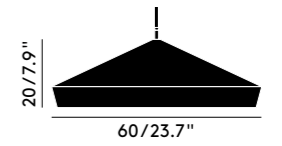

Beat Flat LED (Black)

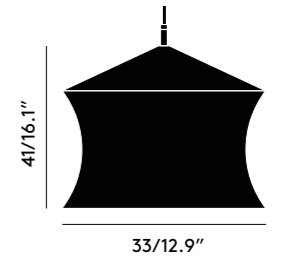

Beat Waist LED (Black)

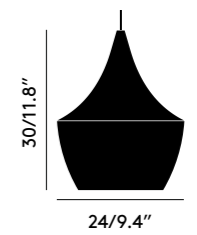

Beat Fat LED (Black, Brass and White)

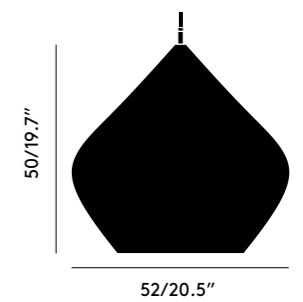

Beat Stout LED (Black, Brass and White)



Beat Tall LED (Black, Brass and White)

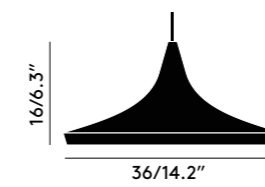

Beat Wide LED (Black, Brass and White)

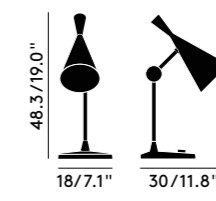

Beat Table (Black and Brass)

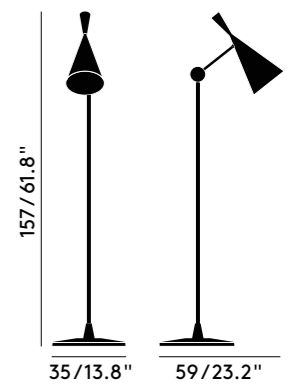

Beat Floor (Black and Brass)

SPRING

LED



Spring White large and medium Pendants, Wingback Chair and Screw Table



Spring Silver small, medium and large Pendants and Wingback Chair

SPRING is a series of pendant lamps made up of stainless-steel strips.

Pliant ribbons of stainless steel have been arranged like a whisk around our custom-made dimmable Tom Dixon LED module.

The semi-transparent shape thus created can be adjusted to a variety of silhouettes - from a flat arrangement reminiscent of a spirograph drawing, to a flying saucer configuration and on to a fuller shape akin to a pumpkin.

MATERIALITY
Stainless Steel



Spring Brass large Pendant, Fat Chaise, Form Teapot, Tray and Tea Caddy, Flash Table



Tom with the Spring Brass Pendant

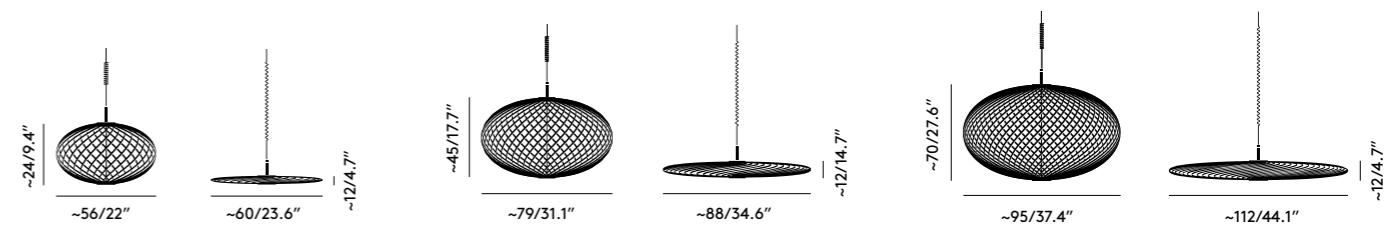

Spring Small LED

Spring Medium LED

Spring Large LED

VOID LED

LED



Void Silver Pendant with Tank Champagne Flute

Semi-precious metals pressed, spun and brazed into complex double-walled shades, Void is the result of a challenge to create a luminous pendant that mysteriously conceals its light source.

Inspired by vacuum flasks, Void is made from pure metal formed into a complex double-walled shade.

They are then hand polished to a mirror finish before being applied with a lacquer to maintain the high gloss finish.

MATERIALITY
Brass, Copper
& Stainless Steel



Void Mini Silver Pendant with Brew Cafetiere and Scoop



Void Brass Pendants



Void Brass, Copper and Silver Pendants

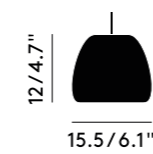

Void Mini LED



Void LED

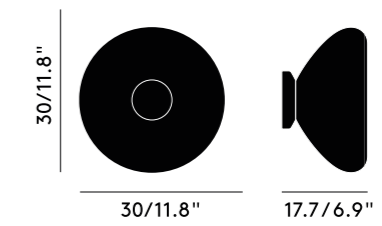

Void Surface LED

PRESS

LED

Press is a series of lights made from the thickest and most transparent glass with a satisfyingly rounded linear surface detail.

Aptly named Sphere, Cone and Surface, the shapes of Press are reminiscent of shipping buoys and children's toys.

The ribbed glass creates diffusion of the light source and projects linear and stripy patterns.

Bold in silhouette and simple in function they are manufactured by dropping massive globs of molten glass at 1,200 degrees centigrade, pressed in iron moulds under tons of pressure to create immensely durable lights.

Press Surface light is rated IP55 and is suitable for installation in living areas, bathroom Zone 2 and sheltered outdoor areas.

MATERIALITY
Glass

Press Sphere Pendant, Press Stem
and Large Vases



Tom with the Press Cone Pendant



Press Surface Light and Eclectic Royalty Candle

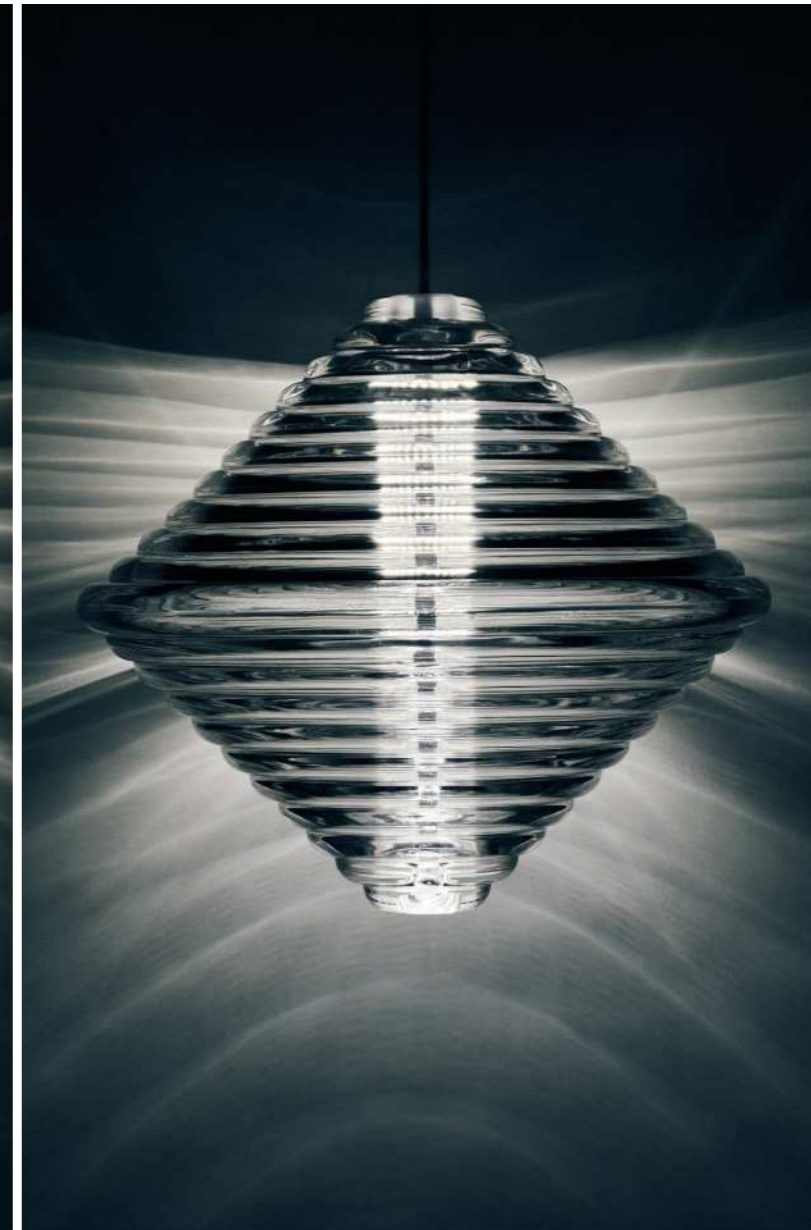

Press Sphere Pendant, Press Cone Pendant

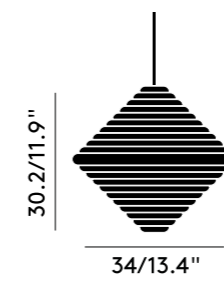

Press Cone Pendant LED

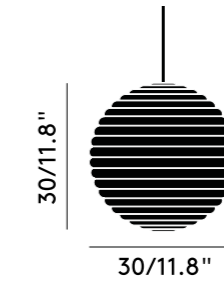

Press Sphere Pendant LED



Press Large Surface LED



FURNITURE

MASS 2.0

The Mass family is proudly manufactured in the UK and made from one single extruded box section of brass.

By using the most familiar unit in furniture construction – the plank – and presenting a series of familiar objects in a highly polished gold hued metal, Tom Dixon manages to make domestic archetypes into monumental heavyweight sculpture.

The rectangular plank is used in a multitude of configurations and will eventually be presented as a made to measure construction set, with a series of predetermined junctions that allow architects and interior designers the liberty to construct their own Mass artefact.

The new and improved Mass family is a development from the previous Mass products, which were made of brass-clad mango wood. The new solid brass products have been designed with longevity in mind and are made with a noble material which will stand the test of time.

In the Mass collection, you will see a series of experiments in materiality and repetition, where Tom's current obsession with basic units multiplied is turned into an abundance of sculptural experiments in function.

Designed in London and engineered in the Southwest countryside, in Dorset by skilled metalworkers, the Mass collection also includes a Console Table, 2M Table, Coat Stand and Bookshelf.

MATERIALITY
Brass



Tom with the Mass Coat Stand



Mass Coat Stand and 2m Table

Mass 3m Table



Mass 3m Table, Book Shelf and Coat Stand



Mass 2m Table, Book Shelf, 3m Table and Coat Stand

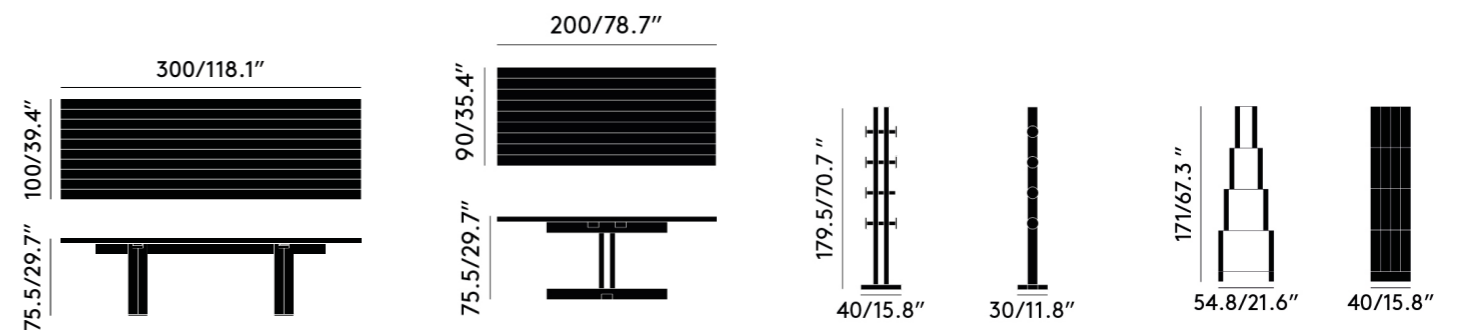

Mass Table 3m

Mass Table 2m

Mass Coat Stand

Mass Book Shelf

TUBE

A simple, sleek table for all occasions, Tube is a versatile and elegant table base.

Available in brass, black and a new chrome finish, Tube is a sophisticated sturdy table component that can be customised. Tube can be paired with White or Primavera marble table tops and comes in a dining, tall and wide table heights.



Tube Chrome Table with Primavera Marble, Globe Chrome Pendants and Floor Light, S Chair, Cloud Vessel



Tube Black High Table with White Marble, Fat Bar Stools, Melt Chrome Pendants and Surface Lights, Tank Glasses

MATERIALITY

Brass plated steel,
chrome plated steel or
black glossy steel



Tube Brass High Table with White Marble, Fat Bar Stool, Beat Brass Tall, Fat and Flat Pendants



Tube Black Wide Table with Primavera Marble, Fat Dining Chairs and Copper Black Pendants

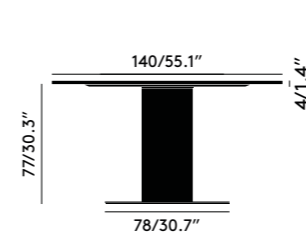

Tube Table Wide

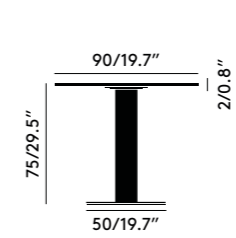

Tube Table Dining

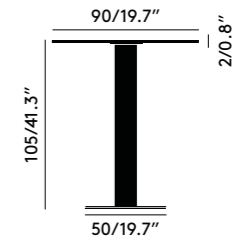

Tube Table High

FLASH



Flash Circle, Square and Rectangle Tables in Chrome and Primavera Marble and Burst Chrome Chandelier



Flash Brass Tables with Melt Smoke Pendants

Inspired by glam-rock, Flash is our continued quest to create an ultra-reflective, theatrical surface which mirrors its surroundings.

Flash is a set of three crisp and smartly detailed side tables. Available in brass and glossy black and topped with a mirrored glass surface, Flash are moody singular statements that can be nested together as a three-tiered multi-level coffee table.

Flash is also available with the Primavera tabletop paired with the new chrome base.

MATERIALITY

Iron, brushed iron, and glass



Flash Black Tables with Wingback Chair and Sofa and Bash Vessel



Flash Black Tables with Opal Pendants and Floor lights and Fat Chairs

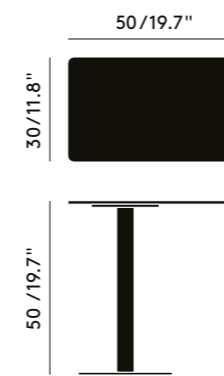

Flash Rectangle

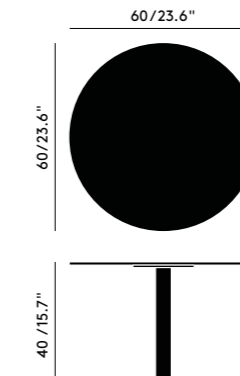

Flash Circle

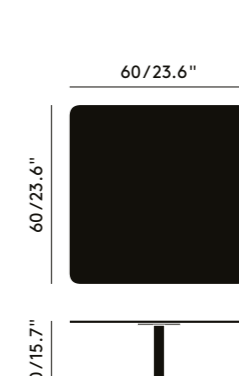

Flash Square

FAT



Fat Lounge Chair, Melt Gold Pendant and Puck Coup Glass



Fat Bar Stools, Melt Chrome Pendants and Surface Lights and Tube Black High Table

Fat, our upholstery chair range is designed to hug the body and allows for multiple sitting positions.

The extreme simplicity of the components is a testament to form following function, whilst maintaining a humorous silhouette and a reductionist aesthetic. Quite a balancing act.

MATERIALITY

Gloss powder coated steel and moulded foam

Fat is made from moulded foam with a metal leg in high gloss black lacquer and made to order upholstery. Manufactured in Europe, hand finished and upholstered by experienced craftsmen. The Fat family has expanded with the launch of 2-Seater and 3-Seater Sofas, Bar Stool and Chaise Longue now available.



Fat 3-Seater Sofa, Chaise and Lounge Chair, Mirror Ball Gold Pendant, Flash Black Rectangle Table and Bone Bowls



Fat 3-Seater Sofa, Lounge and Dining Chair with Melt Chrome Small Chandelier, Globe Chrome Floor Light, Puck Glasses and Flash Tables

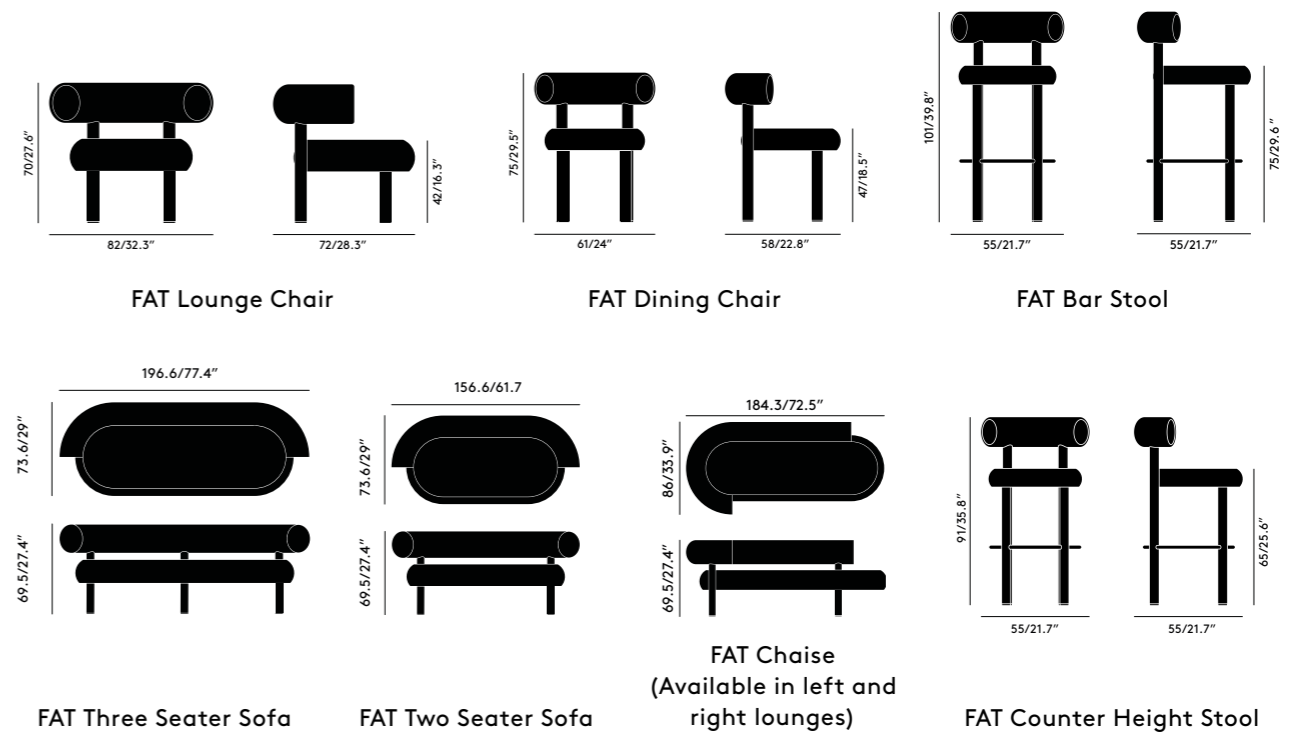

WINGBACK

Wingback was inspired by traditional 17th century Wingback and balloon-back archetypes and was developed for the Shoreditch House Member's Club.

Its expressive sweeping curves allows designers to specify Wingback in the centre of spaces as a sculptural intervention rather than merely a piece of seating.

The wings provide convenient acoustic protection for mobile phone use and a headrest for quick snoozes.

MATERIALITY

Upholstered foam shell
with steel subframe



Tom with the Micro Wingback Chair



Wingback Chair with Beat Floor Light



Wingback Chair with Spring White Pendants and Screw Table



Wingback Sofa and Wingback Micro Chair



Wingback Chair



Micro Wingback Chair

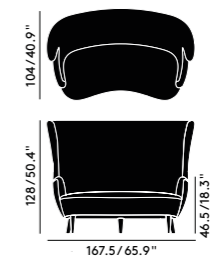

Wingback Sofa

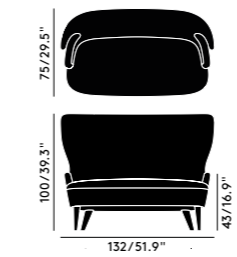

Micro Wingback Sofa

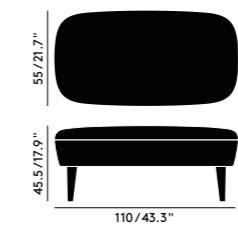

Wingback Ottoman Long

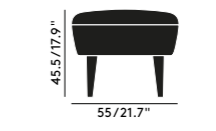

Wingback Ottoman

CORK

A tactile material which has been used for millennia in nautical, construction, apparel and food applications, Cork is the ultimate traditional material fit for the future.

By repurposing this wonder material for our range of extremely fat edged and chubby silhouette furniture, we have taken full advantage of the elasticity and sound absorption characteristics of cork, which combined with its natural beauty makes a unique set of seriously sculptural furniture with expressive minimalist attributes and superior functionality.



Cork Round Table, Melt Gold Small Chandelier, Fat Dining Chair and Form Bowl



Cork Dining Table and Bash Vessel

MATERIALITY
Cork



Cork Round Table, Melt Gold Large Chandelier, Fat Dining Chairs and Bash Tray



Cork Dining Table, Opal Pendants and Fat Dining Chairs

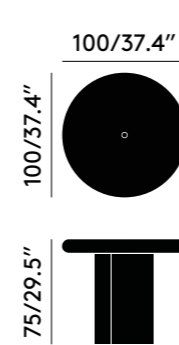

Cork Round Table 1m

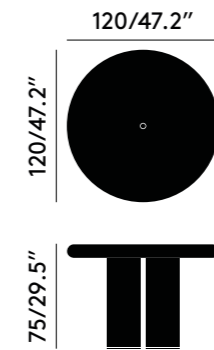

Cork Round Table 1.2m

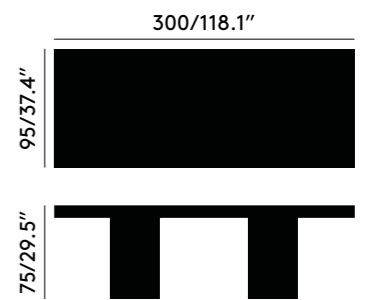

Cork Table 3m

FURNITURE

SLAB



Slab Black Dining Table, Slab Black Upholstered Chairs and Opal Pendants



Slab Natural Desk and Mirror Ball Chrome Pendants

Celebrating the natural beauty of oak, the Slab collection is a robust piece constructed in angular forms of inviting simplicity.

Each piece has generous proportions, solid materiality and is softened with a gently radius edge. The Slab family is made from solid oak, sourced from sustainably managed forests.

The surface of the wood is deeply brushed to expose the grain. A family of desks, chairs and stools.

MATERIALITY
Oak



Slab Natural Chairs, Beat White Floor, Table and Pendant Lights



Slab Black Dining Table, Slab Black Upholstered Chairs and Opal Pendants and Floor Light



Slab Stool



Slab Side Chair



Slab Side Chair Upholstered

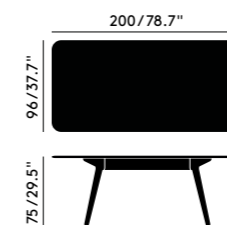

Slab Table 2m

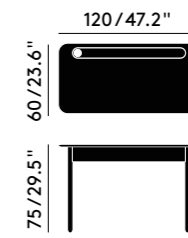

Slab Individual Desk Small

SWIRL

Swirl is a mysterious new material that resembles 3D marbled paper yet has the weight of stone.

The unique process involves recycling the powdered residue from the marble industry, mixed with pigment and resin to create blocks of material that can then be sawn, sliced and turned on a lathe.

Swirl is a family of tables, each with their own distinct silhouette, colouration and personality.



Swirl Medium Table



Swirl Low, Tall and Medium Tables



MATERIALITY

Powdered marble, resin, pigment



Swirl Vases (stacked), Swirl XL and Cone Tables (stacked)

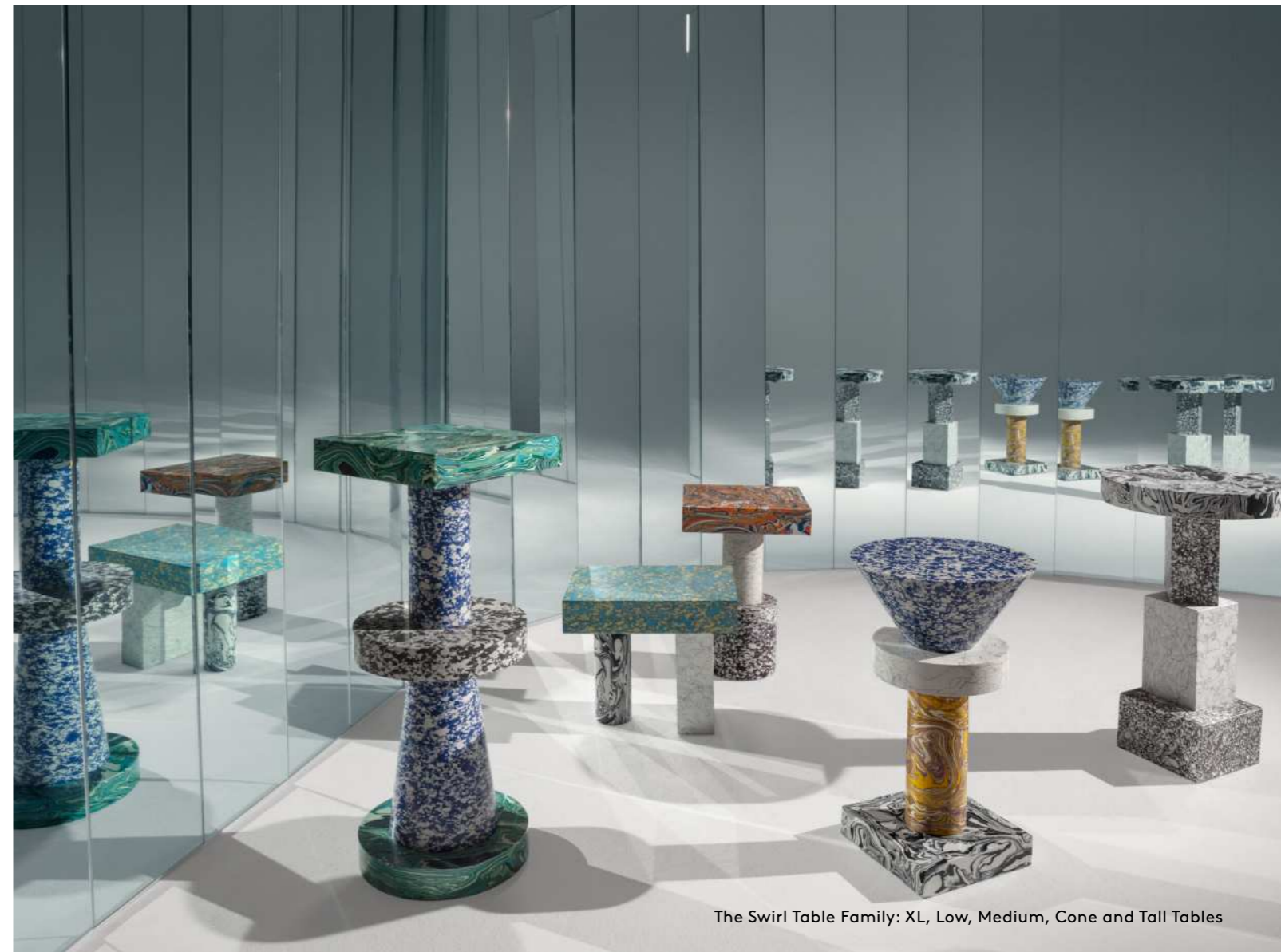

The Swirl Table Family: XL, Low, Medium, Cone and Tall Tables

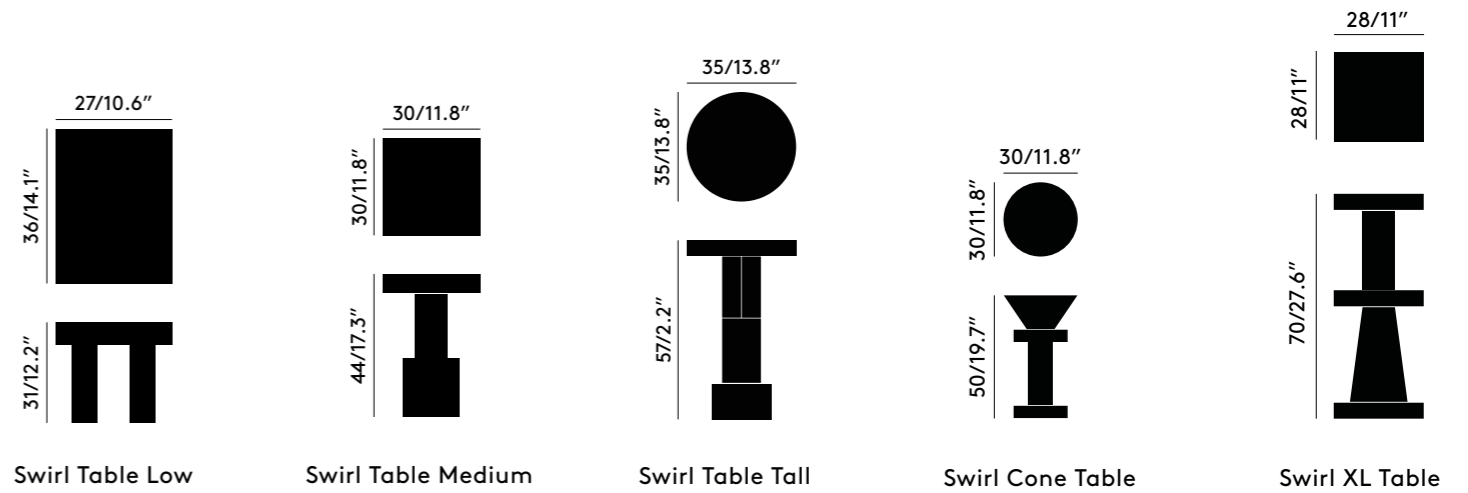

Swirl Table Low

Swirl Table Medium

Swirl Table Tall

Swirl Cone Table

Swirl XL Table



ACCESSORIES

SWIRL

Swirl is a series of geometric forms stacked upon one another to create multidimensional, functional sculptures.

A family of candleholders, bookends, vases and tables, each with their own distinct silhouette, colouration and personality.

Substantial in weight, smooth in texture and bold in pattern, Swirl will inject a fresh pop sensibility into any setting.



Swirl Candleholders



Swirl Bookends



Swirl Vase, Medium, Small and Stem sizes

MATERIALITY
Powdered marble, pigment, resin



Swirl Black and White Candelabra



Swirl Stack and Ball Candles

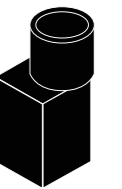

Swirl Vase



Swirl Medium Vase



Swirl Small Vase



Swirl Stem Vase



Swirl Stack Candle



Swirl Ball Candle



Stepped Book Ends



Multi Candelabra

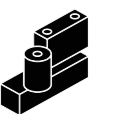

Black & White Candelabra

PRESS

The thickest industrially pressed glass artefacts designed and engineered to catch and refract light, and to last for ever.

Press is a series of heavyweight grooved vases, bowls and candleholders made of fat, chunky coils of pure and clear transparent glass.

Bold in silhouette and simple in function they are manufactured by dropping big globs of molten glass at 1,200 degrees centigrade and pressed in two- or three-part iron moulds to create immediately familiar silhouettes.

MATERIALITY
Glass



Press Large Vase



Tom with the Press Medium and Large Bowls

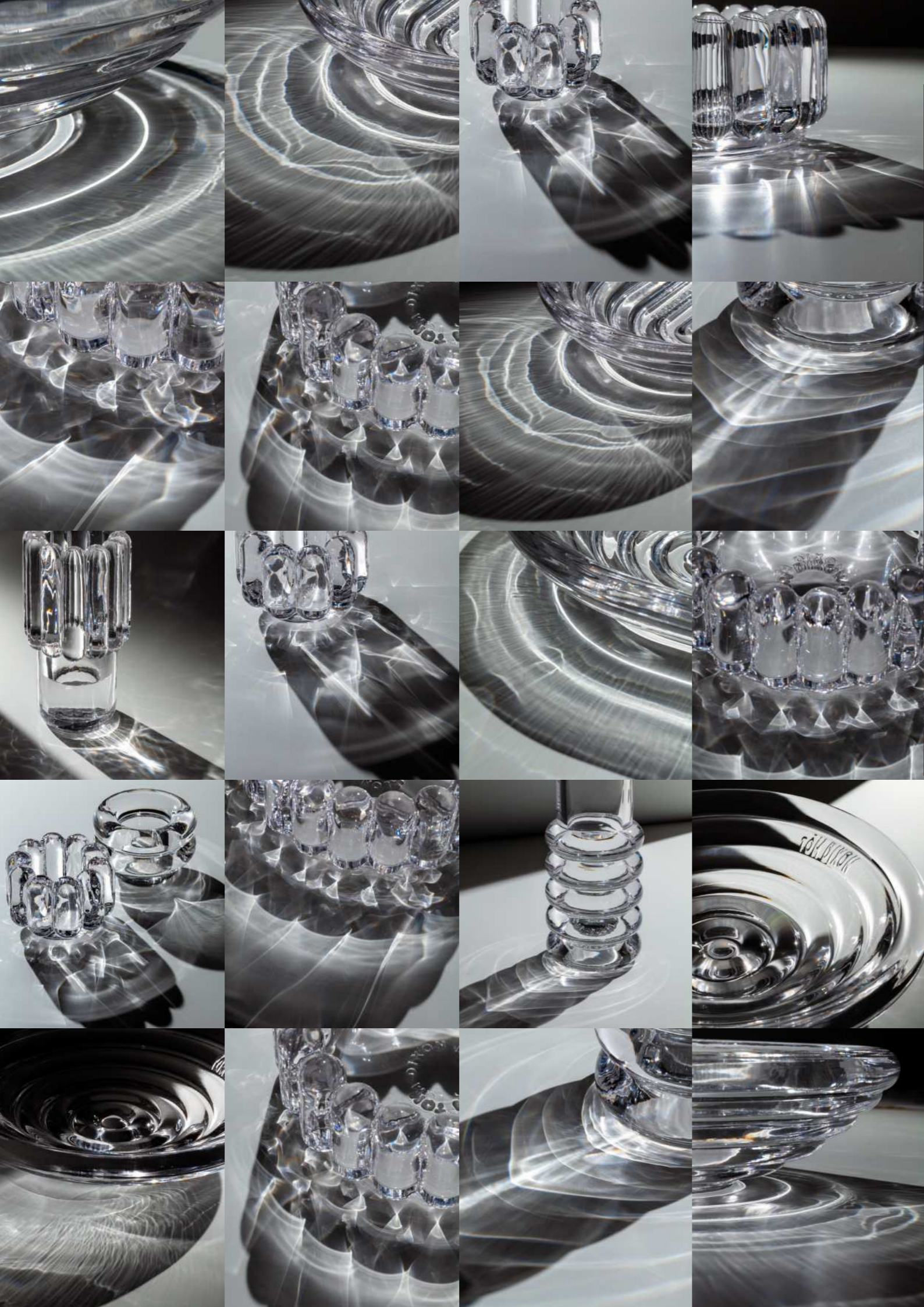

Press Medium Bowl, Horizontal Tealight Holder, Large, Small and Stem Vases, Large Bowl, Vertical Tealight Holder and Small Bowl



Press Tealight Vertical



Press Tealight Horizontal



Press Stem Vase

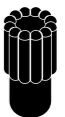

Press Medium Vase



Press Large Vase



Press Small Bowl



Press Medium Bowl



Press Large Bowl

PUCK

Puck is a collection inspired by the basic forms of geometry, such as cylinders, cones and spheres.

Puck is made of mouth-blown glass with a hint of smoke colour.

Anchored with a thick base which is reminiscent of game pucks, minimal and heavy-weight, Puck accessories are resilient enough to survive in a professional cocktail environment.



Puck Flute, Coup, Highball and Balloon Glasses



Puck Flute and Cocktail Glasses

MATERIALITY
Glass



Puck Cocktail, Flute, Coup and Highball Glasses



Puck Shot Glasses, Ice Bucket, Cocktail, Balloon and Coup Glasses

Puck Flute, Coup, Balloon and Balloon Glasses

- 
 Puck Coupe Glass X 2
- 
 Puck Cocktail Glass X 2
- 
 Puck Highball Glass X 2
- 
 Puck Balloon Glass X 2
- 
 Puck Shot Glasses X 4
- 
 Puck Flute Glass X 2
- 
 Puck Ice Bucket

ACCESSORIES

TANK



Tank Black Wine Decanter, Beer Glass and Water Jug



Tank Copper Low Ball, Flute and Wine glasses with the Wine Decanter

Tank takes its sculptural cue from the functional shapes and volumes of scientific glassware.

Minimal yet decorative for a multiplicity of purposes of drinking, pouring, storing and displaying food and drink, the range forms bold building blocks of table-top architecture.

Tank is made from mouth-blown clear glass, finished with the same precision as cut crystal.

Our adventures in glass originate in the lab, with the curiosities of conical shapes and scientific apparatus. Ultra-simple and rigorously functional, the traditional lab kit is an underlying influence across our tabletop glassware.

Each object is ornamented with real liquid gold and colourants, hand-painted with our signature copper detailing and our logo is sand-blasted on the base.

MATERIALITY
Glass



Tank Black Wine Decanter, Beer Glass and Water Jug



Tank Copper Wine Decanter and Low Ball Glasses

- 
Tank Wine Decanter
- 
Tank Jug
- 
Tank Whiskey Decanter
- 
Tank Ice Bucket And Tongs
- 
Tank Vase Medium
- 
Tank Vase Stem
- 
Tank Vase Large
- 
Tank Wine Glasses X2
- 
Tank Low Ball Glass X2
- 
Tank High Ball Glass X2
- 
Tank Whiskey Glass X2
- 
Tank Beer Glass X2
- 
Tank Champagne Glass X2

ECLECTIC

Recognising that first impressions and memories are connected to the sense of smell, Tom Dixon's journey into the world of fragrance started with Eclectic; a collection inspired by the brand's origins as a true Londoner.

The collection evokes historical memories of British life, of travelling and trading across the globe and returning to the familiar gritty smells of modern cosmopolitan London.

We have refreshed the vessel form with an elegant, slim waisted metal container and added two refined perfumes to the collection – Underground and Alchemy join London, Royalty and Orientalist fragrances.



Eclectic Royalty Medium Candle, Mill Grinders, Fog Royalty Incense Burner and Tank Champagne Flute



Eclectic Underground Diffuser, Fog Orientalist Incense Burner and Eclectic Underground Medium Candle

MATERIALITY

Stainless Steel, Brass, Copper



Eclectic London Large Candle, Globe Copper Pendant and S Chair



Eclectic Alchemy Diffuser



Eclectic Medium Candle



Eclectic Large Candle



Eclectic Diffuser

ACCESSORIES

FOG

For a long time, Tom wanted to go beyond the realm of candles and diffusers and explore different methods of scenting the home, and Fog is his first experiment in incense.

Often associated with alternative culture, incense is used for aromatherapy, meditation, and obscure ceremonial practices.

Fog gently disperses the London, Royalty, Orientalist fragrances through a handcrafted brass vessel that's substantial in weight and considering its tiny size, packs a determined punch.

MATERIALITY

Stainless Steel, Brass, and Copper



Fog Royalty Incense Burner, Eclectic Alchemy Diffuser and Eclectic Alchemy Medium Candle



Fog London, Royalty and Orientalist Incense Burners



Fog London Incense Burner



Fog Orientalist Incense Burner, Form Jug



Fog Diffuser



Fog Refill Cones

FORM

Form is a well-proportioned and rigorously detailed solid stainless steel tea set.

Described as Bauhaus, Space Age or Art Deco, we believe this crisp, clean reflective stainless steel finish sits comfortably in any setting and creates a modernist scene for one of the most enjoyable and enduring rites. A family of sophisticated artefacts, Form allows you to create your own contemporary tea ceremony.



Form Stainless Steel Teapot, Sugar Bowl and Spoon and Milk Jug



Form Tea Set: Teapot, Jug, Milk Jug, Tea Caddy, Sugar Bowl and Spoon and Tray

MATERIALITY
Stainless steel

ACCESSORIES



Form Stainless Steel Teapot, Tea Caddy and Tray with Melt Chrome Surface Light



Form Teapot, Sugar Bowl and Milk Jug



Form Teapot



Form Milk Jug



Form Sugar Bowl And Spoon



Form Jug



Form Tray



Form Tea Caddy

MILL



Mill Small and Large Salt and Pepper Grinders



Mill Small and Large Salt and Pepper Grinders, Spring Silver Pendants

Salt and pepper play a heroic role in the kitchen. Mill is a set of grinders with expressed handles and sleek conical silhouettes made of stainless steel.

MATERIALITY
Stainless Steel

The forms have been designed with longevity and quality in mind, particularly in the grind mechanism as there is nothing more frustrating than a pepper mill that wears down or clogs. The Mill vessels are designed with a robust mechanism and ergonomic shape allowing for effortless grinding.



Mill Small and Large Salt and Pepper Grinders



Mill Small and Large, Fog Royalty Incense Burner, Eclectic Royalty Large Candle and Tank Champagne Flute



Mill Small



Mill Tall

BREW

Brew recognises coffee making as a form of art and coffee drinking as one of our few remaining contemporary rituals.

It is a celebration of the coming together of heat, steam, water and coffee grounds – a tribute to the mysteries of the modern-day coffee ceremony.

Precision-engineered from stainless steel, Brew is hyper-reflective, functionally rigorous and designed to take pride of place on any kitchen counter, bar or occasional table.

Tall and tactile with futuristic art deco looks, the result is a sleek, sturdy collection. The centrepiece of the coffee ceremony.



Brew Stainless Steel Cafetiere, Scoop, Espresso Cups, Stove Top, Biscuit Tin and Tea Caddy

MATERIALITY
Copper Steel, Stainless Steel



Brew Copper Coffee Set

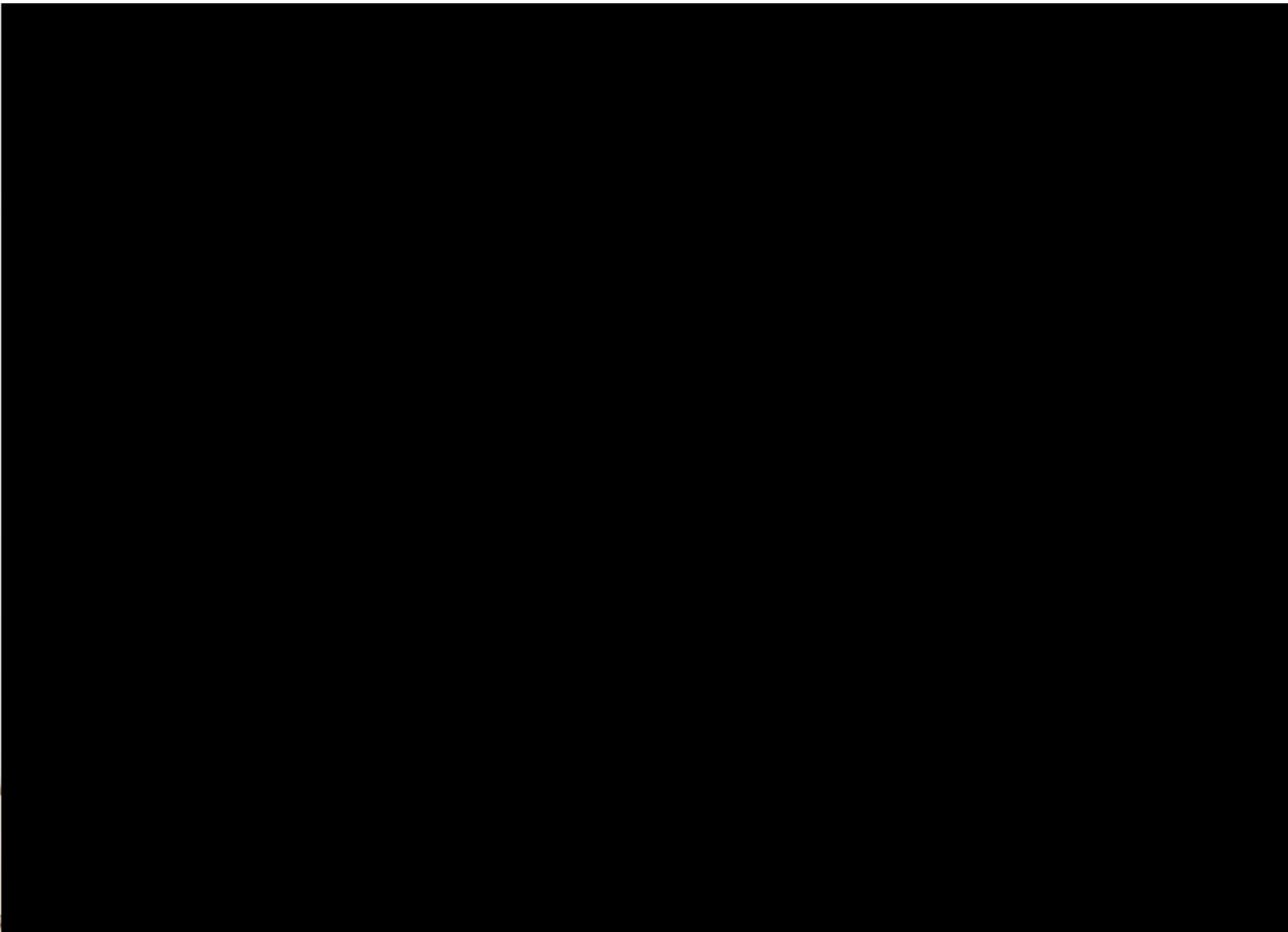

Brew Stainless Steel Coffee Set



Brew Stove Top



Brew Scoop



Brew Espresso Cups X 4



Brew Milk Pan



Brew Tray



Brew Cafetiere



Brew Biscuit Tin



Brew Coffee Caddy

ENQUIRIES

UK, EU, REST OF WORLD
sales@tomdixon.net
T +44 (0)20 3848 6100

USA
united_states@tomdixon.net
T +1 212 228 7337

ASIA
asia@tomdixon.net
T +852 3153 2229

TOM DIXON SHOPS
tomdixon.net/storelocator

PRESS ENQUIRIES
tomdixon.net/press

PHOTOGRAPHY
petenavey.com
peerlindgreen.com

tomdixon.net

@tomdixonstudio

Copyright 2021
Design Research Limited

