

Dama, Knit, Spa,  
Africa, Mayfair Mini,  
Out, Break Plus,  
Dots Outdoor, Class,  
Composing Pendants

VIBIA



# VIBIA

## Current catalogues



General Catalogue

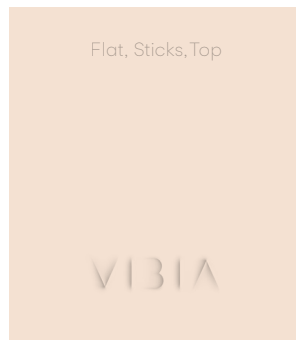

New Collections 1



New Collections 2



Plusminus



New Collections 3

## The new warm indoor collections

Dama

**6**

Knit

**16**

## The wellness and wet location solution

Spa

**28**

## Portable lighting concepts

Africa

**40**

Mayfair Mini

**50**



Living indoor and outdoor  
Out  
**62**

The new outdoor collections  
Break Plus  
**72**  
Dots Outdoor  
**82**  
Class  
**90**

A tool for unlimited creativity  
Composing Pendants  
**104**



# Dama

Design by Ludovica+Roberto Palomba.

Combining technical quality and refinement with a layer of warmth and intimacy, the Dama collection connects the charm of tradition with the finesse of contemporary lighting design.





“Dama is characterized by the refinement of its proportions combined with the lightness of its lines that give life to a very exquisite silhouette”.

Ludovica+Roberto Palomba







“For the diffuser we decided to dare with an unexpected touch using paper - a noble and tactile material, almost fragile and intangible - which, thanks to its characteristics, gives the lamp a warm light”.

Ludovica+Roberto Palomba

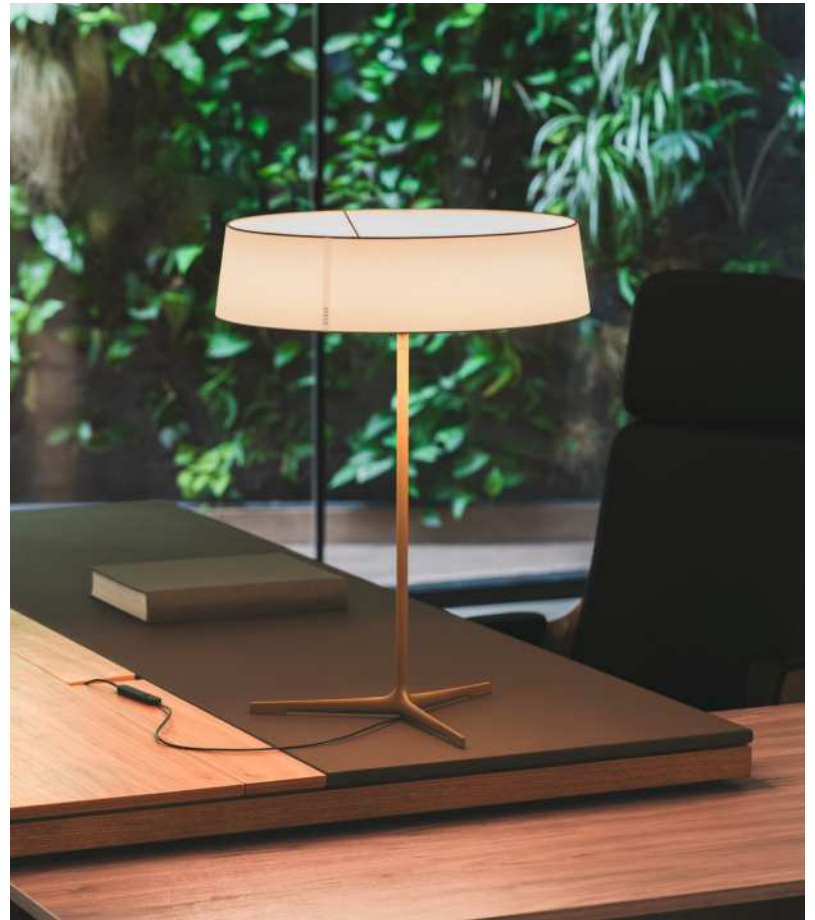

Suspended from a micro-thin cable that's almost invisible to the eye, the pendant version exhibits an ethereal quality, its graceful silhouette looming overhead like a celestial body.





PENDANT

13



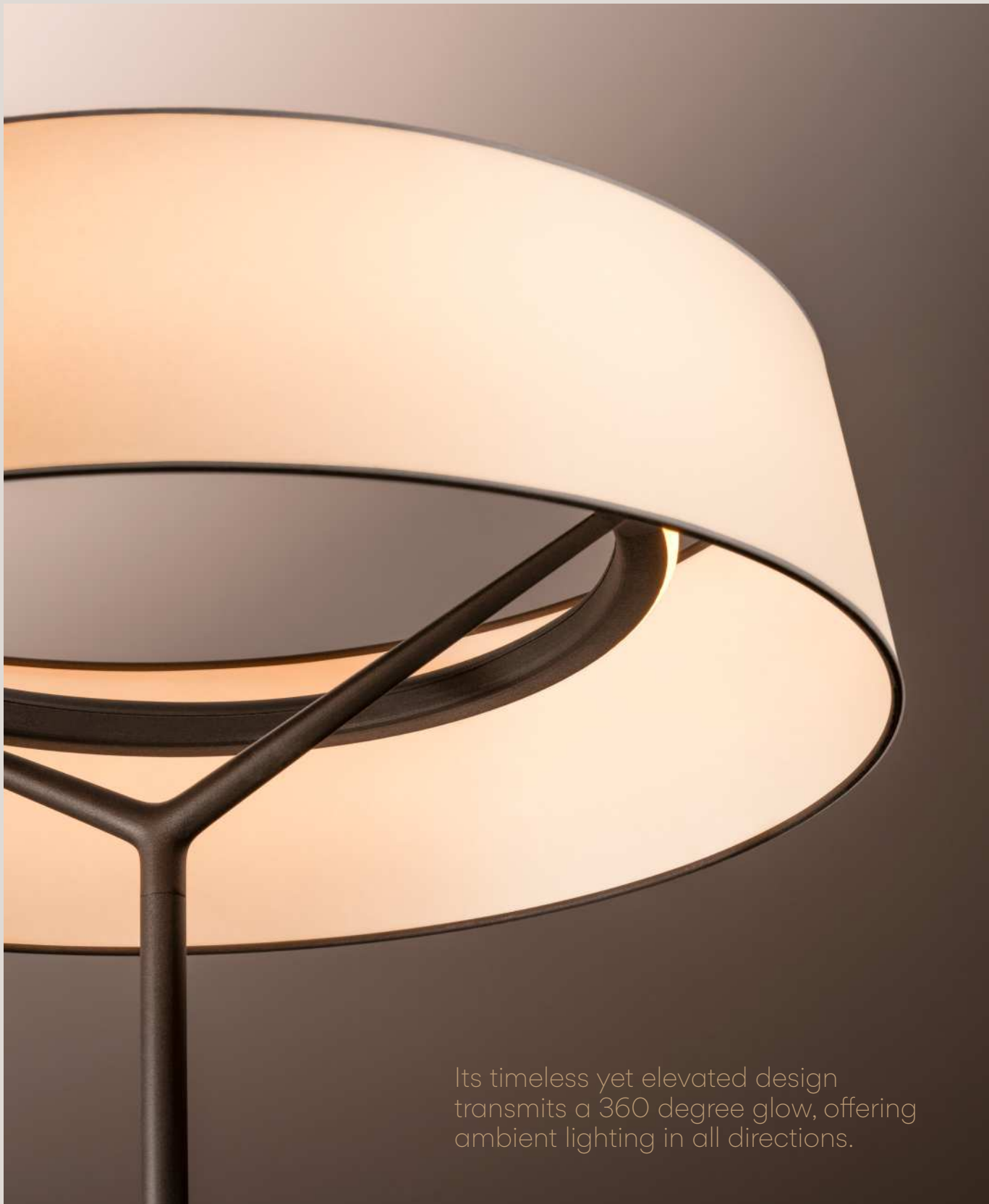

Its timeless yet elevated design transmits a 360 degree glow, offering ambient lighting in all directions.

Dama is a homage to the traditional of luminaires lamp: taking the simplicity of a traditional shade and wire frame, it softens and refines the design in form, material and source of light application. This luminaire is distinguished by an exposed aluminium structure that delimits the edge of its cylindrical shade with honest precision. A distinctive feature rather than a supporting element, the delicacy of the frame provides a feeling of weightlessness and allows the paper diffuser to seemingly float in empty space. Inside the shade, a circular LED lightsource is sealed by a silicon casing to prevent glare. This cutting-edge invisible technology subsequently radiates with a gentle, uniform glow from within. Designed for easy installation, intuitive use and maximum versatility, Dama boasts smart capabilities and dimming control, allowing users to define the perfect ambience.

- 11 Black (NCS S 8500-N)
- 25 Beige D1 (NCS S 4005-Y50R)

Tube: Steel.  
 Base: Zamak.  
 Shade: Paper.  
 Body: Aluminium.

LED 2700 K. CRI >90.  
 Table and Floor control:  
 Push,  
 Casambi.  
 Pendant control:  
 Push,  
 1-10V,  
 DALI,  
 Casambi.

**Pendant.**  
**Electrical connection options**

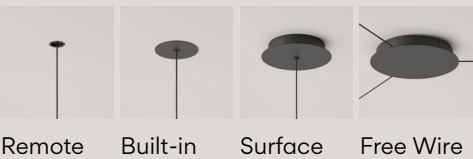

Floor switch



Table switch

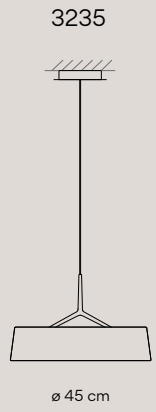
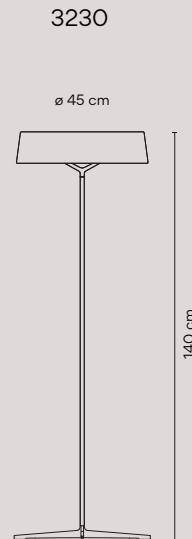

# Knit

Design by Meike Harde.

Light, materiality and tangibility collide with the Knit collection. Its texture is magnetic, calling out for us to touch its surface, to feel its warmth and to keep it close. Light seeps outwards through the fabric and downwards through a translucent screen, softening its luminosity.









While the urchin, a symbol of fertility, conceals a soft inside beneath its protective outer shell, Knit delights in the femininity and softness of its outer layer. It exudes intimacy, comfort and familiarity.













Light seeps outwards through the fabric and downwards through a translucent screen, softening its luminosity.









The Knit collection responds to the tasselled lamps of the past with contemporary craftsmanship and technical innovation.

The Knit collection consists of a series of spheres seemingly flattened, stretched or distorted by intense external pressure. While the urchin, a symbol of fertility, conceals a soft inside beneath its protective outer shell, Knit delights in the femininity and softness of its outer layer. It exudes intimacy, comfort and familiarity. The bulk of each volume is covered in stretchy thread, knitted into ribs using the plating technique. The darker ribs are opaque, tangible, while the space between the ribs is thinly knitted to transmit a diffuse, 360 degree glow. Easy installation and dimming capabilities make Knit the perfect solution for professionals looking for quality indoor lighting with an abundance of charisma.

LED 2700 K. CRI >90.  
 Pendant control:  
 DALI,  
 1-10V,  
 Casambi.  
 Floor control:  
 Push,  
 Casambi.

**Pendant.**  
**Electrical connection options**



Remote Built-in Surface Free Wire



Floor switch ref. 7480, 7485, 7487.

● 24 Beige M1 (NCS S 2005-Y50R)

Fabric Shade: Flame-retardant polyester.  
 Interior diffuser: Polyethylene.  
 Bottom diffuser: Methacrylate.  
 Diffuser ring and support: ABS.  
 Floor stemp: Iron steel.  
 Floor base: Zamak.

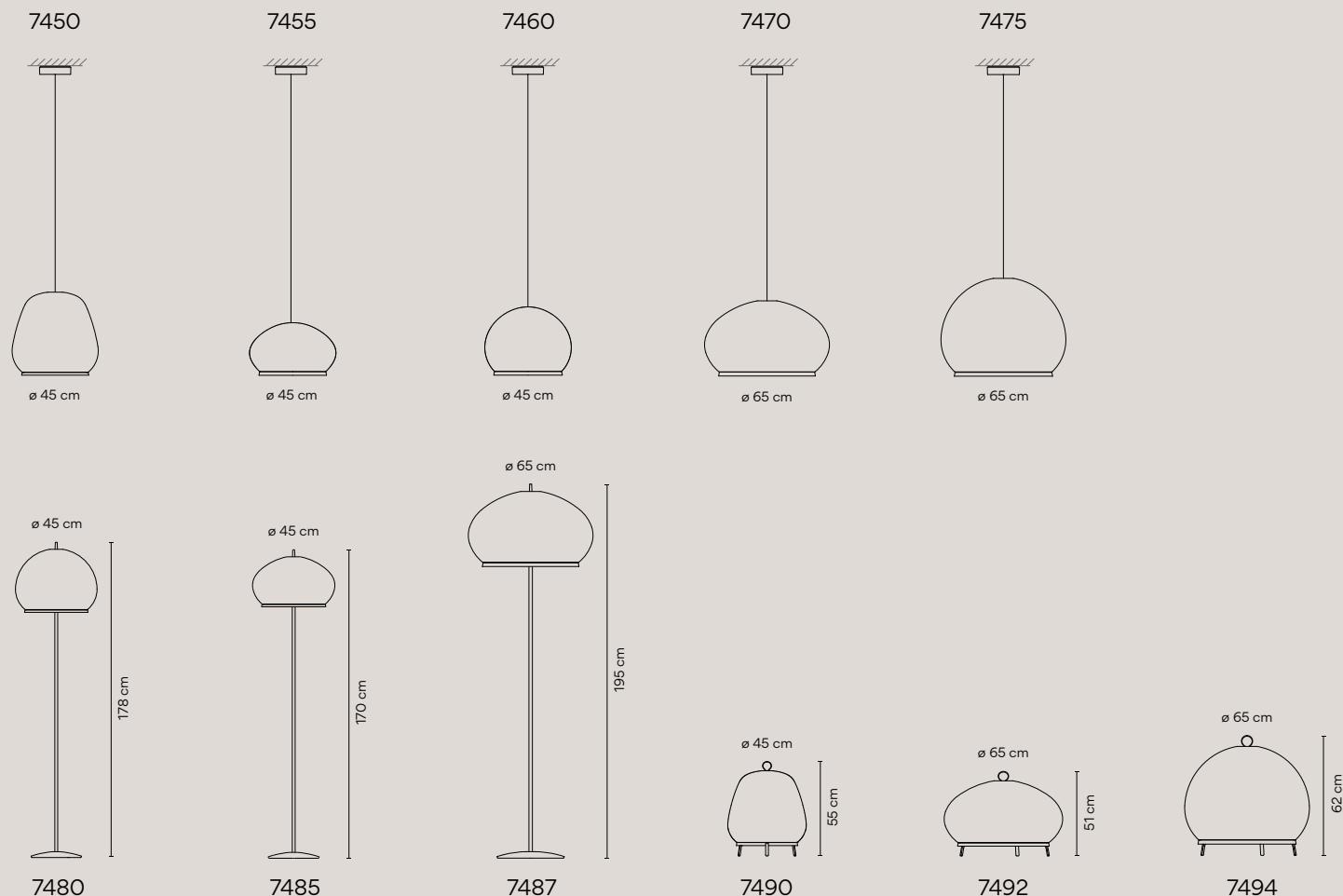

A single knitted lycra sleeve stretched over an ovoid polymer diffuser, its texture is magnetic, calling out for us to touch its surface, to feel its warmth and to keep it close.



# Spa

Design by Ramos & Bassols.

Spa is the perfect lighting solution for any wellness space. From public dressing rooms, restaurants and spas, to private kitchens, corridors and bathrooms, its graceful simplicity allows for linear lighting and seamless integration within the surrounding architecture of a variety of humid interiors.



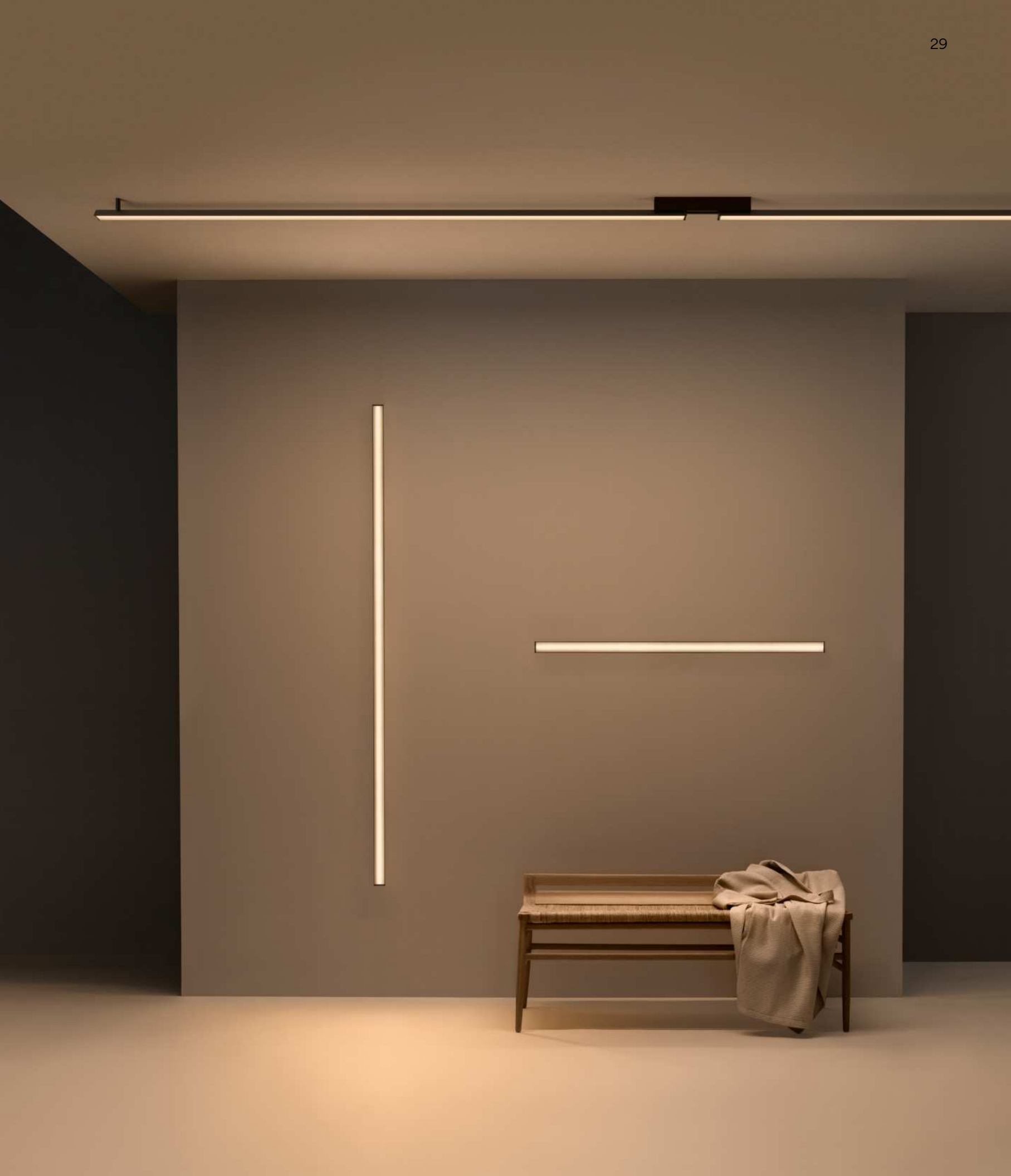



Each luminaire is separated from the wall by a single aluminium support and connects to a simple terminal, invisible from the front, which lends a sense of weightlessness and essentiality to the design.





The diffuser provides a glare-free, front diffuse light, ideal for creating an intimate atmosphere.





## Vanity light

Ideal as a bathroom mirror light fixture, Spa can be positioned at an angle to send diffuse, ambience lighting in the desired direction.



IP44. Spa can be wiped down with a wet cloth for easy maintenance







The versatility of its system allows the luminaires to be positioned in a row to illuminate up to six metres of wall or ceiling space.







Minimalist and refined in form, Spa is an adaptable system of linear LEDs that allows for limitless compositional freedom to create a broad range of atmospheres, from intimate corners for personal wellbeing to functional spaces designed for general wellness.

Particularly apt as a vanity light, it can be positioned at an angle to send diffused light in the desired direction.

Due to the subtle fluting effect of the polycarbonate, dense light tapers out from the centre towards the edges of the strip, casting an intense light without glare. The smoothness of its materiality along with the linearity of its grooves contrasts with the matte texture of the aluminium casing, offered in a range of finishings to suit diverse interior aesthetics.

- 11 Black (NCS S 8500-N)
- 23 Warm White (NCS S 0502-Y50R)
- 25 Beige D1 (NCS S 4005-Y50R)

Profile and canopy: Aluminum  
Diffuser: PMMA & Silicone

LED 2700 K. CRI >90.

LED 3500 K. CRI >90.

Control:

1-10V,

DALI,

Casambi (Remote).

IP44

VANITY LIGHT (slanted diffuser)

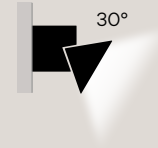

5987

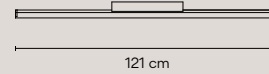

5989

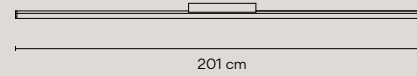

5991

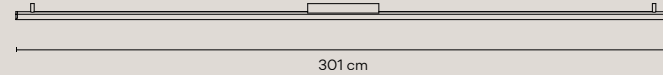

IP44, suitable for wet locations



WALL & CEILING



5975

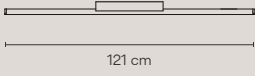

5977



5979



5981

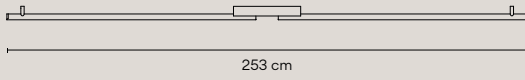

5983



5985

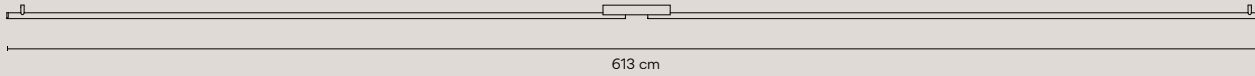

VERTICAL WALL

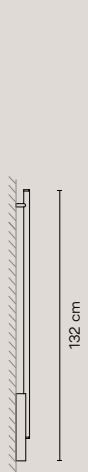
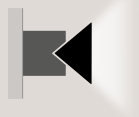

5993



5995

# Africa

Design by Francisco Gómez Paz.

An object of desire, Africa is a unique gift that combines richness of form and materiality with high performance lighting capabilities. A holistic exploration of beauty, functionality and the essence of humanity.





“Africa was born as a response to the latest ways of inhabiting, in which the hybridisation of residential and professional spaces is increasingly nomadic, free, and casual”.

Francisco Gómez Paz







Battery capacity  
10.000mAh.

Battery voltage  
3,7V.

Battery autonomy:  
6,5h at 100% Intensity.  
10h at 66% Intensity.  
20h at 33% Intensity.

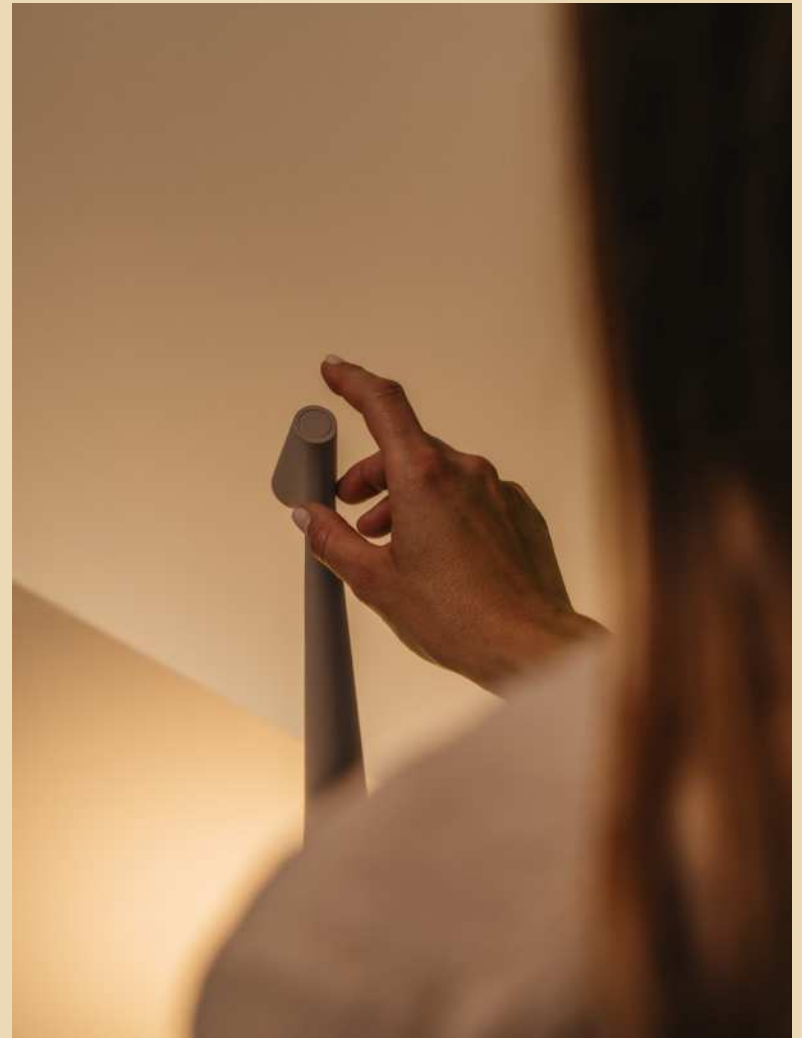

Its chargeable LED light source provides three levels of intensity which are controlled by a simple push button at the head.

To recharge the luminaire, the shaft slides seamlessly into a magnetised charger a flawless continuation of its sculptural expression.







Thanks to its high flow lighting, the Africa collection is the perfect companion for detailed task work.







Defined by a slender, conical stem that leads to a neat head, Africa invites you to reach out and grasp it. Available in two sizes, its lacquered matte texture and four natural tones bring warmth and tangibility to the design. Shaped from a single unit of pure aluminium, this mono-materiality lends it a certain weight and technical quality associated with high-end industrial processes. The ancestral, anthropological quality of its discreet silhouette will create a striking statement in any kind of space, public or residential. Its aesthetic versatility is complemented by adaptability: accent a forgotten corner, illuminate a work space, or enjoy a romantic meal with a soft glow.

- 24 Beige M1 (NCS S 2005-Y50R)
- 25 Beige D1 (NCS S 4005-Y50R)
- 29 Brown D1 (NCS S 8005-Y50R)
- 38 Terra Dark (NCS S 5040-Y70R)

Body: Aluminium.  
Diffuser: Polycarbonate.

LED 2700 K. CRI >90.  
Control:  
Push.

Portable

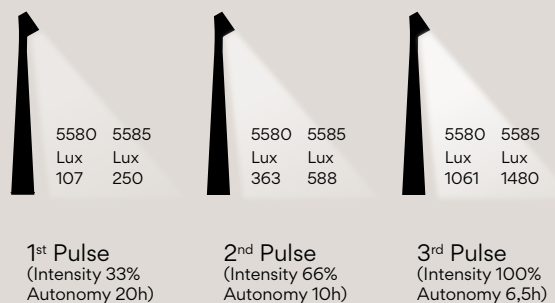
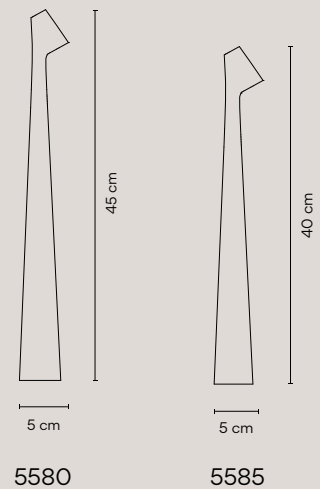

# Mayfair Mini

Design by Diego Fortunato.

The perfect lighting companion.  
A light to grab and go, the portable Mayfair Mini is powered by a rechargeable battery and can be moved exactly where needed -indoors or out- via its slender yet sturdy stem.





Intimate light,  
dedicated to you.  
Perfectly proportioned,  
the Mayfair Mini  
measures a diminutive  
38cm x 20cm and  
casts a contained  
pool of diffuse,  
downward light that  
creates an intimate  
lighting effect suitable  
for quiet moments  
of contemplation or  
cohabitation.  
A small opening  
at the top of the  
shade also emits a  
glow, balancing the  
brightness below  
by lending a subtle  
radiance to the  
stem above.

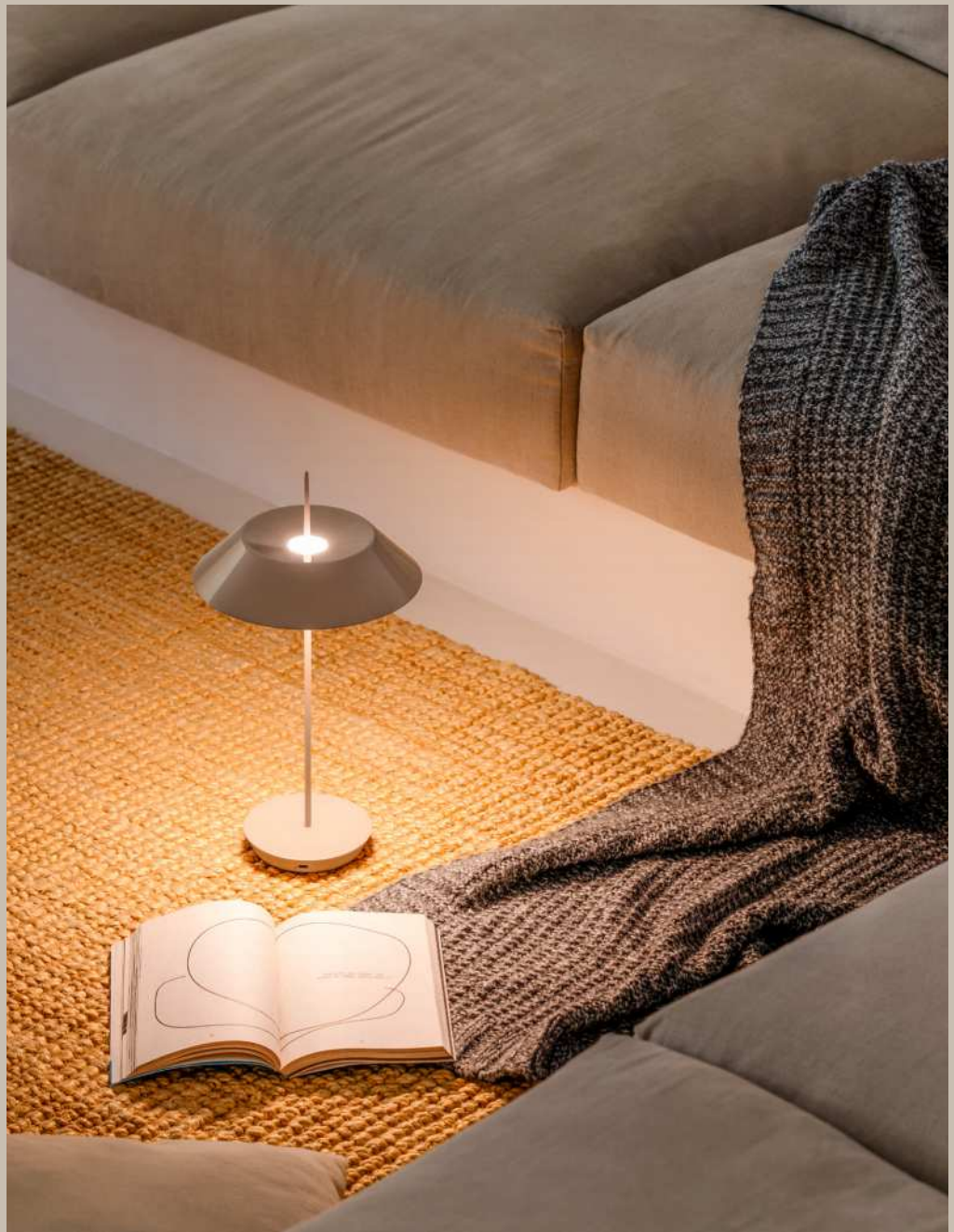













A modern reimagining of the traditional 19th-century bouillotte table lamp, the Mayfair Mini is a statement in small-scale design. Featuring an intriguing play of straight lines and curved contours, its sculptural silhouette exudes an elegant equilibrium.





Fixed luminaries for precise accentuation. Mayfair Mini can be fixed in position to illuminate specific spots, such as the lounge area of a hotel or the communal tables in a library. It comes in a choice of four Chromatica colours that radiate a warm, ambient glow: white, beige, terracotta, and green. Fresh yet familiar, its glossy finishes offer an informal juxtaposition with the fixture's refined form, lending it the versatility to suit a wide range of atmospheres.









The Mayfair Mini is offered in three formats. The portable version is perfect for indoor and outdoor use. Powered by a rechargeable battery, it can be transported to any desired position, while a push button at its base turns it on and off and controls the dimming. It also comes in two bolted versions, available either with a base and push button controls, like the portable, or with no base and available in DALI, 1-10V. The bolted formats are fixed in position, designed to integrate within the surrounding architecture.

- 23 Warm White (NCS S 0502-Y50R)
- 25 Beige D1 (NCS S 4005-Y50R)
- 37 Terra Red (NCS S 4040-Y70R)
- 47 Green L1 (NCS S 4005-G80Y)

Base and shade: Polycarbonate.  
Diffuser: Translucent polycarbonate.  
Stem: Stainless steel.

LED 2700 K. CRI >90.

Control:  
Touch sensor,  
On/ Off,  
DALI,  
1-10V.

Ref. 5495

Rechargeable battery autonomy:  
6h at 100% Intensity.  
12h at 50% Intensity.  
18h at 25% Intensity.



Touch sensor 5495 and 5496

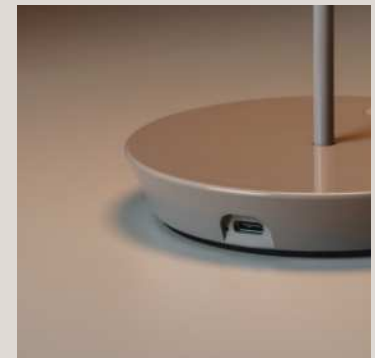

Rechargeable battery 5495

Portable

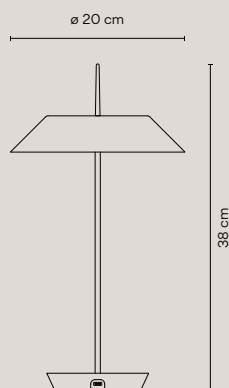

5495

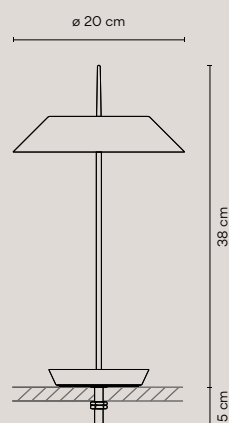

5496

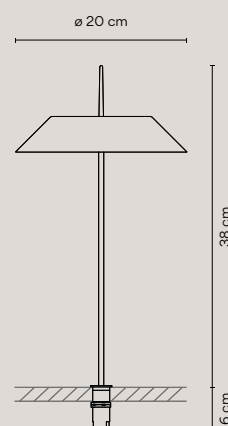

5497

# Out

Design by Víctor Carrasco.

A romantic response to the global transition to life outside, Out brings the intimacy of indoor lighting outdoors. Suitable for illuminating a table or meeting point, this luminaire emanates with a soft, diffuse downlight, its source obscured by a translucent screen.



47 Green L1





Soft, romantic and geometric.  
Out is the best option for an  
outdoor coworking area.







## Indoor & outdoor

Linking interior and exterior spaces has a significant impact on our sense of wellbeing. As we enter an era where outdoor space is becoming increasingly essential, design professionals are turning their attention towards breaking down traditional architectural barriers.



36 Soft Pink





Its slender, egalitarian structure exudes an ethereal magnetism, its cone bringing zenithal lighting al fresco.



47 Green L1









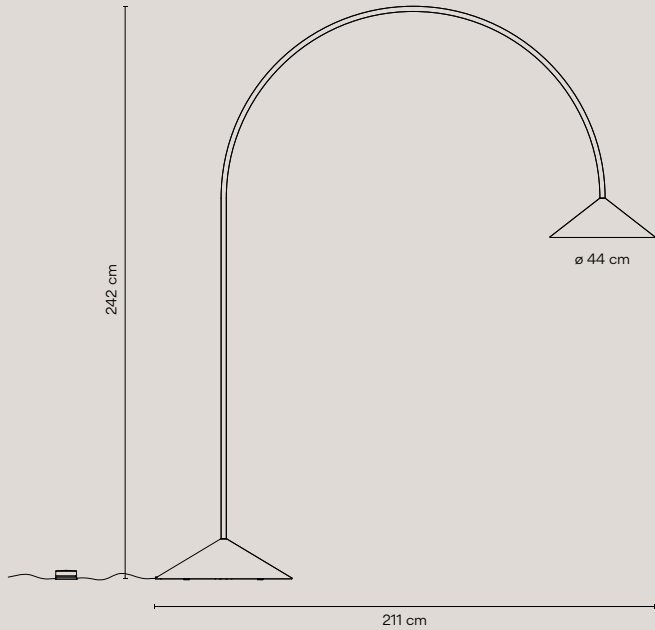

4270 Not Fixed

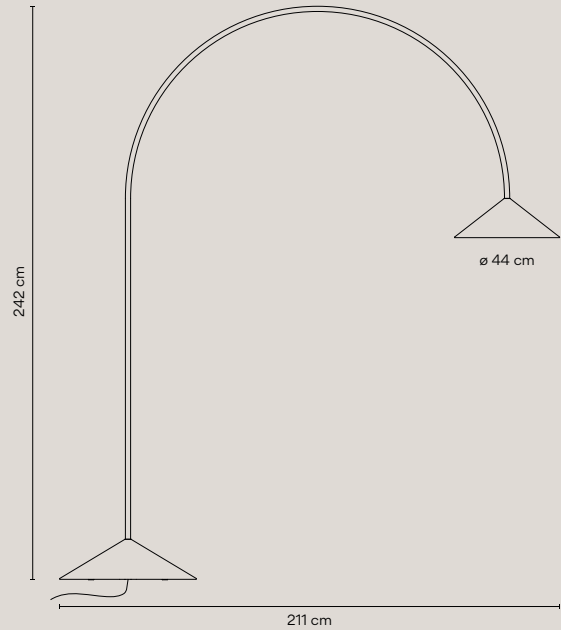

4275 Bolt-down "hard wired"

Whether for meetings, meals or socialising, illuminating an outdoor table from above is difficult to achieve, but Out knows no limits. The ultimate lighting solution for any communal space, it proves that freestanding downlighting is not only possible, but can be beautiful.

An exercise in grace and resilience, it is the high arch of the rod that makes the design so distinctive. Evocative of a flower bending with the weight of its petals in summer, it is designed to bow in response to the wind while fixed by a solid cement base.

A hidden diffuser maintains consistent quality and positioning of the light, even while the cone is moving. Forming islands of light in the darkness, Out will bring poetry to your patio. Coated in a matte finish that grants a certain tenderness, the design is enhanced by six earthy and natural tones.

- 22 Black Anthracite (NCS S 2005-Y50R)
- 23 Warm White (NCS S 0502-Y50R)
- 25 Beige D1 (NCS S 4005-Y50R)
- 36 Soft Pink (NCS S 1010-Y50R)
- 37 Terra Red (NCS S 4040-Y70R)
- 47 Green L1 (NCS S 4005-G80Y)

Tube: Stainless Steel.  
Shade: Aluminium.  
Diffuser: Poliethylene.

LED 2700 K. CRI >90.

Control 4270:  
Push,  
Casambi.  
Control 4275:  
DALI,  
Casambi (Remote).

IP65



4270. Cable with switch.







# Break Plus

Design by Xuclà.

Defined by an instinctual connection to the landscape and surrounding architecture, Break Plus converts any wall into a three dimensional mural, casting diffuse, indirect light upwards, downwards or in both directions.



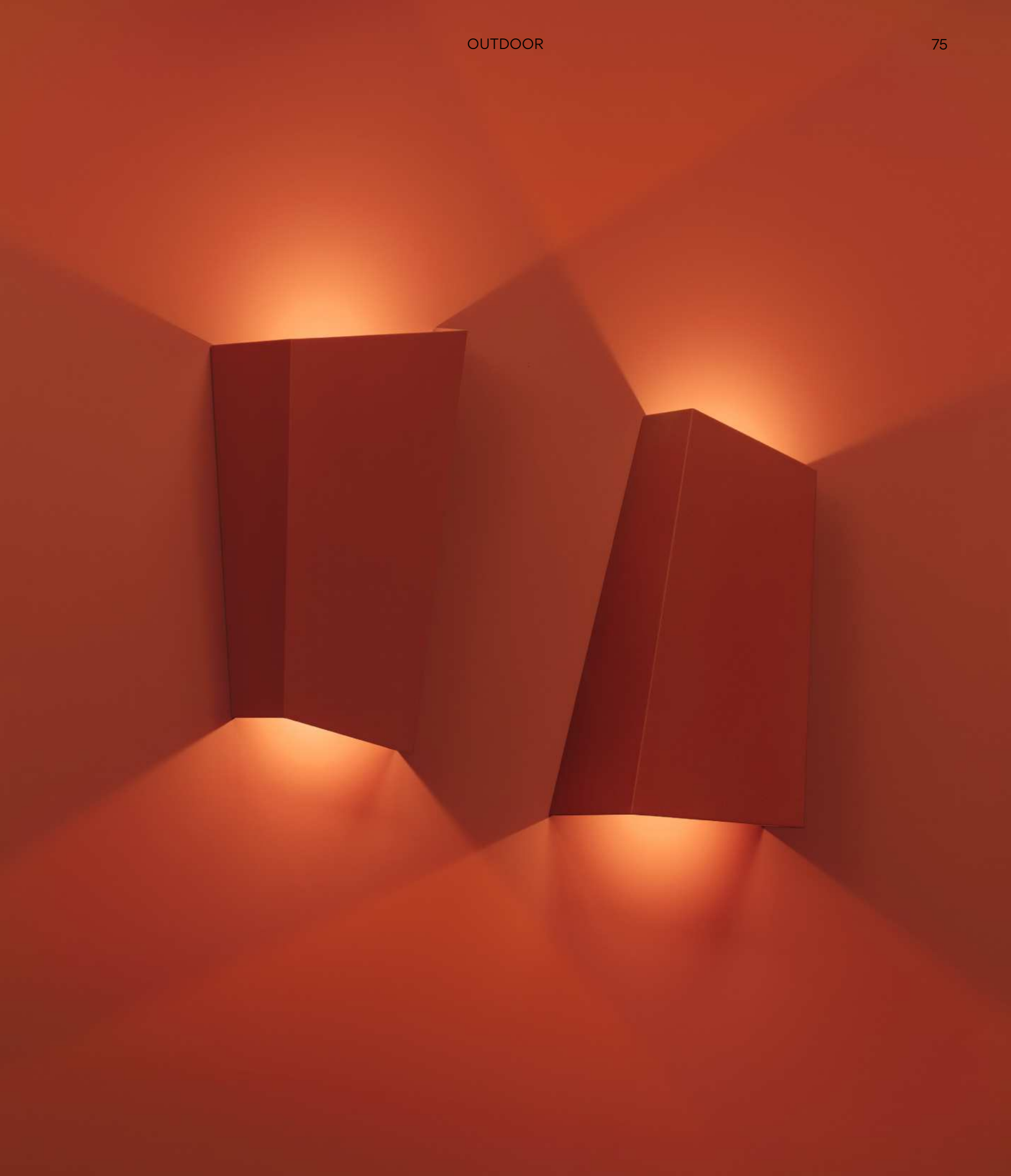



Perfectly blending in any vertical surface in the open air, Break Plus can interact with other wall luminaires casting pathway lighting downwards.





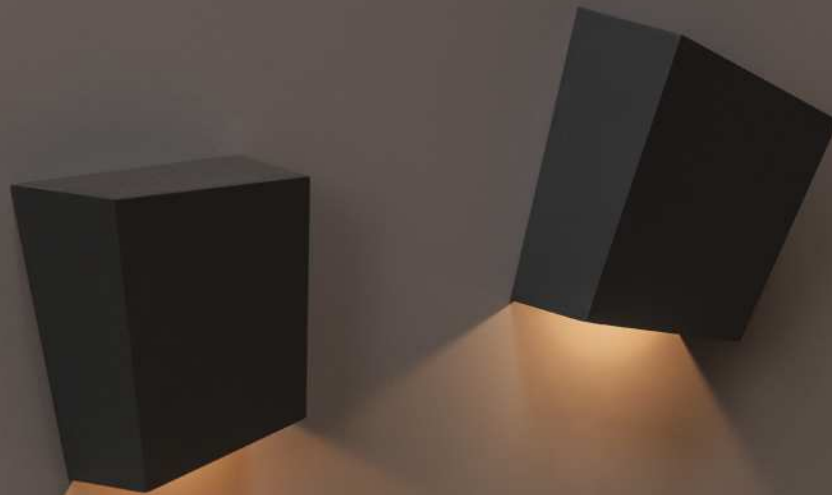

Characterised by its stylized silhouette and available in four muted Chromatica colours, these playful units display an ethereal lighting effect on the wall.







A singular study in technique and high performance, Break Plus is opened at its top and bottom to withstand all weather and to prevent water from stagnating.





Break Plus is evocative of a roof tile or brick, designed individually to connect as a whole. Integrating into the architecture of any space, the collection presents five geometric models that provide spatial depth and aesthetic plasticity to an otherwise flat surface. When grouped together, the collection creates a dynamic dialogue between light and shadow: light is reflected from the interior of each volume, drawing a single or double or beam across the wall, which merge to establish a lattice of oblique lines. Easily installed and with on/ off, Dali and Casambi control systems, systems, its lacquered matte finish adds a hint of graininess that complements its geometric form.

- 22 Black Anthracite (NCS S 8000-N)
- 25 Beige D1 (NCS S 4005-Y50R)
- 37 Terra Red (NCS S 4040-Y70R)
- 95 Primer (NCS S 1000-N)

Body: Aluminium.  
Diffuser: Polycarbonate.

LED 2700 K, CRI >90  
LED 3500 K, CRI >90  
Control:  
On/ Off,  
DALI (Remote),  
Casambi (Remote).

IP65

Primer finish: customisable on site. Break Plus is offered in a primer tone, which allows for seamless integration within the surrounding architecture and adaptation to the project needs as it can be painted in any desired colour.

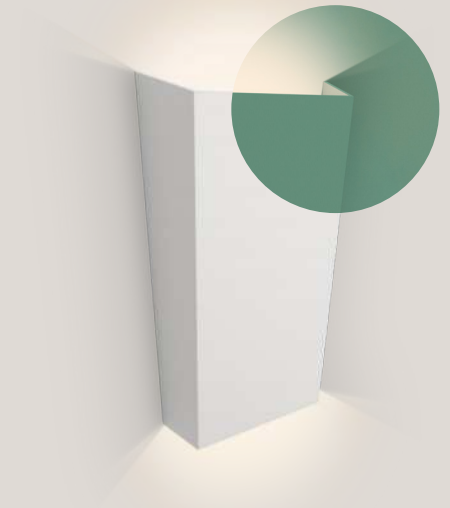

4112

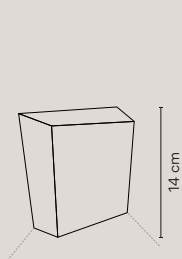

4114

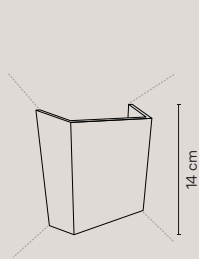

4116

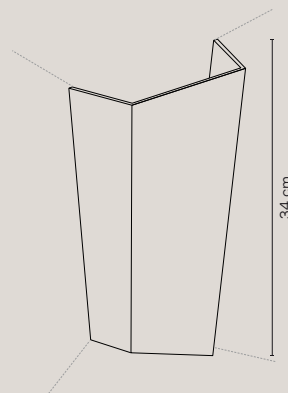

4118



# Dots Outdoor

Design by Martín Azúa.

Easily mistaken for a stone during the day, this fixture is designed to nestle into the undergrowth of a garden or amongst the potted plants of a patio. Dots Outdoor shines at night with a low, diffuse or focused glow, the source of which is invisible from almost any angle.











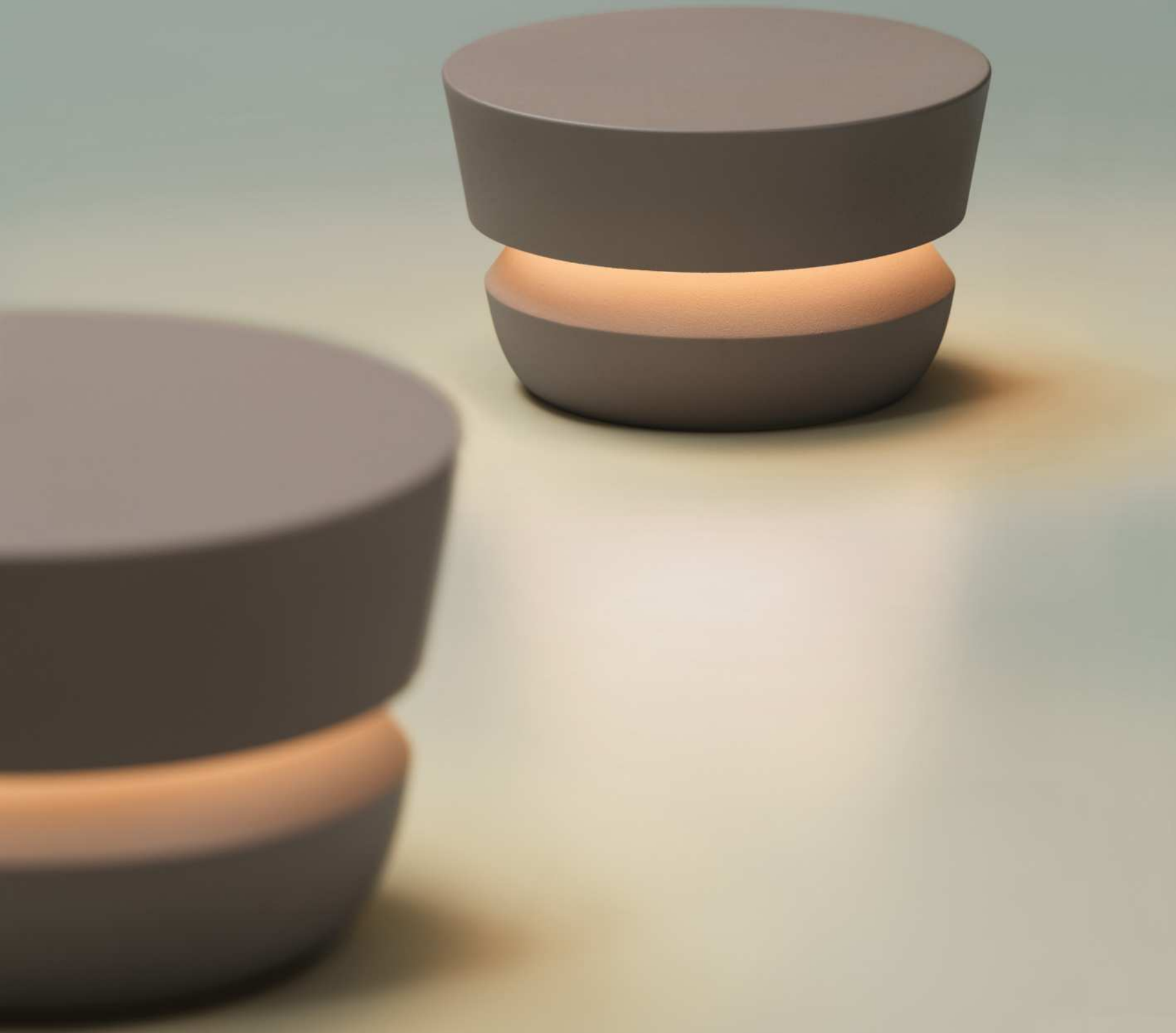















Diminutive, compact and easily integrated into any garden, Dots Outdoor is the perfect solution for a range of exterior low lighting needs. Rather than drawing your eye away from the surrounding vegetation, it becomes a part of it, its soft, natural shades blending effortlessly among plants or gravel. Planted as a single star in the darkness, or combined to create a celestial medley of light, it is as versatile and playful as its indoor counterpart. Each luminaire is carved with a rounded opening that reflects light from an internal source, creating a halo of ambient light like a radiant crown. The other side is closed, allowing the designer to play with the direction of light and ease any intensity.

- 22 Black Anthracite (NCS S 8000-N)
- 25 Beige D1 (NCS S 4005-Y50R)
- 53 Green M1 (NCS S 6005-G80Y)

Body: Aluminium.  
Diffuser: Polycarbonate.

LED 2700 K, CRI >90

Control:  
On/ Of,  
DALI (Remote),  
Casambi (Remote).

IP65

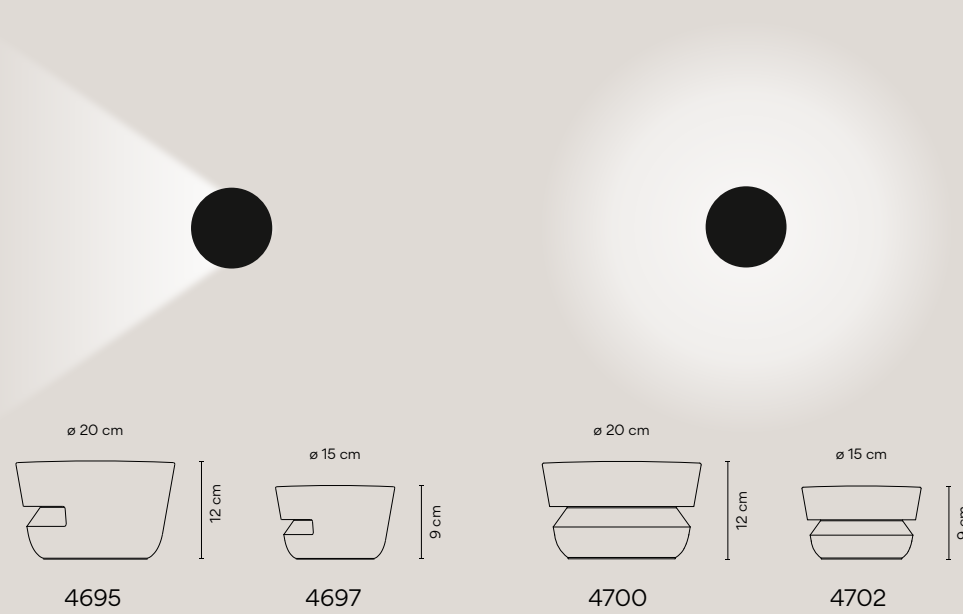
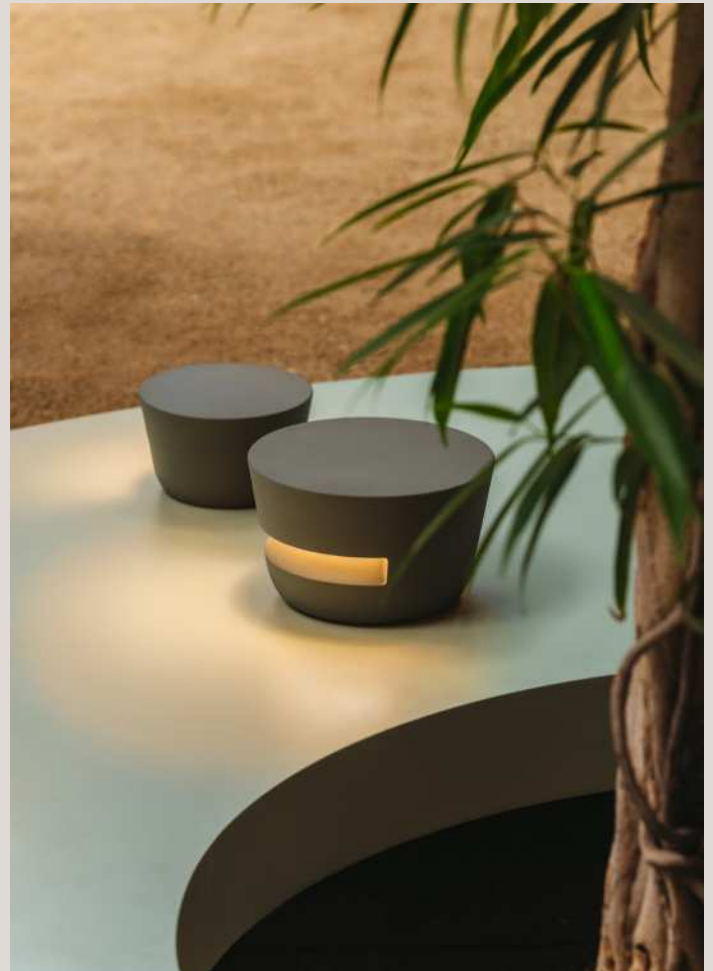



# Class

Design by Sebastian Herkner.

Timeless, elegant and enduring, Class brings the refined, intimate aesthetic of a patio light with the functional performance of a bollard. Rather than silently integrating into the garden environment, it stands handsome and proud, its cylindrical glass luminaire radiating with a soft, diffuse light.



















“Class emphasizes its architectural elegance in its vertical metal structure, as well as the soft waves in the borosilicate glass tube. The structured glass spreads the light in a soft patterned way on the facade, the terrace and the greenery around”.

Sebastian Herkner





















Class's translucent glass tube is fluted, defined by even grooves that allow the light to pass softly through it while the source remains obscured.





Class's translucent glass tube is fluted, defined by even grooves that allow the light to pass softly through it while the source remains obscured. Each tube is supported by a robust aluminium shaft, available in two different heights and with a choice of individual, multiple or asymmetrical luminaires. The matte black of the shaft contrasts with the smooth surface of the glass tubes, a satisfying combination of textures reminiscent of the traditional gas lamp. Designed to give a little sway with the breeze, the taller free standing shaft bathes a wide area of exterior space in its warm glow. In response, the shorter model projects a soft transition radiance from below.

● 11 Black (NCS S 8500-N)

Body: Aluminium.  
Glass: Borosilicate glass.  
Diffuser: Opal polycarbonate.

LED 2700 K. CRI >90.

Control:  
DALI,  
Push,  
Casambi (Remote).

IP65



Forming a delicate H, the metal starts to curve at its peak, enclosing the tube from above and below with gentle precision.

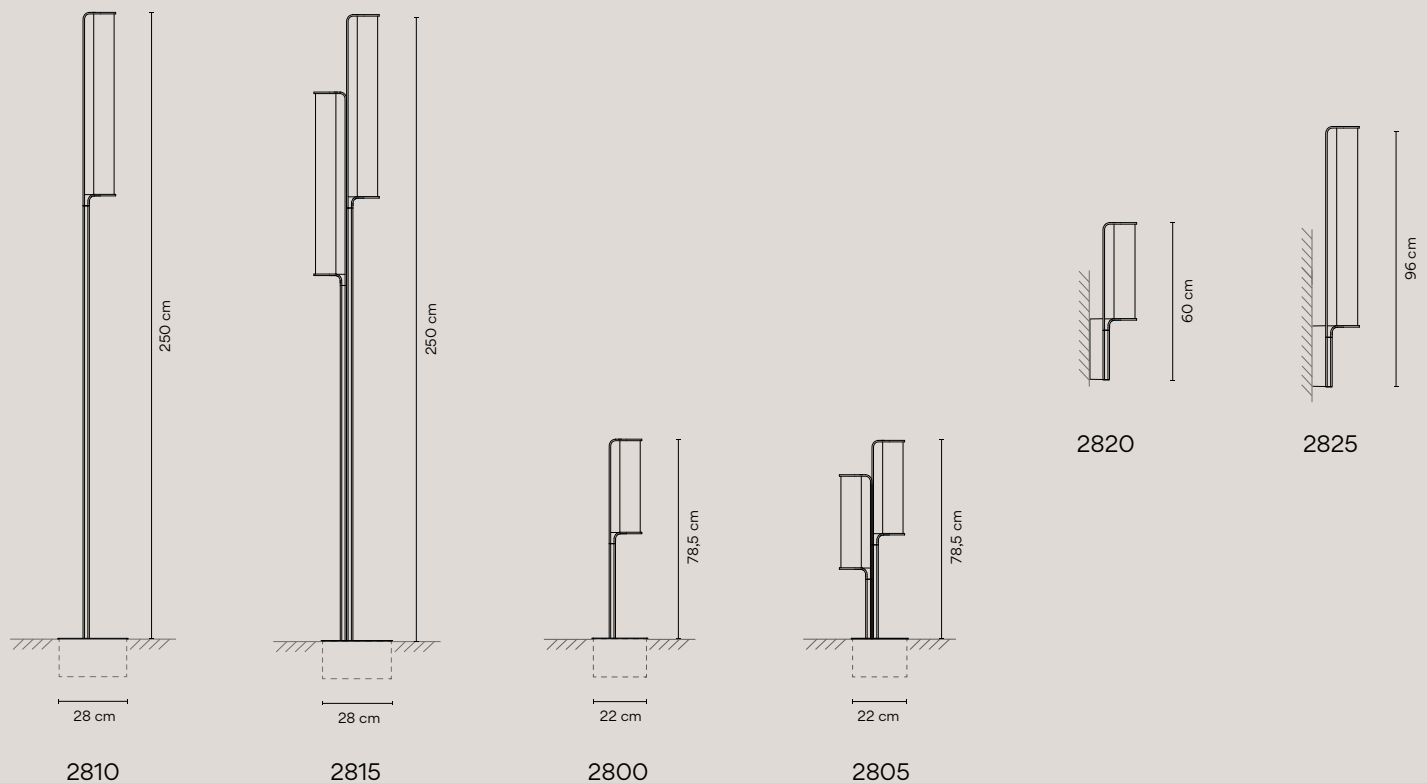

# Composing Pendants

Seamless connection,  
unlimited creativity

Vibia's new installation and connection systems offer complete creative freedom, inviting designers to create personalised compositions adapted to specific lighting requirements.









### Algorithm

0820



### Skam

0270



### Flat

5935



### Slim

0920



### Halo Jewel

2350 2351 2355



### Tempo

5770 5772 5774



### Mayfair

5220 5525



### Tube

6160 6165

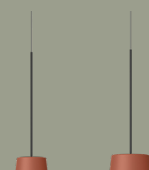

### North

5660 5662 5664

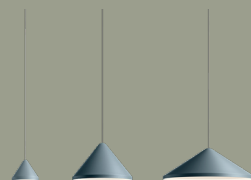

### Wireflow

0345 0361

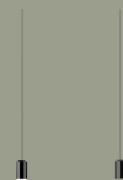



Find your collection at [vibia.com](http://vibia.com)  
and compose your pendant.

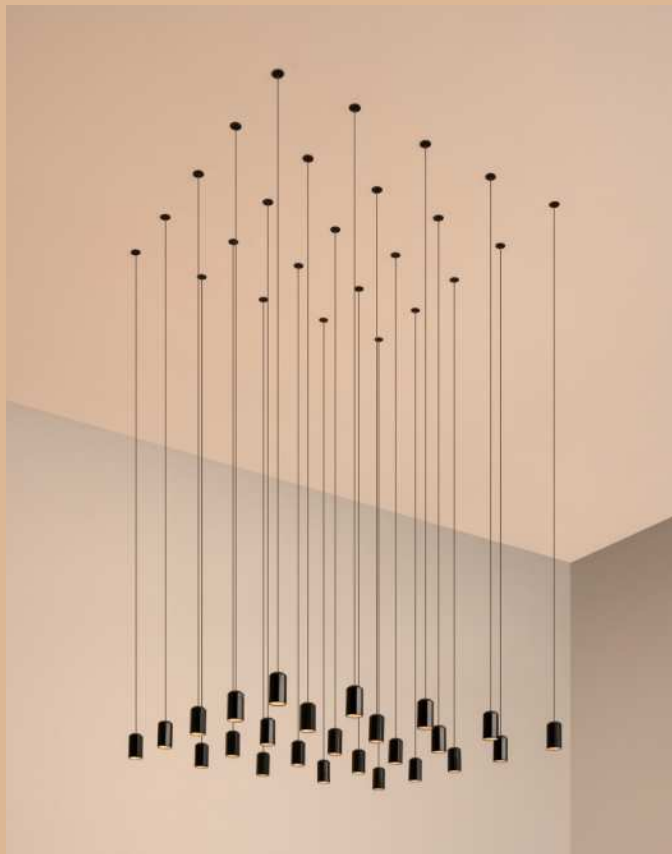

Unlimited by the restraints of traditional electrical systems, a single luminaire can flow freely through space or multiple pendants can be suspended at will, linked to a single point of connection.







Every Vibia single pendant is now offering four electrical connection options (remote, built-in, surface, free wire) promising to bring beauty, harmony and a sense of wellbeing to any interior and type of ceiling.

COMPOSING PENDANTS





Remote  
ø 3 cm

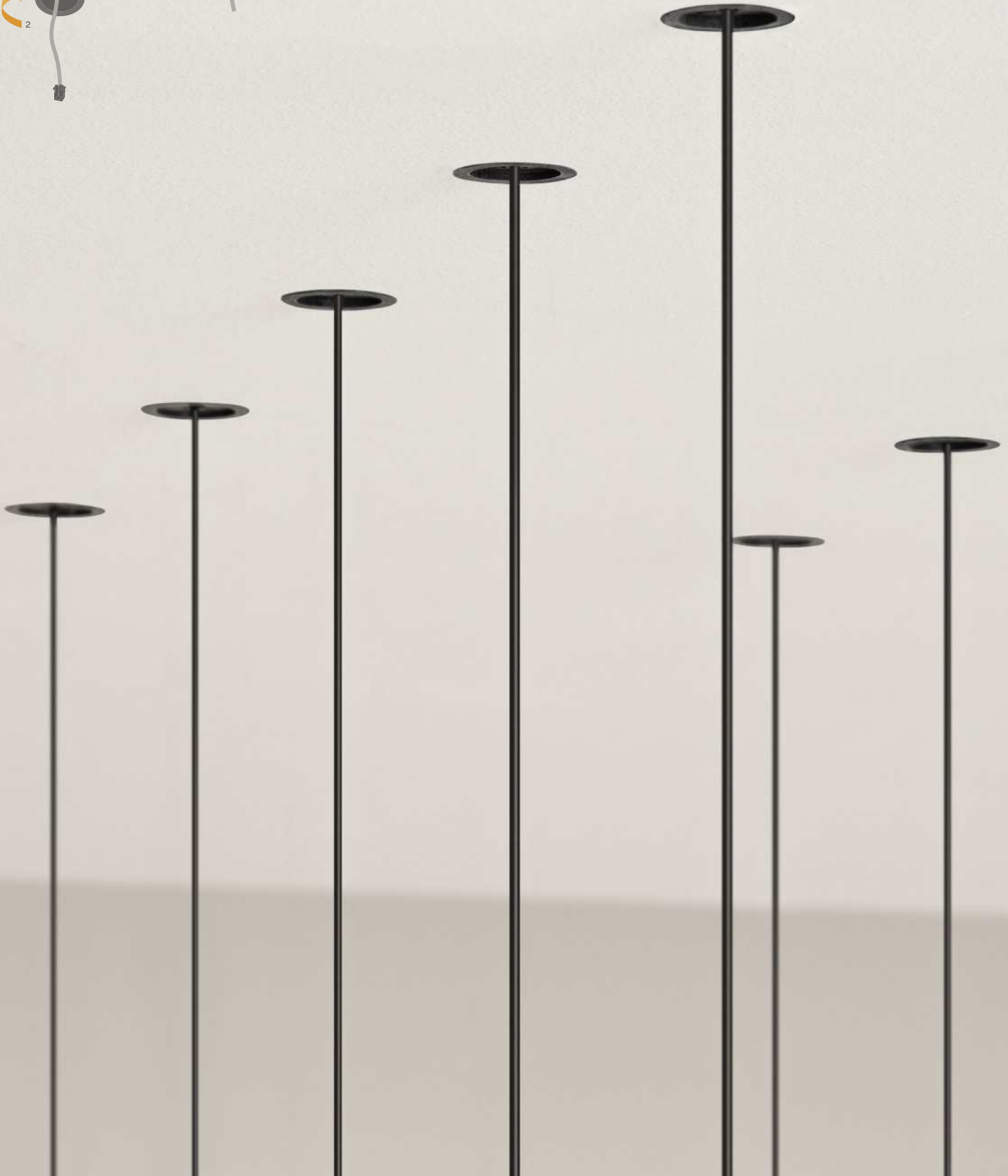
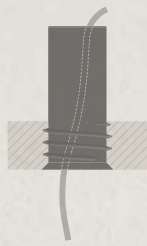
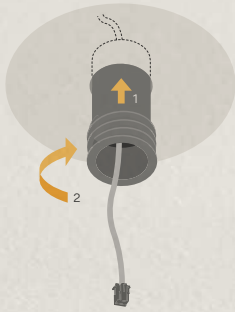



The new systems guarantee easy installation, simple maintenance and seamless integration, no matter how unique the architecture.

Compose your pendant at [vibia.com](http://vibia.com) and select your preferred electrical connection solution.

Designers can explore a range of connection options using our innovative online compositor tool, which calculates the minimum number of drivers required depending on each composition and provides a customised installation manual according to the design.

Furthermore, Vibia offers support throughout the whole process, from design and composition to installation and use.



### Drop ceiling

The innovative remote and built-in fittings accentuate the silkiness and lightness of compositions on suspended ceilings, its great visual grandeur taking center stage.

**Remote**  
ø 3 cm or 6 cm



**Built-in**  
8 cm

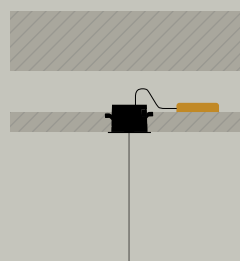
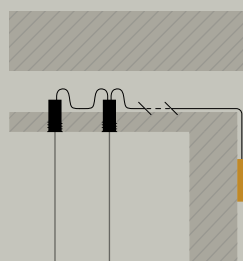



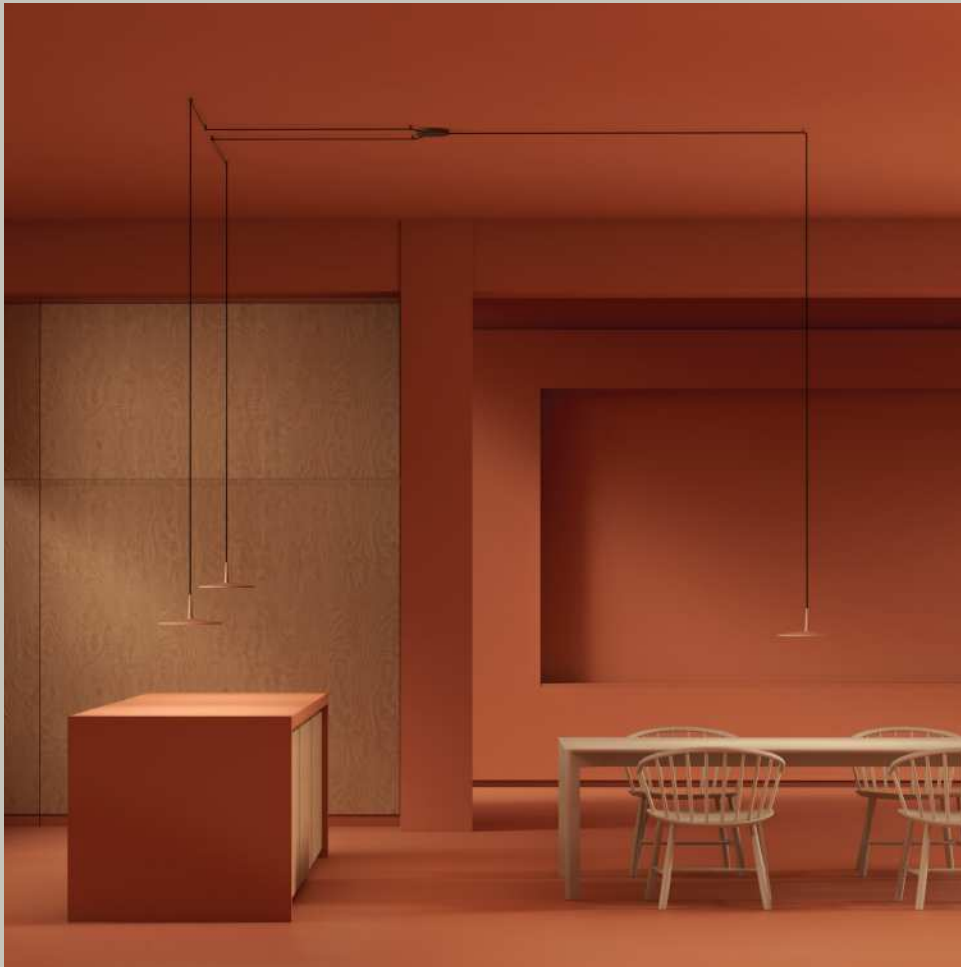

## Regular ceiling

When architecture does not allow for performance, surface and free wire showcase possibilities for any need or desire with no limits, ideal for both individual or cluster arrangements.

### Surface

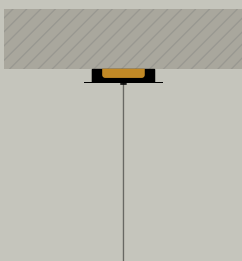

### Free Wire

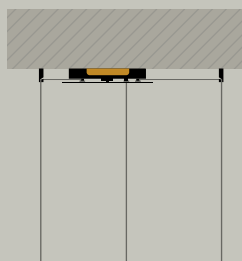
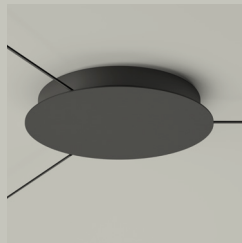

You can choose the finish of the canopy among black, white or any colour matching one of the pendants.



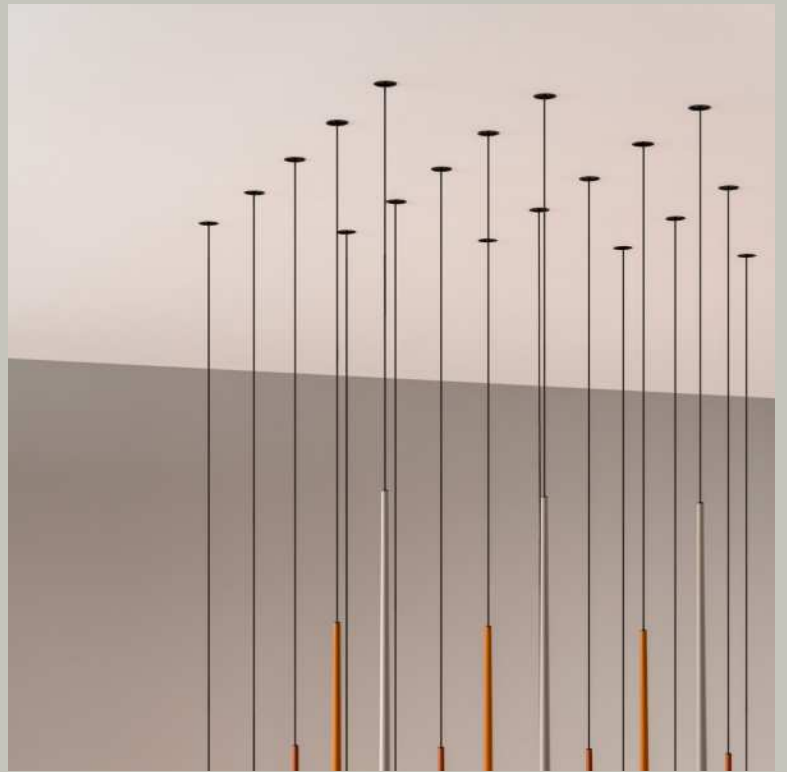



Detailed product information

# Dama

Ludovica+Roberto Palomba

Table Floor Pendant



## 3225

1 x LED STRIP 16,2W 900 mA.

LED 2700 K. CRI >90. 1850 lm. 120 lm/W.

Driver Constant Voltage 24V. 100~240V. 50/60Hz.

Control:

Push

Casambi

Tube: Steel.

Base: Zamak.

Shade: Paper.

Net weight 1,8 Kg.

3225 11 Black (NCS S 8500-N)

3225 25 Beige D1 (NCS S 4005-Y50R)

## 3230

1 x LED STRIP 16,2W 900 mA.

LED 2700 K. CRI >90. 1850 lm. 120 lm/W.

Driver Constant Voltage 24V. 100~240V. 50/60Hz.

Control:

Push

Casambi

Tube: Steel.

Base: Zamak.

Shade: Paper.

Net weight 2,55 Kg.

3230 11 Black (NCS S 8500-N)

3230 25 Beige D1 (NCS S 4005-Y50R)

## 3235

1 x LED STRIP 16,2W 900 mA.

LED 2700 K. CRI >90. 1850 lm. 120 lm/W.

Driver Constant current 900 mA. 110~240V. 50/60Hz.

Control:

DALI,

1-10V + Push,

Casambi.

Body: Aluminium.

Shade: Paper.

Net weight 1,6 Kg.

3235 11 Black (NCS S 8500-N)

3235 25 Beige D1 (NCS S 4005-Y50R)

### Electrical connection options

Remote, Built In, Surface, Free Wire.

# Knit

Design by Meike Harde.

---

Pendant

7450 p. 26



ø 45 cm

7455 p. 26

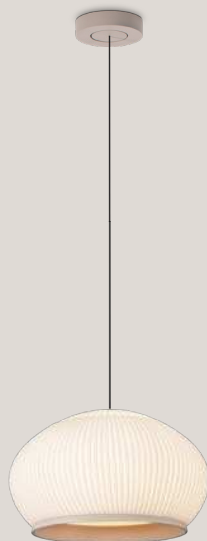

ø 45 cm

7460 p. 26

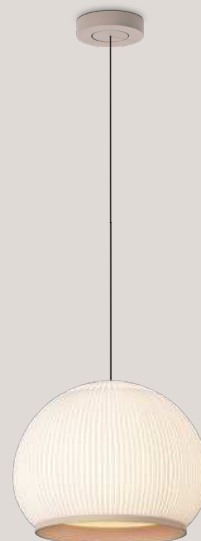

ø 45 cm

7470 p. 26



ø 65 cm

7475 p. 26



ø 65 cm

---



**7450**

6 x LED 5,9W 350 mA.

LED 2700 K. CRI >90. 4752 lm. 198 lm/W. 

Driver Constant Current 1050 mA. 110~240V 50/60Hz.

**Control:**DALI,  
1-10V,  
Casambi.**Electrical connection options**Remote, Built In,  
Surface, Free Wire.

Fabric Shade: Flame-retardant polyester.

Interior diffuser: Polyethylene.

Bottom diffuser: Methacrylate.

Diffuser ring and support: ABS.

DiffNet weight 3,7 Kg.

**7450 24** Beige M1 (NCS S 2005-Y50R)     **7455**

6 x LED 5,9W 350 mA.

LED 2700 K. CRI >90. 4752 lm. 198 lm/W. 

Driver Constant Current 1050 mA. 110~240V 50/60Hz.

**Control:**DALI,  
1-10V,  
Casambi.**Electrical connection options**Remote, Built In,  
Surface, Free Wire.

Fabric Shade: Flame-retardant polyester.

Interior diffuser: Polyethylene.

Bottom diffuser: Methacrylate.

Diffuser ring and support: ABS.

Net weight 3,4 Kg.

**7455 24** Beige M1 (NCS S 2005-Y50R)     **7460**

6 x LED 5,9W 350 mA.

LED 2700 K. CRI >90. 4752 lm. 198 lm/W. 

Driver Constant Current 1050 mA. 110~240V 50/60Hz.

**Control:**DALI,  
1-10V,  
Casambi.**Electrical connection options**Remote, Built In,  
Surface, Free Wire.

Fabric Shade: Flame-retardant polyester.

Interior diffuser: Polyethylene.

Bottom diffuser: Methacrylate.

Diffuser ring and support: ABS.

Net weight 3,2 Kg.

**7460 24** Beige M1 (NCS S 2005-Y50R)     **7470**

6 x LED 6,7W 400 mA.

LED 2700 K. CRI >90. 4752 lm. 198 lm/W. 

Constant Current 1200 mA. 110~240V 50/60Hz.

**Control:**DALI,  
1-10V,  
Casambi.**Electrical connection options**Remote, Built In,  
Surface, Free Wire.

Fabric Shade: Flame-retardant polyester.

Interior diffuser: Polyethylene.

Bottom diffuser: Methacrylate.

Diffuser ring and support: ABS.

Net weight 4,9 Kg.

**7470 24** Beige M1 (NCS S 2005-Y50R)     **7475**

6 x LED 6,7W 400 mA.

LED 2700 K. CRI >90. 4752 lm. 198 lm/W. 

Constant Current 1200 mA. 110~240V 50/60Hz.

**Control:**DALI,  
1-10V,  
Casambi.**Electrical connection options**Remote, Built In,  
Surface, Free Wire.

Fabric Shade: Flame-retardant polyester.

Interior diffuser: Polyethylene.

Bottom diffuser: Methacrylate.

Diffuser ring and support: ABS.

Net weight 5,6 Kg.

**7475 24** Beige M1 (NCS S 2005-Y50R)     

Floor



7480 p.26



7485 p.26

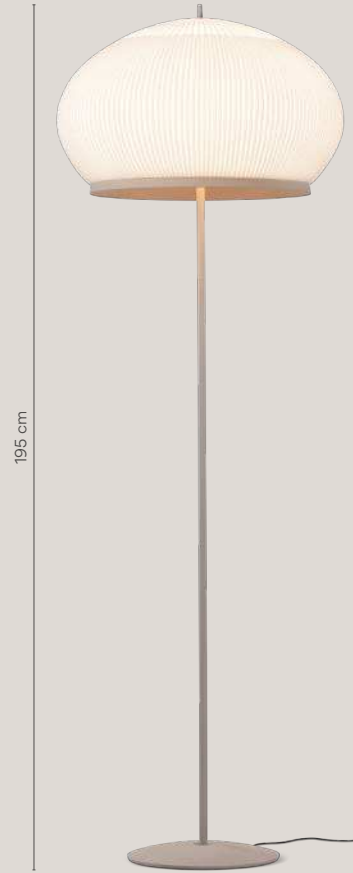

7487 p.26



7490 p.26



7492 p.26



7494 p.26

<p><b>7480</b> 6 x LED 5,9W 350 mA. <b>LED</b> 2700 K. CRI &gt;90. 4752 lm. 198 lm/W.  Constant Voltage 42V 1,43 mA. 110~240V 50/60Hz. <b>Control:</b> Push, Casambi.</p>	<p>Fabric Shade: Flame-retardant polyester. Interior diffuser: Polyethylene. Bottom diffuser: Methacrylate. Diffuser ring and support: ABS. Floor stemp: Iron steel. Floor base: Zamak. Net weight 11,3 Kg.</p>	<p><b>7480 24</b> Beige M1 (NCS S 2005-Y50R) </p> <p>    </p>
<p><b>7485</b> 6 x LED 5,9W 350 mA. <b>LED</b> 2700 K. CRI &gt;90. 4752 lm. 198 lm/W.  Constant Voltage 42V 1,43 mA. 110~240V 50/60Hz. <b>Control:</b> Push, Casambi.</p>	<p>Fabric Shade: Flame-retardant polyester. Interior diffuser: Polyethylene. Bottom diffuser: Methacrylate. Diffuser ring and support: ABS. Floor stemp: Iron steel. Floor base: Zamak. Net weight 17,7 Kg.</p>	<p><b>7485 24</b> Beige M1 (NCS S 2005-Y50R) </p> <p>    </p>
<p><b>7487</b> 6 x LED 5,9W 350 mA. <b>LED</b> 2700 K. CRI &gt;90. 4752 lm. 198 lm/W.  Constant Voltage 42V 1,43 mA. 110~240V 50/60Hz. <b>Control:</b> Push, Casambi.</p>	<p>Fabric Shade: Flame-retardant polyester. Interior diffuser: Polyethylene. Bottom diffuser: Methacrylate. Diffuser ring and support: ABS. Floor stemp: Iron steel. Floor base: Zamak. Net weight 18,5 Kg.</p>	<p><b>7487 24</b> Beige M1 (NCS S 2005-Y50R) </p> <p>    </p>
<p><b>7490</b> 6 x LED 5,9W 350 mA. <b>LED</b> 2700 K. CRI &gt;90. 4752 lm. 198 lm/W.  Constant Voltage 42V 1,43 mA. 110~240V 50/60Hz. <b>Control:</b> Push, Casambi.</p>	<p>Fabric Shade: Flame-retardant polyester. Interior diffuser: Polyethylene. Bottom diffuser: Methacrylate. Diffuser ring and support: ABS. Net weight 3,3 Kg.</p>	<p><b>7490 24</b> Beige M1 (NCS S 2005-Y50R) </p> <p>    </p>
<p><b>7492</b> 6 x LED 5,9 W 350 mA. <b>LED</b> 2700 K. CRI &gt;90. 4752 lm. 198 lm/W.  Constant Voltage 42V 1,43 mA. 110~240V 50/60Hz. <b>Control:</b> Push, Casambi.</p>	<p>Fabric Shade: Flame-retardant polyester. Interior diffuser: Polyethylene. Bottom diffuser: Methacrylate. Diffuser ring and support: ABS. Net weight 4,5 Kg.</p>	<p><b>7492 24</b> Beige M1 (NCS S 2005-Y50R) </p> <p>    </p>
<p><b>7494</b> 6 x LED 5,9 W 350 mA. <b>LED</b> 2700 K. CRI &gt;90. 4752 lm. 198 lm/W.  Constant Voltage 42V 1,43 mA. 110~240V 50/60Hz. <b>Control:</b> Push, Casambi.</p>	<p>Fabric Shade: Flame-retardant polyester. Interior diffuser: Polyethylene. Bottom diffuser: Methacrylate. Diffuser ring and support: ABS. Net weight 5,9 Kg.</p>	<p><b>7494 24</b> Beige M1 (NCS S 2005-Y50R) </p> <p>    </p>



# Spa

Design by Ramos & Bassols.

## Ceiling Wall



5975 p. 39



5977 p. 39



5979 p. 39

### 5975

1 x LED STRIP 10,8 W 600 mA.   
 LED 2700 K. 1560 lm. 144 lm/W.  
 LED 3500 K. 1920 lm. 178 lm/W.  
 Driver Constant Current 600 mA. 220~240V. 50/60Hz.  
**Control:**  
 DALI,  
 1-10V,  
 Casambi (Remote).

Profile: Aluminum.  
 Diffuser: PMMA & Silicone.  
 Canopy: Aluminum.  
 Net weight 1,6 Kg.

5975 11 Black (NCS S 8500-N) 

5975 23 Warm White (NCS S 0502-Y50R) 

5975 25 Beige D1 (NCS S 4005-Y50R) 

      Dimmer

### 5977

1 x LED STRIP 21,6 W 600 mA.   
 LED 2700 K. CRI >90. 2560 lm. 119 lm/W.  
 LED 3500 K. CRI >90. 3360 lm. 156 lm/W.  
 Driver Constant Current 600 mA. 220~240V. 50/60Hz.  
**Control:**  
 DALI,  
 1-10V,  
 Casambi (Remote).

Profile: Aluminum.  
 Diffuser: PMMA & Silicone.  
 Canopy: Aluminum.  
 Net weight 2,6 Kg.

5977 11 Black (NCS S 8500-N) 

5977 23 Warm White (NCS S 0502-Y50R) 

5977 25 Beige D1 (NCS S 4005-Y50R) 

      Dimmer

### 5979

1 x LED STRIP 32,4 W 600 mA.   
 LED 2700 K. CRI >90. 3840 lm. 119 lm/W.  
 LED 3500 K. CRI >90. 5040 lm. 156 lm/W.  
 Driver Constant Current 600 mA. 220~240V. 50/60Hz.  
**Control:**  
 DALI,  
 1-10V,  
 Casambi (Remote).

Profile: Aluminum.  
 Diffuser: PMMA & Silicone.  
 Canopy: Aluminum.  
 Net weight 3,6 Kg.

5979 11 Black (NCS S 8500-N) 

5979 23 Warm White (NCS S 0502-Y50R) 

5979 25 Beige D1 (NCS S 4005-Y50R) 

      Dimmer

Ceiling Wall



5981 p. 39

5983 p. 39

5985 p. 39

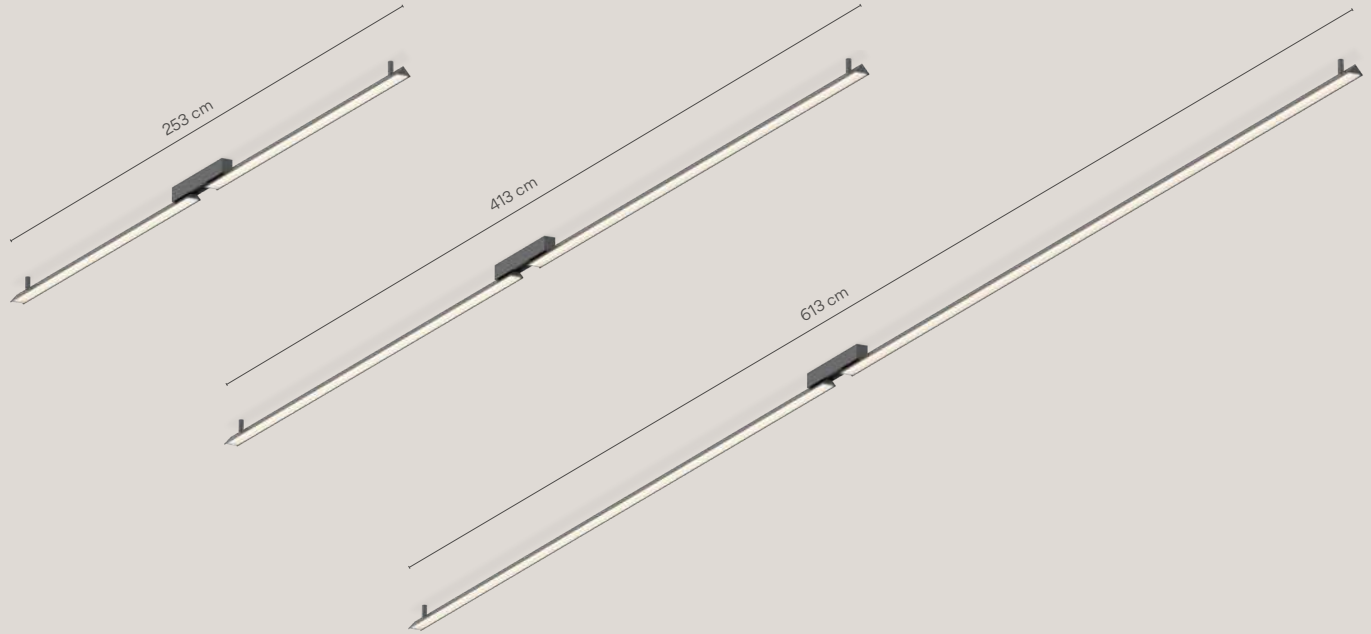

**5981**

2 x LED STRIP 10,8 W 600 mA.   
 LED 2700 K. CRI >90. 3120 lm. 144 lm/W.   
 LED 3500 K. CRI >90. 3840 lm. 178 lm/W.   
 Driver Constant Current 600 mA. 220~240V. 50/60Hz.

**Control:**  
 DALI,  
 1-10V,  
 Casambi (Remote).

Profile: Aluminum.  
 Diffuser: PMMA & Silicone.  
 Canopy: Aluminum.  
 Net weight 2,8 Kg.

5981 11 Black (NCS S 8500-N)

5981 23 Warm White (NCS S 0502-Y50R)

5981 25 Beige D1 (NCS S 4005-Y50R)

**5983**

2 x LED STRIP 21,6 W 600 mA.   
 LED 2700 K. CRI >90. 5120 lm. 119 lm/W.   
 LED 3500 K. CRI >90. 6720 lm. 156 lm/W.   
 Driver Constant Current 1200 mA. 220~240V. 50/60Hz.

**Control:**  
 DALI,  
 1-10V,  
 Casambi (Remote).

Profile: Aluminum.  
 Diffuser: PMMA & Silicone.  
 Canopy: Aluminum.  
 Net weight 4,8 Kg.

5983 11 Black (NCS S 8500-N)

5983 23 Warm White (NCS S 0502-Y50R)

5983 25 Beige D1 (NCS S 4005-Y50R)

**5985**

2 x LED STRIP 32,4 W 600 mA.   
 LED 2700 K. CRI >90. 7680 lm. 119 lm/W.   
 LED 3500 K. CRI >90. 10080 lm. 156 lm/W.   
 Driver Constant Current 600 mA.   
 220~240V. 50/60Hz.

**Control:**  
 DALI (Remote),  
 1-10V (Remote),  
 Casambi (Remote).

Profile: Aluminum.  
 Diffuser: PMMA & Silicone.  
 Canopy: Aluminum.  
 Net weight 6,9 Kg.

5985 11 Black (NCS S 8500-N)

5985 23 Warm White (NCS S 0502-Y50R)

5985 25 Beige D1 (NCS S 4005-Y50R)

Wall Vanity light





5987 p. 38





5989 p. 38

5991 p. 38

**5987**  
 1 x LED STRIP 10,8 W 600 mA.   
 LED 2700 K. CRI >90. 1560 lm. 144 lm/W.  
 LED 3500 K. CRI >90. 1920 lm. 178 lm/W.  
 Driver Constant Current 600 mA. 220-240V. 50/60Hz.  
**Control:**  
 DALI,  
 1-10V,  
 Casambi (Remote).



Profile: Aluminum.  
 Diffuser: PMMA & Silicone.  
 Canopy: Aluminum.  
 Net weight 1,6 Kg.





- 5987 11 Black (NCS S 8500-N) 
- 5987 23 Warm White (NCS S 0502-Y50R) 
- 5987 25 Beige D1 (NCS S 4005-Y50R) 

    

**5989**  
 1 x LED STRIP 21,6 W 600 mA.   
 LED 2700 K. CRI >90. 2560 lm. 119 lm/W.  
 LED 3500 K. CRI >90. 3360 lm. 156 lm/W.  
 Driver Constant Current 600 mA. 220-240V. 50/60Hz.  
**Control:**  
 DALI,  
 1-10V,  
 Casambi (Remote).



Profile: Aluminum.  
 Diffuser: PMMA & Silicone.  
 Canopy: Aluminum.  
 Net weight 2,6 Kg.

- 5989 11 Black (NCS S 8500-N) 
- 5989 23 Warm White (NCS S 0502-Y50R) 
- 5989 25 Beige D1 (NCS S 4005-Y50R) 

**5991**  
 1 x LED STRIP 32,4 W 600 mA.   
 LED 2700 K. CRI >90. 3840 lm. 119 lm/W.  
 LED 3500 K. CRI >90. 5040 lm. 156 lm/W.  
 Driver Constant Current 600 mA. 220-240V. 50/60Hz.  
**Control:**  
 DALI,  
 1-10V,  
 Casambi (Remote).

Profile: Aluminum.  
 Diffuser: PMMA & Silicone.  
 Canopy: Aluminum.  
 Net weight 3,6 Kg.

- 5991 11 Black (NCS S 8500-N) 
- 5991 23 Warm White (NCS S 0502-Y50R) 
- 5991 25 Beige D1 (NCS S 4005-Y50R) 



## Vertical wall

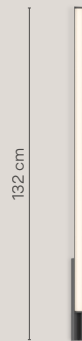

5993 p. 39



5995 p. 39

**5993**

1 x LED STRIP 10,8W 600 mA.

LED 2700 K. 3500 lm. 144 lm/W.

LED 3500 K. 1920 lm. 178 lm/W.

Driver Constant Current 600 mA. 220~240V. 50/60Hz.

**Control:**

DALI,

1-10V,

Casambi (Remote).

Profile: Aluminum.

Diffuser: PMMA &amp; Silicone.

Canopy: Aluminum.

Net weight 1,6 Kg.

**5993 11** Black (NCS S 8500-N) **5993 23** Warm White (NCS S 0502-Y50R) **5993 25** Beige D1 (NCS S 4005-Y50R) **5995**

1 x LED STRIP 21,6 W 600 mA.

LED 2700 K. CRI &gt;90. 2560 lm. 119 lm/W.

LED 3500 K. CRI &gt;90. 3360 lm. 156 lm/W.

Driver Constant Current 600 mA. 220~240V. 50/60Hz.

**Control:**

DALI,

1-10V,

Casambi (Remote).

Profile: Aluminum.

Diffuser: PMMA &amp; Silicone.

Canopy: Aluminum.

Net weight 2,6 Kg.

**5995 11** Black (NCS S 8500-N) **5995 23** Warm White (NCS S 0502-Y50R) **5995 25** Beige D1 (NCS S 4005-Y50R)

# Africa

Design by Francisco Gómez Paz.

Table

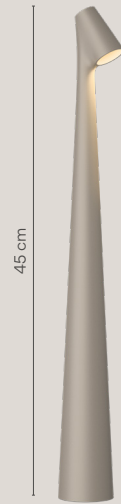

45 cm

Portable

5580 p. 49

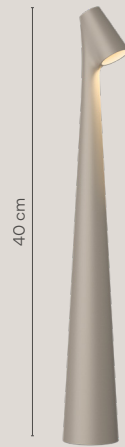

40 cm





Portable

5585 p. 49

**5580**  
 1 x LED 4,5W 500 mA.   
 LED 2700 K. CRI >90. 520 lm. 117 lm/W.  
**Output:** DC 5.0V 2.0 A. 10.0W  
**Input:** 100-240V 50/60Hz

**Control:**  
 Push.  
 Battery capacity 5000mAhx2 (10.000mAh).  
 Battery voltage 3,7V.  
 Rechargeable battery autonomy:  
 6,5h at 100% Intensity.  
 10h at 66% Intensity.  
 20h at 33% Intensity.

Body: Aluminium.  
 Diffuser: Polycarbonate.  
 Net weight 0,9 Kg.





- 5580 24 Beige M1 (NCS S 2005-Y50R) 
- 5580 25 Beige D1 (NCS S 4005-Y50R) 
- 5580 29 Brown D1 (NCS S 8005-Y50R) 
- 5580 38 Terra Dark (NCS S 5040-Y70R) 

**5585**  
 1 x LED 4,5W 500 mA.   
 LED 2700 K. CRI >90. 520 lm. 117 lm/W.  
**Output:** DC 5.0V 2.0 A. 10.0W  
**Input:** 100-240V 50/60Hz

**Control:**  
 Push.  
 Battery capacity 5000mAhx2 (10.000mAh).  
 Battery voltage 3,7V.  
 Rechargeable battery autonomy:  
 6,5h at 100% Intensity.  
 10h at 66% Intensity.  
 20h at 33% Intensity.

Body: Aluminium.  
 Diffuser: Polycarbonate.  
 Net weight 0,9 Kg.

- 5585 24 Beige M1 (NCS S 2005-Y50R) 
- 5585 25 Beige D1 (NCS S 4005-Y50R) 
- 5585 29 Brown D1 (NCS S 8005-Y50R) 
- 5585 38 Terra Dark (NCS S 5040-Y70R) 

# Mayfair Mini

Design by Diego Fortunato.

Table



Portable

5495 p. 61



5496 p. 61

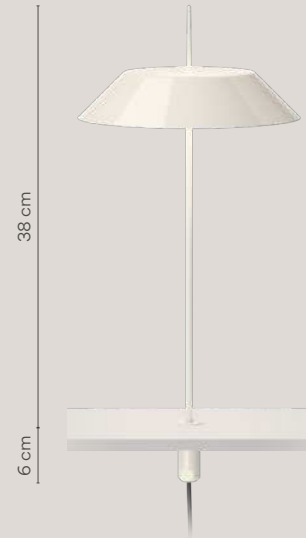

5497 p. 61

## 5495

1 x LED PLATE 5V 2,5W.   
 LED 2700 K. CRI >90. 175 lm. 70 lm/W.   
 Driver Constant Voltage 5V.   
 100~240V. 50/60Hz.

### Control:

Touch sensor.

Rechargeable battery autonomy:   
 6h at 100% Intensity.   
 12h at 50% Intensity.   
 18h at 25% Intensity.

Base and shade: Polycarbonate.   
 Diffuser: Translucent polycarbonate.   
 Stem: Stainless steel.   
 Net weight 0,73 Kg.

5495 23 Warm White (NCS S 0502-Y50R)

5495 25 Beige D1 (NCS S 4005-Y50R)

5495 37 Terra Red (NCS S 4040-Y70R)

5495 47 Green L1 (NCS S 4005-G80Y)

## 5496

1 x LED PLATE 5V 2,5W.   
 LED 2700 K. CRI >90. 175 lm. 70 lm/W.   
 Driver Constant Voltage 5V.   
 100~240V. 50/60Hz.

### Control:

Touch sensor.

Base and shade: Polycarbonate.   
 Diffuser: Translucent polycarbonate.   
 Stem: Stainless steel.   
 Net weight 0,94 Kg.

5496 23 Warm White (NCS S 0502-Y50R)

5496 25 Beige D1 (NCS S 4005-Y50R)

5496 37 Terra Red (NCS S 4040-Y70R)

5496 47 Green L1 (NCS S 4005-G80Y)

## 5497

1 x LED PLATE 5V 2,5W.   
 LED 2700 K. CRI >90. 175 lm. 70 lm/W.   
 Driver Constant Voltage 5V.   
 100~240V. 50/60Hz.

### Control:

On/ Off,   
 DALI,   
 1-10V.

Base and shade: Polycarbonate.   
 Diffuser: Translucent polycarbonate.   
 Stem: Stainless steel.   
 Net weight 0,54 Kg.

5497 23 Warm White (NCS S 0502-Y50R)

5497 25 Beige D1 (NCS S 4005-Y50R)

5497 37 Terra Red (NCS S 4040-Y70R)

5497 47 Green L1 (NCS S 4005-G80Y)



# Out

Design by Víctor Carrasco.

Outdoor



4270 p.71





4275 p.71 Bolt-down "hard wired"

**4270**  
 1 x LED 12,4W 700 mA.   
 LED 2700 K. CRI >90. 1300 lm. 104,83 lm/W.  
 Driver Constant Voltage 24V 1.0 A. 220~240V. 50/60Hz.  
**Control:**  
 Push,  
 Casambi.



Tube: Stainless Steel.  
 Shades: Aluminium.  
 Diffuser: Poliethylene.  
 Net weight 48 Kg.

- 4270 22 Black Anthracite (NCS S 2005-Y50R) 
- 4270 23 Warm White (NCS S 0502-Y50R) 
- 4270 25 Beige D1 (NCS S 4005-Y50R) 
- 4270 36 Soft Pink (NCS S 1010-Y50R) 
- 4270 37 Terra Red (NCS S 4040-Y70R) 
- 4270 47 Green L1 (NCS S 4005-G80Y) 

**4275**  
 1 x LED 12,4W 700 mA.   
 LED 2700 K. CRI >90. 1300 lm. 104,83 lm/W.  
 Driver Constant current 700mA. 220~240V. 50/60Hz.  
**Control:**  
 DALI,  
 Casambi (Remote).

Tube: Stainless Steel.  
 Shades: Aluminium.  
 Diffuser: Poliethylene.  
 Net weight 48 Kg.

- 4275 22 Black Anthracite (NCS S 2005-Y50R) 
- 4275 23 Warm White (NCS S 0502-Y50R) 
- 4275 25 Beige D1 (NCS S 4005-Y50R) 
- 4275 36 Soft Pink (NCS S 1010-Y50R) 
- 4275 37 Terra Red (NCS S 4040-Y70R) 
- 4275 47 Green L1 (NCS S 4005-G80Y) 

# Break Plus

Design by Xuclà.

Outdoor



4112 p. 81



4114 p. 81



4116 p. 81

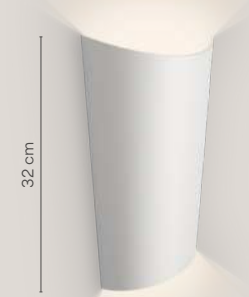

4118 p. 81

## 4112

1 x LED 1W 350 mA.

LED 2700 K. CRI >90. 113,73 lm. 113,73 lm/W.

LED 3500 K. CRI >90. 146,22 lm. 146,22 lm/W.

Driver Constant current 350 mA. 100~240Vac. 50/60Hz.

### Control:

On / Off.

DALI (Remote).

Casambi (Remote).

Body: Aluminium.

Diffuser: Polycarbonate.

Net weight 0,6 Kg.

4112 22 Black Anthracite (NCS S 8000-N)

4112 25 Beige D1 (NCS S 4005-Y50R)

4112 37 Terra Red (NCS S 4040-Y70R)

4112 95 Primer (NCS S 1000-N)

## 4114

2 x LED 1W 350 mA.

LED 2700 K. CRI >90. 227,46 lm. 113,73 lm/W.

LED 3500 K. CRI >90. 292,44 lm. 146,22 lm/W.

Driver Constant current 350 mA. 100~240Vac. 50/60Hz.

### Control:

On / Off.

DALI (Remote).

Casambi (Remote).

Body: Aluminium.

Diffuser: Polycarbonate.

Net weight 0,6 Kg.

4112 22 Black Anthracite (NCS S 8000-N)

4112 25 Beige D1 (NCS S 4005-Y50R)

4112 37 Terra Red (NCS S 4040-Y70R)

4114 95 Primer (NCS S 1000-N)

## 4116

2 x LED 4W 350 mA.

LED 2700 K. CRI >90. 707,52 lm. 90,7 lm/W.

LED 3500 K. CRI >90. 925,22 lm. 118,61 lm/W.

Driver Constant current 350 mA. 100~240Vac. 50/60Hz.

### Control:

On / Off.

DALI (Remote).

Casambi (Remote).

Body: Aluminium.

Diffuser: Polycarbonate.

Net weight 2,2 Kg.

4116 22 Black Anthracite (NCS S 8000-N)

4116 25 Beige D1 (NCS S 4005-Y50R)

4116 37 Terra Red (NCS S 4040-Y70R)

4116 95 Primer (NCS S 1000-N)

## 4118

2 x LED 4W 350 mA.

LED 2700 K. CRI >90. 707,52 lm. 90,7 lm/W.

LED 3500 K. CRI >90. 925,22 lm. 118,61 lm/W.

Driver Constant current 350mA. 100~240Vac. 50/60Hz.

### Control:

On / Off.

DALI (Remote).

Casambi (Remote).

Body: Aluminium.

Diffuser: Polycarbonate.

Net weight 1,7 Kg.

4118 22 Black Anthracite (NCS S 8000-N)

4118 25 Beige D1 (NCS S 4005-Y50R)

4118 37 Terra Red (NCS S 4040-Y70R)

4118 95 Primer (NCS S 1000-N)

# Dots Outdoor

Design by Martín Azúa.

Outdoor

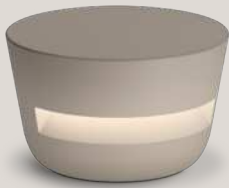

ø 20 cm

4695 p. 89

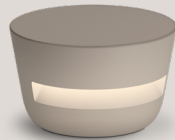

ø 16 cm

4697 p. 89



ø 20 cm

4700 p. 89

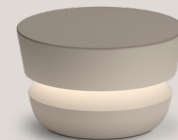



ø 16 cm

4702 p. 89

**4695**  
1 x LED STRIP 7,8W 350 mA.   
LED 2700 K. CRI >90. 750,2 lm. 96,18 lm/W.  
Driver Constant current 350 mA. 100-277V. 50/60Hz.  
**Control:**  
On / Off.  
DALI (Remote).  
Casambi (Remote).



Body: Aluminium.  
Diffuser: Polycarbonate.  
Net weight 2,7 Kg.

4695 22 Black Anthracite (NCS S 8000-N)   
4695 25 Beige D1 (NCS S 4005-Y50R)   
4695 53 Green M1 (NCS S 6005-G80Y) 

     **Multi-volt**

**4697**  
1 x LED STRIP 4,6W 350 mA.   
LED 2700 K. CRI >90. 375,9 lm. 81,72 lm/W.  
Driver Constant current 350 mA. 100-240V. 50/60Hz.  
**Control:**  
On / Off.  
DALI (Remote).  
Casambi (Remote).



Body: Aluminium.  
Diffuser: Polycarbonate.  
Net weight 1,5 Kg.

4697 22 Black Anthracite (NCS S 8000-N)   
4697 25 Beige D1 (NCS S 4005-Y50R)   
4697 53 Green M1 (NCS S 6005-G80Y) 

     **Bi-volt**

**4700**  
1 x LED STRIP 14,8W 350 mA.   
LED 2700 K. CRI >90. 1445 lm. 97,64 lm/W.  
Driver Constant current 350 mA. 100-277V. 50/60Hz.  
**Control:**  
On / Off.  
DALI (Remote).  
Casambi (Remote).



Body: Aluminium.  
Diffuser: Polycarbonate.  
Net weight 3,1 Kg.

4700 22 Black Anthracite (NCS S 8000-N)   
4700 25 Beige D1 (NCS S 4005-Y50R)   
4700 53 Green M1 (NCS S 6005-G80Y) 

     **Bi-volt**

**4702**  
1 x LED STRIP 12,8W 300 mA.   
LED 2700 K. CRI >90. 1294 lm. 101,1 lm/W.  
Driver Constant current 300mA. 100-277V. 50/60Hz.  
**Control:**  
On / Off.  
DALI (Remote).  
Casambi (Remote).

Body: Aluminium.  
Diffuser: Polycarbonate.  
Net weight 1,5 Kg.

4702 22 Black Anthracite (NCS S 8000-N)   
4702 25 Beige D1 (NCS S 4005-Y50R)   
4702 53 Green M1 (NCS S 6005-G80Y) 

     **Bi-volt**



# Class

Design by Sebastian Herkner.

Outdoor

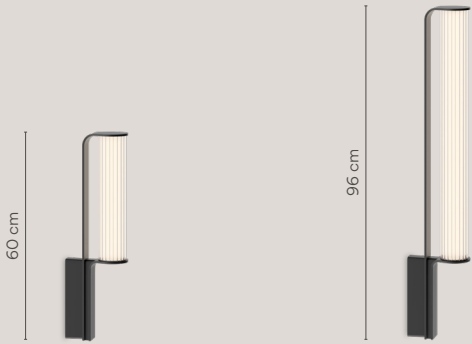



2820 p. 103

2825 p. 103

**2820**  
 1 x LED 3,6 W 150 mA.   
 LED 2700 K. CRI >90. 1188 lm. 198 lm/W.  
 Driver Constant current 150 mA. 220~240V. 50/60Hz.  
**Control:**  
 DALI.  
 Push.  
 Casambi (Remote).

Body: Aluminium.  
 Glass: Borosilicate glass.  
 Diffuser: Opal polycarbonate.  
 Net weight 2,9 Kg.





**2820 11** Black (NCS S 8500-N) 

**2825**  
 1 x LED 7,2W 300 mA.   
 LED 2700 K. CRI>90 2376 lm 198 lm/W.  
 Driver Constant current 300 mA. 220~240V. 50/60Hz.  
**Control:**  
 DALI.  
 Push.  
 Casambi (Remote).

Body: Aluminium.  
 Glass: Borosilicate glass.  
 Diffuser: Opal polycarbonate.  
 Net weight 4,4 Kg.

**2825 11** Black (NCS S 8500-N) 

    

---

Outdoor

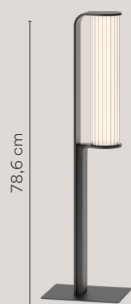

2800 p.103

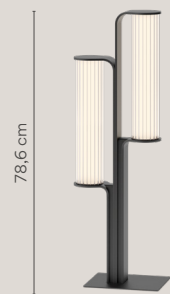

2805 p.103



2810 p.103

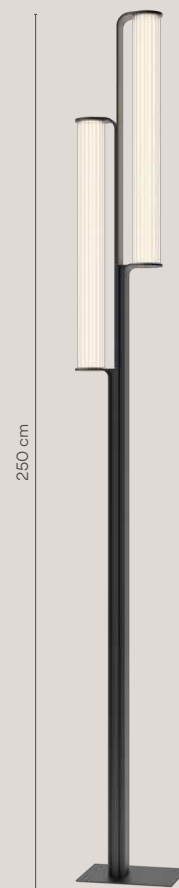

2815 p.103

---

**2800**1 x LED 3,6W 150 mA. 

LED 2700 K. CRI &gt;90. 1188 lm. 198 lm/W.

Driver Constant current 150 mA. 220-240V. 50/60Hz.

**Control:**

DALI.

Push.



Casambi (Remote).

Body: Aluminium.

Glass: Borosilicate glass.

Diffuser: Opal polycarbonate.

Net weight 9,6 Kg.

**2800 11** Black (NCS S 8500-N)      **2805**2 x LED 3,6W 150 mA. 

LED 2700 K. CRI &gt;90. 2376 lm. 198 lm/W.

Driver Constant current 300 mA. 220-240V. 50/60Hz.

**Control:**

DALI.

Push.

Casambi (Remote)..

Body: Aluminium.

Glass: Borosilicate glass.

Diffuser: Opal polycarbonate.

Net weight 12,8 Kg.

**2805 11** Black (NCS S 8500-N)      **2810**1 x LED 7,2W 300 mA. 

LED 2700 K. CRI &gt;90. 2376 lm. 198 lm/W.

Driver Constant current 300 mA. 220-240V. 50/60Hz.

**Control:**

DALI.

Push.



Casambi (Remote).

Body: Aluminium.

Glass: Borosilicate glass.

Diffuser: Opal polycarbonate.

Net weight 17,5 Kg.

**2810 11** Black (NCS S 8500-N)      **2815**2 x LED 7,2W 300 mA. 

LED 2700 K. CRI &gt;90. 4752 lm. 198 lm/W.

Driver Constant current 600 mA. 220-240V. 50/60Hz.

**Control:**

DALI.

Push.

Casambi (Remote).

Body: Aluminium.

Glass: Borosilicate glass.

Diffuser: Opal polycarbonate.

Net weight 25,4 Kg.

**2815 11** Black (NCS S 8500-N)      



## ACKNOWLEDGEMENTS

Nacho Carbó  
Photography: Mariela Apollonio  
(page 9, 72, 113)

Fieldwork Design  
Photography: Jeremy Bittermann / JBSA  
(page 12, 84, 92)

Architecture: Ideo Arquitectura  
Photography: Salva López  
(page 76)

Architecture: Unterlandstättner Architekten  
[www.u-architekten.de](http://www.u-architekten.de)  
Photography: Michael Heinrich  
(page 97)

Architecture: Balzar Arquitectos  
(page 108)

Bernadí Hub  
[www.bernadi.es](http://www.bernadi.es)

Carles Enrich Studio

The content of this catalogue may be changed  
or cancelled at the discretion of the VIBIA  
management without prior notice.

Vibia Lighting, S.L.U.

Spain & Portugal T. +34 934 796 970  
International T. +34 934 796 971  
[hello@vibia.com](mailto:hello@vibia.com)  
[www.vibia.com](http://www.vibia.com)



