

Spotlights & Downlights

UNICO recessed

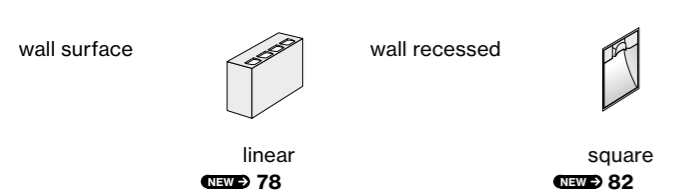

CAVO recessed

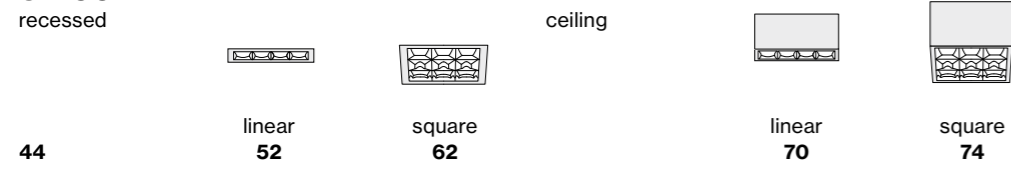
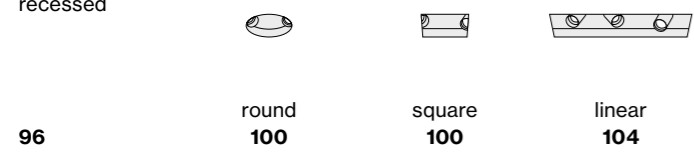

SASSO recessed

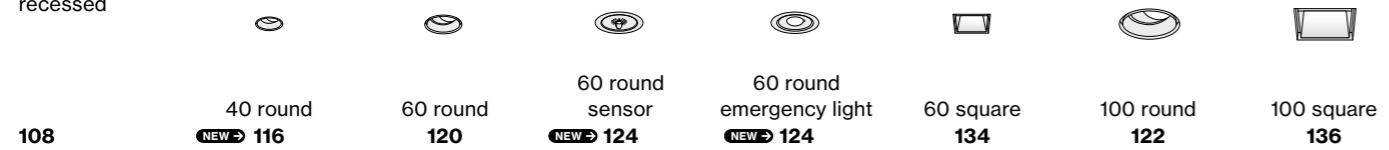

semi-recessed



suspended

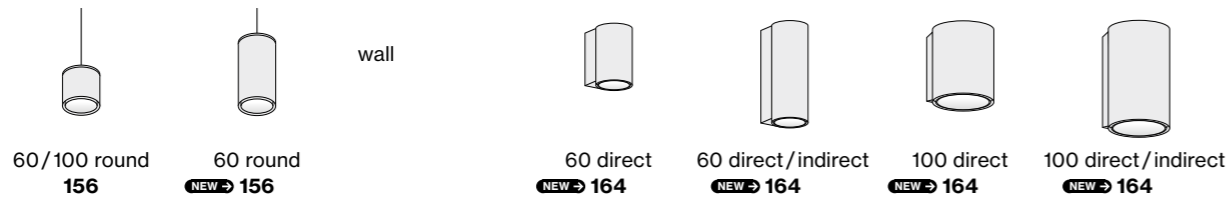

SASSO PRO recessed



MOVE IN recessed

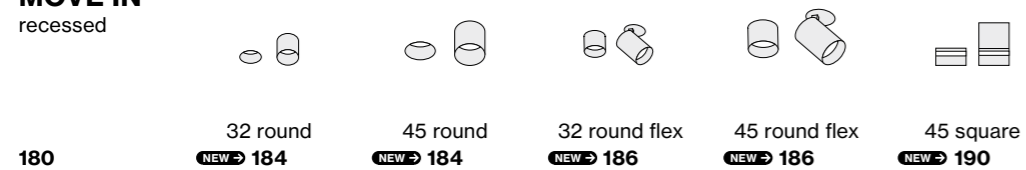

TWIST recessed



SPADO recessed

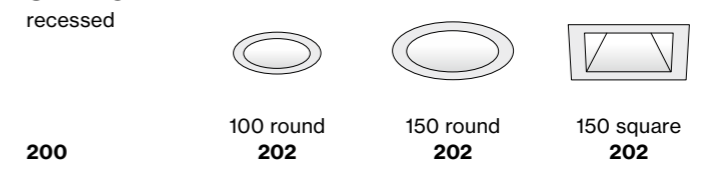

SQUADRO recessed

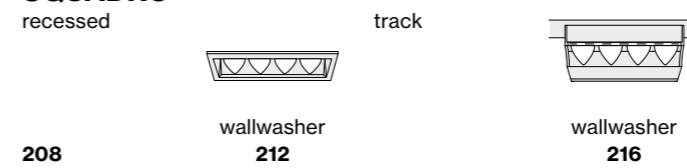

BO semi-recessed

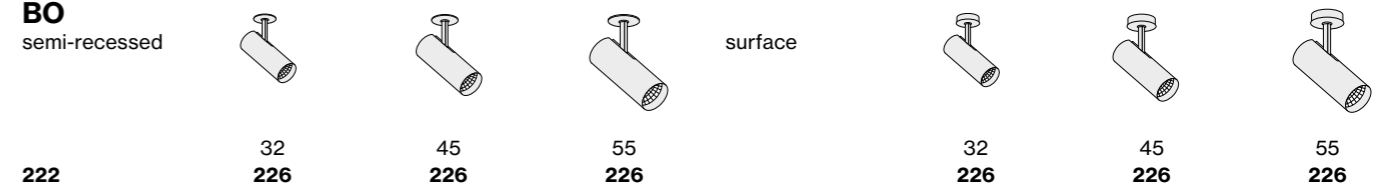

VARO track

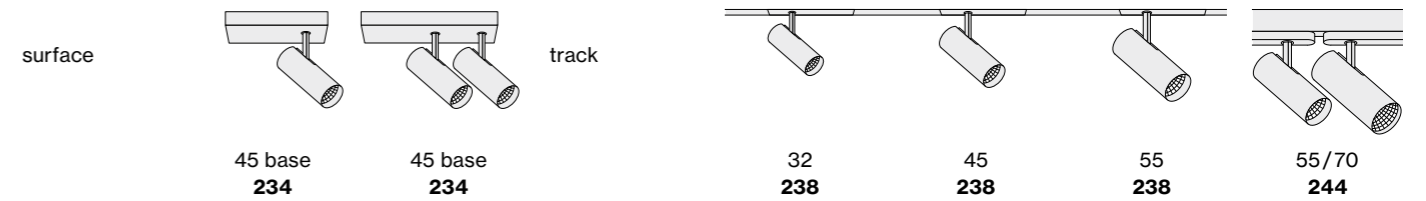

VARO track

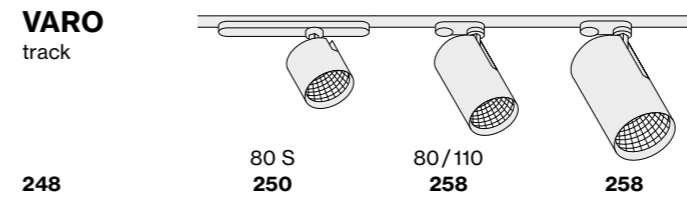

PABLO track

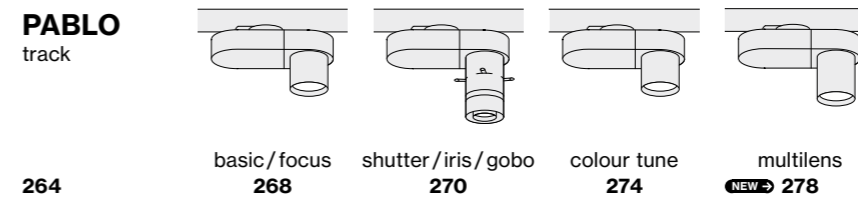

TULA suspended

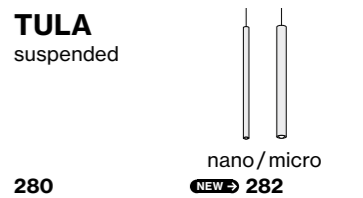

ARY suspended

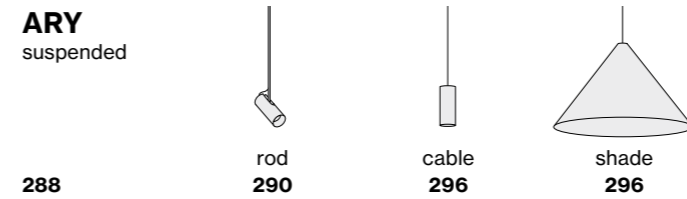

TRACK 3-phase

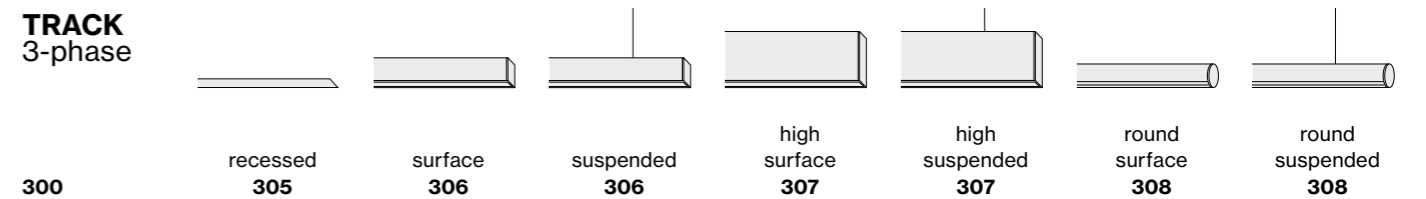

Luminaires

MITA

recessed



ceiling



314 circle 160
NEW → 316

circle
NEW → 320

square
NEW → 326

circle
NEW → 330

COMBO

recessed



334 trim
336

VELA

surface



342 surface
344

suspended



suspended
348

SONO

recessed



356 recessed
360

surface



surface
364



loop surface
370

FLOW

surface



374 surface
376

JANE

semi-recessed surface
suspended

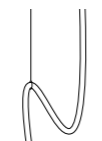

380 **NEW → 384**

DESO

suspended

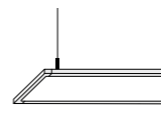

394 suspended
NEW → 396

MINIMAL

recessed trimless



508 60/100
510/512

FRAME

recessed trim



516 40/60/100
518/520/522

CANYON

recessed trim offset



526 60
528

MINO

surface/suspended



532 40/60/100
534/544/552

BASO

recessed trim



556 60
558

surface

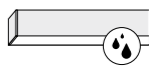

60
564

TUBO

surface



568 60
NEW → 572

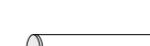

100
576

suspended



60
NEW → 572

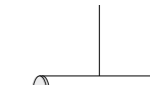

100
576

INO

suspended



580 circle
584

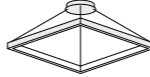

square
590

MINO CIRCLE

ceiling



594 ceiling/acoustic
596

suspended

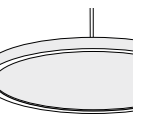

suspended/acoustic
598

TASK

surface



400 round/acoustic
404



square/acoustic
416

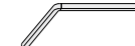

ceiling
424

suspended



round/acoustic
410



square/acoustic
420

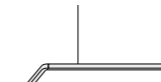

suspended
428

suspended

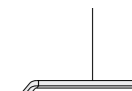

S suspended
432

wall



wall
436

free standing

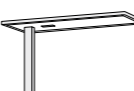

free standing
440

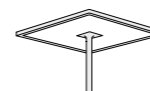

square
446

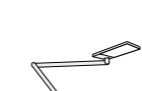
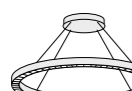

table
452

BETO

suspended



460 circle
NEW → 464



suspended
470

free standing

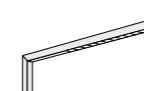

free standing
476

SETA

suspended



484 suspended
NEW → 486

LITO

suspended



610 60
612

SONIC

suspended



616 suspended/acoustic
618

free standing



free standing/acoustic
624

LINEA

wall



632 wall
NEW → 634

HEX-O

ceiling

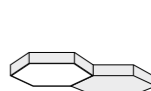

638 ceiling/acoustic
642

suspended

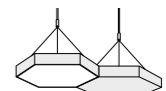

suspended/acoustic
646

MUSE

acoustic suspended

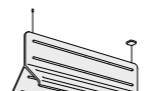

654 double light
658

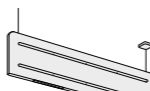

light/baffle
664

STRETTA

surface



670 surface
672

LENO

recessed semi-recessed



490 trim
492



trimless
492



semi-recessed
496

surface



surface
500

suspended



suspended
504

CORNER

surface



676 surface
678

RECOVER

wall

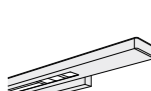

682 wall
686

Systems

MOVE IT 25

recessed
surface
suspended

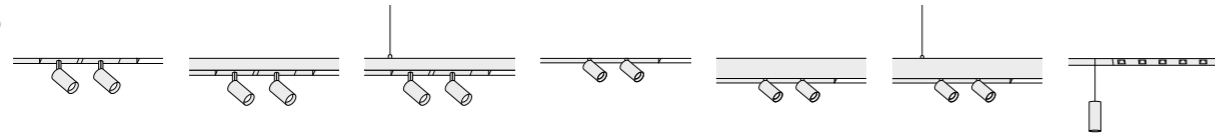

694

25S recessed
701

25S surface
702

25S suspended
702

25 recessed
705

25 surface
706

25 suspended
706

insets
710

MOVE IT 45

recessed
surface
suspended

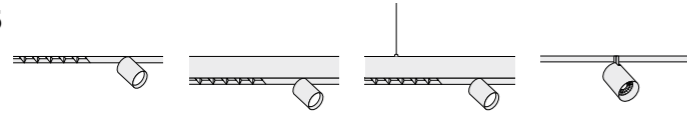

778

45 recessed
785

45 surface
786

45 suspended
786

insets
790

TASK

suspended

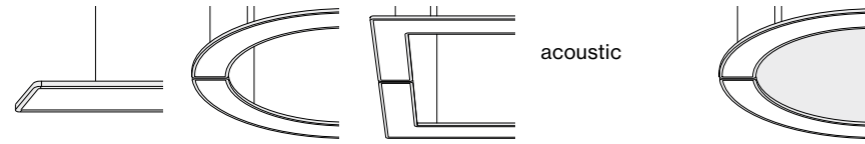

808

S suspended
812

circle
820

angular
826

acoustic
inlay
820 / 826

BETO

ceiling

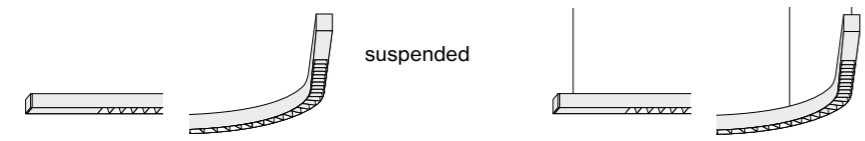

834

ceiling
838

curve ceiling
838

suspended
838

curve susp.
838

SETA

ceiling

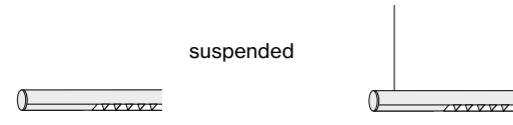

850

ceiling
NEW → 854

suspended
NEW → 854

LENO

recessed
semi-recessed

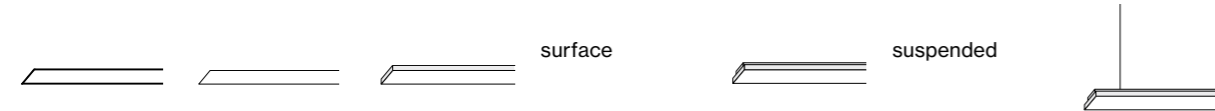

858

trim
862

trimless
866

semi-recessed
870

surface
874

suspended
876

MINIMAL

recessed
trimless

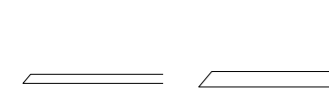

878

60
880

100
882

FRAME

recessed
trim



888

40
890

60
892

100
898

CANYON

recessed
trim offset



902

60
904

MINO

ceiling

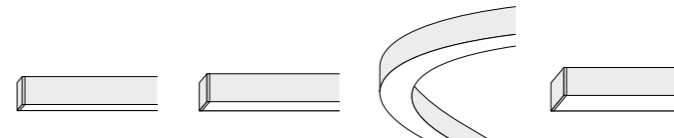

908

40
912

60
914

60 curve
916

100
928

suspended



40
912

60
914

60 curve
916

100
928

BASO

recessed
trim

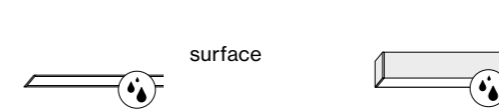

934

60
936

60
940

TUBO

surface

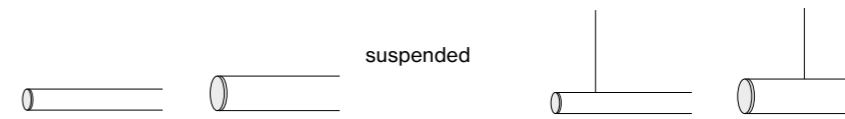

948

60
NEW → 952

100
954

60
NEW → 952

100
954

LINEA

wall

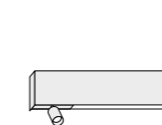

958

wall
NEW → 960

Controls

DALI-2 control



970

Professional building management

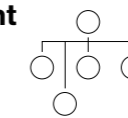

976

Casambi



NEW → 978

DIN rail components

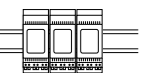

NEW → 980

Know-How



982

Product Index

A

	PAGE
ARY cable suspended	296
ARY rod suspended	290

B

	PAGE
BASO 60 IP 54 surface	564
BASO 60 IP 54 surface system	940
BASO 60 IP 54 trim	558
BASO 60 IP 54 trim system	936
BETO circle suspended	464
BETO free standing	476
BETO suspended	470
BETO linear ceiling system	838
BETO linear suspended system	838
BETO curve ceiling system	840
BETO curve suspended system	840
BETO s-line ceiling system	840
BETO s-line suspended system	840
BO 32 semi-recessed	226
BO 32 surface	226
BO 32 intrack	238
BO 45 base surface	234
BO 45 semi-recessed	226
BO 45 surface	226
BO 45 intrack	238
BO 55 semi-recessed	226
BO 55 surface	226
BO 55 intrack	238
BO 55 track	244
BO 70 track	244

C

	PAGE
CANYON 60 trim offset	528
CANYON 60 trim offset system	904
CAVO linear	104
CAVO round	100
CAVO square	100
COMBO trim	336
CORNER surface	678

D

	PAGE
DESO suspended	396

F

	PAGE
FLOW surface	376
FRAME 40 trim	518
FRAME 40 trim system	890
FRAME 60 trim	520
FRAME 60 trim system	892
FRAME 100 trim	522
FRAME 100 trim system	898

H

	PAGE
HEX-O ceiling	642
HEX-O suspended	646

I

	PAGE
INO circle suspended	584
INO square suspended	590

J

	PAGE
JANE semi-recessed	384
JANE surface	384
JANE suspended	384

L

	PAGE
LENO semi-recessed	496
LENO semi-recessed system	870
LENO surface	500
LENO surface system	874
LENO suspended	504
LENO suspended system	876
LENO trim	492
LENO trim system	862
LENO trimless	492
LENO trimless system	866
LINEA wall	634
LINEA wall system	960
LITO 60 suspended	612

M

	PAGE
MINIMAL 60 trimless	510
MINIMAL 60 trimless system	880
MINIMAL 100 trimless	512
MINIMAL 100 trimless system	882
MINO 40 surface	534
MINO 40 ceiling system	912
MINO 40 suspended	536
MINO 40 suspended system	912
MINO 60 CURVE ceiling system	916
MINO 60 CURVE suspended system	916
MINO 60 surface	544
MINO 60 ceiling system	914
MINO 60 suspended	548
MINO 60 suspended system	914
MINO 100 surface	552
MINO 100 ceiling system	928
MINO 100 suspended	554
MINO 100 suspended system	928
MINO CIRCLE ceiling	596
MINO CIRCLE suspended	598
MINO CIRCLE acoustic elements	606
MITA circle 160 recessed	314
MITA circle 240/450 recessed	320
MITA circle ceiling	330
MITA square recessed	326

MOVE IT 25 S system	700
• JUST 32/45/55 spotlight inset	710
• PIVOT graphic light inset	720
• FLEXTRACK system extension	730
• ARY rod decorative light inset	734
• ARY cable decorative light inset	736
• TULA decorative light inset	742
• PAL decorative light inset	748
• w201 Extra small pendant	752
• WALLWASHER linear inset	764
• WALL GRAZER/BATWING linear inset	768

MOVE IT 25 system	752
• JUST 32/45/55 spotlight inset	710
• PIVOT graphic light inset	720
• FLEXTRACK system extension	730
• ARY rod decorative light inset	734
• ARY cable decorative light inset	736
• TULA decorative light inset	742
• PAL decorative light inset	748
• w201 Extra small pendant	752
• SPOT LINE/OPAL linear inset	754
• WALLWASHER linear inset	764
• ACOUSTIC elements	772

MOVE IT 45 system	784
• OPAL/MICROPRISMATIC linear inset	790
• L1 – 6 linear inset 45	792
• L10 office linear inset 45	793
• L24 office linear inset 45	793
• JUST 45/55 spotlight inset	802
• ACOUSTIC elements	806

MOVE IN 32 round flex recessed	186
MOVE IN 32 round recessed	184
MOVE IN 45 round flex recessed	186
MOVE IN 45 round recessed	184
MOVE IN 45 square recessed	190
MUSE double light suspended	658
MUSE light / baffle suspended	664

P

	PAGE
PABLO basic track	268
PABLO colour tune track	274
PABLO focus track	268
PABLO gobo track	271
PABLO multilens track	278
PABLO iris track	270
PABLO shutter track	270
PABLO tunable white track	274

R

	PAGE
RECOVER wall	686

S

	PAGE
SASSO 40 round recessed	116
SASSO 60 base ceiling	160
SASSO 60 round recessed	120
SASSO 60 round semi-recessed	140
SASSO 60 round ceiling	142
SASSO 60 round emergency light	124
SASSO 60 round sensor	124
SASSO 60 round suspended	156
SASSO 60 square recessed	134
SASSO 60 square semi-recessed	150
SASSO 60 square ceiling	152
SASSO 100 round recessed	122
SASSO 100 round semi-recessed	140
SASSO 100 round ceiling	142
SASSO 100 round suspended	156
SASSO 100 square recessed	136
SASSO 100 square semi-recessed	150
SASSO 100 square ceiling	152
SASSO PRO 80 flush recessed	172
SASSO PRO 80 offset recessed	172
SASSO PRO 100 flush recessed	174
SASSO PRO 100 offset recessed	174
SETA suspended	486
SETA suspended system	854
SONIC free standing	624
SONIC suspended	618
SONO flex trim	360
SONO IP 54 surface	364
SONO loop IP 54 surface	370
SONO surface	364
SPADO 100 round recessed	202
SPADO 150 round recessed	202
SPADO 150 square recessed	202
SPIO 60 round recessed	90
SQUADRO wallwasher recessed	212
SQUADRO wallwasher track	216
STRETTA surface	672

T

	PAGE
TASK acoustic elements	456
TASK ceiling	424
TASK free standing	440
TASK round surface	404
TASK round suspended	410
TASK angular suspended	826
TASK circle suspended	820
TASK S suspended	432
TASK S suspended system	812
TASK square free standing	446
TASK square surface	416
TASK square suspended	420
TASK suspended	428
TASK table	452
TASK wall	436
TRACK 3-phase recessed	305
TRACK 3-phase surface	306
TRACK 3-phase suspended	306
TRACK 3-phase high surface	307
TRACK 3-phase high suspended	307
TRACK 3-phase round surface	308
TRACK 3-phase round suspended	308
TUBO 60 surface	572
TUBO 60 surface system	952
TUBO 60 suspended	572
TUBO 60 suspended system	952
TUBO 100 surface	576
TUBO 100 surface system	954
TUBO 100 suspended	576
TUBO 100 suspended system	954

U

	PAGE
UNICO linear recessed	52
UNICO linear ceiling	70
UNICO square ceiling	74
UNICO square recessed	62
UNICO wall surface	78
UNICO wall recessed	82

V

	PAGE
VARO 80 S track	250
VARO 80 track	258
VARO 110 track	258
VELA surface	344
VELA suspended	348

Lighting without limits



EN It all begins with a passion for light. For more than 30 years, XAL has been working with lighting designers and architects to develop custom luminaires of the highest technical standard, which impress with their style and aesthetics. There is always one goal: to push the boundaries of the technically feasible, enabling visionary designs. We can meet this challenge because our employees in our design labs as well as in our production and sales locations around the world deliver top performance. Being on-site for our customers is essential for mutual success. Thanks to organisational efficiency and high in-house production depth, we can tailor our response to the needs of our customers and continuously expand our existing product portfolio. Meeting seemingly impossible challenges is our daily motivation and inspiration. From novel concept to luminaire innovation: a path created by crossing borders. **Lighting without limits.**

DE Alles beginnt mit der Leidenschaft für Licht. Seit über 30 Jahren entwickelt XAL gemeinsam mit LichtdesignerInnen und ArchitektInnen individuelle Leuchten auf dem höchsten Stand der Technik, die zudem durch Stil und Ästhetik überzeugen. Immer mit einem Ziel: die Grenzen des technisch Machbaren zu überschreiten und dadurch visionäre Entwürfe zu ermöglichen. Das gelingt, da unsere MitarbeiterInnen in unseren Design-Labs sowie Produktions- und Vertriebsstandorten auf der ganzen Welt Höchstleistungen erbringen. Vor Ort für unsere KundInnen da zu sein ist grundlegend für gemeinsame Erfolge. Dank organisatorischer Effizienz und einer hohen inhouse Fertigungstiefe können wir individuell auf die Bedürfnisse unserer KundInnen eingehen und unser bestehendes Produktportfolio laufend erweitern. Scheinbar unmöglichen Anforderungen zu begegnen ist für uns täglich Antrieb und Inspiration. Vom neuartigen Konzept zur Leuchteninnovation: ein Weg, der durch Grenzüber-schreitung entsteht. **Lighting without limits.**

Aertssen Logistics Beveren, BE
Architecture by Mertens Architecten
Lighting and Interior Design by Eef Debeuf p. 18

The Gherkin London, UK
Architecture by Foster + Partners
Lighting Design by Zoe Faulkner, Troup Bywaters + Anders p. 24

Chanel Paris, FR
Architecture by ORY Architecture
Lighting Design by Distylight p. 30

Press Glass Headquarters Konopiska, PL
Architecture by Tomasz Konior, Konior Studio p. 36

Design Lab

EN Light and design merge in our Barcelona Creative Lab (BCL). The location is in close contact with the XAL Competence Center (XALcc) in Graz – two worlds that inspire and complement each other. Our employees research and extrapolate trends and develop concepts at the highest level of lighting technology. We work with international lighting designers and architects, continually striving to explore boundaries and make challenging designs possible. Courage and openness are our Design Lab's values that generate ground-breaking innovations.

DE In unserem Barcelona Creative Lab (BCL) verschmelzen Licht und Design. Der Standort steht in engem Austausch mit dem XAL Competence Center (XALcc) in Graz – zwei Welten, die einander inspirieren und ergänzen. Unsere MitarbeiterInnen erforschen Trends, denken diese weiter und entwickeln Konzepte auf dem höchsten Stand der Lichttechnik. Dazu arbeiten wir mit internationalen LichtdesignerInnen und ArchitektInnen zusammen, im ständigen Bestreben, Grenzen auszuloten und herausfordernde Entwürfe möglich zu machen. Mut und Offenheit sind die Werte in unserem Design Lab, die wegweisende Innovationen hervorbringen.

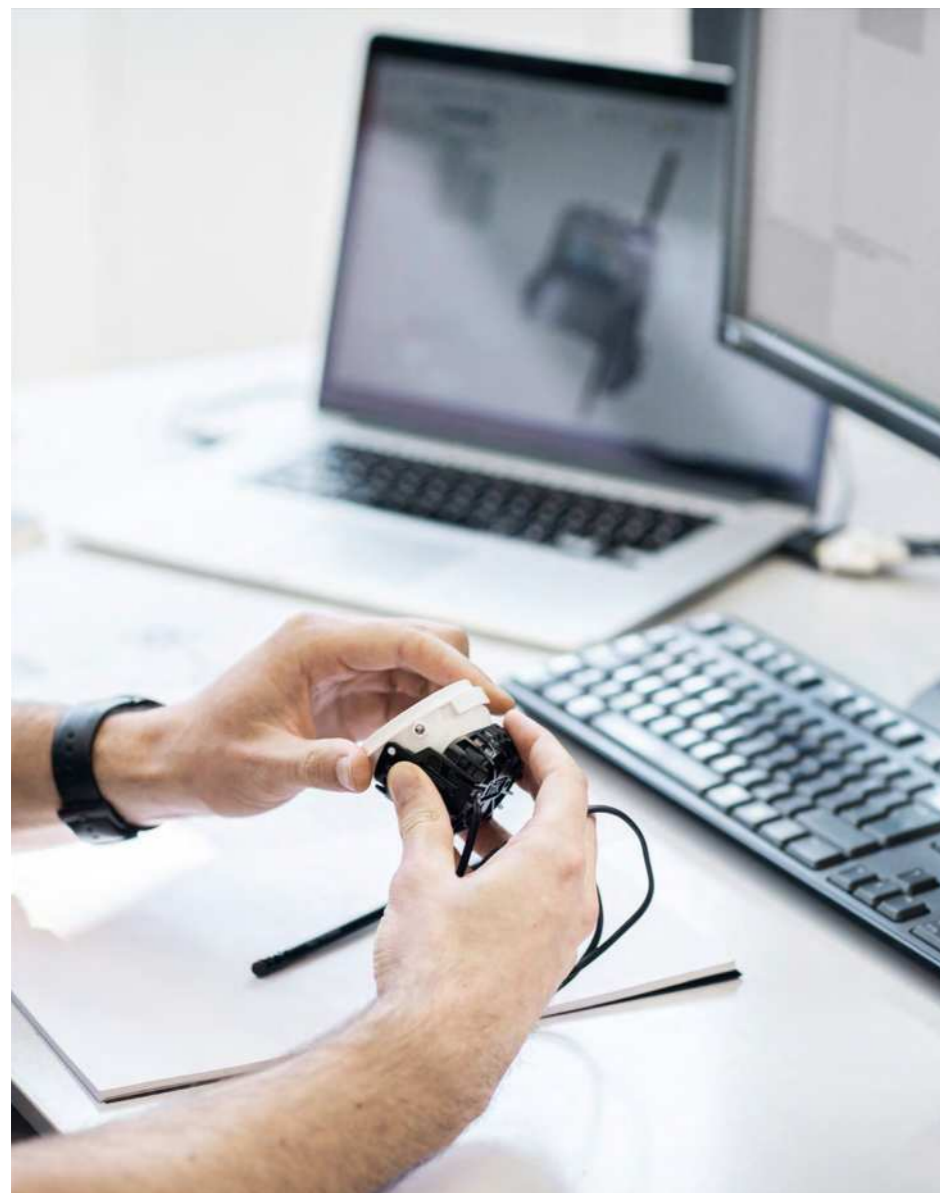

Research & Engineering

EN Our Competence Center provides the laboratory infrastructure needed to turn bold ideas into revolutionary products. Design prototypes are gradually perfected up to the assembly test at XAL HQ in terms of technology, economy, and design. As all relevant development, testing, and manufacturing processes are carried out in-house, we can implement custom designs and meet unique customer requirements quickly and flexibly. The results speak for themselves. We have over 70 registered patents worldwide and a continuously growing product portfolio that delivers exceptional performance.

DE Unser Kompetenzzentrum bietet die Labor-Infrastruktur, die es braucht, um aus kühnen Ideen revolutionäre Produkte zu machen. Im XAL HQ werden die Design-Prototypen bis zum Montagetest schrittweise technologisch, wirtschaftlich und gestalterisch perfektioniert. Indem alle relevanten Entwicklungs-, Prüf- und Fertigungsprozesse inhouse durchgeführt werden, können wir auch Sonderanfertigungen und spezielle Kundenwünsche schnell und flexibel umsetzen. Die Ergebnisse sprechen für sich: über 70 angemeldete Patente weltweit und ein laufend wachsendes Produktportfolio, das Außergewöhnliches leistet.



Quality Labs

EN Our many years of LED know-how ensure top workmanship throughout the entire production process. LEDs are subjected to a precise spectrometric analysis on delivery. Extensive quality tests are carried out in all areas, from PCB production on the optimum production line, in the high-end ESD assembly areas, to the finished product. XAL's light laboratory uses near-field goniophotometers to measure whether luminous flux and light distribution meet the requirements. All luminaires are tested for their electromagnetic compatibility in the EMC chamber. The exact measurement of the colour temperature and efficiency of the luminaire is also essential. This is how we optimise each product for its specific application.

DE Unser langjähriges LED-Know-how sichert höchste Verarbeitungsqualität im gesamten Produktionsprozess. Bereits beim Wareneingang werden LEDs einer präzisen, spektrometrischen Analyse unterzogen. Umfangreiche Qualitätstests erfolgen in allen Bereichen, von der Platinenfertigung auf der jeweils optimalen Fertigungslinie, in den High-End-ESD-Assembly-Bereichen, bis zum fertigen Produkt. Im XAL-Lichtlabor messen wir mittels Nahfeld-Goniophotometer, ob Lichtstrom und Lichtverteilung den Anforderungen entsprechen. In der EMV-Kammer werden alle Leuchten auf ihre elektromagnetische Verträglichkeit geprüft. Die exakte Messung von Farbtemperatur und Wirkungsgrad der Leuchte ist ebenfalls essentiell. So optimieren wir jedes Produkt für seinen individuellen Einsatzbereich.

In-house Manufacturing

EN We are certain that the highest quality and flexibility can only be achieved through in-house expertise along the value chain. That is why we manufacture almost exclusively in-house with state-of-the-art production technologies, at our own locations in Austria, Slovenia, and the USA. Every step is carried out in our modern production facilities – from electronics production, turning, milling, laser engraving, and die-casting to the final powder coating and finishing. This grants us maximum quality control, even for one-off and bespoke products and allows us to react with agility to customer requirements.

DE Wir sind überzeugt, dass höchste Qualität und Flexibilität nur durch eigene Kompetenz entlang der Wertschöpfungskette zu erreichen sind. Daher produzieren wir nahezu ausschließlich inhouse mit modernsten Fertigungstechnologien, an eigenen Standorten in Österreich, Slowenien und den USA. Von der Elektronikfertigung über Drehen, Fräsen, Lasergravur und Druckguss bis zur abschließenden Pulverbeschichtung und Endfertigung wird jeder Arbeitsschritt in eigenen modernen Produktionsstätten erledigt. So haben wir auch bei Einzel- und Sonderanfertigungen maximale Qualitätskontrolle und können flexibel auf Kundenwünsche reagieren.



Customised Solutions

EN Some visions fill space; others create it. Even the most extensive product portfolio cannot always meet a design's specific requirements. That is why we work with you to develop bespoke lighting solutions that are precisely tailored to the architectural and aesthetic needs of your project. Depending on the size of the project, we implement both minor adaptations to existing XAL products and designs of completely new innovations.

DE Manche Visionen nehmen Raum ein – andere erschaffen ihn. Selbst das größte Produktportfolio kann nicht immer die spezifischen Anforderungen eines Entwurfs erfüllen. Daher entwickeln wir gemeinsam mit Ihnen individuelle Lichtlösungen, die sich exakt an die architektonischen und ästhetischen Erfordernisse Ihres Projekts anpassen. Abhängig von der Projektgröße realisieren wir sowohl kleine Anpassungen an bestehenden XAL-Produkten als auch komplette Neuentwicklungen.



Acoustic Planning

EN A quiet working environment boosts concentration, reduces errors, and improves the efficiency and quality of work. Whether for a new construction or acoustic retrofitting, our room-acoustics experts help you with tailored and standard-compliant acoustic planning. We have different methods for this, from simple calculations to 3D simulations with realistic soundwave propagation to exact on-site sound measurements. We create a holistic lighting and acoustic concept in close coordination with you and our lighting design team. This delivers the best balance between lighting, ambience, and room-acoustic conditions.

DE Ein ruhiges Arbeitsumfeld erhöht die Konzentration, reduziert Fehler und steigert die Effizienz und Qualität der Arbeit. Ob Neubau oder akustische Nachrüstung: Unsere Raumakustik-ExpertInnen unterstützen Sie bei der individuellen und normgerechten Akustikplanung. Dazu arbeiten wir mit unterschiedlichen Methoden: von der einfachen Berechnung über 3D-Simulationen mit realistischer Schallwellen-Ausbreitung bis zu exakten Vor-Ort-Schallmessungen. In enger Abstimmung mit Ihnen und unserem Lichtplanungsteam erstellen wir ein ganzheitliches Licht und Akustikkonzept. So können wir die beste Balance zwischen Beleuchtung, Ambiente und raumakustischen Bedingungen schaffen.

Sustainability

EN As a company, we see ourselves as part of a larger whole to which we are committed – now, and for a future worth living. Climate protection has always been a focus of our work, not only because our products can make a significant contribution to improving our customers' environmental footprint but also because we are continuously reducing our emissions, for example by setting up and using our own photovoltaic systems, climate-conscious business travel management, and switching to e-mobility. Social responsibility is just as important to us as ecological responsibility, which is why we have anchored sustainability as a fundamental principle of our actions across all organisational levels. In 2019 we joined the UN Global Compact initiative whose principles guide our interactions with each other and our communities, our supply chain management, and our resource strategies. We believe our actions and our products' lifecycles must be traceable and transparent, which is why we welcome the continuous tightening of ecodesign standards at the EU level, such as most recently the new EPREL requirements. Among other initiatives, we make our ISO certification for environmental management, our corporate social responsibility ranking conducted by EcoVadis, and an increasing number of environmental product declarations available to our stakeholders. This is what we do to help improve the quality of life for everyone.



DE Wir begreifen uns als Unternehmen als Teil eines größeren Ganzen, dem wir verpflichtet sind – jetzt und für eine lebenswerte Zukunft. Ein Schwerpunkt unserer Arbeit war schon immer der Klimaschutz: Nicht nur, weil unsere Produkte einen wesentlichen Beitrag zur Verbesserung der Klimabilanzen unserer KundInnen leisten können, sondern auch, weil wir unsere eigenen Emissionen kontinuierlich reduzieren, etwa durch die Errichtung und Nutzung eigener Photovoltaikanlagen, ein klimabewusstes Dienstreisemanagement und den Umstieg auf E-Mobilität. Genauso wichtig wie ökologische sind für uns gesellschaftliche und soziale Verantwortung, weshalb wir Nachhaltigkeit als ein Grundprinzip unseres Handelns auf allen Organisationsebenen verankert haben. 2019 sind wir der UN Global Compact-

Initiative beigetreten, an deren Prinzipien wir unseren Umgang miteinander und mit unserem Umfeld, unser Lieferkettenmanagement und unsere Ressourcenstrategien ausrichten. Wir glauben daran, dass unser Handeln und der Lebenszyklus unserer Produkte nachvollziehbar und transparent sein müssen, weshalb wir die kontinuierliche Erhöhung der Ökodesign-Standards auf EU-Ebene wie zuletzt die neuen EPREL-Anforderungen begrüßen. Unseren StakeholderInnen stellen wir unter anderem unsere ISO-Zertifizierung für Umweltmanagement, unser von EcoVadis durchgeführtes Corporate Social Responsibility-Ranking und immer mehr Umweltproduktdeklarationen zur Verfügung; das ist unsere Arbeit im Zeichen unserer aller Lebensqualität.

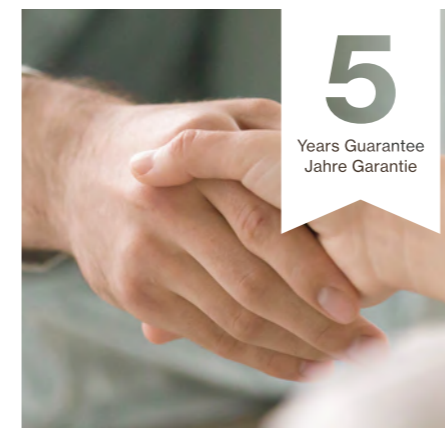

Guarantee

EN We trust our products. You can too. Guaranteed. XAL luminaires are manufactured to meet the highest standards. Today, tomorrow, and in five years' time. Since we are certain of this thanks to state-of-the-art development and production processes and sustainable technologies, you will automatically enjoy our 5-year guarantee.

DE Wir vertrauen unseren Produkten. Das können Sie auch. Garantiert. XAL-Leuchten werden gefertigt, um höchsten Ansprüchen zu genügen. Heute, morgen und in fünf Jahren. Da wir uns dessen dank modernster Entwicklungs- und Produktionsprozesse und nachhaltiger Technologien sicher sind, genießen Sie automatisch unsere 5-Jahres-Garantie.

Support across all project phases



EN Planning a lighting system is often complex. Benefit from our many years of experience in modern lighting systems and use XAL's lighting planning service for your complete bespoke solution. Our internal planning department supports you with lighting planning and luminaire selection, as well as with choosing the right control system. We help you with the installation and commissioning of your lighting system. This includes expert installation and programming of all luminaires so you can manage them centrally right away. We also provide RELUX, DIALux, and REVIT support, as well as installation videos and after-sales services. We are pleased to offer you a webchat on xal.com to answer your enquiries even better and faster.

DE Die Planung einer Beleuchtungsanlage ist oftmals eine komplexe Aufgabe. Profitieren Sie von unserer langjährigen Erfahrung im Lichtbereich mit modernen Lichtsystemen und nutzen Sie das XAL-Lichtplanungsservice für Ihre individuelle Komplettlösung. Unsere interne Planungsabteilung unterstützt Sie bei der Lichtplanung, Auswahl der Leuchten sowie bei der Entscheidung für das richtige Steuerungssystem. Wir helfen Ihnen bei der Montage und Inbetriebnahme Ihrer Beleuchtungsanlage. Das beinhaltet die fachkundige Installation und Programmierung sämtlicher Leuchten, sodass Sie diese sofort zentral verwalten können. Darüber hinaus bieten wir Ihnen RELUX-, DIALux- und REVIT-Unterstützung sowie Montagevideos und After Sales Services. Wir freuen uns, Ihnen auch einen Webchat auf xal.com anbieten zu können, um Ihre Anfragen noch besser und schneller beantworten zu können.

Digital Services Solution

EN Get the most out of your building with a lighting system that thinks for itself. Whether you want to reduce your energy consumption or create a healthy room atmosphere using modern sensor technology, our XAL Digital-Service-Solutions team can help you develop a customised lighting control system or integrate our luminaires into an existing building management system. We accompany you from the selection of the appropriate control system to programming and commissioning, as well as evaluation of building data to optimise building utilisation and energy consumption.

DE Holen Sie das meiste aus Ihrem Gebäude heraus: mit einer Beleuchtungsanlage, die mitdenkt. Ob Sie Ihren Energieverbrauch senken oder eine gesunde Raumatmosphäre schaffen wollen und dabei moderne Sensorik nutzen möchten, unser XAL Digital-Service-Solutions Team unterstützt Sie bei der Entwicklung einer maßgeschneiderten Lichtsteuerung oder integrieren unsere Leuchten in ein bestehendes Gebäudemanagementsystem. Wir begleiten Sie von der Auswahl des passenden Steuerungssystems bis zur Programmierung und Inbetriebnahme sowie Auswertung der Gebäudedaten zur Optimierung der Gebäudenutzung und des Energieverbrauchs.



Around the world

EN We are always near you. Our international sales offices enable us to work with lighting designers and architects all over the world. The international exchange and shared passion for light have shaped the cosmopolitanism that characterises XAL. Today we develop and produce innovative luminaires on three continents and supply our customers worldwide.

DE Wir sind vor Ort für Sie da. Unsere internationalen Vertriebsbüros ermöglichen es uns, mit LichtplanerInnen und ArchitektInnen auf der ganzen Welt zusammen zu arbeiten. Der internationale Austausch und die geteilte Leidenschaft für Licht haben jene Weltoffenheit geprägt, die XAL auszeichnet. Heute entwickeln und produzieren wir innovative Leuchten auf drei Kontinenten und beliefern unsere KundInnen weltweit.



AUSTRIA, XAL GmbH
Graz
Klagenfurt
Leonding
Thaur
Vienna

BELGIUM, XAL
Kortrijk

CHINA, XAL
Hong Kong

FINLAND, XAL Finland Oy
Helsinki

FRANCE, XAL Sarl
Lyon
Paris

GERMANY, XAL GmbH
Berlin
Cologne
Frankfurt
Hamburg
Munich
Stuttgart

INDIA, XAL Pvt. Ltd.
Pune

ITALY, XAL Srl
Bolzano

NETHERLANDS, XAL B.V.
Amsterdam

NORWAY, XAL AS
Oslo

POLAND, XAL Sp. z.o.o.
Warsaw

SLOVAKIA, XAL Eastern Europe k.s.
Bratislava

SPAIN, XAL Iluminación S.L.
Barcelona
Madrid

SWEDEN, XAL AB
Stockholm

SWITZERLAND, XAL Schweiz GmbH
Basel
Bern
Lausanne
Lucerne
Zürich

UNITED ARAB EMIRATES, XAL DMCC
Dubai

UNITED KINGDOM, XAL Ltd.
London

USA, XAL Inc.
New York
Oxford

All contacts:
[xal.com/location](https://www.xal.com/location)

Discreet lighting

EN A futuristic building is reminiscent of a modern boat, in an industrial environment. A unique contrast. The chosen lighting system is as unique as the building itself. It is so powerful that it was used for much of the interior, across various ceiling heights. A further requirement was that no lighting fixtures should be visible from the outside through the transparent façade. Nothing should distract from the building's beauty. A luminaire was needed that was small, beautifully designed, and yet met the demands for high light quality in an office environment. In addition, the desire was to use a single luminaire model to create unity between the areas on the different floors. The UNICO downlight was the right solution as it meets all the requirements. It is almost invisible and so powerful that UNICO was used for different ceiling levels such as the entrance hall with a ceiling height of over five metres and for the general office spaces.

DE Ein futuristisches Gebäude, das an ein modernes Schiff anmutet, in einer industriellen Umgebung. Ein Kontrast, der einzigartig ist. Das gewählte Beleuchtungssystem ist ebenso ein Unikat wie das Gebäude – so leistungsstark, dass es für den Großteil des Innenraums für verschiedene Deckenhöhen eingesetzt wurde. Die Anforderung darüber hinaus war, dass keine Beleuchtungskörper von außen durch die transparente Fassade zu sehen sein sollten. Nichts soll von der schönen Form des Gebäudes ablenken. Der Anspruch war, eine Leuchte zu wählen, die klein ist, ein schönes Design hat und dennoch den Anforderungen an eine hohe Lichtqualität in einer Büroumgebung gerecht wird. Darüber hinaus war es der Wunsch, mit ein und derselben Leuchte eine Einheit zwischen den Bereichen auf den verschiedenen Etagen zu schaffen. Die Lösung dafür wurde mit dem Downlight UNICO gefunden. Es erfüllt alle Anforderungen: Nahezu unsichtbar und so leistungsstark, dass UNICO für unterschiedliche Deckenebenen wie die Eingangshalle mit einer Höhe von mehr als fünf Metern und für die allgemeinen Büroräume eingesetzt wurde.

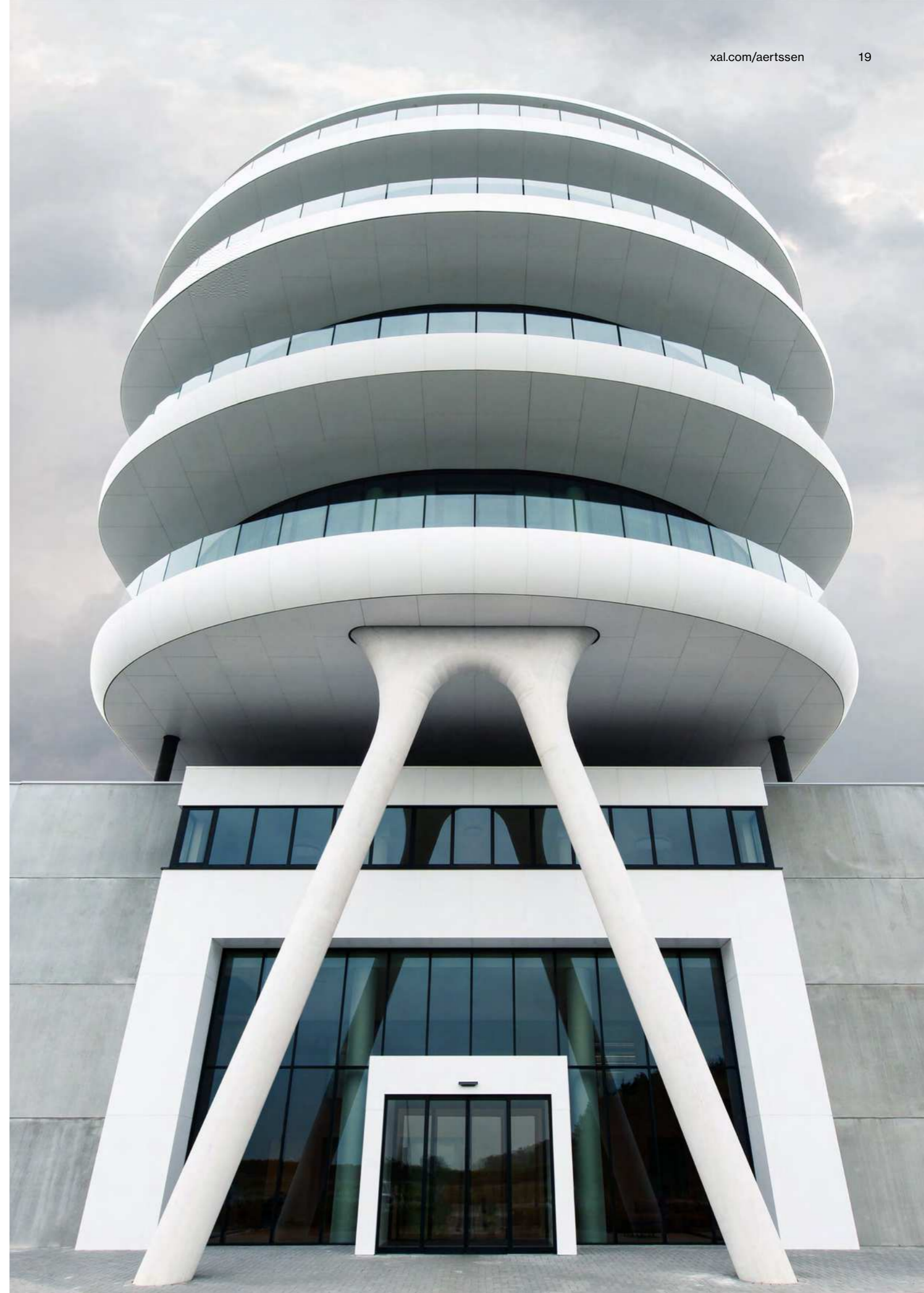



“As interior designers, our job is to craft an environment that makes people feel comfortable. Lighting in particular plays a major role in this.”

Eef Debeuf, Interior Designer





Aertssen Logistics
 Beveren, BE –
 by Mertens Architecten with lighting and
 interior design by Eef Debeuf



Iconic lighting

EN The Gherkin, designed by Foster + Partners, is a fantastic example of how light can highlight a building's architecture. The dazzling glass-fronted skyscraper is one of London's most distinctive landmarks. Lighting and architecture were to merge into one concept: bold, adaptable, and timeless. Each illuminated curve in the ceiling is a bespoke profile system, adapted to precise dimensions and angles. Visitors entering the building are greeted by a homogeneous illuminated imprint of the iconic building structure.

The Gherkin London

The Gherkin
London, UK

Architecture by
Foster + Partners

Lighting Design by
Zoe Faulkner,
Troup Bywaters + Anders

FRAME customised
SASSO 60







“The building is the focus, and the custom lighting serves as a tool, in a sense, to showcase this iconic building.”

Zoe Faulkner, Troup Bywaters and Anders



A wonderful place

EN Home to a banking institution for almost seventy years and an office building from the late 1980s onwards, the imposing building on Rue Cambon in Paris is now undergoing a complete reinvention. The biggest challenge is expressing a large French luxury institution's brand image while giving consistency to the whole place. Light is the interior's common central theme. The lighting designers' goal was to choose lighting that is both discreet and as efficient as possible. The atrium's height and magnificent staircase, its volume, and natural light pose a real challenge. The light had to blend in harmoniously to maintain this beautiful calm and create a pleasant atmosphere. The spotlights' colour temperature in the sleek MOVE IT 25 system was adapted to each of the six floors' heights to achieve balance between natural and artificial light.

DE Nahezu siebzig Jahre lang Sitz eines Bankinstituts, ab Ende der 80er-Jahre ein Bürogebäude, erfährt das imposante Gebäude in der Rue Cambon in Paris nun eine komplette Neuerfindung. Die größte Herausforderung besteht darin, das Markenimage eines großen französischen Luxushauses zum Ausdruck zu bringen und gleichzeitig dem ganzen Ort Konsistenz zu geben. Licht ist für das Interior der rote Faden. Ziel der Lighting Designer war es, eine Beleuchtung zu wählen, die einerseits diskret und gleichzeitig so effizient wie möglich ist. Das Atrium mit seiner Höhe und der prachtvollen Treppe, dem Volumen und dem natürlichen Licht stellt dabei eine echte Herausforderung dar. Das Licht musste sich harmonisch einfügen, um diese schöne Ruhe zu behalten und eine angenehme Atmosphäre zu schaffen. Die Farbtemperatur der Strahler im schlichten Stromschienensystem MOVE IT 25 wurden an jede Höhe der sechs Etagen angepasst, um eine homogene Balance zwischen natürlichem und künstlichem Licht zu erreichen.

Chanel
Paris, FR

Architecture by
ORY Architecture

Lighting Design by
Distylight

MOVE IT 25 system







“Light is something that can add a transcendental quality to the project.”

Johan Sustrac, CEO Distylight



Distinctive

EN The goal for Press Glass headquarters – a leader in the European hybrid window industry – was to create a workplace that is environmentally conscious and benefits in many ways from the beautiful landscape. This idea is reflected in room design, geometry, materials, and lighting. The glass façade running along the outer perimeter of the building, paired with the courtyard façade, floods the interior with natural light and draws the green landscape into the office spaces. The atmosphere resembles a secluded forest cabin, which is associated with tranquillity and a focused mind, stimulating creative thinking. Dark, elegant furnishings and subtle interior lighting bring a warm touch to the social spaces. The MOVE IT system's slender design delivered an exceptionally smooth and seamless lighting implementation into the concept. This subtle and simple aesthetic helps realise the owners' vision of a distinctive building.

DE Ziel für das Press Glass Headquarters – einem führenden Unternehmen in der europäischen Kombifensterindustrie – war es, einen Arbeitsplatz zu schaffen, der naturbewusst ist und die Schönheit der umgebenden Landschaft aufnimmt. Diese Idee spiegelt sich in Raumgestaltung, Geometrie, Materialien und Beleuchtung wider. Die um den Außenumfang des Gebäudes verlaufende Glasfassade, gepaart mit der Innenhoffassade, füllt den Innenraum mit natürlichem Licht und bringt die grüne Landschaft in die Büroräume. Die Atmosphäre ähnelt einer abgelegenen Waldhütte, was man mit Ruhe sowie fokussiertem Geist verbindet und damit kreatives Denken anregt. Dunkle, elegante Einrichtungsmaterialien und dezente Innenbeleuchtung bringen eine warme Note in die Sozialräume. Das schlanke Design des MOVE IT Systems ermöglicht eine sehr fließende und nahtlose Implementierung der Beleuchtung in das Konzept. Diese subtile und zurückhaltende Ästhetik unterstützt bei der Umsetzung der Vision der EigentümerInnen dieses unverwechselbaren Gebäudes.

Press Glass Headquarters
Konopiska, PL

Architecture by
Tomasz Konior, Konior Studio

MOVE IT 25/45 system
SASSO 60
MINO 40



“I cannot imagine this particular design anywhere else. The location was the most demanding factor and, at the same time, the biggest contributor to the concept of the building.”

Marcin Piotrowski, Konior Studio



Spotlights Downlights



Spotlights & Downlights

UNICO



44 recessed ceiling wall surface wall recessed

SPIO



NEW → 86 recessed

CAVO



96 recessed

SASSO



NEW → 108 recessed



semi-recessed



ceiling

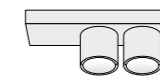

ceiling



suspended



wall surface

SASSO PRO



168 recessed

MOVE IN



NEW → 180 recessed

TWIST

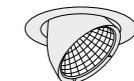

NEW → 194 recessed

SPADO



200 recessed

SQUADRO



208 recessed

BO



222



semi-recessed



surface

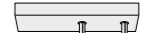

surface



track

VARO

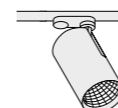

248 track

PABLO

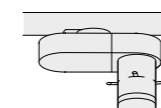

264 track

TULA



NEW → 280 suspended

ARY



288 suspended

TRACK 3-phase



300 recessed



surface



suspended

Shape the light

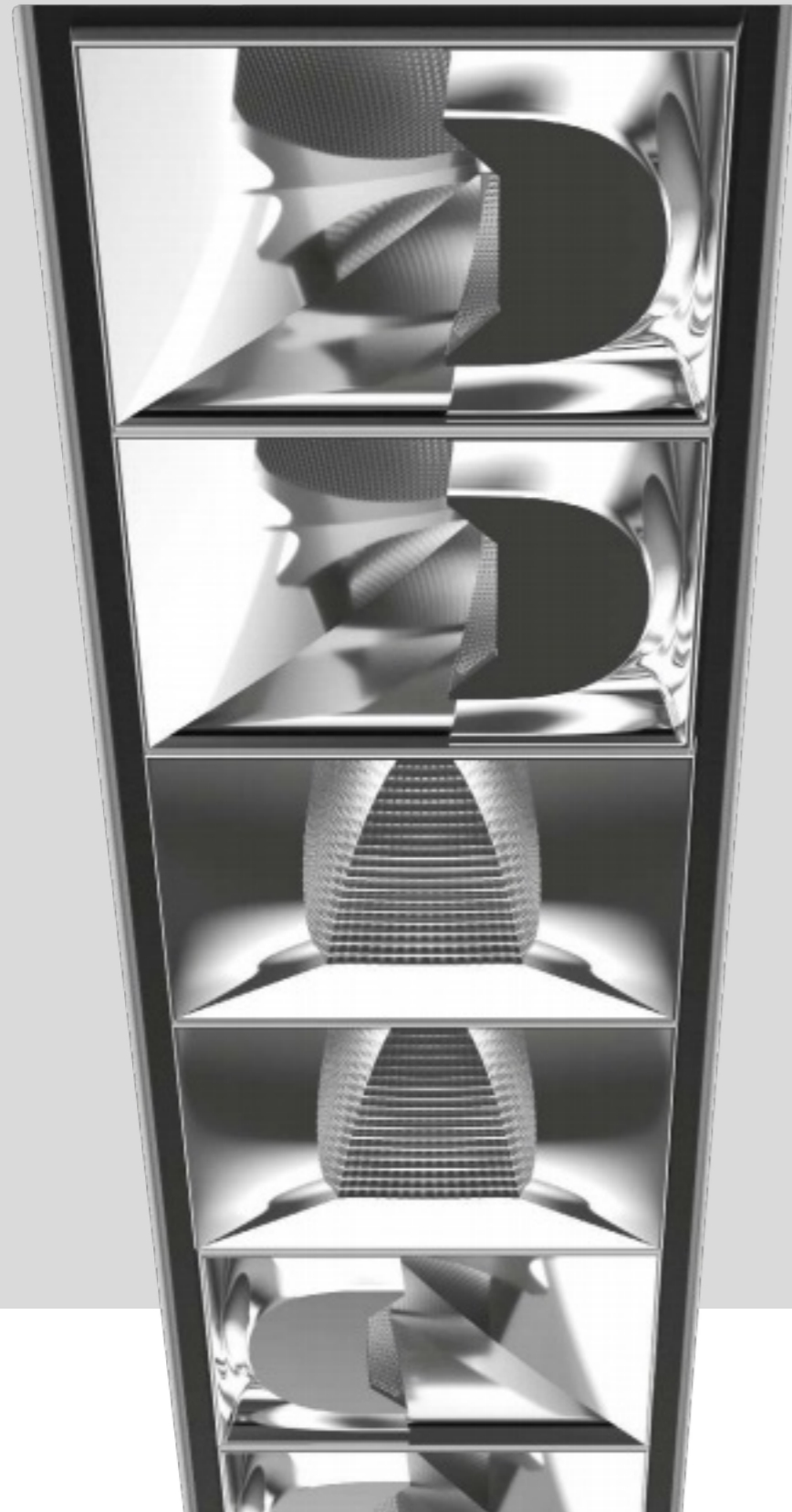

UNICO

EN With UNICO, XAL crafted a unique product built for flexibility. The luminaire offers a solution for every requirement and need. The luminaire can be shaped from five mounting options, seven shapes, eleven optics, two sensors, four colour temperatures and three control options. The intuitive UNICO configurator helps guide the flexible composition and selection of the different beam characteristics. A single luminaire has never offered this much planning freedom in professional lighting design.

DE Mit UNICO ist XAL ein Unikat in punkto Flexibilität gelungen. Die Leuchte bietet für jede Anforderung und jedes Bedürfnis eine Lösung. Aus fünf Montage-Optionen, sieben Formen, elf Optiken, zwei Sensoren, vier Farbtemperaturen und drei Steuerungsmöglichkeiten kann die Leuchte individuell kombiniert werden. Der intuitive UNICO Konfigurator unterstützt bei der flexiblen Zusammenstellung und der Auswahl der verschiedenen Abstrahlcharakteristiken. Mehr planerische Freiheit hat es bei der professionellen Lichtplanung mit einer einzigen Leuchte nie gegeben.

Types

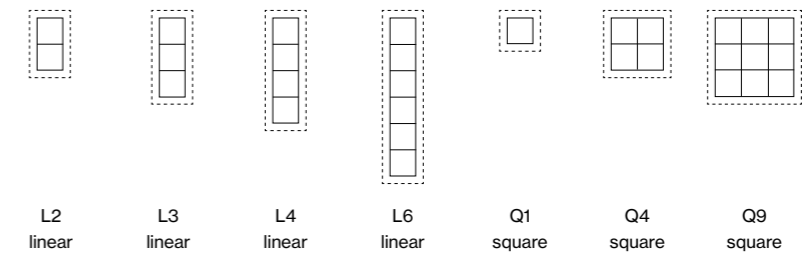

Mountings

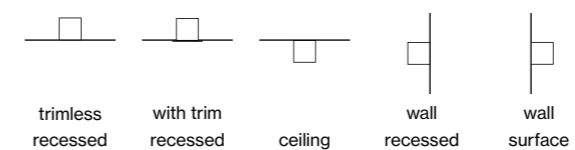

Light optics Sensors

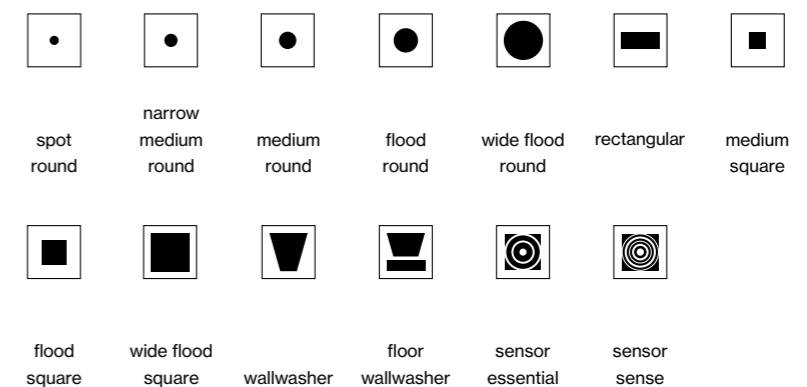

UNICO recessed



Installation housing

	Q1	Q4	Q9	L2
TYPE	with trim (white or black)	with trim (white or black)	with trim (white or black)	with trim (white or black)
CEILING THICKNESS	intermediate 2–25 mm	intermediate 2–25 mm	intermediate 2–25 mm	intermediate 2–25 mm
DIMENSION^{fax}	63 × 63 mm	101 × 101 mm	138 × 138 mm	101 × 63 mm
CUTOUT DIMENSION	50 × 50 mm	90 × 90 mm	130 × 130 mm	90 × 50 mm
RECESS DEPTH	155 mm	110 mm	90 mm	140 mm
TYPE	trimless	trimless	trimless	trimless
CEILING THICKNESS	plasterboard 12/15/20/25	plasterboard 12/15/20/25	plasterboard 12/15/20/25	plasterboard 12/15/20/25
DIMENSION	50 × 50 mm	85 × 85 mm	125 × 125 mm	88 × 50 mm
CUTOUT DIMENSION	50 × 50 mm	90 × 90 mm	130 × 130 mm	90 × 50 mm
RECESS DEPTH	155 mm	110 mm	90 mm	140 mm

	L3	L4	L6
TYPE	with trim (white or black)	with trim (white or black)	with trim (white or black)
CEILING THICKNESS	intermediate 2–25 mm	intermediate 2–25 mm	intermediate 2–25 mm
DIMENSION^{fax}	138 × 63 mm	176 × 63 mm	251 × 63 mm
CUTOUT DIMENSION	130 × 50 mm	165 × 50 mm	240 × 50 mm
RECESS DEPTH	110 mm	100 mm	100 mm
TYPE	trimless	trimless	trimless
CEILING THICKNESS	plasterboard 12/15/20/25	plasterboard 12/15/20/25	plasterboard 12/15/20/25
DIMENSION	125 × 50 mm	163 × 50 mm	238 × 50 mm
CUTOUT DIMENSION	130 × 50 mm	165 × 50 mm	240 × 50 mm
RECESS DEPTH	110 mm	100 mm	100 mm

Light optic

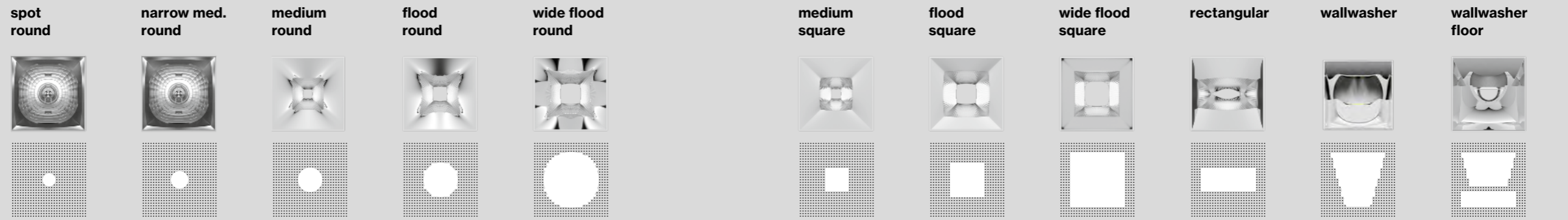

	spot round	narrow med. round	medium round	flood round	wide flood round	medium square	flood square	wide flood square	rectangular	wallwasher	wallwasher floor
LUMINOUS EFFICACY	up to 46 lm/W	up to 51 lm/W	up to 78 lm/W	up to 90 lm/W	up to 89 lm/W	up to 77 lm/W	up to 91 lm/W	up to 93 lm/W	up to 79 lm/W	up to 79 lm/W	up to 82 lm/W
LUMINOUS FLUX	179 lm, 190 lm	196 lm, 208 lm	300 lm, 319 lm	345 lm, 367 lm	342 lm, 363 lm	295 lm, 314 lm	351 lm, 373 lm	361 lm, 383 lm	305 lm, 324 lm	305 lm, 324 lm	318 lm, 338 lm
COLOUR TEMPERATURE	3000 K, 4000 K	3000 K, 4000 K	3000 K, 4000 K	3000 K, 4000 K	3000 K, 4000 K	3000 K, 4000 K	3000 K, 4000 K	3000 K, 4000 K	3000 K, 4000 K	3000 K, 4000 K	3000 K, 4000 K
COLOUR RENDERING INDEX	CRI ≥ 90	CRI ≥ 90	CRI ≥ 90	CRI ≥ 90	CRI ≥ 90	CRI ≥ 90	CRI ≥ 90	CRI ≥ 90	CRI ≥ 90	CRI ≥ 90	CRI ≥ 90

LIGHT DISTRIBUTION

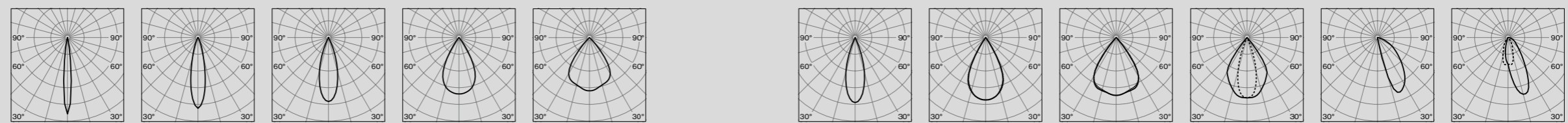

Create your own UNICO

unico.xal.com

EN XAL's UNICO is uniquely flexible. The luminaire offers a solution for every requirement. A UNICO can be flexibly assembled with eleven optics, two sensors and a selection of different light colours as well as Tunable White. XAL delivers this planning freedom with an intuitive online configurator. Solve concrete lighting concepts by creating a bespoke luminaire. unico.xal.com

DE Mit UNICO ist XAL ein Unikat in punkto Flexibilität gelungen. Für jede Anforderung bietet die Leuchte eine Lösung. Ein UNICO kann mit elf Optiken, zwei Sensoren und einer Auswahl verschiedener Lichtfarben sowie Tunable White flexibel zusammengestellt werden. Diese planerische Freiheit unterstützt XAL mit einem intuitiven Online-Konfigurator. Lösen Sie konkrete Beleuchtungskonzepte durch die flexible Zusammenstellung einer einzigartigen Leuchte: unico.xal.com

1. Define your shape

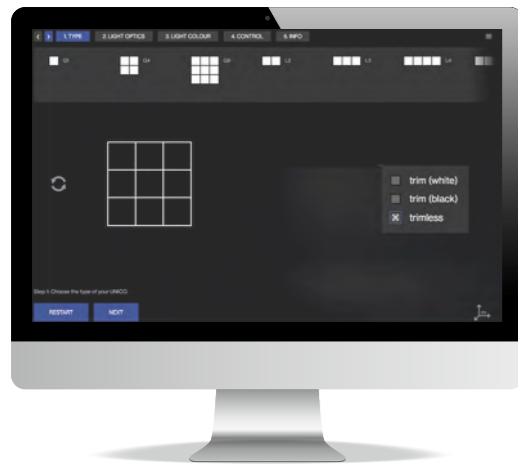

EN Select your preferred mounting type and then one of the seven shapes.

DE Wählen Sie eine passende Montageart und anschließend eine der sieben Formen aus.

2. Choose your light optic and colour



EN Combine the eleven light insets and two sensors. Then select the desired light temperature 2700K, 3000K, 4000K or Tunable White.

DE Kombinieren Sie die elf Lichteinsätze sowie zwei Sensoren und wählen Sie die passende Lichttemperatur 2700K, 3000K, 4000K oder Tunable White, beliebig nach Ihren Anforderungen.

3. Control



EN The configurator helps you set up a maximum of four control channels.

DE Mit Hilfe des Konfigurators können Sie bis zu vier Steuerungskanäle einrichten.

4. Info



EN Get an overview of your configured UNICO. You can download all the specifications as a datasheet.

DE Verschaffen Sie sich einen Überblick über Ihren konfigurierten UNICO. Zusätzlich haben Sie die Möglichkeit sich alle Informationen in Form eines Datenblattes herunterzuladen.

One luminaire – four channels – various light scenes

EN Use the online configurator and address concrete lighting concepts by creating a bespoke luminaire. Assign each optic in a UNICO to one of up to four control channels. Each of the four channels can then be dimmed and controlled separately. Control is via DALI-2 or Zigbee 3.0. Just one luminaire can create custom lighting scenarios for every application. There has never been more freedom in professional lighting design delivered by a single luminaire.

DE Nutzen Sie den Online-Konfigurator um konkrete Beleuchtungskonzepte durch die flexible Zusammenstellung der Optiken umzusetzen. Weisen Sie jede Optik in einer UNICO einem der bis zu vier Steuerungskanäle zu. Jeder der vier Kanäle kann dann separat gedimmt und angesteuert werden. Mit nur einer Leuchte realisieren Sie so für jede Anwendung individuelle Lichtszenarien. Die Steuerung erfolgt via DALI-2 oder Zigbee 3.0. Mehr Freiheit hat es bei der professionellen Lichtplanung mit einer einzigen Leuchte nie gegeben.

Light scene 1 wall

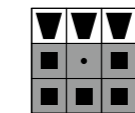
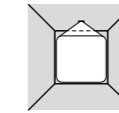

3 × wallwasher



Light scene 2 wall + floor

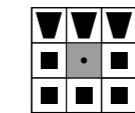
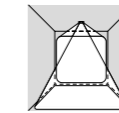

3 × wallwasher
5 × flood square



Light scene 3 floor

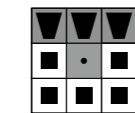
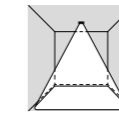

5 × flood square



Light scene 4 spots

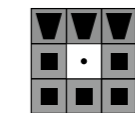
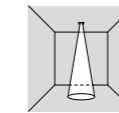

1 × spot round



92.2 quadrillion possibilities

EN The luminaire can be customised from five mounting options, seven shapes, eleven light insets, two sensors, four colour temperatures, and three control options. The downlight optics for generating round or angular light projections are available with different beam characteristics. There are also rectangular downlights and wallwasher optics for wall or wall / floor lighting. Highly glare-free versions (UGR ≤ 19) are ideal for use at computer workstations. Dedicated sensors help adjust the lighting according to daylight and room activity. In addition, the reflectors are available in the colours chrome, black, and gold. Values such as temperature, air quality, and noise levels can be recorded. This delivers valuable knowledge about the conditions of your premises.

DE Aus fünf Montageoptionen, sieben Formen, elf Lichteinsätzen, zwei Sensoren, vier Farbtemperaturen und drei Steuerungsmöglichkeiten kann die Leuchte individuell kombiniert werden. Die Downlight-Optiken zur Generierung runder oder eckiger Lichtprojektionen gibt es mit unterschiedlichen Abstrahlcharakteristiken. Zusätzlich gibt es rechteckige Downlights und Wallwasher-Optiken für Wand- oder Wand / Boden-Beleuchtung. Hochentblendete Versionen (UGR ≤ 19) sind ideal für den Einsatz an Bildschirmarbeitsplätzen. Zudem sind die Reflektoren in den Farben Chrome, Schwarz und Gold verfügbar. Spezielle Sensoren ermöglichen es die Beleuchtung an Tageslicht und Raumaktivität anzupassen, sowie Werte wie Temperatur, Luftqualität und Geräuschpegel zu erfassen. Hiermit lassen sich wertvolle Erkenntnisse über die Umgebungsbedingungen Ihrer Räumlichkeiten gewinnen.



Q1 trimless

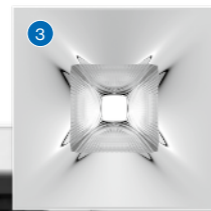
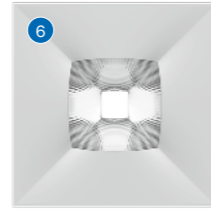

L3 trimless tunable white

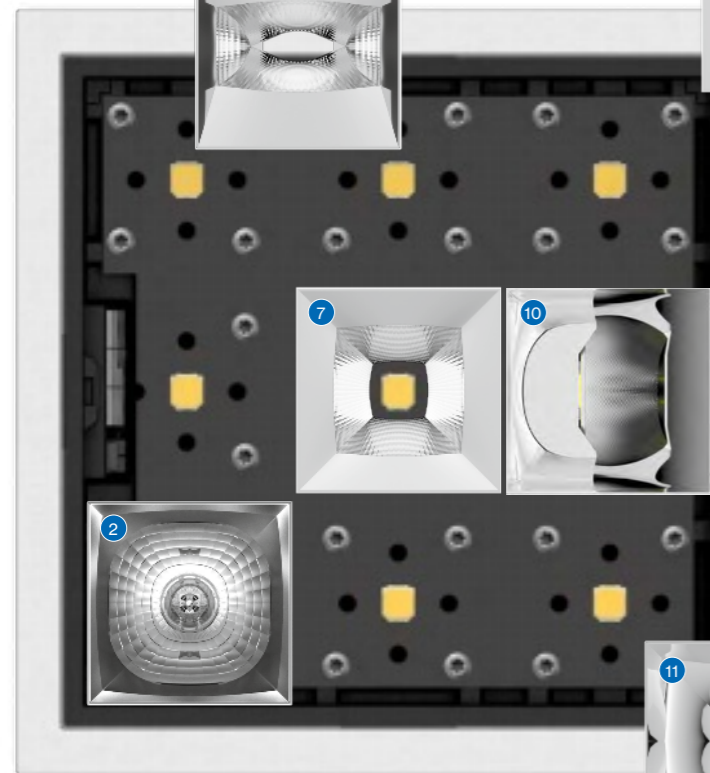
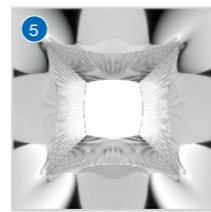

Q9 with trim

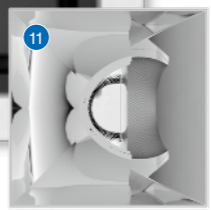
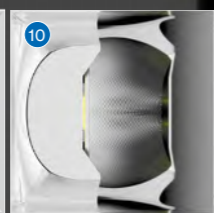
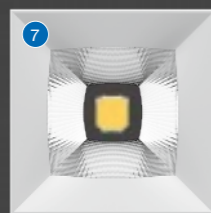

11 light optics and 2 sensors

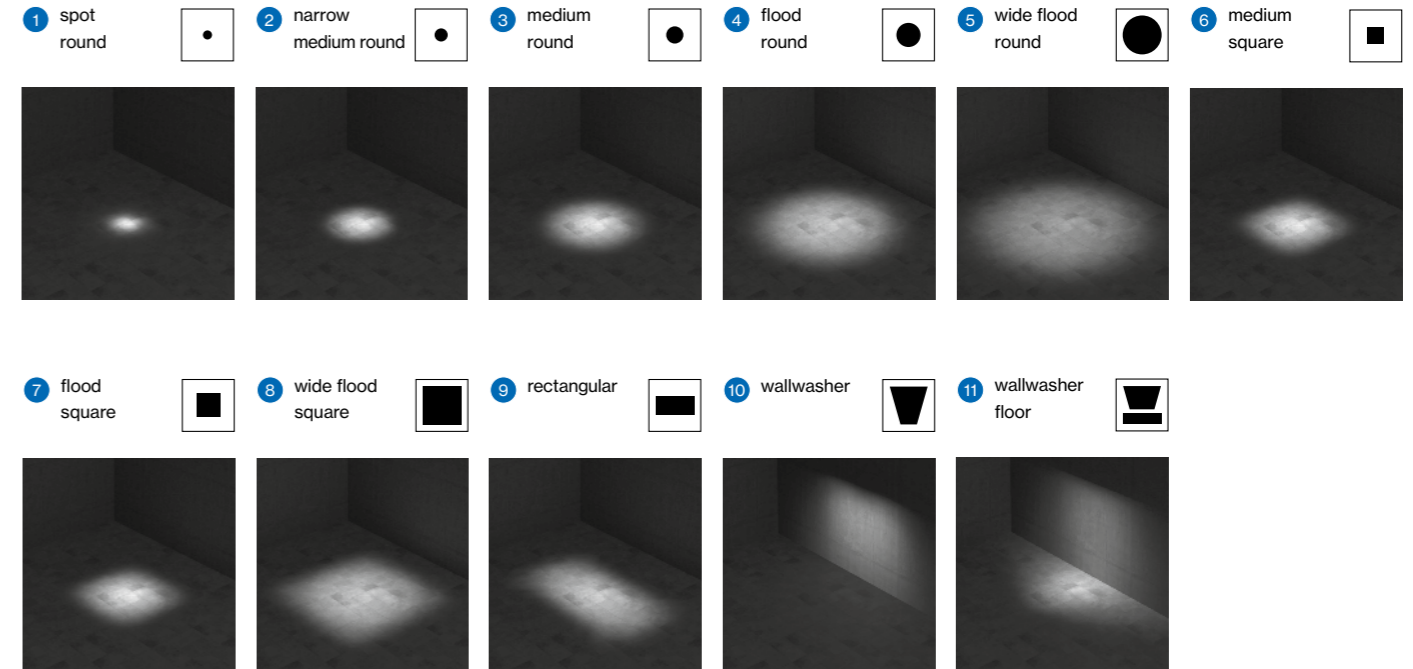

Sensors

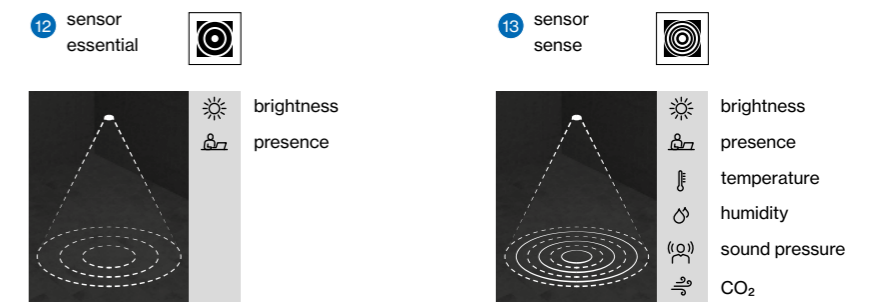

Precision cut-off

EN XAL Light optics deliver the latest development in the field of micro-faceted reflector technology. Architects and lighting planners have entirely new design options thanks to clearly defined contrasts and maximised efficiency. Compared with conventional optics, XAL Light optics offer, with the same beam angle, a clearly defined light cone break with minimal stray light at the edges.

DE Mit XAL Light optics bietet XAL die neueste Entwicklung auf dem Gebiet der mikro-facettierten Reflektortechnologie. Für ArchitektInnen und LichtplanerInnen ergeben sich dank klar definierter Kontraste bei gleichzeitig maximierter Effizienz völlig neue Gestaltungsmöglichkeiten. Verglichen mit konventionellen Optiken bieten XAL Light optics bei gleichem Abstrahlwinkel einen klar begrenzten Lichtkegelabriss mit wenig Streulicht im Randbereich.

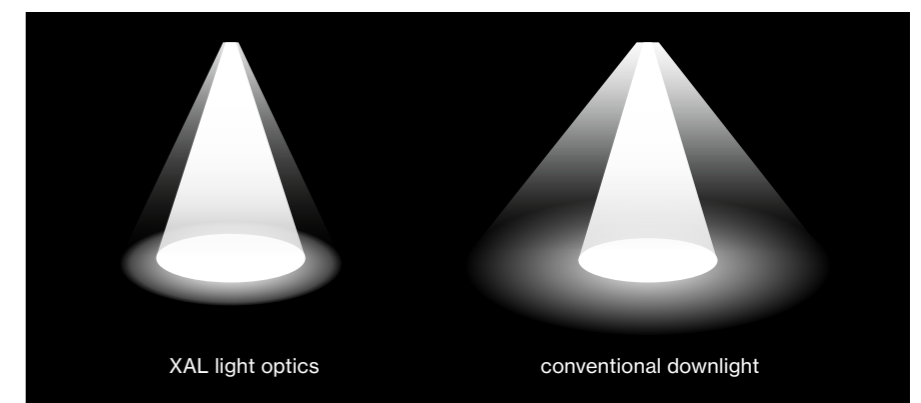
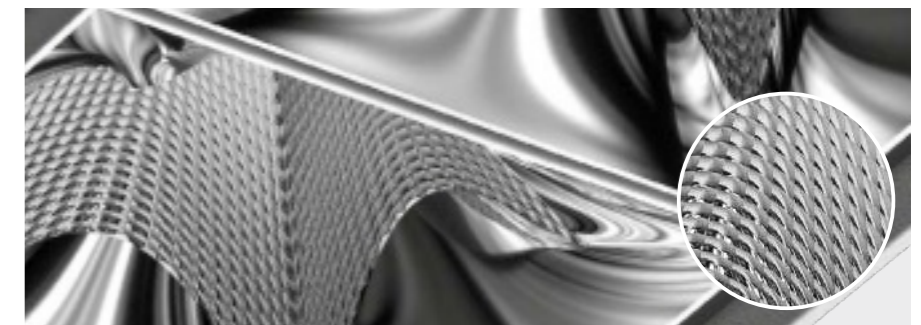



UNICO linear

recessed

EN Rectangular recessed multi-downlight made of die-cast aluminium; equipped with two (L2) / three (L3) / four (L4) / six (L6) individually selectable or pre-specified, customised light elements; installation without tools in mounting set with ball catch system; easy electrical installation by means of reverse polarity protected plug-in connections; suitable for ceiling thickness of 2-25 mm; surface powder coated; installation possible in different housings; high-quality reflector with micro-faceted, aluminium-vaporised surface; precise radiation characteristic with different symmetrical light distributions; or with asymmetric light distribution; energy-efficient high power LEDs with very good colour rendering; clank-free

DE Rechteckiger Einbau-Multi-Downlight aus Aluminiumdruckguss; bestückt mit zwei (L2) / drei (L3) / vier (L4) / sechs (L6) individuell wählbaren oder fix definierten, anwendungsspezifischen Optiken; werkzeuglose Montage im Montageset durch Kugelschnappsystem; einfache elektrische Montage durch verpolungssichere Steckverbindung; geeignet für Deckenstärken von 2-25 mm; Oberfläche pulverbeschichtet; Einbau in unterschiedlichen Gehäusen möglich; hochwertiger Reflektor mit mikrofacettierter, aluminiumbedampfter Oberfläche; präzise Abstrahlcharakteristik mit unterschiedlichen symmetrischen Lichtverteilungen; oder mit asymmetrischer Lichtverteilung; energieeffiziente High-Power-LEDs mit sehr guter Farbwiedergabe; klirrfrei

Quickinfo

2700 K, 3000 K, 4000 K
CRI ≥ 90, 3 SDCM
UGR ≤ 19 / 65° ≤ 1500 cd/m²
L2 up to 98 lm/W
L3 up to 99 lm/W
L4 up to 112 lm/W
L6 up to 112 lm/W
L90 @ 50 000 h
non DIM, DALI-2

Types

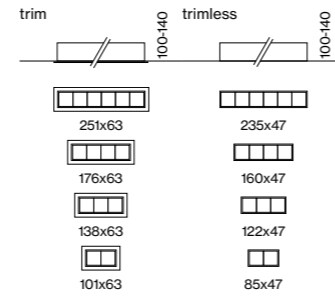

Colours



Light optics

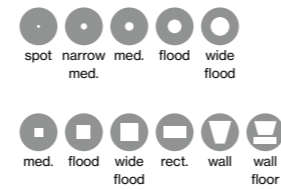

DiiA® standards
251, 252, 253

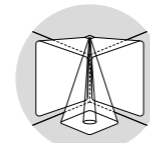

one luminaire
multiple scenes

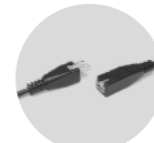

plug / socket
connector

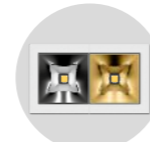

black & gold
reflector



tunable white
2700–5000 K

Order options

COLOUR TEMPERATURE	
2700 K	4
3000 K	5
4000 K	6

CONTROL	
non DIM	1
DALI-2	3

LIGHT OPTIC	
spot round (UGR ≤ 10)	K
narrow medium round (UGR ≤ 10)	N
medium round (UGR ≤ 10)	B
medium square (UGR ≤ 10)	E
flood round (UGR ≤ 16)	C
flood square (UGR ≤ 19)	F
wide flood round	D
wide flood square	G

MATERIAL COLOUR	
○ traffic white RAL 9016	W
● jet black RAL 9005	B

LIGHT OPTIC COLOUR	
chrome reflector	0
black reflector*	B

*not available for spot round, narrow medium round and wallwasher

Options on request

COLOUR TEMPERATURE
tunable white 2700–5000 K
DALI-2 DT8

LIGHT OPTIC COLOUR	
gold reflector	

MOUNTING SET	
acoustic soft ceilings	

Product configurator



Create your own UNICO PRO
unico.xal.com

Planning information

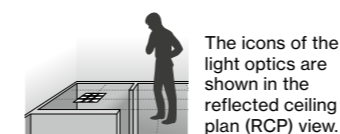

The icons of the light optics are shown in the reflected ceiling plan (RCP) view.

UNICO L2 basic recessed

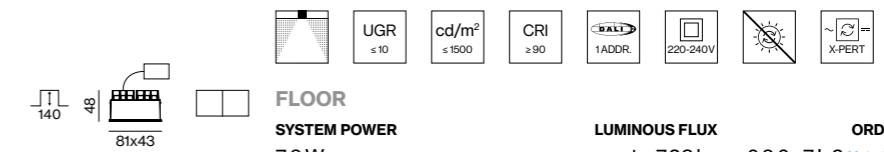

FLOOR	SYSTEM POWER	LUMINOUS FLUX	ORDER CODE
	7.9 W	up to 723 lm	090-7L2::▲0■21

choose one light optic ▲ from the options on the left depending on your room needs

WALL	SYSTEM POWER	LUMINOUS FLUX	ORDER CODE
2x wallwasher	7.9 W	611 lm	090-7L2::▲A022

CORRIDOR	SYSTEM POWER	LUMINOUS FLUX	ORDER CODE
2x rectangular	7.9 W	610 lm	090-7L2::▲R0■21

WALL + FLOOR	SYSTEM POWER	LUMINOUS FLUX	ORDER CODE
2x wallwasher floor	7.9 W	638 lm	090-7L2::▲W0■22

UNICO L3 basic recessed

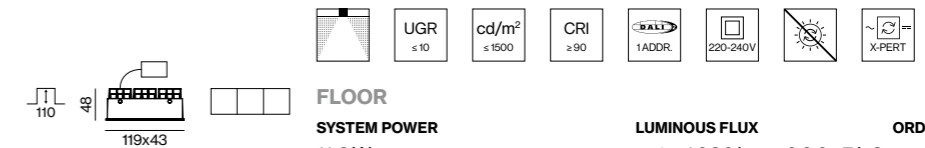

FLOOR	SYSTEM POWER	LUMINOUS FLUX	ORDER CODE
	11.2 W	up to 1030 lm	090-7L3::▲0■21

choose one light optic ▲ from the options on the left depending on your room needs

WALL	SYSTEM POWER	LUMINOUS FLUX	ORDER CODE
3x wallwasher	11.2 W	872 lm	090-7L3::▲A021

Accessories

MOUNTING SET WITH TRIM	for intermediate ceilings 2–25 mm		
TYPE	L-W-H (mm)	CUTOUT (mm)	ORDER CODE
L2	101-63-30	90-50	090-7L2020■
L3	138-63-30	130-50	090-7L3020■

TRIMLESS MOUNTING SET	for installation in plasterboard ceilings 12.5/15/20/25 mm		
TYPE	L-W-H (mm)	CUTOUT (mm)	ORDER CODE
L2	88-50-47	90-50	090-7L20100
L3	125-50-47	130-50	090-7L30100

THROUGH WIRING CONNECTION BOX			
TYPE	L-W-H (mm)	ORDER CODE	
non DIM cable ø 4–12 mm	105-58-30	005-2531110	
DALI cable ø 4–12 mm	105-58-30	005-2551110	

LUMINOUS FLUX value calculated for 3000 K, CRI ≥ 90, colour white, reflector chrome 2700 K -6%, 4000 K +7%

← back

Order options

COLOUR TEMPERATURE

2700K	4
3000K	5
4000K	6

CONTROL

non DIM	1
DALI-2	3

LIGHT OPTIC

spot round (UGR≤10)	K
narrow medium round (UGR≤10)	N
medium round (UGR≤10)	B
medium square (UGR≤10)	E
flood round (UGR≤16)	C
flood square (UGR≤19)	F
wide flood round	D
wide flood square	G

MATERIAL COLOUR

○ traffic white RAL 9016	W
● jet black RAL 9005	B

LIGHT OPTIC COLOUR

chrome reflector	0
black reflector*	B

*not available for spot round, narrow medium round and wallwasher

Options on request

COLOUR TEMPERATURE

tunable white 2700–5000K
DALI-2 DT8

LIGHT OPTIC COLOUR

gold reflector

MOUNTING SET

acoustic soft ceilings

Product configurator



Create your own UNICO PRO

unico.xal.com

Planning information

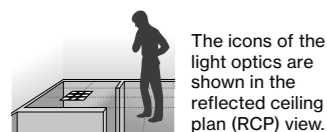

The icons of the light optics are shown in the reflected ceiling plan (RCP) view.

UNICO L4 basic recessed



FLOOR

SYSTEM POWER	LUMINOUS FLUX	ORDER CODE
13.9W	up to 1450lm	090-7L4::▲0■21

choose one light optic ▲ from the options on the left depending on your room needs



WALL

4x wallwasher

SYSTEM POWER	LUMINOUS FLUX	ORDER CODE
13.9W	1220lm	090-7L4::◆A0021



WALL + FLOOR

4x wallwasher floor

SYSTEM POWER	LUMINOUS FLUX	ORDER CODE
13.9W	1280lm	090-7L4::◆W0■22

Accessories

MOUNTING SET WITH TRIM

for intermediate ceilings 2–25mm

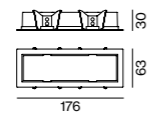

TYPE	L-W-H (mm)	CUTOUT (mm)	ORDER CODE
L4	176-63-30	165-50	090-7L4020

TRIMLESS MOUNTING SET

for installation in plasterboard ceilings 12.5/15/20/25mm

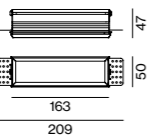

TYPE	L-W-H (mm)	CUTOUT (mm)	ORDER CODE
L4	163-50-47	165-50	090-7L40100

THROUGH WIRING CONNECTION BOX

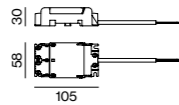

TYPE	L-W-H (mm)	ORDER CODE
non DIM cable ø4–12mm	105-58-30	005-2531110
DALI cable ø4–12mm	105-58-30	005-2551110

Order options

COLOUR TEMPERATURE

2700K	4
3000K	5
4000K	6

CONTROL

non DIM	1
DALI-2	3

LIGHT OPTIC

spot round (UGR≤10)	K
narrow medium round (UGR≤10)	N
medium round (UGR≤10)	B
medium square (UGR≤10)	E
flood round (UGR≤16)	C
flood square (UGR≤19)	F
wide flood round	D
wide flood square	G

MATERIAL COLOUR

○ traffic white RAL 9016	W
● jet black RAL 9005	B

LIGHT OPTIC COLOUR

chrome reflector	0
black reflector*	B

*not available for spot round, narrow medium round and wallwasher

Options on request

COLOUR TEMPERATURE

tunable white 2700–5000K
DALI-2 DT8

LIGHT OPTIC COLOUR

gold reflector

MOUNTING SET

acoustic soft ceilings

UNICO L6 basic recessed



FLOOR

SYSTEM POWER	LUMINOUS FLUX	ORDER CODE
19.8W	up to 2060lm	090-7L6::▲0■21

choose one light optic ▲ from the options on the left depending on your room needs



WALL

6x wallwasher

SYSTEM POWER	LUMINOUS FLUX	ORDER CODE
19.8W	1740lm	090-7L6::◆A0021



CORRIDOR

6x rectangular

SYSTEM POWER	LUMINOUS FLUX	ORDER CODE
19.8W	1740lm	090-7L6::◆R0■21



WALL + FLOOR

6x wallwasher floor

SYSTEM POWER	LUMINOUS FLUX	ORDER CODE
19.8W	1820lm	090-7L6::◆W0■21

Accessories

MOUNTING SET WITH TRIM

for intermediate ceilings 2–25mm

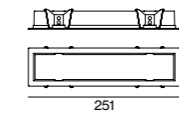

TYPE	L-W-H (mm)	CUTOUT (mm)	ORDER CODE
L6	251-63-30	240-50	090-7L6020

TRIMLESS MOUNTING SET

for installation in plasterboard ceilings 12.5/15/20/25mm

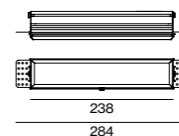

TYPE	L-W-H (mm)	CUTOUT (mm)	ORDER CODE
L6	238-50-47	240-50	090-7L60100

THROUGH WIRING CONNECTION BOX

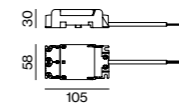

TYPE	L-W-H (mm)	ORDER CODE
non DIM cable ø4–12mm	105-58-30	005-2531110
DALI cable ø4–12mm	105-58-30	005-2551110

LUMINOUS FLUX value calculated for 3000K, CRI≥90, colour white, reflector chrome
2700K -6%, 4000K +7%

LUMINOUS FLUX value calculated for 3000K, CRI≥90, colour white, reflector chrome
2700K -6%, 4000K +7%



West Tower
Manchester, UK – by SimpsonHaugh with
lighting design by Troup, Bywaters & Anders





Penthouse Wörthersee
Carinthia, AT – by ROOMS GmbH



← back

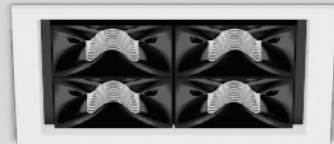
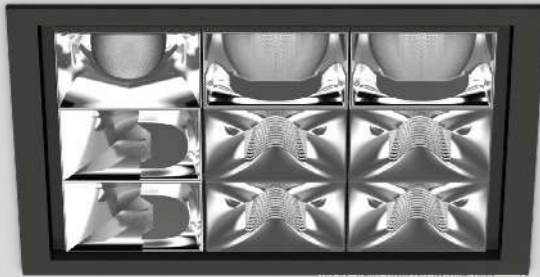

UNICO square

recessed

EN Square recessed multi-downlight made of die-cast aluminium; equipped with one (Q1) / four (Q4) / nine (Q9) individually selectable or pre-specified, customised light element(s); or with a sensor; installation without tools in mounting set with ball catch system; easy electrical installation by means of reverse polarity protected plug-in connections; suitable for ceiling thickness of 2-25 mm; surface powder coated; installation possible in different housings; high-quality reflector with micro-faceted, aluminum-vaporised surface; precise radiation characteristic with different symmetrical light distributions; or with asymmetric light distribution; energy-efficient high power LEDs with very good colour rendering; clank-free

DE Quadratischer Einbau-Multi-Downlight aus Aluminiumdruckguss; bestückt mit einer (Q1) / vier (Q4) / neun (Q9) individuell wählbaren oder fix definierten, anwendungsspezifischen Optik(en); oder mit einem Sensor (Q1); werkzeuglose Montage im Montageset durch Kugelschnappsystem; einfache elektrische Montage durch verpolungssichere Steckverbindung; geeignet für Deckenstärken von 2-25 mm; Oberfläche pulverbeschichtet; Einbau in unterschiedlichen Gehäusen möglich; hochwertiger Reflektor mit mikrofacetierter, aluminiumbedampfter Oberfläche; präzise Abstrahlcharakteristik mit unterschiedlichen symmetrischen Lichtverteilungen; oder mit asymmetrischer Lichtverteilung; energieeffiziente High-Power-LEDs mit sehr guter Farbwiedergabe; klirrfrei

Quickinfo

2700 K, 3000 K, 4000 K
CRI ≥ 90, 3 SDCM
UGR ≤ 19 / 65° ≤ 1500 cd/m²
Q1 up to 85 lm/W
Q4 up to 112 lm/W
Q9 up to 111 lm/W
L90 @ 50 000 h
non DIM, DALI-2

Types

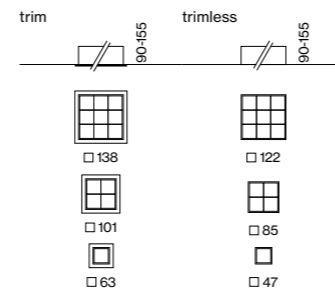

Colours



Light optics / sensors

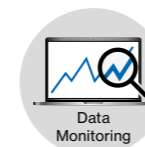

DiiA® standards
251, 252, 253



sensor version
available

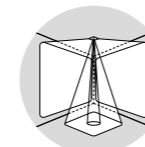

one luminaire
multiple scenes

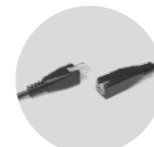

plug / socket
connector

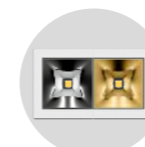

black & gold
reflector

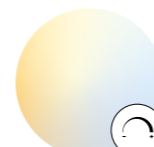

tunable white
2700-5000K

Order options

COLOUR TEMPERATURE	
2700 K	4
3000 K	5
4000 K	6

CONTROL	
non DIM	1
DALI-2	3

LIGHT OPTIC	
spot round (UGR ≤ 10)	K
narrow medium round (UGR ≤ 10)	N
medium round (UGR ≤ 10)	B
medium square (UGR ≤ 10)	E
flood round (UGR ≤ 16)	C
flood square (UGR ≤ 19)	F
wide flood round	D
wide flood square	G

MATERIAL COLOUR	
○ traffic white RAL 9016	W
● jet black RAL 9005	B

LIGHT OPTIC COLOUR	
chrome reflector	0
black reflector*	B

*not available for spot round, narrow medium round and wallwasher

Options on request

COLOUR TEMPERATURE	
tunable white 2700-5000K	
DALI-2 DT8	

LIGHT OPTIC COLOUR	
gold reflector	

MOUNTING SET	
acoustic soft ceilings	

Product configurator



Create your own UNICO PRO
unico.xal.com

Planning information

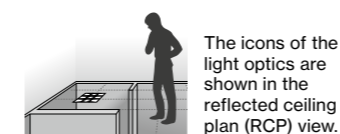

The icons of the light optics are shown in the reflected ceiling plan (RCP) view.

UNICO Q1 basic recessed

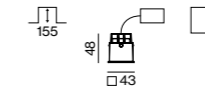

FLOOR	SYSTEM POWER	LUMINOUS FLUX	ORDER CODE
	6 W	up to 490 lm	090-7 Q 1 :: A 0 2 1

choose one light optic ▲ from the options on the left depending on your room needs

WALL	SYSTEM POWER	LUMINOUS FLUX	ORDER CODE
1x wallwasher	6 W	up to 415 lm	090-7 Q 1 :: A 0 2 1

CORRIDOR	SYSTEM POWER	LUMINOUS FLUX	ORDER CODE
1x rectangular	6 W	up to 414 lm	090-7 Q 1 :: R 0 2 1

WALL + FLOOR	SYSTEM POWER	LUMINOUS FLUX	ORDER CODE
1x wallwasher floor	6 W	up to 432 lm	090-7 Q 1 :: W 0 2 1

UNICO Q1 sensor recessed

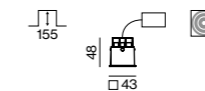

ESSENTIAL SENSOR	TYPE	ORDER CODE
	brightness & presence	090-7 Q 1 0 0 0 0



SENSE SENSOR	TYPE	ORDER CODE
	brightness, presence, temperature, sound pressure, humidity, CO ₂	090-7 Q 1 0 0 1 0

Accessories

MOUNTING SET WITH TRIM	for intermediate ceilings 2-25 mm		ORDER CODE
TYPE	L-W-H (mm)	CUTOUT (mm)	
Q1	63-63-30	50-50	090-7 Q 1 0 2 0 2

TRIMLESS MOUNTING SET	for installation in plasterboard ceilings 12.5/15/20/25 mm		ORDER CODE
TYPE	L-W-H (mm)	CUTOUT (mm)	
Q1	50-50-47	50-50	090-7 Q 1 0 1 0 0

LUMINOUS FLUX value calculated for 3000 K, CRI ≥ 90, colour white, reflector chrome 2700 K -6%, 4000 K +7%

← back

Order options

COLOUR TEMPERATURE

2700K	4
3000K	5
4000K	6

CONTROL

non DIM	1
DALI-2	3

LIGHT OPTIC

spot round (UGR≤10)	K
narrow medium round (UGR≤10)	N
medium round (UGR≤10)	B
medium square (UGR≤10)	E
flood round (UGR≤16)	C
flood square (UGR≤19)	F
wide flood round	D
wide flood square	G

MATERIAL COLOUR

○ traffic white RAL 9016	W
● jet black RAL 9005	B

LIGHT OPTIC COLOUR

chrome reflector	0
black reflector*	B

*not available for spot round, narrow medium round and wallwasher

Options on request

COLOUR TEMPERATURE

tunable white 2700–5000K	
--------------------------	--

DALI-2 DT8

LIGHT OPTIC COLOUR

gold reflector	
----------------	--

MOUNTING SET

acoustic soft ceilings	
------------------------	--

Product configurator

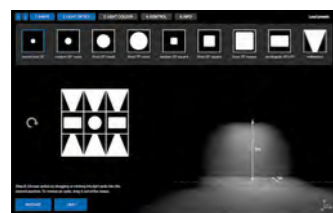

Create your own UNICO PRO
unico.xal.com

Planning information

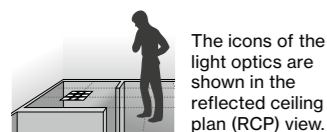

The icons of the light optics are shown in the reflected ceiling plan (RCP) view.

UNICO Q4 basic recessed

UGR ≤10 **cd/m²** ≤1500 **CRI** ≥90 **DALI** 1ADDR. **220-240V** **XPERT**

FLOOR

SYSTEM POWER	LUMINOUS FLUX	ORDER CODE
13.9W	up to 1450lm	090-7Q4::▲021

choose one light optic ▲ from the options on the left depending on your room needs

WALL

SYSTEM POWER	LUMINOUS FLUX	ORDER CODE
13.9W	1220lm	090-7Q4::▲A0021

CORRIDOR

SYSTEM POWER	LUMINOUS FLUX	ORDER CODE
13.9W	1220lm	090-7Q4::▲A0022

WALL + FLOOR

SYSTEM POWER	LUMINOUS FLUX	ORDER CODE
13.9W	1200lm	090-7Q4::▲90021

CORNER + FLOOR

SYSTEM POWER	LUMINOUS FLUX	ORDER CODE
13.9W	1200lm	090-7Q4::▲90022

WALL + FLOOR

SYSTEM POWER	LUMINOUS FLUX	ORDER CODE
13.9W	1280lm	090-7Q4::▲W021

Accessories

MOUNTING SET WITH TRIM
for intermediate ceilings 2–25 mm

TYPE	L-W-H (mm)	CUTOUT (mm)	ORDER CODE
Q4	101-101-30	90-90	090-7Q4020

TRIMLESS MOUNTING SET
for installation in plasterboard ceilings 12.5/15/20/25 mm

TYPE	L-W-H (mm)	CUTOUT (mm)	ORDER CODE
Q4	85-85-47	90-90	090-7Q40100

THROUGH WIRING CONNECTION BOX

TYPE	L-W-H (mm)	ORDER CODE
non DIM cable ø4–12mm	105-58-30	005-2531110
DALI cable ø4–12mm	105-58-30	005-2551110

LUMINOUS FLUX value calculated for
3000K, CRI≥90, colour white, reflector chrome
2700K -6%, 4000K +7%

Order options

COLOUR TEMPERATURE

2700K	4
3000K	5
4000K	6

CONTROL

non DIM	1
DALI-2	3

LIGHT OPTIC

spot round (UGR≤10)	K
narrow medium round (UGR≤10)	N
medium round (UGR≤10)	B
medium square (UGR≤10)	E
flood round (UGR≤16)	C
flood square (UGR≤19)	F
wide flood round	D
wide flood square	G

MATERIAL COLOUR

○ traffic white RAL 9016	W
● jet black RAL 9005	B

LIGHT OPTIC COLOUR

chrome reflector	0
black reflector*	B

*not available for spot round, narrow medium round and wallwasher

Options on request

COLOUR TEMPERATURE

tunable white 2700–5000K	
--------------------------	--

DALI-2 DT8

LIGHT OPTIC COLOUR

gold reflector	
----------------	--

MOUNTING SET

acoustic soft ceilings	
------------------------	--

LUMINOUS FLUX value calculated for
3000K, CRI≥90, colour white, reflector chrome
2700K -6%, 4000K +7%

UNICO Q9 basic recessed

UGR ≤10 **cd/m²** ≤1500 **CRI** ≥90 **DALI** 1ADDR. **220-240V** **XPERT**

FLOOR

SYSTEM POWER	LUMINOUS FLUX	ORDER CODE
32W	up to 3310lm	090-7Q9::▲021

choose one light optic ▲ from the options on the left depending on your room needs

WALL

SYSTEM POWER	LUMINOUS FLUX	ORDER CODE
32W	2800lm	090-7Q9::▲A0021

WALL + FLOOR

SYSTEM POWER	LUMINOUS FLUX	ORDER CODE
32W	3080lm	090-7Q9::▲90021

WALL + CORRIDOR

SYSTEM POWER	LUMINOUS FLUX	ORDER CODE
32W	2790lm	090-7Q9::▲90022

WALL + FLOOR

SYSTEM POWER	LUMINOUS FLUX	ORDER CODE
32W	2920lm	090-7Q9::▲W021

Accessories

MOUNTING SET WITH TRIM
for intermediate ceilings 2–25 mm

TYPE	L-W-H (mm)	CUTOUT (mm)	ORDER CODE
Q9	138-138-30	130-130	090-7Q9020

TRIMLESS MOUNTING SET
for installation in plasterboard ceilings 12.5/15/20/25 mm

TYPE	L-W-H (mm)	CUTOUT (mm)	ORDER CODE
Q9	125-125-47	130-130	090-7Q90100

THROUGH WIRING CONNECTION BOX

TYPE	L-W-H (mm)	ORDER CODE
non DIM cable ø4–12mm	105-58-30	005-2531110
DALI cable ø4–12mm	105-58-30	005-2551110

LUMINOUS FLUX value calculated for
3000K, CRI≥90, colour white, reflector chrome
2700K -6%, 4000K +7%



Aertssen Group Beveren, BE –
by Mertens Architecten with
lighting design by Eef Debeuf



Fortuna Financial Group
Antwerp, BE – by Kris Rymenants
Architectenbureau



← back

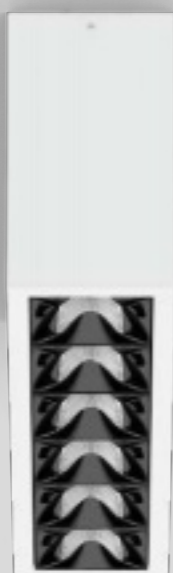
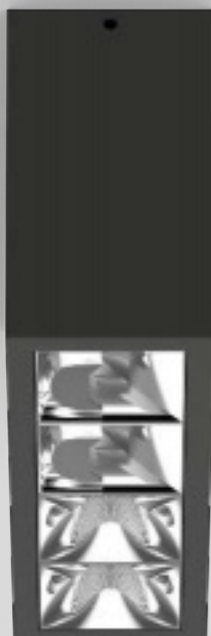

UNICO linear ceiling

EN Rectangular surface mounted multi-downlight made of aluminium; equipped with two (L2) / three (L3) / four (L4) / six (L6) individually selectable or pre-specified, customised light elements; luminaire housing can be attached to mounting plate without tools by interlock; converter integrated into luminaire housing; surface powder coated; high-quality reflector with micro-faceted, aluminum-vaporised surface; precise radiation characteristic with different symmetrical light distributions; or with asymmetric light distribution; energy-efficient high power LEDs with very good colour rendering; clank-free

DE Rechteckiger Anbau-Multi-Downlight aus Aluminium; bestückt mit zwei (L2) / drei (L3) / vier (L4) / sechs (L6) individuell wählbaren oder fix definierten, anwendungsspezifischen Optiken; Leuchtenkörper mittels Verriegelung werkzeuglos auf Montageplatte aufsetzbar; Konverter im Leuchtenkörper integriert; Oberfläche pulverbeschichtet; hochwertiger Reflektor mit mikrofacettierter, aluminiumbedampfter Oberfläche; präzise Abstrahlcharakteristik mit unterschiedlichen symmetrischen Lichtverteilungen; oder mit asymmetrischer Lichtverteilung; energieeffiziente High-Power-LEDs mit sehr guter Farbwiedergabe; klirrfrei

Quickinfo

2700 K, 3000 K, 4000 K
 CRI ≥ 90, 3 SDCM
 UGR ≤ 19 / 65° ≤ 3000 cd/m²
 L2 up to 95 lm/W
 L3 up to 97 lm/W
 L4 up to 103 lm/W
 L6 up to 103 lm/W
 L90 @ 50 000h
 non DIM, DALI-2

Types

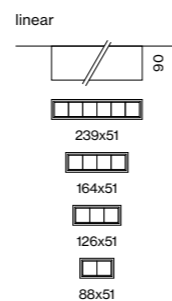

Colours



Light optics



Order options

COLOUR TEMPERATURE	
2700 K	4
3000 K	5
4000 K	6
CONTROL	
non DIM	1
DALI-2	3

LIGHT OPTIC	
spot round (UGR ≤ 10)	K
narrow medium round (UGR ≤ 10)	N
medium round (UGR ≤ 10)	B
medium square (UGR ≤ 10)	E
flood round (UGR ≤ 16)	C
flood square (UGR ≤ 19)	F
wide flood round	D
wide flood square	G

MATERIAL COLOUR	
○ traffic white RAL 9016	W
● white aluminium RAL 9006	G
● jet black RAL 9005	B
● gold dust RAL 260-M	9

LIGHT OPTIC COLOUR	
chrome reflector	0
black reflector*	B

*not available for spot round, narrow medium round and wallwasher

Options on request

COLOUR TEMPERATURE	
tunable white 2700–5000 K	
DALI-2 DT8	

LIGHT OPTIC COLOUR	
gold reflector	

Product configurator



Create your own UNICO PRO
unico.xal.com

Planning information

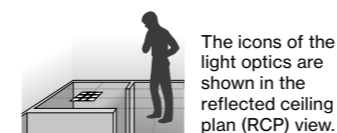

The icons of the light optics are shown in the reflected ceiling plan (RCP) view.

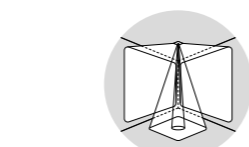

one luminaire multiple scenes

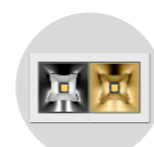

black & gold reflector

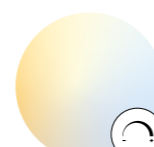

tunable white 2700–5000 K

Order options

COLOUR TEMPERATURE	
2700 K	4
3000 K	5
4000 K	6
CONTROL	
non DIM	1
DALI-2	3

LIGHT OPTIC	
spot round (UGR ≤ 10)	K
narrow medium round (UGR ≤ 10)	N
medium round (UGR ≤ 10)	B
medium square (UGR ≤ 10)	E
flood round (UGR ≤ 16)	C
flood square (UGR ≤ 19)	F
wide flood round	D
wide flood square	G

MATERIAL COLOUR	
○ traffic white RAL 9016	W
● white aluminium RAL 9006	G
● jet black RAL 9005	B
● gold dust RAL 260-M	9

LIGHT OPTIC COLOUR	
chrome reflector	0
black reflector*	B

*not available for spot round, narrow medium round and wallwasher

Options on request

COLOUR TEMPERATURE	
tunable white 2700–5000 K	
DALI-2 DT8	

LIGHT OPTIC COLOUR	
gold reflector	

Product configurator



Create your own UNICO PRO
unico.xal.com

Planning information

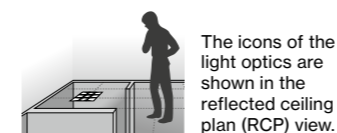

The icons of the light optics are shown in the reflected ceiling plan (RCP) view.

UNICO L2 basic ceiling

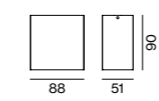
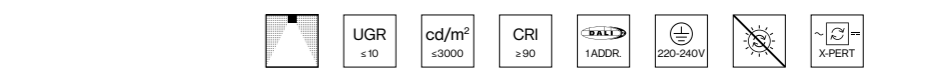

FLOOR		
SYSTEM POWER	LUMINOUS FLUX	ORDER CODE
12.6 W	up to 1150 lm	090-1L2:::A■01

choose one light optic ▲ from the options on the left depending on your room needs

CORRIDOR		
2x rectangular		
SYSTEM POWER	LUMINOUS FLUX	ORDER CODE
12.6 W	971 lm	090-1L2:::R■01

WALL		
2x wallwasher		
SYSTEM POWER	LUMINOUS FLUX	ORDER CODE
12.6 W	973 lm	090-1L2:::A■001

WALL + FLOOR		
2x wallwasher floor		
SYSTEM POWER	LUMINOUS FLUX	ORDER CODE
12.6 W	947 lm	090-1L2:::W■01

WALL + FLOOR		
2x wallwasher floor		
SYSTEM POWER	LUMINOUS FLUX	ORDER CODE
12.6 W	1020 lm	090-1L2:::W■02

UNICO L3 basic ceiling

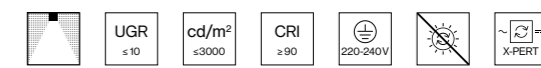

FLOOR		
SYSTEM POWER	LUMINOUS FLUX	ORDER CODE
18.9 W	up to 1720 lm	090-1L3:::A■01

choose one light optic ▲ from the options on the left depending on your room needs

WALL		
3x wallwasher		
SYSTEM POWER	LUMINOUS FLUX	ORDER CODE
18.9 W	1460 lm	090-1L3:::A■001

LUMINOUS FLUX value calculated for 3000K, CRI ≥ 90, colour white, reflector chrome 2700 K -6%, 4000 K +7%

← back

Order options

COLOUR TEMPERATURE

2700K	4
3000K	5
4000K	6

CONTROL

non DIM	1
DALI-2	3

LIGHT OPTIC

spot round (UGR ≤ 10)	K
narrow medium round (UGR ≤ 10)	N
medium round (UGR ≤ 10)	B
medium square (UGR ≤ 10)	E
flood round (UGR ≤ 16)	C
flood square (UGR ≤ 19)	F
wide flood round	D
wide flood square	G

MATERIAL COLOUR

○ traffic white RAL 9016	W
● white aluminium RAL 9006	G
● jet black RAL 9005	B
● gold dust RAL 260-M	9

LIGHT OPTIC COLOUR

chrome reflector	O
black reflector*	B

*not available for spot round, narrow medium round and wallwasher

Options on request

COLOUR TEMPERATURE

tunable white 2700-5000K	
DALI-2 DT8	

LIGHT OPTIC COLOUR

gold reflector	
----------------	--

Product configurator



Create your own UNICO PRO
unico.xal.com

Planning information

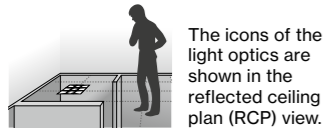

The icons of the light optics are shown in the reflected ceiling plan (RCP) view.

UNICO L4 basic ceiling

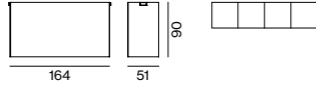

FLOOR	SYSTEM POWER	LUMINOUS FLUX	ORDER CODE
	20.4W	up to 1920lm	090-1L4::A01

choose one light optic ▲ from the options on the left depending on your room needs



WALL	SYSTEM POWER	LUMINOUS FLUX	ORDER CODE
4x wallwasher	20.4W	1620lm	090-1L4::A01



FLOOR/WALL + FLOOR	SYSTEM POWER	LUMINOUS FLUX	ORDER CODE
4x wallwasher floor	20.4W	1690lm	090-1L4::W01



WALL + FLOOR	SYSTEM POWER	LUMINOUS FLUX	ORDER CODE
4x wallwasher floor	20.4W	1690lm	090-1L4::W02

UNICO L6 basic ceiling

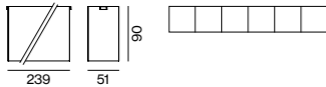
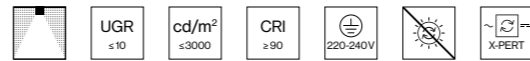

FLOOR	SYSTEM POWER	LUMINOUS FLUX	ORDER CODE
	28.6W	up to 2790lm	090-1L6::A01

choose one light optic ▲ from the options on the left depending on your room needs



CORRIDOR	SYSTEM POWER	LUMINOUS FLUX	ORDER CODE
6x rectangular	28.6W	2350lm	090-1L6::R01



WALL	SYSTEM POWER	LUMINOUS FLUX	ORDER CODE
6x wallwasher	28.6W	2360lm	090-1L6::A01



WALL + FLOOR	SYSTEM POWER	LUMINOUS FLUX	ORDER CODE
6x wallwasher floor	28.6W	2460lm	090-1L6::W01

LUMINOUS FLUX value calculated for 3000K, colour white, reflector chrome
 2700K -6%, 4000K +7%



Babylon
 Den Haag, NL – by Studio Linse

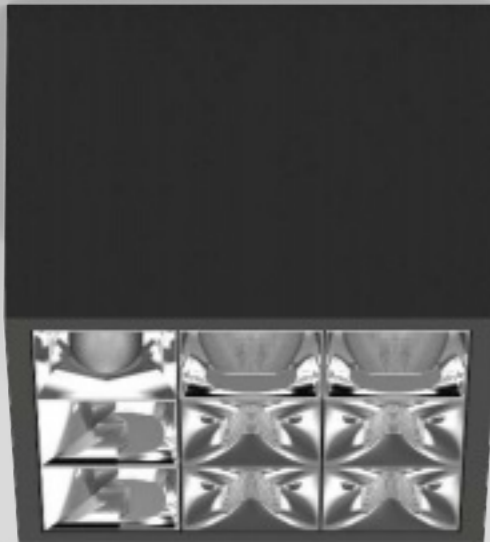

reddot winner 2020

UNICO square

ceiling

EN Square surface mounted multi-downlight made of aluminium; equipped with one (Q1) / four (Q4) / nine (Q9) individually selectable or pre-specified, customised light element(s); luminaire housing can be attached to mounting plate without tools by interlock; converter integrated into luminaire housing; surface powder coated; high-quality reflector with micro-faceted, aluminum-vaporised surface; precise radiation characteristic with different symmetrical light distributions; or with asymmetric light distribution; energy-efficient high power LEDs with very good colour rendering; clank-free

DE Quadratischer Anbau-Multi-Downlight aus Aluminium; bestückt mit einer (Q1) / vier (Q4) / neun (Q9) individuell wählbaren oder fix definierten, anwendungsspezifischen Optik(en); Leuchtenkörper mittels Verriegelung werkzeuglos auf Montageplatte aufsetzbar; Konverter im Leuchtenkörper integriert; Oberfläche pulverbeschichtet; hochwertiger Reflektor mit mikrofacettierter, aluminiumbedampfter Oberfläche; präzise Abstrahlcharakteristik mit unterschiedlichen symmetrischen Lichtverteilungen; oder mit asymmetrischer Lichtverteilung; energieeffiziente High-Power-LEDs mit sehr guter Farbwiedergabe; klirrfrei

Quickinfo

2700 K, 3000 K, 4000 K
CRI ≥ 90, 3 SDCM
UGR ≤ 19 / 65° ≤ 3000 cd/m²
Q1 up to 95 lm/W
Q4 up to 103 lm/W
Q9 up to 105 lm/W
L90 @ 50 000 h
non DIM, DALI-2

Types

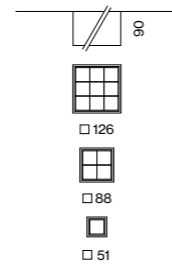

Colours



Light optics

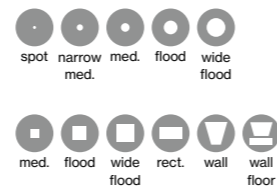

Order options

COLOUR TEMPERATURE	
2700 K	4
3000 K	5
4000 K	6

CONTROL	
non DIM	1
DALI-2	3

LIGHT OPTIC	
spot round (UGR ≤ 10)	K
narrow medium round (UGR ≤ 10)	N
medium round (UGR ≤ 10)	B
medium square (UGR ≤ 10)	E
flood round (UGR ≤ 16)	C
flood square (UGR ≤ 19)	F
wide flood round	D
wide flood square	G

MATERIAL COLOUR	
○ traffic white RAL 9016	W
● white aluminium RAL 9006	G
● jet black RAL 9005	B
● gold dust RAL 260-M	9

LIGHT OPTIC COLOUR	
chrome reflector	0
black reflector*	B

*not available for spot round, narrow medium round and wallwasher

Options on request

COLOUR TEMPERATURE	
tunable white 2700–5000 K	
DALI-2 DT8	

LIGHT OPTIC COLOUR	
gold reflector	

Product configurator



Create your own UNICO PRO
unico.xal.com

Planning information

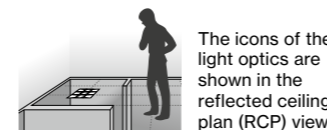

The icons of the light optics are shown in the reflected ceiling plan (RCP) view.

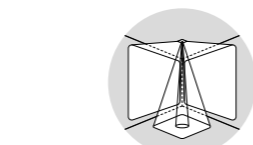

one luminaire
multiple scenes

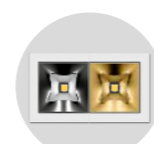

black & gold
reflector

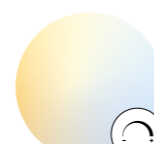

tunable white
2700–5000 K

UNICO Q1 basic ceiling

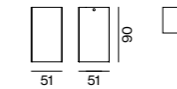

FLOOR	SYSTEM POWER	LUMINOUS FLUX	ORDER CODE
	6.5 W	up to 575 lm	090-1Q1::1▲■01

choose one light optic ▲ from the options on the left depending on your room needs

UNICO Q4 basic ceiling

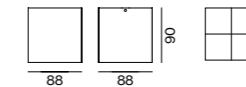
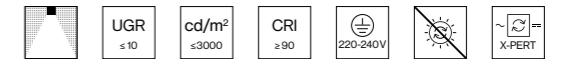

FLOOR	SYSTEM POWER	LUMINOUS FLUX	ORDER CODE
	20.4 W	up to 1920 lm	090-1Q4::4▲■01

choose one light optic ▲ from the options on the left depending on your room needs



WALL	SYSTEM POWER	LUMINOUS FLUX	ORDER CODE
4x wallwasher	20.4 W	1620 lm	090-1Q4::4▲■001



CORNER + FLOOR	SYSTEM POWER	LUMINOUS FLUX	ORDER CODE
2x wallwasher floor + 2x medium square	20.4 W	1630 lm	090-1Q4::4▲■01

UNICO Q9 basic ceiling

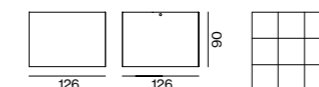
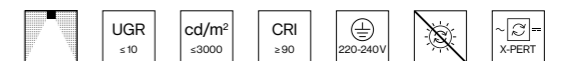

FLOOR	SYSTEM POWER	LUMINOUS FLUX	ORDER CODE
	36 W	up to 3550 lm	090-1Q9::9▲■01

choose one light optic ▲ from the options on the left depending on your room needs



WALL	SYSTEM POWER	LUMINOUS FLUX	ORDER CODE
9x wallwasher	36 W	3000 lm	090-1Q9::9▲■001



WALL + CORRIDOR	SYSTEM POWER	LUMINOUS FLUX	ORDER CODE
6x wallwasher floor + 3x rectangular	36 W	3090 lm	090-1Q9::9▲■01

LUMINOUS FLUX value calculated for
3000 K, CRI ≥ 90, colour white, reflector chrome
2700 K -6%, 4000 K +7%

Granitlab Coworking
St. Martin im Mühlkreis, AT –
by GHT-Plan GmbH with lighting design
by GHT-Plan GmbH, AREA C.I. Design GmbH



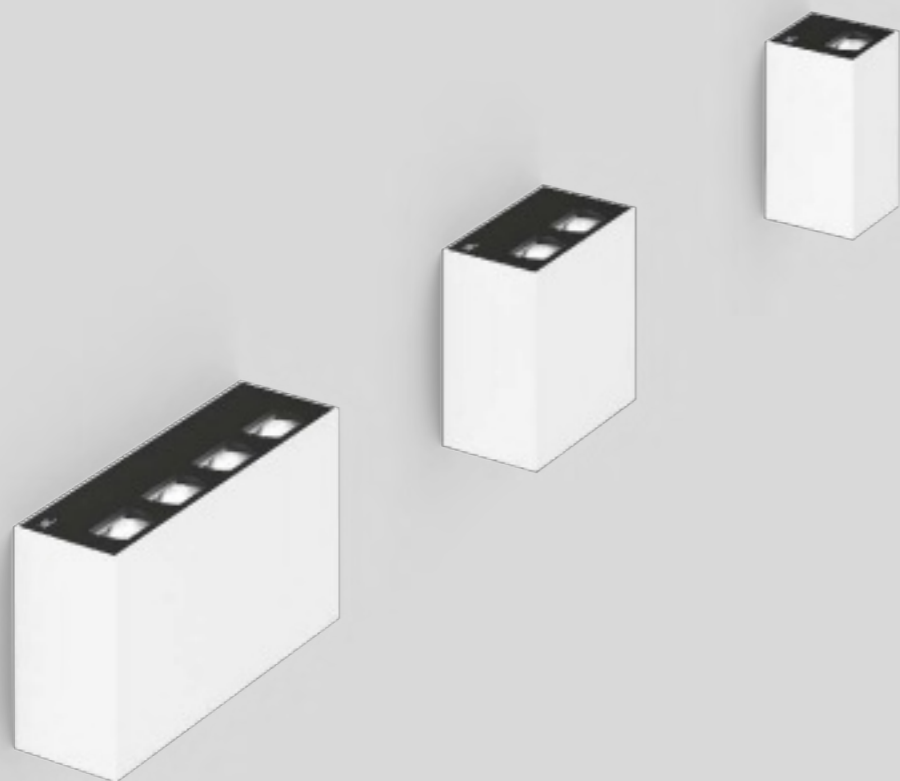

UNICO

wall surface

EN Rectangular wall surface mounted multi-uplight made of aluminium; equipped with one light inset (1 lamp) / two (2 lamps) / four (4 lamps) light insets; luminaire housing can be attached to mounting plate without tools by interlock; converter integrated into luminaire housing; surface powder coated; high-quality reflector with micro-faceted, aluminum-vaporised surface; homogeneous wall or ceiling illumination through uniform light distribution; energy-efficient high power LEDs with very good colour rendering; luminaire for through wiring

DE Rechteckiger Wandanbau-Multi-Uplight aus Aluminium; bestückt mit einem Lichteinsatz (1 lamp) / zwei (2 lamps) / vier (4 lamps) Lichteinsätzen; Leuchtenkörper mittels Verriegelung werkzeuglos auf Montageplatte aufsetzbar; Konverter im Leuchtenkörper integriert; Oberfläche pulverbeschichtet; hochwertiger Reflektor mit mikrofaccettierter, aluminiumbedampfter Oberfläche; homogene Wand- bzw. Deckenaufhellung durch gleichmäßige Lichtverteilung; energieeffiziente High-Power-LEDs mit sehr guter Farbwiedergabe; Leuchte für Weiterverdrahtung

Quickinfo

2700 K, 3000 K, 4000 K
CRI ≥ 90, 3 SDCM
up to 49 lm/W
L90 @ 50 000 h
non DIM, DALI-2

Types

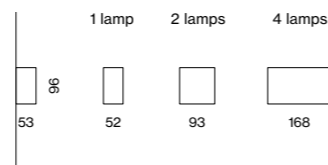

Colours



Light distribution



ceiling washer



homogeneous ceiling illumination

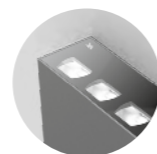

safety glass for dust protection

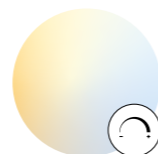

tunable white 2700–5000 K

Order options

COLOUR TEMPERATURE	
2700 K	4
3000 K	5
4000 K	6

CONTROL	
non DIM	1
DALI-2	3

MATERIAL COLOUR	
○ traffic white RAL 9016	W
● white aluminium RAL 9006	G
● jet black RAL 9005	B

Options on request

COLOUR TEMPERATURE	
tunable white 2700–5000 K	
only available for 2 lamps and 4 lamps DALI-2 DT8	

Light distribution

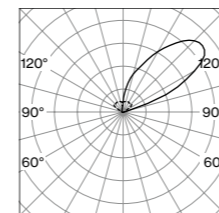

microprismatic direct/indirect power

LUMINOUS FLUX value calculated for 3000 K, CRI ≥ 90, colour white, reflector chrome 2700 K -6%, 4000 K +7%

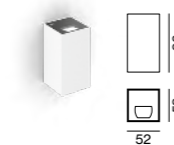

UNICO wall surface



1 LAMP

SYSTEM POWER	LUMINOUS FLUX	ORDER CODE
5.9 W	240 lm	090-0L1:::T001

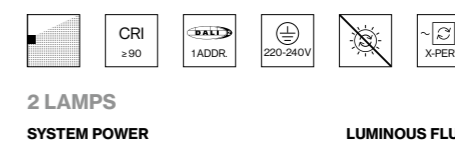
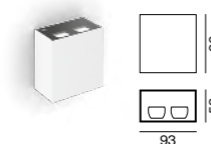

2 LAMPS

SYSTEM POWER	LUMINOUS FLUX	ORDER CODE
17.4 W	740 lm	090-0L2:::T001

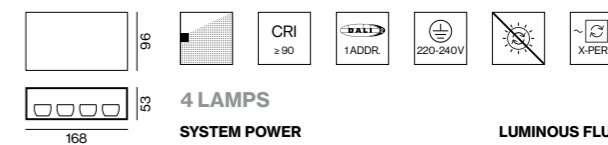

4 LAMPS

SYSTEM POWER	LUMINOUS FLUX	ORDER CODE
30.0 W	1380 lm	090-0L4:::T001

Office
Visualisation



UNICO

wall recessed

EN Recessed wall luminaire in aluminium; installation without tools in mounting set (trimless or with trim) with ball catch system; installation possible in different housings; surface powder coated; incl. external converter; high-quality reflector with micro-faceted, aluminum-vaporised surface; different asymmetrical light distributions; installation optionally for floor or ceiling illumination; energy-efficient high power LEDs with very good colour rendering

DE Wandeinbauleuchte aus Aluminium; werkzeuglose Montage im Montageset (randlos oder mit umlaufendem Rand) durch Kugelschnappsystem; Einbau in unterschiedlichen Gehäusen möglich; Oberfläche pulverbeschichtet; inkl. externem Konverter; hochwertiger Reflektor mit mikrofacettierter, aluminiumbedampfter Oberfläche; unterschiedliche asymmetrische Lichtverteilungen; Montage wahlweise zur Boden- oder Deckenaufhellung; energieeffiziente High-Power-LEDs mit sehr guter Farbwiedergabe

Quickinfo

2700 K, 3000 K, 4000 K
CRI ≥ 90, 3 SDCM
up to 53 lm/W
L90 @ 50 000 h
non DIM, DALI-2

Types

trim



trimless



Colours



Light distribution



wide floor



homogeneous floor illumination



safety glass for dust protection

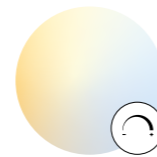

tunable white 2700–5000 K

Order options

COLOUR TEMPERATURE	
2700 K	4
3000 K	5
4000 K	6

CONTROL	
non DIM	1
DALI-2	3

LIGHT OPTIC	
wide floor	

MATERIAL COLOUR	
○ traffic white RAL 9016	W
● jet black RAL 9005	B

Options on request

COLOUR TEMPERATURE	
tunable white 2700–5000 K	

only available for 2 lamps | DALI-2 DT8

Light distribution

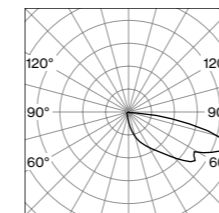

microprismatic direct/indirect power

LUMINOUS FLUX value calculated for 3000 K, CRI ≥ 90, colour white, reflector chrome 2700 K -6%, 4000 K +7%



UNICO wall recessed



1 LAMP

SYSTEM POWER	LUMINOUS FLUX	ORDER CODE
7.3 W	340 lm	090-6L1::UB001



2 LAMPS

SYSTEM POWER	LUMINOUS FLUX	ORDER CODE
12.5 W	610 lm	090-6L2::UB001

Accessories

MOUNTING SET WITH TRIM

for intermediate ceilings 2–25 mm

TYPE	L-W-H (mm)	CUTOUT (mm)	ORDER CODE
1 lamp	101-63-20	90-50	090-7L2020
2 lamps	101-101-30	90-50	090-7Q4020

TRIMLESS MOUNTING SET

for installation in plasterboard ceilings 12.5/15/20/25 mm

TYPE	L-W-H (mm)	CUTOUT (mm)	ORDER CODE
1 lamp	88-50-47	90-50	090-7L20100
2 lamps	85-85-47	90-50	090-7Q40100

PRIMED CONCRETE MOUNTING SET

TYPE	L-W-H (mm)	ORDER CODE
primed concrete ceilings	240-400-130	052-1914320

order mounting set separately

EXPOSED CONCRETE MOUNTING SET

TYPE	ORDER CODE
1 lamp exposed concrete	090-6L10500
2 lamps exposed concrete	090-6L20600

order mounting set separately

Planning information

wide floor

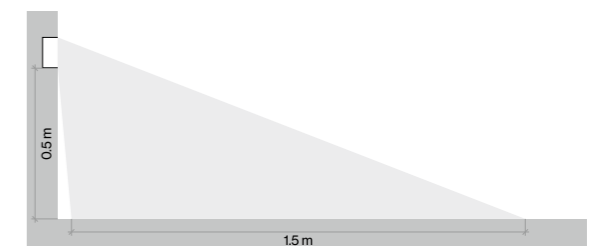

Office
Visualisation



Hidden talent

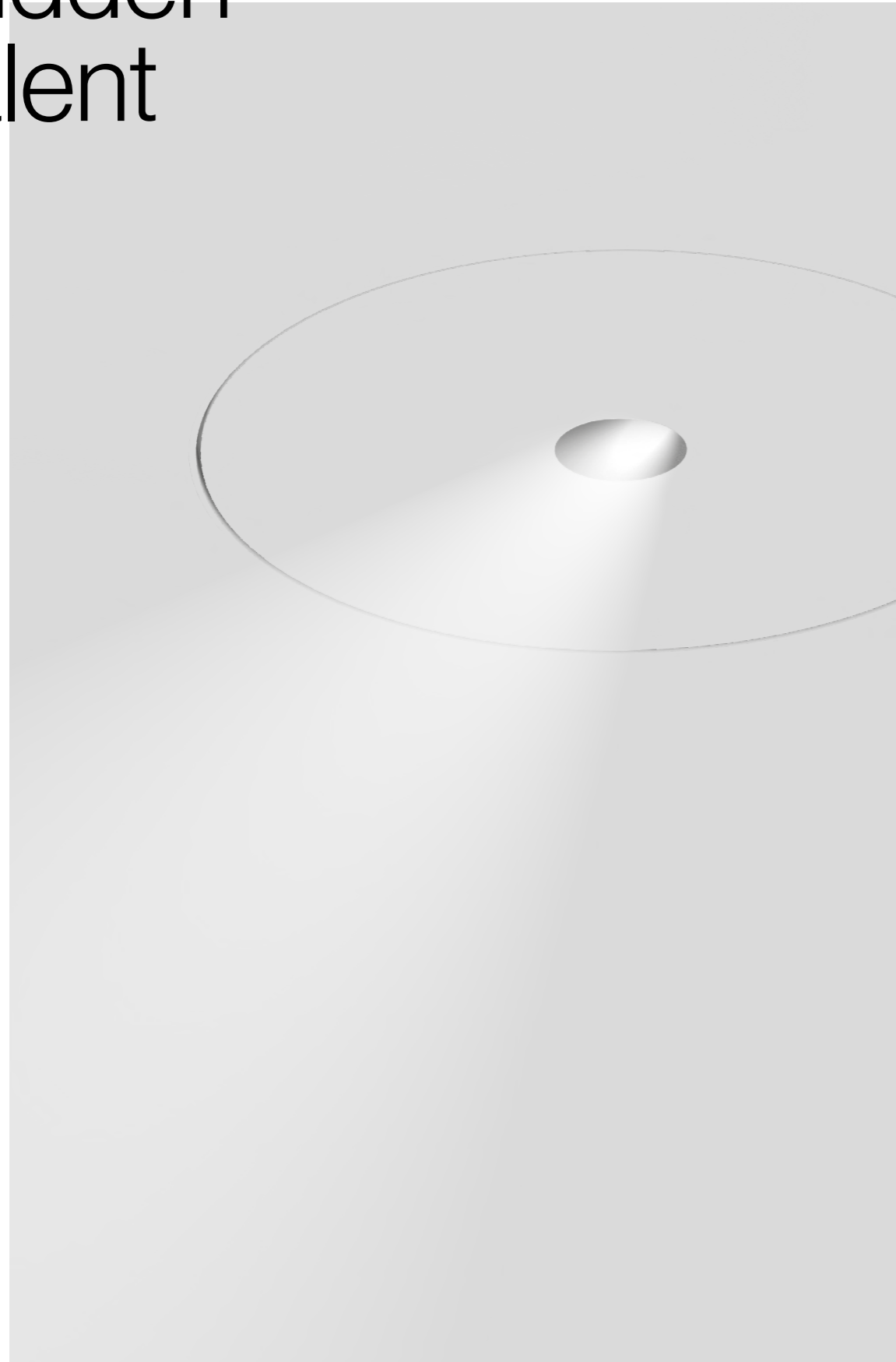

SPIO

EN Round, recessed SPIO spotlights bring special lighting to your rooms. The luminaire provides an impressive lighting effect, trimless or with a trim. The housing can be painted over, allowing the spotlight to blend seamlessly into the ceiling. The small light aperture of 10 mm makes the SPIO itself appear almost hidden – but the equally effective and calm overall impression is anything but invisible. The round, recessed spotlight is available with beam angles of 35° or 44° and can be rotated 360° in the housing and pivoted 30° in all directions. These different lighting options mean that versatile designs for interiors are possible. SPIO is available in the light colours 2700 K, 3000 K, and 4000 K.

DE Mit den runden SPIO Einbaustrahlern bringen Sie eine besondere Beleuchtung in Ihre Räume. Die Leuchte sorgt für eine beeindruckende Lichtwirkung, randlos oder mit umlaufendem Rand. Das Gehäuse kann einfach überstrichen werden, wodurch sich der Strahler nahtlos ins Deckenbild einfügt. Die geringe Lichtaustrittsöffnung von 10 mm lässt die SPIO selbst beinahe verborgen erscheinen – der gleichermaßen effektvolle und ruhige Gesamteindruck ist aber alles andere als unsichtbar. Der runde Einbau-Spot ist mit den Ausstrahlwinkel von 35° oder 44° verfügbar und ist im Gehäuse um 360° drehbar und in alle Richtungen 30° schwenkbar. Dadurch ergibt sich eine vielseitige Raumgestaltung auf Basis der unterschiedlichen Beleuchtungsmöglichkeiten. SPIO ist in den Lichtfarben 2700 K, 3000 K und 4000 K erhältlich.

Type



60

Mountings

trimless
recessedwith trim
recessed

Light distributions

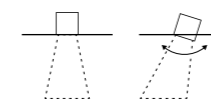

downlight

spotlight

High-efficiency lens

EN Large light output – almost unnoticed. SPIO has a special LFO lens, which is mounted at an exact distance from the light-emission surface, thus ensuring that no light beam appears on the inner surface of the housing. This reduces the light-emission surface, and SPIO illuminates the room almost unnoticed.

DE Großer Lichtoutput – nahezu unbemerkt. SPIO verfügt über eine spezielle LFO Linse, welche in einem exakten Abstand zur Lichtaustrittsfläche montiert wird. Dieser ist so bemessen, dass kein Lichtstrahl an der Innenfläche des Gehäuses auftritt. Dadurch wird die Lichtaustrittsfläche reduziert und SPIO beleuchtet den Raum nahezu unbemerkt.

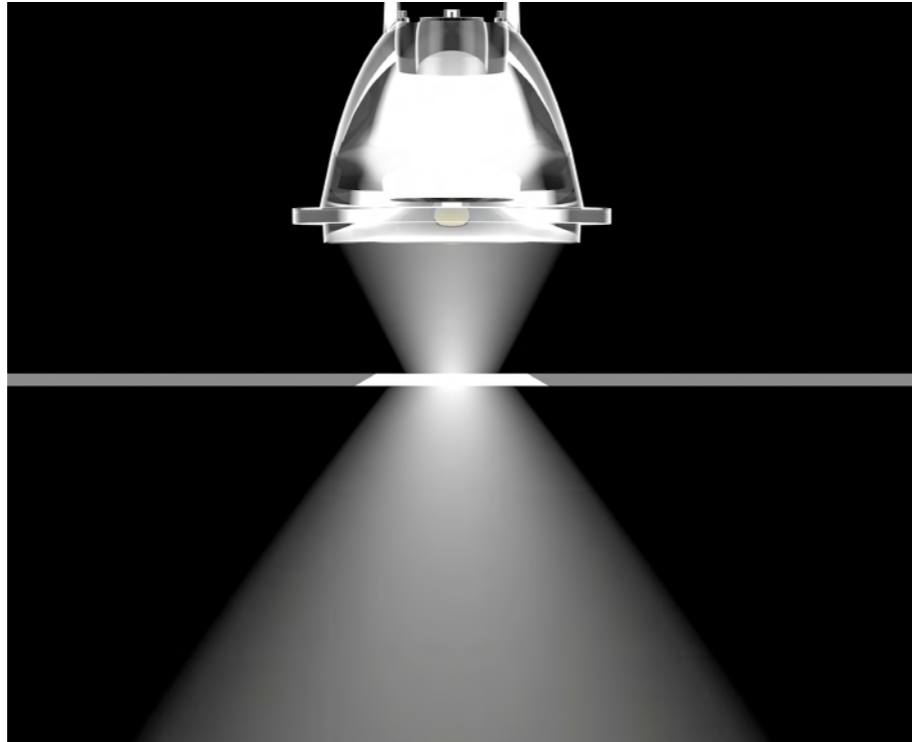

Homogeneous appearance

EN SPIO is the right choice for a uniform ceiling appearance. Thanks to its extremely small light aperture of 10 mm, the recessed spotlight appears almost invisible. The effective lighting is rounded off by its minimalist design language.

DE Für ein einheitliches Deckenbild ist SPIO die richtige Wahl. Dank seiner ausgesprochen geringen Lichtaustrittsöffnung von 10 mm ist der Einbaustrahler beinahe unsichtbar. Die effektive Lichtwirkung wird abgerundet durch seine minimalistische Formensprache.

Light distribution

EN Despite its small emission surface, the recessed spotlight achieves a beam angle of either 35° or 44°. SPIO thus provides glare-free light and skilfully stages objects.

DE Trotz seiner geringen Austrittsfläche erreicht der Einbaustrahler einen Ausstrahlwinkel von wahlweise 35° oder 44°. Dadurch gibt SPIO blendfreies Licht und setzt Objekte gekonnt in Szene.

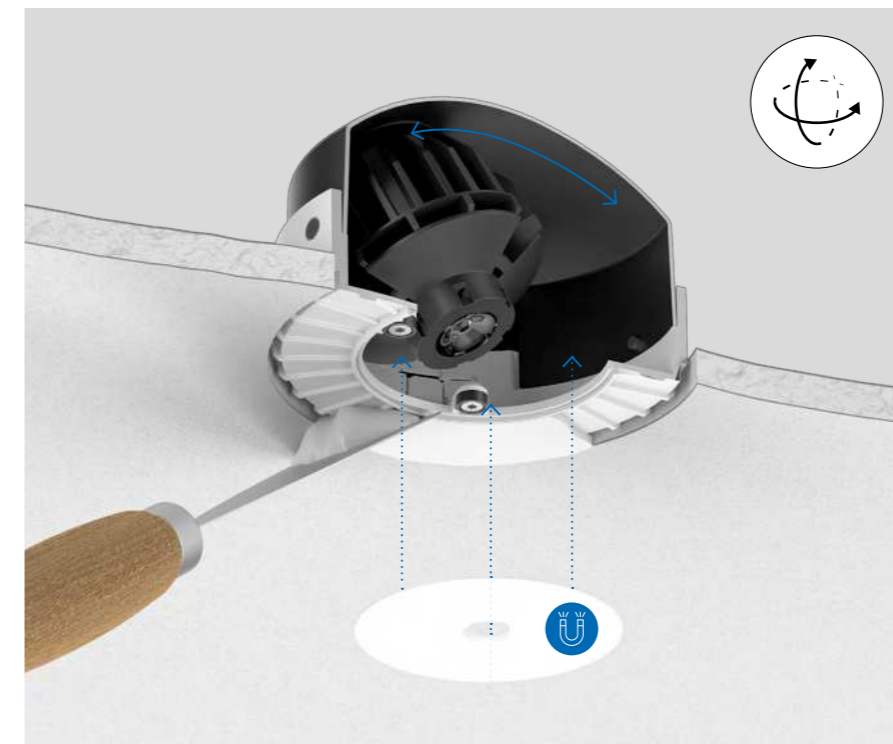
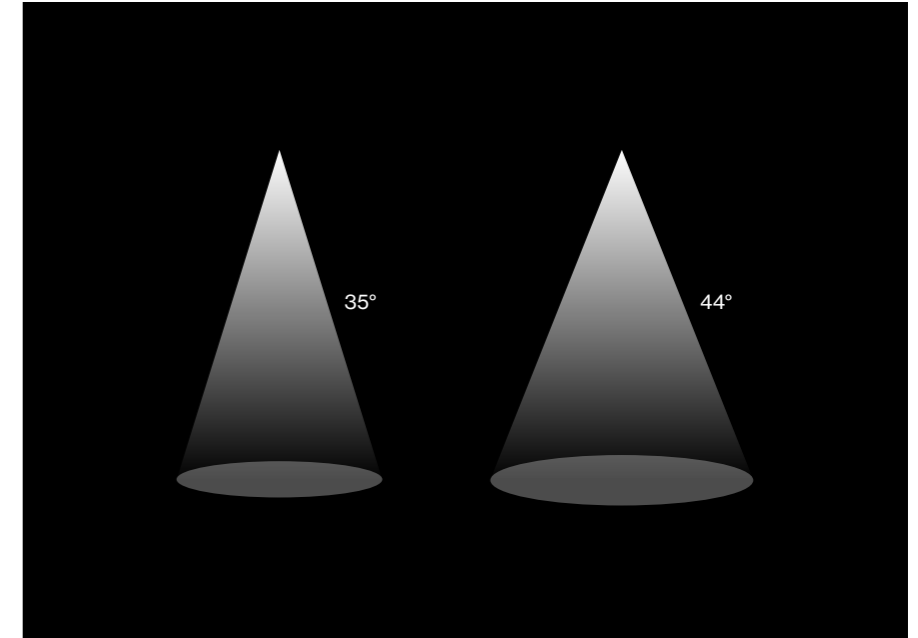

Precise light adjustment

EN The adjustable version of SPIO, patent pending, can be moved in all directions thanks to a magnetic plate. The spotlight can thus both be rotated 360° and pivoted up to 30° in all directions. As a result, it offers the greatest flexibility in directing and guiding light exactly where it is desired.

DE Die zum Patent angemeldete adjustable Version von SPIO kann aufgrund eines magnetischen Strahlerkopfes in alle Richtungen bewegt werden. Der Strahler kann zudem nicht nur um 360° gedreht, sondern auch um bis zu 30° in alle Richtungen geschwenkt werden. Dadurch bietet er größte Flexibilität in der Ausrichtung und Lenkung des Lichtes genau dorthin, wo es gewünscht ist.

Smooth and invisible

EN The trimless SPIO version can easily be maintained and adjusted thanks to its magnetic cover. The spotlight is completely fitted into a plasterboard ceiling. The recessed housing and ceiling can subsequently be painted over. The spots thus appear "invisible", creating a homogeneous, effective overall impression.

DE Die randlose Variante von SPIO ist durch die magnetische Abdeckplatte einfach zu warten und zu adjustieren. Der Strahler wird vollkommen in einer Gipskartondecke verbaut. Anschließend kann das Einbaugehäuse gemeinsam mit der Zimmerdecke überstrichen werden. Die Spots wirken dadurch „unsichtbar“ – es entsteht ein homogener wirkungsvoller Gesamteindruck.

← back

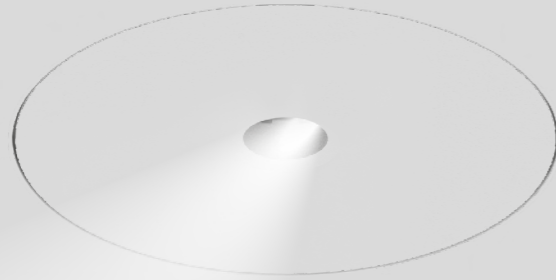

reddot winner 2022



SPIO 60

recessed

EN Round recessed spotlight in die-cast aluminium; installation without tools in mounting set with ball catch system or with magnetic attachment; for trimless installation in plasterboard ceilings; paintable cover; shadow joint between cover and mounting set optionally fillable; choice of adjustable or fixed symmetric radiation characteristic; high quality lens system; uncluttered ceiling look through recessed lighting level; reduced light-emitting surface (only ø10 mm); no multiple shadows; efficient LEDs with very good colour rendering

DE Runder Einbaustrahler aus Aluminiumdruckguss; werkzeuglose Montage im Montageset durch Kugelschnappsystem oder mittels Magnetbefestigung; für randlosen Einbau in Gipskartondecken; überstreichbare Abdeckplatte; Schattenfuge zwischen Abdeckplatte und Montageset optional verspachtelbar; wahlweise einstellbar oder starr symmetrische Abstrahlcharakteristik; hochwertige Linsenoptik; ruhiges Deckenbild durch zurückversetzte Leuchtebene; reduzierte Lichtaustrittsfläche (nur ø10 mm); keine Mehrfachschatten; effiziente LEDs mit sehr guter Farbwiedergabe

Quickinfo

2700 K, 3000 K
CRI ≥ 90, 2 SDCM
up to 60 lm/W
L80 @ 50 000 h
non DIM, DALI-2

Types

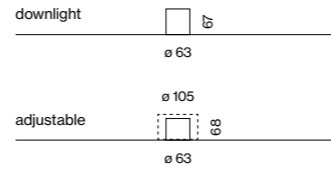

Colour



Light distributions



Order options

COLOUR TEMPERATURE	
2700 K	4
3000 K	5

MATERIAL COLOUR

○ traffic white RAL9016
paintable cover

BEAM ANGLE

flood 35°	F
wide flood 44°	W

Options on request

COLOUR TEMPERATURE
4000 K

CONCRETE HOUSING

primed concrete ceiling
exposed concrete ceiling

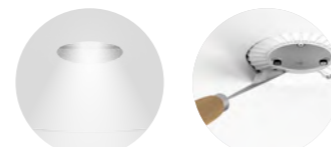

10 mm light output area

trimless installation

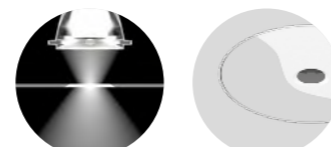

LFO lens technology

paintable cover

INSET POWER is the current consumption excluding any ballast
LUMINOUS FLUX value calculated for 3000 K, CRI ≥ 90, colour white, lens flood 2700 K -5%

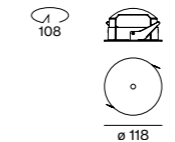
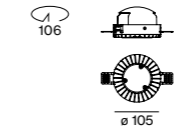
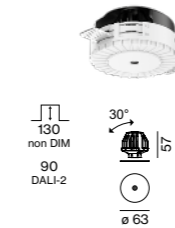
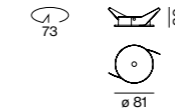
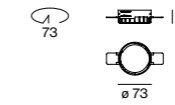
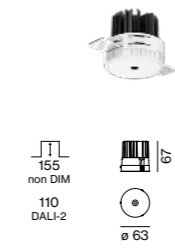

SPIO 60 downlight



DOWNLIGHT	INSET POWER	LUMINOUS FLUX	ORDER CODE
	12.2 W 12 Vf 1050 mA	693 lm	0 4 8 - 1 5 1 0 :: 1 7 ▲

Mounting accessories

TRIMLESS MOUNTING SET for plasterboard ceilings 12.5/15/25 mm	ORDER CODE
COLOUR ○ traffic white RAL9016	0 4 8 - 2 6 9 6 1 1 7

MOUNTING SET WITH TRIM for intermediate ceilings 2–25 mm

COLOUR	ORDER CODE
○ traffic white RAL9016	0 4 8 - 1 5 9 7 2 0 7
● white aluminium RAL 9006	0 4 8 - 1 5 9 7 2 0 G
● jet black RAL 9005	0 4 8 - 1 5 9 7 2 0 8

SPIO 60 adjustable



ADJUSTABLE	INSET POWER	LUMINOUS FLUX	ORDER CODE
	9.7 W 12 Vf 850 mA	582 lm	0 4 8 - 1 5 2 0 :: 1 7 ▲

Mounting accessories

TRIMLESS MOUNTING SET for plasterboard ceilings 12.5/15/25 mm	ORDER CODE
COLOUR ○ traffic white RAL9016	0 4 8 - 1 5 9 8 1 0 7

MOUNTING SET WITH TRIM for intermediate ceilings 2–25 mm

COLOUR	ORDER CODE
○ traffic white RAL9016	0 4 8 - 1 5 9 7 1 0 7
● white aluminium RAL 9006	0 4 8 - 1 5 9 7 1 0 G
● jet black RAL 9005	0 4 8 - 1 5 9 7 1 0 8

Electrical accessories

POWER SUPPLY 220-240 V AC, 50-60 Hz, PC II

TYPE	EFFICIENCY	L-W-H (mm)	ORDER CODE
850 mA non DIM	η 85 %	147-44-22	0 0 2 - 9 0 7 8 5
850 mA DALI-2	η 85 %	147-44-22	0 0 2 - 9 0 7 8 6
1050 mA non DIM	η 85 %	147-44-22	0 0 2 - 9 0 7 8 7
1050 mA DALI-2	η 85 %	147-44-22	0 0 2 - 9 0 7 8 8

DIN RAIL COMPONENTS

TYPE	W-H-D (mm)	ORDER CODE
POWER SUPPLY 220-240 V AC 96 W 48 V DC constant voltage	90-90-60	0 0 5 - 6 5 2 0 2 1 0
LED DRIVER DALI-2 DT6 1-2 addr. 200–1050 mA settable const. current 2 × 42 W 48 V DC U _{OUT} 10–40 V	36-88-59	0 0 5 - 6 1 2 1 0 3 0

for more details and components see page 981

Private Residence
Visualisation



Private Residence
Visualisation



Spotlights behind the scene



CAVO

EN CAVO embodies a new type of lighting system. The round, square, rectangular, or flexible installation system can be integrated flush in suspended ceilings. The spotlights can be positioned and connected almost anywhere using a patented magnet system while remaining discreetly in the background. The spots can be rotated and swivelled individually. The glowing variant offers decorative indirect lighting of the recessed housing, which backlights the spots and effectively de-locates the light points.

DE CAVO verkörpert eine neue Art von Lichtsystem. Das runde, quadratische oder rechteckige flexibel gestaltbare Einbaugehäuse wird flächenbündig in abgehängte Decken integriert. Dort können die Strahler anhand eines patentierten Magnetsystems nahezu beliebig positioniert sowie angeschlossen werden und halten sich dezent im Hintergrund. Die Spots sind individuell dreh- und schwenkbar. Zusätzlich bietet die Glowing Variante eine dekorative Indirektbeleuchtung des Einbaugehäuses, die die Spots hinterleuchtet und die Lichtpunkte effektiv entortet.

Types

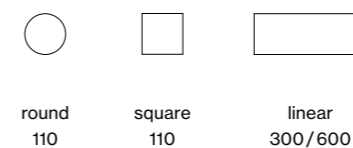

Mountings

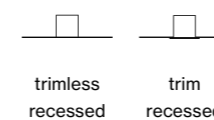

Light distributions

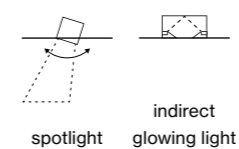

Works invisibly

EN CAVO spotlights are mounted without tools and magnetically fixed, discreetly concealing the light source in the housing. The recessed light point plane also provides ample glare control.

DE CAVO Strahler werden werkzeuglos montiert und magnetisch fixiert, wodurch sich die Lichtquelle dezent im Gehäuse versteckt. Die zurückversetzte Lichtpunktebene schafft zusätzlich eine gute Entblendung.

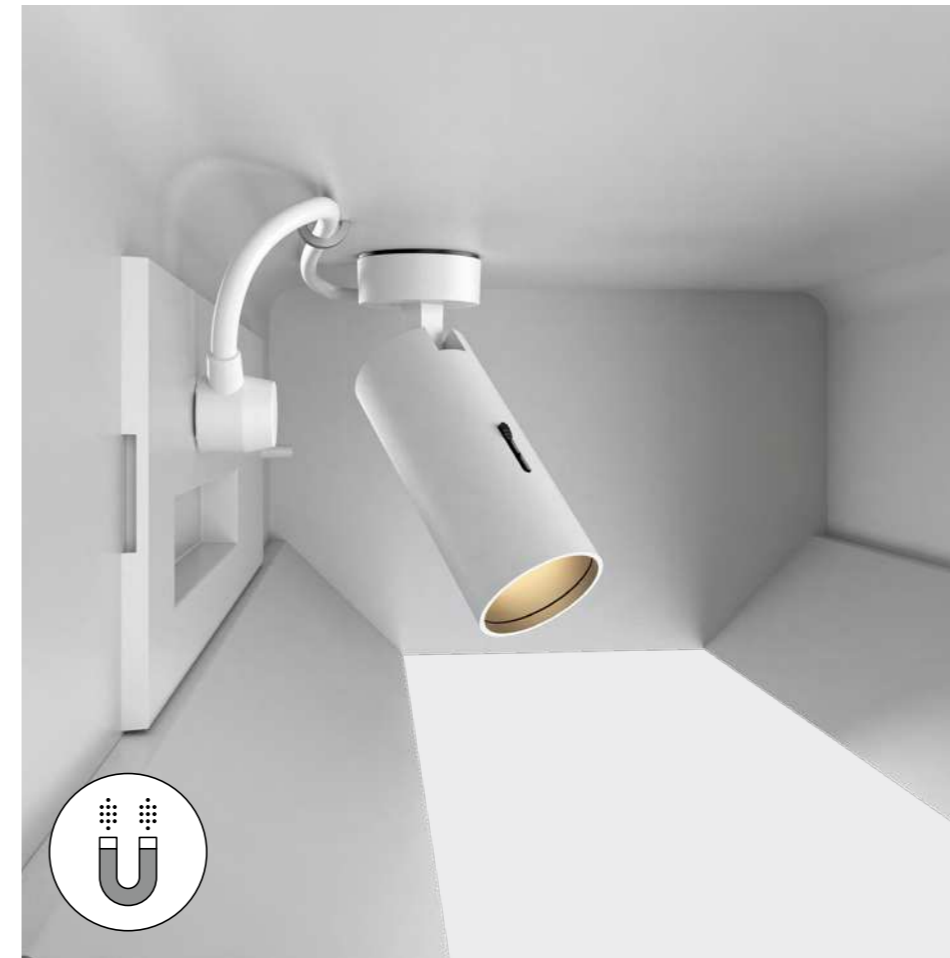

Magnetic attachment

EN CAVO spotlights are easy to rotate and swivel and can be repositioned and rearranged according to requirements, providing maximum mobility and light exactly where it is needed. The magnet system repositions each spotlight within the housing with just one touch.

DE Höchste Beweglichkeit und Licht genau dort, wo es benötigt wird: CAVO Strahler sind einfach dreh- und schwenkbar und können je nach Anforderung neu positioniert und angeordnet werden. Dank eines Magnetsystems wird jeder Strahler innerhalb des Gehäuses mit nur einem Handgriff neu positioniert.



Glowing effect

EN CAVO Glowing is a variant with powerful indirect lighting. Light insets, which are placed inside the box and the housing channel, illuminate from within. This creates subtle, decorative indirect light in the channel, complementing the directional light.

DE Bei CAVO Glowing handelt es sich um eine Variante mit effektvoller Indirektbeleuchtung. Eigene Lichteinsätze in der Box bzw. im Gehäusekanal leuchten diese von innen aus. Dadurch entsteht dezentes, dekoratives Indirektlicht im Kanal, welches das gerichtete Licht ergänzt.

Variety

EN The individual housing is directly attached to the bare ceiling. As a single luminaire, CAVO has four different recessed housings (round, square, or rectangular in two lengths), which can be arranged with up to six spotlights.

DE Das Einzelgehäuse wird direkt an der Rohdecke befestigt. Als Einzelleuchte verfügt CAVO über vier unterschiedliche Einbauegehäuse (rund, quadratisch oder rechteckig in zwei Längen), die mit bis zu sechs Strahlern arrangiert werden können.

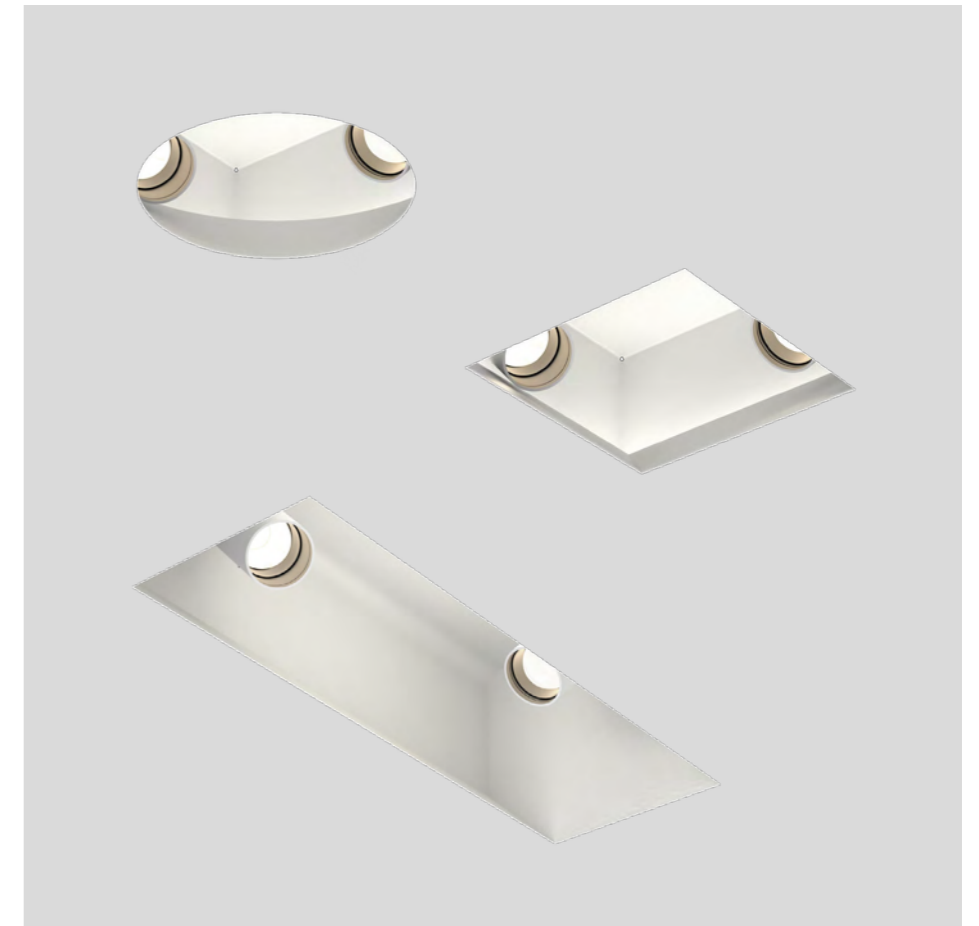

← back

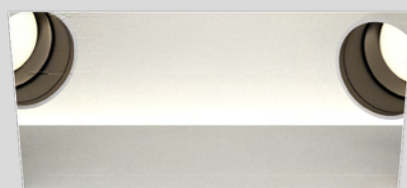

CAVO round/square

recessed

EN Recessed housing made of pressed steel sheet for flush installation in plasterboard ceilings, underside of aluminium-reinforced plaster; alternatively with round or square cut-out; no break-out of edges; 3 cylindrical spotlight heads can be installed without tools by means of magnetic holders; simple electrical connection of the spotlights due to non-reversible plug and play connection; housing and spotlights powder coated; optionally: indirect light component in housing; COB (Chip on Board) technology for maximum efficiency; no multiple shadows; efficient LEDs with very good colour rendering; good glare reduction due to recessed light point plane; high quality lens system; precise radiation characteristic; optical attachments as accessories; hot plug protection

DE Einbaugehäuse aus Stahlblech für randlosen Einbau in Gipskartondecken, Unterseite aus aluminiumverstärktem Gips; wahlweise mit rundem oder quadratischem Ausschnitt; kein Ausbrechen der Kanten; 3 zylindrische Strahlköpfe mittels Magnethalter werkzeuglos einsetzbar; einfacher elektrischer Anschluss der Strahler durch verpolungssichere Plug & Play Verbindung; Gehäuse und Strahler pulverbeschichtet; optional: Indirektlichtanteil im Gehäuse; COB (Chip on Board) Technologie für höchste Effizienz; keine Mehrfachschatten; effiziente LEDs mit sehr guter Farbwiedergabe; gute Entblendung durch zurückversetzte Lichtpunktebene; hochwertige Linsenoptik; präzise Abstrahlcharakteristik; optische Aufsätze als Zubehör; Hot Plug-Schutz

Quickinfo

2700 K, 3000 K
CRI ≥ 90, 2 SDCM
DALI-2

L80 @ 50 000 h
mounting housing with glowing

L90 @ 50 000 h
JUST 45 up to 69lm/W

L95 @ 50 000 h
JUST 32 focus up to 3x54 lm/W

Types

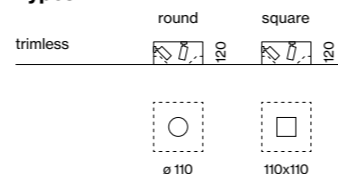

Housing colours



Inset colours



Light distributions



Order options

COLOUR TEMPERATURE	
2700 K	4
3000 K	5

CONTROL

DALI-2

INSET COLOUR

<input type="radio"/> traffic white RAL 9016	7
<input checked="" type="radio"/> jet black RAL 9005	8
<input type="radio"/> gold dust RAL 260-M	9

HOUSING COLOUR

<input type="radio"/> traffic white RAL 9016	7
<input checked="" type="radio"/> jet black RAL 9005	8

BEAM ANGLE

medium 23°	M
flood 44°	F

Options on request

OPTICAL ACCESSORIES

elliptical sculpture foil
snoot
colour filter (red, blue, green, etc.)
only for JUST 32 focus



magnetic holders for tool-free mounting



optical accessories

INSET POWER is the current consumption excluding any ballast
LUMINOUS FLUX value calculated for 3000 K, CRI ≥ 90, colour white, lens medium 2700 K -5%

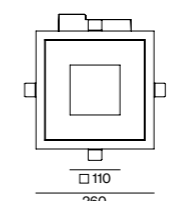
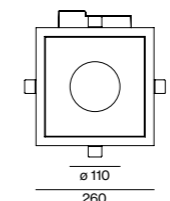
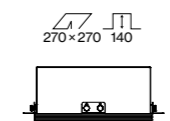

JUST 32 focus 17-43°

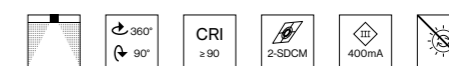

SPOTLIGHT

INSET POWER	LUMINOUS FLUX	ORDER CODE
4.6 W	250 lm	0 4 9 - 8 2 1 1 :: 3 ▽

not for single use

JUST 45

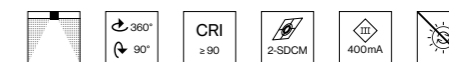

SPOTLIGHT

INSET POWER	LUMINOUS FLUX	ORDER CODE
8.8 W	640 lm	0 4 9 - 8 3 0 2 :: 3 ▽

Mounting accessories

MOUNTING HOUSING 1 DALI-2 address

for trimless installation in plasterboard ceilings 8-25 mm

TYPE	L-W-H (mm)	ORDER CODE
round 3 spots (4.5 kg)	260-260-120	0 4 9 - 8 8 0 3 0 3 ▽
square 3 spots (4.5 kg)	260-260-120	0 4 9 - 8 8 1 3 0 3 ▽

incl. power supply 220-240 V AC, 50-60 Hz, PC I, ENEC approved

MOUNTING HOUSING WITH GLOWING (3000 K) 2 DALI-2 addresses

for trimless installation in plasterboard ceilings 8-25 mm

TYPE	L-W-H (mm)	ORDER CODE
round 3 spots (4.5 kg)	260-260-120	0 4 9 - 8 8 2 3 5 3 7
square 3 spots (4.5 kg)	260-260-120	0 4 9 - 8 8 3 3 5 3 7

incl. power supply 220-240 V AC, 50-60 Hz, PC I, ENEC approved

Optical accessories

HONEYCOMB LOUVER

TYPE	Ø-H (mm)	ORDER CODE
JUST 32 focus	30-4	0 0 7 - 1 9 6 5 1 6 8
JUST 45	42-3	0 0 7 - 1 9 6 5 1 8 8

Freigeist Brauquartier
Graz, AT – by FIPE ARCHITECTURE
with lighting design by Eugen Schöberl



← back



CAVO linear

recessed

EN Installation housing in pressed steel sheet with rectangular cut-out; for trimless installation in plasterboard ceilings; special edge design with perforations for better adhesion of filler; or with trim; 3 or 6 cylindrical spotlight heads can be installed without tools by means of magnetic holders; simple electrical connection of the spotlights due to non-reversible plug and play connection; housing and spotlights powder coated; COB (Chip on Board) technology for maximum efficiency; no multiple shadows; efficient LEDs with very good colour rendering; good glare reduction due to recessed light point plane; high quality lens system; precise radiation characteristic; optical attachments as accessories; hot plug protection

DE Einbaugehäuse aus Stahlblech mit rechteckigem Ausschnitt; für randlosen Einbau in Gipskartondecken; spezielle Randausbildung mit Löchern für bessere Haftung der Spachtelmasse; oder mit umlaufendem Rand; 3 bzw. 6 zylindrische Strahlerköpfe mittels Magnethalter werkzeuglos einsetzbar; einfacher elektrischer Anschluss der Strahler durch verpolungssichere Plug & Play Verbindung; Gehäuse und Strahler pulverbeschichtet; COB (Chip on Board) Technologie für höchste Effizienz; keine Mehrfachschatten; effiziente LEDs mit sehr guter Farbwiedergabe; gute Entblendung durch zurückversetzte Lichtpunktenebene; hochwertige Linsenoptik; präzise Abstrahlcharakteristik; optische Aufsätze als Zubehör; Hot Plug-Schutz

Quickinfo

2700 K, 3000 K
CRI ≥ 90, 2 SDCM
DALI-2

L90 @ 50 000 h
JUST 45 up to 6×69 lm/W

L95 @ 50 000 h
JUST 32 focus up to 6×54 lm/W

Types

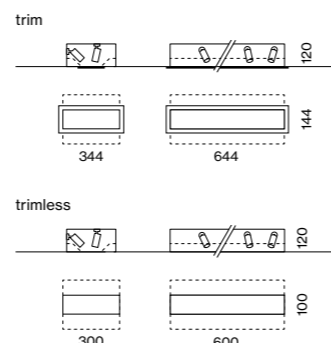

Housing colours



Inset colours



Light distributions



Order options

COLOUR TEMPERATURE	
2700 K	4
3000 K	5

CONTROL

DALI-2

INSET COLOUR

○ traffic white RAL 9016	7
● jet black RAL 9005	8
● gold dust RAL 260-M	9

HOUSING COLOUR

○ traffic white RAL 9016	7
● jet black RAL 9005	8

BEAM ANGLE

medium 23°	M
flood 44°	F

Options on request

OPTICAL ACCESSORIES

elliptical sculpture foil
snoot
colour filter (red, blue, green, etc.)
only for JUST 32 focus

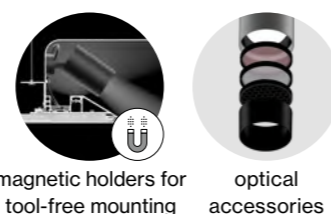
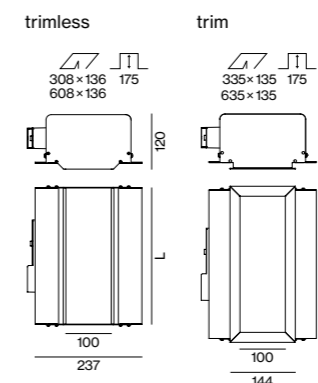

INSET POWER is the current consumption excluding any ballast
LUMINOUS FLUX value calculated for 3000 K, CRI ≥ 90, colour white, lens medium 2700 K -5%



JUST 32 focus 17-43°

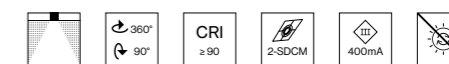

SPOTLIGHT

INSET POWER	LUMINOUS FLUX	ORDER CODE
4.6 W	250 lm	049-821133

not for single use

JUST 45

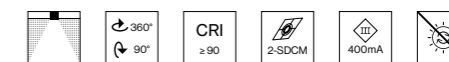

SPOTLIGHT

INSET POWER	LUMINOUS FLUX	ORDER CODE
8.8 W	640 lm	049-830233

Mounting accessories

TRIMLESS MOUNTING HOUSING

for trimless installation in plasterboard ceilings 12.5 mm

TYPE	L-W-H (mm)	ORDER CODE
for 3 spots (▲ 2.4 kg), 1 DALI	308-252-120	049-884303
for 6 spots (▲ 3.6 kg), 2 DALI	608-269-120	049-884603

incl. power supply 220-240 V AC, 50-60 Hz, Ⓢ PC I, ENEC approved

MOUNTING HOUSING WITH TRIM

for intermediate ceilings 12.5 mm

TYPE	L-W-H (mm)	ORDER CODE
for 3 spots (▲ 2.7 kg), 1 DALI	344-254-120	049-885303
for 6 spots (▲ 4.7 kg), 2 DALI	644-271-120	049-885603

incl. power supply 220-240 V AC, 50-60 Hz, Ⓢ PC I, ENEC approved

Optical accessories

HONEYCOMB LOUVER

TYPE	Ø-H (mm)	ORDER CODE
JUST 32 focus	30-4	007-1965168
JUST 45	42-3	007-1965188

Boutique Frame Moscow, RU –
by Architectural Group Method with
lighting design by KA2 Light Architecture



Combine with your design



SASSO

EN SASSO is a glamorous lighting solution for extravagant interior concepts regardless of how it is used. The versatile spotlight series is available as a recessed, semi-recessed, ceiling- or wall-mounted, or suspended version. Choose between round or square versions, as well as single or double-lamp spotlights in some versions. To ensure the spot fits harmoniously into the overall design, it is available in many colours. The housing colours white, black, and silver can be optimally combined with a selection of differently coloured insets. SASSO is available with different light distribution characteristics – either as spotlight, downlight, wallwasher, or wallwasher floor. In addition, sensors or emergency insets are optionally available. The series is characterised by an excellent colour rendering up to $\text{CRI} \geq 95$ (2-SDCM) in all light colours: 2700K, 3000K, 4000K, or Colour Warm Dimming.

DE Wie sie auch zum Einsatz kommt, SASSO ist eine glamouröse Lichtlösung für extravagante Interior-Konzepte. Die vielfältige Strahlerserie ist in zahlreichen Varianten verfügbar: als Einbau-, Halbeinbau, Decken- oder Wandbauvariante sowie in abgependelter Ausführung. Außerdem haben Sie die Wahl zwischen runden oder quadratischen Varianten, sowie in manchen Ausführungen auch als ein- oder zweiflämmige Strahler. Um den Strahler harmonisch in die Gesamtgestaltung einzufügen, ist er in vielen Farben erhältlich – wobei die Housing Farben Weiß, Schwarz und Silber optimal mit einer Auswahl an verschiedenfarbigen Insets kombinierbar sind. SASSO ist in verschiedene Abstrahlcharakteristiken verfügbar – wahlweise als Spotlight, Downlight, Wallwasher oder Wallwasher Floor. Zusätzlich sind wahlweise Sensoren oder Emergency Insets erhältlich. In allen Lichtfarben – 2700K, 3000K, 4000K oder Colour Warm Dimming – zeichnet sich die Serie zudem durch eine sehr gute Farbwiedergabe von bis zu $\text{CRI} \geq 95$ (2-SDCM) aus.

Types

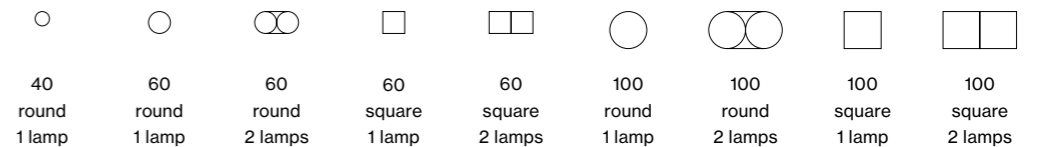

Mountings

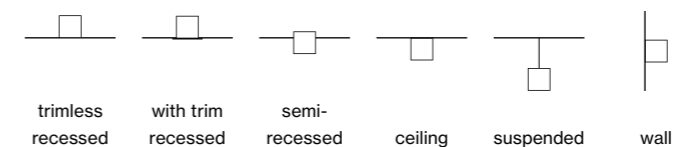

Light distributions

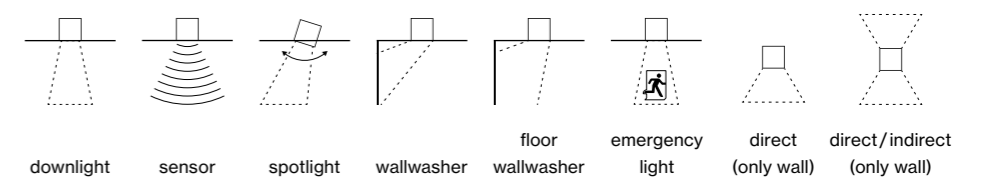

SASSO recessed

Light engines

SASSO 40
round
adjustable/
downlight



SASSO 40
round
wallwasher /
wallwasher floor



SASSO 60
round
adjustable/
downlight



SASSO 60
round
wallwasher /
wallwasher floor

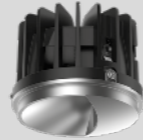

SASSO 60
square
downlight



SASSO 60
square
wallwasher /
wallwasher floor



SASSO 100
round
adjustable/
downlight

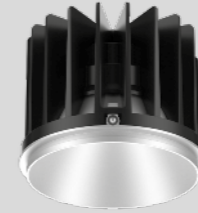

SASSO 100
round
wallwasher /
wallwasher floor



SASSO 100
square
adjustable/
downlight

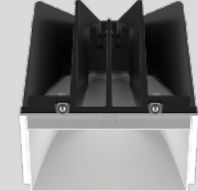

SASSO 100
square
wallwasher /
wallwasher floor



INSET POWER
LUMINOUS EFFICACY
LUMINOUS FLUX
COLOUR TEMPERATURE
BEAM ANGLE
IP RATING

7.4W
up to 84lm/W
up to 624lm
2700, 3000, 4000K
14°, 27°, 45°
‡ IP40 / † IP20 (adj.)
‡ IP44 / † IP20 (dl.)

6.8W
up to 97lm/W
up to 659lm
2700, 3000, 4000K
asymmetric
IP20

10.7W
up to 107lm/W
up to 1150lm
2700,3000,4000K,CWD
15°, 21°, 42°
‡ IP40 / † IP20 (adj.)
‡ IP44 / † IP20 (dl.)

8.2W
up to 89lm/W
up to 726lm
2700, 3000, 4000K
asymmetric
IP20

10.7W
up to 110lm/W
up to 1180lm
2700,3000,4000K,CWD
15°, 21°, 42°
‡ IP44 / † IP20

8.2W
up to 89lm/W
up to 726lm
2700, 3000, 4000K
asymmetric
IP20

17.2W, 25W
up to 116lm/W
up to 2630lm
2700, 3000, 4000K
19°, 34°, 45°, 65°
‡ IP40 / † IP20 (adj.)
‡ IP44 / † IP20 (dl.)

25W, 23.4W
up to 120lm/W
up to 2810lm
2700, 3000, 4000K
asymmetric
IP20

17.2W, 25W
up to 116lm/W
up to 2640lm
2700, 3000, 4000K
19°, 34°, 45°, 65°
‡ IP40 / † IP20 (adj.)
‡ IP44 / † IP20 (dl.)

25W, 23.4W
up to 120lm/W
up to 2810lm
2700, 3000, 4000K
asymmetric
IP20

MATERIAL COLOUR
matt silver, white,
black, gold

matt silver, white,
black, gold

matt silver, white,
black, gold

matt silver, white,
black, gold

matt silver, white,
black, gold

matt silver, white,
black, gold

matt silver, white,
black, gold

matt silver, white,
black, gold

matt silver, white,
black, gold

matt silver, white,
black, gold

Mounting accessories

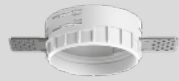

round trimless
for plasterboard ceilings 12.5/15/25 mm

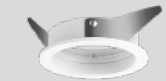
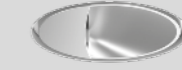

round with trim | 1 lamp
for intermediate ceilings 2-25 mm

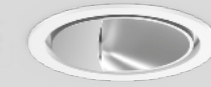

round with trim | 2 lamps
for intermediate ceilings 2-25 mm



square trimless
for plasterboard ceilings 12.5/15/25 mm

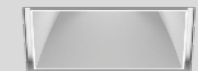
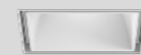

square with trim | 1 lamp
for intermediate ceilings 2-25 mm

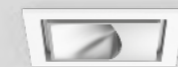
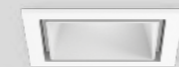

square with trim | 2 lamps
for intermediate ceilings 2-25 mm

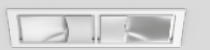

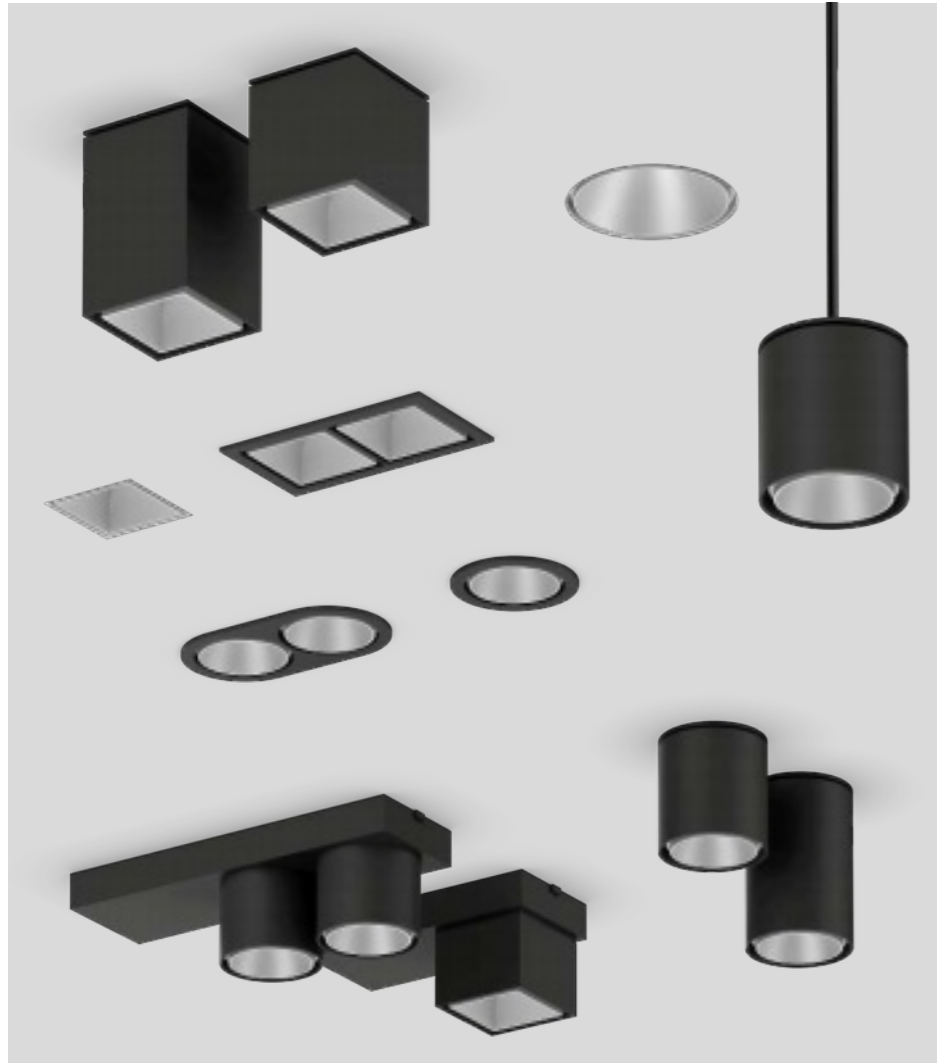

Variety

EN SASSO can be integrated into any lighting design concept. The spotlights are available as recessed, semi-recessed, wall and ceiling mounted variants, as single or dual-lamp spotlights in an elegant base, or as suspended versions. Depending on the interior design, choose between round or square luminaires and the recessed set with or without trim.

DE SASSO integriert sich in jedes lichtplanerische Konzept. Die Strahler sind als Einbau-, Halbeinbau- und Wand- sowie Deckenanbauvariante als ein- oder zweiflammiger Strahler in einem eleganten Gehäuse, oder als abgependelte Variante verfügbar. Je nach Raumgestaltung haben Sie die Wahl zwischen runden oder quadratischen Leuchten sowie dem Einbauset mit oder ohne Rand.

Colour variety

EN SASSO is available in many different colour variations to complement custom designs and colour concepts. The select housing colours (white, black, and silver) combine beautifully with silver, white, black, or gold insets, delivering a harmonious, high-quality overall design.

DE Um sich individuellen Entwürfen und Farbvorstellungen anzupassen, ist SASSO in vielen verschiedenen Farbvarianten erhältlich. Die speziellen Gehäusefarben (Weiß, Schwarz und Silber) lassen sich sehr gut mit Insets in Silber, Weiß, Schwarz oder Gold kombinieren: mit dem Ergebnis eines harmonischen, hochwertigen Gesamtbildes.

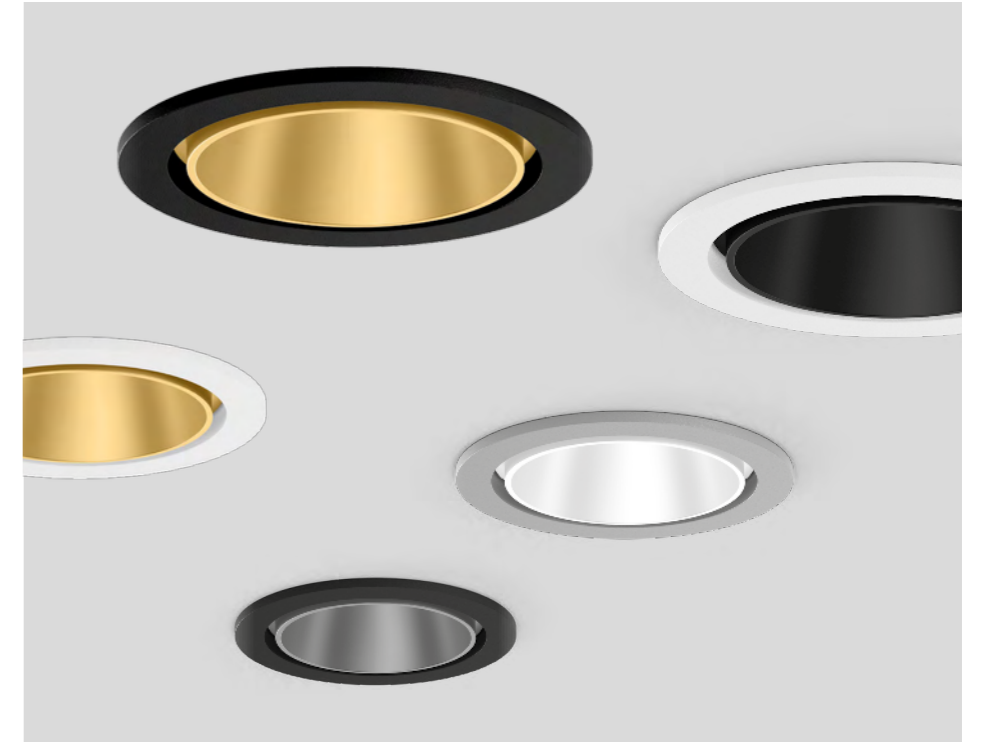

Housing colours

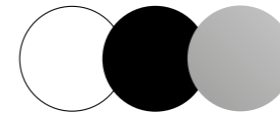

SASSO 60/100 recessed

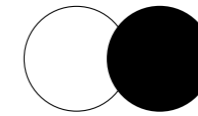

SASSO 40 recessed
SASSO 60/100 semi-recessed/
ceiling / suspended / wall

Inset colours

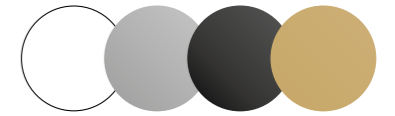

Precise light adjustment

EN A patented swivel mechanism offers the highest possible flexibility. The spotlight can be rotated through 360° and swivelled up to 30° around the horizontal axis. This enables light to be directed precisely where it is needed.

DE Ein patentierter Schwenkmechanismus schafft größtmögliche Flexibilität. Der Strahler kann nicht nur um 360° gedreht, sondern auch bis zu 30° um die horizontale Achse geschwenkt werden. Das ermöglicht die präzise Lenkung des Lichts genau dorthin, wo es gewünscht ist.



Low recess depth

EN SASSO 40 complements XAL's SASSO product family with a small, flexible spotlight that is particularly impressive due to its low height. This makes it an ideal lighting solution for ceiling constructions with an unusually low installation depth.

DE SASSO 40 erweitert die SASSO-Produktfamilie von XAL um einen kleinen, flexiblen Strahler, der vor allem durch seine geringe Höhe überzeugt. Dadurch ist er eine optimale Lichtlösung für Deckenkonstruktionen mit besonders niedriger Einbautiefe.

Light distributions

EN SASSO has four optics and thus fulfils all the fundamental functions of your lighting concept. Vertical lighting is provided by downlights with different beam angles; wallwasher and wall-floor optics provide extensive wall and floor illumination; the adjustable spotlight sets accents. If the functional area changes, the optics in the luminaire housing can be simply replaced without tools.

DE SASSO verfügt über vier Optiken und erfüllt so alle Grundfunktionen Ihres Beleuchtungskonzeptes. Vertikale Beleuchtung wird durch Downlights mit unterschiedlichen Abstrahlwinkeln erzielt, Wallwasher- und Wall-Floor-Optiken sorgen für großflächige Wand- sowie Bodenaufhellung, der Richtstrahler setzt Akzente. Wechselt der Funktionsbereich, kann die Optik im Leuchtgehäuse einfach und werkzeuglos getauscht werden.

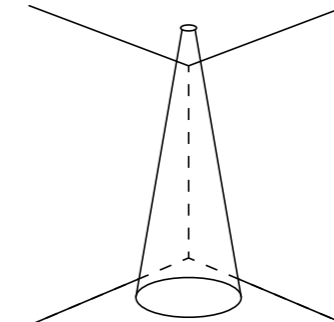

SASSO 60 downlight

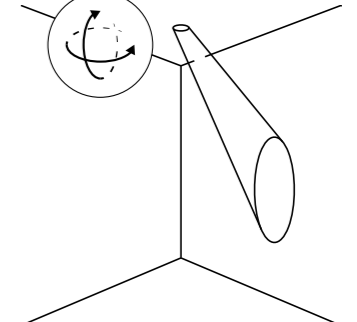

SASSO 60 adjustable

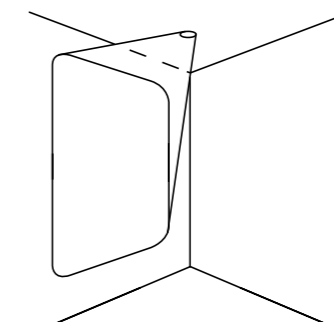

SASSO 60 wallwasher

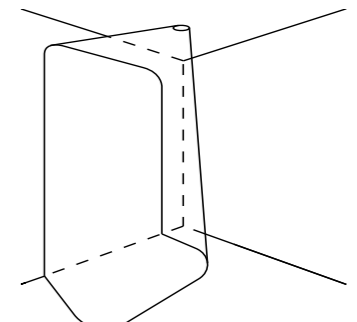

SASSO 60 wallwasher floor

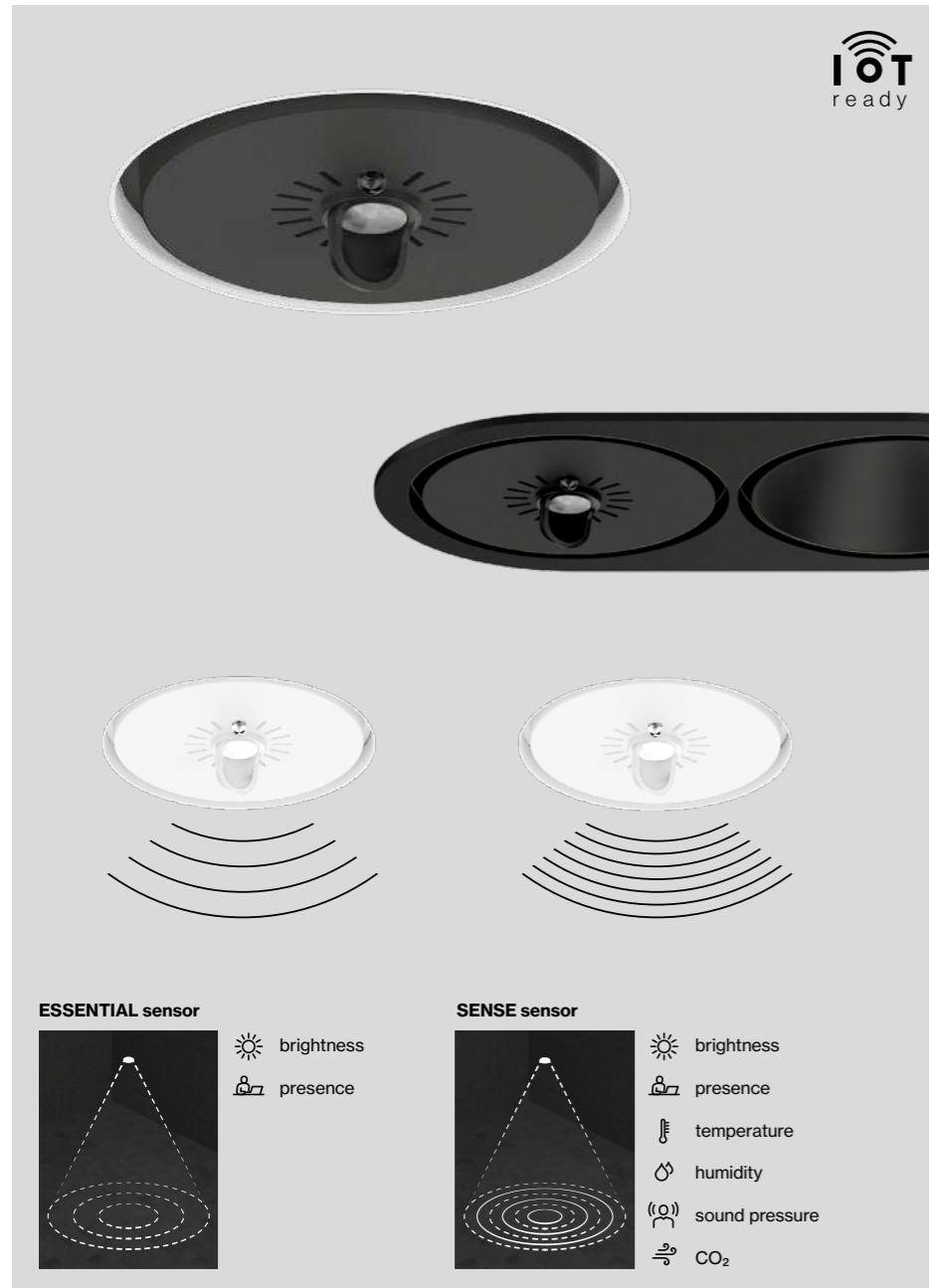

Smart lighting

EN Special sensors expand the SASSO round recessed product family with smart lighting control and collection of insightful data. The ESSENTIAL sensor enables dynamic adjustment of the lighting to ambient brightness and room activity. The SENSE version also measures values such as temperature, air quality, humidity and noise level. These data not only provide important insights into the ambient conditions and use of rooms, but also support energy savings in the long term.

DE Spezielle Sensoren erweitern die SASSO round recessed-Produktfamilie um smarte Lichtsteuerung und aufschlussreiche Datenerhebung. Der ESSENTIAL-Sensor ermöglicht die dynamische Anpassung der Beleuchtung an Umgebungshelligkeit und Raumaktivität. Die SENSE-Variante misst außerdem Werte wie Temperatur, Luftqualität, Luftfeuchtigkeit und Geräuschpegel. Diese Daten liefern nicht nur wichtige Erkenntnisse über die Umgebungsbedingungen und Nutzung von Räumen, sondern unterstützen langfristig Energieeinsparungen.

DIN Rail (DALI)

EN The DIN Rail driver centralises the power supply of several spotlights. This simplifies both the installation and maintenance of a lighting system: drivers no longer have to be installed in false ceilings, but are located collectively in a control cabinet.

More information on page 981.

DE Der DIN Rail LED Treiber zentralisiert den Stromfluss mehrerer Strahler. Dies vereinfacht sowohl die Installation als auch die Wartung einer Lichtanlage: LED Treiber müssen nicht mehr in den Zwischendecken verbaut werden, sondern befinden sich gesammelt in einem Schaltschrank.

Mehr Informationen auf Seite 981.

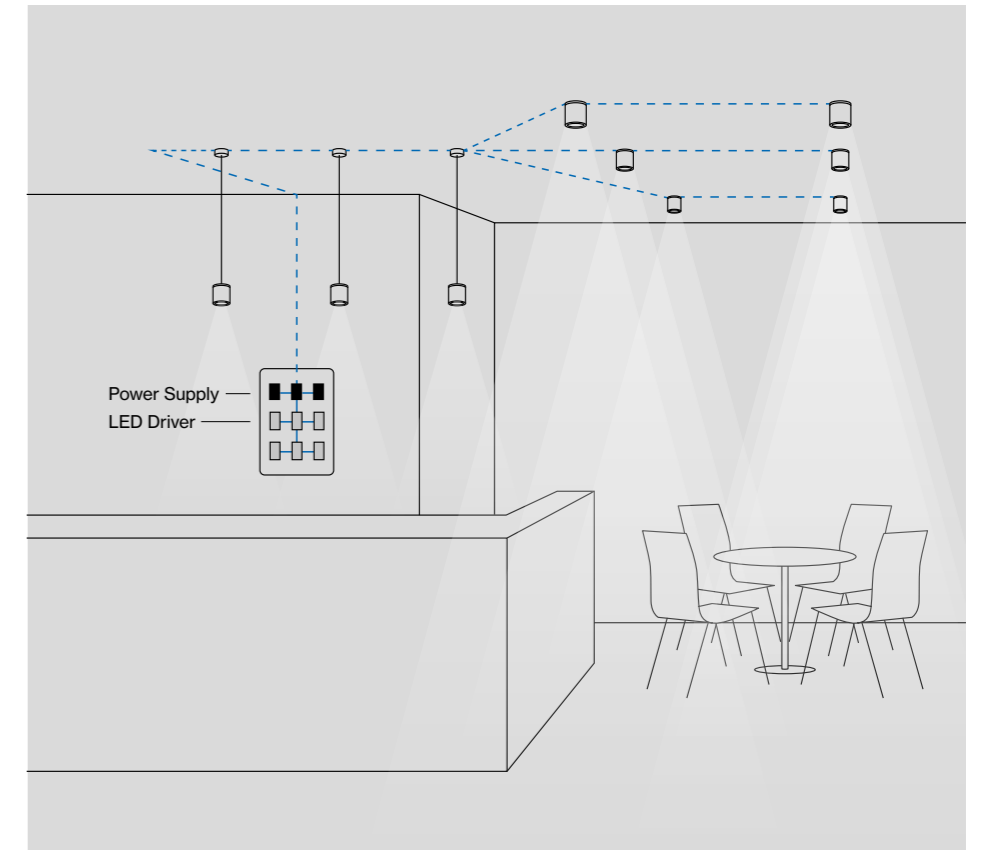

Ball catch system

EN SASSO spots are easy to replace. Assembly is quick and entirely without tools, thanks to a ball catch system. The lighting thus always adapts flexibly to new requirements and circumstances.

DE SASSO Spots sind einfach austauschbar: Die Montage erfolgt schnell und völlig ohne Werkzeug durch ein Kugelschnapsystem. So passt sich die Beleuchtung stets flexibel den neuen Anforderungen und Gegebenheiten an.

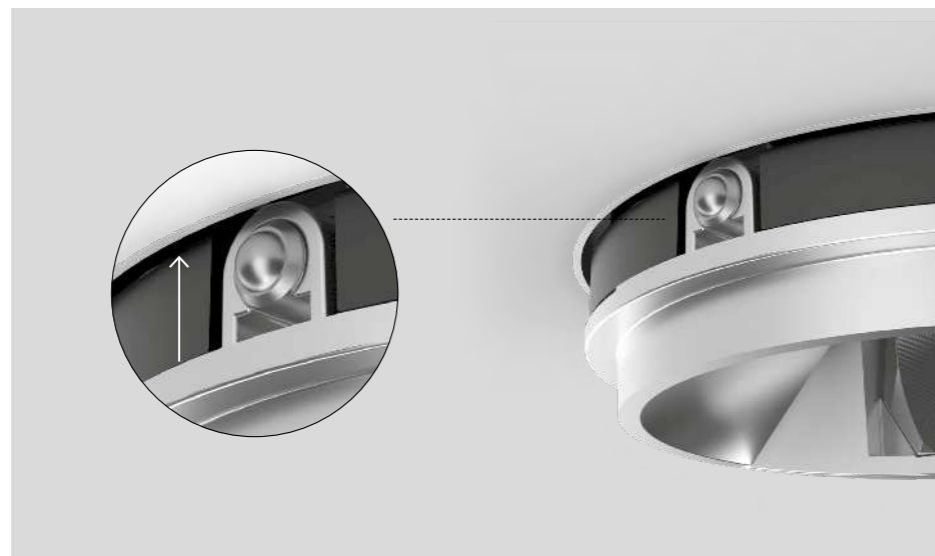

CWD – Colour Warm Dimming

EN Warm light quality with reduced illuminance. Colour Warm Dimming reduces the light intensity while continuously changing the colour temperature between 3000K and 1800K. The function supports, for example, the change between cosy restaurant lighting during the day and a relaxing lighting mood in the evening.

DE Warme Lichtqualität bei reduzierter Beleuchtungsstärke: Colour Warm Dimming senkt zugleich die Lichtintensität und wechselt die Farbtemperatur stufenlos zwischen 3000K und 1800K. Die Funktion unterstützt etwa den Wechsel zwischen gemütlicher Restaurant-Beleuchtung tagsüber und einer entspannenden Lichtstimmung am Abend.

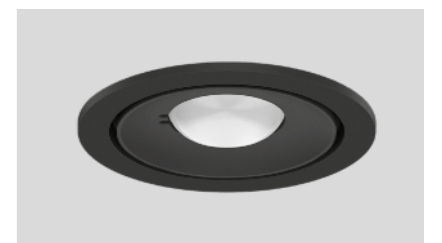

Emergency light

EN The round emergency light inset can be easily added to a lighting system without tools. The battery life is three hours – that's how long the inset can be disconnected from the power supply. It is available in three versions: BASIC provides for functional checking at the push of a button, SELF-TEST indicates functionality by means of a status LED, and in the PRO variant the status can be called up via DALI.

DE Der runde Notlicht-Einsatz lässt sich einfach werkzeuglos einer Beleuchtungsanlage hinzufügen. Die Akkulaufzeit beträgt drei Stunden – so lange kann das Inset von der Stromzufuhr getrennt sein. Erhältlich ist es in drei Varianten: BASIC sieht die Funktionsüberprüfung via Knopfdruck vor, SELF-TEST zeigt die Funktionalität durch eine Status-LED an und in der PRO-Variante ist der Status via DALI abrufbar.

← back



SASSO 40 round

recessed



EN Round recessed spotlight; installation without tools in mounting set (trimless or with trim) with ball catch system; surface lacquered; installation possible in different housings; choice of adjustable / fixed symmetric or asymmetric radiation characteristic; variants with symmetric radiation characteristic: precise radiation characteristic due to high quality lens system; variants with asymmetric radiation characteristic: high-quality reflector with micro-faceted, aluminum-vaporised surface; COB (Chip on Board) technology for maximum efficiency (ADJUSTABLE and DOWNLIGHT); no multiple shadows; efficient LEDs with very good colour rendering

DE Runder Einbaustrahler; werkzeuglose Montage im Montageset (randlos oder mit umlaufendem Rand) durch Kugelschnappsystem; Oberfläche lackiert; Einbau in unterschiedlichen Gehäusen möglich; wahlweise einstellbar / starr symmetrische oder asymmetrische Abstrahlcharakteristik; symmetrisch strahlende Varianten: präzise Abstrahlcharakteristik durch hochwertige Linsenoptik; asymmetrische strahlende Varianten: hochwertiger Reflektor mit mikrofacettierter, aluminiumbedampfter Oberfläche; COB (Chip on Board) Technologie für höchste Effizienz (ADJUSTABLE und DOWNLIGHT); keine Mehrfachschatten; effiziente LEDs mit sehr guter Farbwiedergabe

Quickinfo

2700 K, 3000 K, 4000 K
CRI ≥ 90, 2 SDCM
up to 97 lm/W
L80 @ 50 000 h
non DIM, DALI-2
↓ IP 44 / ↑ IP 20

Types

trim  
ø 44-51

trimless  
ø 48

Housing colours



Inset colours



Light distributions



Order options

COLOUR TEMPERATURE	
2700 K	4
3000 K	5
4000 K	6

INSET COLOUR	
○ traffic white RAL 9016 (UGR ≤ 22)	7
● matt silver (UGR ≤ 19)	4
● jet black RAL 9005 (UGR ≤ 16)	1
● gold dust RAL 260-M (UGR ≤ 19)	9

BEAM ANGLE	
spot 14°	S
medium 27°	M
flood 45°	F

Options on request

POWER SUPPLY
DIM 1–10 V

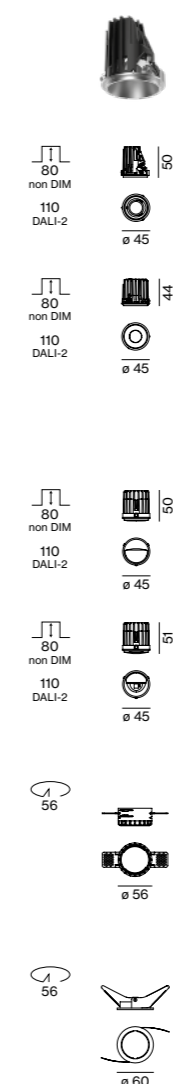

SASSO 40 round



ADJUSTABLE (↓ IP 40 / ↑ IP 20)

INSET POWER	LUMINOUS FLUX	ORDER CODE
7.4 W 36 Vf 200 mA	624 lm	0 4 8 - 2 8 2 0 :: 1 ▽ ▲

DOWNLIGHT (↓ IP 44 / ↑ IP 20)

INSET POWER	LUMINOUS FLUX	ORDER CODE
7.4 W 36 Vf 200 mA	624 lm	0 4 8 - 2 8 0 0 :: 1 ▽ ▲

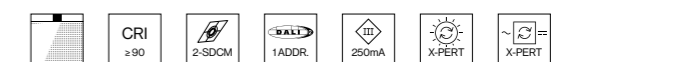

WALLWASHER (IP 20)

INSET POWER	LUMINOUS FLUX	ORDER CODE
6.8 W 27 Vf 250 mA	605 lm	0 4 8 - 2 8 4 0 :: 1 ▽ ▲

WALLWASHER / FLOOR (IP 20)

INSET POWER	LUMINOUS FLUX	ORDER CODE
6.8 W 27 Vf 250 mA	659 lm	0 4 8 - 2 8 4 0 :: 1 ▽ ▲ W

Mounting accessories

TRIMLESS MOUNTING SET for plasterboard ceilings 12.5/15/25 mm

COLOUR	ORDER CODE
○ traffic white RAL9016	0 4 8 - 2 8 9 6 1 1 7

MOUNTING SET WITH TRIM for intermediate ceilings 2–25 mm

COLOUR	ORDER CODE
○ traffic white RAL9016	0 4 8 - 2 8 9 6 3 1 7
● jet black RAL 9005	0 4 8 - 2 8 9 6 3 1 8

Electrical accessories

POWER SUPPLY 220-240 V AC, 50-60 Hz, □ PC II

TYPE	EFFICIENCY	L-W-H (mm)	ORDER CODE
200 mA non DIM	η 80 %	65-39-20	0 0 2 - 9 0 7 4 4
200 mA DALI-2	η 82 %	166-30-22	0 0 2 - 9 0 7 4 5
250 mA non DIM	η 80 %	65-39-20	0 0 2 - 9 0 7 4 2
250 mA DALI-2	η 82 %	166-30-22	0 0 2 - 9 0 7 4 3

DIN RAIL COMPONENTS

TYPE	W-H-D (mm)	ORDER CODE
POWER SUPPLY 220-240 V AC 96 W 48 V DC constant voltage	90-90-60	0 0 5 - 6 5 2 0 2 1 0
LED DRIVER DALI-2 DT6 1-2 addr. 200–1050 mA settable const. current 2 × 42 W 48 V DC U _{OUT} 10–40 V	36-88-59	0 0 5 - 6 1 2 1 0 3 0

for more details and components see page 981

Light distributions

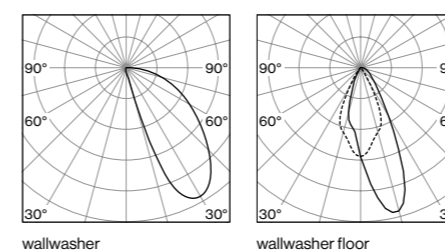

wallwasher

wallwasher floor

INSET POWER is the current consumption excluding any ballast
LUMINOUS FLUX value calculated for 3000 K, CRI ≥ 90, colour white, flood 2700 K -5%, 4000 K +5%

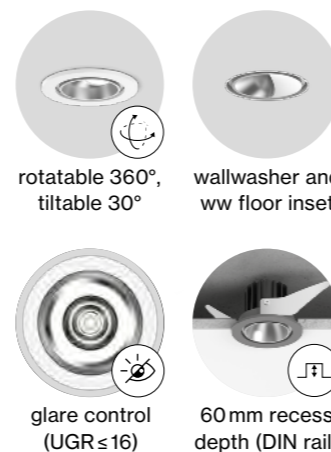

rotatable 360°,
tiltable 30°

wallwasher and
ww floor inset



glare control
(UGR ≤ 16)



60 mm recess
depth (DIN rail)



← back



SASSO 60 round

recessed



EN Round recessed spotlight; installation without tools in mounting set (trimless or with trim) with ball catch system; surface lacquered; installation possible in different housings; choice of adjustable / fixed symmetric or asymmetric radiation characteristic; variants with symmetric radiation characteristic: precise radiation characteristic due to high quality lens system; variants with asymmetric radiation characteristic: high-quality reflector with micro-faceted, aluminum-vaporised surface; COB (Chip on Board) technology for maximum efficiency (ADJUSTABLE and DOWNLIGHT); no multiple shadows; efficient LEDs with very good colour rendering

DE Runder Einbaustrahler; werkzeuglose Montage im Montageset (randlos oder mit umlaufendem Rand) durch Kugelschnappsystem; Oberfläche lackiert; Einbau in unterschiedlichen Gehäusen möglich; wahlweise einstellbar / starr symmetrische oder asymmetrische Abstrahlcharakteristik; symmetrisch strahlende Varianten: präzise Abstrahlcharakteristik durch hochwertige Linsenoptik; asymmetrische strahlende Varianten: hochwertiger Reflektor mit mikrofacettierter, aluminiumbedampfter Oberfläche; COB (Chip on Board) Technologie für höchste Effizienz (ADJUSTABLE und DOWNLIGHT); keine Mehrfachschatten; effiziente LEDs mit sehr guter Farbwiedergabe

Quickinfo

2700 K, 3000 K, 4000 K, CWD
CRI ≥ 90, 2 SDCM
up to 107 lm/W
L80 @ 50 000 h
non DIM, DALI-2
↓ IP 44 / ↑ IP 20

Types

trim		48
	ø 80	
trimless		48
	ø 63	
double trim		48
	147x80	

Housing colours



Inset colours



Light distributions



rotatable 360°,
tiltable 30°



wallwasher and
ww floor inset



glare control
(UGR ≤ 16)

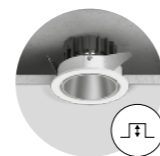

60 mm
recess depth



CWD
1800–3000 K

Order options

COLOUR TEMPERATURE

2700 K	4
3000 K	5
4000 K	6
CWD 1800–3000 K*	

*only for DALI-2

INSET COLOUR

○ traffic white RAL 9016 (UGR ≤ 22)	7
● matt silver (UGR ≤ 19)	4
● jet black RAL 9005 (UGR ≤ 16)	1
● gold dust RAL 260-M (UGR ≤ 19)	9

BEAM ANGLE

spot 15°	S
medium 21°	M
flood 42°	F

Options on request

COLOR RENDERING INDEX

CRI ≥ 95, 2 SDCM

CONTROL

Casambi

MOUNTING SET

acoustic soft ceilings

POWER SUPPLY

DIM 1–10 V

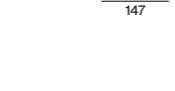
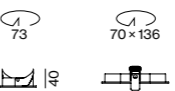
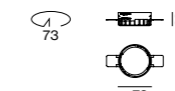

SASSO 60 round



ADJUSTABLE (↓ IP 40 / ↑ IP 20)

INSET POWER	LUMINOUS FLUX	ORDER CODE
10.7 W 36 Vf 300 mA	1040 lm	0 4 8 - 2 6 2 2 :: 1 1 1 1
10.4 W 35 Vf 300 mA	CWD 949 lm	0 4 8 - 2 6 2 2 E 1 1 1 1

DOWNLIGHT (↓ IP 44 / ↑ IP 20)

INSET POWER	LUMINOUS FLUX	ORDER CODE
10.7 W 36 Vf 300 mA	1070 lm	0 4 8 - 2 6 0 2 :: 1 1 1 1
10.4 W 35 Vf 300 mA	CWD 949 lm	0 4 8 - 2 6 0 2 E 1 1 1 1



WALLWASHER (IP 20)

INSET POWER	LUMINOUS FLUX	ORDER CODE
8.2 W 27 Vf 300 mA	635 lm	0 4 8 - 2 6 4 1 :: 1 1 1 1

WALLWASHER/FLOOR (IP 20)

INSET POWER	LUMINOUS FLUX	ORDER CODE
8.2 W 27 Vf 300 mA	633 lm	0 4 8 - 2 6 4 1 :: 1 1 1 1

Mounting accessories

TRIMLESS MOUNTING SET for plasterboard ceilings 12.5/15/25 mm

COLOUR	ORDER CODE
○ traffic white RAL9016	0 4 8 - 2 6 9 6 1 1 7

MOUNTING SET WITH TRIM for intermediate ceilings 2–25 mm

TYPE	COLOUR	ORDER CODE
1 lamp	● white aluminium RAL 9006	0 4 8 - 2 6 9 6 3 1 G
	○ traffic white RAL9016	0 4 8 - 2 6 9 6 3 1 7
	● jet black RAL 9005	0 4 8 - 2 6 9 6 3 1 8
2 lamps	● white aluminium RAL 9006	0 4 8 - 2 6 9 8 3 1 G
	○ traffic white RAL9016	0 4 8 - 2 6 9 8 3 1 7
	● jet black RAL 9005	0 4 8 - 2 6 9 8 3 1 8

CONCRETE MOUNTING HOUSING

COLOUR	L-W-H (mm)	ORDER CODE
exposed concrete ceilings	230-230-162	0 4 8 - 2 6 9 5 2 1 0
primed concrete ceilings*	614-307-120	0 4 8 - 2 6 9 5 1 1 0

*order mounting set separately, not applicable for 2 lamps mounting set with trim

Electrical accessories

POWER SUPPLY 220-240 V AC, 50-60 Hz, □ PC II

TYPE	EFFICIENCY	L-W-H (mm)	ORDER CODE
300 mA non DIM	η 85 %	85-40-22	0 0 2 - 9 0 7 7 1
300 mA DALI-2	η 88 %	143-43-30	0 0 2 - 9 0 7 6 2

DIN RAIL COMPONENTS

TYPE	W-H-D (mm)	ORDER CODE
POWER SUPPLY 220-240 V AC	90-90-60	0 0 5 - 6 5 2 0 2 1 0
96 W 48 V DC constant voltage		
LED DRIVER DALI-2 DT6 1–2 addr.	36-88-59	0 0 5 - 6 1 2 1 0 3 0
200–1050 mA settable const. current		
2 × 42 W 48 V DC U _{OUT} 10–40 V		

for more details and components see page 981

Light distributions

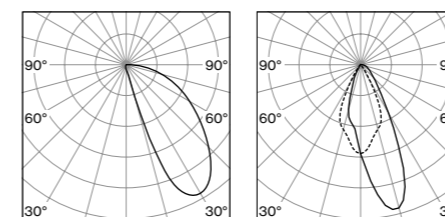

wallwasher

wallwasher floor

INSET POWER is the current consumption excluding any ballast
LUMINOUS FLUX value calculated for 3000 K, CRI ≥ 90, colour white, flood 2700 K -5%, 4000 K +5%

← back



SASSO 100 round

recessed

EN Round recessed spotlight; installation without tools in mounting set (trimless or with trim) with ball catch system; surface lacquered; installation possible in different housings; choice of adjustable / fixed symmetric or asymmetric radiation characteristic; variants with symmetric radiation characteristic: precise radiation characteristic due to high quality lens system; variants with asymmetric radiation characteristic: high-quality reflector with micro-faceted, aluminum-vaporised surface; COB (Chip on Board) technology for maximum efficiency (ADJUSTABLE and DOWNLIGHT); no multiple shadows; efficient LEDs with very good colour rendering

DE Runder Einbaustrahler; werkzeuglose Montage im Montageset (randlos oder mit umlaufendem Rand) durch Kugelschnappsystem; Oberfläche lackiert; Einbau in unterschiedlichen Gehäusen möglich; wahlweise einstellbar / starr symmetrische oder asymmetrische Abstrahlcharakteristik; symmetrisch strahlende Varianten: präzise Abstrahlcharakteristik durch hochwertige Linsenoptik; asymmetrische strahlende Varianten: hochwertiger Reflektor mit mikrofacettierter, aluminiumbedampfter Oberfläche; COB (Chip on Board) Technologie für höchste Effizienz (ADJUSTABLE und DOWNLIGHT); keine Mehrfachschatten; effiziente LEDs mit sehr guter Farbwiedergabe

Quickinfo

2700 K, 3000 K, 4000 K
CRI ≥ 90, 2 SDCM
up to 120 lm/W
L80 @ 50 000 h
non DIM, DALI-2
↓ IP 44 / ↑ IP 20

Types

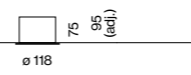
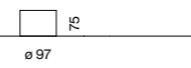
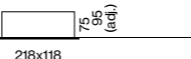
trim		75 95 (depth) ø 118
trimless		75 ø 97
double trim		75 95 (depth) 218x118

Housing colours



Inset colours



Light distributions

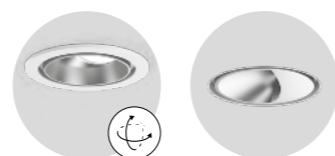

rotatable 360°,
tiltable 30°



wallwasher and
ww floor inset

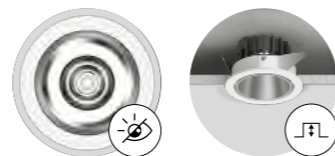

glare control
(UGR ≤ 16)

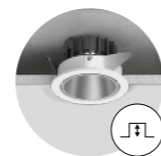

80 mm
recess depth

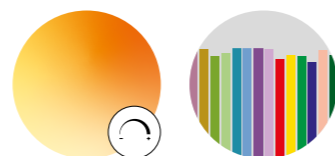

CWD
1800–3000 K



CRI ≥ 95
2 SDCM

Order options

COLOUR TEMPERATURE	
2700 K	4
3000 K	5
4000 K	6

INSET COLOUR	
○ traffic white RAL 9016 (UGR ≤ 22)	7
● matt silver (UGR ≤ 19)	4
● jet black RAL 9005 (UGR ≤ 16)	1
● gold dust RAL 260-M (UGR ≤ 19)	9

BEAM ANGLE	
spot 19°	S
medium 34°	M
flood 45°	F
wide flood 65°	W

Options on request

COLOR RENDERING INDEX
CRI ≥ 95, 2 SDCM

COLOUR TEMPERATURE
CWD 1800–3000 K
not for WW & WWF version

CONTROL
Casambi

MOUNTING SET
acoustic soft ceilings

POWER SUPPLY
DIM 1–10 V

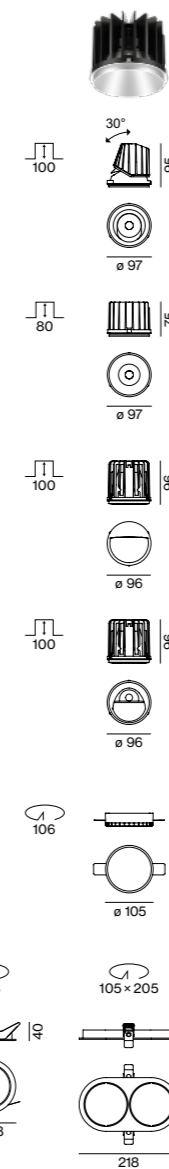

SASSO 100 round



ADJUSTABLE (↓ IP 40 / ↑ IP 20)

INSET POWER	LUMINOUS FLUX	ORDER CODE
17.2 W 36 Vf 500 mA	1850 lm	0 4 8 - 2 7 2 0 :: 1 1 4
25 W 36 Vf 700 mA	2450 lm	0 4 8 - 2 7 2 0 :: 1 1 4

DOWNLIGHT (↓ IP 44 / ↑ IP 20)

INSET POWER	LUMINOUS FLUX	ORDER CODE
17.2 W 36 Vf 500 mA	1830 lm	0 4 8 - 2 7 0 0 :: 1 1 4
25 W 36 Vf 700 mA	2410 lm	0 4 8 - 2 7 0 0 :: 1 1 4



WALLWASHER (IP 20)

INSET POWER	LUMINOUS FLUX	ORDER CODE
25 W 36 Vf 700 mA	2290 lm	0 4 8 - 2 7 4 0 :: 1 1 4

WALLWASHER/FLOOR (IP 20)

INSET POWER	LUMINOUS FLUX	ORDER CODE
23.4 W 36 Vf 700 mA	2670 lm	0 4 8 - 2 7 4 0 :: 1 1 4

Mounting accessories

TRIMLESS MOUNTING SET for plasterboard ceilings 12.5/15/25 mm

COLOUR	ORDER CODE
○ traffic white RAL9016	0 4 8 - 2 7 9 6 1 1 7

MOUNTING SET WITH TRIM for intermediate ceilings 2–25 mm

TYPE	COLOUR	ORDER CODE
1 lamp	● white aluminium RAL 9006	0 4 8 - 2 7 9 6 3 1 G
	○ traffic white RAL9016	0 4 8 - 2 7 9 6 3 1 7
	● jet black RAL 9005	0 4 8 - 2 7 9 6 3 1 8
2 lamps	● white aluminium RAL 9006	0 4 8 - 2 7 9 8 3 1 G
	○ traffic white RAL9016	0 4 8 - 2 7 9 8 3 1 7
	● jet black RAL 9005	0 4 8 - 2 7 9 8 3 1 8

CONCRETE MOUNTING HOUSING

COLOUR	L-W-H (mm)	ORDER CODE
exposed concrete ceilings	230-230-162	0 4 8 - 2 7 9 5 2 1 0
primed concrete ceilings*	614-307-120	0 4 8 - 2 6 9 5 1 1 0

*order mounting set separately, not applicable for 2 lamps mounting set with trim

Electrical accessories

POWER SUPPLY 220-240 V AC, 50-60 Hz, PC II

TYPE	EFFICIENCY	L-W-H (mm)	ORDER CODE
500 mA non DIM	η 88 %	143-43-30	0 0 2 - 9 0 7 7 7
500 mA DALI-2	η 88 %	143-43-30	0 0 2 - 9 0 7 7 9
700 mA non DIM	η 80 %	143-43-30	0 0 2 - 9 0 7 7 4
700 mA DALI-2	η 88 %	143-43-30	0 0 2 - 9 0 7 7 6

THROUGH WIRING CONNECTION BOX

TYPE	L-W-H (mm)	ORDER CODE
non DIM cable ø 4–12 mm	105-58-30	0 0 5 - 2 5 3 1 1 1 0
DALI cable ø 4–12 mm	105-58-30	0 0 5 - 2 5 5 1 1 1 0

DIN RAIL COMPONENTS

TYPE	W-H-D (mm)	ORDER CODE
POWER SUPPLY 220-240 V AC 96 W 48 V DC constant voltage	90-90-60	0 0 5 - 6 5 2 0 2 1 0
LED DRIVER DALI-2 DT6 1–2 addr. 200–1050 mA settable const. current 2 × 42 W 48 V DC U _{OUT} 10–40 V	36-88-59	0 0 5 - 6 1 2 1 0 3 0

for more details and components see page 981

INSET POWER is the current consumption excluding any ballast
LUMINOUS FLUX value calculated for 3000 K, CRI ≥ 90, colour white, wide flood
2700 K -5%, 4000 K +5%

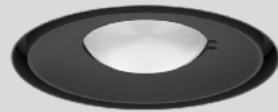

SASSO 60 round sensor/emergency

recessed

EN Round inset (Emergency Light or Sensor); installation without tools in mounting set (trimless or with trim) with ball catch system; surface lacquered; installation possible in different housings; LED emergency light inset: 3 variants with different test possibilities - BASIC with test button, SELF-TEST with status LED or PRO DALI-2 with monitoring via DALI; sensor with DALI-2 control: 2 variants - ESSENTIAL with brightness and presence sensor or SENSE with additional temperature, humidity, air quality and noise level measurement

DE Runder Einsatz (Notlicht bzw. Sensor); werkzeuglose Montage im Montageset (randlos oder mit umlaufendem Rand) durch Kugelschnappsystem; Oberfläche lackiert; Einbau in unterschiedlichen Gehäusen möglich; LED Notlicht-Einsatz: 3 Varianten mit verschiedenen Testmöglichkeiten - BASIC mit Prüftaste, SELF-TEST mit Status-LED oder PRO DALI-2 mit Überwachung über DALI; Sensor mit DALI-2 Steuerung: 2 Varianten - ESSENTIAL mit Helligkeits- und Anwesenheitssensor oder SENSE mit zusätzlicher Temperatur-, Luftfeuchtigkeits-, Luftqualitäts- und Lärmpegelmessung

Quickinfo

sensor
ESSENTIAL, SENSE
DALI-2

emergency light
6500K
CRI ≥ 80
200lm
L80 @ 50000h
non maintained

Types

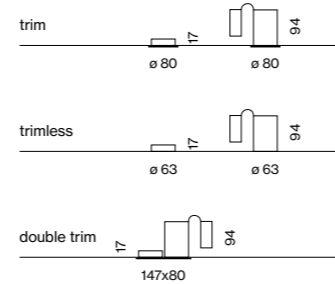

Housing colours



Inset colours



Sensors



Order options

INSET COLOUR
 traffic white RAL 9016 7
 jet black RAL 9005 1

BEAM ANGLE EMERGENCY LIGHT

spot lens
escape route lens
anti panic lens

Options on request

MOUNTING SET
acoustic soft ceilings

INSET COLOUR

grey, gold

Light distributions

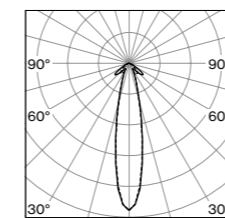

emergency light
spot lens

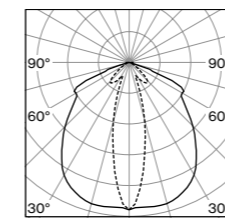

emergency light
escape route lens

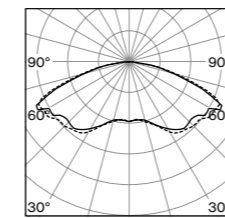

emergency light
anti panic lens

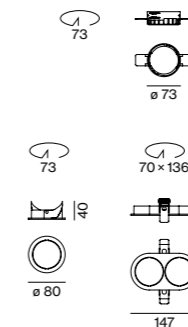
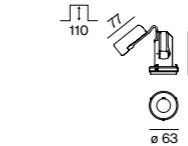

SASSO 60 sensor round



ESSENTIAL SENSOR

TYPE
brightness & presence

ORDER CODE
048-269311

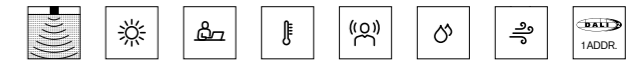

SENSE SENSOR

TYPE
brightness, presence, temperature,
sound pressure, humidity, CO₂

ORDER CODE
048-269312

SASSO 60 emergency light round



EMERGENCY 3h

TYPE
BASIC | 2W
SELF-TEST | 2W
PRO DALI-2 | 2W

ORDER CODE
048-269321
048-269322
048-269323

incl. 3 interchangeable lenses

Electrical accessories

ACCUPACK

TYPE
replacement accupack 3h

ORDER CODE
048-2693910

Mounting accessories

TRIMLESS MOUNTING SET for plasterboard ceilings 12.5/15/25mm

COLOUR
 traffic white RAL9016

ORDER CODE
048-2696117

MOUNTING SET WITH TRIM for intermediate ceilings 2-25mm

TYPE
1 lamp
2 lamps

COLOUR
 traffic white RAL9016
 jet black RAL 9005
 traffic white RAL9016
 jet black RAL 9005

ORDER CODE
048-2696317
048-2696318
048-2698317
048-2698318

CONCRETE MOUNTING HOUSING

COLOUR
exposed concrete ceilings
primed concrete ceilings*

L-W-H (mm)
230-230-162
614-307-120

ORDER CODE
048-2695210
048-2695110

*order mounting set separately, not applicable for 2 lamps mounting set with trim



Deansgate Square Manchester, UK –
by Lister & Lister with lighting design
by Troup, Bywaters & Anders Lighting

Deansgate Square Manchester, UK –
by Lister & Lister with lighting design
by Troup, Bywaters & Anders Lighting



HeidelbergCement AG
Heidelberg, DE – by Albert Speer +
Partner Architekten with lighting
design by Hailight Lichtplanung,
Andreas Haidegger





Oppenländer Rechtsanwälte
Stuttgart, DE – by Ippolito Fleitz
Group GmbH

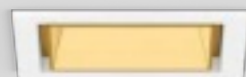
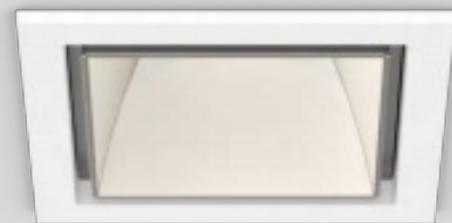

[← back](#)

SASSO 60 square

recessed

EN Square recessed spotlight; installation without tools in mounting set (trimless or with trim) with ball catch system; surface lacquered; installation possible in different housings; choice of fixed symmetric or asymmetric radiation characteristic; variants with symmetric radiation characteristic: precise radiation characteristic due to high quality lens system; variants with asymmetric radiation characteristic: high-quality reflector with micro-faceted, aluminum-vaporised surface; COB (Chip on Board) technology for maximum efficiency (DOWNLIGHT); no multiple shadows; efficient LEDs with very good colour rendering

DE Quadratischer Einbaustrahler; werkzeuglose Montage im Montageset (randlos oder mit umlaufendem Rand) durch Kugelschnapsystem; Oberfläche lackiert; Einbau in unterschiedlichen Gehäusen möglich; wahlweise starr symmetrische oder asymmetrische Abstrahlcharakteristik; symmetrisch strahlende Varianten: präzise Abstrahlcharakteristik durch hochwertige Linsenoptik; asymmetrische strahlende Varianten: hochwertiger Reflektor mit mikrofaccettierter, aluminiumbedampfter Oberfläche; COB (Chip on Board) Technologie für höchste Effizienz (DOWNLIGHT); keine Mehrfachschatten; effiziente LEDs mit sehr guter Farbwiedergabe

Quickinfo

2700 K, 3000 K, 4000 K, CWD
 CRI ≥ 90, 2 SDCM
 up to 110 lm/W
 L80 @ 50 000 h
 non DIM, DALI-2
 ↓ IP 44 / ↑ IP 20

Types

trim		48
		80
trimless		48
		63
double trim		48
		147x81

Housing colours



Inset colours



Light distributions



wallwasher and
ww floor inset



glare control
(UGR ≤ 16)

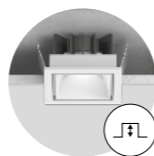

60 mm
recess depth

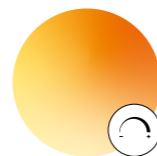

CWD
1800–3000 K



CRI ≥ 95
2 SDCM

Order options

COLOUR TEMPERATURE	☼☼☼
2700 K	4
3000 K	5
4000 K	6
CWD 1800–3000 K*	

*only for DALI-2

INSET COLOUR

<input type="radio"/> traffic white RAL 9016 (UGR ≤ 22)	7
<input type="radio"/> matt silver (UGR ≤ 19)	4
<input type="radio"/> jet black RAL 9005 (UGR ≤ 16)	1
<input type="radio"/> gold dust RAL 260-M (UGR ≤ 19)	9

BEAM ANGLE

spot 15°	S
medium 21°	M
flood 42°	F

Options on request

COLOR RENDERING INDEX

CRI ≥ 95, 2 SDCM

CONTROL

Casambi

MOUNTING SET

acoustic soft ceilings

POWER SUPPLY

DIM 1–10 V

Light distributions

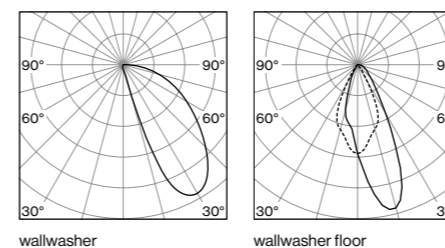

INSET POWER is the current consumption excluding any ballast
LUMINOUS FLUX value calculated for 3000 K, CRI ≥ 90, colour white, flood 2700 K -5%, 4000 K +5%

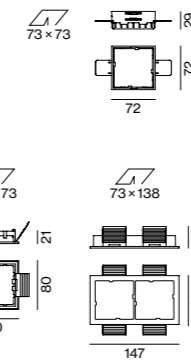
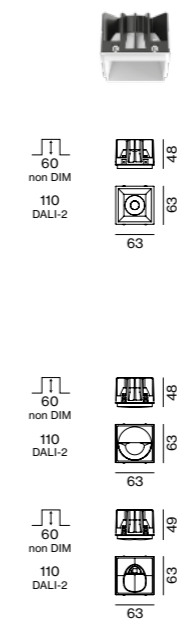

SASSO 60 square



DOWNLIGHT (↓ IP 44 / ↑ IP 20)

INSET POWER	LUMINOUS FLUX	ORDER CODE
10.7 W 36 Vf 300 mA	1180 lm	0 4 8 - 2 6 1 2 :: 1 ▽ ▲
10.4 W 35 Vf 300 mA	CWD 949 lm	0 4 8 - 2 6 1 2 E 1 ▽ ▲



WALLWASHER (IP 20)

INSET POWER	LUMINOUS FLUX	ORDER CODE
8.2 W 27 Vf 300 mA	635 lm	0 4 8 - 2 6 5 1 :: 1 ▽ ▲

WALLWASHER/FLOOR (IP 20)

INSET POWER	LUMINOUS FLUX	ORDER CODE
8.2 W 27 Vf 300 mA	633 lm	0 4 8 - 2 6 5 1 :: 1 ▽ ▲ W

Mounting accessories

TRIMLESS MOUNTING SET for plasterboard ceilings 12.5/15/25 mm

COLOUR	ORDER CODE
<input type="radio"/> traffic white RAL9016	0 4 8 - 2 6 9 7 1 1 7

MOUNTING SET WITH TRIM for intermediate ceilings 2–25 mm

TYPE	COLOUR	ORDER CODE
1 lamp	<input type="radio"/> white aluminium RAL 9006	0 4 8 - 2 6 9 7 3 1 G
	<input type="radio"/> traffic white RAL9016	0 4 8 - 2 6 9 7 3 1 7
2 lamps	<input type="radio"/> jet black RAL 9005	0 4 8 - 2 6 9 7 3 1 8
	<input type="radio"/> white aluminium RAL 9006	0 4 8 - 2 6 9 9 3 1 G
	<input type="radio"/> traffic white RAL9016	0 4 8 - 2 6 9 9 3 1 7
	<input type="radio"/> jet black RAL 9005	0 4 8 - 2 6 9 9 3 1 8

CONCRETE MOUNTING HOUSING

COLOUR	L-W-H (mm)	ORDER CODE
primed concrete ceilings*	614-307-120	0 4 8 - 2 6 9 5 1 1 0

*order mounting set separately, not applicable for 2 lamps mounting set with trim

Electrical accessories

POWER SUPPLY 220-240 V AC, 50-60 Hz, □ PC II

TYPE	EFFICIENCY	L-W-H (mm)	ORDER CODE
300 mA non DIM	η 85 %	85-40-22	0 0 2 - 9 0 7 7 1
300 mA DALI-2	η 88 %	143-43-30	0 0 2 - 9 0 7 6 2

THROUGH WIRING CONNECTION BOX

TYPE	L-W-H (mm)	ORDER CODE
non DIM cable ø 4–12 mm	105-58-30	0 0 5 - 2 5 3 1 1 1 0
DALI cable ø 4–12 mm	105-58-30	0 0 5 - 2 5 5 1 1 1 0

DIN RAIL COMPONENTS

TYPE	W-H-D (mm)	ORDER CODE
POWER SUPPLY 220-240 V AC	90-90-60	0 0 5 - 6 5 2 0 2 1 0
96 W 48V DC constant voltage		
LED DRIVER DALI-2 DT6 1–2 addr.	36-88-59	0 0 5 - 6 1 2 1 0 3 0
200–1050 mA settable const. current		
2 × 42 W 48 V DC U _{OUT} 10–40 V		

for more details and components see page 981

← back

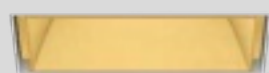
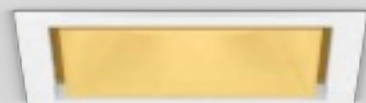

SASSO 100 square

recessed







EN Square recessed spotlight; installation without tools in mounting set (trimless or with trim) with ball catch system; surface lacquered; installation possible in different housings; choice of adjustable / fixed symmetric or asymmetric radiation characteristic; variants with symmetric radiation characteristic: precise radiation characteristic due to high quality lens system; variants with asymmetric radiation characteristic: high-quality reflector with micro-faceted, aluminum-vaporised surface; COB (Chip on Board) technology for maximum efficiency (ADJUSTABLE and DOWNLIGHT); no multiple shadows; efficient LEDs with very good colour rendering

DE Quadratischer Einbaustrahler; werkzeuglose Montage im Montageset (randlos oder mit umlaufendem Rand) durch Kugelschnapsystem; Oberfläche lackiert; Einbau in unterschiedlichen Gehäusen möglich; wahlweise einstellbar / starr symmetrische oder asymmetrische Abstrahlcharakteristik; symmetrisch strahlende Varianten: präzise Abstrahlcharakteristik durch hochwertige Linsenoptik; asymmetrische strahlende Varianten: hochwertiger Reflektor mit mikrofacettierter, aluminiumbedampfter Oberfläche; COB (Chip on Board) Technologie für höchste Effizienz (ADJUSTABLE und DOWNLIGHT); keine Mehrfachschatten; effiziente LEDs mit sehr guter Farbwiedergabe

Quickinfo

2700 K, 3000 K, 4000 K
CRI ≥ 90, 2 SDCM
up to 120 lm/W
L80 @ 50 000 h
non DIM, DALI-2
↓ IP 44 / ↑ IP 20

Types

trim		75	95	(edf)
		118		
trimless		75	95	(edf)
		97		
double trim		75	95	(edf)
		218x118		

Housing colours



Inset colours



Light distributions



wallwasher and
ww floor inset



glare control
(UGR ≤ 16)



60 mm
recess depth



CWD
1800–3000 K



CRI ≥ 95
2 SDCM

Order options

COLOUR TEMPERATURE	☼☼☼
2700 K	4
3000 K	5
4000 K	6

INSET COLOUR	☑
○ traffic white RAL 9016 (UGR ≤ 22)	7
● matt silver (UGR ≤ 19)	4
● jet black RAL 9005 (UGR ≤ 16)	1
● gold dust RAL 260-M (UGR ≤ 19)	9

BEAM ANGLE	▲
spot 19°	S
medium 34°	M
flood 45°	F
wide flood 65°	W

Options on request

COLOR RENDERING INDEX
CRI ≥ 95, 2 SDCM

COLOUR TEMPERATURE
CWD 1800–3000 K
not for WW & WWF version

CONTROL

Casambi

MOUNTING SET

acoustic soft ceilings

POWER SUPPLY

DIM 1–10 V

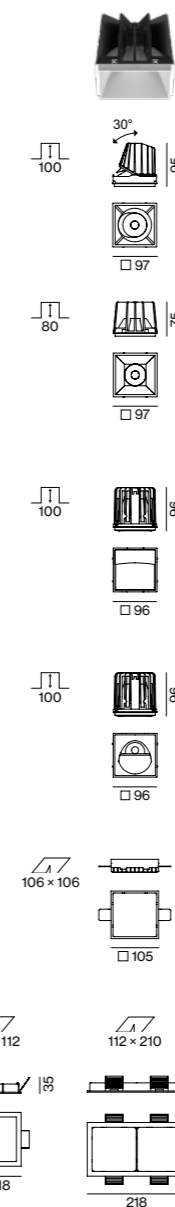

SASSO 100 square



ADJUSTABLE (↓ IP 40 / ↑ IP 20)

INSET POWER	LUMINOUS FLUX	ORDER CODE
17.2 W 36 Vf 500 mA	1860 lm	0 4 8 - 2 7 3 0 :: 1 ☑ ▲
25 W 36 Vf 700 mA	2450 lm	0 4 8 - 2 7 3 0 :: 1 ☑ ▲

DOWNLIGHT (↓ IP 44 / ↑ IP 20)

INSET POWER	LUMINOUS FLUX	ORDER CODE
17.2 W 36 Vf 500 mA	1890 lm	0 4 8 - 2 7 1 0 :: 1 ☑ ▲
25 W 36 Vf 700 mA	2500 lm	0 4 8 - 2 7 1 0 :: 1 ☑ ▲



WALLWASHER (IP 20)

INSET POWER	LUMINOUS FLUX	ORDER CODE
25 W 36 Vf 700 mA	2290 lm	0 4 8 - 2 7 5 0 :: 1 ☑ ▲

WALLWASHER/FLOOR (IP 20)

INSET POWER	LUMINOUS FLUX	ORDER CODE
23.4 W 36 Vf 700 mA	2670 lm	0 4 8 - 2 7 5 0 :: 1 ☑ ▲

Mounting accessories

TRIMLESS MOUNTING SET for plasterboard ceilings 12.5/15/25 mm

COLOUR	ORDER CODE
○ traffic white RAL9016	0 4 8 - 2 7 9 7 1 1 7

MOUNTING SET WITH TRIM for intermediate ceilings 2–25 mm

TYPE	COLOUR	ORDER CODE
1 lamp	● white aluminium RAL 9006	0 4 8 - 2 7 9 7 3 1 G
	○ traffic white RAL9016	0 4 8 - 2 7 9 7 3 1 7
	● jet black RAL 9005	0 4 8 - 2 7 9 7 3 1 8
2 lamps	● white aluminium RAL 9006	0 4 8 - 2 7 9 9 3 1 G
	○ traffic white RAL9016	0 4 8 - 2 7 9 9 3 1 7
	● jet black RAL 9005	0 4 8 - 2 7 9 9 3 1 8

CONCRETE MOUNTING HOUSING

COLOUR	L-W-H (mm)	ORDER CODE
primed concrete ceilings*	614-307-120	0 4 8 - 2 6 9 5 1 1 0

*order mounting set separately, not applicable for 2 lamps mounting set with trim

Electrical accessories

POWER SUPPLY 220-240 V AC, 50-60 Hz, □ PC II

TYPE	EFFICIENCY	L-W-H (mm)	ORDER CODE
500 mA non DIM	η 88 %	143-43-30	0 0 2 - 9 0 7 7 7
500 mA DALI-2	η 88 %	143-43-30	0 0 2 - 9 0 7 7 9
700 mA non DIM	η 80 %	143-43-30	0 0 2 - 9 0 7 7 4
700 mA DALI-2	η 88 %	143-43-30	0 0 2 - 9 0 7 7 6

THROUGH WIRING CONNECTION BOX

TYPE	L-W-H (mm)	ORDER CODE
non DIM cable ø 4–12 mm	105-58-30	0 0 5 - 2 5 3 1 1 1 0
DALI cable ø 4–12 mm	105-58-30	0 0 5 - 2 5 5 1 1 1 0

DIN RAIL COMPONENTS

TYPE	W-H-D (mm)	ORDER CODE
POWER SUPPLY 220-240 V AC 96 W 48 V DC constant voltage	90-90-60	0 0 5 - 6 5 2 0 2 1 0
LED DRIVER DALI-2 DT6 1–2 addr. 200–1050 mA settable const. current 2 × 42 W 48 V DC U _{OUT} 10–40 V	36-88-59	0 0 5 - 6 1 2 1 0 3 0

for more details and components see page 981

Light distributions

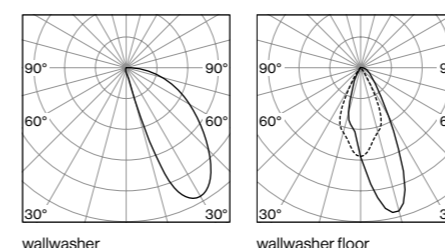

wallwasher

wallwasher floor

INSET POWER is the current consumption excluding any ballast
LUMINOUS FLUX value calculated for 3000 K, CRI ≥ 90, colour white, wide flood
2700 K -5%, 4000 K +5%

Zeitgeist Graz, AT –
by FIPE ARCHITECTURE



← back



SASSO 60/100 round

semi-recessed

EN Cylindrical semi-recessed spotlight made of aluminium, available in 2 sizes; light inset lacquered; housing powder coated; luminaire housing can be attached to mounting plate without tools by interlock; choice of adj. sym. or asym. radiation characteristic; variants with sym. radiation characteristic: precise due to high quality lens system; variants with asym. radiation characteristic: high-quality reflector with micro-faceted, aluminum-vaporised surface; COB (Chip on Board) technology for maximum efficiency (ADJUSTABLE); no multiple shadows; efficient LEDs with very good colour rendering; external converter for ceiling insertion, for through-wiring suitable

DE Zylindrischer Halbeinbaustrahler aus Aluminium in 2 Größen; Leuchteinsatz lackiert; Gehäuse pulverbeschichtet; Leuchtenkörper mittels Verriegelung werkzeuglos auf Montageplatte aufsetzbar; wahlweise einstellbar sym. oder asym. Abstrahlcharakteristik; sym. strahlende Varianten: präzise durch hochwertige Linsensystem; asym. strahlende Varianten: hochwertiger Reflektor mit mikrofacettierter, aluminiumbedampfter Oberfläche; COB (Chip on Board) Technologie für höchste Effizienz (ADJUSTABLE); keine Mehrfachschatten; effiziente LEDs mit sehr guter Farbwiedergabe; externer Konverter für Deckeneinwurf, für Weiterverdrahtung geeignet

Quickinfo

2700 K, 3000 K, 4000 K
CRI ≥ 90, 2 SDCM
SASSO 60 up to 104 lm/W
SASSO 100 up to 117 lm/W
L80 @ 50 000 h
non DIM, DALI-2

Types

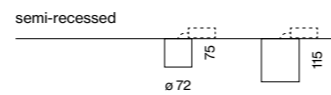

Housing colours



Inset colours



Light distributions

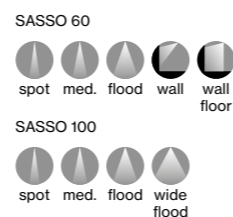

wallwasher and
ww floor inset



glare control
(UGR ≤ 16)



easy mounting;
no visible screws

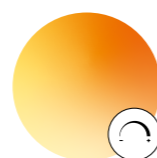

CWD
1800–3000 K



CRI ≥ 95
2 SDCM

Order options

COLOUR TEMPERATURE	
2700 K	4
3000 K	5
4000 K	6

HOUSING COLOUR	
○ traffic white RAL 9016	7
● jet black RAL 9005	1

INSET COLOUR	
○ traffic white RAL 9016 (UGR ≤ 22)	7
● matt silver (UGR ≤ 19)	4
● jet black RAL 9005 (UGR ≤ 16)	1
● gold dust RAL 260-M (UGR ≤ 19)	9

BEAM ANGLE SASSO 60	
spot 15°	S
medium 21°	M
flood 42°	F

BEAM ANGLE SASSO 100	
spot 19°	S
medium 34°	M
flood 45°	F
wide flood 65°	W

Options on request

COLOUR RENDERING INDEX
CRI ≥ 95, 2 SDCM

COLOUR TEMPERATURE

CWD 1800–3000 K
not for WW & WWF version

CONTROL

Casambi

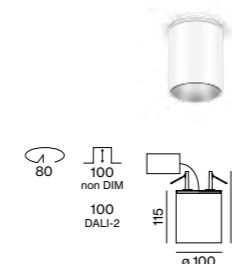
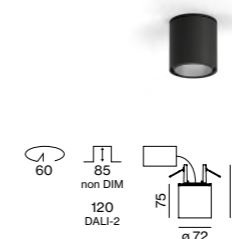

SASSO 60 round semi-recessed



ADJUSTABLE

INSET POWER	LUMINOUS FLUX	ORDER CODE
10.7 W 36 Vf 300 mA	1040 lm	0 4 8 - 3 1 0 1 :: 1 ■ ■ ▲



WALLWASHER

INSET POWER	LUMINOUS FLUX	ORDER CODE
8.2 W 27 Vf 300 mA	635 lm	0 4 8 - 3 7 0 1 :: 1 ■ ■ ▲

WALLWASHER/FLOOR

INSET POWER	LUMINOUS FLUX	ORDER CODE
8.2 W 27 Vf 300 mA	633 lm	0 4 8 - 3 7 0 1 :: 1 ■ ■ ▲

SASSO 100 round semi-recessed



ADJUSTABLE

INSET POWER	LUMINOUS FLUX	ORDER CODE
17.2 W 36 Vf 500 mA	1850 lm*	0 4 8 - 3 4 0 1 :: 1 ■ ■ ▲

*reflector white flood

Electrical accessories

POWER SUPPLY 220-240 V AC, 50-60 Hz, PC II

TYPE	EFFICIENCY	L-WH (mm)	ORDER CODE
300 mA non DIM	η 85 %	85-40-22	0 0 2 - 9 0 7 7 1
300 mA DALI-2	η 88 %	143-43-30	0 0 2 - 9 0 7 6 2
500 mA non DIM	η 88 %	143-43-30	0 0 2 - 9 0 7 7 7
500 mA DALI-2	η 88 %	143-43-30	0 0 2 - 9 0 7 7 9

THROUGH WIRING CONNECTION BOX for SASSO 100

TYPE	L-WH (mm)	ORDER CODE
non DIM cable ø 4–12 mm	105-58-30	0 0 5 - 2 5 3 1 1 1 0
DALI cable ø 4–12 mm	105-58-30	0 0 5 - 2 5 5 1 1 1 0

DIN RAIL COMPONENTS

TYPE	WHD (mm)	ORDER CODE
POWER SUPPLY 220-240 V AC 96 W 48V DC constant voltage	90-90-60	0 0 5 - 6 5 2 0 2 1 0
LED DRIVER DALI-2 DT6 1–2 addr. 200–1050 mA settable const. current 2 × 42 W 48 V DC U _{OUT} 10–40 V	36-88-59	0 0 5 - 6 1 2 1 0 3 0

for more details and components see page 981

INSET POWER is the current consumption excluding any ballast
LUMINOUS FLUX value calculated for 3000 K, CRI ≥ 90, colour white, flood 2700 K -5%, 4000 K +5%

← back



SASSO 60/100 round

ceiling

EN Cylindrical ceiling mounted spotlight made of aluminium, available in 2 sizes; light inset lacquered; housing powder coated; luminaire housing can be attached to mounting plate without tools by interlock; adj. sym. or asym. radiation characteristic; variants with sym. radiation characteristic: precise due to high quality lens system; variants with asym. radiation characteristic: high-quality reflector with micro-faceted, aluminum-vaporised surface; COB (Chip on Board) technology for maximum efficiency (ADJUSTABLE); no multiple shadows; efficient LEDs with very good colour rendering; converter integrated into spotlight head

DE Zylindrischer Deckenanbaustrahler aus Aluminium in 2 Größen; Lichteinsatz lackiert; Gehäuse pulverbeschichtet; Leuchtenkörper mittels Verriegelung werkzeuglos auf Montageplatte aufsetzbar; einstellbar sym. oder asym. Abstrahlcharakteristik; sym. strahlende Varianten: präzise durch hochwertige Linsensystem; asym. strahlende Varianten: hochwertiger Reflektor mit mikrofacettierter, aluminiumbedampfter Oberfläche; COB (Chip on Board) Technologie für höchste Effizienz (ADJUSTABLE); keine Mehrfachschatten; effiziente LEDs mit sehr guter Farbwiedergabe; Konverter im Strahlerkopf integriert

Quickinfo

2700 K, 3000 K, 4000 K
CRI ≥ 90, 2 SDCM
SASSO 60 up to 81lm/W
SASSO 100 up to 100lm/W
L80 @ 50 000 h
non DIM, DALI-2

Types

ceiling

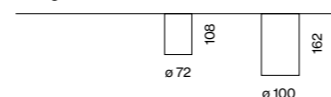

Housing colours



Inset colours



Light distributions

SASSO 60



SASSO 100



wallwasher and
ww floor inset



glare control
(UGR ≤ 16)



easy mounting;
no visible screws

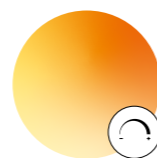

CWD
1800–3000 K



CRI ≥ 95
2 SDCM

Order options

COLOUR TEMPERATURE	
2700 K	4
3000 K	5
4000 K	6

CONTROL	
non DIM	1
DALI-2	3

HOUSING COLOUR	
○ traffic white RAL 9016	7
● jet black RAL 9005	1

INSET COLOUR	
○ traffic white RAL 9016 (UGR ≤ 22)	7
● matt silver (UGR ≤ 19)	4
● jet black RAL 9005 (UGR ≤ 16)	1
● gold dust RAL 260-M (UGR ≤ 19)	9

BEAM ANGLE	
SASSO 60	
spot 15°	S
medium 21°	M
flood 42°	F

BEAM ANGLE	
SASSO 100	
spot 19°	S
medium 34°	M
flood 45°	F
wide flood 65°	W

Options on request

COLOUR RENDERING INDEX
CRI ≥ 95, 2 SDCM

COLOUR TEMPERATURE
CWD 1800–3000 K
not for WW & WWF version

LUMINOUS FLUX value calculated for
CRI ≥ 90, colour white, reflector flood



SASSO 60 round ceiling



ADJUSTABLE

SYSTEM POWER	COLOUR TEMP.	LUMINOUS FLUX	ORDER CODE
11.6 W	2700 K	808 lm	0 4 8 - 3 1 1 0 :: ▨ ▩ ▪ ▫ ▬
	3000 K	874 lm	
	4000 K	939 lm	



WALLWASHER

SYSTEM POWER	COLOUR TEMP.	LUMINOUS FLUX	ORDER CODE
11.4 W	2700 K	635 lm	0 4 8 - 3 7 1 0 :: ▨ ▩ ▪ ▫ ▬ A
	3000 K	635 lm	
	4000 K	744 lm	

WALLWASHER/FLOOR

SYSTEM POWER	COLOUR TEMP.	LUMINOUS FLUX	ORDER CODE
11.4 W	2700 K	633 lm	0 4 8 - 3 7 1 0 :: ▨ ▩ ▪ ▫ ▬ W
	3000 K	633 lm	
	4000 K	746 lm	

SASSO 100 round ceiling



ADJUSTABLE

SYSTEM POWER	COLOUR TEMP.	LUMINOUS FLUX	ORDER CODE
20.2 W	2700 K	1650 lm	0 4 8 - 3 4 1 0 :: ▨ ▩ ▪ ▫ ▬ A
	3000 K	1790 lm	
	4000 K	1930 lm	

Oppenländer Rechtsanwälte
Stuttgart, DE – by Ippolito Fleitz
Group GmbH



WIKUS Sägenfabrik Spangenberg, DE –
by Bieling Architekten AG with lighting
design by Peter Andres Unabhängige
Lichtplanung und -beratung GbR



Private Residence
Copenhagen, DK –
by COBE Architects with
lighting design by anker & co



← back



SASSO 60/100 square

semi-recessed

EN Square semi-recessed spotlight made of aluminium, available in 2 sizes; light inset lacquered; housing powder coated; luminaire housing can be attached to mounting plate without tools by interlock; choice of adjustable / fixed symmetric or asymmetric radiation characteristic; variants with sym. radiation characteristic: precise due to high quality lens system; variants with asym. radiation characteristic: high-quality reflector with micro-faceted, aluminum-vaporised surface; COB (Chip on Board) technology for maximum efficiency (ADJUSTABLE and DOWNLIGHT); no multiple shadows; efficient LEDs with very good colour rendering; external converter for ceiling insertion, for through-wiring suitable

DE Quadratischer Halbeinbaustrahler aus Aluminium in 2 Größen; Lichteinsatz lackiert; Gehäuse pulverbeschichtet; Leuchtenkörper mittels Verriegelung werkzeuglos auf Montageplatte aufsetzbar; wahlweise einstellbar / starr symmetrische oder asymmetrische Abstrahlcharakteristik; sym. strahlende Varianten: präzise durch hochwertige Linsenoptik; asym. strahlende Varianten: hochwertiger Reflektor mit mikrofacetierter, aluminiumbedampfter Oberfläche; COB (Chip on Board) Technologie für höchste Effizienz (ADJUSTABLE und DOWNLIGHT); keine Mehrfachschatten; effiziente LEDs mit sehr guter Farbwiedergabe; externer Konverter für Deckeneinwurf, für Weiterverdrahtung geeignet

Quickinfo

2700 K, 3000 K, 4000 K
CRI ≥ 90, 2 SDCM
SASSO 60 up to 86 lm/W
SASSO 100 up to 119 lm/W
L80 @ 50 000 h
non DIM, DALI-2

Types

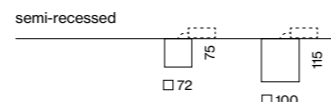

Housing colours



Inset colours



Light distributions

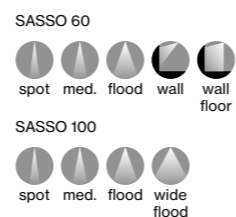

wallwasher and
ww floor inset



glare control
(UGR ≤ 16)



easy mounting;
no visible screws

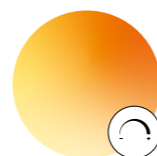

CWD
1800–3000 K



CRI ≥ 95
2 SDCM

Order options

COLOUR TEMPERATURE	
2700 K	4
3000 K	5
4000 K	6

HOUSING COLOUR	
○ traffic white RAL 9016	7
● jet black RAL 9005	1

INSET COLOUR	
○ traffic white RAL 9016 (UGR ≤ 22)	7
● matt silver (UGR ≤ 19)	4
● jet black RAL 9005 (UGR ≤ 16)	1
● gold dust RAL 260-M (UGR ≤ 19)	9

BEAM ANGLE SASSO 60	
spot 15°	S
medium 21°	M
flood 42°	F

BEAM ANGLE SASSO 100	
spot 19°	S
medium 34°	M
flood 45°	F
wide flood 65°	W

Options on request

COLOUR RENDERING INDEX
CRI ≥ 95, 2 SDCM

COLOUR TEMPERATURE
CWD 1800–3000 K

not for WW & WWF version

CONTROL

Casambi

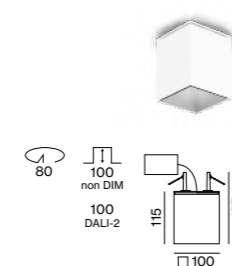
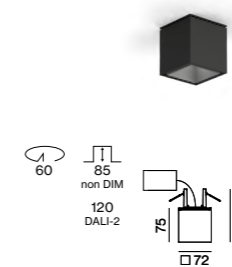

SASSO 60 square semi-recessed



DOWNLIGHT	INSET POWER	LUMINOUS FLUX	ORDER CODE
	10.7 W 36 Vf 300 mA	1100 lm	0 4 8 - 3 0 0 1 :: 1 ■ ■ ▲



WALLWASHER	INSET POWER	LUMINOUS FLUX	ORDER CODE
	8.2 W 27 Vf 300 mA	635 lm	0 4 8 - 3 6 0 1 :: 1 ■ ■ ▲

WALLWASHER/FLOOR

INSET POWER	LUMINOUS FLUX	ORDER CODE
8.2 W 27 Vf 300 mA	633 lm	0 4 8 - 3 6 0 1 :: 1 ■ ■ W

SASSO 100 square semi-recessed



ADJUSTABLE	INSET POWER	LUMINOUS FLUX	ORDER CODE
	17.2 W 36 Vf 500 mA	1890 lm*	0 4 8 - 3 3 0 1 :: 1 ■ ■ ▲

*reflector wide flood

Electrical accessories

POWER SUPPLY 220-240 V AC 50-60 Hz, PC II

TYPE	EFFICIENCY	L-W-H (mm)	ORDER CODE
300 mA non DIM	η 85 %	85-40-22	0 0 2 - 9 0 7 7 1
300 mA DALI-2	η 88 %	143-43-30	0 0 2 - 9 0 7 6 2
500 mA non DIM	η 88 %	143-43-30	0 0 2 - 9 0 7 7 7
500 mA DALI-2	η 88 %	143-43-30	0 0 2 - 9 0 7 7 9

THROUGH WIRING CONNECTION BOX for SASSO 100

TYPE	L-W-H (mm)	ORDER CODE
non DIM cable ø 4–12 mm	105-58-30	0 0 5 - 2 5 3 1 1 1 0
DALI cable ø 4–12 mm	105-58-30	0 0 5 - 2 5 5 1 1 1 0

DIN RAIL COMPONENTS

TYPE	W-H-D (mm)	ORDER CODE
POWER SUPPLY 220-240 V AC 96 W 48V DC constant voltage	90-90-60	0 0 5 - 6 5 2 0 2 1 0
LED DRIVER DALI-2 DT6 1–2 addr. 200–1050 mA settable const. current 2 × 42 W 48 V DC U _{OUT} 10–40 V	36-88-59	0 0 5 - 6 1 2 1 0 3 0

for more details and components see page 981

INSET POWER is the current consumption excluding any ballast
LUMINOUS FLUX value calculated for 3000 K, CRI ≥ 90, colour white, flood 2700 K -5%, 4000 K +5%

Relesys Office Copenhagen, DK –
by Lobo-Lab Architects
with lighting design by anker & co





SASSO 60/100 round

suspended

EN Cylindrical spotlight made of aluminium, available in 2 sizes; light inset lacquered; housing powder coated; pendant fitting with cable suspension; incl. feed (black or white); can be individually shortened; precise radiation characteristic due to high quality lens system; COB (Chip on Board) technology for maximum efficiency; no multiple shadows; efficient LEDs with very good colour rendering; canopy for through wiring; converter included in canopy

DE Zylindrischer Strahler aus Aluminium in 2 Größen; Lichteinsatz lackiert; Gehäuse pulverbeschichtet; abgependelt mit Seilabhangung; inkl. Einspeiseleitung (schwarz oder wei); beliebig kurzbar; prazise Abstrahlcharakteristik durch hochwertige Linsenoptik; COB (Chip on Board) Technologie fur hochste Effizienz; keine Mehrfachschatten; effiziente LEDs mit sehr guter Farbwiedergabe; Baldachin fur Weiterverdrahtung; Konverter im Baldachin enthalten

Quickinfo

2700 K, 3000 K, 4000 K
CRI ≥ 90, 2 SDCM
SASSO 60 up to 83 lm/W
SASSO 100 up to 98 lm/W
L80 @ 50 000 h
non DIM, DALI-2

Types

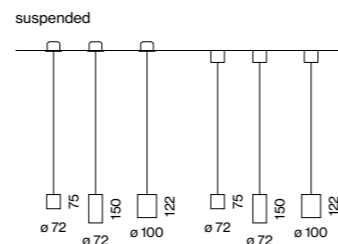

Housing colours



Inset colours



Light distributions

SASSO 60



SASSO 100



glare control
(UGR ≤ 16)



easy mounting;
no visible screws



CRI ≥ 95
2 SDCM

Order options

HOUSING HEIGHT	L
75 mm	2
150 mm	7

COLOUR TEMPERATURE	••
2700 K	4
3000 K	5
4000 K	6

CONTROL	◆
non DIM	1
DALI-2	3

HOUSING COLOUR	■
○ traffic white RAL 9016	7
● jet black RAL 9005	1

INSET COLOUR	■
○ traffic white RAL 9016 (UGR ≤ 22)	7
● matt silver (UGR ≤ 19)	4
● jet black RAL 9005 (UGR ≤ 16)	1
● gold dust RAL 260-M (UGR ≤ 19)	9

BEAM ANGLE	▲
SASSO 60	
spot 15°	S
medium 21°	M
flood 42°	F

BEAM ANGLE	▲
SASSO 100	
spot 19°	S
medium 34°	M
flood 45°	F
wide flood 65°	W

Options on request

COLOUR RENDERING INDEX
CRI ≥ 95, 2 SDCM

MOUNTING

recessed canopy

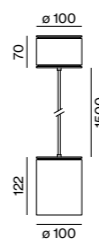
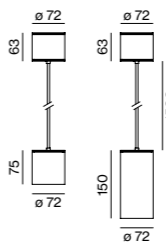

SASSO 60 round suspended



DOWNLIGHT

SYSTEM POWER	COLOUR TEMP.	LUMINOUS FLUX	ORDER CODE
11.6 W	2700 K	833 lm	0 4 8 - 3 1 L 0 :: ◆ ■ ▲
	3000 K	901 lm	
	4000 K	968 lm	

SASSO 100 round suspended



DOWNLIGHT

SYSTEM POWER	COLOUR TEMP.	LUMINOUS FLUX	ORDER CODE
20.2 W	2700 K	1650 lm	0 4 8 - 3 4 2 0 :: ◆ ■ ▲
	3000 K	1790 lm	
	4000 K	1920 lm	

LUMINOUS FLUX value calculated for
CRI ≥ 90, colour white, reflector wide flood

James Good Coiffeur Lounge
Flums, CH – by Daniel Huber Architektur GmbH



[← back](#)

SASSO 60 base

ceiling

EN Cylindrical or square spotlight made of aluminium; light inset lacquered; housing powder coated; light inset rotatable and tiltable (cylindrical versions); choice of single lamp or double lamps (cylindrical versions); surface mounted housing in aluminium incl. converter; mounting plate with pre-assembled converter unit can be pre-mounted; luminaire housing can be attached without tools by interlock; precise radiation characteristic due to high quality lens system; COB (Chip on Board) technology for maximum efficiency; no multiple shadows; efficient LEDs with very good colour rendering; luminaire for through wiring

DE Zylindrischer bzw. quadratischer Strahler aus Aluminium; Lichteinsatz lackiert; Gehäuse pulverbeschichtet; Lichteinsatz dreh- und schwenkbar (zylindr. Varianten); wahlweise einflammig oder zweiflammig (zylindr. Varianten); Anbaugehäuse aus Aluminium inkl. Konverter; Montageplatte mit vormontierter Konvertereinheit vorab montierbar; Leuchtenkörper mittels Verriegelung werkzeuglos aufsetzbar; präzise Abstrahlcharakteristik durch hochwertige Linsenoptik; COB (Chip on Board) Technologie für höchste Effizienz; keine Mehrfachschatten; effiziente LEDs mit sehr guter Farbwiedergabe; Leuchte für Weiterverdrahtung

Quickinfo

2700 K, 3000 K, 4000 K
 CRI ≥ 90, 2 SDCM
 SASSO round up to 90 lm/W
 SASSO square up to 86 lm/W
 L80 @ 50 000 h
 non DIM, DALI-2

Types

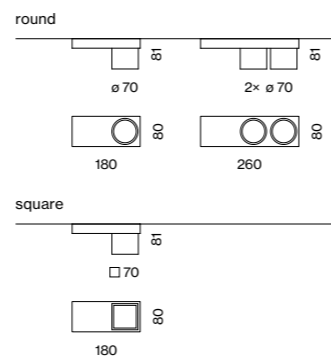

Housing colours



Inset colours



Light distributions



Order options

COLOUR TEMPERATURE	
2700 K	4
3000 K	5
4000 K	6

CONTROL	
non DIM	1
DALI-2	3

HOUSING COLOUR	
○ traffic white RAL 9016	7
● jet black RAL 9005	1

INSET COLOUR	
○ traffic white RAL 9016 (UGR ≤ 22)	7
● matt silver (UGR ≤ 19)	4
● jet black RAL 9005 (UGR ≤ 16)	1
● gold dust RAL 260-M (UGR ≤ 19)	9

BEAM ANGLE	
spot 15°	S
medium 21°	M
flood 42°	F

Options on request

COLOUR RENDERING INDEX	
CRI ≥ 95, 2 SDCM	

LIGHT DISTRIBUTION	
wallwasher	
wallwasher / floor	

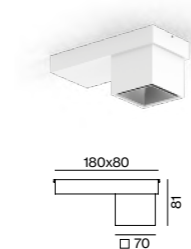
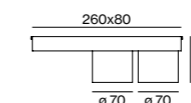
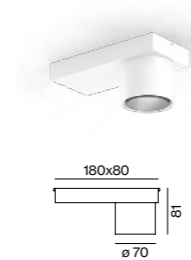

SASSO 60 base round

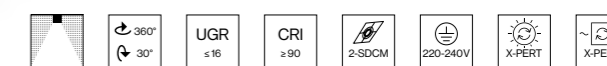

ADJUSTABLE 1 LAMP

SYSTEM POWER	COLOUR TEMP.	LUMINOUS FLUX	ORDER CODE
11.7 W	2700 K	816 lm	0 4 8 - 3 1 3 0 :: ◆ ▣ ▣ ▲
	3000 K	882 lm	
	4000 K	948 lm	

ADJUSTABLE 2 LAMPS

SYSTEM POWER	COLOUR TEMP.	LUMINOUS FLUX	ORDER CODE
21.6 W	2700 K	2 × 873 lm	0 4 8 - 3 1 4 0 :: ◆ ▣ ▣ ▲
	3000 K	2 × 921 lm	
	4000 K	2 × 977 lm	

SASSO 60 base square



DOWNLIGHT 1 LAMP

SYSTEM POWER	COLOUR TEMP.	LUMINOUS FLUX	ORDER CODE
11.7 W	2700 K	865 lm	0 4 8 - 3 0 3 0 :: ◆ ▣ ▣ ▲
	3000 K	936 lm	
	4000 K	1010 lm	

LUMINOUS FLUX value calculated for CRI ≥ 90, colour white, reflector flood



The Raum Bolzano, IT –
by bergundtal gmbh.



Quickinfo

2700 K, 3000 K, 4000 K
 CRI ≥ 90, 2 SDCM
 SASSO 60 up to 69 lm/W
 SASSO 100 up to 61 lm/W
 L80 @ 50 000 h
 non DIM, DALI-2

Types**Housing colours****Inset colours****Light distributions****SASSO 60/100 round**

wall

EN Cylindrical wall surface mounted luminaire made of aluminium, available in 2 sizes; light inset lacquered; housing powder coated; optionally symmetric direct or direct / indirect light distribution; homogeneous wall or ceiling illumination through uniform light distribution; precise radiation characteristic due to high quality lens system; installation of variant DIRECT optionally for floor or ceiling illumination; COB (Chip on Board) technology for maximum efficiency; no multiple shadows; efficient LEDs with very good colour rendering

DE Zylindrische Wandanbauleuchte aus Aluminium in 2 Größen; Lichteinsatz lackiert; Gehäuse pulverbeschichtet; wahlweise symmetrisch direkte oder direkt/indirekte Abstrahlcharakteristik; homogene Wand- bzw. Deckenaufhellung durch gleichmäßige Lichtverteilung; präzise Abstrahlcharakteristik durch hochwertige Linsenoptik; Montage Variante DIRECT wahlweise zur Boden- oder Deckenaufhellung; COB (Chip on Board) Technologie für höchste Effizienz; keine Mehrfachschatten; effiziente LEDs mit sehr guter Farbwiedergabe



direct and direct / indirect illumination



high quality lens



easy mounting

CRI ≥ 95
2 SDCM**Order options**

COLOUR TEMPERATURE	
2700 K	4
3000 K	5
4000 K	6

CONTROL	
non DIM	1
DALI-2	3

HOUSING COLOUR	
○ traffic white RAL 9016	7
● jet black RAL 9005	1

INSET COLOUR	
○ traffic white RAL 9016 (UGR ≤ 22)	7
● matt silver (UGR ≤ 19)	4
● jet black RAL 9005 (UGR ≤ 16)	1
● gold dust RAL 260-M (UGR ≤ 19)	9

BEAM ANGLE	
opal lens	

Options on request

COLOUR RENDERING INDEX	
CRI ≥ 95, 2 SDCM	

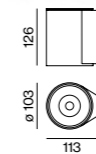
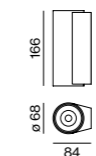
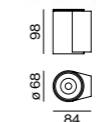
**SASSO 60 round wall****DIRECT**

SYSTEM POWER	COLOUR TEMP.	LUMINOUS FLUX	ORDER CODE
11.7 W	2700 K	647 lm	0 4 8 - 3 1 5 0 :: ◆ ▣ ▣ ○
	3000 K	683 lm	
	4000 K	724 lm	

DIRECT / INDIRECT

SYSTEM POWER	COLOUR TEMP.	LUMINOUS FLUX	ORDER CODE
20.4 W	2700 K	2 × 643 lm	0 4 8 - 3 1 6 0 :: ◆ ▣ ▣ ○
	3000 K	2 × 678 lm	
	4000 K	2 × 720 lm	

SASSO 100 round wall**DIRECT**

SYSTEM POWER	COLOUR TEMP.	LUMINOUS FLUX	ORDER CODE
20.4 W	2700 K	1130 lm	0 4 8 - 3 4 5 0 :: ◆ ▣ ▣ ○
	3000 K	1180 lm	
	4000 K	1240 lm	

DIRECT / INDIRECT

SYSTEM POWER	COLOUR TEMP.	LUMINOUS FLUX	ORDER CODE
41 W	2700 K	2 × 1130 lm	0 4 8 - 3 4 6 0 :: ◆ ▣ ▣ ○
	3000 K	2 × 1180 lm	
	4000 K	2 × 1240 lm	

LUMINOUS FLUX value calculated for CRI ≥ 90, colour white, lens opal

MAM Competence Center
Großhöflein, AT –
by INNOCAD Architektur ZT



The exquisite choice



SASSO PRO

EN The high-quality reflector ensures a particularly even light pattern and professional glare control. Its exclusive design and high-quality appearance make SASSO the ideal spotlight on the shop floor. The spotlights can be rotated through 360° and can also be swivelled by up to 35° around the horizontal central axis. This means light can be flexibly redirected even after installation, depending on the shop concept. Thanks to its replaceable light insets, the spotlight can be installed quickly and without any tools using a ball-catch system. SASSO is available in various sizes, colours, and with optical accessories. For the light colours, you can choose between 2700K, 3000K, 4000K, or the dynamic gradient Colour Warm Dimming and Tunable White versions.

DE Der hochwertige Reflektor sorgt für ein besonders gleichmäßiges Lichtbild und professionelle Entblendung. Sein exklusives Design und hochwertiges Erscheinungsbild machen SASSO zum idealen Strahler im Shopbereich. Die Spots können um 360° gedreht werden und sind zusätzlich um bis zu 35° um die horizontale Mittelachse schwenkbar. Dadurch kann Licht auch nach der Installation flexibel gelenkt werden – je nach Shop-Konzept. Durch seine tauschbaren Lichteinsätze kann der Spot schnell und werkzeuglos mittels Kugelschnappsystem eingebaut werden. SASSO ist in verschiedenen Größen, Farben und mit optischen Zubehör erhältlich. Bei den Lichtfarben haben Sie die Auswahl zwischen 2700K, 3000K, 4000K oder den dynamischen Verlaufsvarianten Colour Warm Dimming und Tunable White.

Types



80

100

Mountings

trimless
recessedwith trim
recessed

Light distribution

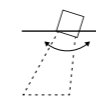

spotlight



Precise light adjustment

EN In addition to the 360° rotatability of all SASSO Round 80/100 variants, the adjustable version can be swivelled up to 35° around the horizontal central axis. This enables light to be directed precisely where it is needed.

DE Zusätzlich zur 360°-Drehbarkeit aller SASSO Round 80/100 Varianten kann die Adjustable-Ausführung bis zu 35° um die horizontale Mittelachse geschwenkt werden. Das ermöglicht eine noch exaktere Lenkung des Lichts dorthin, wo es gebraucht wird.



Optical accessories

EN Use a wide range of optical accessories to adapt spotlights for special applications. The optical light accessories can be attached or removed in one easy step and provide glare-free light at any point.

DE Nutzen Sie vielfältiges optisches Zubehör, um Strahler für spezielle Anwendungsbereiche anzupassen. Die optischen Licht-Accessoires lassen sich mit nur einem Handgriff aufsetzen oder abnehmen und sorgen an jeder Stelle für blendfreies Licht.

CWD – Colour Warm Dimming

EN Warm light quality with reduced illuminance. Colour Warm Dimming reduces the light intensity while continuously changing the colour temperature between 3000 K and 1800 K. The function supports, for example, the change between cosy restaurant lighting during the day and a relaxing lighting mood in the evening.

DE Warme Lichtqualität bei reduzierter Beleuchtungsstärke: Colour Warm Dimming senkt zugleich die Lichtintensität und wechselt die Farbtemperatur stufenlos zwischen 3000 K und 1800 K. Die Funktion unterstützt etwa den Wechsel zwischen gemütlicher Restaurant-Beleuchtung tagsüber und einer entspannenden Lichtstimmung am Abend.

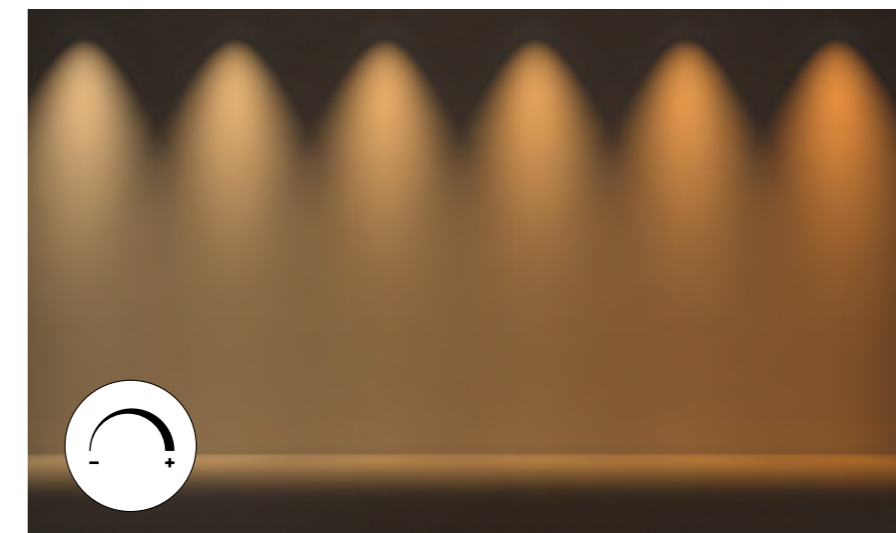

Reflector inset

EN The high-quality reflector with spherical faceted optics ensures a uniform light pattern with significant glare control. SASSO is an attractive lighting solution in the premium shop area, thanks to its high-quality appearance.

DE Der hochwertige Reflektor mit sphärischer Facettenoptik sorgt für ein gleichmäßiges Lichtbild bei zusätzlich guter Entblendung. Dank seines hochwertigen Erscheinungsbildes ist SASSO auch eine attraktive Lichtlösung im Premium-Shopbereich.

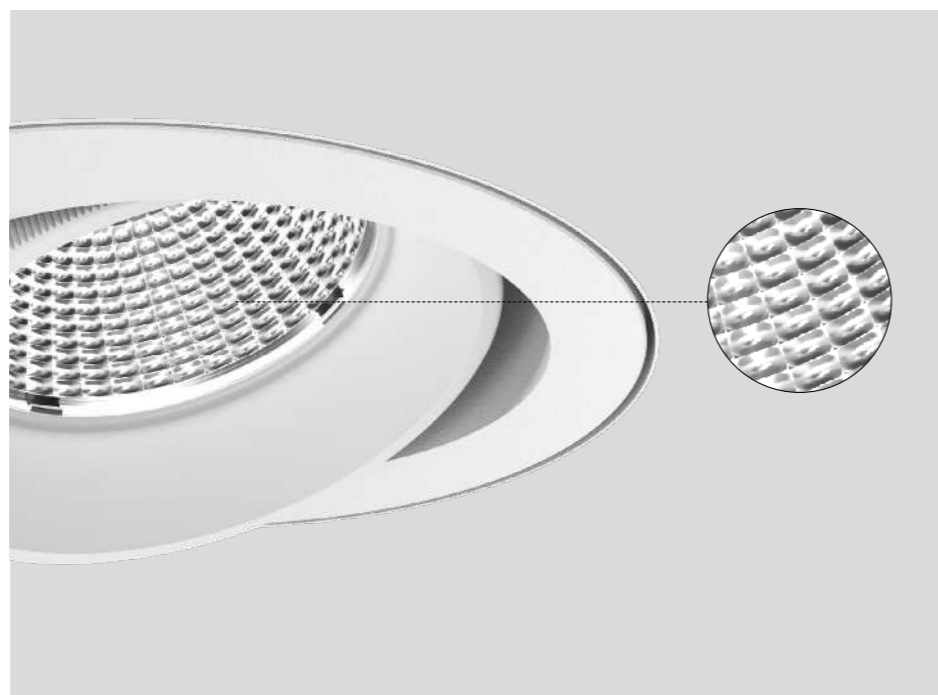

Ball catch system

EN SASSO spots are easy to replace. The assembly is quick and entirely without tools, thanks to a ball catch system. The lighting thus always adapts flexibly to new requirements and circumstances.

DE SASSO Spots sind einfach austauschbar: Die Montage erfolgt schnell und völlig ohne Werkzeug durch ein Kugelschnappsystem. So passt sich die Beleuchtung stets flexibel den neuen Anforderungen und Gegebenheiten an.



TW – Tunable White

EN Changes in the colour of light have a substantial effect on our mood. Tunable White allows the colour temperature to be continuously adjusted from 2700 K (warm light) to 6500 K (cool light) to dynamically adapt the lighting to the time of day or ambient brightness.

DE Veränderungen in der Lichtfarbe haben eine starke Wirkung auf unsere Stimmung. Tunable White ermöglicht die stufenlose Verschiebung der Farbtemperatur von 2700 K (warmes Licht) bis 6500 K (kühles Licht), um die Beleuchtung dynamisch an Uhrzeit oder Umgebungslicht anzupassen.

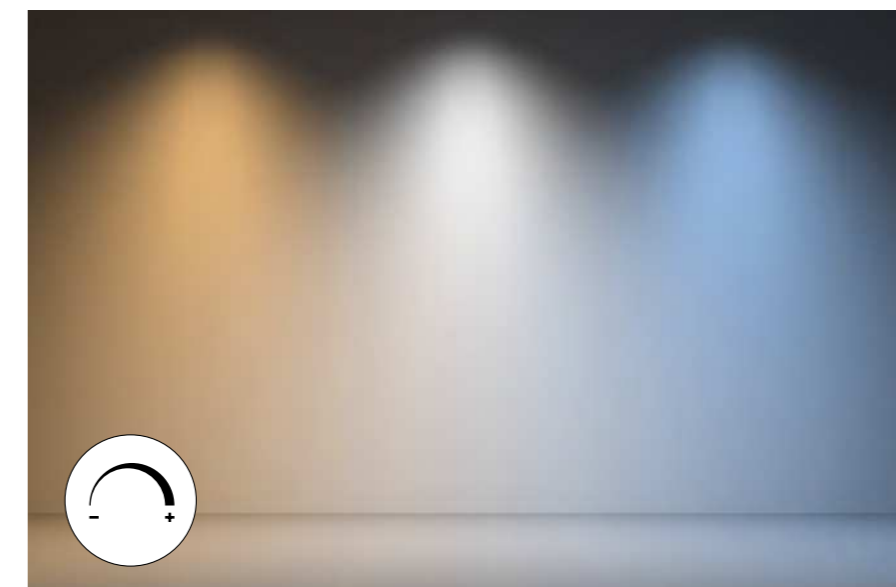

← back

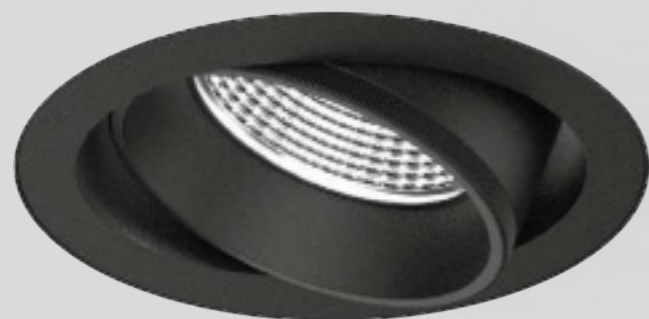

SASSO PRO 80 flush/offset

recessed

EN Round recessed spotlight in die-cast aluminium; installation without tools in mounting set with ball catch system; surface powder coated; installation possible in different housings; light inset rotatable and tiltable; optionally with recessed lighting level; optical attachments as accessories; with optional high-quality lens system with precise radiation characteristic; and high-quality reflector with spherical facet effect design, precise radiation characteristics with different beam angles; installed and exchanged without tools; COB (Chip on Board) technology or high power LEDs for maximum efficiency; no multiple shadows; efficient LEDs with very good colour rendering

DE Runder Einbaustrahler aus Aluminiumdruckguss; werkzeuglose Montage im Montageset durch Kugelschnappsystem; Oberfläche pulverbeschichtet; Einbau in unterschiedlichen Gehäusen möglich; Licht-einsatz dreh- und schwenkbar; optional mit zurückversetzter Leuchtenebene; optische Aufsätze als Zubehör; wahlweise mit hochwertiger Linsenoptik mit präziser Abstrahlcharakteristik; bzw. hochwertiger Reflektor mit sphärischer Facettenoptik, präzise Abstrahlcharakteristik mit verschiedenen Ausstrahlwinkeln; werkzeuglos einsetz- bzw. austauschbar; mit COB (Chip on Board) Technologie bzw. High-Power-LEDs für höchste Effizienz; keine Mehrfachschatten; effiziente LEDs mit sehr guter Farbwiedergabe

Quickinfo

2700 K, 3000 K, 4000 K, CWD
CRI ≥ 90, 3 SDCM
up to 93 lm/W
L90 @ 50 000 h
non DIM, DALI-2

Types

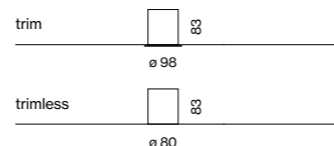

Colours



Light distributions



Order options

COLOUR TEMPERATURE	
2700 K	4
3000 K	5
4000 K	6
CWD 1800–2700 K	

CONTROL	
non DIM	1
DALI-2	3

MATERIAL COLOUR	
○ traffic white RAL 9016	7
● jet black RAL 9005	8

LENS	
super spot 6°	

BEAM ANGLE	
medium 27°	M
flood 37°	F

Options on request

MOUNTING SET	
acoustic soft ceilings	



DiiA® standards
251, 252, 253

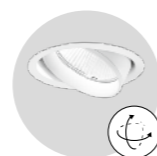

rotatable 360°
tiltable 35°

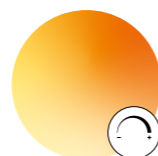

CWD
1800–2700 K

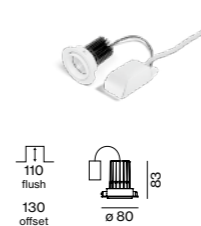

SASSO PRO 80



SPOTLIGHT ADJUSTABLE

SYSTEM POWER	COLOUR TEMP.	LUMINOUS FLUX	ORDER CODE
7.7 W	2700 K	353 lm	048-2310::1 V
super spot 6°	3000 K	379 lm	048-2310::1 V ▲
	4000 K	408 lm	
8.3 W	2700 K	728 lm	048-2312::2 V ▲
	3000 K	765 lm	
	4000 K	773 lm	
12.2 W	2700 K	1020 lm	048-2312::2 V ▲
	3000 K	1060 lm	
	4000 K	1130 lm	

SYSTEM POWER	LUMINOUS FLUX	ORDER CODE
6.5 W CWD 1800–2700 K	378 lm	048-2310E3 V M

Mounting accessories

TRIMLESS MOUNTING SET

for installation in plasterboard ceilings 12.5/15/25 mm

TYPE	ORDER CODE
flush	052-1921327
offset 17 mm	052-193132 V

ROUND MOUNTING SET WITH TRIM

for intermediate ceilings 5–25 mm

TYPE	ORDER CODE
flush	052-192232 V
offset 17 mm	052-193232 V

SQUARE MOUNTING SET WITH TRIM

for intermediate ceilings 5–25 mm

TYPE	ORDER CODE
flush	052-194231 V
offset 17 mm	052-195231 V

CONCRETE MOUNTING HOUSING

TYPE	L-W-H (mm)	ORDER CODE
exposed concrete ceilings*	229-227-160	060-00080
primed concrete ceilings**	ø240-400-130	052-1914320

*only for flush mounting **order mounting set separately

Optical accessories

TYPE	ORDER CODE
honeycomb louver	048-209131 V
linear prismatic lens	048-209231 V
snoot	048-209111 V
snoot with honeycomb louver	048-209121 V

use only 1 optical accessory

Electrical accessories

THROUGH WIRING CONNECTION BOX

TYPE	L-W-H (mm)	ORDER CODE
non DIM cable ø 4–12 mm	105-58-30	005-2531110
DALI cable ø 4–12 mm	105-58-30	005-2551110

LUMINOUS FLUX value calculated for CRI ≥ 90, colour white, reflector flood, flush mounting

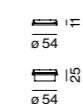
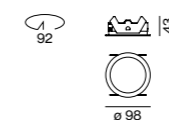
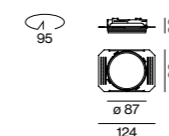

← back

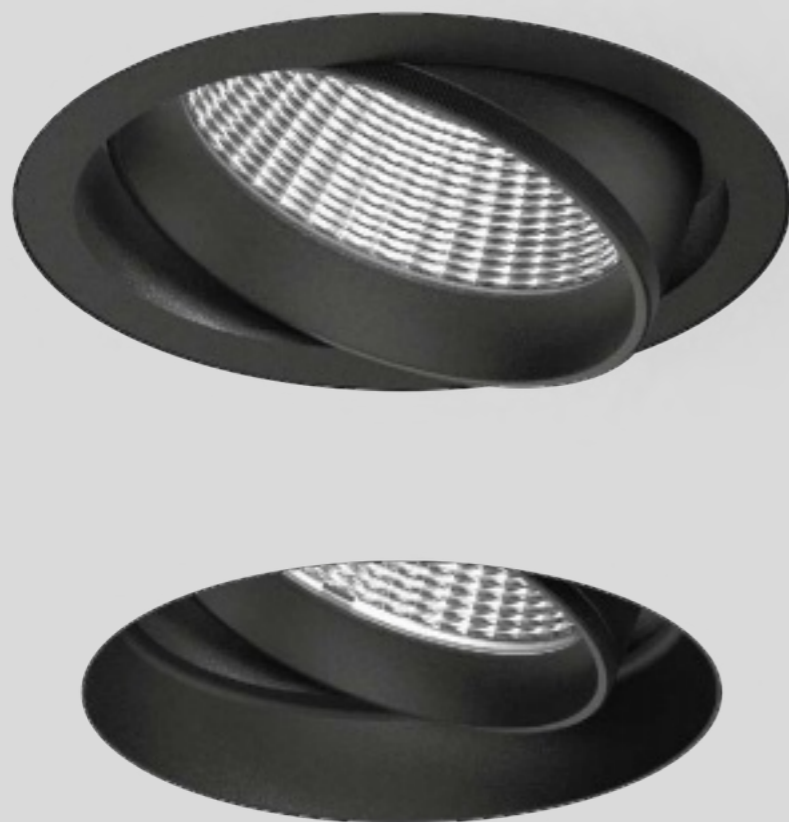

SASSO PRO 100 flush/offset

recessed

EN Round recessed spotlight in die-cast aluminium; installation without tools in mounting set with ball catch system; surface powder coated; installation possible in different housings; light inset rotatable and tiltable; optionally with recessed lighting level; optical attachments as accessories; high-quality reflector with spherical facet effect design, precise radiation characteristics with different beam angles; installed and exchanged without tools; COB (Chip on Board) technology for maximum efficiency; no multiple shadows; efficient LEDs with very good colour rendering

DE Runder Einbaustrahler aus Aluminiumdruckguss; werkzeuglose Montage im Montageset durch Kugelschnappsystem; Oberfläche pulverbeschichtet; Einbau in unterschiedlichen Gehäusen möglich; Licht-einsatz dreh- und schwenkbar; optional mit zurückversetzter Leuchtenebene; optische Aufsätze als Zubehör; hochwertiger Reflektor mit sphärischer Facettenoptik, präzise Abstrahlcharakteristik mit verschiedenen Ausstrahlwinkeln; werkzeuglos einsetz- bzw. austauschbar; COB (Chip on Board) Technologie für höchste Effizienz; keine Bildung von Mehrfachschatten; effiziente LEDs mit sehr guter Farbwiedergabe

Quickinfo

2700 K, 3000 K, 4000 K, CWD, TW
 CRI ≥ 90, 3 SDCM
 up to 104 lm/W
 L80 @ 50 000 h
 non DIM, DALI-2

Types

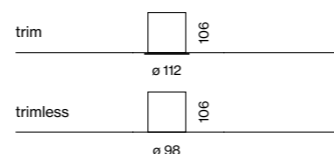

Colours



Light distributions



Order options

COLOUR TEMPERATURE	
2700 K	4
3000 K	5
4000 K	6
CWD 2000–3000 K	
TW 1800–3000 K	
TW 2700–6500 K	

CONTROL	
non DIM	1
DALI-2	3

MATERIAL COLOUR	
○ traffic white RAL 9016	7
● jet black RAL 9005	8

REFLECTOR	
spot 18° (not for HO version)	S
medium 24°	M
flood 36°	F
wide flood 55° (not for HO vers.)	W

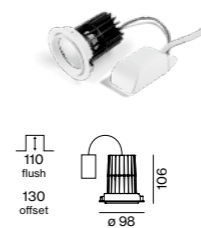

SASSO PRO 100



SPOTLIGHT ADJUSTABLE

SYSTEM POWER	COLOUR TEMP.	LUMINOUS FLUX	ORDER CODE
14.5 W	2700 K	1350 lm	0 4 8 - 2 4 1 0
	3000 K	1420 lm	
	4000 K	1490 lm	
26.5 W	2700 K	2160 lm	0 4 8 - 2 4 1 2
	3000 K	2260 lm	
	4000 K	2380 lm	
27 W HO	2700 K	2580 lm	0 4 8 - 2 4 1 3
	3000 K	2810 lm	
	4000 K	2840 lm	

SYSTEM POWER	LUMINOUS FLUX	ORDER CODE
14.7 W CWD 2000–3000 K	1030 lm	0 4 8 - 2 4 1 1 E 3
28.2 W TW 1800–3000 K	2020 lm	0 4 8 - 2 4 1 2 L 3
28.2 W TW 2700–6500 K	2170 lm	0 4 8 - 2 4 1 2 D 3

Mounting accessories

TRIMLESS MOUNTING SET

for installation in plasterboard ceilings 12.5/15/25 mm

TYPE	ORDER CODE
flush	0 5 2 - 1 9 2 1 4 4 7
offset 17 mm	0 5 2 - 1 9 3 1 4 4

ROUND MOUNTING SET WITH TRIM

for intermediate ceilings 5–25 mm

TYPE	ORDER CODE
flush	0 5 2 - 1 9 2 2 4 4
offset 17 mm	0 5 2 - 1 9 3 2 4 4

SQUARE MOUNTING SET WITH TRIM

for intermediate ceilings 5–25 mm

TYPE	ORDER CODE
flush	0 5 2 - 1 9 4 2 4 1
offset 17 mm	0 5 2 - 1 9 5 2 4 1

CONCRETE MOUNTING HOUSING

for <15 W version

TYPE	L·W·H (mm)	ORDER CODE
exposed concrete ceilings*	229·227·160	0 5 2 - 1 9 1 3 4 1 0
primed concrete ceilings**	ø240·400·130	0 5 2 - 1 9 1 4 4 2 0

*only for flush mounting **order mounting set separately

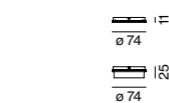
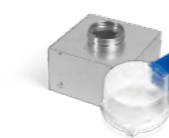
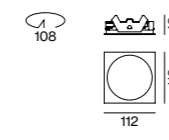
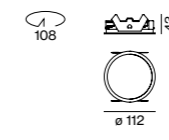
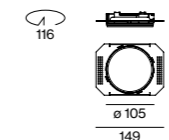

Optical accessories

TYPE	ORDER CODE
honeycomb louver	0 4 8 - 2 1 9 1 3 1
linear prismatic lens	0 4 8 - 2 1 9 2 3 1
snoot	0 4 8 - 2 1 9 1 1 1
snoot with honeycomb louver	0 4 8 - 2 1 9 1 2 1

use only 1 optical accessory

Electrical accessories

THROUGH WIRING CONNECTION BOX

TYPE	L·W·H (mm)	ORDER CODE
non DIM cable ø 4–12 mm	105·58·30	0 0 5 - 2 5 3 1 1 1 0
DALI cable ø 4–12 mm	105·58·30	0 0 5 - 2 5 5 1 1 1 0



DiiA® standards
251, 252, 253

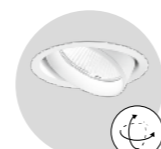

rotatable 360°
tiltable 35°



CWD
2000–3000 K



TW 1800–3000 K &
2700–6500 K

LUMINOUS FLUX value calculated for CRI ≥ 90, colour white, reflector flood, flush mounting

Oberpollinger | The KaDeWe Group
Munich, DE – by Licht Kunst Licht AG
including lighting design



Oberpollinger | The KaDeWe Group
Munich, DE – by Licht Kunst Licht AG
including lighting design



Presence as desired



MOVE IN

EN This luminaire's trump card is mobility. MOVE IN's appearance can be easily adapted without tools at any time because the spots are height-adjustable. New and exciting ceiling pictures are created by combining round or square with flush or protruding spots. The spots are optimally glare-free thanks to the recessed light point plane. MOVE IN flex's spotlight head can be rotated 360° and swivelled 90°. All spots are characterised by an excellent colour rendering value (CRI ≥ 90) and high-quality reflector. The light colours 2700K and 3000K create an atmospheric lighting effect.

DE Beweglichkeit ist Trumpf bei dieser Leuchtenserie. Mit MOVE IN ist das Erscheinungsbild jederzeit anpassbar, denn die Spots sind höhenverstellbar – einfach und ohne Werkzeug. Durch die Kombination aus runden und eckigen, deckenbündigen bzw. hervorragenden Spots entstehen immer neue, spannende Deckenbilder. Dank der zurückversetzten Lichtpunktebene sind die Spots optimal entblendet. Der Strahlerkopf von MOVE IN flex ist 360° dreh- und 90° schwenkbar, zusätzlich zeichnen sich alle Spots durch einen sehr guten Farbwiedergabewert (CRI ≥ 90) und einen hochwertigen Reflektor aus. Die Lichtfarben 2700K und 3000K sorgen für eine atmosphärische Lichtwirkung.

Types

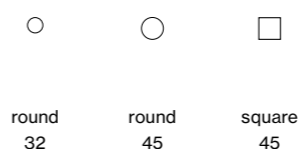

round
32

round
45

square
45

Mounting

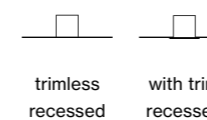

trimless
recessed

with trim
recessed

Light distributions

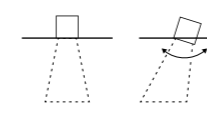

downlight

spotlight

Variety

EN MOVE IN not only provides light, but also designs the ceiling. Round, angular, flush-mounted, and surface-mounted spots can be combined individually and always form new, exciting ceiling arrangements.

DE MOVE IN gibt nicht nur Licht, sondern gestaltet die Decke. Runde, eckige, deckenbündige und aufbauende Spots lassen sich individuell kombinieren und formen stets neue, spannende Deckenbilder.

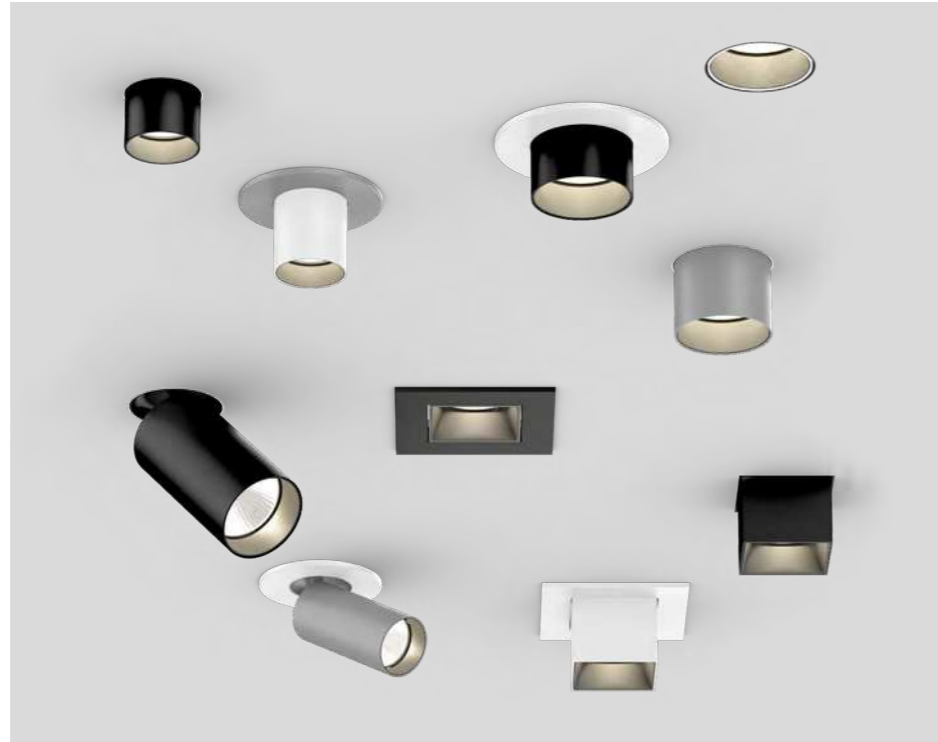

Glare control & colour rendering

EN Thanks to the recessed light spot level, MOVE IN spots provide optimum glare control. As the high-quality reflector optics have very good colour rendering values (CRI ≥ 90), objects are rendered almost true to colour.

DE Dank der zurückversetzten Lichtpunktebene sind MOVE IN Spots optimal entblendet. Da der hochwertige Reflektor über sehr gute Farbwiedergabewerte (CRI ≥ 90) verfügt, werden Objekte nahezu farbecht wiedergegeben.



Light distribution

EN Thanks to different beam angles, MOVE IN is suitable for different areas of application: from narrow-beam spot for precise and targeted lighting, to medium and flood for accentuated basic brightness.

DE Dank verschiedener Ausstrahlwinkel ist MOVE IN für unterschiedliche Einsatzbereiche geeignet: vom eng ausstrahlenden Spot für präzise und zielgerichtete Beleuchtung, bis hin zu Medium und Flood für eine akzentuierte Grundhelligkeit.

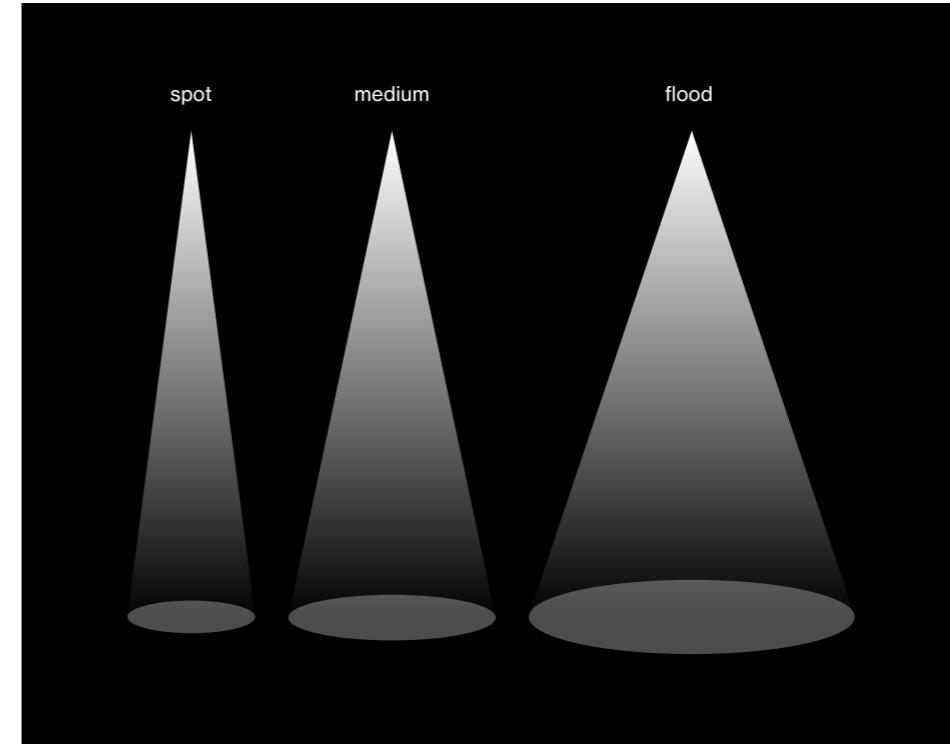

Precise light adjustment

EN MOVE IN flex offers the greatest possible flexibility. The spotlight can not only be rotated 360°, but also swivelled 90°. This allows the light to be directed exactly where it is needed.

DE MOVE IN flex bietet größtmögliche Flexibilität. Der Strahler kann nicht nur um 360° gedreht, sondern auch um 90° geschwenkt werden. Das ermöglicht die exakte Lenkung des Lichts genau dorthin, wo es benötigt wird.

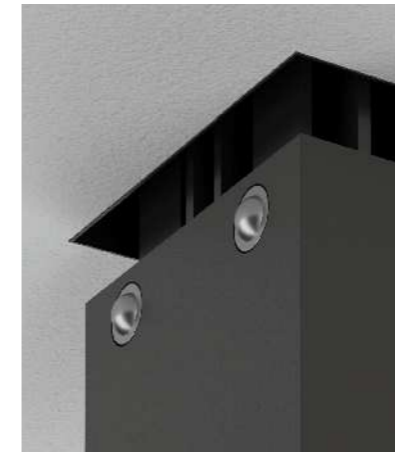

Ball catch system

EN Mounting and replacing MOVE IN spots is very easy. The spots are fixed in the system by a ball catch system. This in turn can be installed in three different positions – for flexible adaptation of the lighting to changing requirements and conditions.

DE Montage und Tausch von MOVE IN Spots sind denkbar einfach. Durch ein Kugelschnappsystem werden die Spots im System fixiert. Dieses wiederum lässt sich in drei verschiedenen Positionen installieren. Für eine flexible Anpassung der Beleuchtung an wechselnde Anforderungen und Konditionen.



← back

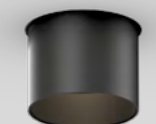
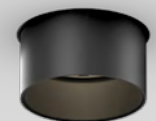

MOVE IN round

recessed

Round spotlight element in aluminium, available in 2 sizes; powder coated; installation without tools in mounting set (trimless or with trim) with ball catch system; special mounting tool for easy installation of the trimless housing available as an accessory; spotlight element height adjustable without tools: flush with the ceiling, or extended 25 mm or 35 mm; COB (Chip on Board) technology for maximum efficiency; no multiple shadows; energy-efficient LEDs with very good colour rendering; high-quality, aluminium, vapour deposition coated reflector with faceted design; precise radiation characteristic; good glare reduction due to recessed light point plane; optical attachments as accessories

Rundes Strahlerelement aus Aluminium in 2 Größen; pulverbeschichtet; werkzeuglose Montage im Montageset (randlos oder mit umlaufendem Rand) durch Kugelschnappsystem; spezielles Montagewerkzeug zur einfachen Installation des randlosen Gehäuses als Zubehör erhältlich; Strahlerelement werkzeuglos höhenverstellbar: deckenbündig, 25 mm oder 35 mm herausragend; COB (Chip on Board) Technologie für höchste Effizienz; keine Mehrfachschattenbildung; energieeffiziente LEDs mit sehr guter Farbwiedergabe; hochwertiger, aluminiumbedampfter Reflektor mit Facettenoptik; präzise Abstrahlcharakteristik; gute Entblendung durch zurückversetzte Lichtpunktebene; optische Aufsätze als Zubehör

Quickinfo

2700 K, 3000 K
 CRI ≥ 90, 3 SDCM
 MOVE IN 32 up to 86 lm/W
 MOVE IN 45 up to 95 lm/W
 L80 @ 50 000 h
 non DIM, DALI-2

Types

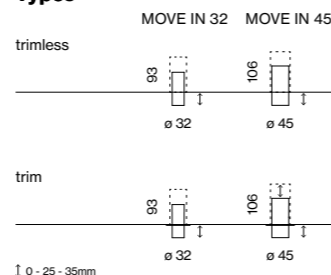

Inset colours



Housing colours



Light distributions

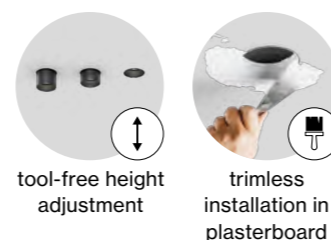

tool-free height adjustment

trimless installation in plasterboard

Order options

COLOUR TEMPERATURE	
2700 K	4
3000 K	5

INSET COLOUR	
○ traffic white RAL 9016	7
● jet black RAL 9005	8

HOUSING COLOUR	
○ traffic white RAL 9016	7
● silver-grey	G
● jet black RAL 9005	8

BEAM ANGLE	
MOVE IN 32 / 45	▲
spot 18° / 14°	S
medium 23° / 24°	M
flood 37° / 39°	F

Options on request

MOUNTING HOUSING	
special colours	

POWER SUPPLY	
DIM 1-10V	

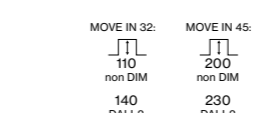
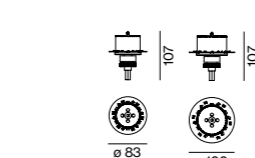
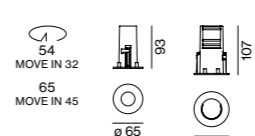
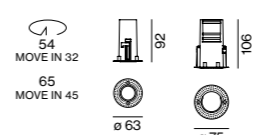
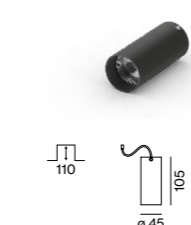
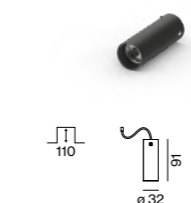

MOVE IN 32 round



SPOTLIGHT incl. connection cable 600 mm		
INSET POWER	LUMINOUS FLUX	ORDER CODE
8.8 W 36 Vf 250 mA	755 lm	063-81111::1▲

MOVE IN 45 round



SPOTLIGHT incl. connection cable 600 mm		
INSET POWER	LUMINOUS FLUX	ORDER CODE
12.8 W 37 Vf 350 mA	spot 1010 lm	063-81212::1▲S
13.5 W 36 Vf 400 mA	1280 lm	063-81212::1▲

Mounting accessories

MOUNTING HOUSING TRIMLESS
 for installation in plasterboard ceilings 9-25 mm

TYPE	Ø-H (mm)	ORDER CODE
MOVE IN 32	63-93	063-8821117
MOVE IN 45	75-106	063-8821217

MOUNTING HOUSING WITH TRIM
 for installation in ceilings from 2-25 mm

TYPE	Ø-H (mm)	ORDER CODE
MOVE IN 32	65-93	063-8821111■
MOVE IN 45	77-107	063-8822111■

SPECIAL MOUNTING TOOL

TYPE	Ø-H (mm)	ORDER CODE
MOVE IN 32	83-9	063-89111110
MOVE IN 45	100-9	063-89121110

necessary to install mounting housing trimless

Electrical accessories

POWER SUPPLY 220-240 V AC, 50-60 Hz, PC II

TYPE	EFFICIENCY	L-W-H (mm)	ORDER CODE
250 mA non DIM	η 80 %	65-39-20	002-90742
250 mA DALI-2	η 82 %	166-30-22	002-90743
350 mA non DIM	η 85 %	180-30-21	002-90722
350 mA DALI-2	η 83 %	210-30-21	002-90723
400 mA non DIM	η 88 %	180-30-21	002-90724
400 mA DALI-2	η 84 %	210-30-21	002-90725

MOVE IN 32 trimless revision opening required

DIN RAIL COMPONENTS

TYPE	W-H-D (mm)	ORDER CODE
POWER SUPPLY 220-240 V AC	90-90-60	005-6520210
96 W 48 V DC constant voltage		
LED DRIVER DALI-2 DT6 1-2 addr.	36-88-59	005-6121030
200-1050 mA settable const. current		
2 × 42 W 48 V DC U _{OUT} 10-40 V		

for more details and components see page Seite 981

Optical accessories

HONEYCOMB LOUVER

TYPE	Ø-H (mm)	ORDER CODE
MOVE IN 32	30-3	007-1965168
MOVE IN 45	42-3	007-1965188

INSET POWER is the current consumption excluding any ballast
LUMINOUS FLUX value calculated for 3000 K, CRI ≥ 90, colour white, reflector flood 2700 K -6%

[← back](#)

MOVE IN flex

recessed

Round spotlight element in aluminium, available in 2 sizes; powder coated; installation without tools in mounting set (trimless or with trim) with ball catch system; special mounting tool for easy installation of the trimless housing available as an accessory; spotlight element height adjustable without tools: flush with the ceiling, or extended 25 mm or 35 mm; spotlight head rotates 360° and tilts 90°; COB (Chip on Board) technology for maximum efficiency; no multiple shadows; energy-efficient LEDs with very good colour rendering; high-quality, aluminium, vapour deposition coated reflector with faceted design; precise radiation characteristic; good glare reduction due to recessed light point plane; optical attachments as accessories

Rundes Strahlerelement aus Aluminium in 2 Größen; pulverbeschichtet; werkzeuglose Montage im Montageset (randlos oder mit umlaufendem Rand) durch Kugelschnappsystem; spezielles Montagewerkzeug zur einfachen Installation des randlosen Gehäuses als Zubehör erhältlich; Strahlerelement werkzeuglos höhenverstellbar: deckenbündig, 25 mm oder 35 mm herausragend; Strahlerkopf 360° dreh- und 90° schwenkbar; COB (Chip on Board) Technologie für höchste Effizienz; keine Mehrfachschattenbildung; energieeffiziente LEDs mit sehr guter Farbwiedergabe; hochwertiger, aluminiumbedampfter Reflektor mit Facettenoptik; präzise Abstrahlcharakteristik; gute Entblendung durch zurückversetzte Lichtpunktebene; optische Aufsätze als Zubehör

Quickinfo

2700 K, 3000 K
CRI ≥ 90, 3 SDCM
MOVE IN 32 up to 86 lm/W
MOVE IN 45 up to 95 lm/W
L80 @ 50 000 h
non DIM, DALI-2

Types

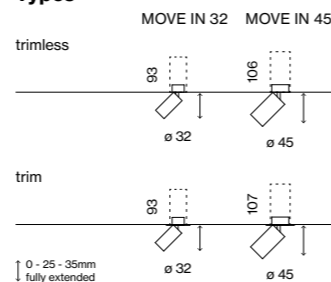

Inset colours



Housing colours



Light distributions



Order options

COLOUR TEMPERATURE	☐☐
2700 K	4
3000 K	5

INSET COLOUR	☑
○ traffic white RAL 9016	7
● jet black RAL 9005	8

HOUSING COLOUR	■
○ traffic white RAL 9016	7
● silver-grey	G
● jet black RAL 9005	8

BEAM ANGLE	▲
MOVE IN 32 / 45	
spot 18° / 14°	S
medium 23° / 24°	M
flood 37° / 39°	F

Options on request

MOUNTING HOUSING	
special colours	

POWER SUPPLY	
DIM 1-10V	

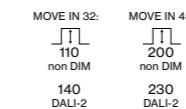
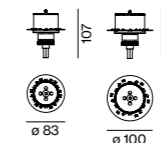
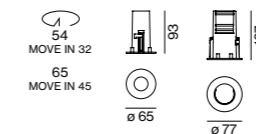
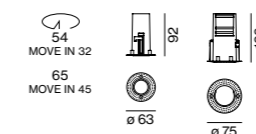
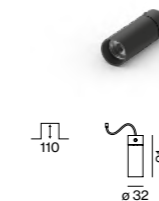

MOVE IN 32 flex



SPOTLIGHT incl. connection cable 600 mm

INSET POWER	LUMINOUS FLUX	ORDER CODE
8.8 W 36 Vf 250 mA	755 lm	063-82111::1■▲

MOVE IN 45 flex



SPOTLIGHT incl. connection cable 600 mm

INSET POWER	LUMINOUS FLUX	ORDER CODE
12.8 W 37 Vf 350 mA	spot 1010 lm	063-82211::1■S
13.5 W 36 Vf 400 mA	1280 lm	063-82211::1■▲

Mounting accessories

MOUNTING HOUSING TRIMLESS
for installation in plasterboard ceilings 9-25 mm

TYPE	Ø-H (mm)	ORDER CODE
MOVE IN 32	63-93	063-8811117
MOVE IN 45	75-106	063-8812117

MOUNTING HOUSING WITH TRIM
for installation in ceilings from 2-25 mm

TYPE	Ø-H (mm)	ORDER CODE
MOVE IN 32	65-93	063-8821111■
MOVE IN 45	77-107	063-8822111■

SPECIAL MOUNTING TOOL

TYPE	Ø-H (mm)	ORDER CODE
MOVE IN 32	83-9	063-89111110
MOVE IN 45	100-9	063-89121110

necessary to install mounting housing trimless

Electrical accessories

POWER SUPPLY 220-240 V AC, 50-60 Hz, PC II

TYPE	EFFICIENCY	L-W-H (mm)	ORDER CODE
250 mA non DIM	η 80 %	65-39-20	002-90742
250 mA DALI-2	η 82 %	166-30-22	002-90743
350 mA non DIM	η 85 %	180-30-21	002-90722
350 mA DALI-2	η 83 %	210-30-21	002-90723
400 mA non DIM	η 88 %	180-30-21	002-90724
400 mA DALI-2	η 84 %	210-30-21	002-90725

MOVE IN 32 trimless revision opening required

DIN RAIL COMPONENTS

TYPE	W-H-D (mm)	ORDER CODE
POWER SUPPLY 220-240 V AC	90-90-60	005-6520210
96 W 48 V DC constant voltage		
LED DRIVER DALI-2 DT6 1-2 addr.	36-88-59	005-6121030
200-1050 mA settable const. current		
2 × 42 W 48 V DC U _{OUT} 10-40 V		

for more details and components see page Seite 981

Optical accessories

TYPE	Ø-H (mm)	ORDER CODE
MOVE IN flex 32	30-3	007-1965168
MOVE IN flex 45	42-3	007-1965188

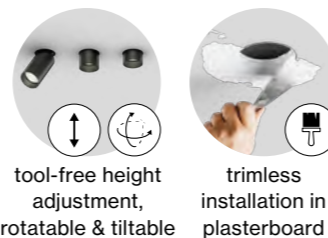

INSET POWER is the current consumption excluding any ballast
LUMINOUS FLUX value calculated for 3000 K, CRI ≥ 90, colour white, reflector flood 2700 K -6 %

Hargassner Energy World Linz, AT –
by architekten berger.hofmann og & tech3
Projektentwicklung GmbH with lighting design
by AREA C.I.DESIGN GmbH



back



MOVE IN 45 square

recessed

EN Square spotlight element in aluminium; powder coated; installation without tools in mounting set (trimless or with trim) with ball catch system; special mounting tool for easy installation of the trimless housing available as an accessory; spotlight element height adjustable without tools: flush with the ceiling, or extended 25 mm or 35 mm; COB (Chip on Board) technology for maximum efficiency; no multiple shadows; energy-efficient LEDs with very good colour rendering; high-quality, aluminium, vapour deposition coated reflector with faceted design; precise radiation characteristic; good glare reduction due to recessed light point plane; optical attachments as accessories

DE Quadratisches Strahlerelement aus Aluminium; pulverbeschichtet; werkzeuglose Montage im Montageset (randlos oder mit umlaufendem Rand) durch Kugelschnappsystem; spezielles Montagewerkzeug zur einfachen Installation des randlosen Gehäuses als Zubehör erhältlich; Strahlerelement werkzeuglos höhenverstellbar: deckenbündig, 25 mm oder 35 mm herausragend; COB (Chip on Board) Technologie für höchste Effizienz; keine Mehrfachschattenbildung; energieeffiziente LEDs mit sehr guter Farbwiedergabe; hochwertiger, aluminiumbedampfter Reflektor mit Facettenoptik; präzise Abstrahlcharakteristik; gute Entblendung durch zurückversetzte Lichtpunktebene; optische Aufsätze als Zubehör

Quickinfo

2700 K, 3000 K
CRI ≥ 90, 3 SDCM
up to 95 lm/W
L80 @ 50 000 h
non DIM, DALI-2

Types

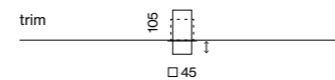
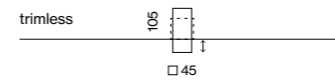

| 0 - 25 - 35mm

Inset colours



Housing colours



Light distributions



spot med. flood

Order options

COLOUR TEMPERATURE	
2700 K	4
3000 K	5

INSET COLOUR	
<input type="radio"/> traffic white RAL 9016	7
<input checked="" type="radio"/> jet black RAL 9005	8

HOUSING COLOUR	
<input type="radio"/> traffic white RAL 9016	7
<input checked="" type="radio"/> silver-grey	G
<input checked="" type="radio"/> jet black RAL 9005	8

BEAM ANGLE	
spot 14°	S
medium 24°	M
flood 39°	F

Options on request

MOUNTING HOUSING
special colours

POWER SUPPLY
DIM 1-10V

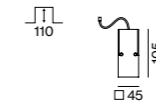

MOVE IN 45 square



SPOTLIGHT incl. connection cable 600 mm

INSET POWER	LUMINOUS FLUX	ORDER CODE
12.8 W 37 Vf 350 mA	spot 1010 lm	0 6 3 - 8 4 2 1 :: 1 ■ S
13.5 W 36 Vf 400 mA	1280 lm	0 6 3 - 8 4 2 1 :: 1 ■ ▲

Mounting accessories

MOUNTING HOUSING TRIMLESS

for installation in plasterboard ceilings 9-25 mm

TYPE	Ø-H (mm)	ORDER CODE
MOVE IN 45	80-54	0 6 3 - 8 8 3 2 1 1 7

MOUNTING HOUSING WITH TRIM

for installation in ceilings from 2-25 mm

TYPE	L-W-H (mm)	ORDER CODE
MOVE IN 45	78-78-55	0 6 3 - 8 8 4 2 1 1 ■

SPECIAL MOUNTING TOOL

TYPE	Ø-H (mm)	ORDER CODE
MOVE IN 45	100-9	0 6 3 - 8 9 1 2 1 1 0

necessary to install mounting housing trimless

Electrical accessories

POWER SUPPLY 220-240V AC, 50-60 Hz, PC II

TYPE	EFFICIENCY	L-W-H (mm)	ORDER CODE
350 mA non DIM	η 85 %	180-30-21	0 0 2 - 9 0 7 2 2
350 mA DALI-2	η 83 %	210-30-21	0 0 2 - 9 0 7 2 3
400 mA non DIM	η 88 %	180-30-21	0 0 2 - 9 0 7 2 4
400 mA DALI-2	η 84 %	210-30-21	0 0 2 - 9 0 7 2 5

DIN RAIL COMPONENTS

TYPE	W-H-D (mm)	ORDER CODE
POWER SUPPLY 220-240 V AC 96 W 48V DC constant voltage	90-90-60	0 0 5 - 6 5 2 0 2 1 0
LED DRIVER DALI-2 DT6 1-2 addr. 200-1050 mA settable const. current 2 × 42 W 48 V DC U _{OUT} 10-40 V	36-88-59	0 0 5 - 6 1 2 1 0 3 0

for more details and components see page Seite 981

Optical accessories

HONEYCOMB LOUVER

TYPE	Ø-H (mm)	ORDER CODE
MOVE IN 45	42-3	0 0 7 - 1 9 6 5 1 8 8

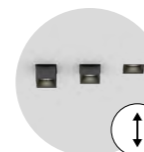

tool-free height adjustment



trimless installation in plasterboard

INSET POWER is the current consumption excluding any ballast
LUMINOUS FLUX value calculated for 3000 K, CRI ≥ 90, colour white, reflector flood 2700 K -6 %



Lampenwelt GmbH Schlitz, DE –
lighting design by Lampenwelt GmbH

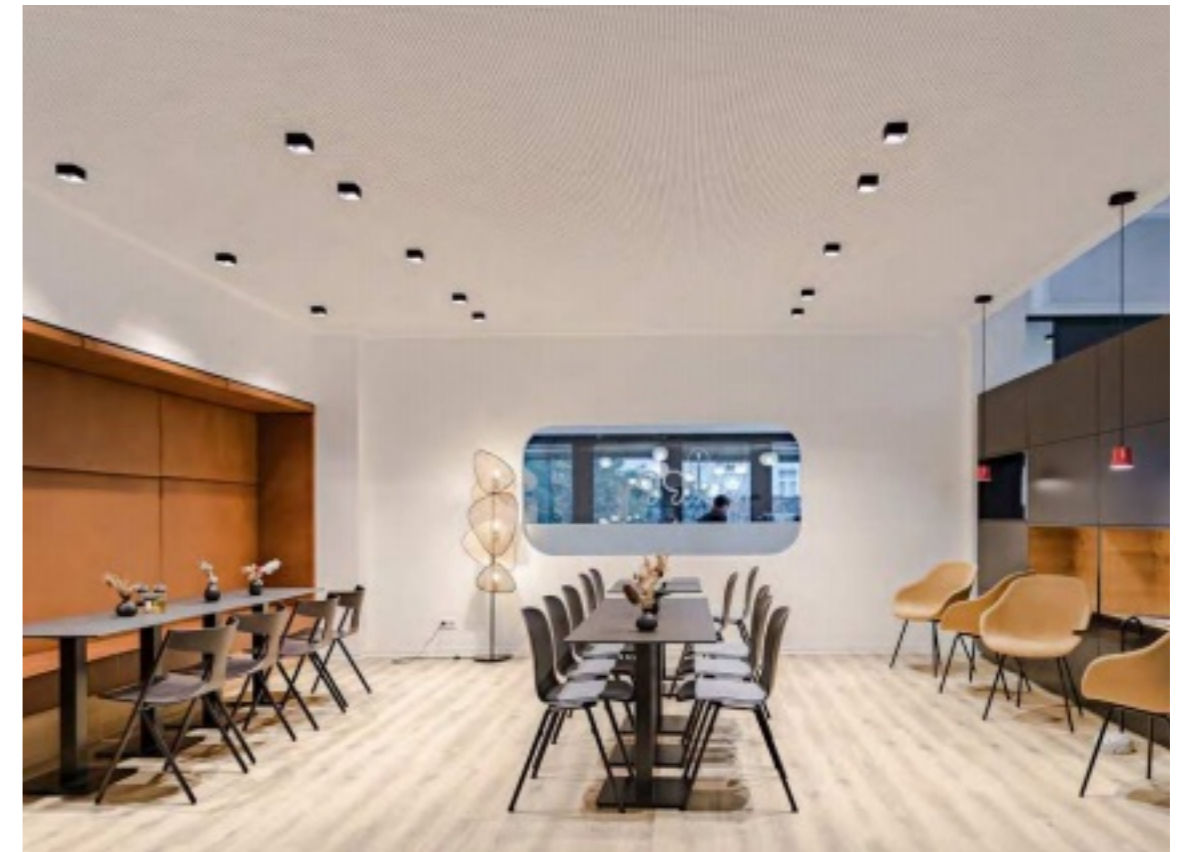

Add a little twist



TWIST

EN A round recessed spotlight, ideal for retail. TWIST can be completely recessed into the ceiling or swivelled out and aligned, either bringing it to the fore or making it take a step back. Thanks to its 360° rotation and 45° tilt, it is highly flexible and adapts to evolving conditions in shops. The high-quality reflector produces precise beam characteristics with three different beam angles. TWIST is simply mounted without tools using a ball catch system. Excellent colour rendering value (CRI ≥ 90) at 2700K, 3000K, or 4000K ensures outstanding product presentation.

DE Ein runder Einbaustrahler, ideal für Retail. TWIST macht sich sichtbar oder nimmt sich zurück: Der Strahler kann auf Wunsch völlig in die Decke versetzt oder herausgeschwenkt und ausgerichtet werden. Mit 360° Dreh- und 45° Schwenkbarkeit ist er höchst flexibel und passt sich an neue Gegebenheiten in Shops an. Der hochwertige Reflektor bietet eine präzise Abstrahlcharakteristik mit drei verschiedenen Ausstrahlwinkeln. Mittels Kugelschnappsystem wird TWIST einfach werkzeuglos montiert. Ein sehr guter Farbwiedergabewert (CRI ≥ 90) bei 2700K, 3000K oder 4000K sorgt für exzellente Warenpräsentation.

Types

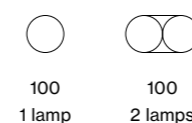

100
1 lamp

100
2 lamps

Mountings

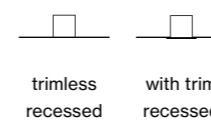

trimless
recessed

with trim
recessed

Light distribution

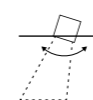

spotlight

← back



TWIST 100

recessed



EN Round recessed spotlight in die-cast aluminium; powder coated; installation without tools in mounting set (trimless or with trim) with ball catch system; 360° rotatable and 45° tiltable outward; COB (Chip on Board) technology for maximum efficiency; no multiple shadows; energy-efficient LEDs with very good colour rendering; high quality reflector with spherical facet finish; precise radiation characteristic; optical attachments as accessories; optical attachments can be combined

DE Runder Einbaustrahler aus Aluminium-druckguss; pulverbeschichtet; werkzeuglose Montage im Montageset (randlos oder mit umlaufendem Rand) durch Kugelschnappsystem; 360° dreh- und 45° ausschwenkbar; COB (Chip on Board) Technologie für höchste Effizienz; keine Mehrfachschattenbildung; energieeffiziente LEDs mit sehr guter Farbwiedergabe; hochwertiger Reflektor mit sphärischer Facettenoptik; präzise Abstrahlcharakteristik; optische Aufsätze als Zubehör; optische Aufsätze miteinander kombinierbar

Quickinfo

3000K, 4000K
CRI ≥ 90, 3 SDCM
up to 96lm/W
L80 @ 50 000h
non DIM, DALI-2

Types

trim		99
	ø 118	
trimless		88
	ø 105	
double trim		88
	218x118	

Colours



Light distributions



Order options

COLOUR TEMPERATURE	••
3000K	5
4000K	6

CONTROL

non DIM
DALI-2

INSET COLOUR

<input type="radio"/> traffic white RAL 9016 (UGR ≤ 22)	7
<input checked="" type="radio"/> jet black RAL 9005 (UGR ≤ 16)	8

BEAM ANGLE

spot 17°	S
medium 28°	M
flood 38°	F

Options on request

COLOUR TEMPERATURE

2700K

INSET COLOUR

grey aluminium RAL 9007

MOUNTING SET COLOUR

grey aluminium RAL 9007

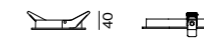
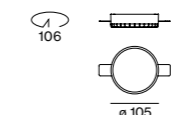

TWIST 100 recessed

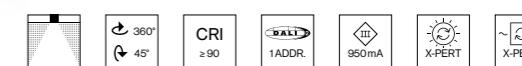

SPOTLIGHT ADJUSTABLE

INSET POWER	LUMINOUS FLUX	ORDER CODE
34 W	3250 lm	048-1120::1▲▲

Mounting accessories

TRIMLESS MOUNTING SET

for installation in plasterboard ceilings 12.5/15/25mm

COLOUR	ORDER CODE
<input type="radio"/> traffic white RAL 9016	048-2796117

MOUNTING SET WITH TRIM for intermediate ceilings 2-25mm

TYPE	COLOUR	ORDER CODE
1 lamp	<input type="radio"/> traffic white RAL9016	048-2796317
	<input checked="" type="radio"/> jet black RAL 9005	048-2796318
2 lamps*	<input type="radio"/> traffic white RAL9016	048-2798317
	<input checked="" type="radio"/> jet black RAL 9005	048-2798318

*do not use in combination with optical accessories

Electrical accessories

POWER SUPPLY 220-240V AC, 50-60Hz, PC II

TYPE	EFFICIENCY	L-W-H (mm)	ORDER CODE
950 mA non DIM	η 89 %	136-43-30	002-90781
950 mA DALI-2	η 85 %	143-43-30	002-90782

THROUGH WIRING CONNECTION BOX

TYPE	L-W-H (mm)	ORDER CODE
non DIM cable ø 4-12mm	105-58-30	005-2531110
DALI cable ø 4-12mm	105-58-30	005-2551110

Optical accessories

LENS AND HONEYCOMB LOUVER

TYPE	Ø-H (mm)	ORDER CODE
linear prismatic lens	75-9	080-6402110P
honeycomb louver	75-9	080-6401118

SNOOT

TYPE	Ø-H (mm)	ORDER CODE
short	66-23	080-6403118
medium	66-38	080-6403218
angle	66-38	080-6403318



2 lamps mounting set



combine 2 optical accessories



360° rotatable, 45° tiltable

INSET POWER is the current consumption excluding any ballast
LUMINOUS FLUX value calculated for 4000K, CRI ≥ 90, colour white, reflector medium 3000K -7%

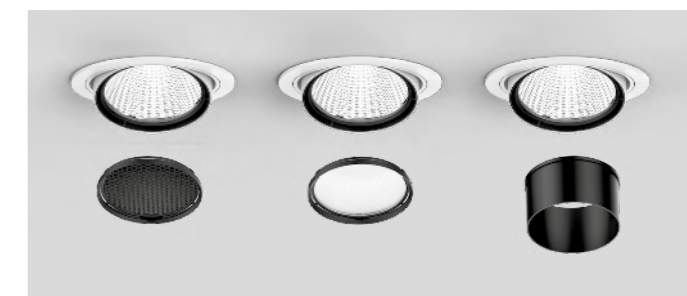

use only one optical accessory



Kastner & Öhler, Kaufhaus Tyrol Innsbruck, AT –
by DIOMA AG / WHIR3 / K&Ö Bauabteilung with
lighting design by VEDDER.LICHTMANAGEMENT



Always and anywhere



SPADO

EN One design, two strengths. SPADO's version with a symmetrical beam is used as a downlight. The version with an asymmetrical beam shines as a wallwasher. The recessed light plane creates a discreet overall impression. It makes the chrome-polished reflector, despite its intense illumination and good colour rendering ($CRI \geq 80$), outstandingly glare-free and screen-friendly. SPADO spotlights are simply mounted without tools and are also suitable for wet rooms with its IP 44 protection class. For the light colours, you can choose between 2700K, 3000K or 4000K.

DE Ein Design, zwei Stärken. Mit symmetrischer Abstrahlung wird SPADO als Downlight eingesetzt, während die Version mit asymmetrischer Abstrahlcharakteristik als Wandfluter brilliert. Die zurückversetzte Leuchtenebene erzielt einen dezenten Gesamteindruck, wodurch der chrom-polierter Reflektor trotz intensiver Ausleuchtung und guter Farbwiedergabe ($CRI \geq 80$) hervorragend entblendet und bildschirmtauglich ist. SPADO Strahler werden einfach werkzeuglos montiert und sind gemäß Schutzart IP 44 auch für Nassräume geeignet. Bei den Lichtfarben haben Sie die Wahl zwischen 2700K, 3000K oder 4000K.

Types



round
100

round
150

square
150

Mounting



trim
recessed

Light distributions

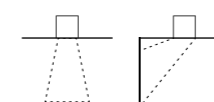

downlight

asymmetric

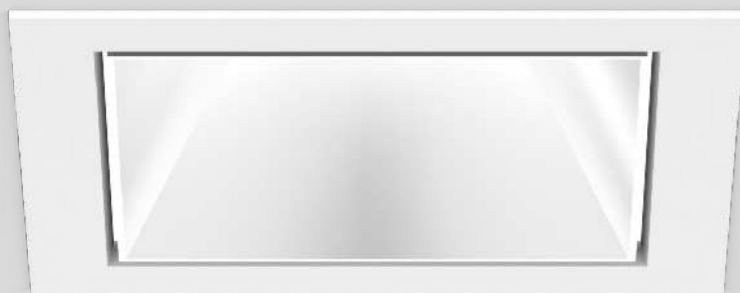
[← back](#)

SPADO 100/150

recessed

EN Round or square luminaire housing in die-cast aluminium; with trim; suitable for ceiling thickness of 2-25mm; surface powder coated; installation without tools using snap spring closure; reflector made of polycarbonate, polished chrome; choice of symmetric or asymmetric (only SPADO 150 round trim) radiation characteristic; lighting level recessed; energy-efficient LEDs with very good colour rendering; external converter for ceiling insertion, for through-wiring suitable; operating device suitable for use with a central battery system

DE Runder oder quadratischer Leuchtenkörper aus Aluminiumdruckguss; mit umlaufendem Rand; geeignet für Deckenstärken von 2-25 mm; Oberfläche pulverbeschichtet; werkzeuglose Montage mittels Schnappfederverschluss; Reflektor aus Polycarbonat, chrom-poliert; wahlweise mit symmetrischer oder asymmetrischer (nur SPADO 150 round trim) Abstrahlcharakteristik; Leuchtenebene zurückversetzt; energieeffiziente LEDs mit sehr guter Farbwiedergabe; externer Konverter für Deckeneinwurf, für Weiterverdrahtung geeignet; Betriebsgerät geeignet für den Betrieb an einem Zentralbatterie-System

Quickinfo

3000K, 4000K
CRI ≥ 80, 3 SDCM
up to 118lm/W
L90 @ 50 000h
non DIM, DALI-2
↓ IP44/↑ IP20

Types

SPADO 100



SPADO 150



Colours



Light distributions



DiiA® standards
251, 252, 253

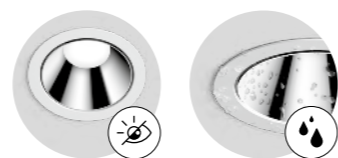

glare control
(UGR ≤ 19)

splash water
protection (IP44)

Order options

COLOUR TEMPERATURE	
3000K	5
4000K	6

CONTROL	
non DIM	1
DALI-2	3

MATERIAL COLOUR	
○ traffic white RAL 9016	7
● jet black RAL 9005	8

Options on request

COLOUR TEMPERATURE
2700K

MOUNTING SET

acoustic soft ceilings
only for SPADO 100 round trim

Light distribution

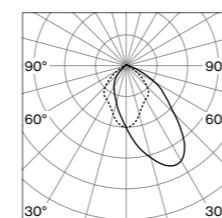

SPADO 150 asymmetric

LUMINOUS FLUX value calculated for
4000 K, colour white, reflector chrome
3000 K -5%

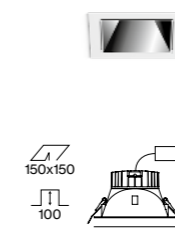
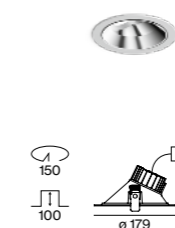
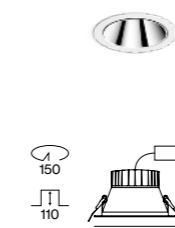
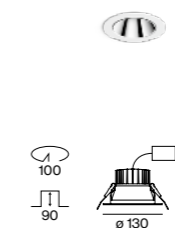

SPADO 100 round trim



DOWNLIGHT (↓ IP44/↑ IP20)

SYSTEM POWER	LUMINOUS FLUX	ORDER CODE
9.3 W	990 lm	0 4 9 - 3 1 1 1 :: :: A O

SPADO 150 round trim



DOWNLIGHT (↓ IP44/↑ IP20)

SYSTEM POWER	LUMINOUS FLUX	ORDER CODE
16.4 W UGR ≤ 19	2350 lm	0 4 9 - 3 1 2 1 :: :: A O
27.5 W	3130 lm	0 4 9 - 3 1 2 3 :: :: A O

SPADO 150 round trim



WALLWASHER ASYMMETRIC (↓ IP44/↑ IP20)

SYSTEM POWER	LUMINOUS FLUX	ORDER CODE
10.7 W	944 lm	0 4 9 - 3 1 2 2 :: :: A O

SPADO 150 square trim



DOWNLIGHT (↓ IP44/↑ IP20)

SYSTEM POWER	LUMINOUS FLUX	ORDER CODE
16.4 W UGR ≤ 19	2380 lm	0 4 9 - 3 1 5 1 :: :: 7 O
27.5 W	3170 lm	0 4 9 - 3 1 5 2 :: :: 7 O

Mounting accessories

EXPOSED CONCRETE CEILINGS

TYPE	L-W-H (mm)	ORDER CODE
SPADO 150 round	295-295-160	0 4 9 - 3 1 9 1 2 1 0
SPADO 150 square	400-260-160	0 4 9 - 3 1 9 2 2 1 0

PRIMED CONCRETE CEILINGS

TYPE	Ø-H (mm)	ORDER CODE
SPADO 150 round/square	307-170	0 4 9 - 3 1 9 1 4 1 0

moovel group
Stuttgart, DE –
by FURCH GESTALTUNG +
PRODUKTION GMBH



Sparkasse
Rüsselsheim, DE –
by Zaeske und Partner
Architekten BDA



High-precision shelf lighting

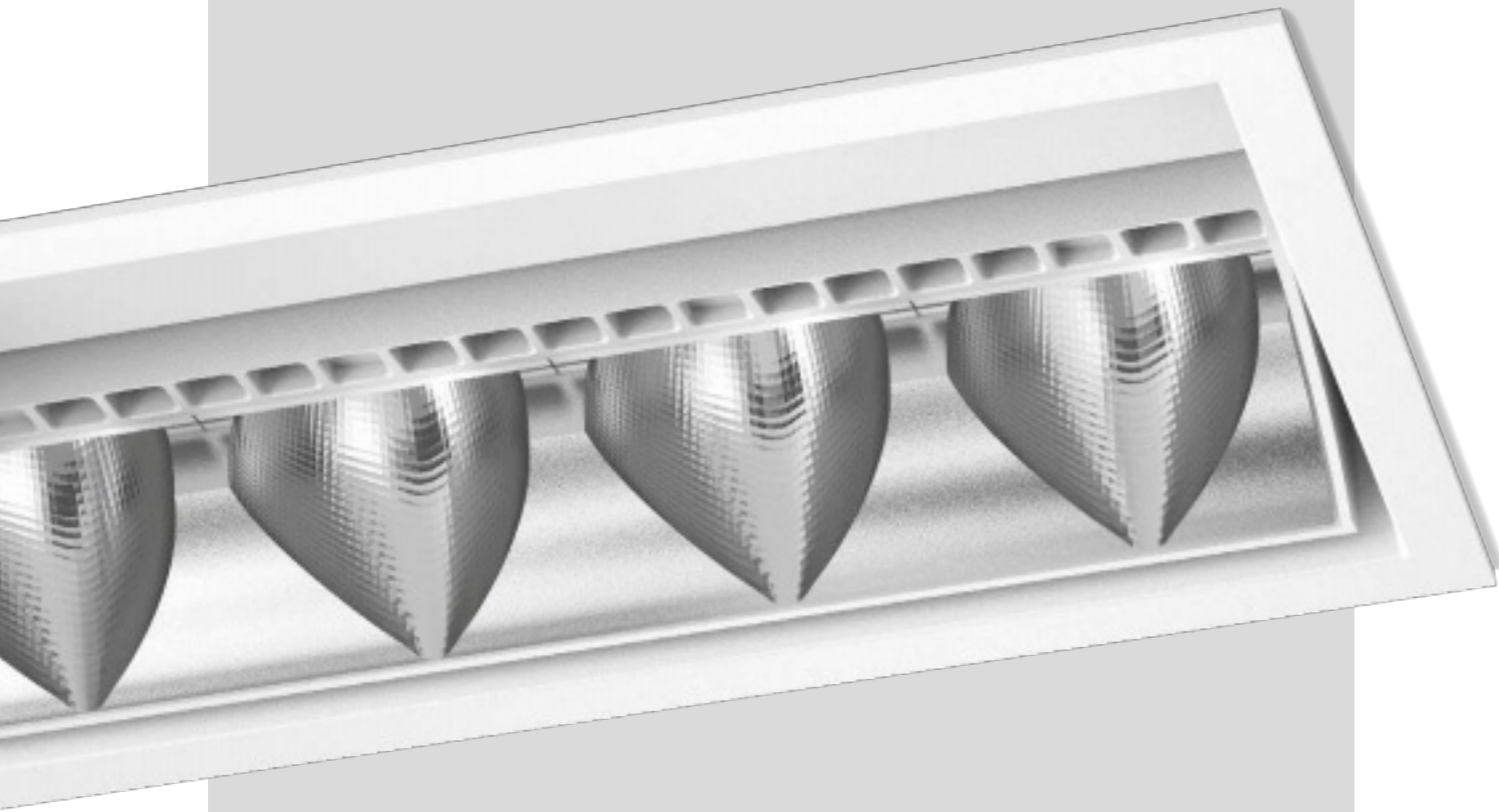

SQUADRO

EN SQUADRO is a track-mounted and recessed spotlight for the retail sector that bundles six essential retail requirements in one luminaire. Free-form reflectors with faceted optics make a polished presentation of goods possible. These reflectors direct the light precisely into shelves or aisle zones. Directed light creates a modelling effect on the products and delivers attractive staging. Swivelling light modules illuminate specific shelf levels or billboards while providing plenty of basic lighting. SQUADRO spotlights are completely glare-free, both transversely and longitudinally. They are highly efficient in their energy balance with an efficiency of over 90%.

DE SQUADRO ist ein Stromschienen- und Einbaustrahler für den Retailbereich, der sechs wichtige Retail-Anforderungen in einer Leuchte bündelt. Die brillante Präsentation von Waren gelingt dank Freiformflächenreflektoren mit Facettenoptik: Diese lenken das Licht punktgenau und hochpräzise in Regale oder Gangzonen. Gerichtetes Licht erzeugt einen Modelling-Effekt auf den Waren und schafft eine attraktive Inszenierung. Schwenkbare Lichtmodule beleuchten gezielt Regalebenen oder Plakatwände und sorgen gleichzeitig für ausreichende Grundbeleuchtung. SQUADRO Strahler sind dabei komplett quer- und längsentblendet und dennoch in ihrer Energiebilanz mit einem Wirkungsgrad von über 90% höchst effizient.

Types



single-sided
1x2

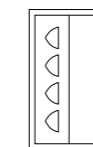

single-sided
1x4

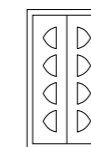

double-sided
2x4

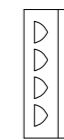

single-sided
1x4

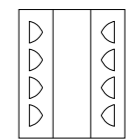

double-sided
2x4

Mountings



recessed



track

Light distributions

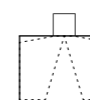

wall floor

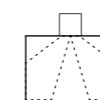

shelf floor

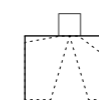

wall/shelf
floor

6-in-1 Lighting solution



EN SQUADRO combines all the advantages of traditional retail lighting solutions in one luminaire. The spotlights are transversely and longitudinally glare-free and direct the light precisely onto the goods – into the heights and depths of the shelves. This achieves a strong product presentation. Thanks to proper light distribution, no additional light source is required for basic lighting.

DE SQUADRO bündelt alle Vorteile klassischer Retail-Lichtlösungen in einer Leuchte. Die Strahler sind quer- und längsentblendet und richten das Licht präzise auf die Ware – bis in die Höhen und Tiefen der Regale. Das erzielt eine starke Produktpräsentation. Dank guter Lichtverteilung ist keine zusätzliche Lichtquelle für die Grundbeleuchtung nötig.

1 EN The highest illuminance is on the upper two presentation levels.

DE Die höchste Beleuchtungsstärke liegt auf den oberen beiden Präsentationsebenen.

2 EN Highlights on premium goods create a brilliant staging.

DE Speziell exklusive Ware wird durch Glanzpunkte attraktiv inszeniert.

3 EN Directed light creates accents on billboards and subjects.

DE Gerichtetes Licht erzeugt Akzente auf Werbetafeln und Sujets.

4 EN The high depth effect gives food high colour contrasts and attractiveness.

DE Durch die hohe Tiefenwirkung erhalten Lebensmittel hohe Farbkontraste und Glanzpunkte.

5 EN Due to longitudinal glare control, the lighting system is barely perceptible to the customer in the direction of the aisle.

DE Durch die Längsentblendung ist die Beleuchtungsanlage für den Kunden in Gangrichtung kaum wahrnehmbar.

6 EN Transverse glare control additionally prevents glare from any viewing direction.

DE Die Querentblendung verhindert zusätzlich Blendung aus jeder Blickrichtung.

Five versions

EN SQUADRO's five variants with diverse beam characteristics respond to different shop layouts and requirements. Perfect alignment ensures that minimal luminaires radiate as much light as possible onto the merchandise. SQUADRO adapts to the conditions and illuminates selectively and without scatter loss. All goods are thus attractively presented regardless of the size or interior design of the shop.

DE SQUADRO antwortet auf unterschiedliche Shop-Layouts und Anforderungen mit fünf Varianten mit verschiedenen Abstrahlcharakteristiken. Damit wenige Leuchten so viel Licht wie möglich auf die Ware strahlen, zählt die perfekte Ausrichtung. SQUADRO passt sich den Gegebenheiten an und beleuchtet punktuell und ohne Streuverluste. So werden alle Waren, unabhängig von Größe oder Innenarchitektur des Shops, ansprechend in Szene gesetzt.

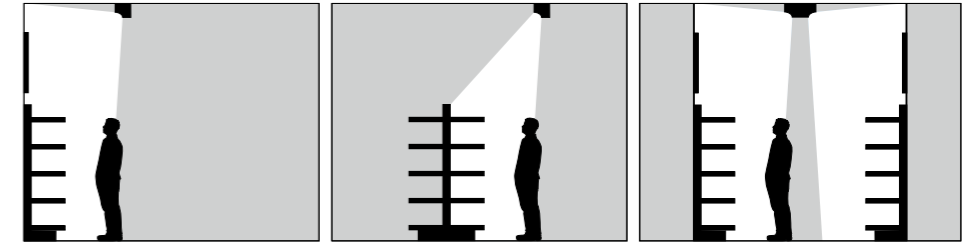

Wall Floor (single-side)

Shelf Floor (single-side)

Wall Floor (double-side)

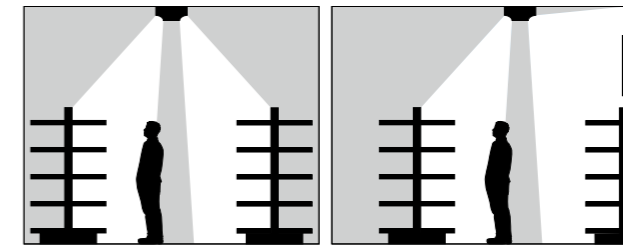

Shelf Floor (double-side)

Shelf / Wall Floor

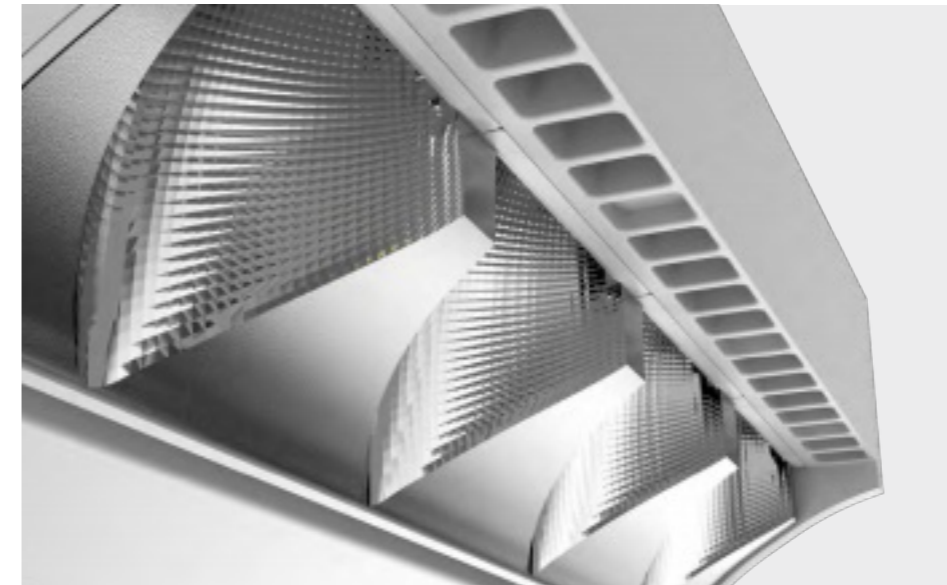

Unique reflector technology

EN Custom free-form reflectors ensure high-precision light control; each SQUADRO achieves an efficiency of over 90 per cent. The spotlights enjoy optimum glare control through the curved shape and secondary reflector technology.

DE Spezielle Freiflächenreflektoren sorgen für hochpräzise Lichtlenkung; jeder SQUADRO erzielt einen Wirkungsgrad von über 90 Prozent. Optimale Entblendung gelingt durch die gekrümmte Form und Sekundärreflektortechnik der Strahler.

Effective lighting

EN Branches of the same chain often differ in their shop architecture. Shelf heights and aisle widths may vary from one location to another. The solution is step-adjustable light modules. The elements can be tilted from -15° to $+20^\circ$. Each module can be tilted asymmetrically, allowing precise alignment and thus optimum light control.

DE Filialen derselben Kette unterscheiden sich häufig in der Shop-Architektur. Regalhöhen und Gangbreiten können sich je nach Standort unterscheiden. Die Lösung: stufenverstellbare Lichtmodule. Die Elemente sind von -15° bis zu $+20^\circ$ kippbar. Jedes Modul kann asymmetrisch geneigt werden und ermöglicht eine präzise Ausrichtung und damit eine optimale Lichtlenkung.

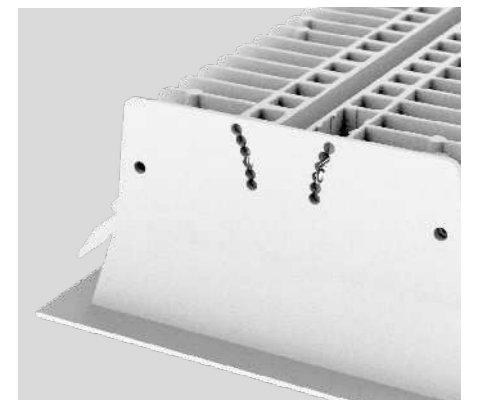

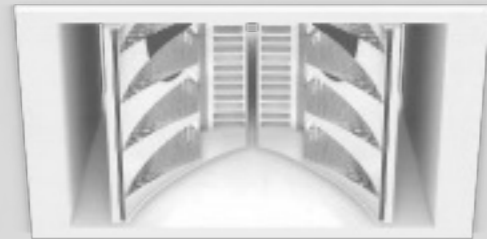
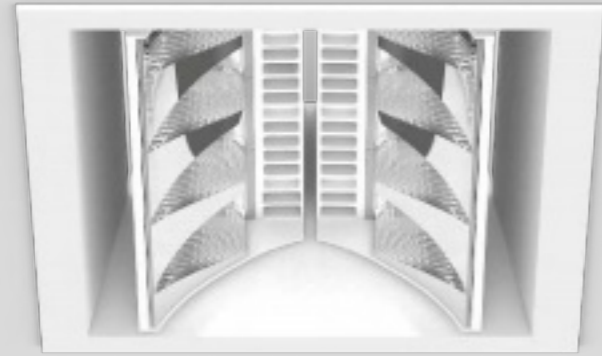

SQUADRO wallwasher

recessed

EN Recessed ceiling spotlight in die cast aluminium in 2 sizes, in different types (2 lamps, 4 lamps or 2 x 4 lamps) and with 2 types of light modules (for shelf floor washer and wall floor washer); with trim; surface powder coated; installation without tools using snap spring closure; aisle spotlight with special, multi-free-form, facet effect surface reflectors for high precision light control; precise shelf and aisle zone lighting, optimum longitudinal glare control for high viewing comfort in the aisle zone, adjustable light modules; COB (Chip on Board) technology for maximum efficiency; efficient LEDs with very good colour rendering; IP 40 protection glass available as an accessory

DE Deckeneinbaustrahler aus Aluminium-druckguss in 2 Größen, in verschiedenen Varianten (2-flammig, 4-flammig bzw. 2 x 4-flammig) und mit 2 verschiedenen Lichtmodulen (für shelf floor washer und wall floor washer); mit umlaufendem Rand; Oberfläche pulverbeschichtet; werkzeuglose Montage mittels Schnappfederverschluss; Gangzonenstrahler mit speziellen Multi-Freiformflächenreflektoren mit Facettenoptik zur äußerst präzisen Lichtlenkung; punktgenaue Regal- und Gangzonenausleuchtung, optimale Längsentblendung für hohen Sehkomfort in der Gangzone, einstellbare Lichtmodule; COB (Chip on Board) Technologie für höchste Effizienz; effiziente LEDs mit sehr guter Farbwiedergabe; IP40-Schutzglas als Zubehör erhältlich

Quickinfo

3000K, 4000K
CRI ≥ 80, 3 SDCM
up to 134lm/W
L80 @ 50000h
non DIM, DALI-2

Types

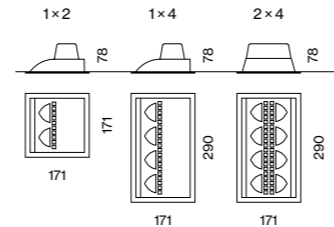

Colours



Light distributions

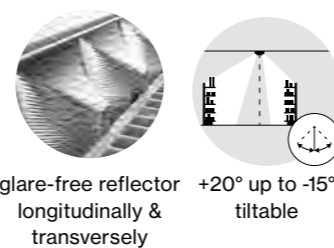
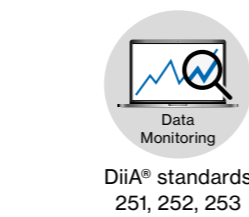
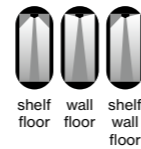

Order options

COLOUR TEMPERATURE	
3000K	5
4000K	6

CONTROL	
non DIM	1
DALI-2	3

MATERIAL COLOUR	
○ traffic white RAL 9016	7
● jet black RAL 9005	8

REFLECTOR	
shelf floor washer	S
wall floor washer	A
1 x shelf / 1 x wall floor washer*	B

*only for 2 x 4 lamps

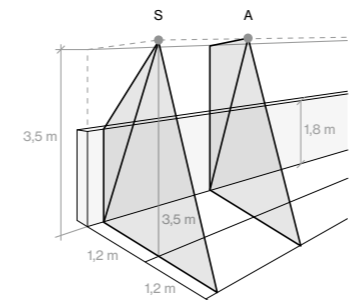

Light distributions

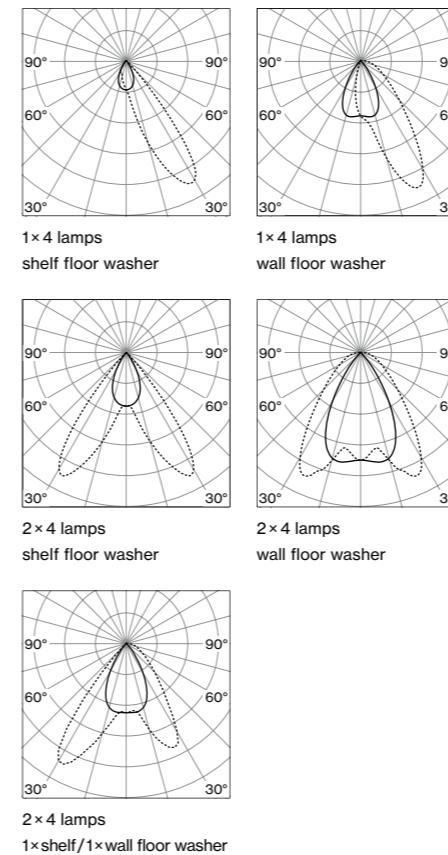

LUMINOUS FLUX value calculated for 4000K (3000K -5%), colour white, wall floor washer



SQUADRO wallwasher trim



1 x 2 LAMPS SINGLE-SIDED	
SYSTEM POWER	25.3 W
LUMINOUS FLUX	3250 lm
ORDER CODE	049-2011



1 x 4 LAMPS SINGLE-SIDED	
SYSTEM POWER	51 W
LUMINOUS FLUX	6490 lm
ORDER CODE	049-2031

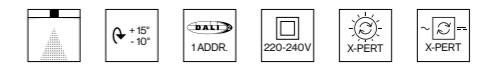

2 x 4 LAMPS DOUBLE-SIDED	
SYSTEM POWER	86 W
LUMINOUS FLUX	2 x 5760 lm
ORDER CODE	049-2040
	101 W
	2 x 6495 lm
	049-2041

Optical accessories

IP 40 PROTECTION GLASS

TYPE		ORDER CODE
1 x 2 lamps/single-sided		049-2910010
1 x 4 lamps/single-sided		049-2930010
2 x 4 lamps/double-sided		049-2940010

Technical data

SQUADRO 1 x 4 lamps, shelf wall washer, trim, 51W, 3000K

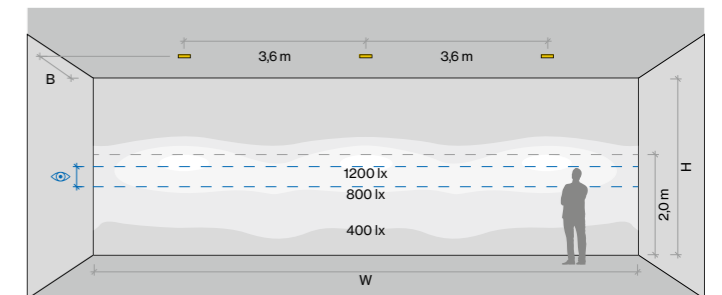

SQUADRO 1 x 4 lamps, wall floor washer, trim, 51W, 3000K

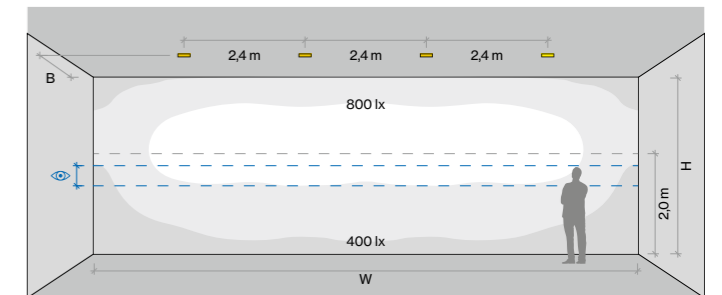

ROOM VALUES		CALCULATION SURFACE	
Wall dimensions	H = 3.5m W = 10.8m	Surface dimensions	10.8 x 3.5m
Distance to wall	B = 1.3m	Surface height	0 - 3.5m
Aisle width	2.6m		
Reflection factor	0.7 0.7 0.2	Eye level	1.35m - 1.75m
Maintenance factor	0.9		



Casagrande Luxury Lifestyle
Lucerne, CH –
by Obrist interior AG



← back



SQUADRO wallwasher track

Track light in die cast aluminium in two different types (4 lamps or 2x4 lamps) and with 2 types of light modules (for shelf floor washer and wall floor washer); surface powder coated; aisle spotlight with special, multi-free-form, facet effect surface reflectors for high precision light control; precise shelf and aisle zone lighting, optimum longitudinal glare control for high viewing comfort in the aisle zone, adjustable light modules; COB (Chip on Board) technology for maximum efficiency; efficient LEDs with very good colour rendering; IP40 protection glass available as an accessory; including attachment for linear alignment of the spotlights

Stromschienenstrahler aus Aluminium-druckguss in 2 verschiedenen Varianten (4-flammig bzw. 2x4-flammig) und mit 2 verschiedenen Lichtmodulen (für shelf floor washer und wall floor washer); Oberfläche pulverbeschichtet; Gangzonenstrahler mit speziellen Multi-Freiformflächenreflektoren mit Facettenoptik zur äußerst präzisen Lichtlenkung; punktgenaue Regal- und Gangzonenausleuchtung, optimale Längsentblendung für hohen Sehkomfort in der Gangzone, einstellbare Lichtmodule; COB (Chip on Board) Technologie für höchste Effizienz; effiziente LEDs mit sehr guter Farbwiedergabe; IP40-Schutzglas als Zubehör erhältlich; inklusive Aufsatz zur linearen Ausrichtung der Strahler

Quickinfo

3000K, 4000K
CRI ≥ 80, 3 SDCM
up to 134lm/W
L80 @ 50 000h
non DIM, DALI-2

Types

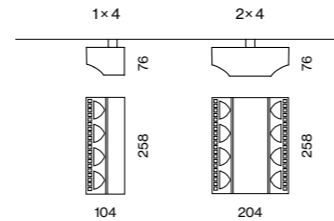

Colours



Light distributions

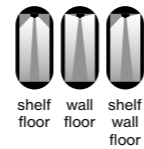

Order options

COLOUR TEMPERATURE	
3000K	5
4000K	6

CONTROL	
non DIM	1
DALI-2	3

MATERIAL COLOUR	
○ traffic white RAL 9016	7
● jet black RAL 9005	8

REFLECTOR	
shelf floor washer	S
wall floor washer	A
1x shelf / 1x wall floor washer*	B

*only for 2x4 lamps

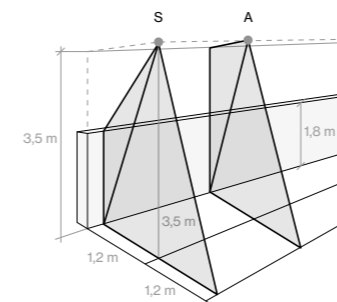

Light distributions

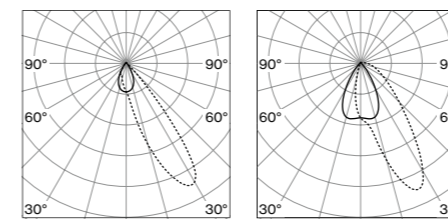

1x4 lamps shelf floor washer | 1x4 lamps wall floor washer

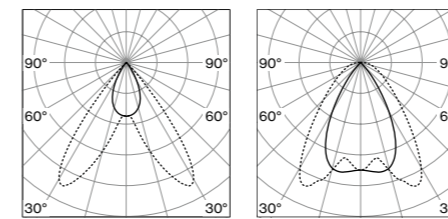

2x4 lamps shelf floor washer | 2x4 lamps wall floor washer

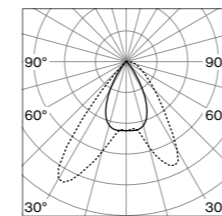

2x4 lamps 1x shelf / 1x wall floor washer

LUMINOUS FLUX value calculated for 4000K (3000K -5%), colour white, wall floor washer



DiiA® standards 251, 252, 253

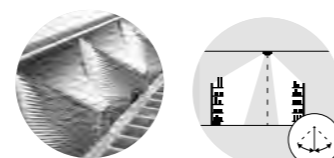

glare-free reflector longitudinally & transversely | +20° up to -15° tiltable

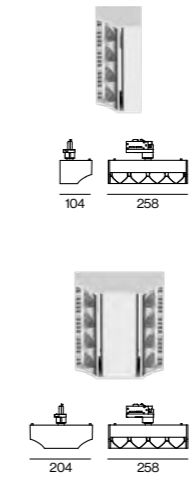

SQUADRO wallwasher track



1x4 LAMPS SINGLE-SIDED		ORDER CODE
SYSTEM POWER	LUMINOUS FLUX	149-2231
51W	6610lm	149-2231



2x4 LAMPS DOUBLE-SIDED		ORDER CODE
SYSTEM POWER	LUMINOUS FLUX	149-2240
86W	2x5760lm	149-2240
101W	2x6490lm	149-2241

Optical accessories

IP 40 PROTECTION GLASS

TYPE	ORDER CODE
1x4 lamps/single-sided	049-2930010
2x4 lamps/double-sided	049-2940010

Technical data

SQUADRO shelf floor washer, 1x4 lamps, +5° tilt, 51W, 3000K

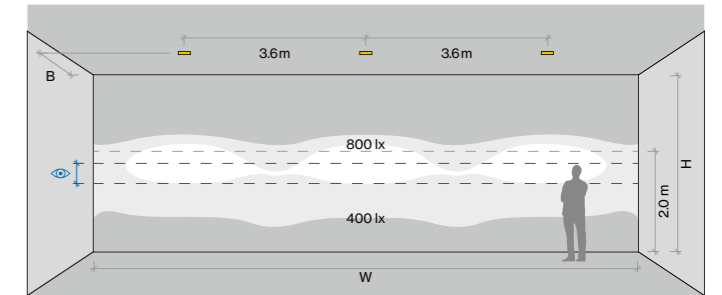

SQUADRO wall floor washer, 1x4 lamps, +5° tilt, 51W, 3000K

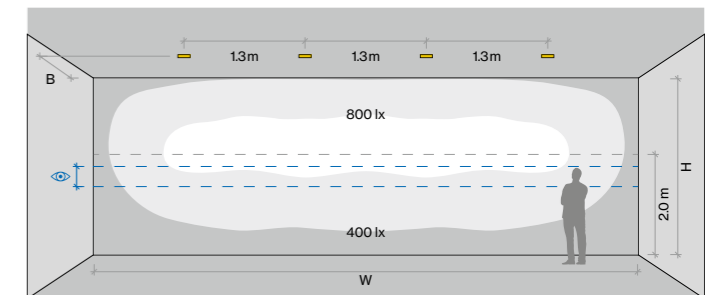

ROOM VALUES	CALCULATION SURFACE
Wall dimensions H = 3.5m W = 10.8m	Surface dimensions 10.8 x 3.5m
Distance to wall B = 1.3m	Surface height 0 - 3.5m
Aisle width 2.6m	
Reflection factor 0.7 0.7 0.2	Eye level 1.35m - 1.75m
Maintenance factor 0.9	

Jelmoli Store
Zurich, CH



Oasis Store Melbourne, AU –
by Sync Design

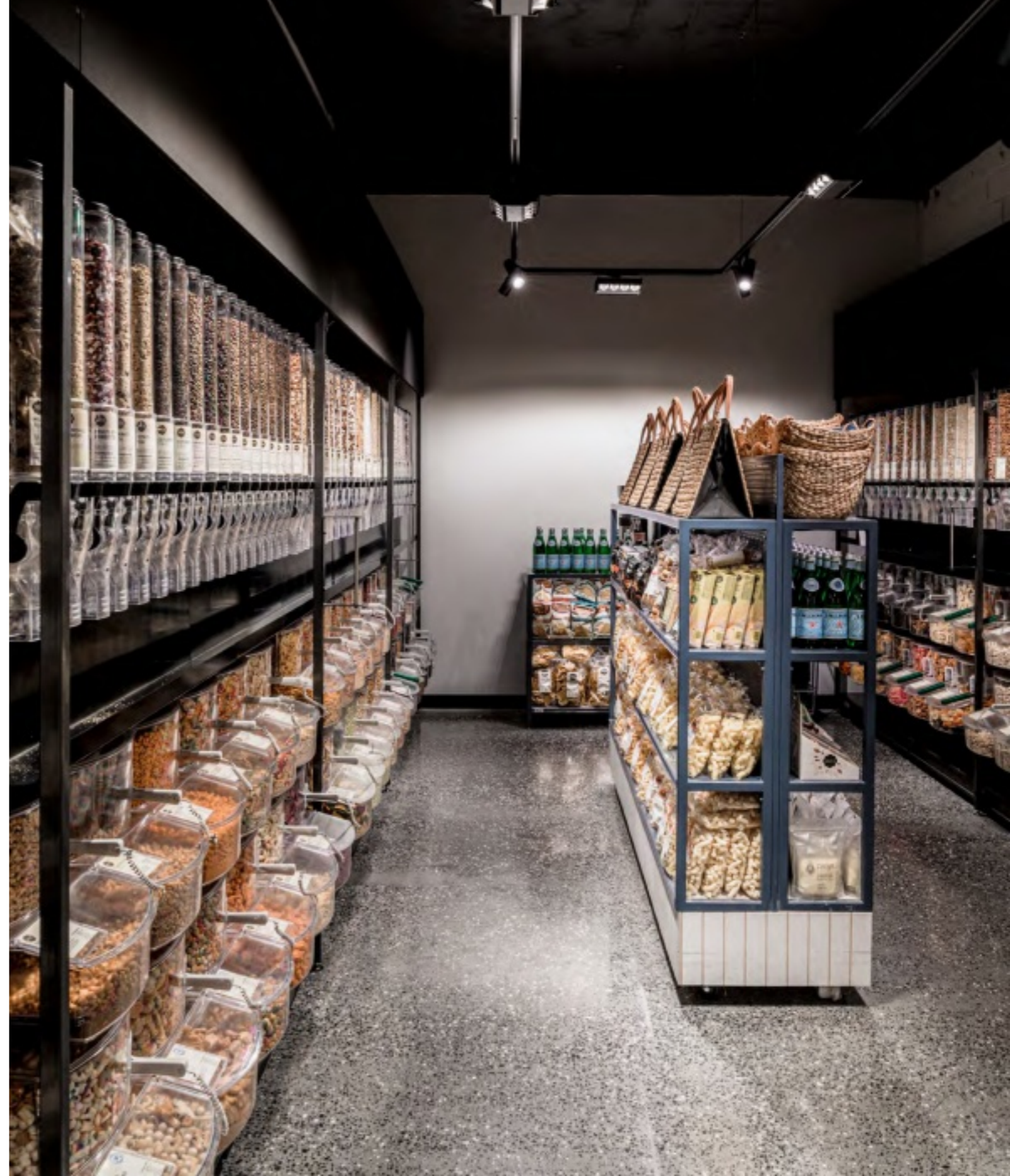

Sutterlüty Rankweil, AT –
by Hermann Kaufmann + Partner ZT GmbH



In the spotlight



BO

EN Beautiful design and flexibility distinguish the BO series of ceiling and track-mounted spotlights. Multiple sizes and different beam angles deliver great freedom in staging. The individual spotlights are available as semi-recessed or surface-mounted variants or as single or dual-lamp spotlights in an elegant base with an integrated driver, as well as track-mounted spotlights. Different housing and light colours (2700 K, 3000 K, or 4000 K) offer flexibility in different architectural concepts, and different versions promise excellent colour rendering with up to $\text{CRI} \geq 95$ (2-SDCM). The spots can be rotated up to 360° and swivelled 90° , making BO an ideal spotlight for shops and display areas.

DE Formschön und flexibel: das zeichnet die Decken- sowie Stromschienenstrahlerserie BO aus. Durch mehrere Größen und verschiedene Ausstrahlwinkel haben Sie große Freiheit bei der Inszenierung. Die Einzelstrahler sind als Halbeinbau- oder Anbauvariante und als ein- oder zweiflämmiger Strahler in einem eleganten Gehäuse mit integriertem Driver sowie als Stromschienenstrahler erhältlich. Verschiedene Gehäuse- und Lichtfarben (2700 K, 3000 K oder 4000 K) bieten Flexibilität in unterschiedlichen architektonischen Konzepten und versprechen eine sehr gute Farbwiedergabe von bis zu $\text{CRI} \geq 95$ (2-SDCM). Die Spots sind bis zu 360° dreh- und 90° schwenkbar und machen BO zu einem idealen Strahler für Shops und Präsentationsflächen.

Types



32 45 55 70

Mountings

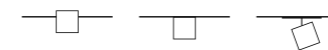

semi-recessed surface track

Light distribution

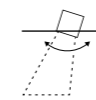

spotlight

Matched proportions

EN Elegance in the right measure: All BO product family spotlights are characterised by their decorative and simple aesthetics. Thanks to their reduced design and precisely coordinated proportions, all BO models can be combined with each other.

DE Eleganz im richtigen Maß: Alle Strahler der BO Produktfamilie zeichnen sich durch ihre dekorative und schlichte Ästhetik aus. Dank ihres reduzierten Designs und den exakt aufeinander abgestimmten Proportionen sind sämtliche BO-Varianten miteinander kombinierbar.



Colour variety

EN BO is available in standard white and black. For even more design freedom, additional colour options are available so that you can tailor BO to your individual project. Learn more about our colour palette at xal.com/colours.

DE BO ist in den Standardfarben Weiß und Schwarz erhältlich. Für noch mehr Gestaltungsfreiraum stehen weitere Farbvarianten zur Verfügung – so können Sie BO Ihrem individuellen Projekt anpassen. Mehr zu unserer Farbpalette erfahren Sie auf xal.com/colours.



xal.com/colours

Intrack

EN Flexible adjustment – easy installation: In the track version, BO combines different sizes and beam angles. Thus, ever new lighting scenarios can be implemented: from the selective presentation of goods and products to the staging of art objects and home accessories. The converter disappears elegantly into the track.

DE Flexible Adjustierung – einfache Montage: In der Track-Variante vereint BO unterschiedliche Größen und Ausstrahlwinkel. So lassen sich immer wieder neue Lichtszenierungen realisieren: von der punktuellen Waren- und Produktpräsentation bis zur Inszenierung von Kunstobjekten und Wohnaccessoires. Der Konverter verschwindet elegant in der Schiene.



Flexible adjustment

EN BO adapts to the requirements to ensure that objects are presented in the best possible light. The spotlight comes in different beam angles and is rotatable by at least 360°, as well as 90° tiltable.

DE Damit Objekte bestmöglich in Szene gesetzt sind, passt sich BO den Anforderungen an. Der Strahler ist nicht nur in verschiedenen Ausstrahlwinkeln verfügbar sondern auch um mindestens 360° dreh- sowie 90° schwenkbar.

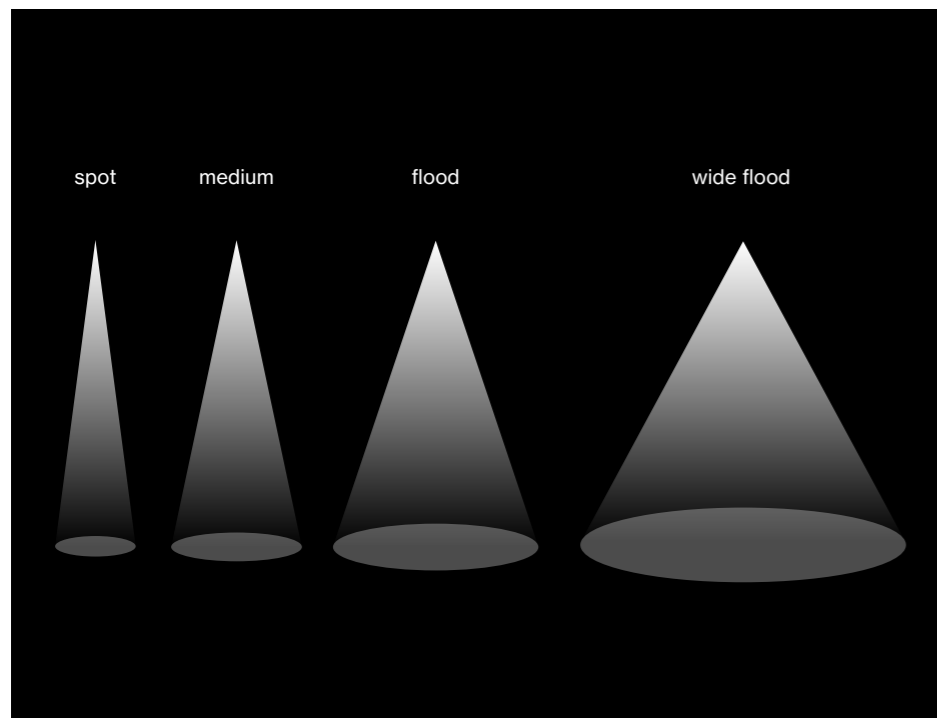

Variety

EN The individual spotlights are available as semi-recessed or surface-mounted versions or as single or double-flame spotlights in an elegant housing. Different housing and light colours (2700 K, 3000 K, or 4000 K) offer flexibility for unique projects.

DE Die Einzelstrahler sind als Halbeinbau- oder Anbauvariante bzw. als ein- oder zweiflammiger Strahler in einem eleganten Gehäuse erhältlich. Verschiedene Gehäuse- und Lichtfarben (2700 K, 3000 K oder 4000 K) bieten Flexibilität für einzigartige Projekte.

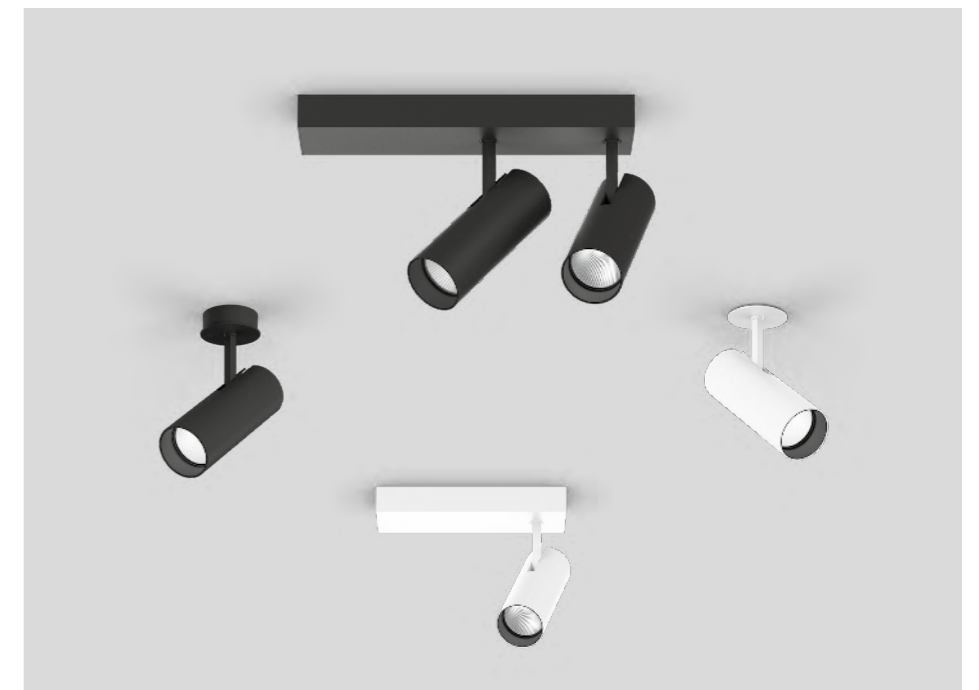

← back



BO 32/45/55

semi-recessed / surface

EN Cylindrical spotlight made of aluminium; surface powder coated; either with surface mounted housing or as ceiling recessed variant; spotlight head 350° rotatable and 90° tiltable; high-quality, aluminium, vapour deposition coated reflector with faceted design; precise radiation characteristics with different beam angles; good glare reduction due to recessed light point plane; optical attachments as accessories; COB (Chip on Board) technology for maximum efficiency; no multiple shadows; energy-efficient LEDs with very good colour rendering

DE Zylindrischer Strahler aus Aluminium; Oberfläche pulverbeschichtet; wahlweise mit Anbaueinheit oder als Deckeneinbauvariante; Strahlerkopf 350° dreh- und 90° schwenkbar; hochwertiger, aluminiumbedampfter Reflektor mit Facettenoptik; präzise Abstrahlcharakteristik mit verschiedenen Ausstrahlwinkeln; gute Entblendung durch zurückversetzte Lichtpunktebene; optische Aufsätze als Zubehör; mit COB (Chip on Board) Technologie für höchste Effizienz; keine Bildung von Mehrfachschatten; energieeffiziente LEDs mit sehr guter Farbwiedergabe

Quickinfo

2700 K, 3000 K
 CRI ≥ 90, 2 SDCM
 BO 32 up to 91 lm/W
 BO 45 up to 103 lm/W
 BO 55 up to 92 lm/W
 L80 @ 50 000 h
 non DIM, DALI-2

Types

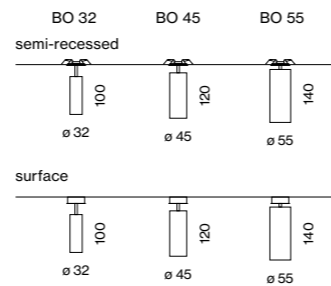

Colours



Light distributions



Order options

MOUNTING

semi-recessed ceiling clip	1
surface housing	2

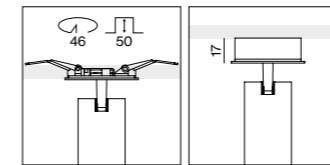

COLOUR TEMPERATURE

2700 K	4
3000 K	5

MATERIAL COLOUR

○ traffic white RAL 9016	7
● jet black RAL 9005	8
● special colours* p. 992	X

*canopy always in white

BEAM ANGLE BO 32

spot 18°	S
medium 23°	M
flood 37°	F

BEAM ANGLE BO 45

super spot 8°	V
spot 14°	S
medium 24°	M
flood 39°	F

BEAM ANGLE BO 55

spot 17°	S
medium 23°	M
flood 37°	F

Options on request

COLOUR RENDERING INDEX

CRI ≥ 95, 2 SDCM	
------------------	--

COLOUR TEMPERATURE

4000 K	
--------	--

CONTROL

Casambi	
---------	--

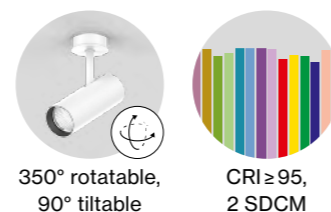
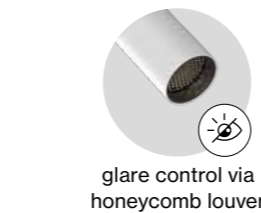

LUMINOUS FLUX value calculated for 3000 K, colour white, reflector flood 2700 K -6%

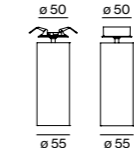
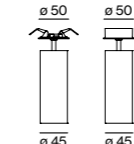
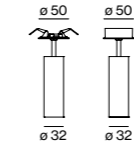

BO 32 semi-recessed / surface



ADJUSTABLE

INSET POWER	LUMINOUS FLUX	ORDER CODE
8.8 W 36 Vf 250 mA	755 lm	0 4 9 - 6 5 2 0 :: 1 ▣ ▲

BO 45 semi-recessed / surface



ADJUSTABLE

INSET POWER	LUMINOUS FLUX	ORDER CODE
6.1 W 11 Vf 400 mA	super spot 297 lm	0 4 9 - 6 5 3 0 :: 1 ▣ V
12.8 W 37 Vf 350 mA	spot 1030 lm	0 4 9 - 6 5 3 0 :: 1 ▣ S
13.5 W 36 Vf 400 mA	medium, flood 1320 lm	0 4 9 - 6 5 3 0 :: 1 ▣ ▲

BO 55 semi-recessed / surface



ADJUSTABLE

INSET POWER	LUMINOUS FLUX	ORDER CODE
21.1 W 36 Vf 600 mA	1850 lm	0 4 9 - 6 5 4 0 :: 1 ▣ ▲

Electrical accessories

POWER SUPPLY 220-240 V AC, 50-60 Hz, PC II

TYPE	EFFICIENCY	L-W-H (mm)	ORDER CODE
250 mA non DIM	η 80 %	65-39-20	0 0 2 - 9 0 7 4 2
250 mA DALI-2	η 82 %	166-30-22	0 0 2 - 9 0 7 4 3
350 mA non DIM	η 85 %	180-30-21	0 0 2 - 9 0 7 2 2
350 mA DALI-2	η 83 %	210-30-21	0 0 2 - 9 0 7 2 3
400 mA non DIM	η 88 %	180-30-21	0 0 2 - 9 0 7 2 4
400 mA DALI-2	η 84 %	210-30-21	0 0 2 - 9 0 7 2 5
600 mA non DIM	η 87 %	210-30-21	0 0 2 - 9 0 7 2 6
600 mA DALI-2	η 85 %	210-30-21	0 0 2 - 9 0 7 2 7

for surface versions revision opening required

DIN RAIL COMPONENTS

TYPE	W-H-D (mm)	ORDER CODE
POWER SUPPLY 220-240 V AC	90-90-60	0 0 5 - 6 5 2 0 2 1 0
96 W 48 V DC constant voltage		
LED DRIVER DALI-2 DT6 1-2 addr.	36-88-59	0 0 5 - 6 1 2 1 0 3 0
200-1050 mA settable const. current		
2 x 42 W 48 V DC U _{OUT} 10-40 V		

for more details and components see page 981

Optical accessories

HONEYCOMB LOUVER

TYPE	Ø-H (mm)	ORDER CODE
BO 32	30-3	0 0 7 - 1 9 6 5 1 6 8
BO 45	42-3	0 0 7 - 1 9 6 5 1 8 8
BO 55	50-3	0 0 7 - 1 9 6 5 5 9 8

Complexe des opérations Payerne CH –
by op-arch, Oester Pfenninger, Ulrich
Weiz including lighting design





Einrichtungshaus Grimm
Göppingen, DE –
by Studio Komo





BO 45 base surface

EN Cylindrical spotlight made of aluminium; surface powder coated; spotlight head 350° / 330° (1 lamp / 2 lamps) rotatable and 90° tiltable; choice of single lamp or double lamps; surface mounted housing in aluminium incl. converter; mounting plate with pre-assembled converter unit can be pre-mounted; luminaire housing can be attached without tools by interlock; high-quality, aluminium, vapour deposition coated reflector with faceted design; precise radiation characteristics with different beam angles; good glare reduction due to recessed light point plane; optical attachments as accessories; COB (Chip on Board) technology for maximum efficiency; no multiple shadows; energy-efficient LEDs with very good colour rendering

DE Zylindrischer Strahler aus Aluminium; Oberfläche pulverbeschichtet; Strahlerkopf 350° / 330° (1-flammig / 2-flammig) dreh- und 90° schwenkbar; wahlweise einflammig oder zweiflammig; Anbaueinheit aus Aluminium inkl. Konverter; Montageplatte mit vormontierter Konvertereinheit vorab montierbar; Leuchtenkörper mittels Verriegelung werkzeuglos aufsetzbar; hochwertiger, aluminiumbedampfter Reflektor mit Facettenoptik; präzise Abstrahlcharakteristik mit verschiedenen Ausstrahlwinkeln; gute Entblendung durch zurückversetzte Lichtpunktebene; optische Aufsätze als Zubehör; mit COB (Chip on Board) Technologie für höchste Effizienz; keine Bildung von Mehrfachschatten; energieeffiziente LEDs mit sehr guter Farbwiedergabe

Quickinfo

2700 K, 3000 K
CRI ≥ 90, 2 SDCM
1 lamp up to 86 lm/W
2 lamps up to 96 lm/W
L80 @ 50 000 h
non DIM, DALI-2

Types

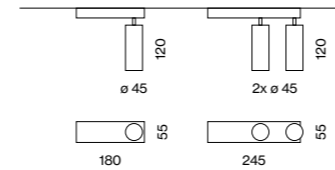

Colours



Light distributions

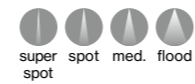

Order options

COLOUR TEMPERATURE	
2700 K	4
3000 K	5

CONTROL	
non DIM	1
DALI-2	3

MATERIAL COLOUR	
○ traffic white RAL 9016	7
● jet black RAL 9005	8
● special colours* p. 992	X

*base always in white

BEAM ANGLE	
super spot 8°	V
spot 14°	S
medium 24°	M
flood 39°	F

Options on request

COLOUR RENDERING INDEX
CRI ≥ 95, 2 SDCM

COLOUR TEMPERATURE
4000 K

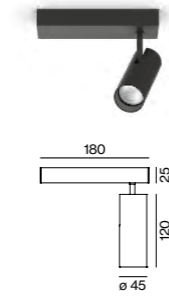

BO 45 base surface



1 LAMP

SYSTEM POWER	LUMINOUS FLUX	ORDER CODE
7.2 W	super spot 297 lm	0 4 9 - 6 3 3 0 :: ▽ ▽ V
15.1 W	spot 1030 lm	0 4 9 - 6 3 3 0 :: ▽ ▽ S
15.9 W	medium, flood 1310 lm	0 4 9 - 6 3 3 0 :: ▽ ▽ ▲

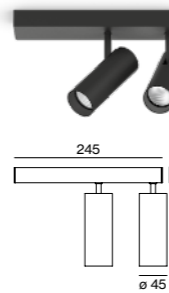

BO 45 base surface



2 LAMPS

SYSTEM POWER	LUMINOUS FLUX	ORDER CODE
14.4 W	super spot 2 × 297 lm	0 4 9 - 6 4 3 0 :: ▽ ▽ V
30 W	spot 2 × 1030 lm	0 4 9 - 6 4 3 0 :: ▽ ▽ S
27.5 W	medium, flood 2 × 1220 lm	0 4 9 - 6 4 3 0 :: ▽ ▽ ▲

Optical accessories

HONEYCOMB LOUVER

TYPE	Ø-H (mm)	ORDER CODE
BO 45	42-3	0 0 7 - 1 9 6 5 1 8 8



glare control via
honeycomb louver



350° rotatable,
90° tiltable

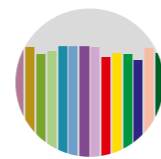

CRI ≥ 95,
2 SDCM

LUMINOUS FLUX value calculated for 3000 K, CRI ≥ 90, colour white, flood 2700 K -6%

möbelbau breithaler gmbh
Leibnitz, AT – by möbelbau
breithaler gmbh



Quickinfo

2700 K, 3000 K, 4000 K
 CRI ≥ 90, 2 SDCM
 BO 32 up to 69 lm/W
 BO 45 up to 87 lm/W
 BO 55 up to 78 lm/W
 L80 @ 50 000 h
 non DIM, DALI-2

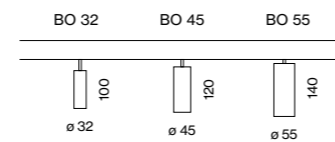
Types**Colours****Light distributions****Order options**

COLOUR TEMPERATURE	☼☼
2700 K	4
3000 K	5
4000 K	6

CONTROL	⬆️⬆️
non DIM	1
DALI-2	3

MATERIAL COLOUR

○ traffic white RAL 9016	7
● jet black RAL 9005	8
🌈 special colours p.992	X

BEAM ANGLE BO 32

spot 18°	S
medium 23°	M
flood 37°	F

BEAM ANGLE BO 45

super spot 8°	V
spot 14°	S
medium 24°	M
flood 39°	F

BEAM ANGLE BO 55

spot 17°	S
medium 23°	M
flood 37°	F

Options on request**COLOUR RENDERING INDEX**

CRI ≥ 95, 2 SDCM

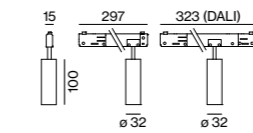
**BO 32 intrack****TRACK LIGHT**

SYSTEM POWER	LUMINOUS FLUX	ORDER CODE
11.7 W	755 lm	180-71111 ☼☼ ⬆️⬆️

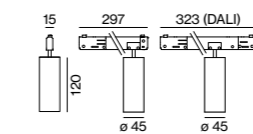
**BO 45 intrack****TRACK LIGHT**

SYSTEM POWER	LUMINOUS FLUX	ORDER CODE
6.1 W	super spot 297 lm	180-72111 ☼☼ ⬆️⬆️ V
15.1 W	spot 1030 lm	180-72111 ☼☼ ⬆️⬆️ S
15.9 W	medium, flood 1320 lm	180-72111 ☼☼ ⬆️⬆️

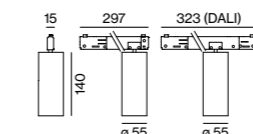
**BO 55 intrack****TRACK LIGHT**

SYSTEM POWER	LUMINOUS FLUX	ORDER CODE
24.8 W	1840 lm	180-73111 ☼☼ ⬆️⬆️

Optical accessories**HONEYCOMB LOUVER**

TYPE	Ø H (mm)	ORDER CODE
BO 32	30·3	007-1965168
BO 45	42·3	007-1965188
BO 55	50·3	007-1965598

BO 32/45/55

intrack

EN Track light made of die-cast aluminium; surface powder coated; spotlight head rotates 360° and tilts 90°; converter integrated in the power track adapter; high-quality, aluminium, vapour deposition coated reflector with faceted design; precise radiation characteristics with different beam angles; good glare reduction due to recessed light point plane; optical attachments as accessories; COB (Chip on Board) technology for maximum efficiency; no multiple shadows; energy-efficient LEDs with very good colour rendering; adapter for toolless insertion or movement on a variety of 3-phase power tracks; adapter flush with the power track

DE Stromschiene Strahler aus Aluminiumdruckguss; Oberfläche pulverbeschichtet; Strahlerkopf 360° dreh- und 90° schwenkbar; Konverter im Stromschiene-Adapter integriert; hochwertiger, aluminiumbedampfter Reflektor mit Facettenoptik; präzise Abstrahlcharakteristik mit verschiedenen Ausstrahlwinkeln; gute Entblendung durch zurückversetzte Lichtpunktebene; optische Aufsätze als Zubehör; mit COB (Chip on Board) Technologie für höchste Effizienz; keine Bildung von Mehrfachschatten; energieeffiziente LEDs mit sehr guter Farbwiedergabe; Adapter für werkzeugloses Einsetzen bzw. Verschieben in verschiedenen 3-Phasen Stromschiene; Adapter bündig mit Stromschiene abschließend



glare control via honeycomb louver



360° rotatable, 90° tiltable



CRI ≥ 95, 2 SDCM

LUMINOUS FLUX value calculated for 3000 K, CRI ≥ 90, colour white, flood 2700 K -5%, 4000 K +7%



Oberpollinger | The KaDeWe Group
Munich, DE – by Licht Kunst Licht AG
including lighting design



Optiek Sagaert Zwevegem BE –
by Courtois & Châtelain and
Entirus Group



Quickinfo

3000K, 4000K
 CRI ≥ 90 2-SDCM
 up to 87lm/W
 L80 @ 50 000h
 non DIM, DALI-2

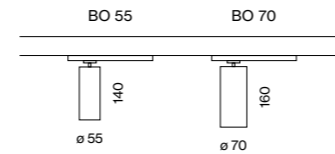
Types**Colours****Light distributions**

BO 55



BO 70

**Order options**

COLOUR TEMPERATURE	☼☼☼
3000K	5
4000K	6

CONTROL	⬆️⬆️
non DIM	1
DALI-2	3

MATERIAL COLOUR	☑️
○ traffic white RAL 9016	7
● jet black RAL 9005	8

BEAM ANGLE BO 55	▲
spot 17°	S
medium 24°	M
flood 40°	F

BEAM ANGLE BO 70	▲
spot 15°	S
medium 23°	M
flood 37°	F
wide flood 57°	W

Options on request

COLOUR RENDERING INDEX	
CRI ≥ 95, 2 SDCM	

CONTROL

Casambi

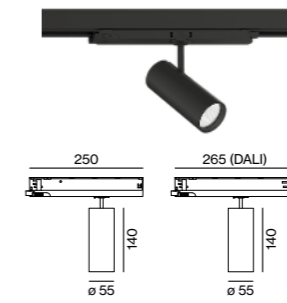
**BO 55 track****TRACK LIGHT**

SYSTEM POWER	LUMINOUS FLUX	ORDER CODE
24.8 W	2150 lm	1 8 0 - 7 3 1 2 :: ⬆️⬆️ ▲

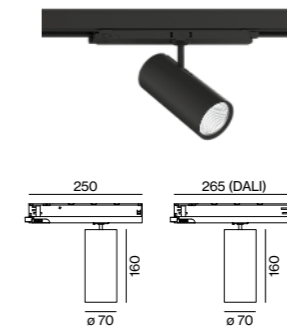
**BO 70 track****TRACK LIGHT**

SYSTEM POWER	LUMINOUS FLUX	ORDER CODE
40 W	3410 lm	1 8 0 - 7 4 1 1 :: ⬆️⬆️ ▲

Optical accessories**HONEYCOMB LOUVER**

TYPE	Ø H (mm)	ORDER CODE
BO 55	50-3	0 0 7 - 1 9 6 5 5 9 8
BO 70	61-3	0 8 0 - 5 9 0 0 0 1 8

BO 55/70

track

EN Track light made of die-cast aluminium; surface powder coated; spotlight head 355° rotatable and 90° tiltable; converter integrated in the power track adapter; high-quality, aluminium, vapour deposition coated reflector with faceted design; precise radiation characteristics with different beam angles; good glare reduction due to recessed light point plane; optical attachments as accessories; COB (Chip on Board) technology for maximum efficiency; no multiple shadows; energy-efficient LEDs with very good colour rendering; adapter for toolless insertion or movement on a variety of 3-phase power tracks

DE Stromschienenstrahler aus Aluminium-druckguss; Oberfläche pulverbeschichtet; Strahlerkopf 355° dreh- und 90° schwenkbar; Konverter im Stromschienen-Adapter integriert; hochwertiger, aluminiumbedampfter Reflektor mit Facettenoptik; präzise Abstrahlcharakteristik mit verschiedenen Ausstrahlwinkeln; gute Entblendung durch zurückversetzte Lichtpunktebene; optische Aufsätze als Zubehör; mit COB (Chip on Board) Technologie für höchste Effizienz; keine Bildung von Mehrfachschatten; energieeffiziente LEDs mit sehr guter Farbwiedergabe; Adapter für werkzeugloses Einsetzen bzw. Verschieben in verschiedenen 3-Phasen Stromschienen



glare control via honeycomb louver



355° rotatable, 90° tiltable



CRI ≥ 90, 2 SDCM

LUMINOUS FLUX value calculated for 3000K, CRI ≥ 90, colour white, flood 4000K +5%

Shop SVNTY Antwerp, BE –
by Verhamme de vel Architecten
with lighting design by Electro Govaerts



Universal expert



VARO

EN As a track-mounted spotlight, VARO focuses on the essentials and can be used universally. It is available in two different sizes and, thanks to its 355° rotation and 90° swivelling capability, is extremely flexible in use. This flexibility is supported by the fact that the spotlights can be inserted and moved along the track without tools. It is ideal for use in shops whose interior design is continually evolving. The high-quality reflector from VARO ensures a particularly precise beam characteristic at different angles, all with an excellent colour rendering up to $\text{CRI} \geq 95$. Depending on the desired spatial effect, you can choose between the 3000 K and 4000 K light colours.

DE Als Stromschiene Strahler fokussiert VARO auf das Wesentliche und ist universell einsetzbar. Er ist in zwei verschiedenen Größen verfügbar und durch 355° Dreh- und 90° Schwenkbarkeit höchst beweglich im Einsatz. Unterstützt wird diese Flexibilität durch werkzeugloses Einsetzen und Verschieben der Strahler in der Stromschiene: ideal für den Einsatz in Shops, deren Innenarchitektur sich immer wieder verändert. Der hochwertige Reflektor von VARO sorgt für eine besonders präzise Abstrahlcharakteristik in verschiedenen Winkeln – und das bei sehr guter Farbwiedergabe von bis zu $\text{CRI} \geq 95$. Je nach gewünschter Raumwirkung haben Sie die Wahl zwischen den Lichtfarben 3000 K und 4000 K.

Types



80



110

Mounting



track

Light distribution



spotlight

← back



VARO 80 S

track

EN Track light made of die-cast aluminium; surface powder coated; spotlight head 355° rotatable and 90° tiltable; integrated converter in the plastic adapter; high quality reflector with spherical facet finish; precise radiation characteristics with different beam angles; installed and exchanged without tools; optical attachments as accessories; optical attachments can be combined; COB (Chip on Board) technology for maximum efficiency; no multiple shadows; energy-efficient LEDs with very good colour rendering; adapter for toolless insertion or movement on a variety of 3-phase power tracks

DE Stromschienenstrahler aus Aluminium-druckguss; Oberfläche pulverbeschichtet; Strahlerkopf 355° dreh- und 90° schwenkbar; Konverter im Kunststoffadapter integriert; hochwertiger Reflektor mit sphärischer Facetenoptik; präzise Abstrahlcharakteristik mit verschiedenen Ausstrahlwinkeln; werkzeuglos einsetz- bzw. austauschbar; optische Aufsätze als Zubehör; optische Aufsätze miteinander kombinierbar; mit COB (Chip on Board) Technologie für höchste Effizienz; keine Bildung von Mehrfachschatten; energieeffiziente LEDs mit sehr guter Farbwiedergabe; Adapter für werkzeugloses Einsetzen bzw. Verschieben in verschiedenen 3-Phasen Stromschienen

Quickinfo

3000K, 4000K
 CRI ≥ 90, 3 SDCM
 up to 91lm/W
 L80/50 000h
 non DIM, DALI-2

Type

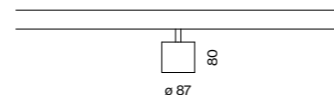

Colours



Light distributions



Order options

COLOUR TEMPERATURE	
3000K	0
4000K	1

CONTROL	
non DIM	1
DALI-2	3

MATERIAL COLOUR	
○ traffic white RAL 9016	7
● jet black RAL 9005	8

BEAM ANGLE	
spot 17°	S
medium 28°	M
flood 38°	F

Options on request

COLOUR RENDERING INDEX	
CRI ≥ 80	

CONTROL	
Casambi	

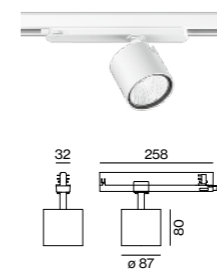

VARO 80 S track



TRACK LIGHT

SYSTEM POWER	LUMINOUS FLUX	ORDER CODE
28.5W	2600lm	180-6420
45W	3610lm	180-6421

Optical accessories

LENSES AND HONEYCOUMB LOUVER

TYPE	Ø H (mm)	ORDER CODE
linear prismatic lens	75.9	080-6402110P
honeycomb louver	75.9	080-6401118

SNOOT

TYPE	Ø H (mm)	ORDER CODE
short	66.23	080-6403118
medium	66.38	080-6403218
angle	66.38	080-6403318

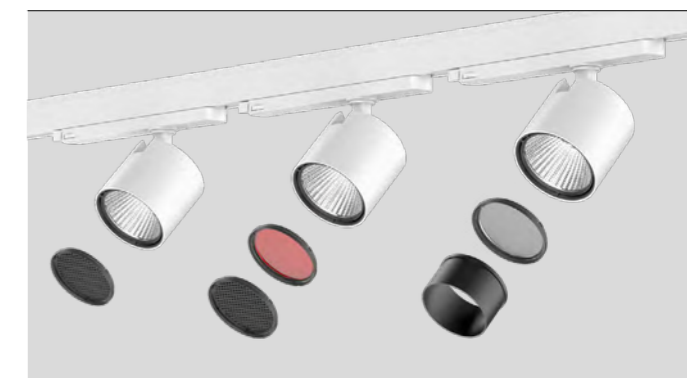
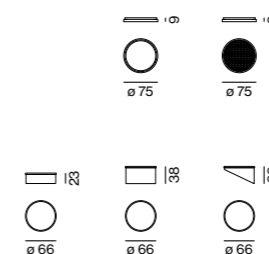

possibility to combine different optical accessories (max. 2 pieces)

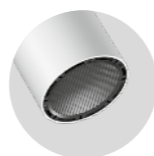

optical accessories



combine 2 optical accessories



355° rotatable, 90° tiltable

LUMINOUS FLUX value calculated for 3000K, CRI ≥ 90, colour white, flood 4000K +8%

s.Oliver Store Munich, DE –
by Kitzig Interior Design GmbH
including lighting design





Feucht Mode Innsbruck, AT –
by blocher partners with lighting design by
Hailight Lichtplanung, Andreas Haidegger



back



VARO 80/110

track

EN Track spotlight in die-cast aluminium, available in 2 different sizes; surface powder coated; spotlight head 355° rotatable and 90° tiltable; converter installed in aluminium spotlight housing; high quality reflector with spherical facet finish; precise radiation characteristics with different beam angles; installed and exchanged without tools; optical attachments as accessories; COB (Chip on Board) technology for maximum efficiency; no multiple shadows; energy-efficient LEDs with very good colour rendering; adapter for toolless insertion or movement on a variety of 3-phase power tracks

DE Stromschienstrahler aus Aluminiumdruckguss in 2 verschiedenen Größen; Oberfläche pulverbeschichtet; Strahlerkopf 355° dreh- und 90° schwenkbar; Konverter im Strahlergehäuse aus Aluminium verbaut; hochwertiger Reflektor mit sphärischer Facettenoptik; präzise Abstrahlcharakteristik mit verschiedenen Ausstrahlwinkeln; werkzeuglos einsetz- bzw. austauschbar; optische Aufsätze als Zubehör; mit COB (Chip on Board) Technologie für höchste Effizienz; keine Bildung von Mehrfachschatten; energieeffiziente LEDs mit sehr guter Farbwiedergabe; Adapter für werkzeugloses Einsetzen bzw. Verschieben in verschiedenen 3-Phasen Stromschielen

Quickinfo

3000K, 4000K
CRI ≥ 90, 3 SDCM
VARO 80 up to 95lm/W
VARO 110 up to 100lm/W
L80/50 000h
non DIM

Types

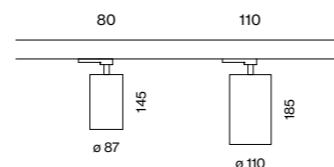

Colours



Light distributions



Order options

COLOUR TEMPERATURE	☼☼☼
3000K	5
4000K	6

CONTROL

non DIM

MATERIAL COLOUR

○ traffic white RAL 9016	7
● jet black RAL 9005	8

BEAM ANGLE

VARO 80	▲
spot 17°	S
medium 28°	M
flood 38°	F

BEAM ANGLE

VARO 110	▲
spot 14°	S
medium 24°	M
flood 33°	F

Options on request

COLOUR RENDERING INDEX
CRI ≥ 95 2-SDCM

SPECIAL COLOUR RENDERING

vogue	CRI ≥ 90
gallery	CRI 98
gourmet	CRI ≥ 80
fresh meat & fish	CRI ≥ 80
pastry	CRI ≥ 80
brilliant white	CRI ≥ 90

REFLECTOR

wide flood 67°
only for VARO 110



355° rotatable,
90° tiltable



CRI ≥ 95
2 SDCM

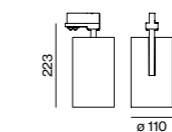
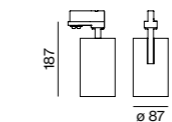

VARO 80 track



TRACK LIGHT

SYSTEM POWER	LUMINOUS FLUX	ORDER CODE
29 W	2700 lm	080-6210::1▲

VARO 110 track



TRACK LIGHT

SYSTEM POWER	LUMINOUS FLUX	ORDER CODE
42 W	4210 lm	080-6120::1▲

Optical accessories

SNOOT WITH HONEYCOMB LOUVER

TYPE	Ø H (mm)	ORDER CODE
VARO 80	83-9	006-93120
VARO 110	106-9	006-93130

LUMINOUS FLUX value calculated for 3000K, CRI ≥ 90, colour white, flood 4000K +5%



Kastner & Öhler, Kaufhaus Tyrol Innsbruck, AT –
by DIOMA AG / WHIR3 / K&Ö Bauabteilung with
lighting design by VEDDER.LICHTMANAGEMENT



Porsche Studio Saigon, VN –
by Kobi Lighting Studio



Known for his expressive colours



PABLO

EN The PABLO track-mounted spotlight was developed especially for museums. With a colour rendering index of up to $CRI \geq 95$, it illuminates works of art with near-perfect colour reproduction. The Colour Tune variant compensates for age-related colour changes in paintings with increased and customisable red-blue saturation. PABLO is fixed in the tracks without tools, and the spotlight heads can be rotated, swivelled, and repositioned almost at will. PABLO focus's beam angle is also adjustable. The iris, shutter, and gobo versions create sharp-edged light cut-outs in various shapes to stage works of art even more excitingly. The multilens version of PABLO has five attachment lenses that can be exchanged without tools depending on the required beam pattern. The mood of the room can be influenced by using the Tunable White version to change light colours.

DE Der Stromschieneenstrahler PABLO wurde speziell für Museen entwickelt. Mit einem Farbwiedergabeindex von bis zu $CRI \geq 95$ beleuchtet er Kunstwerke nahezu farbecht. In der Colour-Tune-Variante werden außerdem alterungsbedingte Farbveränderungen an Gemälden durch eine erhöhte, individuell einstellbare Rot-Blau-Sättigung kompensiert. PABLO wird werkzeuglos in den Schienen fixiert, die Strahlerköpfe lassen sich nahezu beliebig drehen, schwenken und neu positionieren. Bei PABLO Focus kann zusätzlich der Abstrahlwinkel variiert werden. Die Varianten Iris, Shutter und Gobo kreieren scharfkantige Lichtausschnitte in unterschiedlichen Formen, um Kunstwerke noch spannender zu inszenieren. Die Multilens-Ausführung von PABLO besitzt fünf Vorsatzlinsen, die je nach benötigter Abstrahlcharakteristik werkzeuglos ausgetauscht werden können. Durch veränderbare Lichtfarben als Tunable White Option kann zudem die Stimmung im Raum beeinflusst werden.

Types

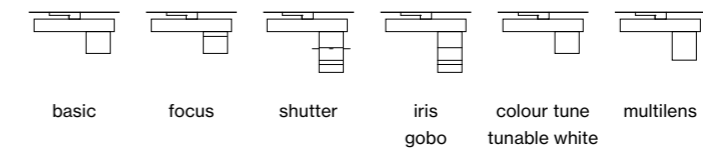

basic focus shutter iris gobo colour tune tunable white multilens

Mounting

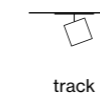

track

Light distribution

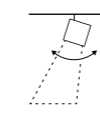

spotlight

PABLO multilens

EN PABLO's multilens design lets the beam characteristics be flexibly adjusted depending on the application. For this purpose, there are five ancillary lenses that can be easily exchanged without tools. Objects are thus staged in the best possible light and the staging of a room with changing interiors becomes feasible.

DE Mit der PABLO Multilens-Ausführung kann die Abstrahlcharakteristik je nach Anwendung flexibel angepasst werden. Dafür gibt es fünf Vorsatzlinsen, die einfach werkzeuglos ausgetauscht werden können. So werden Objekte bestmöglich in Szene gesetzt und die Inszenierung des Raumes bei wechselndem Interieur wird ermöglicht.

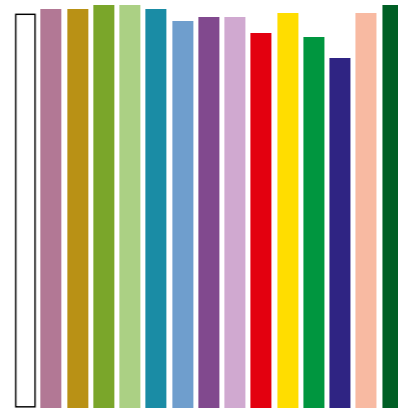

Authentic colours

EN Museum lighting must present exhibits authentically. PABLO illuminates works of art with near-perfect colour reproduction thanks to a colour rendering index of up to $CRI \geq 95$ and $R9 > 90$. Light colour and intensity can be controlled, allowing the lighting to be adapted to any new spatial setting.

DE Museumsbeleuchtung muss Exponate authentisch darstellen. Mit einem Farbwiedergabeindex von bis zu $CRI \geq 95$ und $R9 > 90$ beleuchtet PABLO Kunstwerke nahezu farbecht. Lichtfarbe und -intensität sind steuerbar, wodurch sich die Beleuchtung jeder neuen räumlichen Inszenierung anpassen lässt.

Light in form

EN PABLO's shutter, iris, and gobo variants create sharp-edged silhouettes in a square, round, or custom shape such as lettering. This means exhibits can be precisely custom-illuminated for maximum effect.

DE Die PABLO-Varianten Shutter, Iris und Gobo kreieren scharfkantige Silhouetten in viereckigen, runden oder individuell wählbaren Formen, wie z. B. Schriftzügen. Damit können Exponate exakt und zugeschnitten beleuchtet werden und maximal wirken.

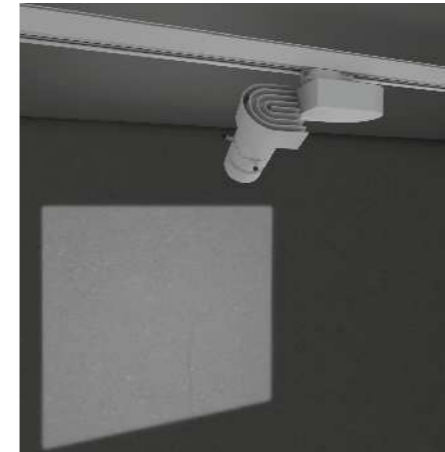

shutter

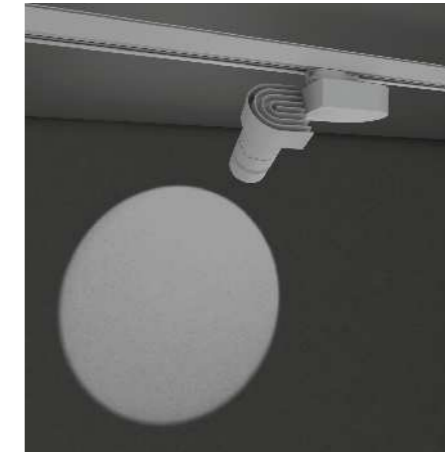

iris



gobo

Precise and variable

EN PABLO spots can be mounted and moved along the track without tools. The spotlight head can be fixed in any position without tools thanks to the special adapter fixing. This makes PABLO as precise as it is flexible, even after installation.

DE PABLO Spots lassen sich entlang der Stromschienen werkzeuglos montieren und verschieben. Dank der speziellen Adapterfixierung kann der Strahlerkopf werkzeuglos in jeder Position fixiert werden. Dadurch ist PABLO so präzise wie flexibel – auch nach seiner Installation.



Restored by light

EN PABLO Colour Tune was developed to faithfully revive historical art worthy of protection. A customisable red-blue saturation compensates, purely thanks to the lighting, for time-related colour damage. This gently reawakens a work of art's original colours.

DE Um historische und schützenswerte Kunst originalgetreu wiederzubeleben, wurde PABLO Colour Tune entwickelt. Eine individuell einstellbare Rot-Blau-Sättigung kompensiert zeitlich bedingte Farbschäden – rein durch die Beleuchtung. So werden die ursprünglichen Farben eines Kunstwerks schonend wiedererweckt.



Easy dimming

EN PABLO's DIM Poti variant has a manual dimming function. The brightness can be easily adjusted directly on-site at the spotlight head to suit the surroundings and the desired lighting mood.

DE In der DIM Poti-Variante verfügt PABLO über eine manuelle Dimmfunktion. So kann die Helligkeit einfach und direkt vor Ort am Strahlerkopf an ihre Umgebung und die gewünschte Lichtstimmung angepasst werden.

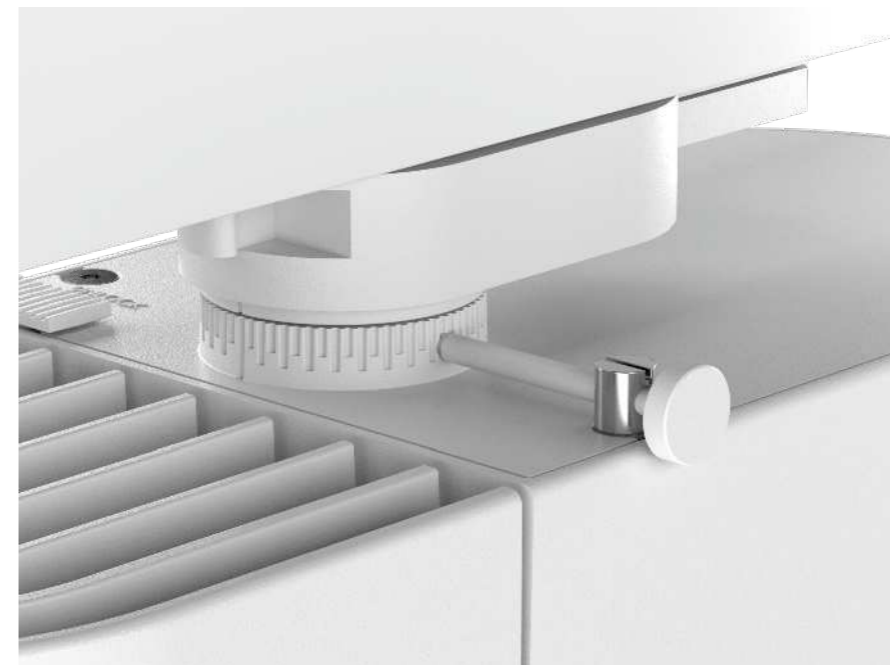

← back



PABLO basic/focus

track

EN Track light made of die-cast aluminium; powder coated; converter in spotlight housing; COB (Chip on Board) technology – maximum efficiency; no multiple shadows; energy-eff. LEDs – very good colour rendering; PABLO basic: sym./asym. radiation characteristic; PABLO focus: object focusing through adjustable lens; adjustable beam angle; PABLO shutter / iris: contour spotlight for rectangular or round shape – adjustment by 4 shading elements / by iris-shaped shade; toolless insertion or movement on a variety of 3-phase power tracks; adapter fixation optionally without tools by means of knurled screw or set screw (screwdriver required); point outlet, either in surface mounted housing or recessed housing, as an accessory

DE Stromschienenstrahler aus Aluminium-druckguss; pulverbeschichtet; Konverter im Strahlergehäuse; COB (Chip on Board) Technologie – höchste Effizienz; keine Mehrfachschatten; energieeff. LEDs – sehr gute Farbwiedergabe; PABLO basic: sym./asym. strahlend; PABLO focus: Objekt-Fokussierung durch justierbare Linse; Ausstrahlwinkel einstellbar; PABLO shutter / iris: Konturstrahler für rechteckige / runde Formgebung – Einstellung durch 4 Abschattenelemente / durch irisförmige Abschatter; werkzeugloses Einsetzen bzw. Verschieben in versch. 3-Phasen Stromschienen; Adapter-Fixierung wahlweise werkzeuglos mittels Rändel- oder Feststellschraube (Schraubendreher erforderlich); Punktauslass, wahlw. in Anbaugehäuse bzw. Einbaugehäuse, als Zubehör

Quickinfo

3000K, 4000K
CRI ≥ 95, 2 SDCM
POTI, DALI

L85 @ 50 000h
PABLO basic up to 87lm/W
PABLO focus up to 69lm/W

L90 @ 50 000h
PABLO shutter/iris up to 18lm/W

Types

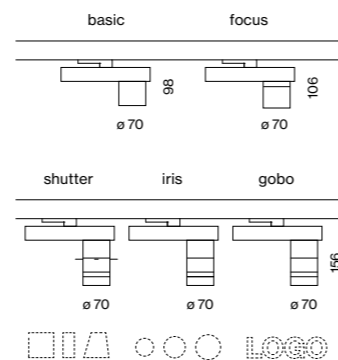

Colours



Light distributions

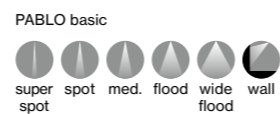

PABLO focus

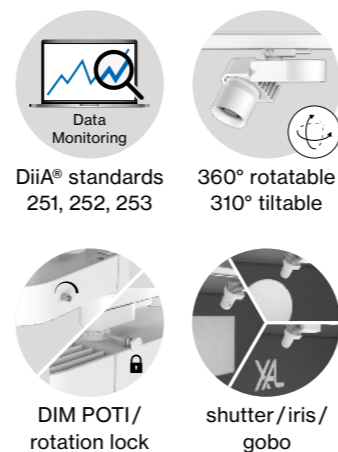

Order options

ADAPTER FIXATION	
tool-free fixation	2
set screw (tool required)	1

COLOUR TEMPERATURE	
3000K	0
4000K	1

CONTROL	
DIM POTI	8
DALI	3

MATERIAL COLOUR	
○ traffic white RAL 9016	7
● jet black RAL 9005	8

REFLECTOR	
super spot 6° (only for 11W)	V
spot 12°	S
medium 24°	M
flood 39°	F
wide flood 58°	W
wallwasher	A

Options on request

REFLECTOR	
oval flood	

Light distribution

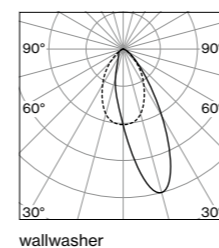

LUMINOUS FLUX value calculated for CRI ≥ 95, colour white, reflector spot

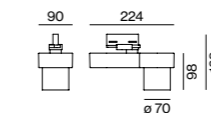

PABLO basic



TRACK LIGHT

SYS. POWER	COLOUR TEMPERATURE	LUMINOUS FLUX	ORDER CODE
10.9 W	3000K (CRI ≥ 90)	614 lm	180-51005
(3-SDCM)	4000K (CRI ≥ 90)	660 lm	180-51006
13.9 W	3000K	986 lm	180-51000
	4000K	1080 lm	
22.9 W	3000K	1460 lm	180-51011
	4000K	1610 lm	

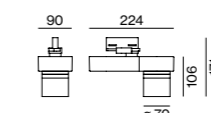

PABLO focus 17–47°



TRACK LIGHT

SYS. POWER	COLOUR TEMPERATURE	LUMINOUS FLUX	ORDER CODE
14 W	3000K	785 lm	180-52000
	4000K	862 lm	
23 W	3000K	1170 lm	180-52010
	4000K	1280 lm	

Optical accessories

SNOOT | HONEYCOMB LOUVER

TYPE	Ø H (mm)	ORDER CODE
snoot	62-33	080-590008
honeycomb louver	61-3	080-590018

Mounting accessories

SURFACE HOUSING/POINT OUTLET

TYPE	ORDER CODE
surface housing / point outlet	186-07228

RECESSED HOUSING/POINT OUTLET

ceiling thickness: 1-30 mm

TYPE	ORDER CODE
recessed housing / point outlet	186-07227



← back

Order options

ADAPTER FIXATION

- tool-free fixation 2
- set screw (tool required) 1

COLOUR TEMPERATURE

- 3000K 0
- 4000K 1

CONTROL

- DIM POTI 8
- DALI 3

MATERIAL COLOUR

- traffic white RAL 9016 7
- jet black RAL 9005 8

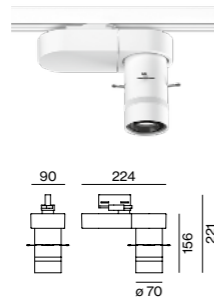

PABLO shutter



TRACK LIGHT

SYS. POWER	COLOUR TEMP.	LUMINOUS INTENSITY	ORDER CODE
14 W	3000K	854 cd	180-5300
	4000K	934 cd	
23 W	3000K	1266 cd	180-5301
	4000K	1389 cd	

illuminance (lux) = luminous intensity (cd) / distance (m)²

LIGHT DISTRIBUTION

possible shapes of illumination

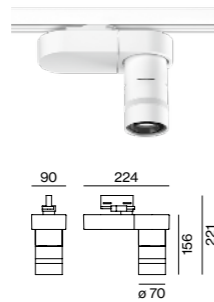
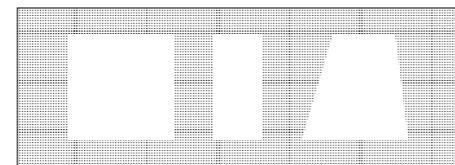

PABLO iris



TRACK LIGHT

SYS. POWER	COLOUR TEMP.	LUMINOUS INTENSITY	ORDER CODE
14 W	3000K	873 cd	180-5400
	4000K	960 cd	
23 W	3000K	1297 cd	180-5401
	4000K	1425 cd	

illuminance (lux) = luminous intensity (cd) / distance (m)²

LIGHT DISTRIBUTION

possible shapes of illumination

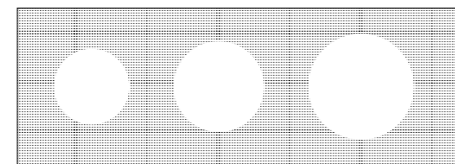

Illumination size

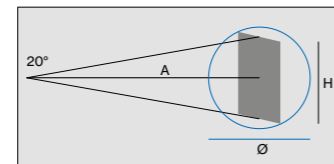

A (mm)	H (mm)	Ø (mm)
1000	396	560
2000	792	1120
3000	1188	1680

Order options

MATERIAL COLOUR

- traffic white RAL 9016 7
- jet black RAL 9005 8

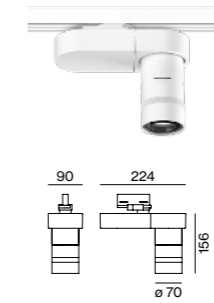

PABLO gobo



TRACK LIGHT

SYS. POWER	LUMINOUS INTENSITY	ORDER CODE
14 W	depends on form	on request

LIGHT DISTRIBUTION

customised shapes of illumination possible

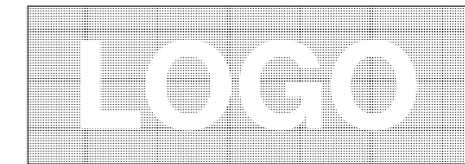

Mounting accessories



SURFACE HOUSING/POINT OUTLET

TYPE	ORDER CODE
surface housing/point outlet	186-07228



RECESSED HOUSING/POINT OUTLET

ceiling thickness: 1-30 mm

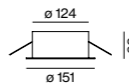

TYPE	ORDER CODE
recessed housing/point outlet	186-07227



Nationalmuseum Stockholm, SE –
by Wingårdhs with lighting design
by Gabriele von Kardorff

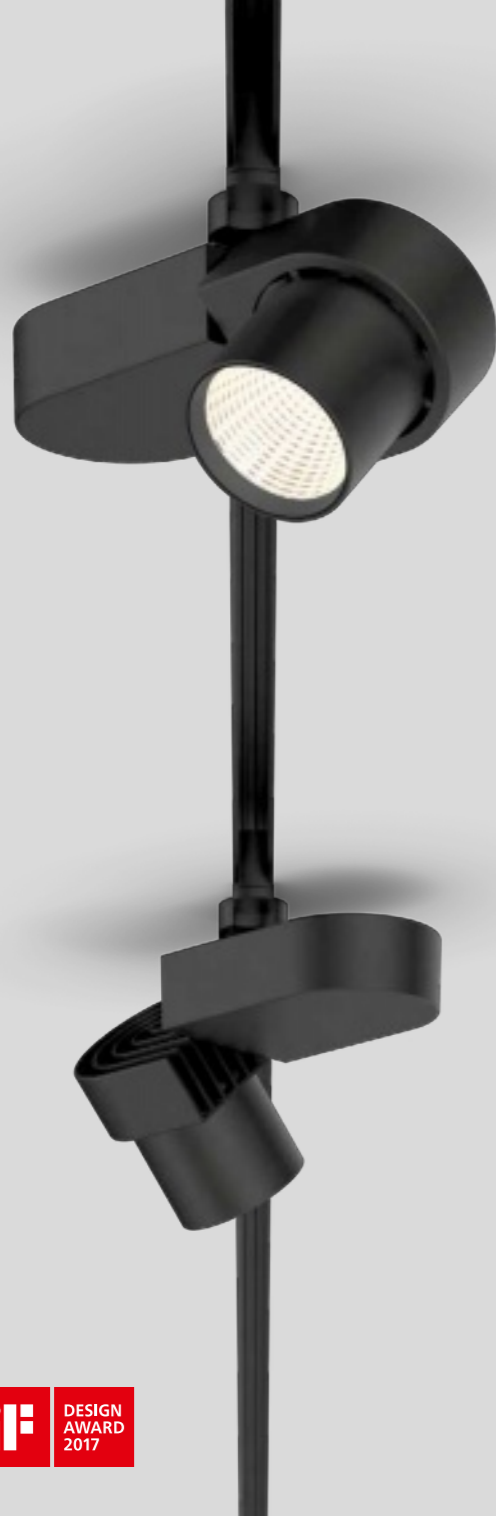

[← back](#)

PABLO colour tune/tunable white

track

EN Track light made of die-cast aluminium; powder coated; converter in spotlight housing; COB (Chip on Board) technology or CSP (Chip-Scale-Packaging) technology for maximum efficiency; no multiple shadows; energy-eff. LEDs – very good colour rendering; high quality aluminium refl., spherical facet finish; high-gloss anodised; precise radiation charact. – different beam angles; installed/exchanged without tools; optical attachments as accessories; adapter for toolless insertion or movement on a variety of 3-phase power tracks; adapter fixation optionally without tools by means of knurled screw or set screw (screwdriver required); point outlet, either in surface mounted housing or recessed housing, as an accessory

DE Stromschienenstrahler aus Aluminium-druckguss; pulverbeschichtet; Konverter im Strahlergehäuse; COB (Chip on Board) Technologie bzw. CSP (Chip-Scale-Packaging) Technologie für höchste Effizienz; keine Mehrfachschatten; energieeff. LEDs – sehr gute Farbwiedergabe; hochwert. Aluminium-refl., sphärische Facettenoptik; hochglänzend elox.; präzise Abstrahlcharakt. – verschied. Ausstrahlwinkel; werkzeuglos einsetz-/austauschbar; optische Aufsätze als Zubehör; Adapter für werkzeugloses Einsetzen bzw. Verschieben in verschiedenen 3-Phasen Stromschienen; Adapter-Fixierung wahlweise werkzeuglos mittels Rändel- oder Feststellschraube (Schraubendreher erforderlich); Punktauslass, wahlw. in Anbaugehäuse bzw. Einbaugehäuse, als Zubehör

Quickinfo

PABLO colour tune
3500 K red/blue
CRI ≥ 90, 3 SDCM
up to 54lm/W
L95 @ 50 000h
DALI-2

PABLO tunable white
TW 2700–5000K
CRI ≥ 95, 3 SDCM
up to 48lm/W
L80 @ 50 000h
DALI-2 DT8

Type

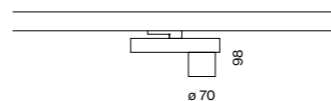

Colours



Light distributions

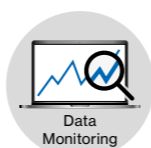

DiiA® standards
251, 252, 253



360° rotatable
245°/65° tiltable



rotation
lock



colour tune
(3500K red/blue)

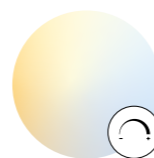

tunable white
2700–5000K

Order options

ADAPTER FIXATION
tool-free fixation 2
set screw (tool required) 1

MATERIAL COLOUR
○ traffic white RAL 9016 7
● jet black RAL 9005 8

BEAM ANGLE
medium 20/24° M
flood 38° F

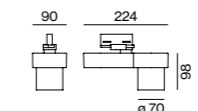

PABLO colour tune



TRACK LIGHT

SYS. POWER	COLOUR TEMPERATURE	LUMINOUS FLUX	ORDER CODE
18.8W	3500K red/blue	1020lm	180-5600G3

Fresh colour for historical works of art



PABLO colour tune was developed to revitalise historical art, which is particularly worthy of protection, true to the original. An increased, individually adjustable red-blue saturation compensates for time-related colour damage – purely through the lighting. This reawakens the original colours of a work of art. The correct setting of PABLO colour tune can be easily controlled and adjusted via DALI-2.

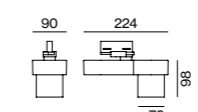

PABLO tunable white

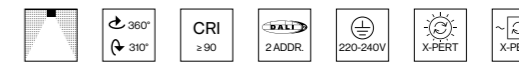

TRACK LIGHT

SYS. POWER	COLOUR TEMPERATURE	LUMINOUS FLUX	ORDER CODE
19.9W	2700–5000K	954lm	180-5600D3

Optical accessories

SNOOT | HONEYCOMB LOUVER

TYPE	Ø-H (mm)	ORDER CODE
snoot	62-33	080-5900008
honeycomb louver	61-3	080-5900018

Mounting accessories

SURFACE HOUSING/POINT OUTLET

TYPE	ORDER CODE
surface housing/point outlet	186-07228

RECESSED HOUSING/POINT OUTLET

ceiling thickness: 1-30 mm

TYPE	ORDER CODE
recessed housing/point outlet	186-07227



LUMINOUS FLUX value calculated for colour white, reflector medium

Nationalmuseum Stockholm, SE –
by Wingårdhs with lighting design
by Gabriele von Kardorff



back



PABLO multilens

track

EN Track light made of die-cast aluminium; powder coated; 360° rotatable and 310° tiltable; converter installed in aluminium spotlight housing; COB (Chip on Board) technology for maximum efficiency; no multiple shadows; energy-eff. LEDs – very good colour rendering; exchangeable additional lenses; precise radiation characteristics with different beam angles; installed and exchanged without tools; optical attachments as accessories; adapter for toolless insertion or movement on a variety of 3-phase power tracks; adapter fixation optionally without tools by means of knurled screw or set screw (screwdriver required); point outlet, either in surface mounted housing or recessed housing, as an accessory

DE Stromschienenstrahler aus Aluminiumdruckguss; pulverbeschichtet; 360° dreh- und 310° schwenkbar; Konverter im Strahlergehäuse aus Aluminium verbaut; mit COB (Chip on Board) Technologie für höchste Effizienz; keine Mehrfachschatten; energieeff. LEDs – sehr gute Farbwiedergabe; austauschbare Vorsatzlinsen; präzise Abstrahlcharakteristik mit verschiedenen Ausstrahlwinkeln; werkzeuglos einsetz- bzw. austauschbar; optische Aufsätze als Zubehör; Adapter für werkzeugloses Einsetzen bzw. Verschieben in verschiedenen 3-Phasen Stromschienen; Adapter-Fixierung wahlweise werkzeuglos mittels Rändel- oder Feststellschraube (Schraubendreher erforderlich); Punktauslass, wahlweise in Anbaugehäuse bzw. Einbaugehäuse, als Zubehör

Quickinfo

3000K, 4000K
CRI ≥ 90, 2 SDCM
up 76lm/W
L85 @ 50 000h
DIM POTI

Type



Colours



Light distributions

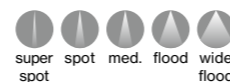

Order options

ADAPTER FIXATION
tool-free fixation 2
set screw (tool required) 1

COLOUR TEMPERATURE
3000K 5
4000K 6

CONTROL

DIM POTI

MATERIAL COLOUR

traffic white RAL 9016 7
 jet black RAL 9005 8

BEAM ANGLE

10/19/30/38/40/64°

Options on request

CONTROL

DALI-2

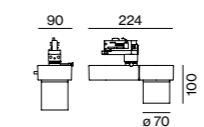

PABLO multilens 10–60°



TRACK LIGHT

SYS. POWER	COLOUR TEMPERATURE	LUMINOUS FLUX	ORDER CODE
14.8W	3000K	1050lm	180-57008
	4000K	1130lm	

incl. 5 pcs. interchangeable diffusion sheets

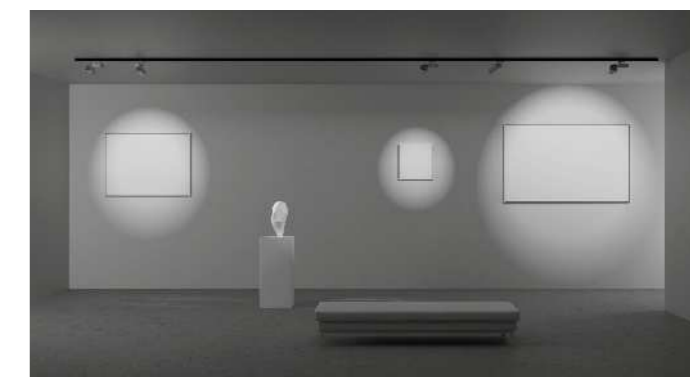

Optical accessories

OVAL FILTER

TYPE	ORDER CODE
oval filter 60 × 15°	080-5900020

Mounting accessories

SURFACE HOUSING/POINT OUTLET

TYPE	ORDER CODE
surface housing/point outlet	186-07228

RECESSED HOUSING/POINT OUTLET

ceiling thickness: 1-30 mm

TYPE	ORDER CODE
recessed housing/point outlet	186-07227

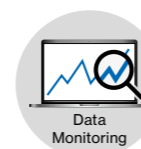
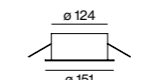

DiiA® standards
251, 252, 253

interchangeable
diffusion sheets360° rotatable
310° tiltableDIM POTI/
rotation lock

LUMINOUS FLUX value calculated for
CRI ≥ 90, colour white, lens spot

Free to arrange

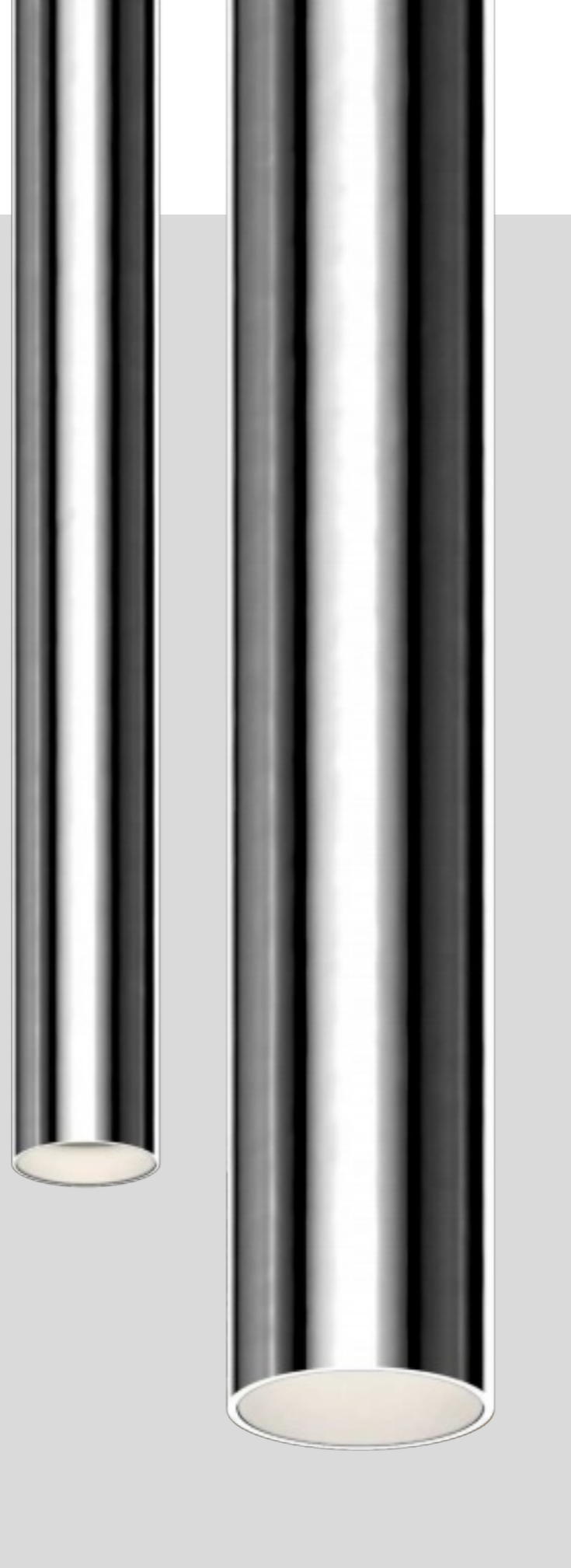

TULA

EN A suspended luminaire that gives more than “just” light. TULA immediately catches the eye with its decorative, slim shape. The luminaire is available in white, black, and chrome, as well as in numerous custom colours. Depending on your interior design, choose between the light colours 2700K, 3000K, or 4000K. The position of the luminaires can be easily changed with additional hooks on the cable and rings on the ceiling, thus TULA always adapts itself to evolving conditions in the space or creates artistic patterns. TULA is also available as a lighting inset for the MOVE IT track system.

DE Eine Pendelleuchte, die mehr als „nur“ Licht gibt. Durch ihre dekorative, schlanke Form fällt TULA sofort auf. Die Leuchte ist in Weiß, Schwarz und Chrom sowie in zahlreichen Sonderfarben erhältlich. Je nach Interior Design können Sie zwischen den Lichtfarben 2700 K, 3000 K oder 4000 K wählen. Mit zusätzlichen Haken am Kabel und Ringen an der Decke wird die Position der Leuchte einfach verändert – so passt sie sich stets neuen Gegebenheiten im Raum an oder kreiert kunstvolle Muster. TULA ist auch als Lichteinsatz für das MOVE IT Stromschienensystem verfügbar.

Types



25
nano

45
micro

Mounting



suspended

Light distribution

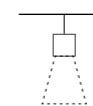

downlight

← back



TULA

suspended

EN Decorative suspended luminaire in aluminium; surface polished chrome or powder coated; pendant fitting with suspension, incl. feed (black or white); can be individually shortened; good glare reduction due to recessed light point plane; incl. high quality lens system; COB (Chip on Board) technology or high power LEDs for maximum efficiency; no multiple shadows; energy-efficient LEDs with very good colour rendering; canopy for through wiring; converter included in canopy, either recessed or surface mounted version; ceiling mounting rings for multiple positioning of the luminaire in the room available as accessory

DE Dekorative Pendelleuchte aus Aluminium; Oberfläche chrom poliert oder pulverbeschichtet; abgependelt mit Pendelabhängung, inkl. Einspeiseleitung (schwarz oder weiß); beliebig kürzbar; gute Entblendung durch zurückversetzte Lichtpunktebene; inkl. hochwertiger Linsenoptik; mit COB (Chip on Board) Technologie bzw. High-Power-LEDs für höchste Effizienz; keine Mehrfachschatten; energieeffiziente LEDs mit sehr guter Farbwiedergabe; Baldachin für Weiterverdrahtung; Konverter im Baldachin enthalten, wahlweise als Einbau- oder Anbauvariante; Deckenmontageringe für multiple Positionierung der Leuchte im Raum als Zubehör erhältlich

Quickinfo

2700 K, 3000 K
 CRI ≥ 90, 3 SDCM
 up to 95 lm/W
 L80 @ 50 000 h
 non DIM, DALI-2, Casambi

Types

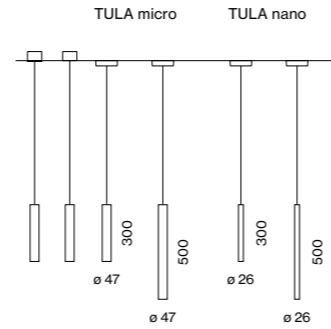

Colours



Light distributions



Order options

HOUSING HEIGHT	
300 mm	5
500 mm	7

SUSPENSION	
cable 1500 mm	

COLOUR TEMPERATURE	
2700 K	4
3000 K	5

MATERIAL COLOUR	
chrome	4
traffic white RAL 9016	7
jet black RAL 9005	8
special colours* p. 992	X

*cable always in white

BEAM ANGLE	
medium 25°	M
flood 44°	F

ACCESSORY COLOUR	
traffic white RAL 9016	7
jet black RAL 9005	8

Options on request

COLOUR TEMPERATURE	
4000 K	

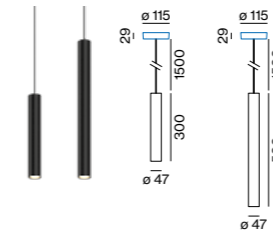
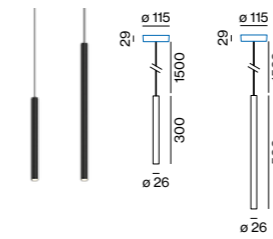

TULA nano suspended

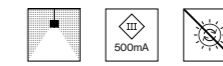

INSET POWER	LUMINOUS FLUX	ORDER CODE
9 W 18 Vf 500mA	732lm	0 4 9 - 5 L 1 0 :: 1 ▣ ▣

TULA micro suspended

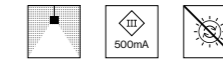

INSET POWER	LUMINOUS FLUX	ORDER CODE
8.4 W 18 Vf 500mA	798lm	0 4 9 - 5 L 1 5 :: 1 ▣ ▣

Mounting accessories

CANOPY CEILING 220-240V AC, 50-60Hz, PC I

TYPE	EFFICIENCY	Ø-H (mm)	ORDER CODE
500 mA non DIM	η 79 %	115-29	0 0 5 - 2 6 0 2 1 1 ▣
500 mA DALI-2	η 81 %	115-29	0 0 5 - 2 6 0 2 1 3 ▣
500 mA Casambi	η 80 %	115-29	0 0 5 - 2 6 0 2 1 9 ▣

MOUNTING SET RECESSED WITH TRIM

for installation in ceilings from 2-25 mm

TYPE	Ø-H (mm)	ORDER CODE
mounting set with trim	77-49	0 0 5 - 3 5 2 1 0 1 ▣

MOUNTING SET RECESSED TRIMLESS

for installation in plasterboard ceilings 9-25 mm

TYPE	Ø-H (mm)	ORDER CODE
mounting set trimless	75-48	0 0 5 - 3 5 1 1 0 1 7

SPECIAL MOUNTING TOOL

TYPE	Ø-H (mm)	ORDER CODE
special mounting tool	100-9	0 6 3 - 8 9 1 2 1 1 0

necessary to install mounting set trimless

RING

TYPE	Ø-H (mm)	ORDER CODE
ceiling mounted	50-88	0 5 0 - 0 5 1 0 2 1 ▣

HOOK

TYPE	L-W-H (mm)	ORDER CODE
ceiling mounted	18-13-58	0 5 0 - 5 9 0 1 1 1 ▣

Electrical accessories

POWER SUPPLY 220-240 V AC, 50-60 Hz, PC II

TYPE	EFFICIENCY	L-W-H (mm)	ORDER CODE
500 mA non DIM	η 80 %	65-39-20	0 0 2 - 9 0 7 3 2
500 mA DALI-2	η 82 %	166-30-22	0 0 2 - 9 0 7 3 3

DIN RAIL COMPONENTS

TYPE	W-H-D (mm)	ORDER CODE
POWER SUPPLY 220-240 V AC 96 W 48V DC constant voltage	90-90-60	0 0 5 - 6 5 2 0 2 1 0
LED DRIVER DALI-2 DT6 1-2 addr. 200-1050 mA settable const. current 2 × 42W 48V DC U _{OUT} 10-40V	36-88-59	0 0 5 - 6 1 2 1 0 3 0

for more details and components see page 981

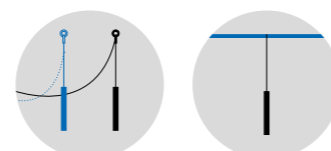

free positioning by ring and hook track version available (p. 742)

INSET POWER is the current consumption excluding any ballast
 LUMINOUS FLUX value calculated for 3000 K, CRI ≥ 90, colour white, lens flood 2700 K -5%



Casino Dusseldorf, DE –
by ttsp hwp seidel Planungsgesellschaft mbH
with lighting design by Licht Kunst Licht AG



Global Timber Århus, DK –
by RAVN architects with lighting
design by Rikke Sølvsteen



Arrange the mood

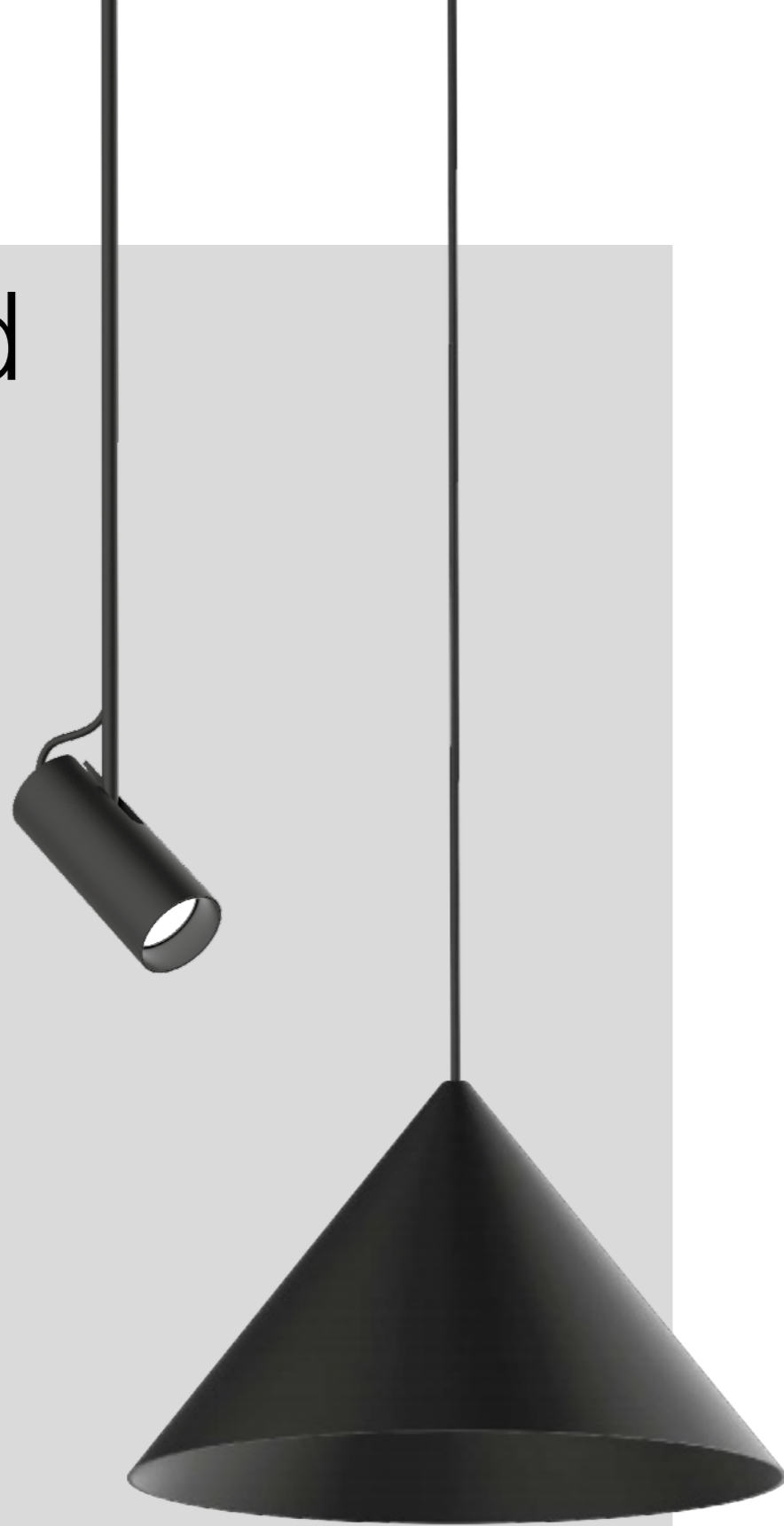

ARY

EN ARY simultaneously serves lighting and decor. The suspended spotlight luminaire amazes with various selectable beam characteristics and excellent colour rendering ($CRI \geq 90$). ARY's adjustable rod variant is maximally mobile. The spotlight head can be turned by 320° and tilted by 90° . The cable variant offers a choice of different shades to match the colour and size perfectly to your interior design. Separate ceiling rings create even more design freedom. The lights can be repositioned at will and grouped into exciting arrangements using the hooks. ARY is also available as a light inset for the elegant MOVE IT track system.

DE ARY ist Beleuchtung und Dekorationsobjekt zugleich. Die abgehängte Strahlerleuchte besticht durch unterschiedlich wählbare Abstrahlcharakteristiken und sehr gute Farbwiedergabe ($CRI \geq 90$). In der Adjustable-Rod-Variante ist ARY maximal beweglich: der Strahlerkopf kann um 320° gedreht und um 90° geschwenkt werden. Für die Kabelvariante haben Sie eine Auswahl an verschiedenen Shades, um Farbe und Größe perfekt auf Ihre Innenarchitektur abzustimmen. Separate Deckenringe schaffen noch mehr Gestaltungsfreiheit: Mittels Haken können die Leuchten immer wieder neu positioniert und zu spannenden Arrangements gruppiert werden. ARY ist auch als Lichteinsatz für das elegante MOVE IT Stromschienensystem verfügbar.

Types

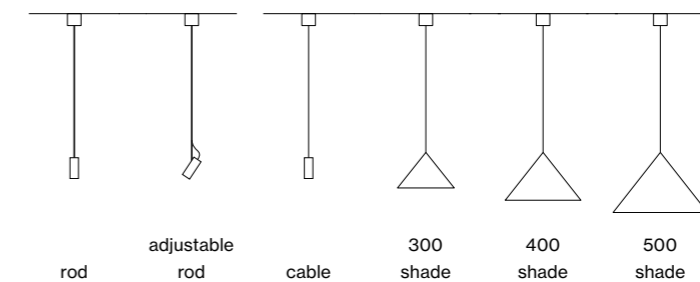

Mounting

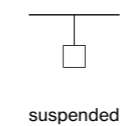

Light distributions

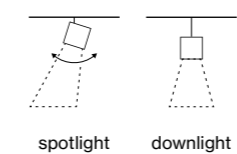

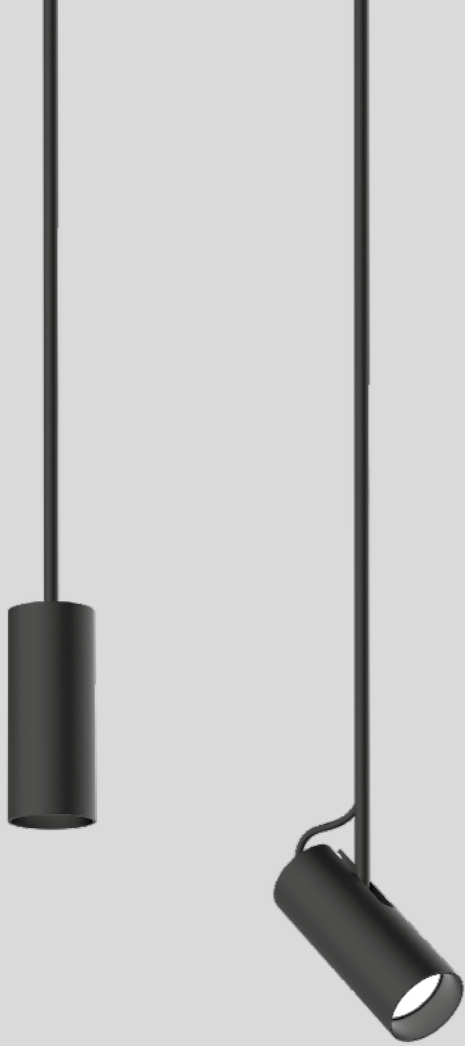

Quickinfo

2700 K, 3000 K, 4000 K
 CRI ≥ 90, 3 SDCM
 up to 95 lm/W
 L90 @ 50 000 h
 non DIM, DALI-2, Casambi

Types

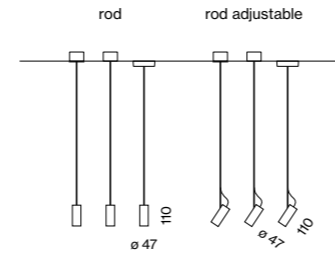

Colours



Light distributions



med. flood

Order options

MOUNTING

suspension 1500 mm 1
 suspension 2000 mm with hook* 2

*one ring included

COLOUR TEMPERATURE

2700 K 4
 3000 K 5
 4000 K 6

MATERIAL COLOUR

○ traffic white RAL 9016 7
 ● jet black RAL 9005 8
 ● special colours* p. 992 X

*rod always in white

ACCESSORY COLOUR

○ traffic white RAL 9016 7
 ● jet black RAL 9005 8

BEAM ANGLE

medium 25° M
 flood 44° F

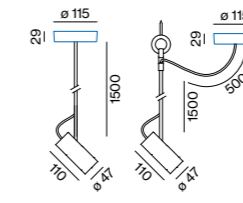
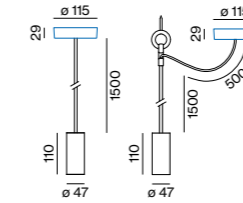

ARY rod suspended



DOWNLIGHT

INSET POWER 8.4 W 18 Vf 500 mA LUMINOUS FLUX 791 lm ORDER CODE 0 4 9 - 5 2 1 :: 1

ARY adjustable rod suspended



SPOTLIGHT ADJUSTABLE

INSET POWER 8.4 W 18 Vf 500 mA LUMINOUS FLUX 791 lm ORDER CODE 0 4 9 - 5 3 1 :: 1

Mounting accessories



CANOPY CEILING 220-240V AC, 50-60Hz, PC I

TYPE	EFFICIENCY	Ø-H (mm)	ORDER CODE
500 mA non DIM	η 79 %	115-29	0 0 5 - 2 6 0 1 1 1
500 mA DALI-2	η 81 %	115-29	0 0 5 - 2 6 0 1 1 3
500 mA Casambi	η 80 %	115-29	0 0 5 - 2 6 0 1 1 9

use for suspension with rod



CANOPY CEILING 220-240V AC, 50-60Hz, PC I

TYPE	EFFICIENCY	Ø-H (mm)	ORDER CODE
500 mA non DIM	η 79 %	115-29	0 0 5 - 2 6 0 2 1 1
500 mA DALI-2	η 81 %	115-29	0 0 5 - 2 6 0 2 1 3
500 mA Casambi	η 80 %	115-29	0 0 5 - 2 6 0 2 1 9

use for suspension with hook

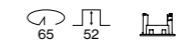

MOUNTING SET WITH TRIM for installation in ceilings from 2-25 mm

TYPE	Ø-H (mm)	ORDER CODE
single luminaire rod	77-49	0 0 5 - 3 5 2 2 0 1
single luminaire cable*	77-49	0 0 5 - 3 5 2 1 0 1

*use for suspension with hook

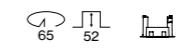

MOUNTING SET TRIMLESS for installation in plasterboard ceilings 9-25 mm

TYPE	Ø-H (mm)	ORDER CODE
single luminaire rod	75-48	0 0 5 - 3 5 1 2 0 1 7
single luminaire cable*	75-48	0 0 5 - 3 5 1 1 0 1 7

*use for suspension with hook



SPECIAL MOUNTING TOOL

TYPE	Ø-H (mm)	ORDER CODE
special mounting tool	100-9	0 6 3 - 8 9 1 2 1 1 0

necessary to install mounting set trimless



RING

TYPE	Ø-H (mm)	ORDER CODE
ceiling mounted	50-88	0 5 0 - 0 5 1 0 2 1

Electrical accessories

POWER SUPPLY 220-240V AC, 50-60Hz, PC II

TYPE	EFFICIENCY	L-W-H (mm)	ORDER CODE
500 mA non DIM	η 80 %	65-39-20	0 0 2 - 9 0 7 3 2
500 mA DALI-2	η 82 %	166-30-22	0 0 2 - 9 0 7 3 3

DIN RAIL COMPONENTS

TYPE	W-H-D (mm)	ORDER CODE
POWER SUPPLY 220-240 V AC 96 W 48V DC constant voltage	90-90-60	0 0 5 - 6 5 2 0 2 1 0
LED DRIVER DALI-2 DT6 1-2 addr. 200-1050 mA settable const. current 2 × 42 W 48V DC U _{OUT} 10-40 V	36-88-59	0 0 5 - 6 1 2 1 0 3 0

for more details and components see page 981



ARY rod

suspended

EN Decorative suspended luminaire in aluminium; surface powder coated; height adjustable U-profile pendant rod suspension (black or white), feed in U-profile; spotlight head either fixed or 320° rotatable and 90° tiltable; good glare reduction due to recessed light point plane; incl. high quality lens system; precise radiation characteristics with different beam angles; COB (Chip on Board) technology for maximum efficiency; no multiple shadows; energy-efficient LEDs with very good colour rendering; canopy for through wiring; converter included in canopy; ceiling mounting rings for multiple positioning of the luminaire in the room available as accessory

DE Dekorative Pendelleuchte aus Aluminium; Oberfläche pulverbeschichtet; kürzbare U-Profil-Pendelstangenabhangung (schwarz oder weiß), Einspeiseleitung in U-Profil; Strahlerkopf wahlweise starr bzw. 320° dreh- und 90° schwenkbar; gute Entblendung durch zurückversetzte Lichtpunktebene; inkl. hochwertiger Linsenoptik; präzise Abstrahlcharakteristik mit verschiedenen Ausstrahlwinkeln; mit COB (Chip on Board) Technologie für höchste Effizienz; keine Mehrfachschatten; energieeffiziente LEDs mit sehr guter Farbwiedergabe; Baldachin für Weiterverdrahtung; Konverter im Baldachin enthalten; Deckenmontageringe für multiple Positionierung der Leuchte im Raum als Zubehör erhältlich



320° rotatable,
90° tiltable

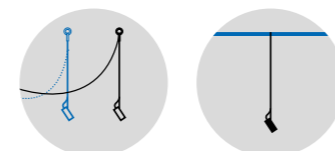

free positioning by ring and hook track version available (p. 734)

INSET POWER is the current consumption excluding any ballast
 LUMINOUS FLUX value calculated for 3000 K, CRI ≥ 90, colour white, lens flood 2700 K -5%, 4000 K +5%

Restaurant Le Prestine Antwerp, BE –
by Space Copenhagen
with lighting design by anker & co





Restaurant Vinea Oldenburg, DE –
 by neun grad architektur with lighting design
 by CapitalReal Immobilien GmbH & Co. KG, Dennis Poelmeyer



Colliers Real-estate Copenhagen, DK –
by Architect Helle Nøhr with lighting
design by anker & co



Get on track

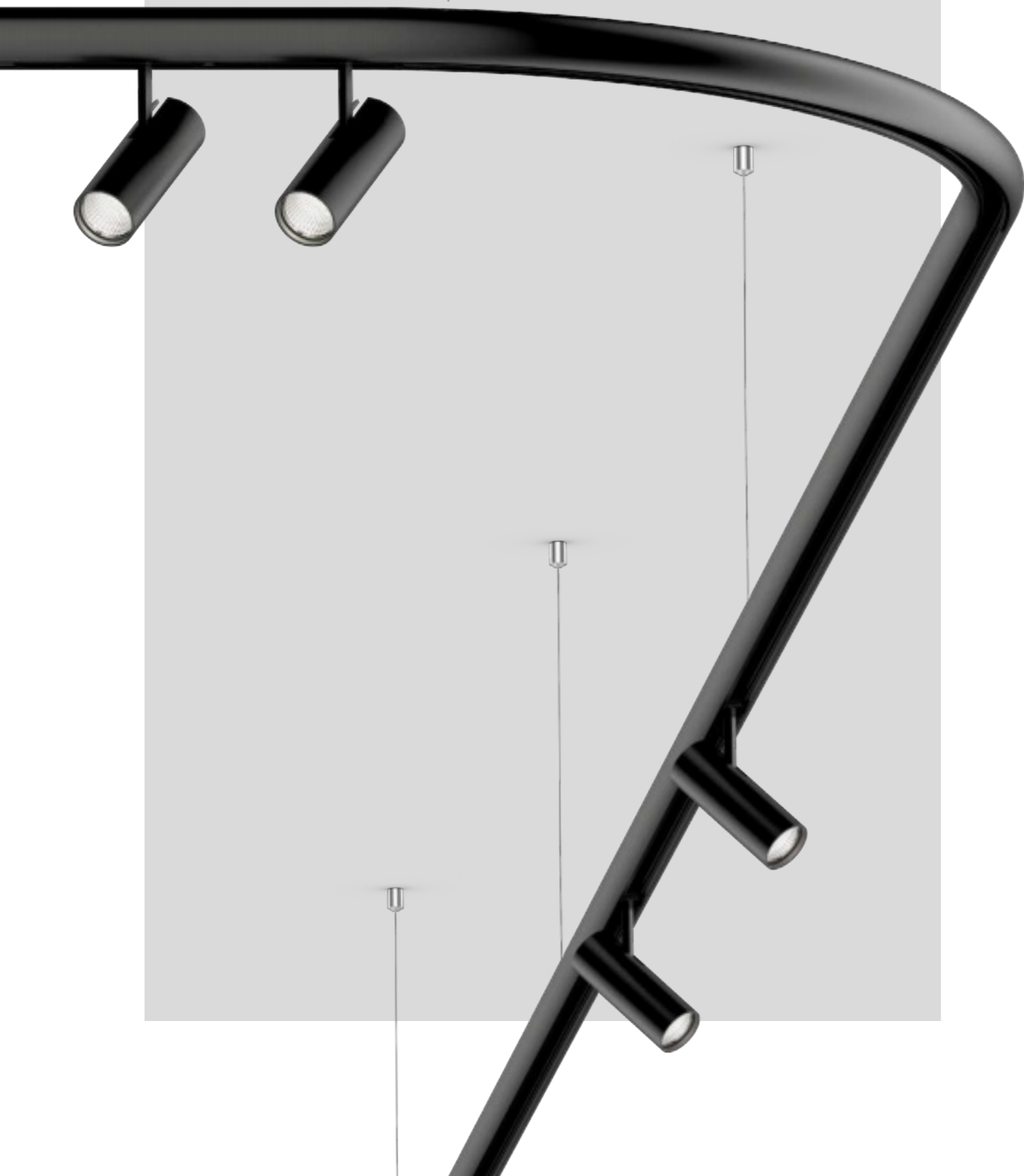

TRACK 3-phase

EN A particularly elegant and versatile track system. The three-phase track is available in square, round, or H-shaped profile form. The surface-mounted and suspended versions deliver further design freedom when combined with curved and corner connectors. The suspended H-profile enables exciting ceiling accentuation through optional light insets on the top of the profile. In many variants, the adapter disappears entirely in the profile and supports the reduced look. The high-quality appearance is enhanced by choosing between the colours white, grey, and black.

DE Ein besonders elegantes Stromschienensystem, das durch Vielseitigkeit überzeugt. Die 3-Phasen-Schiene ist in eckiger, runder oder H-förmiger Profilform erhältlich. In Kombination mit Kurven- und Eckverbindern geben die Anbau- und abgehängte Variante noch mehr Gestaltungsfreiraum. Das abgehängte H-Profil ermöglicht eine spannende Deckenakzentuierung durch optionale Lichteinsätze an der Profiloberseite. In vielen Varianten verschwindet der Adapter vollständig im Profil und unterstützt die reduzierte Optik. Die hochwertige Erscheinung wird durch die Farbauswahl Weiß, Grau und Schwarz verstärkt.

Types



30x40 45 30x80

Mountings

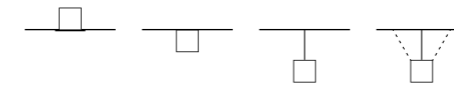

recessed surface suspended indirect
suspended

Configurations

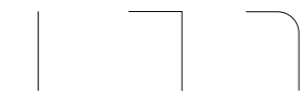

linear corner curve

Compatible spotlights

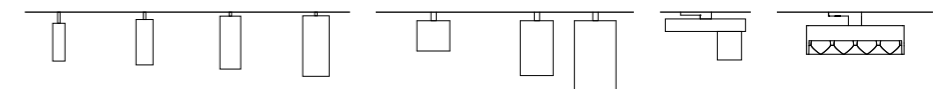

BO 32 BO 45 BO 55 BO 70 VARO 80 S VARO 80/110 PABLO SQUADRO

Mounting options

EN The three-phase tracks are available as recessed, surface-mounted, and suspended versions.

DE Die 3-Phasen-Stromschienen sind als Einbau-, Anbau- und Suspended-Variante verfügbar.

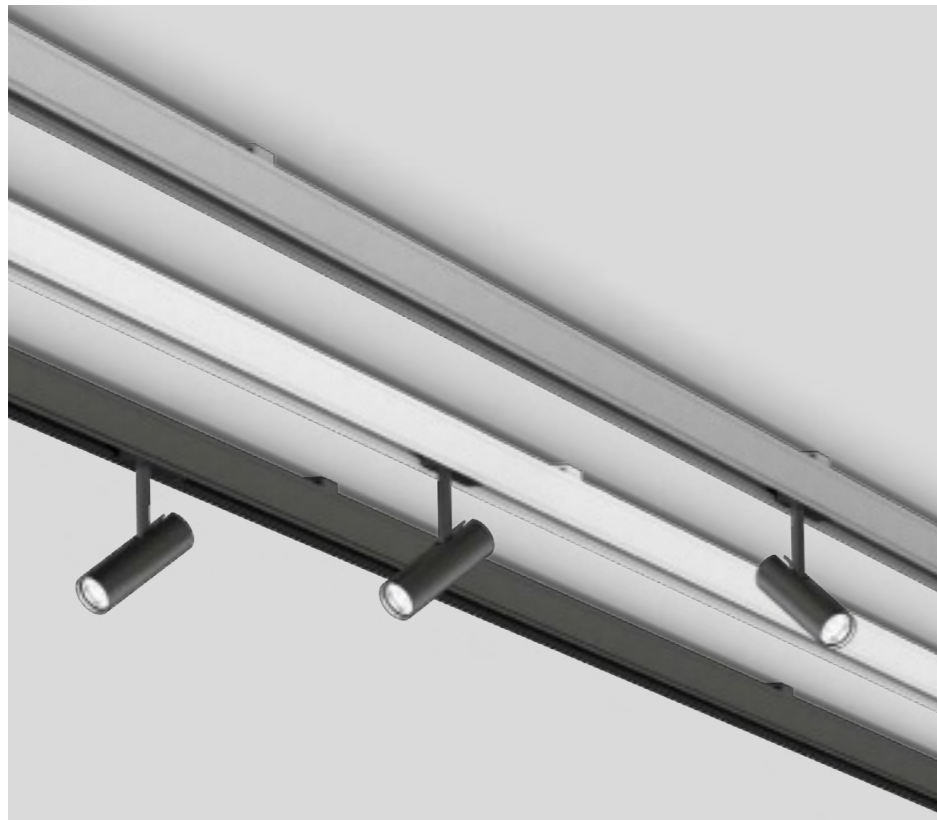
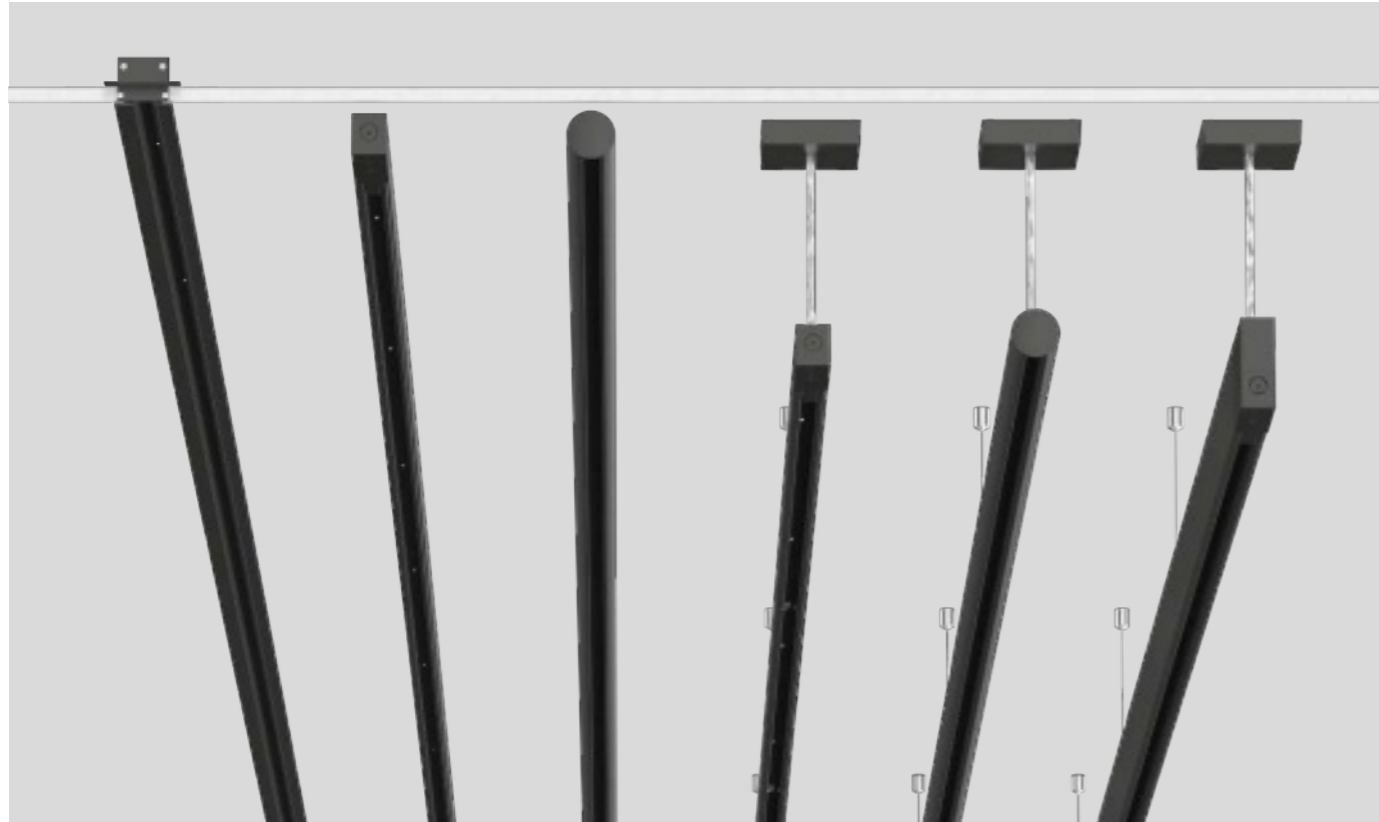

Colour variety

EN Tracks are available in different standard colours: white, grey, and black.

DE Die Stromschienen sind in unterschiedlichen Standardfarben von Weiß, Grau und Schwarz erhältlich.



Track variety

EN Available in round, square, and H-shape, the profile offers custom application options. Concealing the adapter in the profile creates a visually calm ceiling image. This concealment is available in the surface-mounted and suspended variants, in both the round and square forms. The unique feature of the suspended H-profile is that it can create indirect light by mounting, without tools, lighting insets on the top.

DE In runder, eckiger und in H-Form erhältlich bietet das Profil individuelle Einsatzmöglichkeiten. In der Anbau- und Suspended-Variante, verfügbar in runder und eckiger Form, entsteht durch den im Profil verborgenen Adapter ein optisch ruhiges Deckenbild. Die Besonderheit des abgehängten H-Profiles: Lichteinsätze können auch an der Oberseite werkzeuglos montiert werden, um indirektes Licht zu erzeugen.

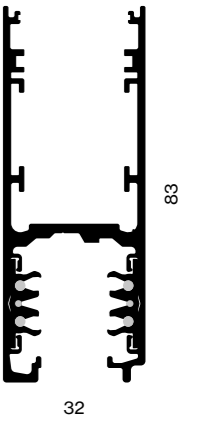
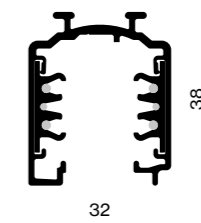
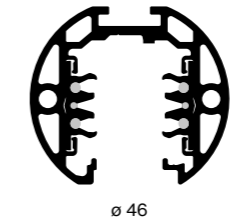
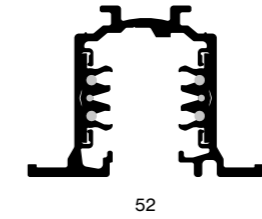

Curve and corner elements

EN Additional creative design options are opened when combined with curve and corner elements. The lighting system can thus be adapted to the different contours of the respective architecture.

DE In Kombination mit Eck- und Kurvenelementen ergeben sich zusätzlich kreative Gestaltungsoptionen. Somit lässt sich das Beleuchtungssystem an die unterschiedlichen Konturen der jeweiligen Architektur anpassen.



← back



TRACK 3-phase

recessed / surface / suspended

Types

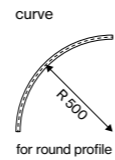
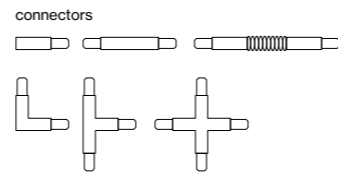
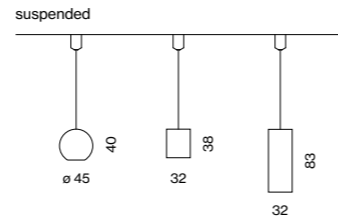
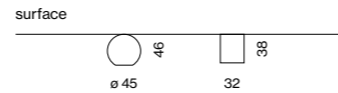
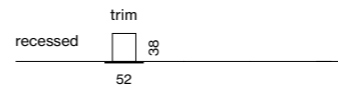

Colours



← back

TRACK recessed

Order options

CONTROL

non DIM
DALI-2

MATERIAL COLOUR

- pure white RAL 9010 7
- jet black RAL 9005 8

Pole options

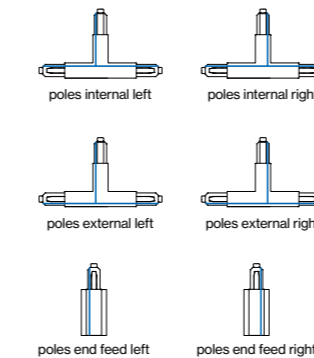

curve connector



optimised adapter integration

TRACK 3-phase/3-phase + DALI-2-bus



TRACK 240V-16A

L (mm)	ORDER CODE
2000	186-012213
3000	186-012313
4000	186-012413

end cap	186-022011
---------	------------

end feed left	186-022313
end feed right	186-022413
middle feed	186-021323

CONNECTORS 240V-16A

TYPE	ORDER CODE
linear connector	186-021113

L-connector	186-022123
-------------	------------

L-connector right	186-022133
L-connector left	186-022233

T-connector right (poles internal)	186-022143
T-connector left (poles internal)	186-022243
T-connector right (poles external)	186-022173
T-connector left (poles external)	186-022273

X-connector	186-022153
-------------	------------

MOUNTING ACCESSORIES

TYPE	ORDER CODE
clip	186-0225110

cutting tool	186-0219110
--------------	-------------

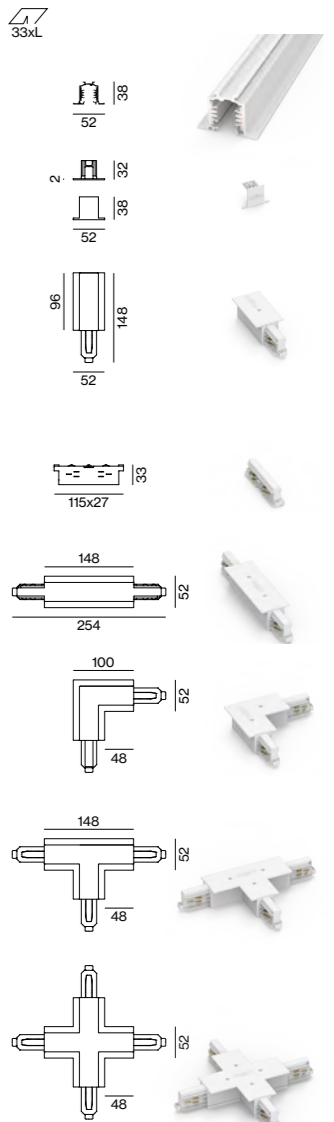

← back

TRACK

surface/suspended

Order options

CONTROL

non DIM
DALI-2

MATERIAL COLOUR

- pure white RAL 9010 7
- white aluminium RAL 9006 6
- jet black RAL 9005 8

Pole options

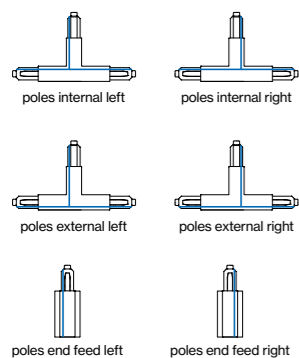

TRACK 3-phase/3-phase + DALI-2-bus



TRACK 240V-16A

L (mm)	ORDER CODE
1000	186-011123
2000	186-011223
3000	186-011323
4000	186-011423

end cap	186-021011
end feed left	186-021313
end feed right	186-021413
middle feed	186-021323

CONNECTORS 240V-16A

TYPE	ORDER CODE
linear connector	186-021113
I-connector	186-021123
L-connector right	186-021133
L-connector left	186-021233
T-connector right (poles internal)	186-021143
T-connector left (poles internal)	186-021243
T-connector right (poles external)	186-021173
T-connector left (poles external)	186-021273

X-connector	186-021153
adjustable corner connector	186-021163

MOUNTING ACCESSORIES

TYPE	ORDER CODE
ceiling clip	186-021511
pendant clip cable	186-021521
pendant clip rod	186-021541
joiner piece cable	186-021531
joiner piece rod	186-021551
cutting tool	186-021910

SUSPENSION KIT

TYPE	ORDER CODE
pendant 1000	186-021611
cable 1500	186-021710
cable 3000	186-021720
cable 6200	186-021730

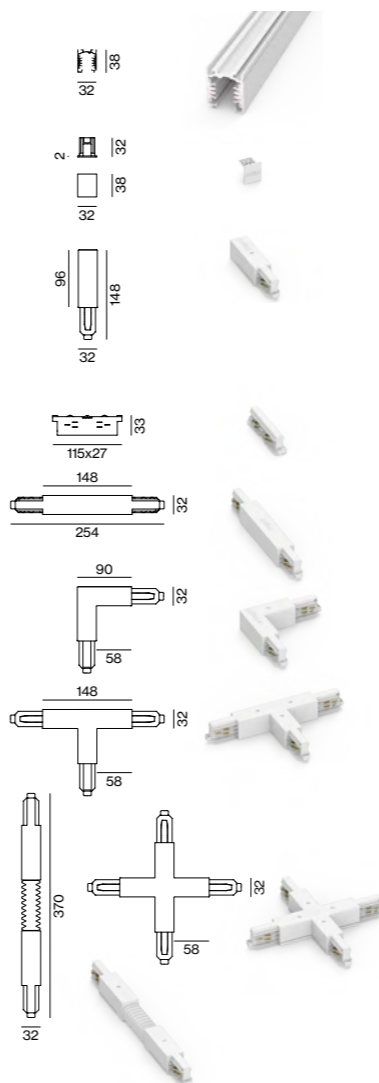

← back

TRACK high

surface/suspended

Order options

CONTROL

non DIM
DALI-2

MATERIAL COLOUR

- pure white RAL 9010 7
- jet black RAL 9005 8

Options on request

LIGHT OPTIC COVER

inset indirect

Pole options

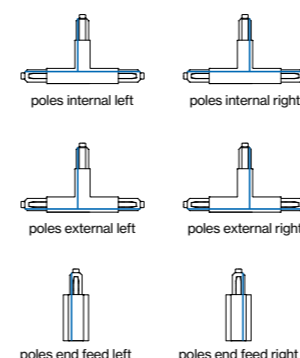

TRACK high 3-phase/3-phase + DALI-2-bus



TRACK 240V-16A

L (mm)	ORDER CODE
1000	186-016113
2000	186-016213
3000	186-016313
4000	186-016413

end cap	186-026011
end feed left	186-026313
end feed right	186-026413
middle feed	186-021323

CONNECTORS 240V-16A

TYPE	ORDER CODE
linear connector	186-026113
I-connector	186-026123
L-connector right	186-026133
L-connector left	186-026233
T-connector right (poles internal)	186-026143
T-connector left (poles internal)	186-026243
T-connector right (poles external)	186-026173
T-connector left (poles external)	186-026273

X-connector	186-026153
-------------	------------

MOUNTING ACCESSORIES

TYPE	ORDER CODE
pendant clip cable	186-0265210
pendant sheet metal clip	186-0215220
pendant clip rod	186-0265410
joiner piece cable	186-0265310
joiner piece rod	186-0265510

cutting tool	186-0219110
--------------	-------------

SUSPENSION KIT

TYPE	ORDER CODE
pendant 1000	186-021611
cable 1500	186-0217110
cable 3000	186-0217210
cable 6200	186-0217310

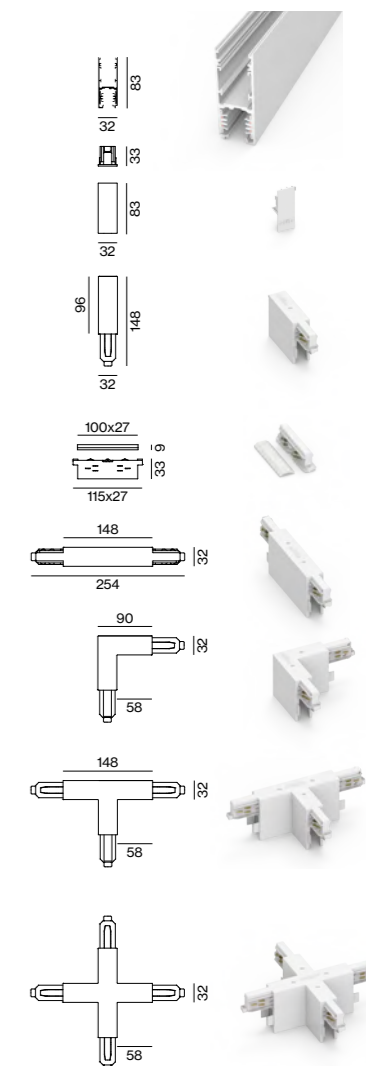

[← back](#)

TRACK round surface/suspended

Order options

CONTROL

non DIM

DALI-2

MATERIAL COLOUR

- pure white RAL 9010 7
- jet black RAL 9005 8

Options on request

CONNECTOR

T-connector

X-connector

MATERIAL COLOUR

- gold dust RAL 260-M

TRACK round 3-phase/3-phase + DALI-2-bus



TRACK 240V-16A

L (mm)	ORDER CODE
1000	186-015113
2000	186-015213
3000	186-015313
4000	186-015413



TRACK CURVE 240V-16A

TYPE	ORDER CODE
R 500 90° left	186-015853
R 500 90° right	186-015863

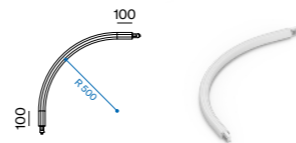

end cap	186-025011
---------	------------

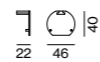

end feed left	186-025313
end feed right	186-025413
middle feed	186-021323

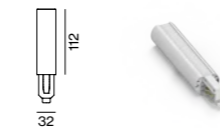

CONNECTORS 240V-16A

TYPE	ORDER CODE
linear connector	186-021113

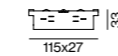

L-connector right	186-025133
L-connector left	186-025233

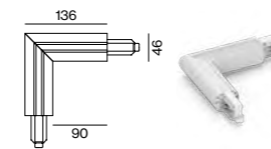

MOUNTING ACCESSORIES

TYPE	ORDER CODE
pendant clip cable	186-025521
pendant clip rod	186-025541

joiner piece cable	186-025531
joiner piece rod	186-025551

cutting tool	186-0219110
--------------	-------------

SUSPENSION KIT

TYPE	ORDER CODE
pendant 1000	186-021611

cable 1500	186-0217110
cable 3000	186-0217210
cable 6200	186-0217310



Luminaires



INSPIRATIONAL BOARD

Hör mal!

- Malware: Episode 14/2014
- Gedanken des eine Welt im Wandel
- 2017: Edward von Neumann: Episode 04
- Next generation
- "First look: Learning Forward"
- 2019: "Macht das Auge trüben"
- 1.2.19

Lies mal!

- "Kunst des Horchens"
- "Kulturcode für das 21. Jhd."
- "The Culture Code"
- "The secrets of how to build a great group"

Schau mal!

- WIRED: 5 Levels
- "Die Kunst des Horchens"

Luminaires

MITA



NEW 314

recessed

ceiling

COMBO



334

recessed

VELA



342

surface



suspended

SONO



356

recessed

surface

FLOW



374

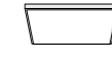

surface

JANE



NEW 380

semi-recessed
surface
suspended

DESO

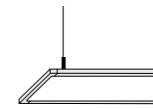

NEW 394

suspended

TASK

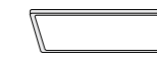

400

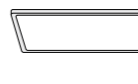
surface /
acoustic

wall



free standing

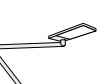

table

BETO

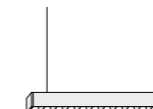

460

suspended

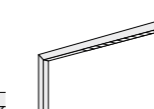

free standing

SETA

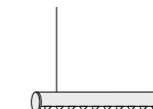

NEW 484

suspended

LENO

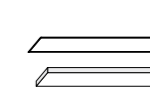

490

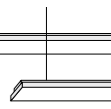
recessed
semi-recessedsurface /
suspended

MINIMAL

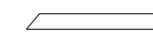

508

recessed

FRAME



516

recessed trim

CANYON



526

recessed
offset

MINO



532

surface /
suspended

BASO



556

recessed

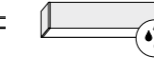

surface

TUBO

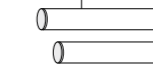

NEW 568

surface /
suspended

INO

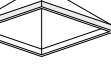

580

circle
suspendedsquare
suspendedMINO
CIRCLE

594

ceiling/
acousticsuspended /
acoustic

LITO

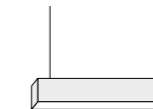

610

suspended

SONIC

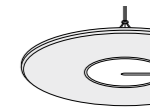

616

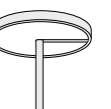
suspended /
acousticfree standing /
acoustic

LINEA

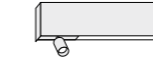

NEW 632

wall

HEX-O

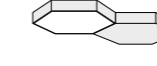

638

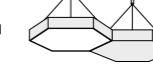
ceiling/
acousticsuspended /
acoustic

MUSE

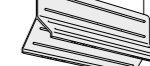

654

acoustic
suspended

STRETTA



670

surface

CORNER

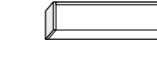

676

surface

RECOVER

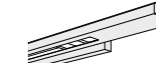

682

wall

Discreet perfection



MITA

EN MITA combines high performance with a slim design language and its wide range of applications is impressive. The product family is available as recessed or surface-mounted luminaires in a round or square design. All the versions of the luminaire have special reflectors for the best screen-compatible work lighting – perfect for use in offices or meeting rooms. MITA circle 160 recessed and its central extension also open up a wide range of new possibilities. Optional accessories can be added: covers, sensors for smart lighting control, emergency lighting inserts, or SASSO 60 spotlights with various reflectors. The product family is available in the light colours 3000K, 4000K, or Tunable White. Optionally, the luminaire can be equipped with a presence and brightness sensor.

DE MITA vereint Leistungsstärke mit schlanker Formensprache und besticht durch vielfältige Einsatzmöglichkeiten. Die Produktfamilie ist als Einbau- oder Anbauleuchte in runder oder quadratischer Ausführung verfügbar. In allen Ausführungen verfügt die Leuchte über spezielle Reflektoren für bestes, bildschirmtaugliches Arbeitslicht – perfekt für den Einsatz in Büros oder Meetingräumen. Mit MITA circle 160 recessed eröffnen sich zudem vielfältige neue Möglichkeiten durch eine Erweiterung in der Mitte. Optional kann Zubehör ergänzt werden: Abdeckungen, Sensoren für die smarte Lichtsteuerung, Notlichteinsätze oder SASSO 60 Strahler mit verschiedenen Reflektoren. Die Produktfamilie ist in den Lichtfarben 3000K, 4000K oder als Tunable White Option erhältlich. Optional kann die Leuchte mit einem Anwesenheits- und Helligkeitssensor ausgestattet werden.

Types

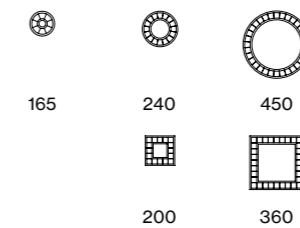

165

240

450

200

360

Mountings

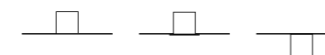
trimless
recessedwith trim
recessed

ceiling

Light distributions

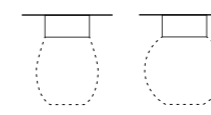
reflector
(UGR ≤ 19)opal
(ceiling)

← back



MITA circle 160

recessed

EN Ring shaped luminaire housing in die-cast aluminium; extremely slim design; recessed luminaire with trim (suitable for ceiling thickness of 2-25 mm); or for trimless installation in plasterboard ceilings (suitable for ceiling thickness of 12.5/15/20/25 mm); surface powder coated; incl. blind cover made of plastic in the cut-out; optional: SASSO 60 round, SASSO 60 round sensor or SASSO 60 round emergency round for installation in the cut-out available as an accessory; high-gloss reflector with faceted design; energy-efficient LEDs with very good colour rendering

DE Ringförmiger Leuchtenkörper aus Aluminiumdruckguss; extrem schlanke Bauform; Einbauleuchte mit umlaufendem Rand (geeignet für Deckenstärken von 2-25 mm); oder für randlosen Einbau in Gipskartondecken (geeignet für Deckenstärken 12,5/15/20/25 mm); Oberfläche pulverbeschichtet; inkl. Blindabdeckung aus Kunststoff im Innenausschnitt; optional: SASSO 60 round, SASSO 60 sensor round oder SASSO 60 emergency round zum Einsetzen im Innenausschnitt als Zubehör erhältlich; hochglänzender Reflektor mit Facettenoptik; energieeffiziente LEDs mit sehr guter Farbwiedergabe

Quickinfo

3000K, 4000K, TW
 CRI ≥ 80, 3 SDCM
 UGR ≤ 19 / 65° ≤ 1500 cd/m²
 up to 134 lm/W
 L95 @ 50 000 h
 non DIM, DALI-2
 reflector (UGR ≤ 19)

Types

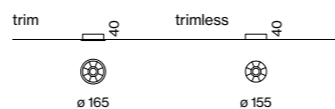

Colours



Light distribution



Order options

COLOUR TEMPERATURE
 3000K 5
 4000K 6
 tunable white 2700–6500 K* D
 *DALI-2 DT8

CONTROL

non DIM
 DALI-2

MATERIAL COLOUR

○ pure white RAL 9010 7
 ● jet black RAL 9005 8

LIGHT OPTIC COVER

reflector (UGR ≤ 19)

Options on request

COLOUR RENDERING INDEX

CRI ≥ 90

GRID CEILING MOUNTING

installed in module 600 × 600 mm
 installed in module 625 × 625 mm

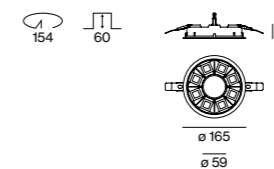
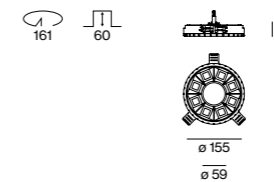

MITA circle 160 trimless



DIRECT

INSET POWER	COLOUR TEMP.	LUMINOUS FLUX	ORDER CODE
6.6 W 22 Vf 300 mA	3000 K 4000 K	1120 lm 1180 lm	0 7 4 - 8 2 2 2 :: 1 R

MITA circle 160 trim



DIRECT

INSET POWER	COLOUR TEMP.	LUMINOUS FLUX	ORDER CODE
6.6 W 22 Vf 300 mA	3000 K 4000 K	1120 lm 1180 lm	0 7 4 - 8 1 2 2 :: 1 R

Electrical accessories

POWER SUPPLY 220-240 V AC, 50-60 Hz, PC II

TYPE	EFFICIENCY	L-W-H (mm)	ORDER CODE
300 mA non DIM	η 89 %	147-44-22	0 0 2 - 9 1 1 2 2
300 mA DALI-2	η 87 %	97-43-30	0 0 2 - 9 1 1 2 0
375 mA DALI-2 DT8	η 83 %	129-79-30	0 0 2 - 9 1 1 2 1

DIN RAIL COMPONENTS

TYPE	W-H-D (mm)	ORDER CODE
POWER SUPPLY 220-240 V AC 96 W 48V DC constant voltage	90-90-60	0 0 5 - 6 5 2 0 2 1 0
LED DRIVER DALI-2 DT6 1-2 addr. 200-1050 mA settable const. current 2 × 42W 48V DC U _{OUT} 10-40 V	36-88-59	0 0 5 - 6 1 2 1 0 3 0

for more details and components see page 981

Accessories

SASSO 60 SPOTLIGHT

TYPE	ORDER CODE
SASSO 60 round adjustable	see page 135
SASSO 60 round downlight	see page 135

SASSO 60 SENSOR

TYPE	ORDER CODE
SASSO 60 ESSENTIAL sensor	see page 135
SASSO 60 SENSE sensor	see page 135

SASSO 60 EMERGENCY LIGHT

TYPE	ORDER CODE
SASSO 60 emergency light	see page 135



DIN EN 12464-1 UGR ≤ 19 trimless install. in plasterboard

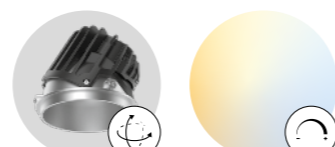

SASSO 60 inset ready tunable white 2700-6500K

Light distribution

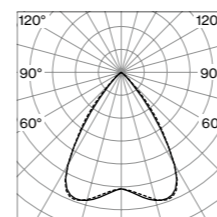

reflector (UGR ≤ 19)
 direct

INSET POWER in watts is the current consumption excluding any ballast
LUMINOUS FLUX value calculated for CRI ≥ 80, colour white, reflector chrome



ALLPLAN Österreich GmbH
Graz, AT

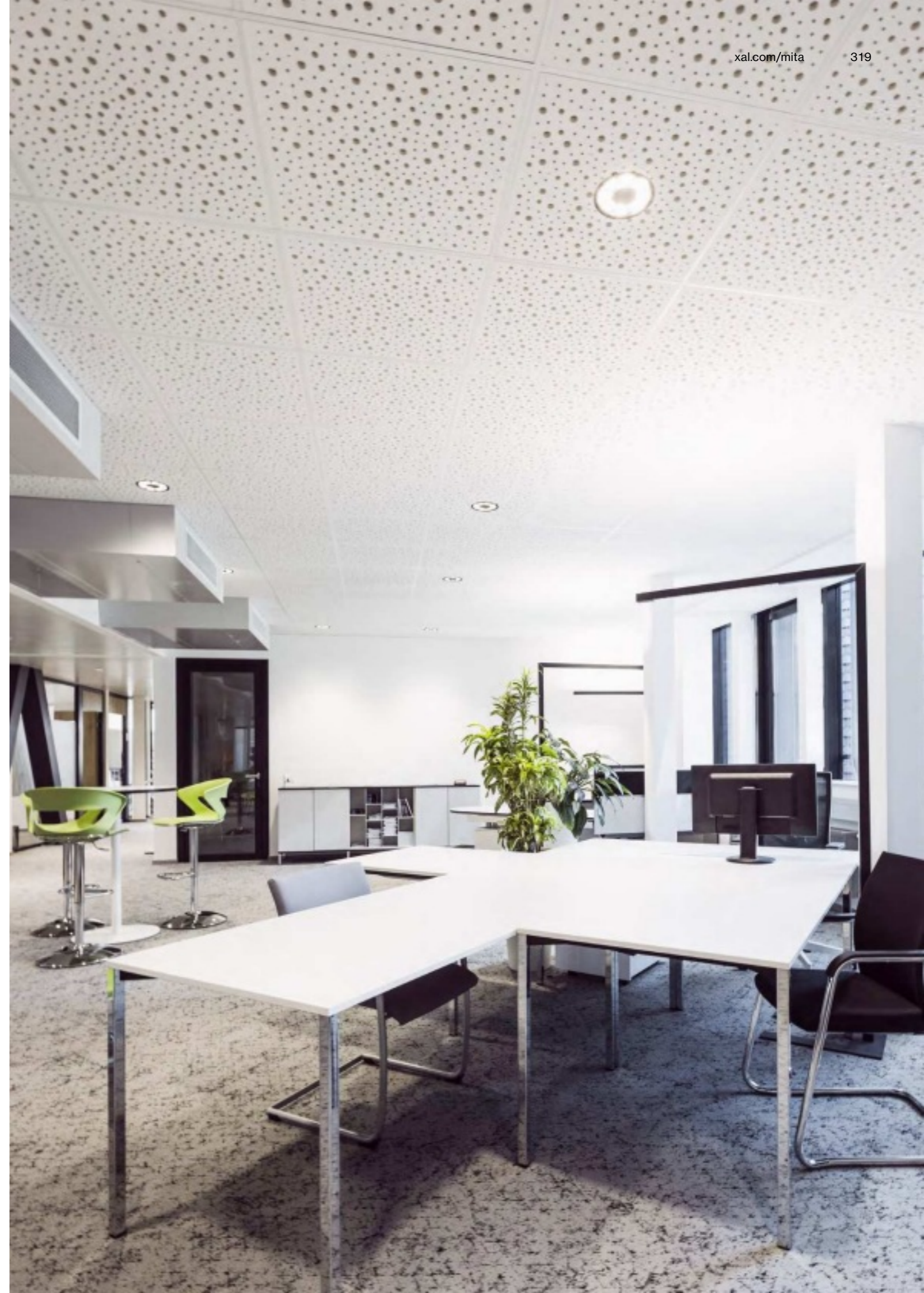

← back

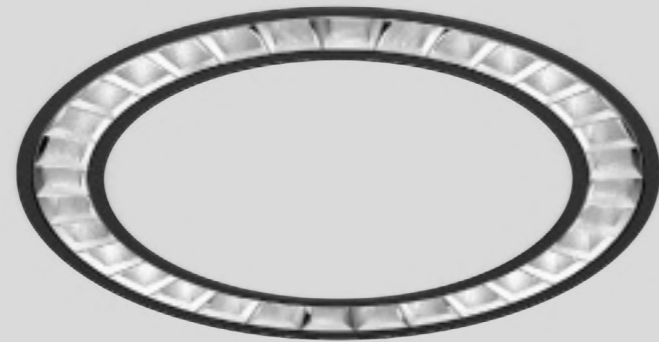

MITA circle 240 / 450

recessed with trim

EN Ring shaped luminaire housing in die-cast aluminium; extremely slim design; recessed luminaire with trim; optional: blind cover to cover the cut-out available as an accessory; suitable for ceiling thickness of 2-25 mm; surface powder coated; high-gloss reflector with faceted design; energy-efficient LEDs with very good colour rendering

DE Ringförmiger Leuchtenkörper aus Aluminiumdruckguss; extrem schlanke Bauform; Einbauleuchte mit umlaufendem Rand; optional: Blindabdeckung zum Einlegen im Innenausschnitt als Zubehör erhältlich; geeignet für Deckenstärken von 2-25 mm; Oberfläche pulverbeschichtet; hochglänzender Reflektor mit Facettenoptik; energieeffiziente LEDs mit sehr guter Farbwiedergabe

Quickinfo

3000K, 4000K, TW
 CRI ≥ 80, 3 SDCM
 UGR ≤ 19 / 65° ≤ 1500 cd/m²
 up to 134 lm/W
 L95 @ 50 000 h
 DALI-2
 reflector (UGR ≤ 19)

Types

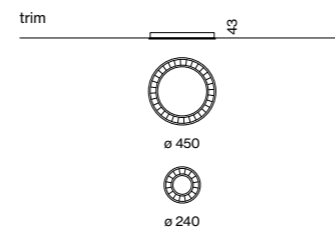

Colours



Light distribution

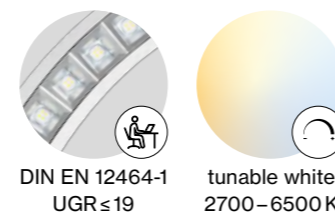

Order options

COLOUR TEMPERATURE	
3000K	5
4000K	6
tunable white 2700-6500K*	D
*DALI-2 DT8	

CONTROL

DALI-2

MATERIAL COLOUR

○ pure white RAL 9010	7
● jet black RAL 9005	8

LIGHT OPTIC COVER

reflector (UGR ≤ 19)

Options on request

COLOUR RENDERING INDEX
 CRI ≥ 90

GRID CEILING MOUNTING

installed in module 600 × 600 mm
 installed in module 625 × 625 mm

INLAY

sensor
 emergency light

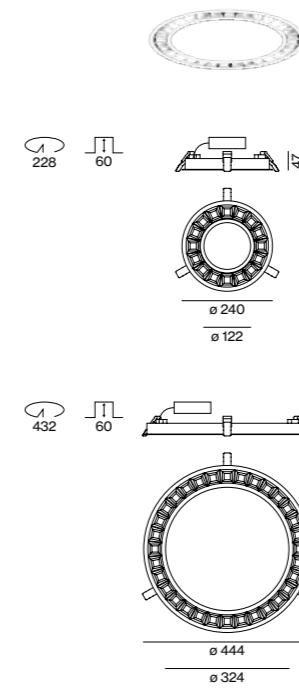

MITA circle 240 trim



DIRECT

SYSTEM POWER	COLOUR TEMP.	LUMINOUS FLUX	ORDER CODE
14.2 W	3000 K	2080 lm	074-8114::3R
	4000 K	2200 lm	

MITA circle 450 trim



DIRECT

SYSTEM POWER	COLOUR TEMP.	LUMINOUS FLUX	ORDER CODE
31 W	3000 K	4510 lm	074-8116::3R
	4000 K	4750 lm	
42 W	3000 K	5830 lm	074-8126::3R
	4000 K	6140 lm	

Accessories

BLIND COVER

TYPE	ORDER CODE
MITA 240 circle recessed	074-891141
MITA 450 circle recessed	074-891161

Light distribution

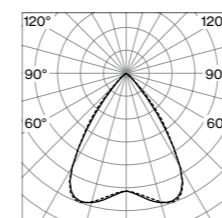

reflector (UGR ≤ 19)
 direct

LUMINOUS FLUX value calculated for
 CRI ≥ 80, colour white, reflector chrome

Endress + Hauser GmbH

Vienna, AT – by FOKURA Luxury Interior /
Reinhard Strepfl with lighting design by
TB Heil & Schafzahl GmbH / Ing. Gerhard Heil



ALLPLAN Österreich GmbH
Graz, AT



← back



MITA square

recessed with trim

EN Square luminaire housing in die-cast aluminium; extremely slim design; recessed luminaire with trim; optional: blind cover to cover the cut-out available as an accessory; suitable for ceiling thickness of 2-25 mm; surface powder coated; high-gloss reflector with faceted design; energy-efficient LEDs with very good colour rendering

DE Quadratischer Leuchtenkörper aus Aluminiumdruckguss; extrem schlanke Bauform; Einbauleuchte mit umlaufendem Rand; optional: Blindabdeckung zum Einlegen im Innenausschnitt als Zubehör erhältlich; geeignet für Deckenstärken von 2-25 mm; Oberfläche pulverbeschichtet; hochglänzender Reflektor mit Facettenoptik; energieeffiziente LEDs mit sehr guter Farbwiedergabe

Quickinfo

3000K, 4000K, TW
CRI ≥ 80, 3 SDCM
UGR ≤ 19 / 65° ≤ 1500 cd/m²
up to 155 lm/W
L95 @ 50 000 h
DALI-2
reflector (UGR ≤ 19)

Types

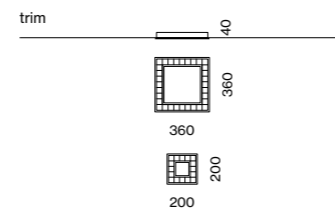

Colours



Light distribution



direct

Order options

COLOUR TEMPERATURE 
3000K 5
4000K 6
tunable white 2700–6500 K* D
*DALI-2 DT8

CONTROL

DALI-2

MATERIAL COLOUR

pure white RAL 9010 7
 jet black RAL 9005 8

LIGHT OPTIC COVER

reflector (UGR ≤ 19)

Options on request

COLOUR RENDERING INDEX
CRI ≥ 90

GRID CEILING MOUNTING

installed in module 600 × 600 mm
installed in module 625 × 625 mm

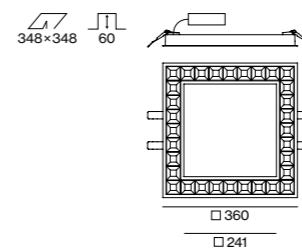
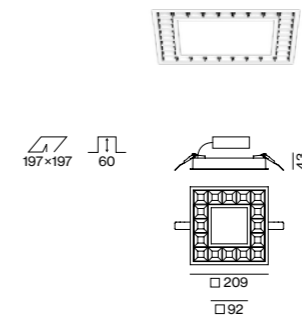

MITA square 200 trim



DIRECT

SYSTEM POWER	COLOUR TEMP.	LUMINOUS FLUX	ORDER CODE
14.2 W	3000 K	2080 lm	0 7 4 - 8 3 1 4 :: 3 R
	4000 K	2200 lm	

MITA square 360 trim



DIRECT

SYSTEM POWER	COLOUR TEMP.	LUMINOUS FLUX	ORDER CODE
31 W	3000 K	4510 lm	0 7 4 - 8 3 1 6 :: 3 R
	4000 K	4750 lm	
42 W	3000 K	5830 lm	0 7 4 - 8 3 2 6 :: 3 R
	4000 K	6150 lm	

Accessories

BLIND COVER

TYPE	ORDER CODE
MITA 200 square recessed	0 7 4 - 8 9 1 3 4 1 R
MITA 360 square recessed	0 7 4 - 8 9 1 3 6 1 R



suitable for plaster-board or grid ceilings



DIN EN 12464-1
UGR ≤ 19

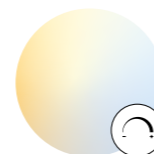

tunable white
2700–6500 K

Light distribution

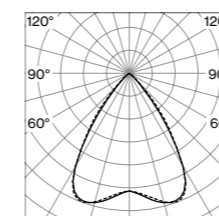

reflector (UGR ≤ 19)
direct

LUMINOUS FLUX value calculated for
CRI ≥ 80, colour white, reflector chrome



Classroom
Visualisation

← back



MITA circle

ceiling

EN Ring shaped luminaire housing in die-cast aluminium; extremely slim design (only 42 x 42 mm); surface powder coated; luminaire housing set away from ceiling; electronic operating unit installed in the surface mounted housing; surface mounted housing aligned from the ring to the center; optional: blind cover to cover the cut-out, held by magnet, available as an accessory; high-gloss reflector with faceted design; HPO (High Performance Opal) cover for uniform illumination; either with direct or indirect light distribution; energy-efficient LEDs with very good colour rendering

DE Ringförmiger Leuchtenkörper aus Aluminiumdruckguss; extrem schlanke Bauform (nur 42 x 42 mm); Oberfläche pulverbeschichtet; Leuchtenkörper von der Decke abgesetzt; elektronisches Betriebsgerät im Anbauehäuse verbaut; Anbauehäuse vom Ring ins Zentrum ausgerichtet; optional: Blindabdeckung, mittels Magnet im Innenausschnitt befestigt, als Zubehör erhältlich; hochglänzender Reflektor mit Facettenoptik; HPO (High Performance Opal) Abdeckung für homogene Ausleuchtung; wahlweise mit direkter bzw. direkt/indirekter Abstrahlcharakteristik; energieeffiziente LEDs mit sehr guter Farbwiedergabe

Quickinfo

3000K, 4000K, TW
CRI ≥ 80, 3 SDCM
UGR ≤ 19 / 65° ≤ 1500 cd/m²
up to 146 lm/W
L90 @ 50 000 h
DALI-2, DALI-2 sensor
reflector (UGR ≤ 19), opal

Types

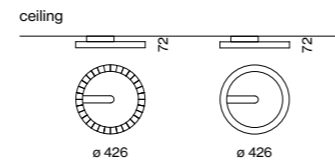

Colours



Light distributions

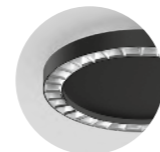

version with
opal cover



magnetic
blind cover



DIN EN 12464-1
UGR ≤ 19

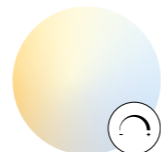

tunable white
2700–6500K

Order options

COLOUR TEMPERATURE

3000K	5
4000K	6
tunable white 2700–6500K*	D

*DALI-2 DT8

CONTROL

DALI-2	3
DALI-2 ESSENTIAL sensor (brightness & presence)	B
DALI-2 SENSE sensor (brightness, presence, temp., sound pressure, humidity, CO ₂)	P

MATERIAL COLOUR

○ pure white RAL 9010	7
● jet black RAL 9005	8

LIGHT OPTIC COVER

reflector _____
opal _____

Options on request

COLOUR RENDERING INDEX
CRI ≥ 90

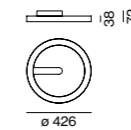
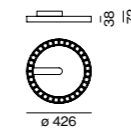
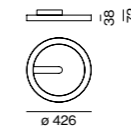
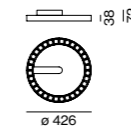

MITA circle 450 ceiling



REFLECTOR DIRECT

SYSTEM POWER	COLOUR TEMP.	LUMINOUS FLUX	ORDER CODE
31W	3000K	4510 lm	074-75111
42W	3000K	5830 lm	074-75211
	4000K	4750 lm	
	4000K	6140 lm	

OPAL DIRECT

SYSTEM POWER	COLOUR TEMP.	LUMINOUS FLUX	ORDER CODE
27W	3000K	2650 lm	074-75111
	4000K	2810 lm	



REFLECTOR DIRECT / INDIRECT SOFT

SYSTEM POWER	COLOUR TEMP.	LUMINOUS FLUX	ORDER CODE
31W	3000K	↓ 4370 / ± 140 lm	074-75311
42W	3000K	↓ 4610 / ± 140 lm	
	3000K	↓ 5660 / ± 170 lm	074-75611
	4000K	↓ 5960 / ± 180 lm	

OPAL DIRECT / INDIRECT SOFT

SYSTEM POWER	COLOUR TEMP.	LUMINOUS FLUX	ORDER CODE
27W	3000K	↓ 2570 / ± 80 lm	074-75311
	4000K	↓ 2730 / ± 80 lm	

Accessories

BLIND COVER

TYPE	ORDER CODE
MITA circle 450 ceiling	074-891162
MITA circle 450 ceiling sensor	074-891163

Light distribution

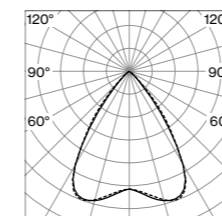

reflector (UGR ≤ 19)
direct

LUMINOUS FLUX value calculated for
CRI ≥ 80, colour white, reflector chrome

Conference room
Visualisation



All-round performer



COMBO

EN COMBO has a narrow trim and is perfectly integrated into the ceiling. It creates a calm, even ceiling appearance with pleasant and uniform room illumination. The circular luminaire owes this to its opal cover. COMBO's microprismatic cover variant reduces the glare value to $UGR \leq 19$: ideal for standard-compliant computer workstations. Depending on the desired lighting mood, COMBO is available in the light colours 3000 K, 4000 K, or Tunable White.

DE Ein schmaler Rand, bestmöglich integriert in die Raumdecke: COMBO erzeugt ein ruhiges, einheitliches Deckenbild bei angenehmer und gleichmäßiger Raumausleuchtung. Diese verdankt die Rundleuchte ihrem Opal-Cover. In der Version mit mikroprismatischer Abdeckung reduziert COMBO den Blendwert auf $UGR \leq 19$ – ideal für den normgerechten Bildschirmarbeitsplatz. Je nach gewünschter Lichtstimmung ist COMBO in den Lichtfarben 3000 K, 4000 K oder Tunable White verfügbar.

Types

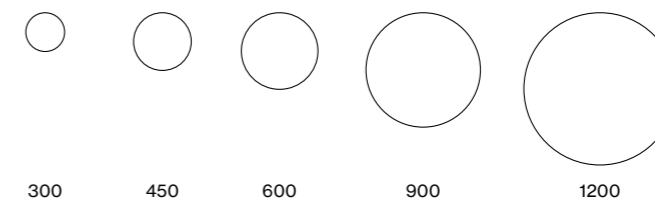

Mounting

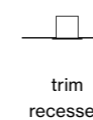

Light distributions

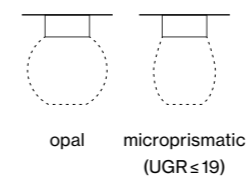

← back

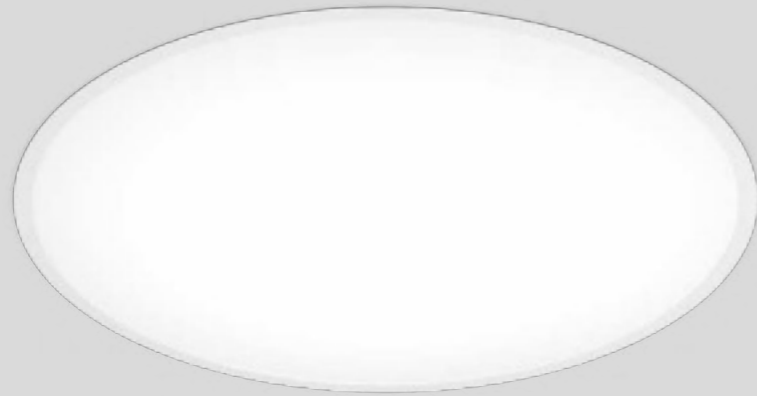

COMBO

recessed with trim

EN Round luminaire housing in aluminium with trim; suitable for installation in plasterboard ceilings; suitable for ceiling thickness of 10-25 mm; surface powder coated; up to ø600 mm: installation without tools using snap spring closure; highly reflective coating of the PCB for improved efficiency; completely homogeneously illuminated, satinised or microprismatic PMMA cover; energy-efficient LEDs with very good colour rendering; external converter for ceiling insertion, for through-wiring suitable

DE Runder Leuchtenkörper aus Aluminium mit umlaufendem Rand; geeignet für den Einbau in Gipskartondecken; geeignet für Deckenstärken von 10-25 mm; Oberfläche pulverbeschichtet; bis ø600 mm werkzeuglose Montage mittels Schnappfederverschluss; hochreflektierende Beschichtung der Platine für verbesserten Wirkungsgrad; absolut homogen ausgeleuchtete, satinierte oder mikroprismatische PMMA-Abdeckung; energieeffiziente LEDs mit sehr guter Farbwiedergabe; externer Konverter für Deckeneinwurf, für Weiterverdrahtung geeignet

Quickinfo

3000K, 4000K
 CRI ≥ 80, 3 SDCM
 UGR ≤ 19 / 65° ≤ 3000 cd/m²
 up to 145 lm/W
 L90 @ 50 000h
 non DIM, DALI-2
 opal, microprismatic (UGR ≤ 19)

Types

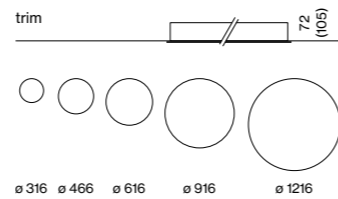

Colour



Light distribution



direct

Order options

COLOUR TEMPERATURE ☰
 3000K 5
 4000K 6

CONTROL ⬆
 non DIM 1
 DALI-2 3

MATERIAL COLOUR
 pure white RAL 9010

LIGHT OPTIC COVER ☑
 opal O
 microprismatic (UGR ≤ 19) K

Options on request

COLOUR RENDERING INDEX
 CRI ≥ 90

COLOUR TEMPERATURE
 tunable white 2700-6500K (2 × DALI)

EMERGENCY LIGHT
 1h accupack
 3h accupack



Data Monitoring
 DiiA® standards
 251, 252, 253



DIN EN 12464-1
 UGR ≤ 19

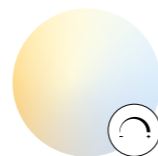

tunable white
 2700-6500K

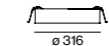
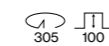

COMBO 300 trim



DIRECT		ORDER CODE	
SYSTEM POWER	COLOUR TEMP.	LUMINOUS FLUX	
10.1W	3000K	993 lm	064-1031 ☰ 7 ☑
	4000K	1050 lm	

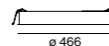
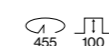

COMBO 450 trim



DIRECT		ORDER CODE	
SYSTEM POWER	COLOUR TEMP.	LUMINOUS FLUX	
16.7W	3000K	2050 lm	064-1041 ☰ 7 ☑
	4000K	2170 lm	

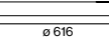
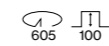

COMBO 600 trim



DIRECT		ORDER CODE	
SYSTEM POWER	COLOUR TEMP.	LUMINOUS FLUX	
31W	3000K	4020 lm	064-1051 ☰ 7 ☑
	4000K	4250 lm	

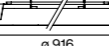
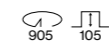

COMBO 900 trim



DIRECT		ORDER CODE	
SYSTEM POWER	COLOUR TEMP.	LUMINOUS FLUX	
58W	3000K	7440 lm	064-1071 ☰ 3 7 ☑
	4000K	7880 lm	

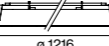
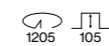

COMBO 1200 trim



DIRECT		ORDER CODE	
SYSTEM POWER	COLOUR TEMP.	LUMINOUS FLUX	
92W	3000K	12610 lm	064-1081 ☰ 3 7 ☑
	4000K	13350 lm	

Accessories

MOUNTING RING FOR ACOUSTIC CEILING

TYPE	ORDER CODE
COMBO 300	064-1906300
COMBO 450	064-1906400
COMBO 600	064-1906500
COMBO 900	064-1906700
COMBO 1200	064-1906800

LUMINOUS FLUX value calculated for CRI ≥ 80, colour white, cover opal

Raiffeisenbank Gmunden Salzkammergut, AT –
by INNOCAD Architektur ZT



Hargassner Energy World Linz, AT –
by architekten berger.hofmann og & tech3
Projektentwicklung GmbH with lighting design
by AREA C.I.DESIGN GmbH



Timeless perfection



VELA

EN As one of XAL's first round luminaires, VELA has been perfected over the years. Innovative technology hides behind its flat, minimalistic design. VELA surface can be wall or ceiling mounted. The suspended version has either a classic cable suspension or a chrome-plated pendulum tube suspension that can be shortened. To adapt to a variety of interior designs, VELA is available in an extensive colour palette and in the light colours 3000K, 4000K, or Tunable White (2700K–6500K) on request. A microprismatic cover is ideal for workstations. An opal cover provides homogeneous basic lighting. An optional direct/indirect beam characteristic illuminates the ceiling and creates ambience.

DE VELA war eine der ersten XAL-Rundleuchten und wurde über die Jahre konstant perfektioniert. In ihrem flachen, reduzierten Design verbirgt sich innovative Technologie. Während VELA surface für Wand- und Deckenanbau geeignet ist, verfügt die abgehängte Variante wahlweise über eine klassische Seilabhängung oder eine verchromte, individuell kürzbare Pendelrohrabhängung. Um sich einer Vielzahl an Innenraumgestaltungen anzupassen, ist VELA in einer großen Farbpalette und in den Lichtfarben 3000K, 4000K oder optional als Tunable White (2700K–6500K) erhältlich. Je nach Abdeckung kommt sie mikroprismatisch am Arbeitsplatz oder opal für homogene Grundausleuchtung zum Einsatz. Eine optionale direkt/indirekte Abstrahlcharakteristik erhellt die Decke und schafft Ambiente.

Types

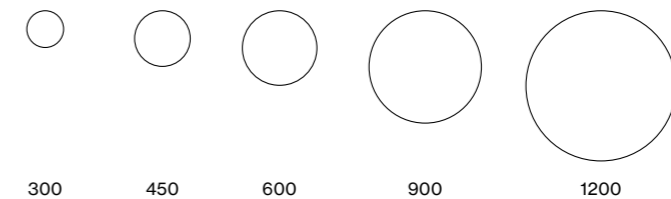

Mountings

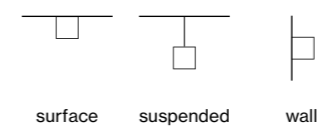

Light distributions

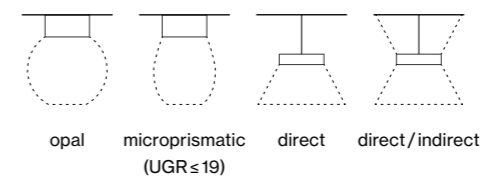

← back



VELA

surface

EN Round luminaire housing in aluminium, rolled profile, seamlessly welded; surface powder coated; quick mounting system without tools; highly reflective coating of the PCB for improved efficiency; completely homogeneously illuminated, satinised PMMA cover; up to ø600mm: microprismatic PMMA cover; either with direct or direct/indirect light distribution; energy-efficient LEDs with very good colour rendering; luminaire with 2 cable openings and plug-in terminals for through wiring

DE Runder Leuchtenkörper aus Aluminium, gerolltes Profil, nahtlos verschweißt; Oberfläche pulverbeschichtet; werkzeugloses Schnellmontagesystem; hochreflektierende Beschichtung der Platine für verbesserten Wirkungsgrad; absolut homogen ausgeleuchtete, satinierte PMMA-Abdeckung; bis ø600mm: mikroprismatische PMMA-Abdeckung; wahlweise mit direkter bzw. direkt/indirekter Abstrahlcharakteristik; energieeffiziente LEDs mit sehr guter Farbwiedergabe; Leuchte mit 2 Kabelöffnungen und Steckklemme für Weiterverdrahtung

Quickinfo

3000K, 4000K
 CRI ≥ 80, 3 SDCM
 UGR ≤ 19 / 65° ≤ 3000 cd/m²
 up to 153 lm/W
 L90 @ 50 000h
 non DIM, DALI-2
 opal, microprismatic (UGR ≤ 19)

Types

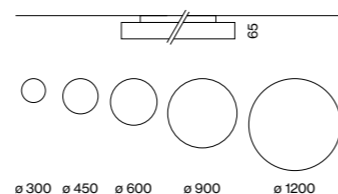

Colours



Light distributions



DiiA® standards
 251, 252, 253



DIN EN 12464-1
 UGR ≤ 19



easy mounting
 (click-system)

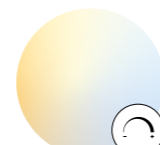

tunable white
 2700-6500K

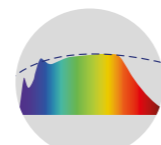

CRI ≥ 98
 XPECTRUM

Order options

COLOUR TEMPERATURE	
3000K	5
4000K	6

CONTROL	
non DIM	1
DALI-2	3

MATERIAL COLOUR	
○ pure white RAL 9010	7
● white aluminium RAL 9006	G
● jet black RAL 9005	8
● special colours p.992	X

LIGHT OPTIC COVER	
opal high performance	O
microprismatic (UGR ≤ 19)	K

Options on request

COLOUR RENDERING INDEX	
CRI ≥ 90	
CRI ≥ 98 XPECTRUM	

COLOUR TEMPERATURE	
tunable white 2700-6500K	
DALI-2 DT8	

EMERGENCY LIGHT	
1h accupack	
3h accupack	
not available for VELA 300	

Light distributions

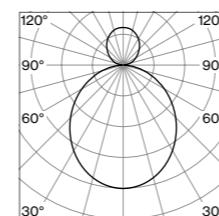

opal high performance
 direct/indirect power

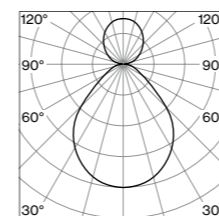

microprismatic
 direct/indirect power

LUMINOUS FLUX value calculated for
 4000K, CRI ≥ 80, colour white, cover opal
 3000K -5%

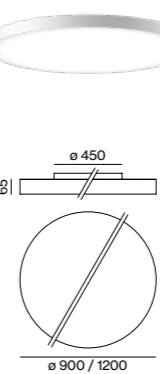
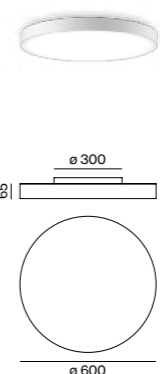
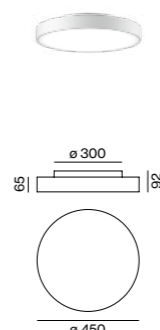
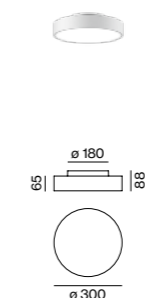

VELA 300 surface



DIRECT		LUMINOUS FLUX		ORDER CODE	
SYSTEM POWER	10.1W	1050lm		073-1131	3 3 3
	16.5W	1800lm		073-1132	3 3 3

DIRECT/INDIRECT SOFT		LUMINOUS FLUX		ORDER CODE	
SYSTEM POWER	10.1W	↓ 1110/↑ 54lm		073-1137	3 3 3
	16.5W	↓ 1900/↑ 92lm		073-1138	3 3 3

VELA 450 surface



DIRECT		LUMINOUS FLUX		ORDER CODE	
SYSTEM POWER	16.7W	2170lm		073-1141	3 3 3
	30W	3620lm		073-1142	3 3 3

DIRECT/INDIRECT SOFT		LUMINOUS FLUX		ORDER CODE	
SYSTEM POWER	16.7W	↓ 2140/↑ 84lm		073-1147	3 3 3
	30W	↓ 3580/↑ 140lm		073-1148	3 3 3

VELA 600 surface



DIRECT		LUMINOUS FLUX		ORDER CODE	
SYSTEM POWER	31W	4250lm		073-1151	3 3 3
	42W	5600lm		073-1150	3 3 3
	48W	6290lm		073-1152	3 3 3

DIRECT/INDIRECT SOFT		LUMINOUS FLUX		ORDER CODE	
SYSTEM POWER	31W	↓ 4220/↑ 118lm		073-1157	3 3 3
	42W	↓ 5560/↑ 155lm		073-1156	3 3 3
	48W	↓ 6250/↑ 632lm		073-1158	3 3 3

VELA 900 ceiling



DIRECT		LUMINOUS FLUX		ORDER CODE	
SYSTEM POWER	71W	9520lm		073-1171	3 3 3

VELA 1200 ceiling



DIRECT		LUMINOUS FLUX		ORDER CODE	
SYSTEM POWER	147W	20600lm		073-1181	3 3 3

Accessories

TYPE		ORDER CODE	
dismounting tool (for ø600/900/1200)		073-1100000	

Optician and Eyeware Külling
St. Gallen, CH –
by HEIKAUS Concept GmbH

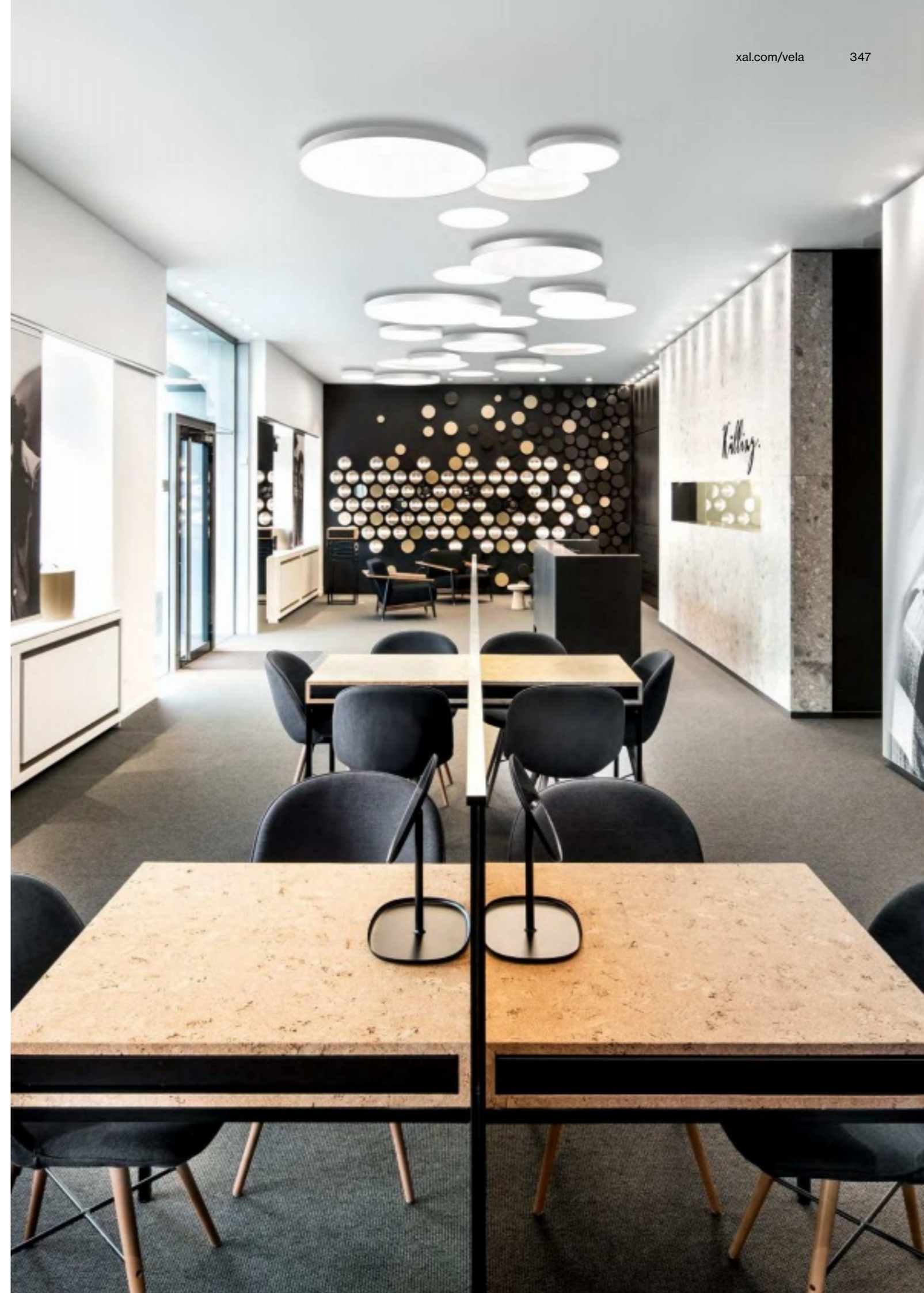

← back



VELA

suspended

EN Round luminaire housing in aluminium, rolled profile, seamlessly welded; surface powder coated; suspended; with integrated tool-less suspension height adjustment; incl. transparent feed or with height adjustable rod suspension (chrome), feed in rod; highly reflective coating of the PCB for improved efficiency; completely homogeneously illuminated, satinised PMMA cover; up to ø600 mm: microprismatic PMMA cover; either with direct or direct/indirect light distribution; indirect component with special PCBs for increased luminous flux and maximum ceiling illumination; energy-efficient LEDs with very good colour rendering; canopy with 2 cable openings and plug-in terminal for through wiring

DE Runder Leuchtenkörper aus Aluminium, gerolltes Profil, nahtlos verschweißt; Oberfläche pulverbeschichtet; abgependelt; werkzeuglose Höhenverstellung an der Leuchte; inkl. transparenter Einspeiseleitung oder mit kürzbarer Pendelrohrabhängung (chrom), Einspeiseleitung in Pendelrohr; hochreflektierende Beschichtung der Platine für verbesserten Wirkungsgrad; absolut homogen ausgeleuchtete, satinierte PMMA-Abdeckung; bis ø600 mm: mikroprismatische PMMA-Abdeckung; wahlweise mit direkter bzw. direkt/indirekter Abstrahlcharakteristik; Indirektlichtanteil mit eigenen Platinen für erhöhten Lichtstrom und maximale Deckenaufhellung; energieeffiziente LEDs mit sehr guter Farbwiedergabe; Baldachin mit 2 Kabelöffnungen und Steckklemme für Weiterverdrahtung

Quickinfo

3000K, 4000K
 CRI ≥ 80, 3 SDCM
 UGR ≤ 19 / 65° ≤ 3000 cd/m²
 up to 153 lm/W
 L90 @ 50 000 h
 non DIM, DALI-2
 opal, microprismatic (UGR ≤ 19)

Types

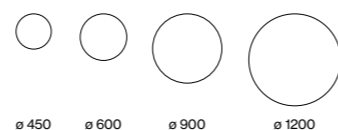
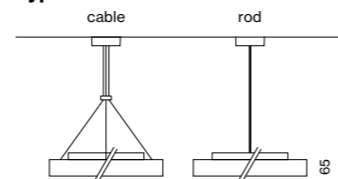

Colours



Light distributions



DiiA® standards
 251, 252, 253



DIN EN 12464-1
 UGR ≤ 19



direct/indirect
 illumination

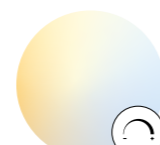

tunable white
 2700–6500K

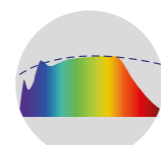

CRI ≥ 98
 XPECTRUM

Order options

SUSPENSION
 cable 1500mm 2
 rod 1000mm 4

COLOUR TEMPERATURE
 3000K 5
 4000K 6

CONTROL
 non DIM 1
 DALI-2 3

MATERIAL COLOUR
 pure white RAL 9010 7
 white aluminium RAL 9006 8
 jet black RAL 9005 8
 special colours* p. 992 X
 *canopy always in white

LIGHT OPTIC COVER
 opal high performance O
 microprismatic (UGR ≤ 19) K

Options on request

COLOUR RENDERING INDEX
 CRI ≥ 90
 CRI ≥ 98 XPECTRUM

SUSPENSION
 rod 2000mm

COLOUR TEMPERATURE
 tunable white 2700–6500K
 DALI-2 DT8

EMERGENCY LIGHT
 1h accupack
 3h accupack

Light distributions

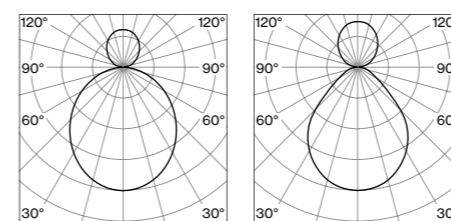

opal high performance
 direct/indirect power
 microprismatic
 direct/indirect power

LUMINOUS FLUX value calculated for
 4000K, CRI ≥ 80, colour white, cover opal
 3000K -5%

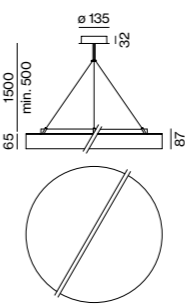
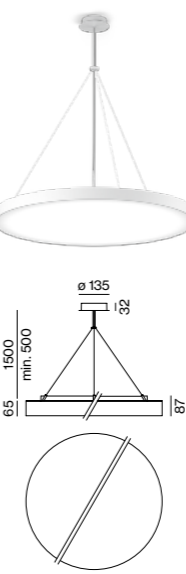
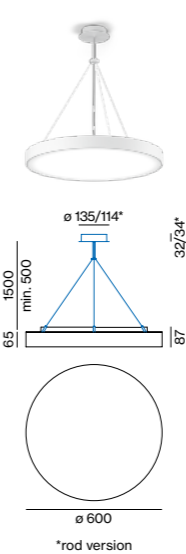
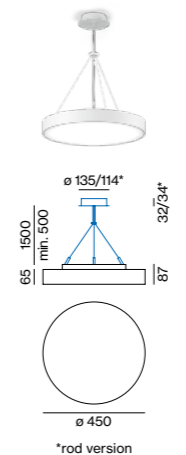

VELA 450 suspended



DIRECT		LUMINOUS FLUX		ORDER CODE	
SYSTEM POWER	16.7W	2170lm		073-1	41
	30W	3620lm		073-1	42



DIRECT / INDIRECT POWER		LUMINOUS FLUX		ORDER CODE	
SYSTEM POWER	21.1W	↓ 2070 / ↑ 812lm		073-1	44
	35W	↓ 3250 / ↑ 1270lm		073-1	45

VELA 600 suspended



DIRECT		LUMINOUS FLUX		ORDER CODE	
SYSTEM POWER	31W	4250lm		073-1	51
	42W	5600lm		073-1	50
	48W	6290lm		073-1	52



DIRECT / INDIRECT POWER		LUMINOUS FLUX		ORDER CODE	
SYSTEM POWER	45W	↓ 4350 / ↑ 1970lm		073-1	54
	68W	↓ 6290 / ↑ 2850lm		073-1	55

VELA 900 suspended



DIRECT		LUMINOUS FLUX		ORDER CODE	
SYSTEM POWER	71W	9520lm		073-1	271



DIRECT / INDIRECT POWER		LUMINOUS FLUX		ORDER CODE	
SYSTEM POWER	96W	↓ 9520 / ↑ 4670lm		073-1	274

VELA 1200 suspended



DIRECT		LUMINOUS FLUX		ORDER CODE	
SYSTEM POWER	147W	20600lm		073-1	281



DIRECT / INDIRECT POWER		LUMINOUS FLUX		ORDER CODE	
SYSTEM POWER	185W	↓ 20600 / ↑ 6060lm		073-1	284

Hostpoint AG
Rapperswil-Jona, CH –
by Büronauten AG



MASCHAGENCY GmbH & Co. kg
Munich, DE – by Gruschwitz GmbH



Sparkasse Berlin, DE –
by blocher partners



For heavy-duty use



SONO

EN The SONO family of circular luminaires was created especially for heavy-duty use. It has increased dust and insect protection (IP50), and is characterised by an all-round robust housing (IK07). In addition, the SONO IP54 offers increased moisture protection. The SONO Flex recessed luminaire can be recessed or fixed in two positions by employing the Jut-Out function. This can minimise the contrast between the luminaire and ceiling, or change the appearance in the room. As a mounted luminaire, SONO ensures homogeneous ambient illumination thanks to its narrow frame and opal cover. All versions are available in the light colours 3000K, 4000K, or Tunable White.

DE Die Rundleuchten-Familie SONO wurde speziell für starke Beanspruchung geschaffen. Sie verfügt über einen erhöhten Staub- und Insektenschutz (IP50) und zeichnet sich durch ein rundum robustes Gehäuse (IK07) aus. Zusätzlich bietet die SONO IP54 einen erhöhten Feuchtigkeitsschutz. Die Einbauleuchte SONO Flex kann versenkt oder mittels Jut-Out Funktion hervorstehend in zwei Positionen fixiert werden: ideal, um den Kontrast zwischen Leuchte und Decke zu minimieren oder die Erscheinung im Raum zu verändern. Als Anbau-Variante sorgt SONO dank ihres schmalen Rahmens und der Opal-Abdeckung für eine homogene Umgebungsbeleuchtung. Alle Varianten sind in den Lichtfarben 3000K, 4000K oder Tunable White verfügbar.

Types



260

350

450

600

Mountings

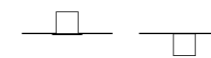
flex trim
recessed

surface

Light distributions

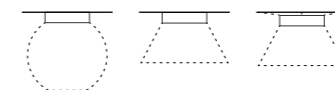

opal

direct

direct/indirect

Jut-Out

EN The SONO Flex recessed luminaire can assume two positions: recessed into the ceiling or protruding through its Jut-Out function. This allows a change of its effect in a room and the luminaire can either be accentuated or visually blended into the surroundings.

DE Die Einbauleuchte SONO Flex kann zwei Positionen einnehmen: versenkt in die Decke oder hervorstehend durch Jut-Out-Funktion. Dadurch lässt sich die Raumwirkung verändern und die Leuchte kann entweder betont oder optisch in die Umgebung eingefügt werden.



Homogenous quality

EN As a recessed luminaire, SONO blends harmoniously into the ceiling. Thanks to its narrow frame and opal cover, the SONO surface-mounted version provides soft, homogeneous ambient light.

DE Als Einbauleuchte integriert sich SONO harmonisch in die Raumdecke. Die SONO Anbau-Variante sorgt dank ihres schmalen Rahmens und der Opal-Abdeckung für ein rundum weich abstrahlendes, homogenes Umgebungslicht.

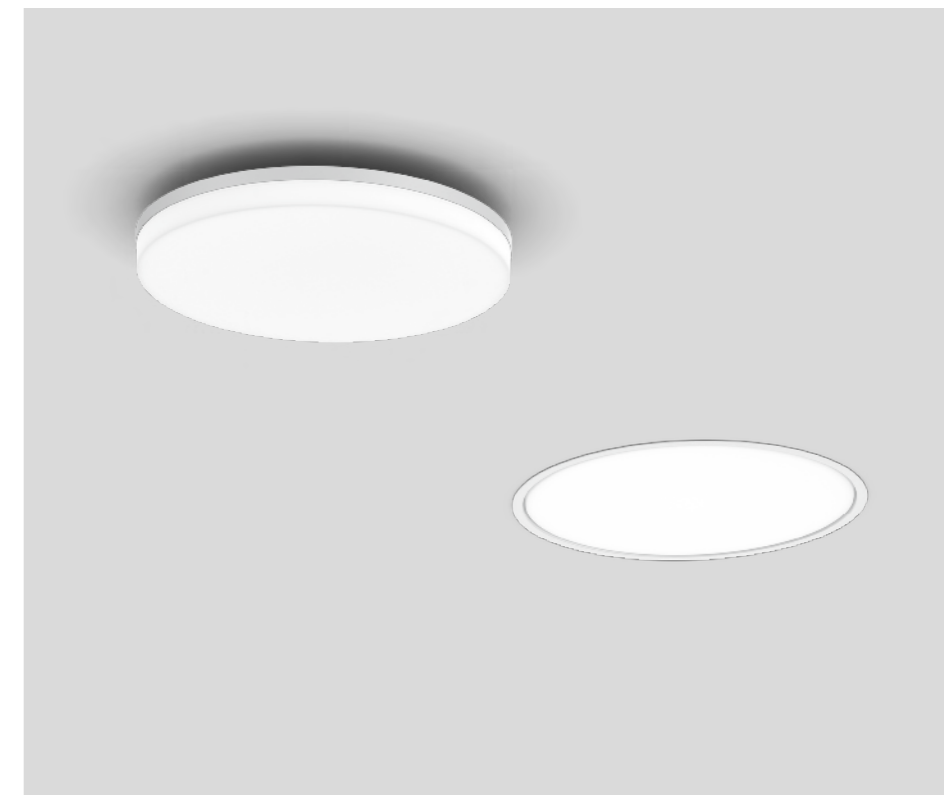

Smart controls

EN Thanks to an implemented Radar Control System (RCS), SONO reacts to lighting conditions and movements in its vicinity. Brightness and presence sensors wirelessly adjust the light output. The corridor function registers an individual and successively switches luminaires on and off, depending on the direction in which they are moving.

DE Durch ein implementiertes Radar Control System (RCS) reagiert SONO auf Lichtverhältnisse und Bewegungen im Umkreis. Helligkeits- bzw. Präsenzsensoren passen den Licht-Output drahtlos an. Die Korridorfunktion registriert eine Person und schaltet Leuchten sukzessive ein und aus – je nachdem, in welche Richtung sie sich bewegt.

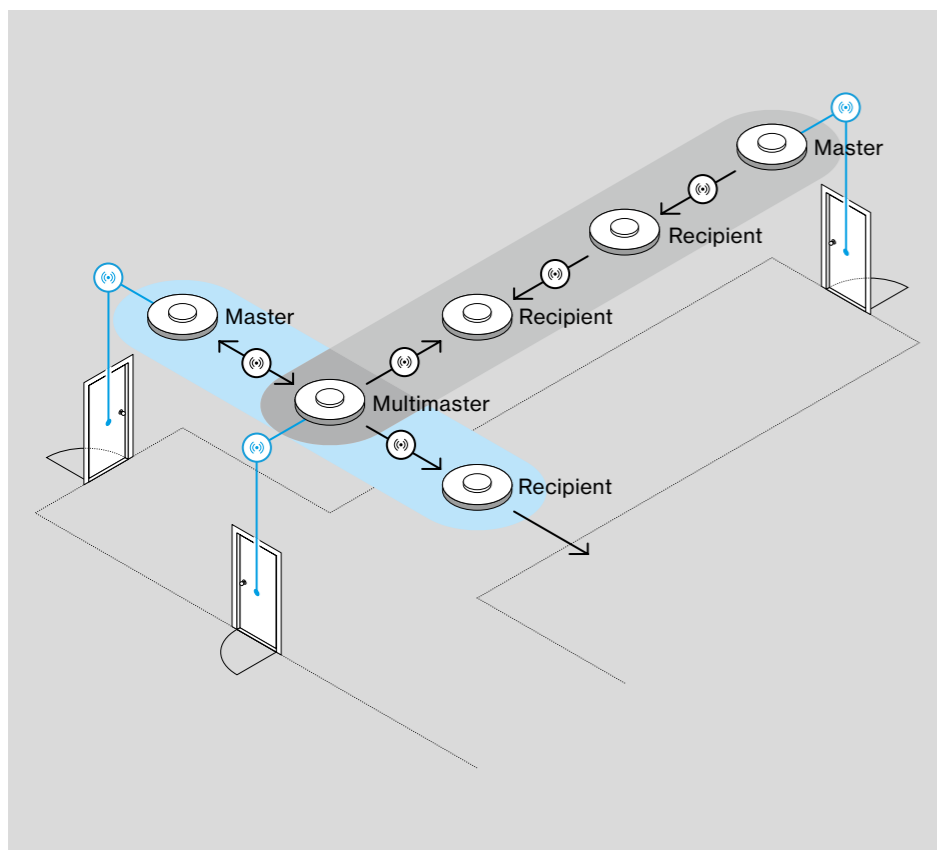

Robust housing

EN The SONO family of circular luminaires was created especially for heavy-duty use. It has increased dust and insect protection (IP 50), and is characterised by an all-round robust housing (IK 07).

DE Die Rundleuchten-Familie SONO wurde speziell für starke Beanspruchung geschaffen. Sie verfügt über einen erhöhten Staub- und Insektenschutz (IP 50) und zeichnet sich durch ein rundum robustes Gehäuse (IK 07) aus.

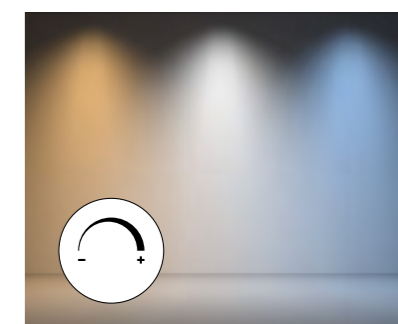

TW – Tunable White

EN Changes in the colour of light have a substantial effect on our mood. Tunable White allows the colour temperature to be continuously adjusted from 2700 K (warm light) to 6500 K (cool light) to dynamically adapt the lighting to the time of day or ambient brightness.

DE Veränderungen in der Lichtfarbe haben eine starke Wirkung auf unsere Stimmung. Tunable White ermöglicht die stufenlose Verschiebung der Farbtemperatur von 2700 K (warmes Licht) bis 6500 K (kühles Licht), um die Beleuchtung dynamisch an Uhrzeit oder Umgebungshelligkeit anzupassen.

← back

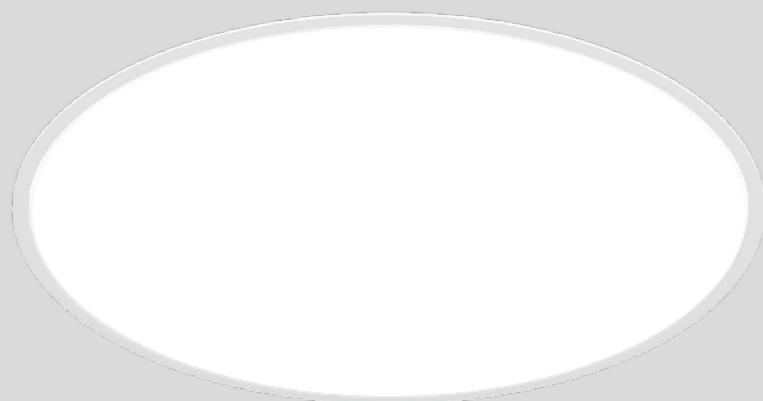

SONO flex

recessed with trim

EN Round recessed luminaire in aluminium, consisting of (SONO) light housing and recessed housing; housing with trim suitable for installation in plasterboard ceilings; suitable for ceiling thickness of 10-25 mm; optionally: installation in concrete ceilings with a special installation housing (available as an accessory); surface powder coated; luminaire installs in housing without tools optionally flush or protruding by 25 mm; completely homogeneously illuminated, satinised PMMA cover; same luminance for all size versions; energy-efficient LEDs with very good colour rendering; luminaire with 2 cable openings and plug-in terminals for through wiring

DE Runde Einbauleuchte aus Aluminium, bestehend aus Leuchtenkörper (SONO) und Einbaugehäuse; Gehäuse mit umlaufendem Rand geeignet für den Einbau in Gipskartondecken; geeignet für Deckenstärken von 10-25 mm; optional: Einbau in Betondecken mittels Betoneinbaugehäuse (als Zubehör erhältlich); Oberfläche pulverbeschichtet; Leuchte wahlweise deckenbündig oder 25 mm hervorstehend werkzeuglos im Gehäuse einsetzbar; absolut homogen ausgeleuchtete, satinierte PMMA-Abdeckung; gleiche Leuchtdichte bei allen Größenvarianten; energieeffiziente LEDs mit sehr guter Farbwiedergabe; Leuchte mit 2 Kabelöffnungen und Steckklemme für Weiterverdrahtung

Quickinfo

3000K, 4000K
CRI ≥ 80, 3 SDCM
up to 133lm/W
L90 @ 50 000h
non DIM, DALI-2
opal cover
IP50

Types

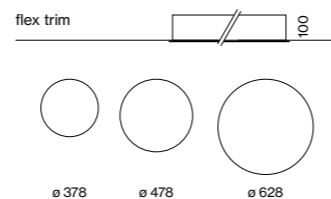

Colour



Light distribution



Order options

IP RATING
IP50

COLOUR TEMPERATURE
3000K 5
4000K 6

CONTROL
non DIM 1
DALI-2 3

MATERIAL COLOUR
pure white RAL 9010

LIGHT OPTIC COVER
opal

Options on request

COLOUR RENDERING INDEX
CRI ≥ 90

COLOUR TEMPERATURE
tunable white 2700-6500 K
DALI-2 DT8

CONTROL
RCS Master (☺)
RCS Slave (☺)

EMERGENCY LIGHT
3h accupack

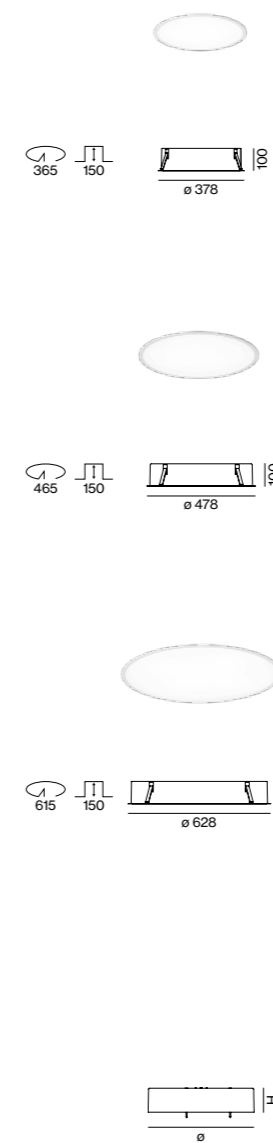

SONO FLEX 350 trim

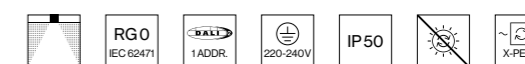

DIRECT		SYSTEM POWER	COLOUR TEMP.	LUMINOUS FLUX	ORDER CODE
15.9W	3000K	1940lm		063-3238::70	
	4000K	2060lm			

SONO FLEX 450 trim



DIRECT		SYSTEM POWER	COLOUR TEMP.	LUMINOUS FLUX	ORDER CODE
23.2W	3000K	2850lm		063-3248::70	
	4000K	3010lm			

SONO FLEX 600 trim



DIRECT		SYSTEM POWER	COLOUR TEMP.	LUMINOUS FLUX	ORDER CODE
43W	3000K	5410lm		063-3258::70	
	4000K	5730lm			

Accessories

CONCRETE INSTALLATION HOUSING

TYPE	Ø-H (mm)	ORDER CODE
SONO FLEX 350	364-107	063-2238100
SONO FLEX 450	464-107	063-2248100
SONO FLEX 600	614-107	063-2258100

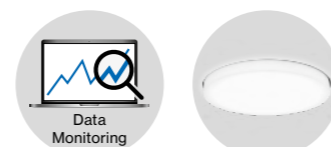

DiiA® standards 251, 252, 253
flexible jut out 0 or 25 mm



dust and insect protection (IP50)
tunable white 2700-6500K

LUMINOUS FLUX value calculated for CRI ≥ 80, colour white, cover opal



Volksschule Erlaaer Schleife
Vienna, AT – by ARGE Architekten
Kronaus – Mitterer/Vasko & Partner



← back

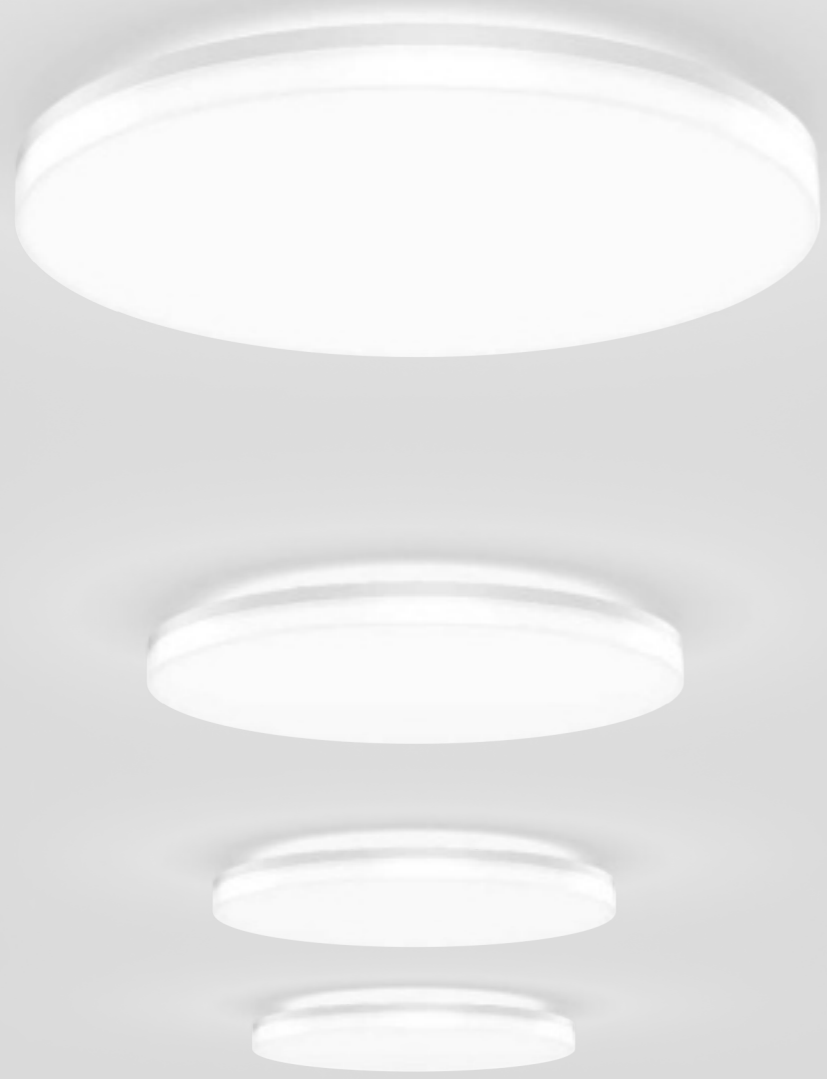

SONO IP50/IP54 surface

EN Round luminaire housing in die-cast aluminium; surface powder coated; suitable for wall or ceiling mounting; completely homogeneously illuminated, satinised PMMA cover; same luminance for all size versions; energy-efficient LEDs with very good colour rendering; luminaire with 2 cable openings and plug-in terminals for through wiring

DE Runder Leuchtenkörper aus Aluminiumdruckguss; Oberfläche pulverbeschichtet; geeignet für Wand- oder Deckenmontage; absolut homogen ausgeleuchtete, satinierte PMMA-Abdeckung; gleiche Leuchtdichte bei allen Größenvarianten; energieeffiziente LEDs mit sehr guter Farbwiedergabe; Leuchte mit 2 Kabelöffnungen und Steckklemme für Weiterverdrahtung

Quickinfo

3000K, 4000K
CRI ≥ 80, 3 SDCM
up to 143lm/W
L90 @ 50 000h
non DIM, DALI-2
opal cover
IP 40, IP 50, IP 54

Types

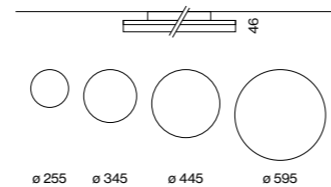

Colour



Light distributions

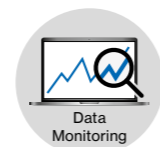

DiiA® standards
251, 252, 253



easy mounting by
click-mechanism



dust and insect
protection (IP 54)

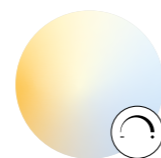

tunable white
2700–6500K

Order options

IP RATING
IP50 0
IP54 8

COLOUR TEMPERATURE
3000K 5
4000K 6

CONTROL
non DIM 1
DALI-2 3

EMERGENCY LIGHT
3h accupack* N L 3
*not for IP54

MATERIAL COLOUR
 pure white RAL 9010

LIGHT OPTIC COVER
opal

Options on request

COLOUR RENDERING INDEX
CRI ≥ 90

COLOUR TEMPERATURE
tunable white 2700–6500K
DALI-2 DT8

CONTROL
RCS Master
RCS Slave

Light distribution

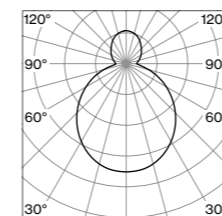

opal
direct/indirect

LUMINOUS FLUX value calculated for
CRI ≥ 80, colour white, cover opal

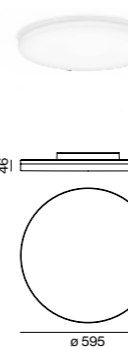
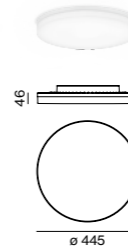
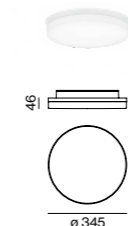

SONO 260 surface

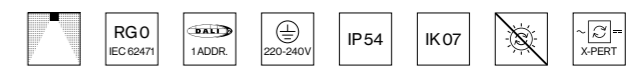

DIRECT		ORDER CODE	
SYSTEM POWER	COLOUR TEMP.	LUMINOUS FLUX	
7.6 W	3000 K	950 lm	071-9126::70
	4000 K	1010 lm	

SONO 350 surface



DIRECT		ORDER CODE	
SYSTEM POWER	COLOUR TEMP.	LUMINOUS FLUX	
15.9 W	3000 K	2090 lm	071-9136::70
	4000 K	2210 lm	

SONO 450 surface



DIRECT		ORDER CODE	
SYSTEM POWER	COLOUR TEMP.	LUMINOUS FLUX	
23.2 W	3000 K	3070 lm	071-9146::70
	4000 K	3250 lm	



DIRECT/INDIRECT		ORDER CODE	
SYSTEM POWER	COLOUR TEMP.	LUMINOUS FLUX	
34 W	3000 K	↓ 3290 / ↑ 1130 lm	071-9148::70
	4000 K	↓ 3480 / ↑ 1200 lm	

SONO 600 surface

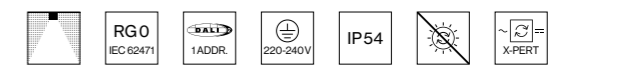

DIRECT		ORDER CODE	
SYSTEM POWER	COLOUR TEMP.	LUMINOUS FLUX	
43 W	3000 K	5830 lm	071-9156::70
	4000 K	6170 lm	



DIRECT/INDIRECT		ORDER CODE	
SYSTEM POWER	COLOUR TEMP.	LUMINOUS FLUX	
67 W	3000 K	↓ 5830 / ↑ 2840 lm	071-9158::70
	4000 K	↓ 6170 / ↑ 3010 lm	

Grundschule St. Martin in Gsies, IT –
by tasserball architekten

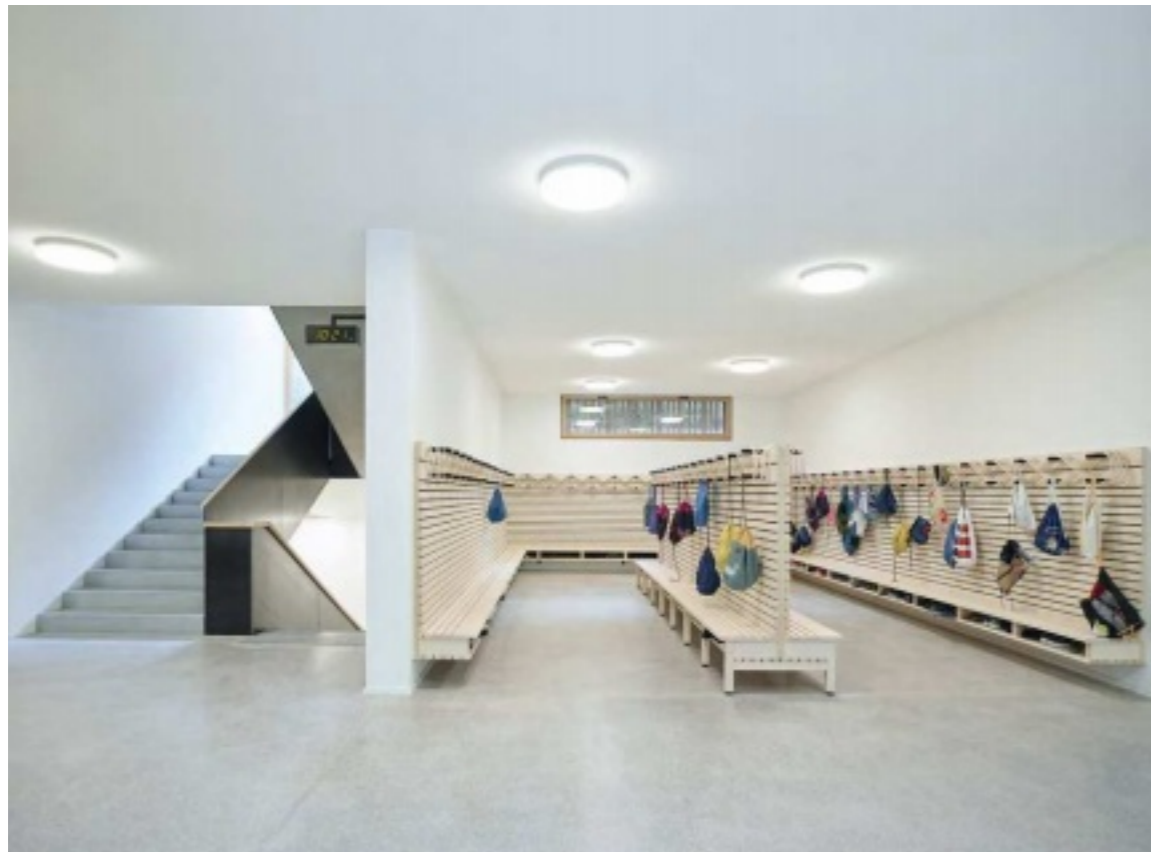

Kindergarten Hauderweg Linz, AT –
by Mia2 Architektur ZT KG
including lighting design

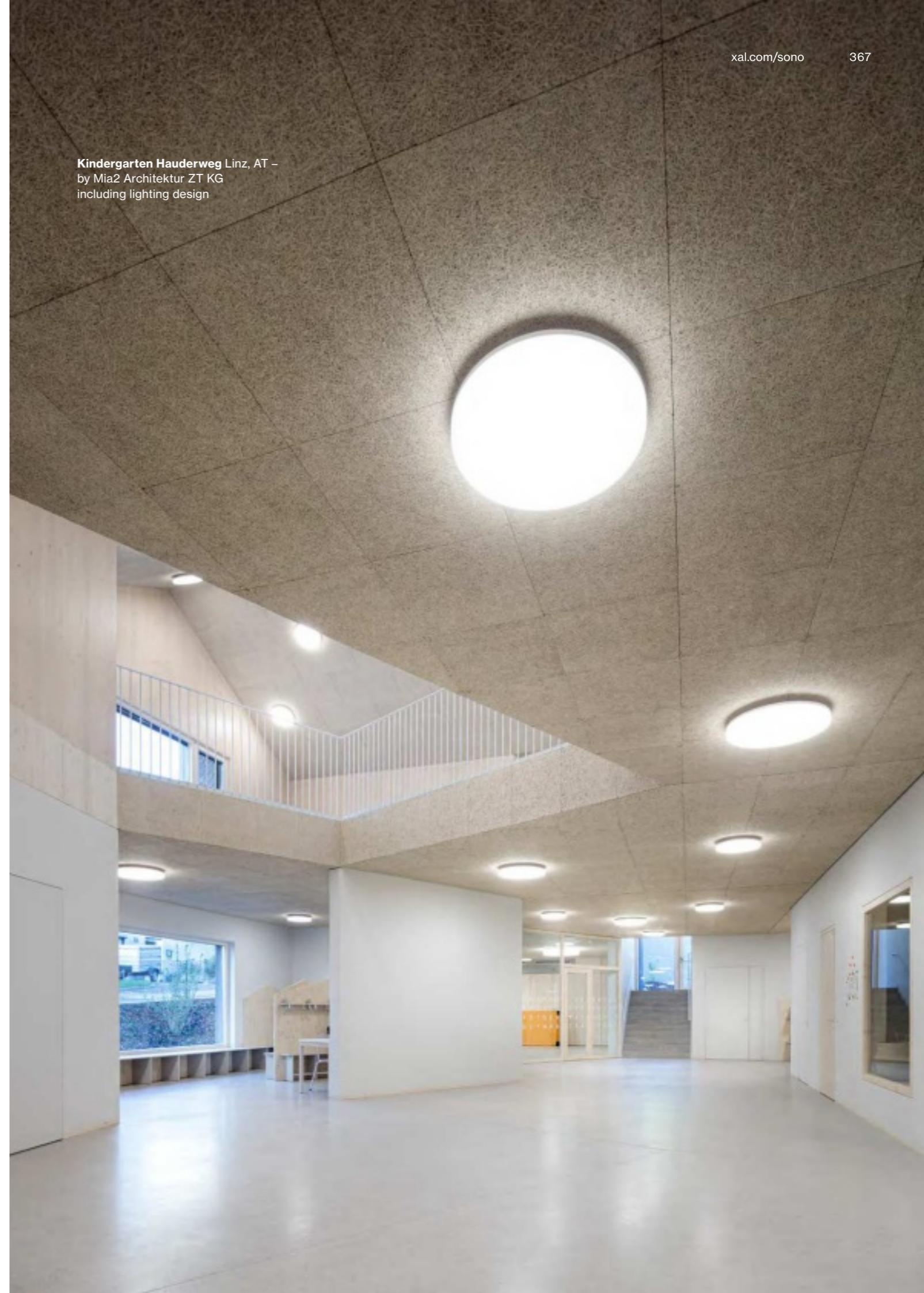

Primarschule Basel, CH – by
Stähelin Partner Architekten AG

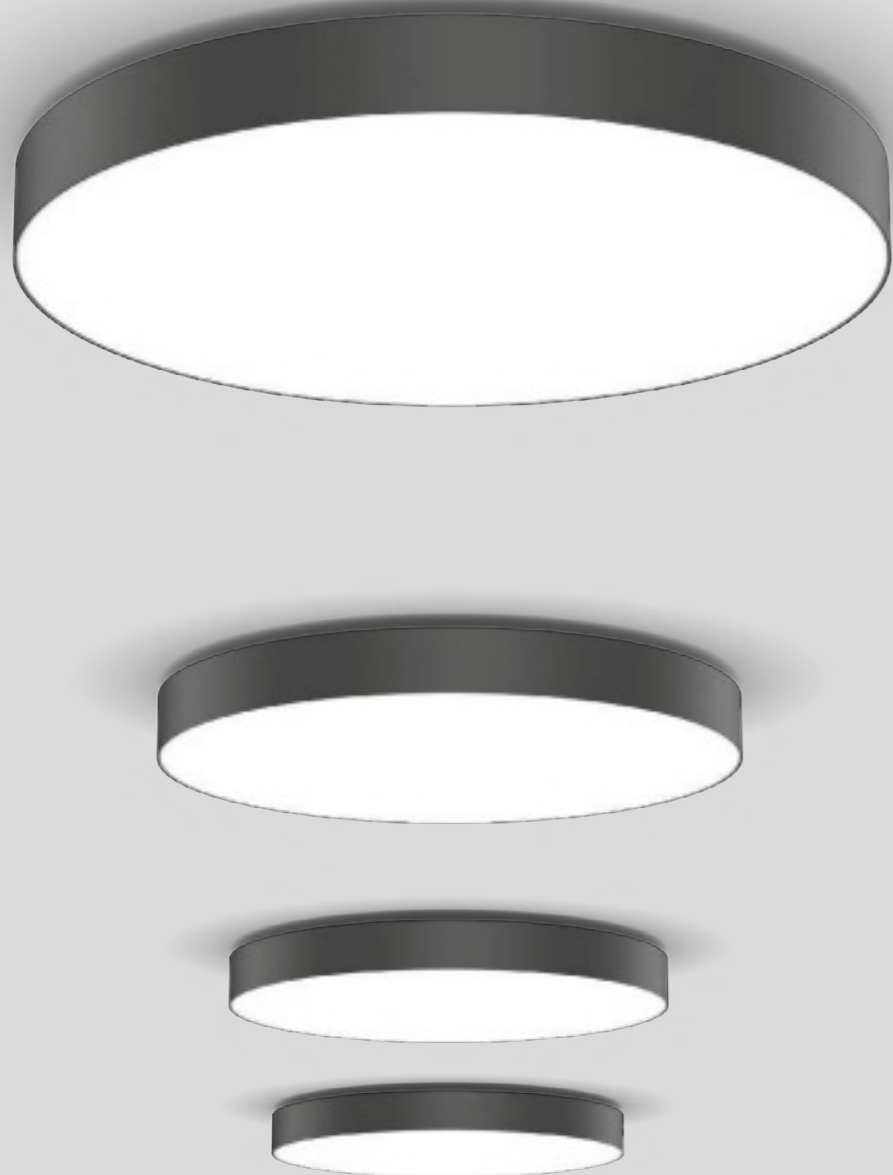

[← back](#)

SONO LOOP IP54

surface

EN Round luminaire housing in die-cast aluminium; surface powder coated; fitted bezel in rolled, seamless welded aluminium profile; suitable for wall or ceiling mounting; completely homogeneously illuminated, satinised PMMA cover; same luminance for all size versions; energy-efficient LEDs with very good colour rendering; luminaire with 2 cable openings and plug-in terminals for through wiring

DE Runder Leuchtenkörper aus Aluminiumdruckguss; Oberfläche pulverbeschichtet; aufgesetzter Ring aus gerolltem und nahtlos verschweißtem Aluminiumprofil; geeignet für Wand- oder Deckenmontage; absolut homogen ausgeleuchtete, satinierte PMMA-Abdeckung; gleiche Leuchtdichte bei allen Größenvarianten; energieeffiziente LEDs mit sehr guter Farbwiedergabe; Leuchte mit 2 Kabelöffnungen und Steckklemme für Weiterverdrahtung

Quickinfo

3000K, 4000K
CRI ≥ 80, 3 SDCM
uo to 133lm/W
L90 @ 50 000h
non DIM, DALI-2
opal cover
IK 07, IP 54

Types

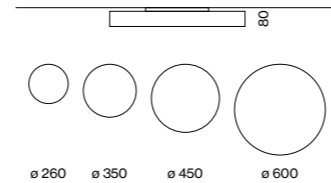

Colours



Light distribution



direct

Order options

IP RATING

IP54

COLOUR TEMPERATURE

3000K 5
4000K 6

CONTROL

non DIM 1
DALI-2 3

MATERIAL COLOUR

○ pure white RAL 9010 7
● grey aluminium RAL 9007 D

LIGHT OPTIC COVER

opal

Options on request

COLOUR RENDERING INDEX

CRI ≥ 90

COLOUR TEMPERATURE

tunable white 2700–6500 K
DALI-2 DT8

CONTROL

RCS Master (☺)
RCS Slave (☺)

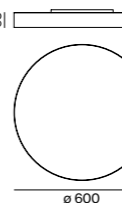
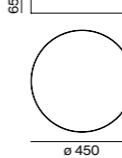
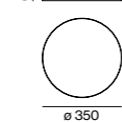
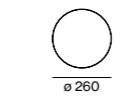
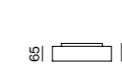

SONO LOOP 260 surface



IP 54 LUMINAIRE

SYSTEM POWER	COLOUR TEMP.	LUMINOUS FLUX	ORDER CODE
7.6 W	3000 K	881lm	8 7 1 - 8 1 2 6 :: ☺ ☺ ○
	4000 K	933lm	

SONO LOOP 350 surface



IP 54 LUMINAIRE

SYSTEM POWER	COLOUR TEMP.	LUMINOUS FLUX	ORDER CODE
15.9 W	3000 K	1940lm	8 7 1 - 8 1 3 6 :: ☺ ☺ ○
	4000 K	2060lm	

SONO LOOP 450 surface



IP 54 LUMINAIRE

SYSTEM POWER	COLOUR TEMP.	LUMINOUS FLUX	ORDER CODE
23.2 W	3000 K	2850lm	8 7 1 - 8 1 4 6 :: ☺ ☺ ○
	4000 K	3010lm	

SONO LOOP 600 surface



IP 54 LUMINAIRE

SYSTEM POWER	COLOUR TEMP.	LUMINOUS FLUX	ORDER CODE
43 W	3000 K	5410lm	8 7 1 - 8 1 5 6 :: ☺ ☺ ○
	4000 K	5730lm	

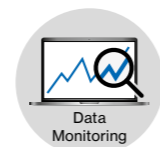

DiiA® standards
251, 252, 253



easy mounting by
click-mechanism



dust and insect
protection (IP 54)



tunable white
2700–6500 K

LUMINOUS FLUX value calculated for
CRI ≥ 80, colour white, cover opal



KTM House of brands
Munderfing, AT – by Hofbauer
Liebmann Architekten ZT GmbH

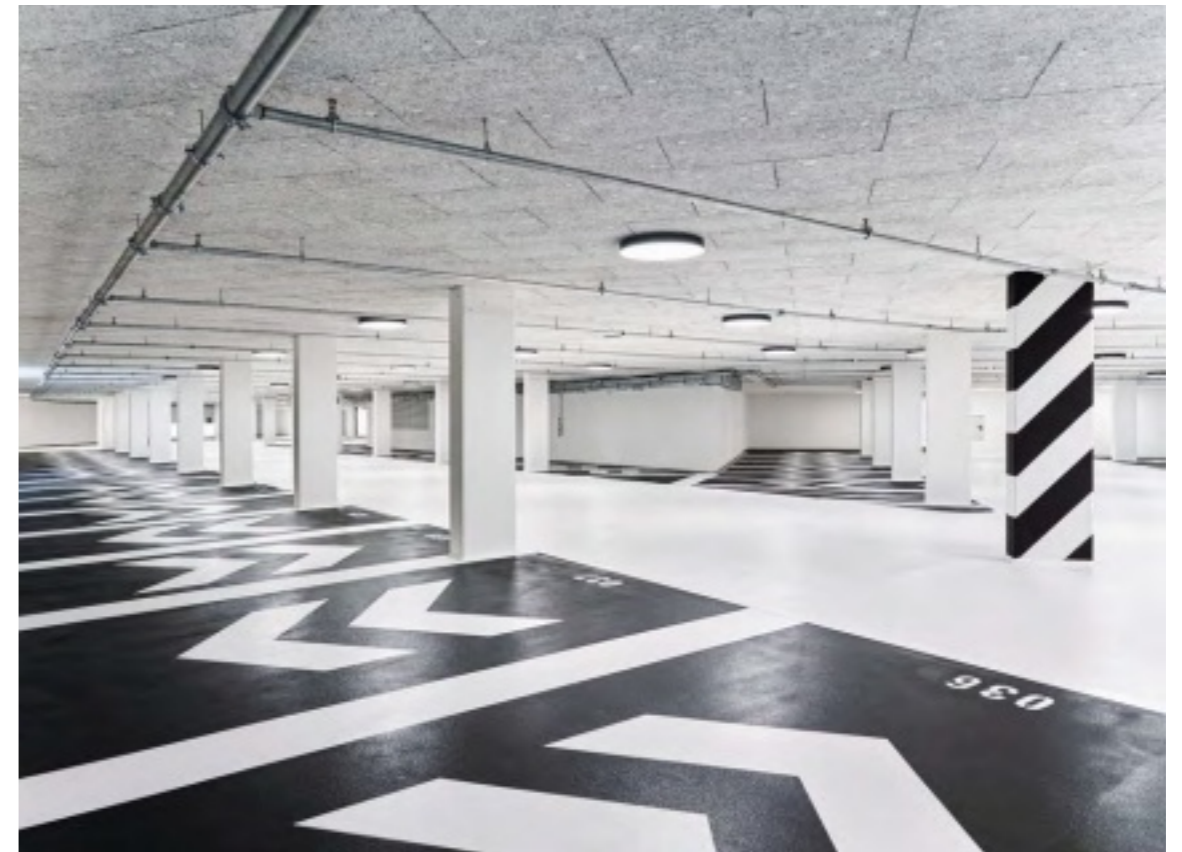

The square difference

FLOW

EN FLOW is ideal for providing light in its pure form. FLOW, whether mounted on the wall or ceiling, or in its suspended variant, has a clean design and flat dimensions. Depending on the desired lighting mood, the IP 40-protected luminaire is available at 3000 K or 4000 K. An opal cover creates a uniform and pleasant light. The surface-mounted luminaire is installed quickly and without tools via a mounting plate.

DE Wo Licht in seiner puren Form gewünscht ist, liefert FLOW die optimale Lösung. Sowohl an Wand oder Decke montiert als auch in ihrer abgehängten Variante nimmt sich FLOW durch ihr schlichtes Erscheinungsbild und ihre flachen Abmessungen zurück. Je nach gewünschter Lichtstimmung ist die IP 40-geschützte Leuchte in 3000 K oder 4000 K erhältlich, ein Opal-Cover schafft gleichförmiges und angenehmes Licht. Die Installation der Anbauleuchte erfolgt einfach und werkzeuglos über eine Montageplatte.

Types

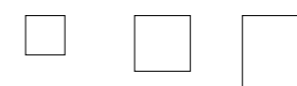

320

450

600

Mountings



wall



ceiling

Light distribution



opal

back

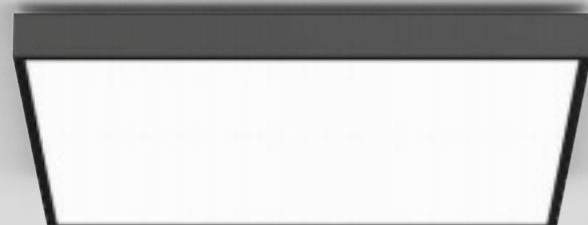

FLOW

surface

EN Square aluminium luminaire housing, flat design (luminaire housing 35 mm); surface powder coated; suitable for wall or ceiling mounting, luminaire housing set 11 mm away from wall or ceiling; convenient quick mounting system without tools; direct light distribution by LGP body (Light Guiding Prism); side coupled light directed downwards by laser engraving; light control via highly reflective reflector material; completely homogeneous illumination; same luminance for all size versions; energy-efficient LEDs with very good colour rendering; luminaire with 2 cable openings and plug-in terminals for through wiring

DE Quadratischer Leuchtenkörper aus Aluminium, flache Bauform (Leuchtenkörper 35 mm); Oberfläche pulverbeschichtet; geeignet für Wand- oder Deckenmontage, Leuchtenkörper 11 mm von Wand bzw. Decke abgesetzt; komfortables, werkzeugloses Schnellmontagesystem; direkte Lichtverteilung durch LGP-Body (Light-Guiding-Prism); seitlich eingekoppeltes Licht durch Lasergravur nach unten gelenkt; Lichtlenkung mittels hochreflektierenden Reflektormaterials; absolut homogene Ausleuchtung; gleiche Leuchtdichte bei allen Größenvarianten; energieeffiziente LEDs mit sehr guter Farbwiedergabe; Leuchte mit 2 Kabelöffnungen und Steckklemme für Weiterverdrahtung

Quickinfo

3000 K, 4000 K
CRI ≥ 80, 3 SDCM
up to 146 lm/W
L90 @ 50 000 h
non DIM, DALI-2
opal, IP 40

Types

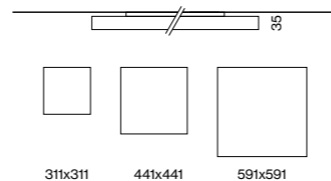

Colours



Light distribution



Order options

COLOUR TEMPERATURE

3000 K	5
4000 K	6

CONTROL

non DIM	1
DALI-2	3

MATERIAL COLOUR

<input type="radio"/> pure white RAL 9010	7
<input checked="" type="radio"/> white aluminium RAL 9006	G
<input type="radio"/> jet black RAL 9005	8
<input type="radio"/> special colours p.992	X

LIGHT OPTIC COVER

opal

Options on request

MOUNTING

1500 mm cable suspension

COLOUR RENDERING INDEX

CRI ≥ 90

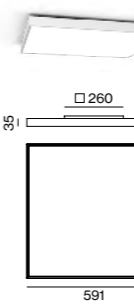
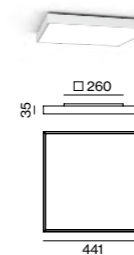
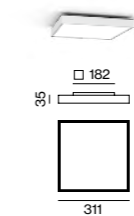

FLOW 320 surface



DIRECT

SYSTEM POWER	COLOUR TEMP.	LUMINOUS FLUX	ORDER CODE
15.2 W	3000 K	2000 lm	0 7 3 - 0 1 3 1
	4000 K	2120 lm	

FLOW 450 surface



DIRECT

SYSTEM POWER	COLOUR TEMP.	LUMINOUS FLUX	ORDER CODE
23.9 W	3000 K	3250 lm	0 7 3 - 0 1 4 1
	4000 K	3440 lm	

FLOW 600 surface



DIRECT

SYSTEM POWER	COLOUR TEMP.	LUMINOUS FLUX	ORDER CODE
44 W	3000 K	6060 lm	0 7 3 - 0 1 5 1
	4000 K	6420 lm	

Accessories

TYPE	ORDER CODE
dismounting tool	0 7 3 - 0 1 0 0 0 0



DiiA® standards
251, 252, 253



easy mounting by click-mechanism
insect protection (IP 40)

LUMINOUS FLUX value calculated for
CRI ≥ 80, colour white, cover opal

Businesscenter
Wels, AT –
by Riepl / Riepl



Artistic light arrangements

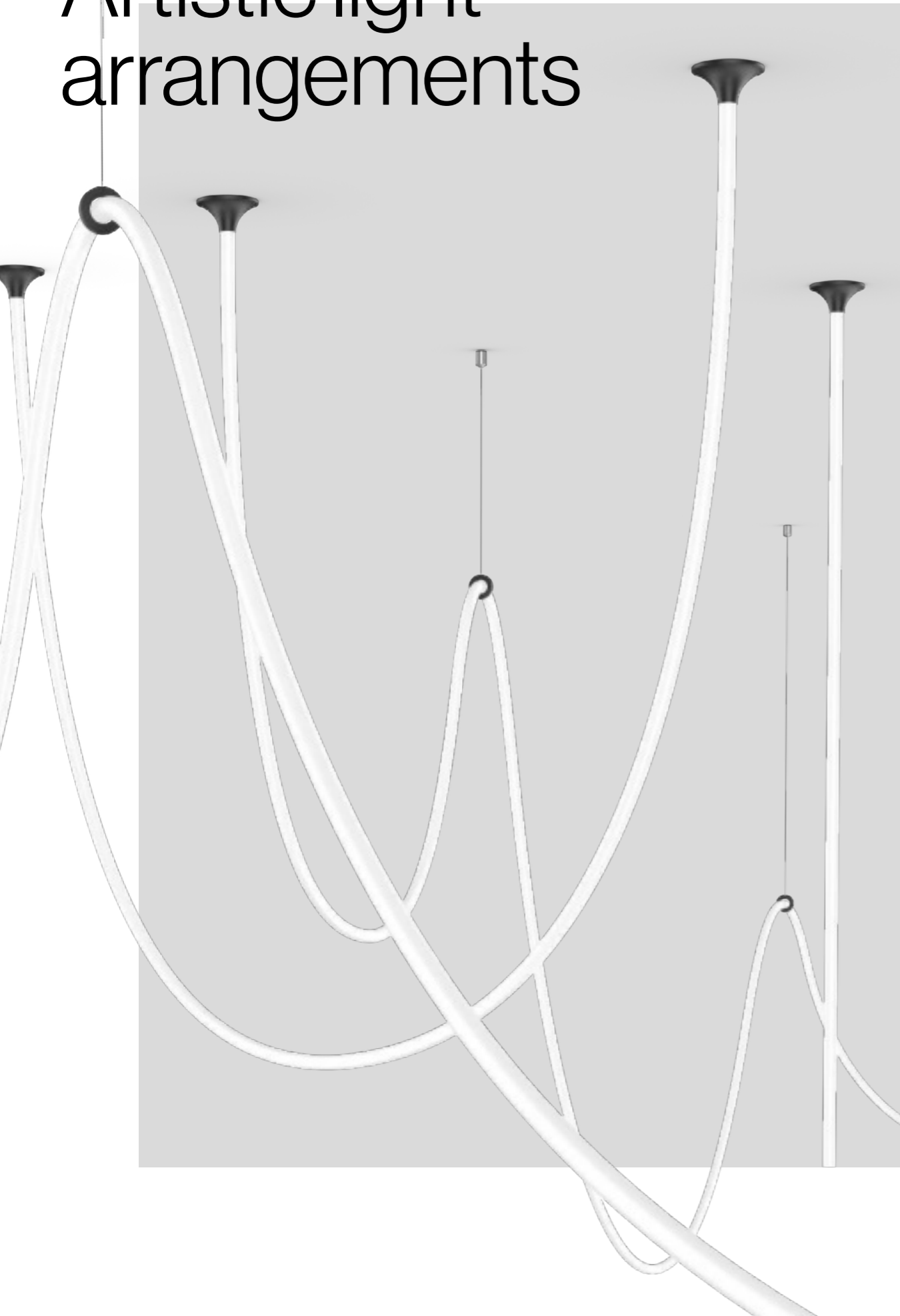

JANE

EN JANE gives flexibility in design a new dimension. The rope-like, highly flexible LED luminaire is made of food-safe silicone and offers complete freedom when designing creative ceiling and wall arrangements. JANE has a homogeneous light distribution, with a diameter of only 18 mm. At up to 10 metres long, it is ideal for small and large visions. The light cables can be easily arranged into custom patterns with the ceiling clips and cable holders. JANE is available in 3000 K or 4000 K light colours and, with CRI ≥ 90 , also delivers top colour rendering. This luminaire is unique because of its appearance. It is a new, highly decorative innovation from XAL – artistic and exclusive.

DE Flexibilität im Design gewinnt durch JANE eine neue Dimension. Die seilartige, hochflexible LED Leuchte aus lebensmittelechtem Silikon bietet vollkommene Freiheit bei der Gestaltung kreativer Decken- und Wandarrangements. JANE verfügt über eine durchgehend homogene Abstrahlcharakteristik, bei einem Durchmesser von nur 18 mm. Und mit einer Länge von bis zu 10 Metern ist sie für kleine und große Visionen geeignet. Mit den Deckenclips und Seilhalter lassen sich die Lichtseile einfach zu ausgefallenen Mustern arrangieren. JANE ist wahlweise in den Lichtfarben 3000 K oder 4000 K erhältlich und sorgt bei CRI ≥ 90 für eine sehr gute Farbwiedergabe. Einzigartig macht diese Leuchte ihr Erscheinungsbild: Eine neuartige, hochdekorative Innovation von XAL – kunstvoll und exklusiv.

Mountings

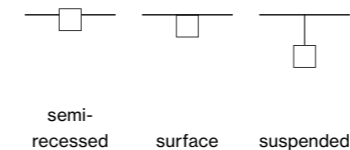

semi-recessed

surface

suspended

Light distribution



opal



Artistic sculptures

EN JANE curves along walls and loops from ceilings thanks to its flexibility. This corded, food-grade silicone luminaire promises full lighting-design freedom. Create dynamic patterns and artistic arrangements; bring unique and harmonious motion to life.

DE Hochflexibel schwingt JANE über Wand und Decke. Die seilartige Leuchte aus lebensmittelechtem Silikon ermöglicht maximale Freiheit bei der Lichtgestaltung. Entwerfen Sie ausgefallene Muster und kunstvolle Arrangements: einzigartig und in harmonischer Bewegung.

Mounting options

EN JANE attaches to ceilings or walls easily to fully meet your needs. The luminaire hangs in position with ceiling clips and cord holders. The suspended cord is height-adjustable without any tools. Let your design ideas run free. You can even arrange JANE perfectly linearly thanks to the special track guide.

DE JANE wird einfach und vollkommen individuell an Decken oder Wänden befestigt. Deckenclips und Seilhalter bringen die Leuchte in Position, die Seilabhängung kann zusätzlich ganz ohne Werkzeug höhenverstellt werden. Dabei sind Ihren Gestaltungsideen keine Grenzen gesetzt. Auch ein lineares Arrangement ist möglich: Entlang einer speziellen Schienenführung wird JANE sprichwörtlich schnurgerade ausgerichtet.

Mounting accessories

- 1 mounting set recessed
- 2 mounting set surface
- 3 mounting set suspended
- 4 clip surface (transparent)
- 5 channel surface (transparent)
- 6 mounting ring surface
- 7 mounting ring suspended

Electrical accessories

- 1 power supply recessed
- 2 power supply surface
- 3 power supply suspended

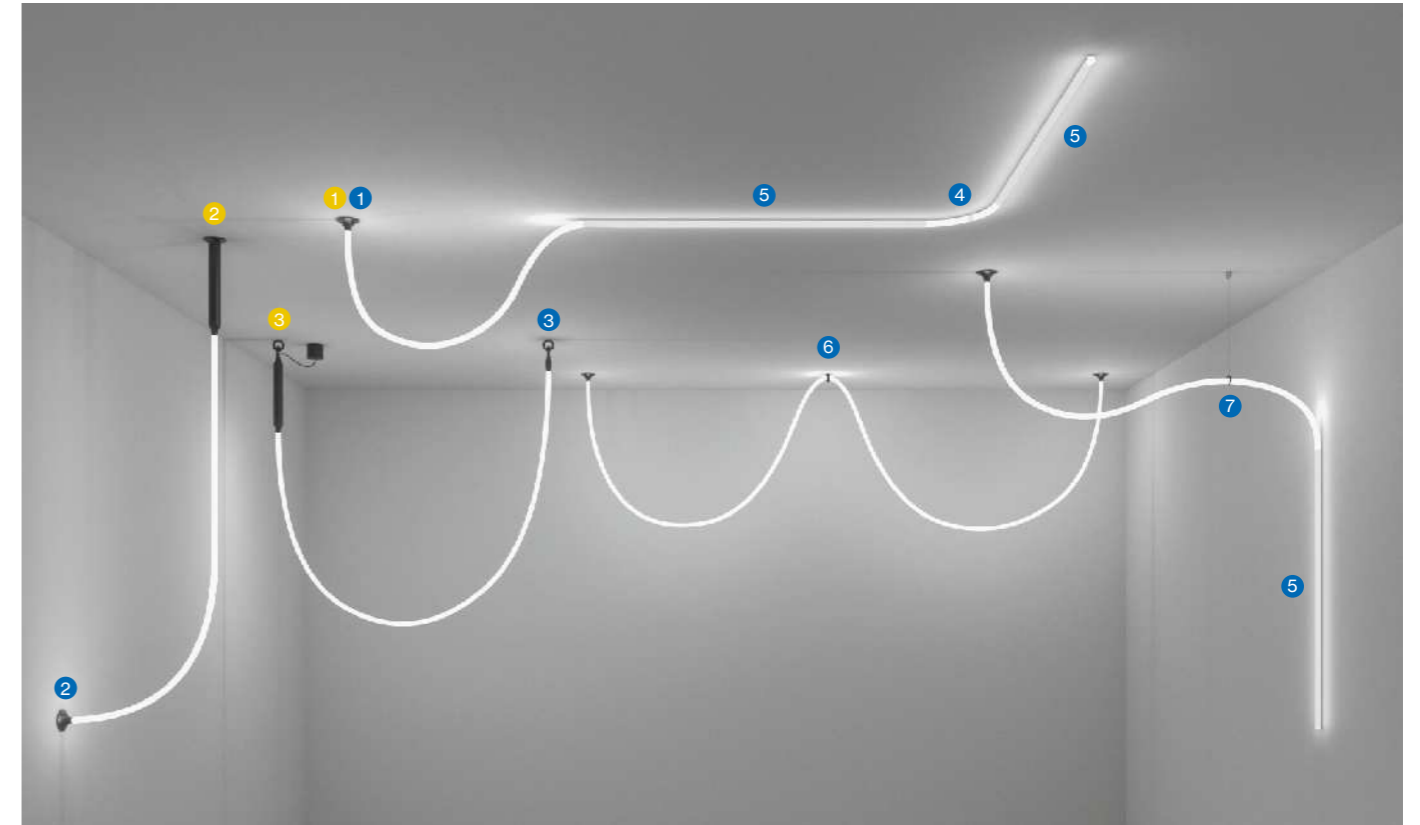

Length variety

EN How far does your vision go? JANE adapts to your project dimensions whether expansive or confined. Create light sculptures perfectly tailored to the space and the ambience in a wide range of sizes thanks to its varying light cord lengths, from 1 to 10 m.

DE Wie groß ist Ihre Vision? Ob ausladend oder auf kleinem Raum: JANE passt sich den Projektdimensionen an. Verschiedene verfügbare Lichtseil-Längen, von 1 m bis 10 m, ermöglichen es, Lichtskulpturen in unterschiedlichen Größen anzufertigen. Genau abgestimmt auf den verfügbaren Platz und das Ambiente der Umgebung.

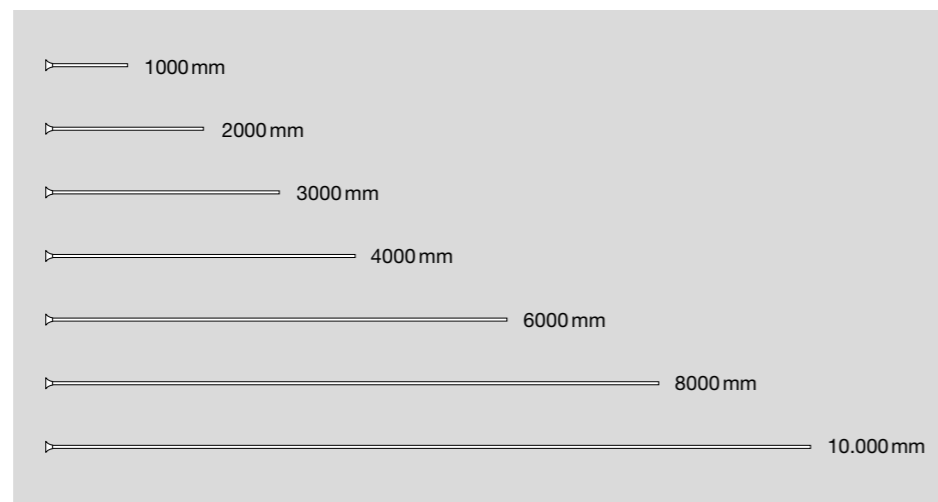

Slim and decorative

EN JANE is so much more than merely decorative. Its focussed 18 mm diameter packs enormous punch. The light cord's uniform all-round 360° beam characteristics deliver balanced illumination. Craft beautiful, swooping light sculptures and generate pleasant, homogeneous lighting wherever JANE is set.

DE Mehr als „nur“ dekorativ: In ihren schlanken 18 mm Durchmesser verbirgt JANE großes Potenzial. Durch die gleichmäßige 360°-Abstrahlcharakteristik erzeugt das Lichtseil eine ausgewogene Ausleuchtung. Ihre schwungvollen Lichtskulpturen sind also kein rein ästhetischer Hingucker, sondern schaffen eine wohltuende und homogene Beleuchtung dort, wo Sie JANE einsetzen.

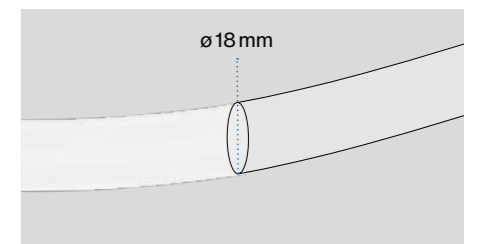

← back

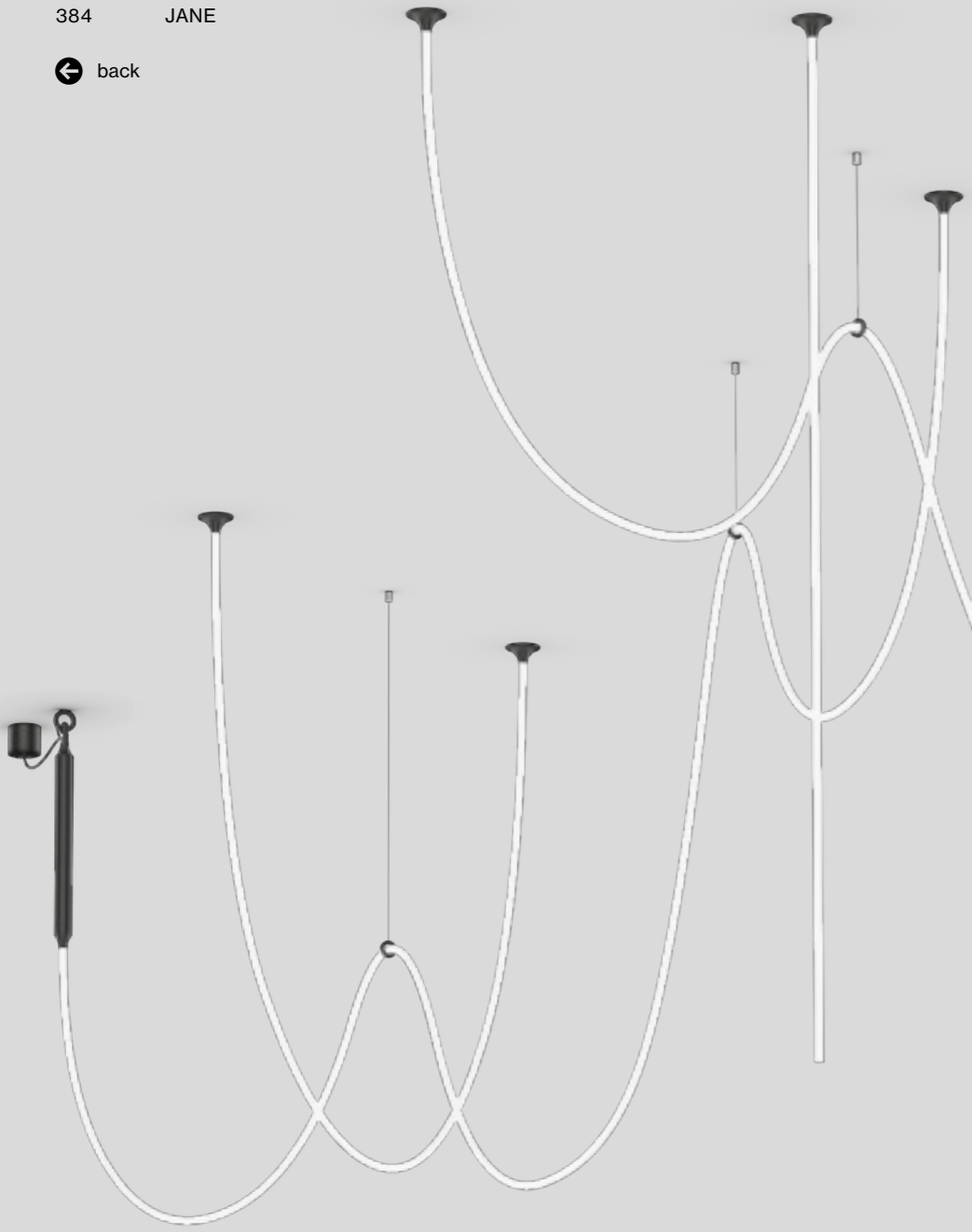

Quickinfo

3000K, 4000K
 CRI ≥ 90, 3 SDCM
 up to 1000lm/m
 up to 71lm/W
 L80 @ 50000h
 non DIM, DALI
 IP40

Types

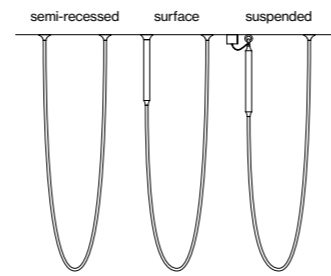

∅18 x 1000-10000

Canopy colours



Light distribution



JANE

semi-recessed / surface / suspended

EN Highly flexible light rope made of food grade silicone for creative and decorative design; extremely slim design (only 18 mm diameter); for wall-/ceiling surface mounting or suspended mounting (cable suspension, height adjustment without tools); completely homogeneously illuminated, matt surface; 360° light emission; energy-efficient LEDs with very good colour rendering; optionally with external converter for ceiling installation or suspended in combination with the light rope (available as an accessory)

DE Hochflexibles Lichtseil aus lebensmittel-echtem Silikon zur kreativen, dekorativen Gestaltung; extrem schlanke Bauform (nur 18 mm Durchmesser); für Wand-/Decken-anbaumontage oder für abgehängte Montage (Seilabhängung, werkzeuglose Höhenverstellung); absolut homogen ausgeleuchtete, matte Oberfläche; 360° Lichtabstrahlung; energieeffiziente LEDs mit sehr guter Farbwiedergabe; wahlweise externer Konverter für Deckeneinwurf oder abgependelt in Kombination mit dem Lichtseil (als Zubehör erhältlich)

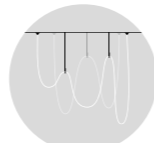

many mounting options



dust and insect protection (IP40)

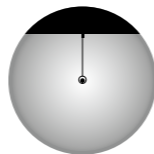

360° light emitting

Order options

COLOUR TEMPERATURE	
3000K	5
4000K	6

CONTROL	
non DIM	1
DALI	3

LENGTH	
1000 mm	1
2000 mm	2
3000 mm	3
4000 mm	4
6000 mm	6
8000 mm	8
10000 mm	0

MATERIAL COLOUR	
○ pure white RAL 9010	7
● jet black RAL 9005	8

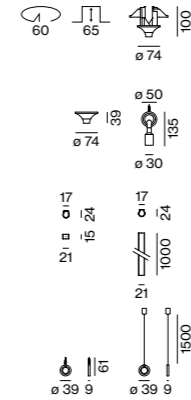
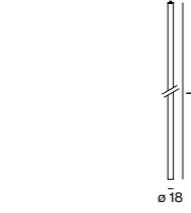

JANE semi-recessed / surface / suspended



LUMINAIRE			
SYSTEM POWER	COLOUR TEMP.	LUMINOUS FLUX	ORDER CODE
14.4W/m	3000K	812lm/m	058-651 L 10
	4000K	1000lm/m	

Mounting accessories

MOUNTING ACCESSORIES		
TYPE	L-W-H (mm)	ORDER CODE
1 mounting set recessed	∅74-100	058-659021
2 mounting set surface	∅74-39	058-659101
3 mounting set suspended	∅50/30-135	058-659201
4 clip surface (transparent)	15-21-24	058-6591410
5 channel surface (transparent)	1000-21-24	058-6591110
6 mounting ring surface	∅39-9-61	058-659161
7 mounting ring suspended	∅39-9	058-659261

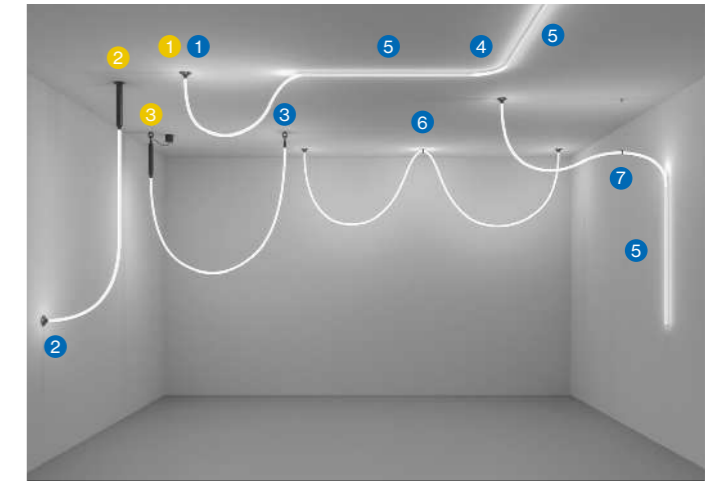

various mounting options with different mounting accessories

Electrical accessories

1 POWER SUPPLY RECESSED 220-240V AC, 48V, 50-60Hz			
TYPE		L-W-H (mm)	ORDER CODE
100W recessed	PC II	350-30-18	002-62134
150W recessed	PC II	350-30-18	002-62135
60W revision opening	PC II	163-43-32	002-62133
100W revision opening	PC II	350-30-18	002-62134
150W revision opening	PC II	350-30-18	002-62135
250W revision opening	PC II	400-40-22	002-62139
320W revision opening	PC I	252-90-44	002-60320
DALI device		120-30-22	058-6599330

2 POWER SUPPLY SURFACE 220-240V AC, 48V, 50-60Hz			
TYPE		L-∅ (mm)	ORDER CODE
100W surface	PC II	584-∅40	058-65912
150W surface	PC II	584-∅40	058-65913

3 POWER SUPPLY SUSPENDED 220-240V AC, 48V, 50-60Hz			
TYPE		L-∅ (mm)	ORDER CODE
100W suspended	PC II	639-∅40	058-65922
150W suspended	PC II	639-∅40	058-65923

incl. ceiling canopy and 2000mm power cable

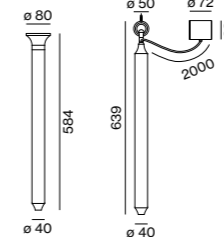

LUMINOUS FLUX value calculated for CRI ≥ 90, colour white, rope silicone

Upart Werbung & Kommunikation GmbH Linz-Urfahr, AT –
by MOSER UND HAGER Architekten ZT GmbH

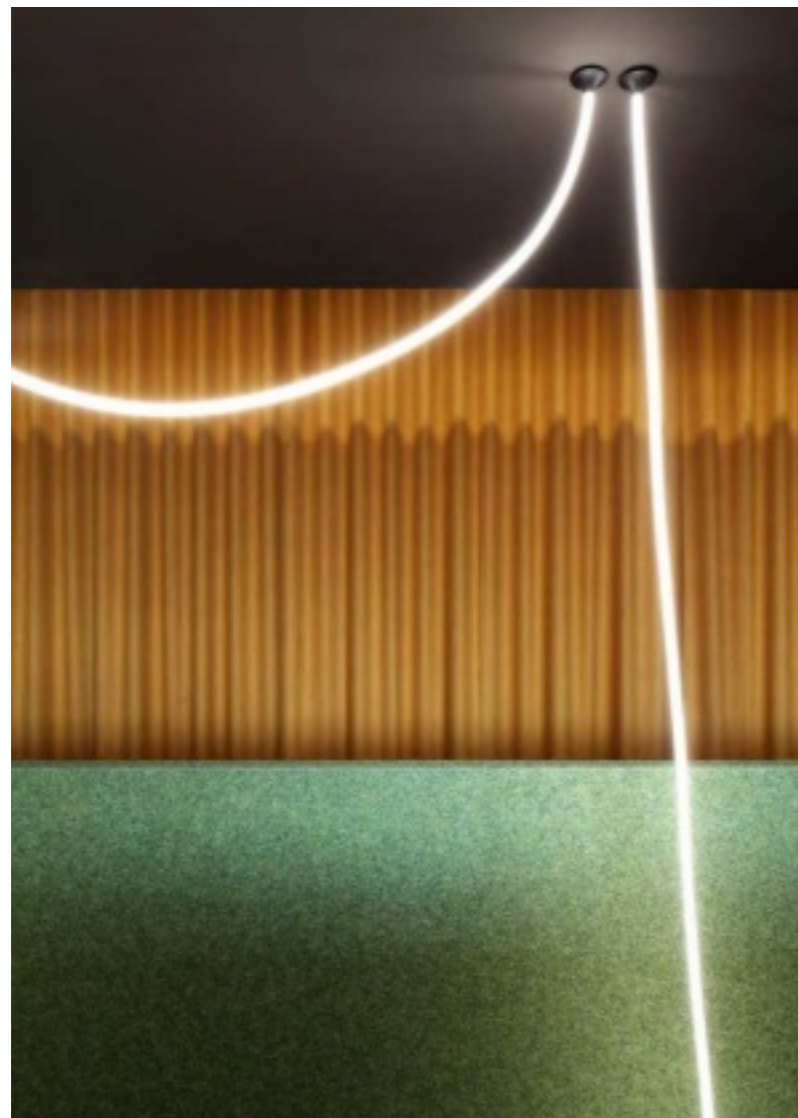



The Raum Bolzano, IT –
by bergundtal gmbh.



Office Greenhouse Gent, BE –
by Boîte, Interieur & concept architecten



**Binder Grösswang Rechtsanwälte
GmbH** Vienna, AT – by The Black
Square Planungsbüro GmbH

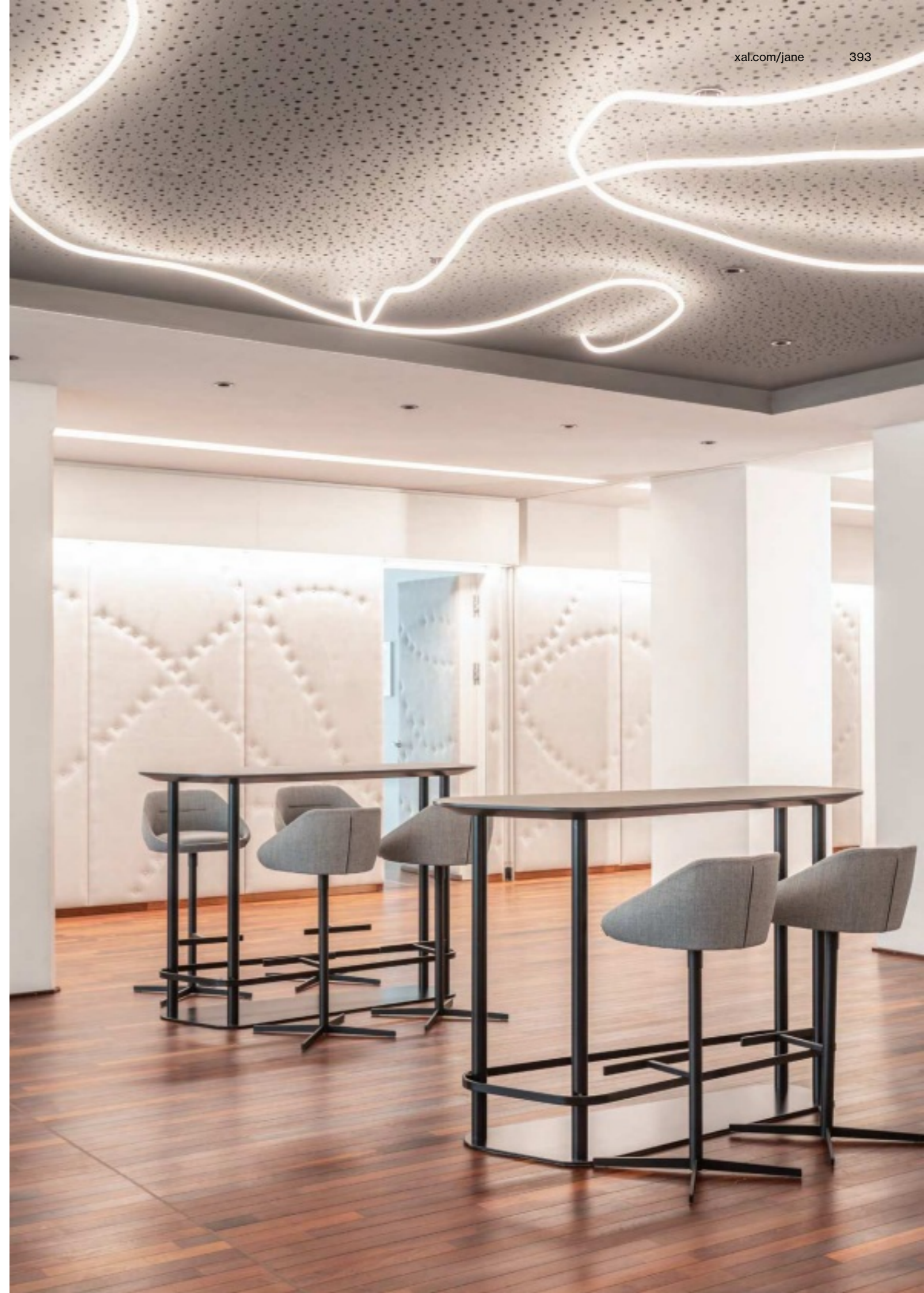
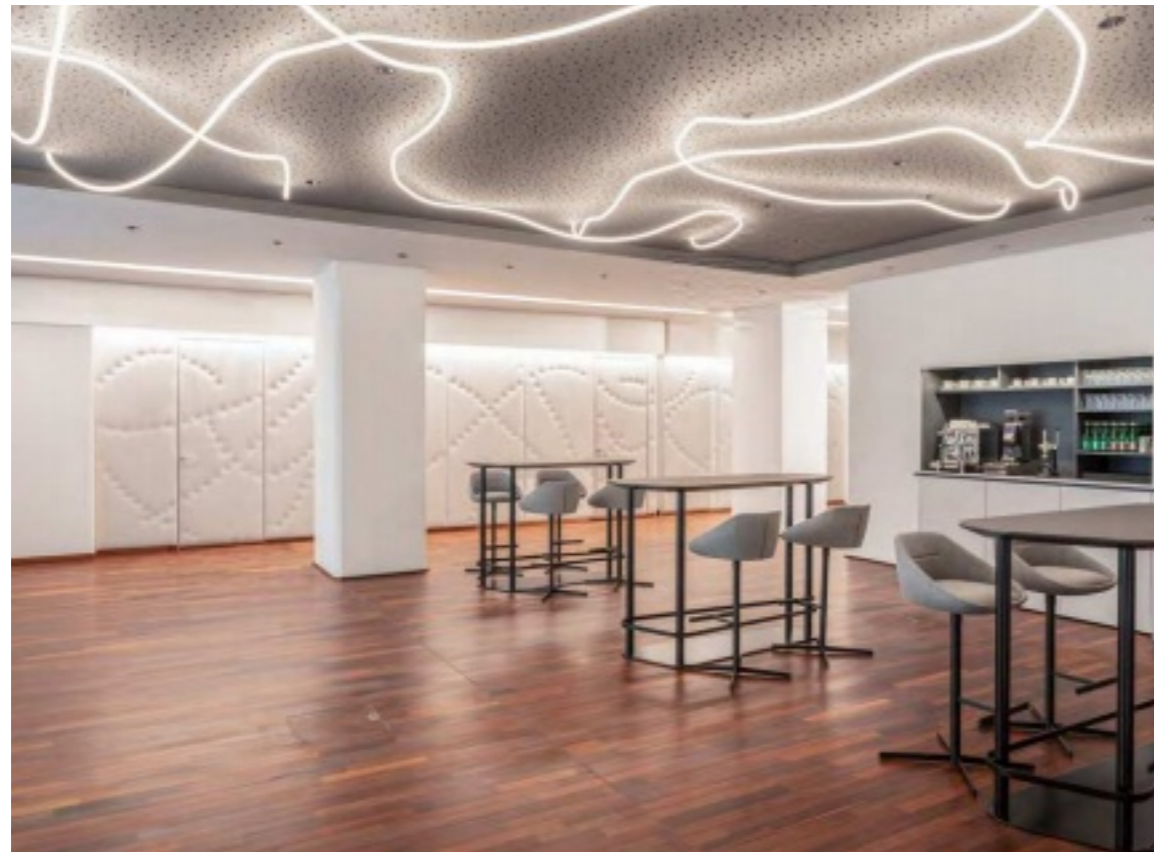

Effective at work

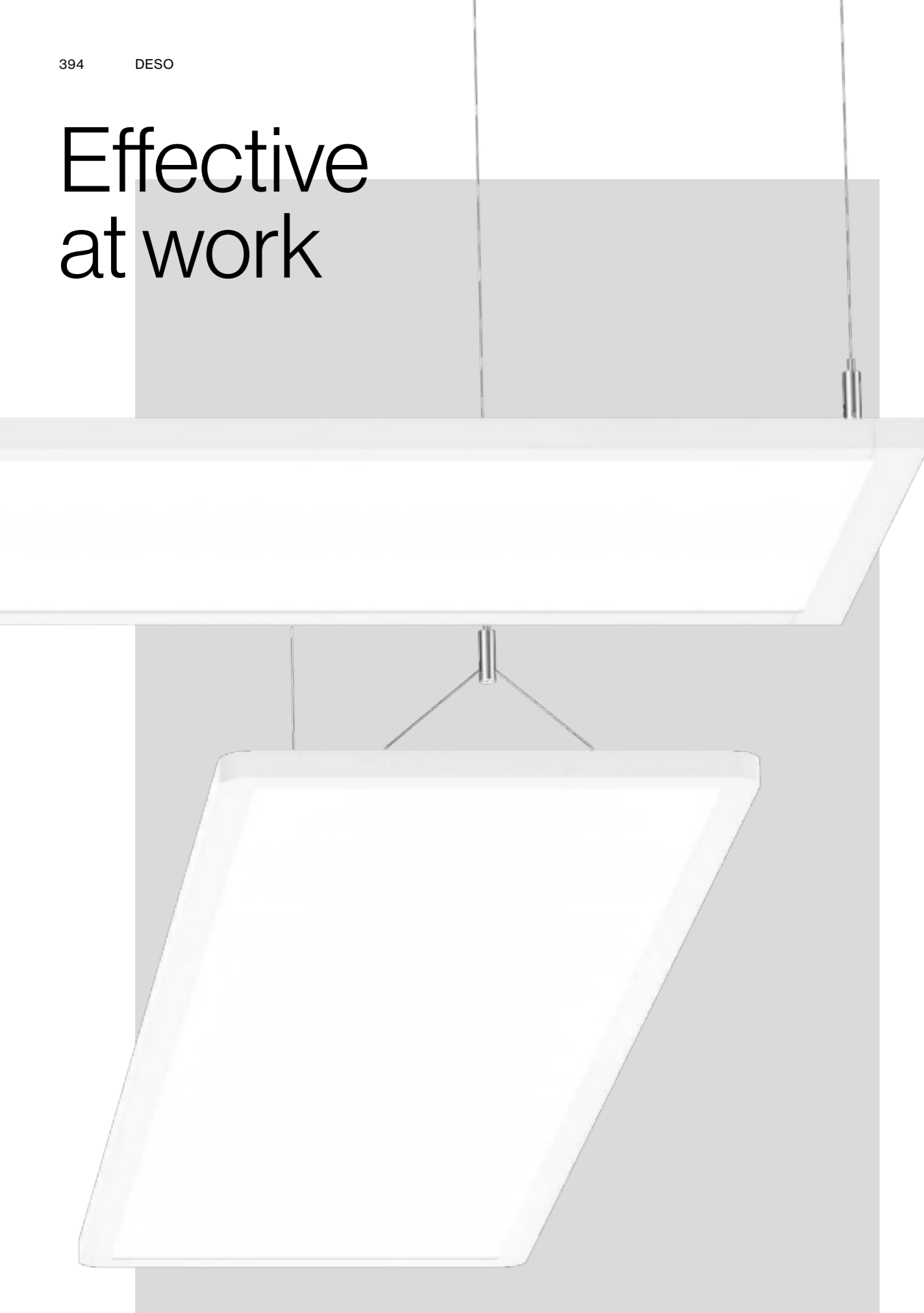

DESO

EN A classic office luminaire that meets all requirements without being obtrusive. DESO convinces through its fantastic simple, rectangular shape. It can come with rounded corners or angular design.

Thanks to its microprismatic cover, it provides excellent workplace lighting, delivers optimum glare control of $UGR \leq 19$, and is suitable for single and double workstations. The discreet indirect light distribution creates a pleasant, homogeneous ceiling illumination. An optional brightness and presence sensor automatically adjusts the lighting to the ambient brightness in the office.

DE Eine klassische Büroleuchte, die alle Anforderungen erfüllt, ohne sich aufzudrängen: DESO überzeugt durch ein schlichtes, rechteckiges Design – wahlweise in kantiger Ausführung oder mit abgerundeten Ecken. Dank mikroprismatischer Abdeckung schafft sie exzellentes Arbeitsplatzlicht, entblendet optimal gemäß $UGR \leq 19$ und ist für Einzel- und Doppelplätze geeignet. Zusätzlich erzeugt die dezente Indirektlicht-Abstrahlung eine angenehme, homogene Deckenaufhellung. Durch einen optionalen Bewegungs- und Tageslichtsensor passt sich die Beleuchtung automatisch der Umgebungshelligkeit im Büro an.

Types

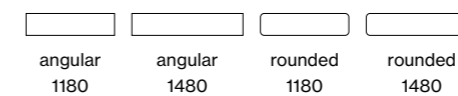

angular 1180 angular 1480 rounded 1180 rounded 1480

Mounting



suspended

Light distribution

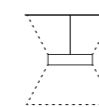

direct
indirect

← back



DESO

suspended

EN Rectangular luminaire housing in aluminium; choice of angular design or with rounded edges; ultra low-profile design (only 15 mm); surface powder coated; pendant fitting with cable suspension; with integrated tool-less suspension height adjustment; incl. feed (white); electronic operating unit installed in the canopy; direct/indirect light distribution by LGP body (Light Guiding Prism); side coupled light, directed up and down by laser engraving; direct component: microprismatic PMMA cover; indirect component covered with opal cover; homogeneous illumination; energy-efficient LEDs with very good colour rendering; canopy for through wiring

DE Rechteckiger Leuchtenkörper aus Aluminium; wahlweise kantige Ausführung oder mit abgerundeten Kanten; extrem flache Bauform (nur 15 mm); Oberfläche pulverbeschichtet; abgependelt mit Seilabhängung; werkzeuglose Höhenverstellung an der Leuchte; inkl. Einspeiseseitung (weiß); elektronisches Betriebsgerät im Baldachin verbaut; direkt/indirekte Lichtverteilung durch LGP-Body (Light-Guiding-Prism); seitlich eingekoppeltes Licht durch Lasergravur nach oben und unten gelenkt; Direktanteil: Mikroprismatische PMMA-Abdeckung; Indirektlichtanteil mit opaler Abdeckung abgedeckt; homogene Ausleuchtung; energieeffiziente LEDs mit sehr guter Farbwiedergabe; Baldachin für Weiterverdrahtung

Quickinfo

3000K, 4000K
 CRI ≥ 80, 3 SDCM
 UGR ≤ 19 / 65° ≤ 3000 cd/m²
 up to 131lm/W
 L90 @ 50 000h
 DALI-2
 microprismatic (UGR ≤ 19)

Types

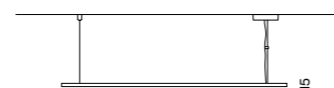

DESO

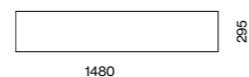
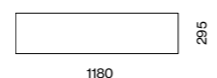

DESO rounded

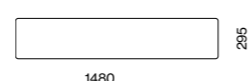
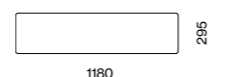

Colours



Light distribution



detail end caps



detail rounded end caps

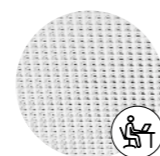

DIN EN 12464-1 UGR ≤ 19



direct/indirect illumination

Order options

COLOUR TEMPERATURE	
3000K	5
4000K	6

CONTROL

DALI-2

MATERIAL COLOUR

○ pure white RAL 9010

LIGHT OPTIC COVER

microprismatic (UGR ≤ 19)

Options on request

CONTROL

non DIM
 ESSENTIAL sensor
 (brightness & presence)

Light distribution

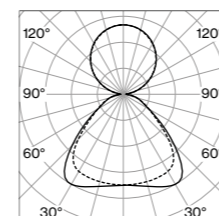

microprismatic direct/indirect

LUMINOUS FLUX value calculated for CRI ≥ 80, colour white, cover microprismatic

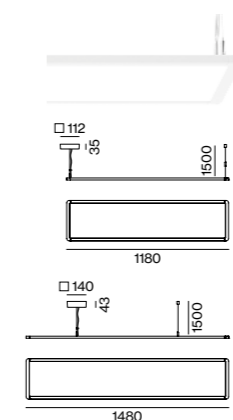
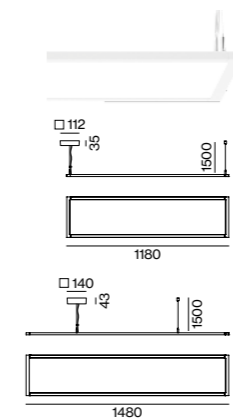

DESO suspended



DIRECT / INDIRECT

SYS. POWER	COLOUR TEMP.	LUM. FLUX	L (mm)	ORDER CODE
39 W	3000 K	↓ 2750 / ↑ 2090 lm	1180	0 7 4 - 2 2 4 4 :: 3 7 P
	4000 K	↓ 2910 / ↑ 2210 lm		
64 W	3000 K	↓ 3360 / ↑ 2540 lm	1480	0 7 4 - 2 2 4 5 :: 3 7 P
	4000 K	↓ 4400 / ↑ 3340 lm		

DESO rounded suspended



DIRECT / INDIRECT

SYS. POWER	COLOUR TEMP.	LUM. FLUX	L (mm)	ORDER CODE
39 W	3000 K	↓ 2750 / ↑ 2090 lm	1180	0 7 4 - 3 2 4 4 :: 3 7 P
	4000 K	↓ 2910 / ↑ 2210 lm		
64 W	3000 K	↓ 3360 / ↑ 2540 lm	1480	0 7 4 - 3 2 4 5 :: 3 7 P
	4000 K	↓ 4400 / ↑ 3340 lm		

Technical data

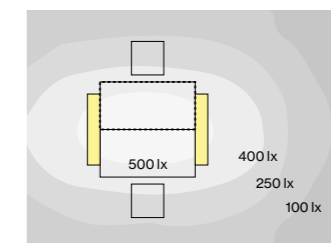

DESO suspended, 39W, 4000K, direct/indirect

ROOM VALUES

Room dimensions	5.4 × 4 × 2.8 m
Reflection factor	0.7 0.5 0.2
Maintenance factor	0.8
Suspension height	2.25 m

CALCULATION SURFACE

Surface dimensions	1.6 × 0.8 m
Surface height	0.75 m
Average illuminance (E _m)	> 500 lx
Uniformity (U ₀)	> 0.6

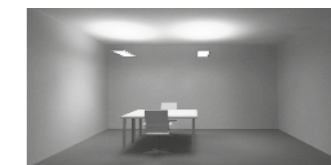

GLARE EVALUATION

Table Classification X=4H | Y=8H | S=0.25H

UGR transversal	≤ 16
UGR axial	≤ 16
≥ 65° ≤ 3000 cd/m²	

Highlight Towers Munich, DE –
lighting design by Lumen3 GbR



Ultra-slim office series



TASK

EN The ultra-slim TASK series fulfils all requirements of modern office lighting while being impressively flexible. Innovative technology and highly efficient LEDs meet minimalistic design. Thanks to its microprismatic cover, TASK provides bright and glare-minimised work light. The large product family includes ceiling, wall, floor, and table luminaires in a shared, sleek design language. The optional indirect light provides pleasant ceiling illumination. In addition, the ESSENTIAL sensor enables dynamic adjustment of the TASK S system and the floor luminaire to the ambient brightness and room activity. The SENSE variant also measures values such as temperature, air quality, humidity, and noise level. The SENSE sensor is IoT ready and enables the TASK free standing to transfer data via WLAN. For optimal room acoustics, the luminaires can be supplemented with highly effective acoustic elements with the same appearance.

DE Die ultraschlanke TASK Serie erfüllt alle Anforderungen an moderne Bürobeleuchtung – neben beeindruckender Flexibilität. Innovative Technologie und hocheffiziente LEDs treffen auf minimalistisches Design. Dank mikroprismatischer Abdeckung spendet TASK brillantes und blendungsminimiertes Arbeitslicht. Die große Produktfamilie umfasst Decken-, Wand-, Steh- und Tischleuchten im einheitlich schlanken Design. Das optionale Indirektlicht sorgt für eine angenehme Deckenaufhellung. Zusätzlich ermöglicht der ESSENTIAL-Sensor die dynamische Anpassung des TASK S Systems und der Stehleuchte an Umgebungshelligkeit und Raumaktivität. Die SENSE-Variante misst außerdem Werte wie Temperatur, Luftqualität, Luftfeuchtigkeit und Geräuschpegel. Der SENSE-Sensor ist IoT ready und ermöglicht der TASK free standing die Datenübertragung mittels WLAN. Für optimale Raumakustik können die Leuchtkörper durch hocheffektive Akustikelemente im gleichen Erscheinungsbild ergänzt werden.

Types

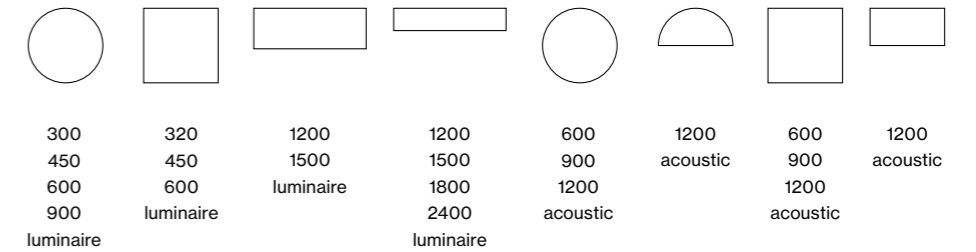

Mountings

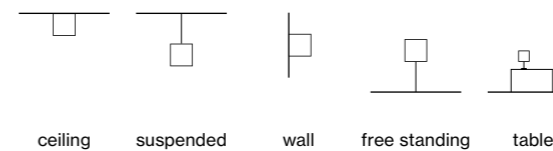

Light distributions

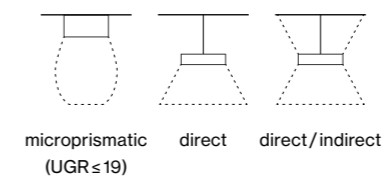

Ultra-slim and versatile

EN TASK combines an ultra-slim design with innovative lighting technology. These include, in particular, an LGP (Light Guiding Prism), which directs the laterally coupled light from highly efficient LEDs upwards and downwards. It creates a pleasant room atmosphere through a balanced relationship between direct and indirect light.

DE TASK vereint ultraschlankes Design mit innovativer Lichttechnik. Dazu gehören insbesondere ein LGP (Light Guiding Prism), welches das seitlich eingekoppelte Licht aus hocheffizienten LEDs nach oben und unten lenkt. Es schafft ein ausgewogenes Verhältnis zwischen Direkt- und Indirektlicht und somit eine angenehme Raum Atmosphäre.

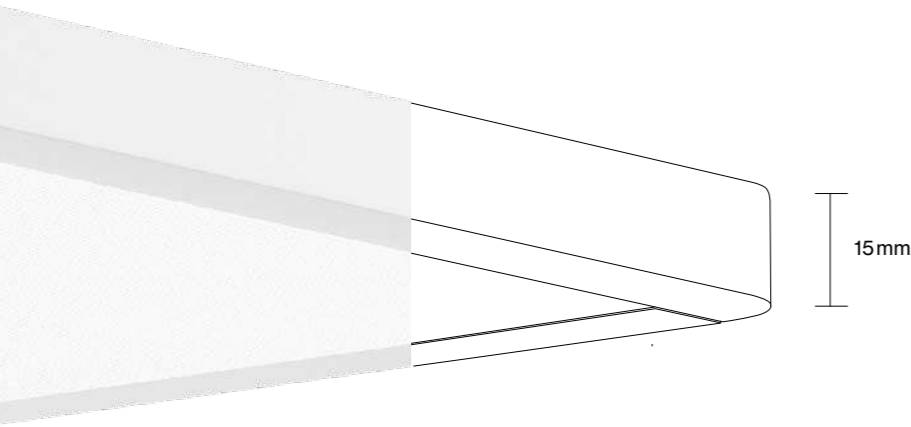

One design – many options

EN Thanks to a variety of shapes and mounting options, available individually but also as a system variant, TASK creates uniform lighting solutions for the most diverse projects. Pendant or surface-mounted luminaires for walls and ceilings can be supplemented by mobile floor and table luminaires. Flexible in use and uniform in design.

DE Dank vielfältiger Formen und Montagevarianten, einzeln erhältlich aber auch als Systemvariante, schafft TASK einheitliche Beleuchtungslösungen für unterschiedlichste Projekte. Pendel- bzw. Anbauleuchten für Wand und Decke können um mobile Steh- und Tischleuchten ergänzt werden. Flexibel im Einsatz und einheitlich im Design.

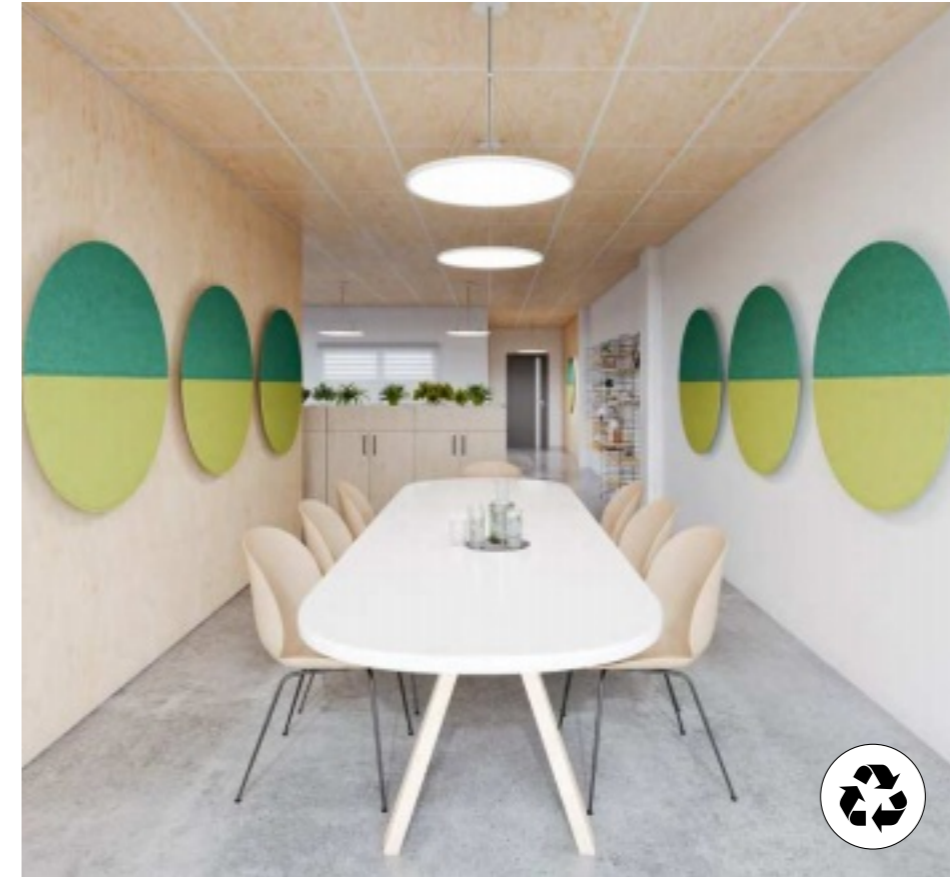

Pleasant room acoustics

EN Light is decisive but not solely. Pleasant room acoustics have a significant impact on job satisfaction. Acoustic panels in various colours and made of 60%-recycled PET complement the TASK series and reduce background noise in the office. For concentrated, productive work.

DE Neben Beleuchtung wirkt sich eine angenehme Raumakustik auf die Zufriedenheit am Arbeitsplatz aus. Akustikelemente in verschiedenen Farben, aus 60% recyceltem PET ergänzen die TASK Serie und reduzieren Nebengeräusche im Büro. Für konzentriertes, produktives Arbeiten.

Advanced sensor technology

EN The TASK S single luminaire and the TASK Free Standing adapt to daylight and room activity. Integrated motion sensors automatically dim the lighting while smart daylight sensors enable the light intensity to be adjusted to the ambient brightness. In addition, the SENSE version measures values such as temperature, air quality, humidity, and noise level. These data provide important insights into the conditions and use of rooms, and also support energy savings in the long term. The data from the sensors is transmitted via DALI. The SENSE sensor is IoT ready and enables the TASK free standing to transfer data via WLAN.

DE Die TASK S Einzelleuchte sowie die TASK Free Standing passen sich an Tageslicht und Raumaktivität an. Integrierte Bewegungssensoren dimmen automatisch die Beleuchtung, smarte Daylight-Sensorik ermöglicht die Anpassung der Lichtstärke an die Umgebungshelligkeit. Zudem misst die SENSE-Variante Werte wie Temperatur, Luftqualität, Luftfeuchtigkeit und Geräuschpegel. Diese Daten liefern nicht nur wichtige Erkenntnisse über die Bedingungen und Nutzung von Räumen, sondern unterstützen langfristig Energieeinsparungen. Die Daten der Sensoren werden über DALI übertragen. Der SENSE Sensor ist IoT ready und ermöglicht der TASK free standing die Datenübertragung mittels WLAN.

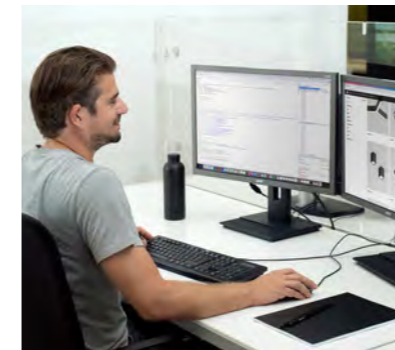
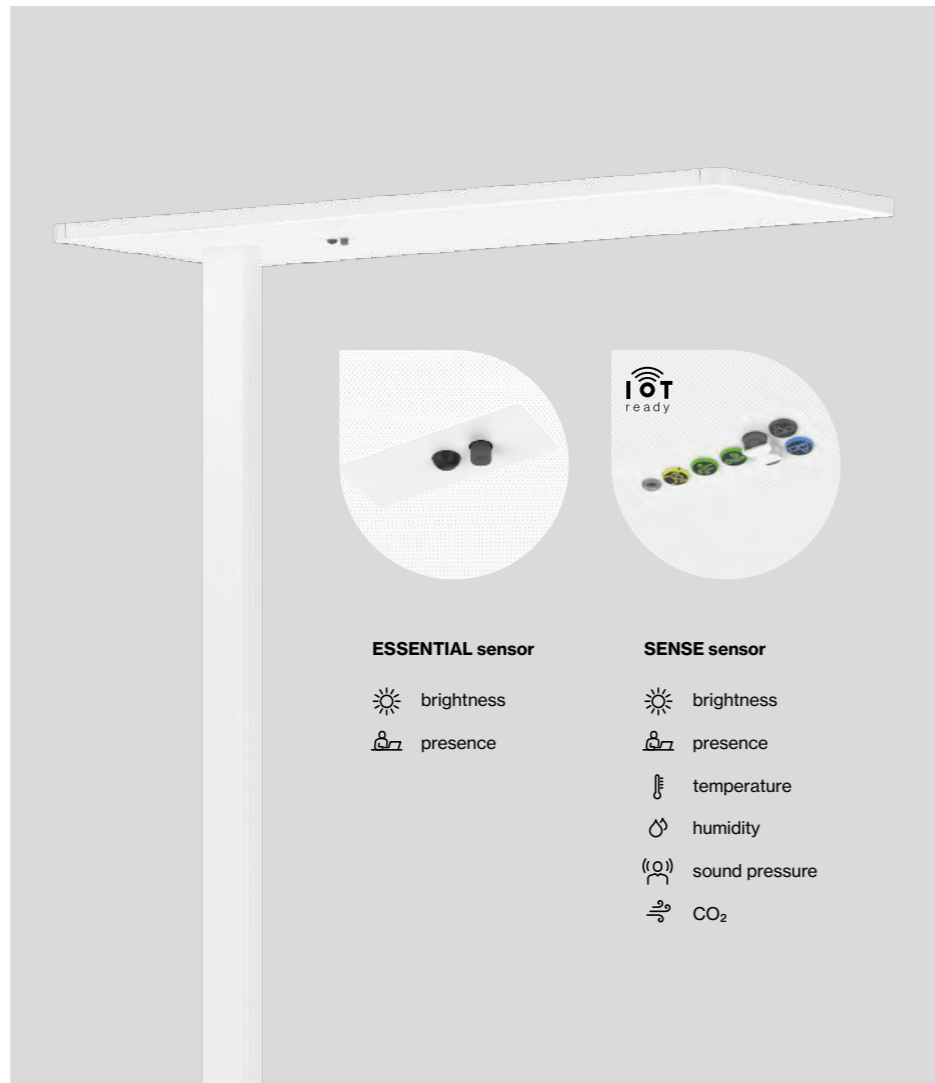

Screen-work friendly

EN TASK guarantees standard-compliant illumination of workplaces with custom anti-glare prisms. TASK also focuses on brightness and reduces reflections. An ideal light source for double workstations in open-plan offices and also for single workstations in smaller offices.

DE Durch spezielle Entblendungsprismen garantiert TASK eine normgerechte Ausleuchtung von Arbeitsplätzen. Eine ideale Lichtquelle für Doppelarbeitsplätze in Großraumbüros aber auch für Einzelarbeitsplätze in kleineren Büroräumen und das bei reduzierten Spiegelungen.

Full-spectrum LED

EN XAL's new XPECTRUM LEDs deliver healthy, biologically effective light. The reduced blue light and increased cyan values reduce the blue light hazard for the eye to daylight-equivalent levels. The resulting non-visual, so-called melanopic light effect, improves concentration and increases sleep quality. The excellent colour rendering of IES T_M 30-15 R_i = 98 and R_g = 101 further helps visual comfort.

DE Die neue XPECTRUM LED von XAL sorgt für gesundes, biologisch wirksames Licht. Der reduzierte Blaulichtanteil sowie die erhöhten Cyan-Werte minimieren die Blaulichtgefahr für das Auge auf ein tageslichtähnliches Niveau. Die daraus resultierende nichtvisuelle, auch melanopische Lichtwirkung genannt, fördert die Konzentration und steigert die Schlafqualität. Die hervorragende Farbwiedergabe von IES T_M 30-15 R_i = 98 und R_g = 101 ermöglicht zudem einen verbesserten Sehkomfort.

XPECTRUM LED

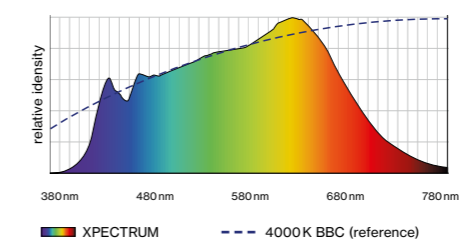

Commercially available LED 4000K

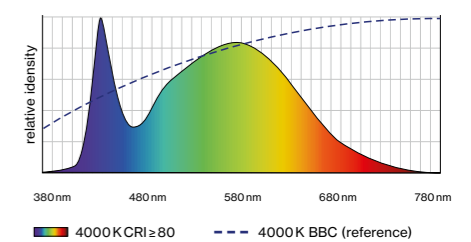

← back

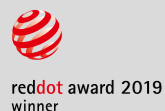
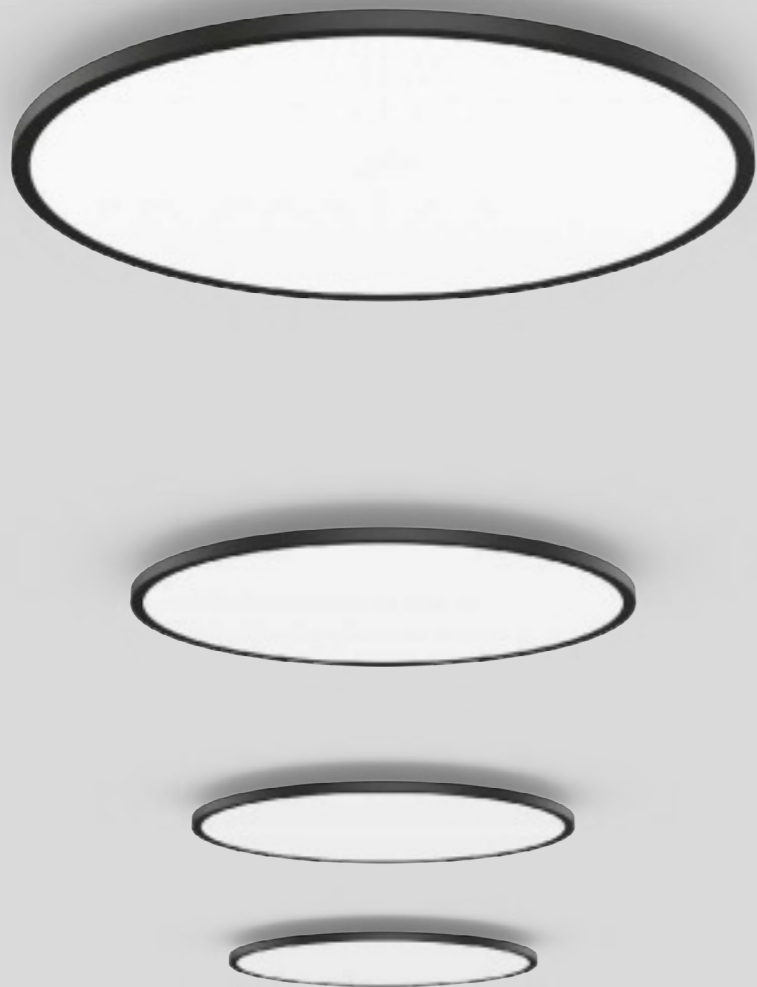

TASK round surface

EN Round luminaire housing in aluminium; ultra low-profile design (only 15 mm); surface powder coated; convenient quick mounting system without tools; direct light distribution by LGP body (Light Guiding Prism); side coupled light directed downwards by laser engraving; light control via highly reflective reflector material; completely homogeneous illumination; energy-efficient LEDs with very good colour rendering; luminaire with 2 cable openings and plug-in terminals for through wiring; sound absorbing accessories available

DE Runder Leuchtenkörper aus Aluminium; extrem flache Bauform (nur 15 mm); Oberfläche pulverbeschichtet; komfortables, werkzeugloses Schnellmontagesystem; direkte Lichtverteilung durch LGP-Body (Light-Guiding-Prism); seitlich eingekoppeltes Licht durch Lasergravur nach unten gelenkt; Lichtlenkung mittels hochreflektierenden Reflektormaterials; absolut homogene Ausleuchtung; energieeffiziente LEDs mit sehr guter Farbwiedergabe; Leuchte mit 2 Kabelöffnungen und Steckklemme für Weiterverdrahtung; schallabsorbierendes Zubehör erhältlich

Quickinfo

3000K, 4000K
 CRI ≥ 90, 3 SDCM
 UGR ≤ 19 / 65° ≤ 3000 cd/m²
 up to 136 lm/W
 L90 @ 50 000 h
 DALI-2
 microprismatic (UGR ≤ 19)
 IP 40

Types

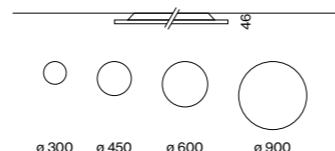

Colours



Light distribution

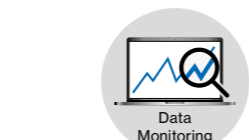

DiiA® standards
 251, 252, 253



DIN EN 12464-1 UGR ≤ 19 easy mounting by click-mechanism



acoustic elements (p. 456) CRI ≥ 98 XPECTRUM

Order options

COLOUR TEMPERATURE
 3000K 0
 4000K 1

CONTROL
 DALI-2

MATERIAL COLOUR
 pure white RAL 9010 7
 jet black RAL 9005 8
 special colours p. 992 X

LIGHT OPTIC COVER
 microprismatic (UGR ≤ 19)

Options on request

COLOUR RENDERING INDEX
 CRI ≥ 80
 CRI ≥ 98 XPECTRUM

CONTROL
 Casambi

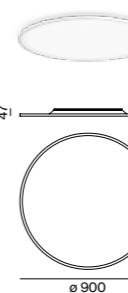
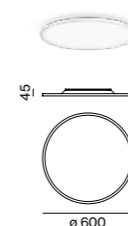
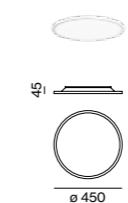
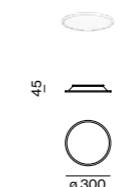

TASK 300 round surface



DIRECT			
SYSTEM POWER	COLOUR TEMP.	LUMINOUS FLUX	ORDER CODE
11.4W	3000K	1020 lm	0 5 9 - 0 1 5 0 :: 3 P
	4000K	1080 lm	

TASK 450 round surface



DIRECT			
SYSTEM POWER	COLOUR TEMP.	LUMINOUS FLUX	ORDER CODE
16W	3000K	1750 lm	0 5 9 - 0 1 4 1 :: 3 P
	4000K	1860 lm	
22.8W	3000K	2400 lm	0 5 9 - 0 1 5 1 :: 3 P
	4000K	2560 lm	

TASK 600 round surface



DIRECT			
SYSTEM POWER	COLOUR TEMP.	LUMINOUS FLUX	ORDER CODE
30W	3000K	3470 lm	0 5 9 - 0 1 4 2 :: 3 P
	4000K	3690 lm	
40W	3000K	4350 lm	0 5 9 - 0 1 5 2 :: 3 P
	4000K	4630 lm	

TASK 900 round surface



DIRECT			
SYSTEM POWER	COLOUR TEMP.	LUMINOUS FLUX	ORDER CODE
52W	3000K	6630 lm	0 5 9 - 0 1 4 3 :: 3 P
	4000K	7060 lm	

Technical data

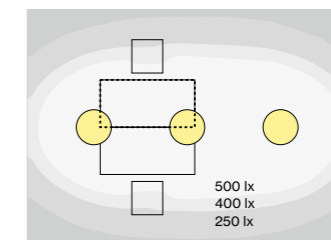

TASK 600 round surface
 30W, 4000K, direct

ROOM VALUES
 Room dimensions 5.4 × 4 × 2.8m
 Reflection factor 0.7 | 0.5 | 0.2
 Maintenance factor 0.8

CALCULATION SURFACE
 Surface dimensions 1.6 × 0.8m
 Surface height 0.75m
 Average illuminance (E_{av}) > 500 lx
 Uniformity (U₀) > 0.6



GLARE EVALUATION
 Table Classification X=4H | Y=8H | S=0.25H
 UGR transversal ≤ 19
 UGR axial ≤ 19
 ≥ 65° ≤ 3000 cd/m²

LUMINOUS FLUX value calculated for CRI ≥ 90, colour white, cover microprismatic

**Triplex Universitätsbibliothek
und Ausleihe** Heidelberg, DE –
by ap88 Architekten Partner-
schaft mbB with lighting design
by LDE BELZNER HOLMES



← back



TASK round suspended

EN Round luminaire housing in aluminium; ultra low-profile design (only 15 mm); powder coated; suspended; with height adjustable rod suspension (chrome), feed in rod; direct light distribution by LGP body (Light Guiding Prism); side coupled light directed downwards by laser engraving; light control via highly reflective reflector material; optional: indirect component with special PCBs for increased luminous flux and maximum ceiling illumination; completely homogeneous illumination; energy-efficient LEDs with very good colour rendering; canopy for through wiring; sound absorbing accessories available

DE Runder Leuchtenkörper aus Aluminium; extrem flache Bauform (nur 15 mm); pulverbeschichtet; abgependelt; mit kürzbarer Pendelrohrabhangung (chrom), Einspeiseleitung in Pendelrohr; direkte Lichtverteilung durch LGP-Body (Light-Guiding-Prism); seitlich eingekoppeltes Licht durch Lasergravur nach unten gelenkt; Lichtlenkung mittels hochreflektierenden Reflektormaterials; optional: Indirektlichtanteil mit eigenen Platinen für erhöhten Lichtstrom und maximale Deckenaufhellung; absolut homogene Ausleuchtung; energieeffiziente LEDs mit sehr guter Farbwiedergabe; Baldachin für Weiterverdrahtung; schallabsorbierendes Zubehör erhältlich

Quickinfo

3000K, 4000K
 CRI ≥ 90, 3 SDCM
 UGR ≤ 19 / 65° ≤ 3000 cd/m²
 up to 137 lm/W
 L90 @ 50 000 h
 DALI-2
 microprismatic (UGR ≤ 19)
 IP 40

Types

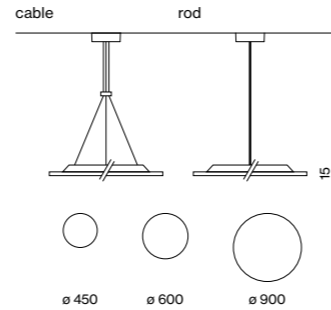

Colours



Light distributions

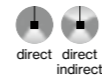

DiiA® standards
 251, 252, 253



DIN EN 12464-1 UGR ≤ 19 direct/indirect illumination



acoustic elements (p. 456) CRI ≥ 98 XPECTRUM

Order options

SUSPENSION
 cable 1500 mm 2
 rod 1000 mm 4

COLOUR TEMPERATURE
 3000K 0
 4000K 1

CONTROL
 DALI-2

MATERIAL COLOUR
 ○ pure white RAL 9010 7
 ● jet black RAL 9005 8
 ● special colours* p. 992 X
 *canopy always in white

LIGHT OPTIC COVER
 microprismatic (UGR ≤ 19)

Options on request
COLOUR RENDERING INDEX
 CRI ≥ 80
 CRI ≥ 98 XPECTRUM

SUSPENSION
 rod 2000 mm

CONTROL
 Casambi

Light distribution

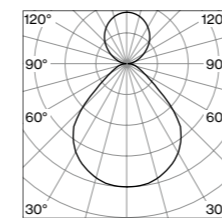

microprismatic
 direct/indirect power

LUMINOUS FLUX value calculated for CRI ≥ 90, colour white, cover microprismatic

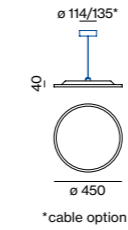

*cable option

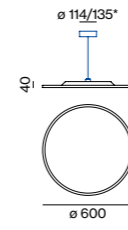

*cable option

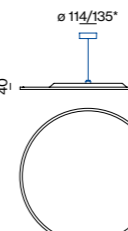

*cable option

TASK 450 round suspended



DIRECT		ORDER CODE	
SYSTEM POWER	COLOUR TEMP.	LUMINOUS FLUX	
16 W	3000 K	1750 lm	0 5 9 - 0 4 1 :: 3 P
	4000 K	1860 lm	



DIRECT / INDIRECT POWER		ORDER CODE	
SYSTEM POWER	COLOUR TEMP.	LUMINOUS FLUX	
38 W	3000 K	↓ 2710 / ↑ 1460 lm	0 5 9 - 0 5 6 1 :: 3 P
	4000 K	↓ 2880 / ↑ 1550 lm	

TASK 600 round suspended



DIRECT		ORDER CODE	
SYSTEM POWER	COLOUR TEMP.	LUMINOUS FLUX	
30 W	3000 K	3470 lm	0 5 9 - 0 3 4 2 :: 3 P
	4000 K	3690 lm	



DIRECT / INDIRECT POWER		ORDER CODE	
SYSTEM POWER	COLOUR TEMP.	LUMINOUS FLUX	
45 W	3000 K	↓ 3470 / ↑ 1770 lm	0 5 9 - 0 3 6 2 :: 3 P
	4000 K	↓ 3690 / ↑ 1880 lm	

TASK 900 round suspended

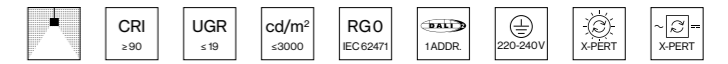

DIRECT		ORDER CODE	
SYSTEM POWER	COLOUR TEMP.	LUMINOUS FLUX	
52 W	3000 K	6630 lm	0 5 9 - 0 3 4 3 :: 3 K
	4000 K	7060 lm	



DIRECT / INDIRECT POWER		ORDER CODE	
SYSTEM POWER	COLOUR TEMP.	LUMINOUS FLUX	
100 W	3000 K	↓ 8800 / ↑ 4110 lm	0 5 9 - 0 3 6 3 :: 3 K
	4000 K	↓ 9370 / ↑ 4370 lm	



INSPIRATIONAL BOARD

- Hör mal!**
 - Podcast: Episode MWC24 - Gedanken des ersten Welt im Wandel
 - SAP Education: Neueste Episode DE
 - "Wirtschaft - Learning Podcast"
 - "RF" - Podcast des Bayer Medical
 - 12min
- Lies mal!**
 - "Yacht Club: Harzvi"
 - 121 Buchtipps für das 2024!
 - "The Culture Code: The secrets of highly successful groups"
- Schau mal!**
 - WIRED: 5 Levels
 - "Anforderungen an die 5. Ebene des ..."

Microsoft Office
Brussels, BE –
by PROCOS Group



← back

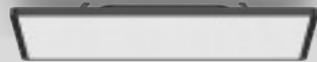
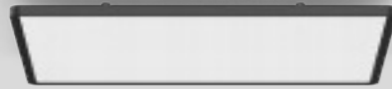
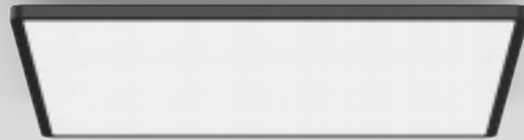

TASK square surface

EN Square housing made of aluminium with rounded edges; ultra low-profile design (only 15 mm); surface powder coated; convenient quick mounting system without tools; direct light distribution by LGP body (Light Guiding Prism); side coupled light directed downwards by laser engraving; light control via highly reflective reflector material; completely homogeneous illumination; energy-efficient LEDs with very good colour rendering; luminaire with 2 cable openings and plug-in terminals for through wiring; sound absorbing accessories available

DE Quadratischer Leuchtenkörper aus Aluminium mit abgerundeten Kanten; extrem flache Bauform (nur 15 mm); Oberfläche pulverbeschichtet; komfortables, werkzeugloses Schnellmontagesystem; direkte Lichtverteilung durch LGP-Body (Light-Guiding-Prism); seitlich eingekoppeltes Licht durch Lasergravur nach unten gelenkt; Lichtlenkung mittels hochreflektierenden Reflektormaterials; absolut homogene Ausleuchtung; energieeffiziente LEDs mit sehr guter Farbwiedergabe; Leuchte mit 2 Kabelöffnungen und Steckklemme für Weiterverdrahtung; schallabsorbierendes Zubehör erhältlich

Quickinfo

3000K, 4000K
 CRI ≥ 90, 3 SDCM
 UGR ≤ 19 / 65° ≤ 3000 cd/m²
 up to 137 lm/W
 L90 @ 50 000h
 DALI-2
 microprismatic (UGR ≤ 19)

Types

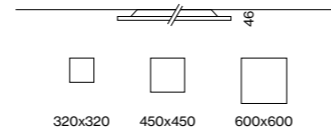

Colours



Light distribution

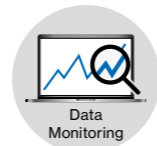

DiiA® standards
 251, 252, 253

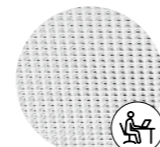

DIN EN 12464-1
 UGR ≤ 19



easy
 mouting



acoustic
 elements (p.456)

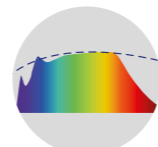

CRI ≥ 98
 XPECTRUM

Order options

COLOUR TEMPERATURE	
3000K	0
4000K	1

CONTROL

DALI-2

MATERIAL COLOUR

○ pure white RAL 9010	7
● jet black RAL 9005	8
● special colours p.992	X

LIGHT OPTIC COVER

microprismatic (UGR ≤ 19)

Options on request

COLOUR RENDERING INDEX

CRI ≥ 80
 CRI ≥ 98 XPECTRUM

CONTROL

Casambi



TASK 320 square surface



DIRECT

SYSTEM POWER	COLOUR TEMP.	LUMINOUS FLUX	ORDER CODE
11.8W	3000K	1230lm	0 5 9 - 2 1 1 0 :: 3 ▣ K
	4000K	1310lm	

TASK 450 square surface

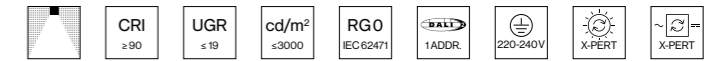

DIRECT

SYSTEM POWER	COLOUR TEMP.	LUMINOUS FLUX	ORDER CODE
15W	3000K	1880lm	0 5 9 - 2 1 4 1 :: 3 ▣ K
	4000K	2000lm	

TASK 600 square surface



DIRECT

SYSTEM POWER	COLOUR TEMP.	LUMINOUS FLUX	ORDER CODE
27.3W	3000K	3510lm	0 5 9 - 2 1 4 2 :: 3 ▣ K
	4000K	3730lm	

Technical data

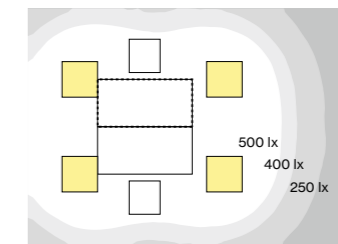

TASK 600 square surface
 27.3W, 4000K, direct

ROOM VALUES
 Room dimensions 5.4×4×2.8m
 Reflection factor 0.7 | 0.5 | 0.2
 Maintenance factor 0.8

CALCULATION SURFACE
 Surface dimensions 1.6×0.8m
 Surface height 0.75m
 Average illuminance (E_m) > 500 lx
 Uniformity (U₀) > 0.6

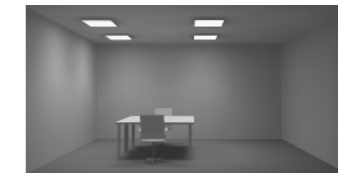

GLARE EVALUATION
 Table Classification X=4H | Y=8H | S=0.25H
 UGR transversal ≤ 19
 UGR axial ≤ 19
 ≥ 65° ≤ 3000 cd/m²

LUMINOUS FLUX value calculated for
 CRI ≥ 90, colour white, cover microprismatic

Art Invest headquarters Cologne, DE –
by Lepel & Lepel Architektur with
lighting design by Volker von Kardorff



← back



TASK square

suspended

EN Square housing made of aluminium with rounded edges; ultra low-profile design (only 15 mm); powder coated; pendant fitting with cable suspension (4 cables); with integrated tool-less suspension height adjustment; incl. transparent feed; direct light distribution by LGP body (Light Guiding Prism); side coupled light directed downwards by laser engraving; light control via highly reflective reflector material; optional: indirect component with special PCBs for increased luminous flux and maximum ceiling illumination; completely homogeneous illumination; energy-eff. LEDs – very good colour rendering; canopy for through wiring; sound absorbing accessories available

DE Quadratischer Leuchtenkörper aus Aluminium mit abgerundeten Kanten; extrem flache Bauform (nur 15 mm); pulverbeschichtet; abgependelt mit Seilabhangung (4 Seile); werkzeuglose Hohenverstellung an der Leuchte; inkl. transparenter Einspeiseleitung; direkte Lichtverteilung durch LGP-Body (Light-Guiding-Prism); seitlich eingekoppeltes Licht durch Lasergravur nach unten gelenkt; Lichtlenkung mittels hochreflektierenden Reflektormaterials; optional: Indirektlichtanteil mit eigenen Platinen fur erhoheten Lichtstrom und maximale Deckenaufhellung; absolut homogene Ausleuchtung; energieeff. LEDs – sehr gute Farbwiedergabe; Baldachin fur Weiterverdrahtung; schallabsorbierendes Zubehor erhaltlich

Quickinfo

3000K, 4000K
 CRI ≥ 90, 3 SDCM
 UGR ≤ 19 / 65° ≤ 3000 cd/m²
 up to 137 lm/W
 L90 @ 50 000h
 DALI-2
 microprismatic (UGR ≤ 19)

Types

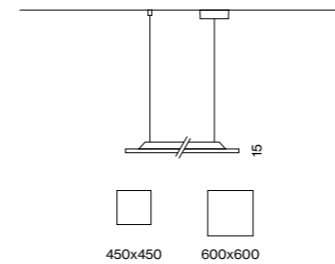

Colours



Light distributions



DiiA® standards
 251, 252, 253

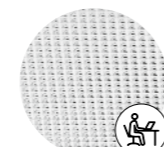

DIN EN 12464-1
 UGR ≤ 19



flat design
 (15 mm)



acoustic
 elements (p.456)

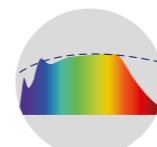

CRI ≥ 98
 XPECTRUM

Order options

SUSPENSION
 cable 1500mm

COLOUR TEMPERATURE

3000K	0
4000K	1

CONTROL
 DALI-2

MATERIAL COLOUR

○ pure white RAL 9010	7
● jet black RAL 9005	8
● special colours* p.992	X

*canopy always in white

LIGHT OPTIC COVER
 microprismatic (UGR ≤ 19)

Options on request

COLOUR RENDERING INDEX
 CRI ≥ 80
 CRI ≥ 98 XPECTRUM

CONTROL
 Casambi

Light distributions

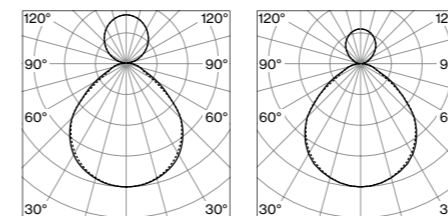

TASK 450 microprismatic direct/indirect power
 TASK 600 microprismatic direct/indirect power

LUMINOUS FLUX value calculated for
 CRI ≥ 90, colour white, cover microprismatic

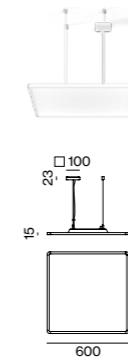
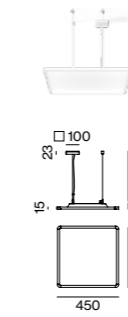

TASK 450 square suspended

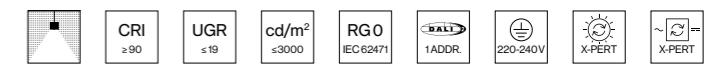

DIRECT

SYSTEM POWER	COLOUR TEMP.	LUMINOUS FLUX	ORDER CODE
15W	3000K	1880lm	0 5 9 - 2 2 1 1 :: 3 ▣ K
	4000K	2000lm	



DIRECT / INDIRECT POWER

SYSTEM POWER	COLOUR TEMP.	LUMINOUS FLUX	ORDER CODE
35W	3000K	↓ 2910 / ↑ 1470 lm	0 5 9 - 2 2 3 1 :: 3 ▣ K
	4000K	↓ 3100 / ↑ 1570 lm	

TASK 600 square suspended

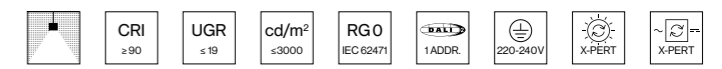

DIRECT

SYSTEM POWER	COLOUR TEMP.	LUMINOUS FLUX	ORDER CODE
27.3W	3000K	3510lm	0 5 9 - 2 2 1 2 :: 3 ▣ K
	4000K	3730lm	



DIRECT / INDIRECT POWER

SYSTEM POWER	COLOUR TEMP.	LUMINOUS FLUX	ORDER CODE
57W	3000K	↓ 5660 / ↑ 1530 lm	0 5 9 - 2 2 3 2 :: 3 ▣ K
	4000K	↓ 6020 / ↑ 1620 lm	

Technical data

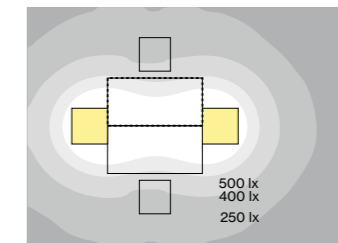

TASK 600 square suspended
 57W, 4000K, direct/indirect power

ROOM VALUES

Room dimensions	5.4 × 4 × 2.8m
Reflection factor	0.7 0.5 0.2
Maintenance factor	0.8
Suspension height	2.25m

CALCULATION SURFACE

Surface dimensions	1.6 × 0.8m
Surface height	0.75m
Average illuminance (E _m)	> 500lx
Uniformity (U ₀)	> 0.6

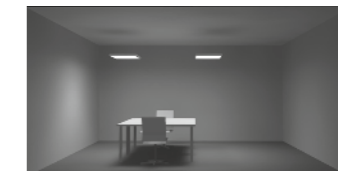

GLARE EVALUATION

Table Classification X=4H Y=8H S=0.25H	
UGR transversal	≤ 19
UGR axial	≤ 19

XAL headquarters Graz, AT –
by INNOCAD Architektur ZT



← back

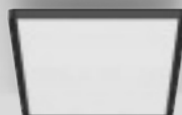

TASK

ceiling

EN Rectangular housing made of aluminium with rounded edges; ultra low-profile design (only 15 mm); surface powder coated; convenient quick mounting system without tools; direct light distribution by LGP body (Light Guiding Prism); side coupled light directed downwards by laser engraving; light control via highly reflective reflector material; completely homogeneous illumination; energy-efficient LEDs with very good colour rendering; luminaire with 2 cable openings and plug-in terminals for through wiring

DE Rechteckiger Leuchtenkörper aus Aluminium mit abgerundeten Kanten; extrem flache Bauform (nur 15 mm); Oberfläche pulverbeschichtet; komfortables, werkzeugloses Schnellmontagesystem; direkte Lichtverteilung durch LGP-Body (Light-Guiding-Prism); seitlich eingekoppeltes Licht durch Lasergravur nach unten gelenkt; Lichtlenkung mittels hochreflektierenden Reflektormaterials; absolut homogene Ausleuchtung; energieeffiziente LEDs mit sehr guter Farbwiedergabe; Leuchte mit 2 Kabelöffnungen und Steckklemme für Weiterverdrahtung

Quickinfo

3000K, 4000K, TW
 CRI ≥ 90, 3 SDCM
 UGR ≤ 19 / 65° ≤ 3000 cd/m²
 up to 131lm/W
 L80 @ 50 000h
 DALI-2
 microprismatic (UGR ≤ 19)

Types

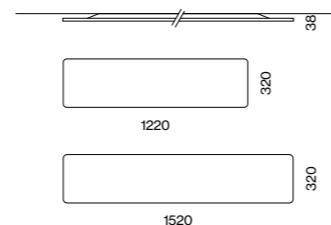

Colours



Light distribution



Order options

COLOUR TEMPERATURE
 3000K 0
 4000K 1
 tunable white 2700–6500K*
 *DALI-2 DT8; CRI ≥ 80

CONTROL

DALI-2

MATERIAL COLOUR

○ pure white RAL 9010 7
 ● jet black RAL 9005 8
 ● special colours p.992 X

LIGHT OPTIC COVER

microprismatic (UGR ≤ 19)

Options on request

COLOUR RENDERING INDEX

CRI ≥ 80
 CRI ≥ 98 XPECTRUM

CONTROL

ESSENTIAL sensor
 (brightness & presence)

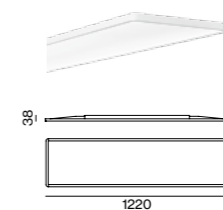

TASK 1200 ceiling



DIRECT

SYSTEM POWER	COLOUR TEMP.	LUMINOUS FLUX	ORDER CODE
28.4W	3000K	3440lm	0 5 9 - 2 1 1 4 :: 3 K
29.3W	4000K	3660lm	
	2700–6500K	± 3220lm	0 5 9 - 2 1 1 4 D 3 K

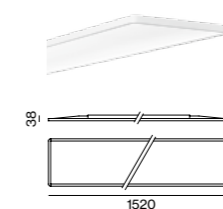

TASK 1500 ceiling



DIRECT

SYSTEM POWER	COLOUR TEMP.	LUMINOUS FLUX	ORDER CODE
36W	3000K	4300lm	0 5 9 - 2 1 1 5 :: 3 K
	4000K	4570lm	
37W	2700–6500K	± 4020lm	0 5 9 - 2 1 1 5 D 3 K

Technical data

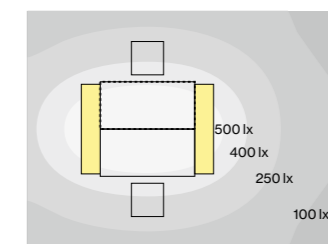

TASK 1500 ceiling
 36W, 4000K, direct

ROOM VALUES
 Room dimensions 5.4 × 4 × 2.8m
 Reflection factor 0.7 | 0.5 | 0.2
 Maintenance factor 0.8

CALCULATION SURFACE
 Surface dimensions 1.6 × 0.8m
 Surface height 0.75m
 Average illuminance (E_{av}) > 500 lx
 Uniformity (U₀) > 0.6



GLARE EVALUATION
 Table Classification X=4H | Y=8H | S=0.25H
 UGR transversal ≤ 19
 UGR axial ≤ 19
 ≥ 65° ≤ 3000 cd/m²

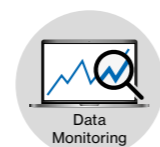

DiiA® standards
 251, 252, 253



DIN EN 12464-1
 UGR ≤ 19

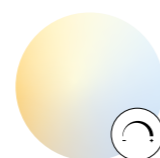

tunable white
 2700–6500K

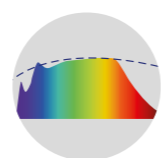

CRI ≥ 98
 XPECTRUM

LUMINOUS FLUX value calculated for
 CRI ≥ 90, colour white, cover microprismatic

Münchner Rückversicherung Munich, DE –
by Scholz - SorgerArchitekten Partnerschaft mbB
with lighting design by Lumen³ GbR

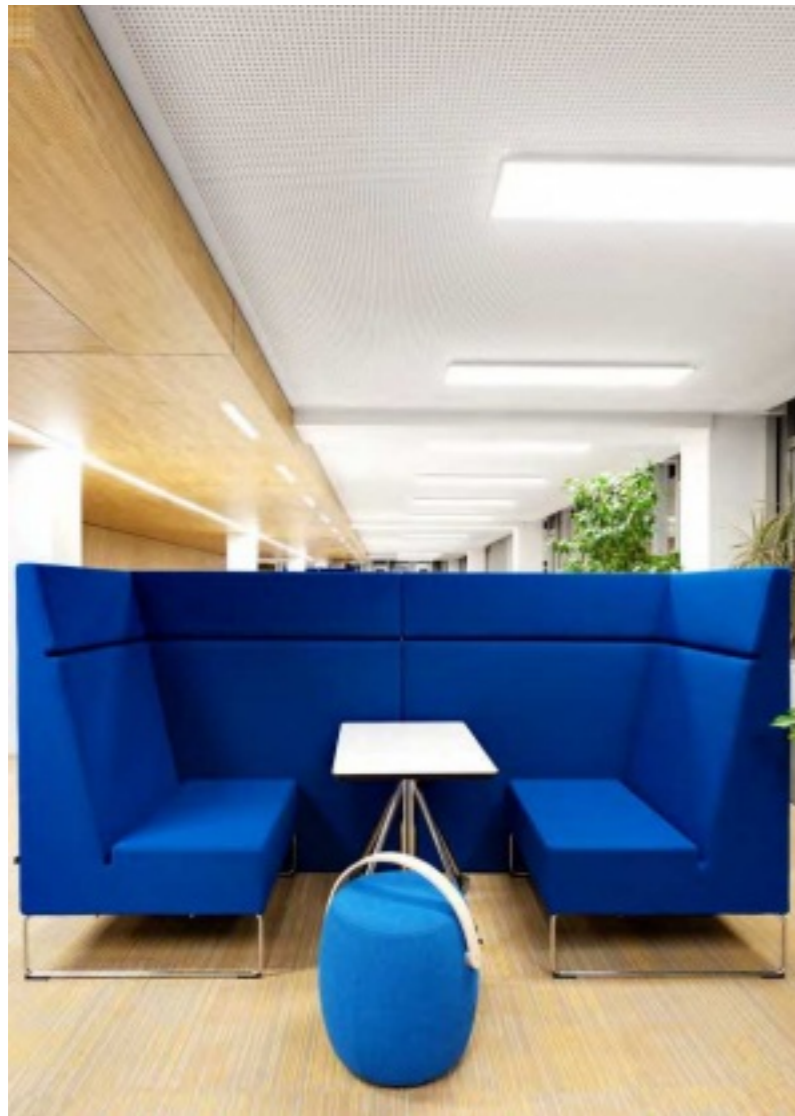

← back



 **reddot award 2015**
winner



TASK

suspended

EN Rectangular housing made of aluminium with rounded edges; ultra low-profile design (only 15 mm); surface powder coated; 1500 mm cable suspension, tool-less height adjustment; incl. transparent feed; direct light distribution by LGP body (Light Guiding Prism); side coupled light directed downwards by laser engraving; indirect component with special PCBs for increased luminous flux and maximum ceiling illumination; completely homogeneous illumination; energy-efficient LEDs with very good colour rendering; canopy with 2 cable openings and plug-in terminal for through wiring

DE Rechteckiger Leuchtenkörper aus Aluminium mit abgerundeten Kanten; extrem flache Bauform (nur 15 mm); Oberfläche pulverbeschichtet; werkzeuglos höhenverstellbare 1500 mm Seilabhängung; inkl. transparenter Einspeiseleitung; direkte Lichtverteilung durch LGP-Body (Light-Guiding-Prism); seitlich eingekoppeltes Licht durch Lasergravur nach unten gelenkt; Indirektlichtanteil mit eigenen Platinen für erhöhten Lichtstrom und maximale Deckenaufhellung; absolut homogene Ausleuchtung; energieeffiziente LEDs mit sehr guter Farbwiedergabe; Baldachin mit 2 Kabelöffnungen und Steckklemme für Weiterverdrahtung

Quickinfo

3000K, 4000K, TW
CRI ≥ 90, 3 SDCM
UGR ≤ 19 / 65° ≤ 3000 cd/m²
up to 129 lm/W
L80 @ 50 000 h
DALI-2
microprismatic (UGR ≤ 19)
IP 40

Types

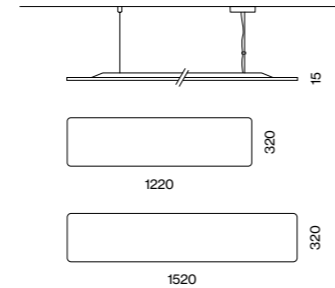

Colours



Light distribution

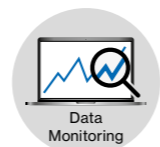

DiiA® standards
251, 252, 253

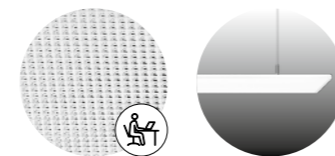

DIN EN 12464-1
UGR ≤ 19 direct/indirect illumination

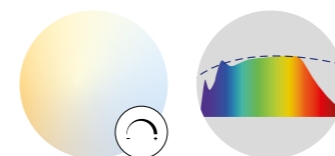

tunable white
2700–6500 K CRI ≥ 98 XPECTRUM

Order options

SUSPENSION
cable 1500 mm

COLOUR TEMPERATURE
3000K 0
4000K 1
tunable white 2700–6500K*
*DALI-2 DT8; CRI ≥ 80

CONTROL
DALI-2

MATERIAL COLOUR
○ pure white RAL 9010 7
● jet black RAL 9005 8
● special colours* p. 992 X
*canopy always in white

LIGHT OPTIC COVER
microprismatic (UGR ≤ 19)

Options on request

COLOUR RENDERING INDEX
CRI ≥ 80
CRI ≥ 98 XPECTRUM

CONTROL
ESSENTIAL sensor
(brightness & presence)

Light distribution

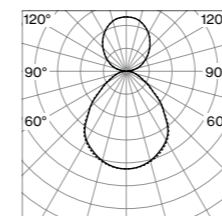

microprismatic
direct/indirect power

LUMINOUS FLUX value calculated for
CRI ≥ 90, colour white, cover microprismatic

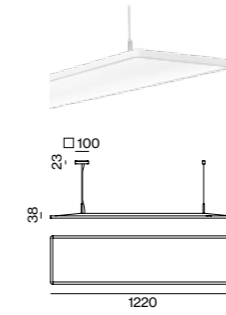

TASK 1200 suspended

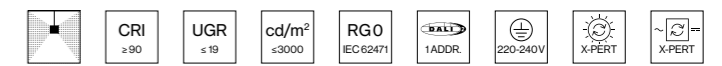

DIRECT/INDIRECT POWER		ORDER CODE	
SYS. POWER	COLOUR TEMP.	LUMINOUS FLUX	
50 W	3000 K	↓ 3890 / ↑ 2180 lm	0 5 9 - 2 2 2 4 :: 3 K
52 W	4000 K	↓ 4140 / ↑ 2320 lm	
	2700–6500 K	↓ 3620 / ↑ 2100 lm	0 5 9 - 2 2 2 4 D 3 K

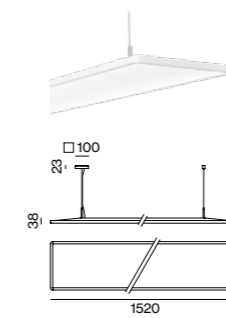

TASK 1500 suspended

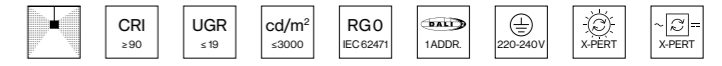

DIRECT/INDIRECT POWER		ORDER CODE	
SYS. POWER	COLOUR TEMP.	LUMINOUS FLUX	
63 W	3000 K	↓ 4860 / ↑ 2720 lm	0 5 9 - 2 2 2 5 :: 3 K
64 W	4000 K	↓ 5170 / ↑ 2900 lm	
	2700–6500 K	↓ 4530 / ↑ 2630 lm	0 5 9 - 2 2 2 5 D 3 K

Technical data

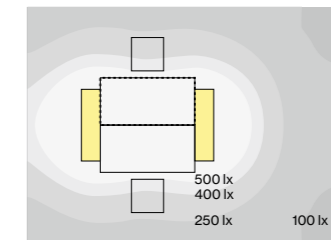

TASK 1200 suspended
50 W, 4000 K, direct/indirect power

ROOM VALUES
Room dimensions 5.4 × 4 × 2.8 m
Reflection factor 0.7 | 0.5 | 0.2
Maintenance factor 0.8
Suspension height 2.25 m

CALCULATION SURFACE
Surface dimensions 1.6 × 0.8 m
Surface height 0.75 m
Average illuminance (E_{av}) > 500 lx
Uniformity (U₀) > 0.6



GLARE EVALUATION
Table Classification X=4H | Y=8H | S=0.25H
UGR transversal ≤ 19
UGR axial ≤ 19
≥ 65° ≤ 3000 cd/m²



Takeda Office Lodz, PL –
by The Design Group with lighting design
by Plus Lighting



← back



TASK S

suspended

EN Rectangular housing made of aluminium with rounded edges; ultra low-profile design (only 15 mm); surface powder coated; 1500 mm cable suspension, tool-less height adjustment; incl. transparent feed; direct or direct/indirect light distribution by LGP body (Light Guiding Prism); side coupled light, directed downwards or up and down by laser engraving; light control via highly reflective reflector material; optional: indirect component with special PCBs for increased luminous flux and maximum ceiling illumination; completely homogeneous illumination; energy-efficient LEDs with very good colour rendering; canopy with 2 cable openings and plug-in terminal for through wiring

DE Rechteckiger Leuchtenkörper aus Aluminium mit abgerundeten Kanten; extrem flache Bauform (nur 15 mm); Oberfläche pulverbeschichtet; werkzeuglos höhenverstellbare 1500 mm Seilabhängung; inkl. transparenter Einspeiseleitung; direkte bzw. direkt/indirekte Lichtverteilung durch LGP-Body (Light-Guiding-Prism); seitlich eingekoppeltes Licht durch Lasergravur nach unten bzw. oben und unten gelenkt; Lichtlenkung mittels hochreflektierenden Reflektormaterials; optional: Indirektlichtanteil mit eigenen Platinen für erhöhten Lichtstrom und maximale Deckenaufhellung; absolut homogene Ausleuchtung; energieeffiziente LEDs mit sehr guter Farbwiedergabe; Baldachin mit 2 Kabelöffnungen und Steckklemme für Weiterverdrahtung

Quickinfo

3000K, 4000K, TW
 CRI ≥ 90, 3 SDCM
 UGR ≤ 19 / 65° ≤ 3000 cd/m²
 up to 126 lm/W
 L95 @ 50 000 h
 DALI-2
 brightness & presence sensor
 microprismatic (UGR ≤ 19)

Types

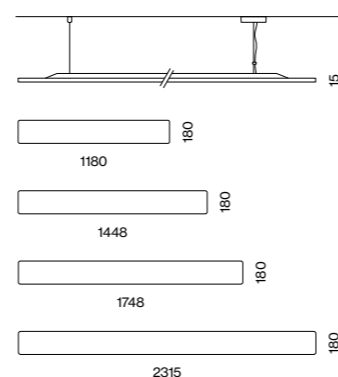

Colours

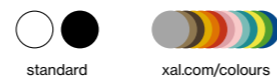

Light distributions



DiiA® standards 251, 252, 253
 direct/indirect illumination

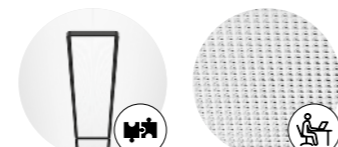

system solution (p.812)
 DIN EN 12464-1 UGR ≤ 19

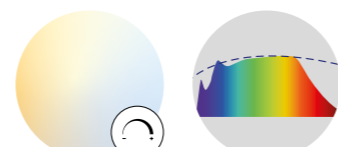

tunable white 2700–6500 K
 CRI ≥ 98 XPECTRUM

Order options

SUSPENSION

cable 1500 mm

COLOUR TEMPERATURE

3000K	0
4000K	1
tunable white 2700–6500K*	

*DALI-2 DT8; CRI ≥ 80

3000K + TW 2700–6500K
 4000K + TW 2700–6500K

DALI-2 DT8 (separately controllable)

CONTROL

DALI-2	3
ESSENTIAL sensor* (brightness & presence)	7

*version with sensor: length + 9 mm

MATERIAL COLOUR

○ pure white RAL 9010	7
● jet black RAL 9005	8
● special colours* p.992	X

*canopy always in white

LIGHT OPTIC COVER

microprismatic (UGR ≤ 19)

Order options

COLOUR RENDERING INDEX

CRI ≥ 80
 CRI ≥ 98 XPECTRUM

Light distribution

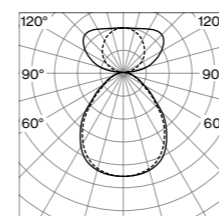

microprismatic
 direct/indirect power

LUMINOUS FLUX value calculated for CRI ≥ 90, colour white, cover microprismatic

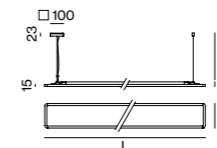

TASK S suspended



DIRECT / INDIRECT SOFT

SYS. POWER	COLOUR TEMP.	LUM. FLUX	L (mm)	ORDER CODE
19.5 W	3000 K	↓ 1900 / ↑ 327 lm	1180	0 5 9 - 5 2 5 4 :: ▣ ▣ K
	4000 K	↓ 2020 / ↑ 347 lm		
24.4 W	3000 K	↓ 2380 / ↑ 408 lm	1448	0 5 9 - 5 2 5 5 :: ▣ ▣ K
	4000 K	↓ 2540 / ↑ 435 lm		
29.2 W	3000 K	↓ 2860 / ↑ 490 lm	1748	0 5 9 - 5 2 5 6 :: ▣ ▣ K
	4000 K	↓ 3040 / ↑ 521 lm		
39 W	3000 K	↓ 3810 / ↑ 653 lm	2315	0 5 9 - 5 2 5 8 :: ▣ ▣ K
	4000 K	↓ 4050 / ↑ 695 lm		



DIRECT / INDIRECT POWER

SYS. POWER	COLOUR TEMP.	LUM. FLUX	L (mm)	ORDER CODE
29.6 W	3000 K	↓ 1890 / ↑ 1540 lm	1180	0 5 9 - 5 2 6 4 :: ▣ ▣ K
	4000 K	↓ 2010 / ↑ 1640 lm		
28.6 W	3000 K	↓ 1890 lm	1180	0 5 9 - 5 2 D 4 0 3 ▣ K
(2 × DALI)	2700–6500 K	↑ 1490 lm		
28.6 W	4000 K	↓ 2010 lm	1180	0 5 9 - 5 2 D 4 1 3 ▣ K
(2 × DALI)	2700–6500 K	↑ 1490 lm		
36 W (2 ×)	2700–6500 K	↑ 4010 lm	1180	0 5 9 - 5 2 6 4 D ▣ ▣ K
37 W	3000 K	↓ 2360 / ↑ 1920 lm	1448	0 5 9 - 5 2 6 5 :: ▣ ▣ K
	4000 K	↓ 2520 / ↑ 2050 lm		
36 W	3000 K	↓ 2360 lm	1448	0 5 9 - 5 2 D 5 0 ▣ ▣ K
(2 × DALI)	2700–6500 K	↑ 1860 lm		
36 W	4000 K	↓ 2520 lm	1448	0 5 9 - 5 2 D 5 1 ▣ ▣ K
(2 × DALI)	2700–6500 K	↑ 1860 lm		
44 W (2 ×)	2700–6500 K	↑ 5010 lm	1448	0 5 9 - 5 2 6 5 D ▣ ▣ K
44 W	3000 K	↓ 2840 / ↑ 2310 lm	1748	0 5 9 - 5 2 6 6 :: ▣ ▣ K
	4000 K	↓ 3020 / ↑ 2460 lm		
43 W	3000 K	↓ 2840 lm	1748	0 5 9 - 5 2 D 6 0 ▣ ▣ K
(2 × DALI)	2700–6500 K	↑ 2230 lm		
43 W	4000 K	↓ 3020 lm	1748	0 5 9 - 5 2 D 6 1 ▣ ▣ K
(2 × DALI)	2700–6500 K	↑ 2230 lm		
53 W (2 ×)	2700–6500 K	↑ 6010 lm	1748	0 5 9 - 5 2 6 6 D ▣ ▣ K
59 W	3000 K	↓ 3780 / ↑ 3080 lm	2315	0 5 9 - 5 2 6 8 :: ▣ ▣ K
	4000 K	↓ 4030 / ↑ 3270 lm		
57 W	3000 K	↓ 3780 lm	2315	0 5 9 - 5 2 D 8 0 ▣ ▣ K
(2 × DALI)	2700–6500 K	↑ 2970 lm		
57 W	4000 K	↓ 4030 lm	2315	0 5 9 - 5 2 D 8 1 ▣ ▣ K
(2 × DALI)	2700–6500 K	↑ 2970 lm		
71 W (2 ×)	2700–6500 K	↑ 8010 lm	2315	0 5 9 - 5 2 6 8 D ▣ ▣ K

Technical data

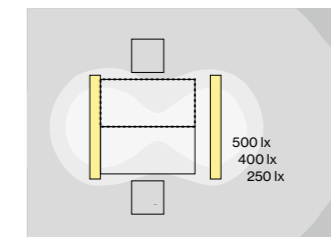

TASK S suspended, 1748 mm
 44 W, 4000 K, direct/indirect power

ROOM VALUES
 Room dimensions 5.4 × 4 × 2.8 m
 Reflection factor 0.7 | 0.5 | 0.2
 Maintenance factor 0.8
 Suspension height 2.25 m

CALCULATION SURFACE
 Surface dimensions 1.6 × 0.8 m
 Surface height 0.75 m
 Average illuminance (E_m) > 500 lx
 Uniformity (U₀) > 0.6

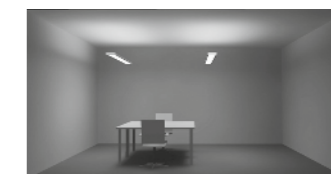

GLARE EVALUATION
 Table Classification X=4H | Y=8H | S=0.25H
 UGR transversal ≤ 19
 UGR axial ≤ 19

Dr. Schaer Burgstall, IT –
by monovolume architecture+
design with lighting design by
VON LUTZ - electrical and
lighting projects / Alexa von Lutz



back



TASK

wall

EN Rectangular housing made of aluminium with rounded edges; ultra low-profile design (only 15 mm); surface powder coated; suitable for wall mounting; direct light distribution by LGP body (Light Guiding Prism); side coupled light directed downwards by laser engraving; light control via highly reflective reflector material; indirect component with special PCBs with asymmetrical light distribution; for optimum ceiling illumination; completely homogeneous illumination; energy-efficient LEDs with very good colour rendering

DE Rechteckiger Leuchtenkörper aus Aluminium mit abgerundeten Kanten; extrem flache Bauform (nur 15 mm); Oberfläche pulverbeschichtet; geeignet für Wandmontage; direkte Lichtverteilung durch LGP-Body (Light-Guiding-Prism); seitlich eingekoppeltes Licht durch Lasergravur nach unten gelenkt; Lichtlenkung mittels hochreflektierenden Reflektormaterials; Indirektlichtanteil mit eigenen Platinen mit asymmetrischer Lichtverteilung; für optimale Deckenaufhellung; absolut homogene Ausleuchtung; energieeffiziente LEDs mit sehr guter Farbwiedergabe



asymmetrical ceiling illumination

Quickinfo

3000K, 4000K
 CRI ≥ 90, 3 SDCM
 up to 125 lm/W
 L90 @ 50 000h
 DALI-2
 microprismatic (UGR ≤ 16)

Type

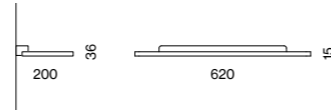

Colours



Light distribution



Order options

COLOUR TEMPERATURE	
3000K	0
4000K	1

CONTROL

DALI-2

MATERIAL COLOUR

<input type="radio"/> pure white RAL 9010	7
<input checked="" type="radio"/> jet black RAL 9005	8

LIGHT OPTIC COVER

microprismatic (UGR ≤ 16)

Options on request

COLOUR RENDERING INDEX

CRI ≥ 80

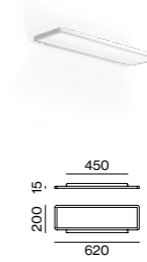

TASK wall

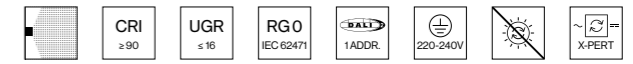

DIRECT / INDIRECT POWER

SYSTEM POWER	COLOUR TEMP.	LUMINOUS FLUX	ORDER CODE
46 W	3000 K	↓ 1850 / ↑ 3530 lm	0 5 9 - 2 0 3 2 :: 3 ▣ Z
	4000 K	↓ 1970 / ↑ 3760 lm	

Technical data

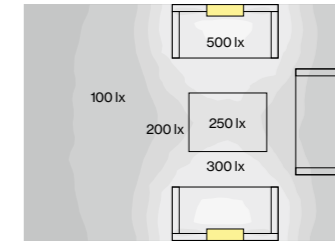

TASK wall
 46 W, 4000 K, direct/indirect power

ROOM VALUES
 Room dimensions 5.4 × 4.0 × 2.8 m
 Reflection factor 0.7 | 0.5 | 0.2
 Maintenance factor 0.8
 Mounting height 2.25 m

CALCULATION SURFACE
 Surface dimensions Floor
 Surface height 0 m



GLARE EVALUATION
 Table Classification X=4H | Y=8H | S=0.25H
 UGR transversal ≤ 19
 UGR axial ≤ 19

Light distribution

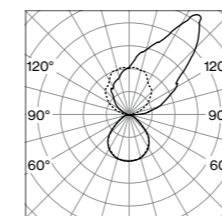

microprismatic
 direct/indirect power

LUMINOUS FLUX value calculated for
 CRI ≥ 90, colour white, cover microprismatic

Lobby
Visualisation



← back



TASK

free standing

EN Free standing luminaire with rectangular luminaire head made of aluminium and rounded edges; ultra low-profile design (only 15 mm); rectangular downpipe; pedestal with recess for table base; surface powder coated; direct/indirect light distribution by LGP body (Light Guiding Prism); side coupled light, directed up and down by laser engraving; optional: indirect component with special PCBs for increased luminous flux; optional: indirect component with special, inclined PCBs for asymmetric radiation characteristic; completely homogeneous illumination; energy-efficient LEDs with very good colour rendering; switch installed in the downpipe; incl. connection cable (3 m) with safety plug

DE Stehleuchte mit rechteckigem Leuchtenkopf aus Aluminium und abgerundeten Kanten; extrem flache Bauform (nur 15 mm); Standrohr rechteckig; Standfuß mit Ausnehmung für Tischfuß; Oberfläche pulverbeschichtet; direkt/indirekte Lichtverteilung durch LGP-Body (Light-Guiding-Prism); seitlich eingekoppeltes Licht durch Lasergravur nach oben und unten gelenkt; optional: Indirektlichtanteil mit eigenen Platinen für erhöhten Lichtstrom; optional: Indirektlichtanteil mit eigenen, schräg gerichteten Platinen für asymmetrische Abstrahlcharakteristik; absolut homogene Ausleuchtung; energieeffiziente LEDs mit sehr guter Farbwiedergabe; Schalter im Standrohr verbaut; inkl. Anschlussleitung (3 m) mit Schutzkontaktstecker

Quickinfo

3000K, 4000K
 CRI ≥ 90, 3 SDCM
 UGR ≤ 19 / 65° ≤ 3000 cd/m²
 up to 129 lm/W
 L90 @ 50 000 h
 touch DIM on pole
 brightness & presence sensor
 microprismatic (UGR ≤ 19)

Type

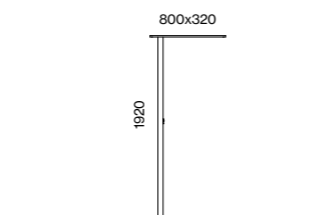

Colours



Light distributions

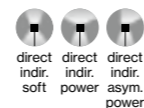

suitable for double workstation



SENSE sensor on request



control by touch DIM on pole

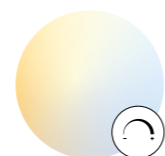

tunable white 2700–6500 K

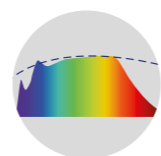

CRI ≥ 98 XPECTRUM

Order options

BASE PLATE	
U-shape	4
T-shape	5

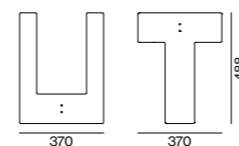

COLOUR TEMPERATURE	
3000K	0
4000K	1

CONTROL	
touch DIM on pole	5
ESSENTIAL sensor (brightness & presence)	7

MATERIAL COLOUR	
○ pure white RAL 9010	7
● white aluminium RAL 9006	6
● jet black RAL 9005	8
● special colours p. 992	X

LIGHT OPTIC COVER	
microprismatic (UGR ≤ 19)	

Options on request

COLOUR TEMPERATURE	
tunable white 2700–6500 K indir.	

COLOUR RENDERING INDEX	
CRI ≥ 80	
CRI ≥ 98 XPECTRUM	

CONTROL	
SENSE sensor (brightness, presence, temperature, sound pressure, humidity, CO ₂)	
cluster network DIM	
dynamic daylight control (BPI)	
Zigbee 3.0	

MOUNTING	
table system	

LUMINOUS FLUX value calculated for CRI ≥ 90, colour white, cover microprismatic

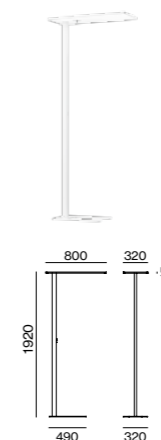

TASK free standing



DIRECT / INDIRECT SOFT		ORDER CODE	
SYSTEM POWER	COLOUR TEMP.	LUMINOUS FLUX	
71W	3000K	↓4100/↑3350 lm	0 5 9 - 2 9 U 3 :: ▢ Z
	4000K	↓4370/↑3560 lm	

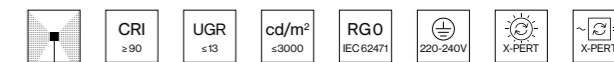

DIRECT / INDIRECT POWER		ORDER CODE	
SYSTEM POWER	COLOUR TEMP.	LUMINOUS FLUX	
80W	3000K	↓2400/↑7330 lm	0 5 9 - 2 9 U 2 :: ▢ Z
	4000K	↓2550/↑7800 lm	

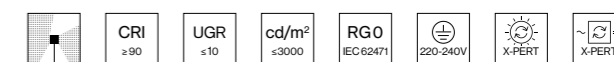

DIRECT / INDIRECT ASYMMETRIC POWER		ORDER CODE	
SYSTEM POWER	COLOUR TEMP.	LUMINOUS FLUX	
97W	3000K	↓1900/↑9300 lm	0 5 9 - 2 9 U 1 :: ▢ Z
	4000K	↓2030/↑9960 lm	

Light distributions

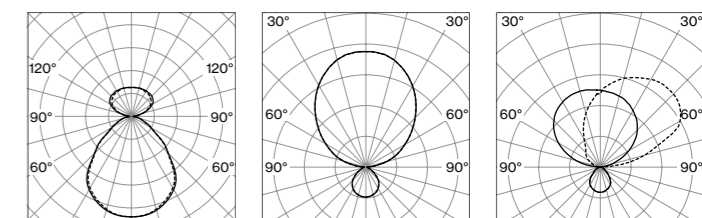

microprismatic direct/indirect soft microprismatic direct/indirect power microprismatic direct/indirect asym. power

Business-Quartier Sparkasse
Salzburg, AT – by OM/ARGE
Neutor, Schabelreiter Architektur



OMV Vienna, AT

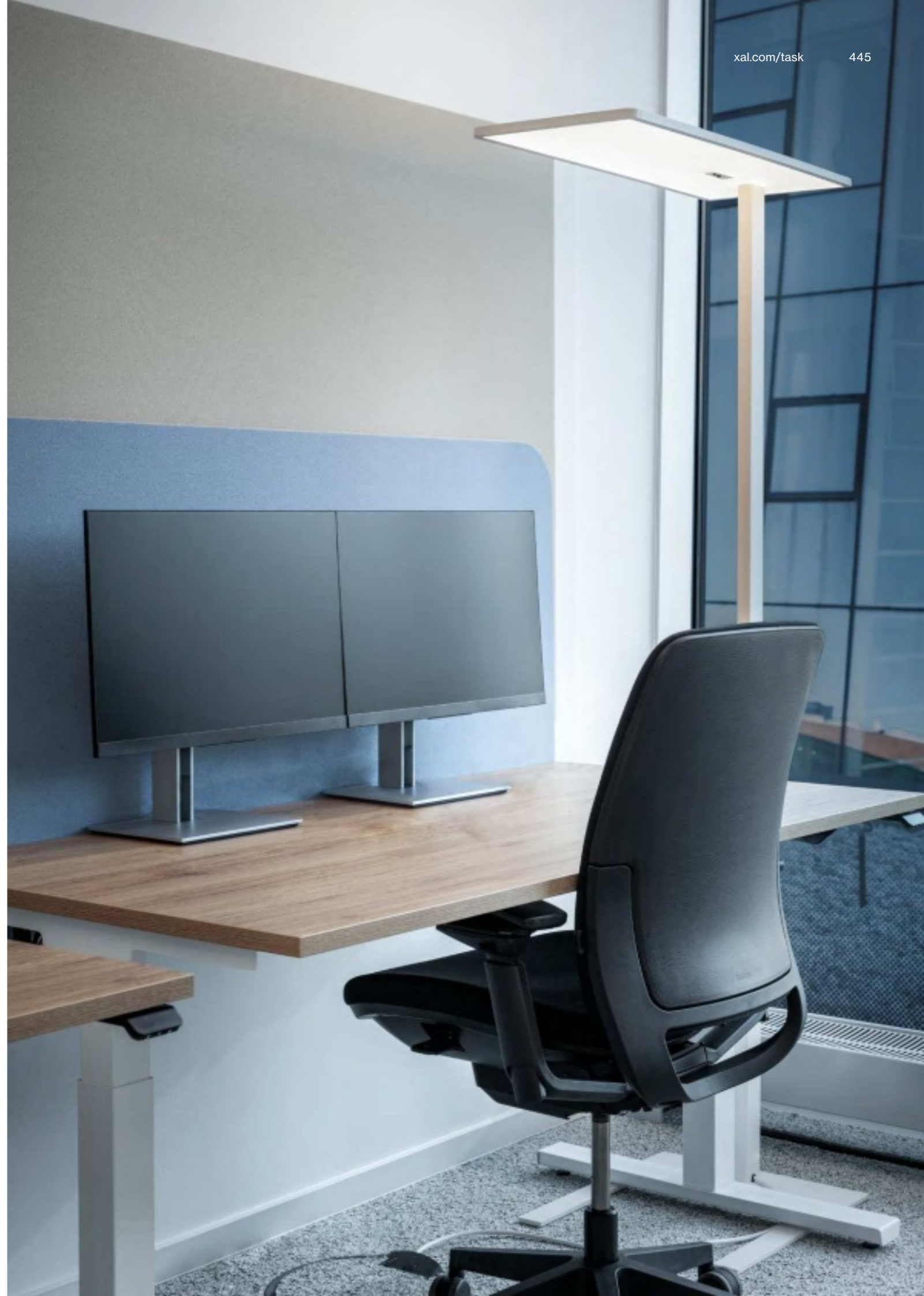

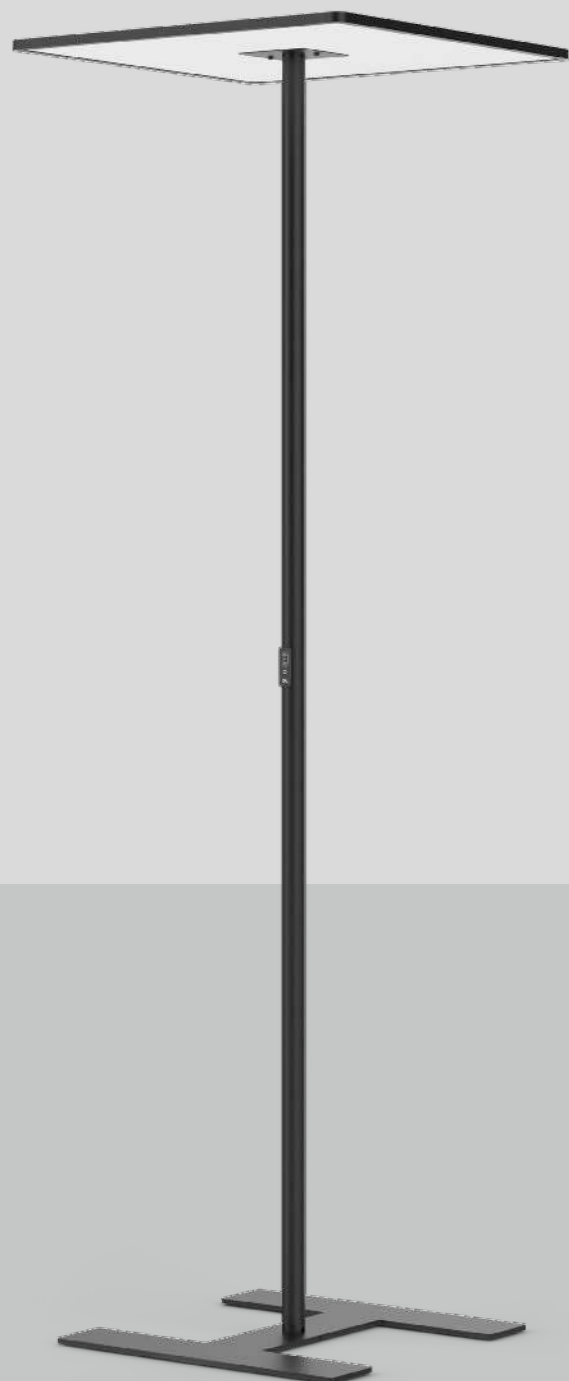
[← back](#)

TASK square

free standing

EN Free standing luminaire with square luminaire head made of aluminium and rounded edges; ultra low-profile design (only 15 mm); steel round downpipe; pedestal with recess for table base; surface powder coated; direct light distribution by LGP body (Light Guiding Prism); side coupled light directed downwards by laser engraving; indirect component with special PCBs for increased luminous flux and maximum ceiling illumination; completely homogeneous illumination; energy-efficient LEDs with very good colour rendering; switch installed in the downpipe; incl. connection cable (3m) with safety plug

DE Stehleuchte mit quadratischem Leuchtenkopf aus Aluminium und abgerundeten Kanten; extrem flache Bauform (nur 15 mm); Stahlrohr rund; Standfuß mit Ausnehmung für Tischfuß; Oberfläche pulverbeschichtet; direkte Lichtverteilung durch LGP-Body (Light-Guiding-Prism); seitlich eingekoppeltes Licht durch Lasergravur nach unten gelenkt; Indirektlichtanteil mit eigenen Platinen für erhöhten Lichtstrom und maximale Deckenaufhellung; absolut homogene Ausleuchtung; energieeffiziente LEDs mit sehr guter Farbwiedergabe; Schalter im Standrohr verbaut; inkl. Anschlussleitung (3m) mit Schutzkontaktstecker

Quickinfo

3000K, 4000K
 CRI ≥ 90, 3 SDCM
 UGR ≤ 19 / 65° ≤ 3000 cd/m²
 up to 143 lm/W
 L90 @ 50 000 h
 touch DIM on pole
 brightness & presence sensor
 microprismatic (UGR ≤ 19)

Type

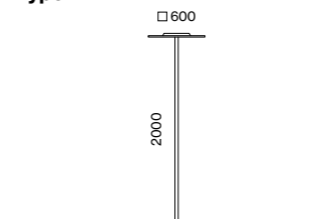

Colours



Light distribution



Order options

COLOUR TEMPERATURE	
3000K	0
4000K	1

CONTROL	
touch DIM on pole	5
ESSENTIAL sensor (brightness & presence)	7

MATERIAL COLOUR	
○ pure white RAL 9010	7
● white aluminium RAL 9006	6
● jet black RAL 9005	8
● special colours p.992	X

LIGHT OPTIC COVER
microprismatic (UGR ≤ 19)

Options on request

COLOUR RENDERING INDEX
CRI ≥ 80
CRI ≥ 98 XPECTRUM

CONTROL
dynamic daylight control



TASK square free standing

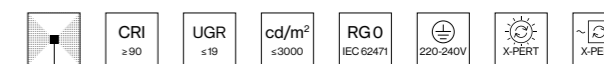

DIRECT / INDIRECT POWER

SYSTEM POWER	COLOUR TEMP.	LUMINOUS FLUX	ORDER CODE
92W	3000K	↓ 2280 / ↑ 10000 lm	0 5 9 - 2 9 3 2 :: ▢ ▢ Z
	4000K	↓ 2420 / ↑ 10700 lm	

Light distribution

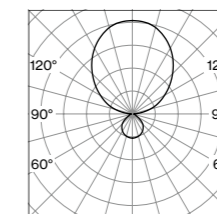

microprismatic
 direct / indirect power

Technical data

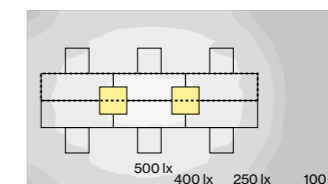

TASK square free standing
 92 W, 4000K, direct / indirect power

ROOM VALUES	
Room dimensions	7.2 × 4 × 2.8 m
Reflection factor	0.7 0.5 0.2
Maintenance factor	0.8

CALCULATION SURFACE	
Surface dimensions	4.8 × 0.6 m
Surface height	0.75 m
Average illuminance (E _m)	> 500 lx



GLARE EVALUATION	
Table Classification X=4H Y=8H S=0.25H	
UGR transversal	≤ 19
UGR axial	≤ 19
65° ≤ 3000 cd/m ²	



suitable for
 fourfold workstation

control by touch
 DIM on pole

CRI ≥ 98
 XPECTRUM

LUMINOUS FLUX value calculated for
 CRI ≥ 90, colour white, cover microprismatic





Fricke Verwaltung Heeslingen, DE –
lighting design by LUV Interior Hamburg



back

Quickinfo

3000K, 4000K
 CRI ≥ 90, 3 SDCM
 up to 92lm/W
 L90 @ 50 000h
 DIM via optical sensor (10–100%)
 presence sensor
 opal

Type

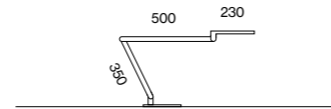

Colours



Light distribution



direct

Order options

COLOUR TEMPERATURE	
3000K	0
4000K	1

MATERIAL COLOUR	
<input type="radio"/> pure white RAL 9010	7
<input checked="" type="radio"/> jet black RAL 9005	8

LIGHT OPTIC COVER

opal

Options on request

COLOUR RENDERING INDEX
 CRI ≥ 80

MOUNTING

table clamp, wall fastening

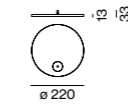
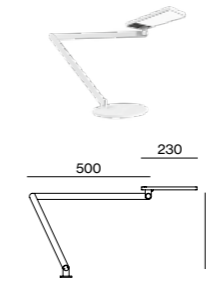

TASK table

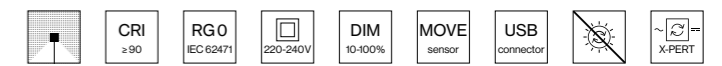

DIRECT

SYSTEM POWER	COLOUR TEMP.	LUMINOUS FLUX	ORDER CODE
11W	3000K	950lm	0 5 9 - 2 8 1 1 1 7 <input checked="" type="checkbox"/> <input type="checkbox"/>
	4000K	1010lm	

Accessories

BASE PLATE

TYPE	Ø-H (mm)	ORDER CODE
base plate	Ø220-13	0 5 9 - 2 8 9 1 1 1 <input checked="" type="checkbox"/>

TABLE CLAMP for hole ø68mm, 10–30mm range

TYPE	Ø-H (mm)	ORDER CODE
table clamp	Ø75-77-88	0 5 9 - 2 8 9 2 1 1 <input checked="" type="checkbox"/>

TASK

table

^{EN} Desk lamp in puristic design with high functionality; lamp head 360° rotatable and +/- 15° tiltable; surface powder coated; direct light distribution by LGP body (Light Guiding Prism); side coupled light directed downwards by laser engraving; completely homogeneous illumination; energy-efficient LEDs with very good colour rendering; continuously adjustable dimming via optical sensor (10-100% analog); integrated USB charging socket for charging of a smart device; version with presence detector

^{DE} Schreibtischleuchte in puristischem Design und hoher Funktionalität; Leuchtenkopf 360° dreh- und +/- 15° schwenkbar; Oberfläche pulverbeschichtet; direkte Lichtverteilung durch LGP-Body (Light-Guiding-Prism); seitlich eingekoppeltes Licht durch Lasergravur nach unten gelenkt; absolut homogene Ausleuchtung; energieeffiziente LEDs mit sehr guter Farbwiedergabe; stufenloses Dimmen via optischem Sensor (10-100% analog); integrierte USB-Ladebuchse zum Aufladen eines Smart Devices; Ausführung mit Präsenzmelder

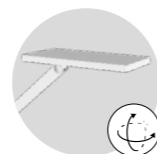

360° rotatable,
±15° tiltable

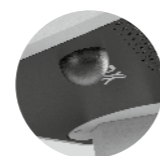

presence
sensor



USB charging
socket

LUMINOUS FLUX value calculated for
 CRI ≥ 90, colour white, cover opal



WKO Vienna, AT –
by Architekturconsult
with lighting design by Hailight
Lichtplanung, Andreas Haidegger





Meeting room
Visualisation

Slim and smart office light



BETO

EN Extremely slim and powerful – BETO combines technical excellence with subtle, minimalist design. The BETO product family is available as free-standing luminaires, or a suspended version. All versions have custom reflectors for the best screen-appropriate working light; as a free-standing luminaire, ideally suited for single or double workstations, and in a matching suspended version for double or quadruple workstations. Circle and square luminaires complete the series. Free-standing and suspended versions have an indirect light component for ceiling illumination. The colour rendering value of up to $\text{CRI} \geq 98$ crafts a pleasant atmosphere. BETO comes in 3000 K or 4000 K light colours, or as a Tunable White option. The luminaire can be fitted with a presence and brightness sensor or a SENSE sensor which measures temperature, air quality, humidity, and noise levels. This allows the lighting to be adapted to the activities in the office while reducing energy costs.

DE Extrem schlank und leistungsstark – BETO vereint technische Exzellenz mit subtilem, minimalistischem Design. Die BETO Produktfamilie ist als Stehleuchte sowie in abgependelter Version verfügbar. In allen Ausführungen verfügt die Leuchte über spezielle Reflektoren für bestes, bildschirmtaugliches Arbeitslicht: Als Stehleuchte ideal geeignet für den Einzel- oder Doppelarbeitsplatz und in dazu passender abgehängter Variante für Doppel- oder Vierfach-Arbeitsplätze. Steh- und abgehängte Versionen verfügen über einen Indirektlichtanteil zur Deckenaufhellung. Der Farbwiedergabewert von bis zu $\text{CRI} \geq 98$ schafft zusätzliche eine angenehme Raumatmosphäre. BETO ist in den Lichtfarben 3000 K, 4000 K oder als Tunable White Option erhältlich. Optional kann die Leuchte mit einem Anwesenheits- und Helligkeitssensor ausgestattet werden sowie einem SENSE Sensor, der zusätzlich Temperatur, Luftqualität, Luftfeuchtigkeit und Geräuschpegel misst. Damit lässt sich die Beleuchtung den Abläufen im Büro anpassen, gleichzeitig werden Energiekosten gesenkt.

Types

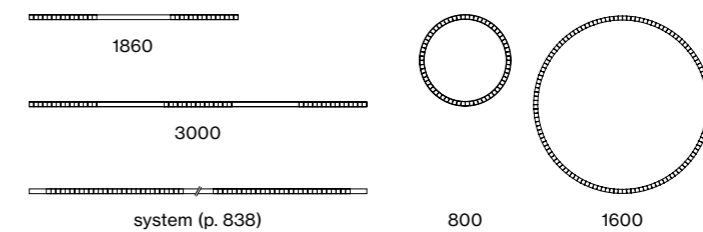

Mountings

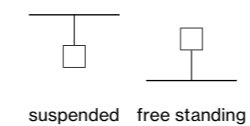

Light distributions

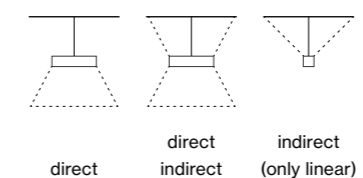

Variety

EN The BETO office luminaire series' elegant appearance combines successful room design with the best workplace lighting. As a free-standing luminaire, as a suspended luminaire, or as a system version – BETO offers a multifunctional lighting solution for a homogeneous appearance.

DE Das elegante Erscheinungsbild der BETO Office Leuchtenserie verbindet ein gelungenes Raumdesign mit bestem Arbeitsplatzlicht. Als Stehleuchte, als abgehängte Leuchte oder als Systemvariante – BETO bietet eine multifunktionale Lichtlösung für ein homogenes Erscheinungsbild.



Work-friendly light

EN As an office luminaire, BETO guarantees illumination that is compliant with workplace standards (up to $UGR \leq 13$). Custom glare-free reflectors and the selected use of blind covers direct the light precisely to the work surface and reduce reflections. The direct/indirect version comes with special lens technology that distributes the indirect light component homogeneously and broadly into the room.

DE Als Office-Leuchte garantiert BETO eine normgerechte Ausleuchtung von Arbeitsplätzen (bis zu $UGR \leq 13$). Speziell entblendete Reflektoren und der gezielte Einsatz von Blind-Covers richten das Licht zielgenau auf die Arbeitsfläche und reduzieren Spiegelungen. Bei der direkt/indirekt Variante, verteilt eine spezielle Linsentechnik, den sehr breit ausstrahlenden Indirektlichtanteil homogen an der Decke für eine angenehme Raumatmosphäre.

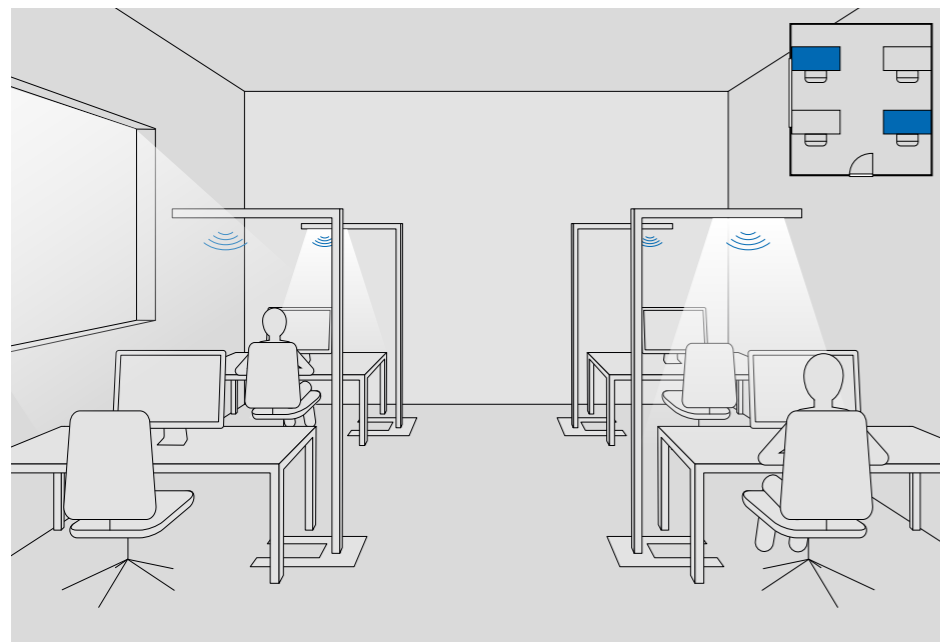

Advanced sensor technology

EN A presence sensor controls the light at the workplace depending on the presence of an individual. In addition, a brightness sensor adjusts the light intensity to the ambient brightness. The SENSE version also measures values such as temperature, air quality, humidity, and noise level. These data provide important insights into the conditions and use of rooms and support energy savings in the long term. The sensor data is transmitted via DALI. The SENSE sensor is IoT ready and enables data transmission via WLAN.

DE Ein Anwesenheitssensor regelt abhängig von der Präsenz einer Person das Licht am Arbeitsplatz. Zusätzlich passt ein Helligkeitssensor die Lichtstärke an die Umgebungshelligkeit an. Zudem misst die SENSE-Variante Werte wie Temperatur, Luftqualität, Luftfeuchtigkeit und Geräuschpegel. Diese Daten liefern nicht nur wichtige Erkenntnisse über die Bedingungen und Nutzung von Räumen, sondern unterstützen langfristig Energieeinsparungen. Die Daten der Sensoren werden über DALI übertragen. Der SENSE Sensor ist IoT ready und ermöglicht die Datenübertragung mittels WLAN.



ESSENTIAL sensor
 ☀ brightness
 👤 presence



SENSE sensor
 IoT ready
 ☀ brightness
 👤 presence
 🌡 temperature
 💧 humidity
 🗣 sound pressure
 🌫 CO₂

XPECTRUM LED

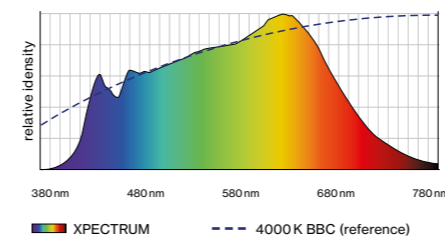

Commercially available LED 4000K

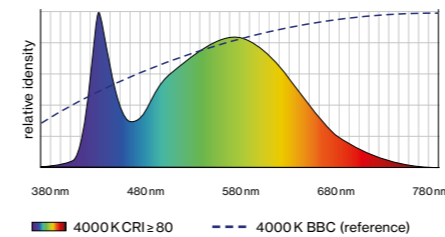

Full-spectrum LED

EN XAL's new XPECTRUM LEDs deliver healthy, biologically effective light. The reduced blue light and increased cyan values reduce the blue light hazard for the eye to daylight-equivalent levels. The resulting non-visual, so-called melanopic light effect, improves concentration and increases sleep quality. The excellent colour rendering of IES TM 30-15 $R_t = 98$ and $R_g = 101$ further helps visual comfort.

DE Die neue XPECTRUM LED von XAL sorgt für gesundes, biologisch wirksames Licht. Der reduzierte Blaulichtanteil sowie die erhöhten Cyan-Werte minimieren die Blaulichtgefahr für das Auge auf ein tageslichtähnliches Niveau. Die daraus resultierende nichtvisuelle, auch melanopische Lichtwirkung genannt, fördert die Konzentration und steigert die Schlafqualität. Die hervorragende Farbwiedergabe von IES TM 30-15 $R_t = 98$ und $R_g = 101$ ermöglicht zudem einen verbesserten Sehkomfort.

← back

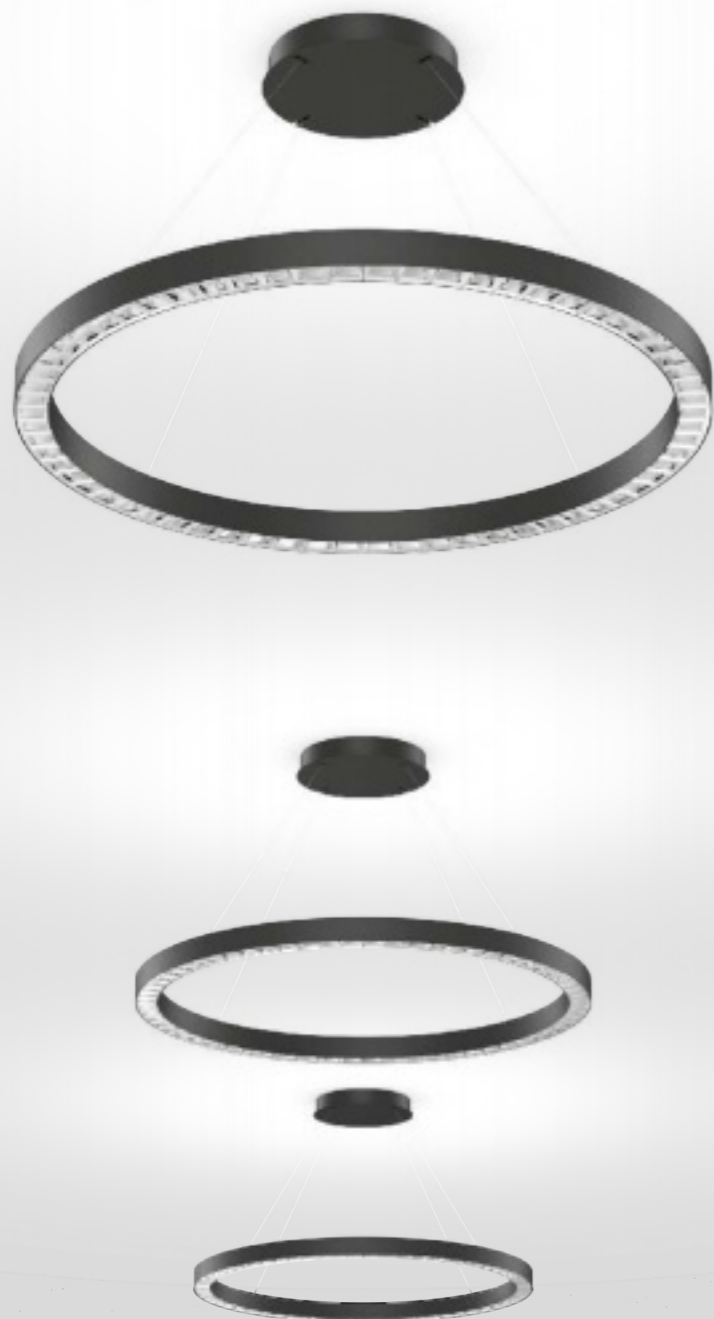

BETO circle

suspended

EN Ring shaped luminaire housing from rolled aluminium extruded profile, seamlessly welded; extremely slim design (only 42 x 42 mm); surface powder coated; pendant fitting with cable suspension; height adjustment without tools; with transparent feeder cable; electronic operating unit installed in the canopy; extruded profile for improved thermal management; high-gloss reflector with faceted design; direct or direct/indirect light distribution; indirect light component with integrated PC boards and high-quality lens system for maximum, homogeneous ceiling illumination; energy-efficient LEDs with very good colour rendering

DE Ringförmiger Leuchtenkörper aus gerolltem Aluminiumstrangpressprofil nahtlos verschweißt; extrem schlanke Bauform (nur 42 x 42 mm); Oberfläche pulverbeschichtet; abgependelt mit Seilabhängung; werkzeuglose Höhenverstellung; inkl. transp. Ein-speiseleitung; elektronisches Betriebsgerät im Baldachin verbaut; Strangpressprofil für verbessertes Thermomanagement; hochglänzender Reflektor mit Facettenoptik; direkte bzw. direkte / indirekte Abstrahlcharakteristik; Indirektlichtanteil mit eigenen Platinen und hochwertiger Linsenoptik für maximale, homogene Deckenaufhellung; energieeffiziente LEDs mit sehr guter Farbwiedergabe

Quickinfo

3000K, 4000K, TW
 CRI ≥ 80, 3 SDCM
 UGR ≤ 19 / 65° ≤ 1500 cd/m²
 up to 145 lm/W
 L90 @ 50 000h
 DALI-2
 reflector (UGR ≤ 19)

Types

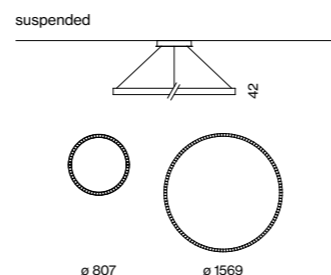

Colours



Light distributions



Order options

COLOUR TEMPERATURE	
3000K	5
4000K	6
tunable white 2700–6500 K*	D
*DALI-2 DT8	

CONTROL

DALI-2

MATERIAL COLOUR

○ pure white RAL 9010	7
● jet black RAL 9005	8

LIGHT OPTIC COVER

reflector (UGR ≤ 19)

Options on request

COLOUR RENDERING INDEX

CRI ≥ 90
 CRI ≥ 98 XPECTRUM

CONTROL

Casambi

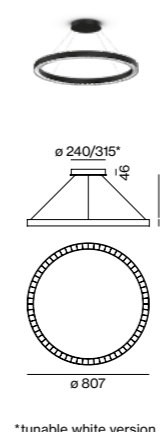

BETO circle 800 suspended



DIRECT			
SYSTEM POWER	COLOUR TEMP.	LUMINOUS FLUX	ORDER CODE
52W	3000K	6720 lm	074-7403::3 R
	4000K	7080 lm	



DIRECT / INDIRECT POWER			
SYSTEM POWER	COLOUR TEMP.	LUMINOUS FLUX	ORDER CODE
97W	3000K	↓ 6690 / ± 6400 lm	074-7443::3 R
	4000K	↓ 7080 / ± 6780 lm	

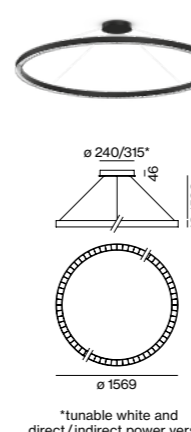

BETO circle 1600 suspended



DIRECT			
SYSTEM POWER	COLOUR TEMP.	LUMINOUS FLUX	ORDER CODE
98W	3000K	13400 lm	074-7404::3 R
	4000K	14200 lm	



DIRECT / INDIRECT POWER			
SYSTEM POWER	COLOUR TEMP.	LUMINOUS FLUX	ORDER CODE
190W	3000K	↓ 13400 / ± 12800 lm	074-7444::3 R
	4000K	↓ 14200 / ± 13600 lm	

tunable white on request

Light distribution

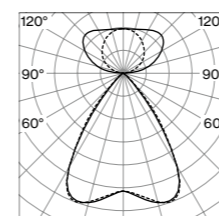

reflector (UGR ≤ 19)
 direct/indirect power

LUMINOUS FLUX value calculated for CRI ≥ 80, colour white, reflector chrome

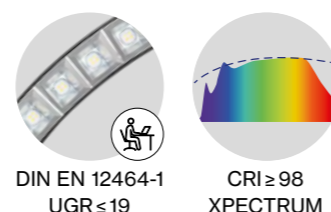

ALLPLAN Österreich GmbH
Graz, AT



Office OSTA
Harelbeke, BE



← back



BETO

suspended

EN Luminaire housing from extruded aluminium profile, angular design; extremely slim design (only 42 x 42 mm); no visible screws; surface powder coated; pendant fitting with cable suspension; with integrated tool-less suspension height adjustment; spring clip attachment to the luminaire; freely positionable; with transparent feeder cable; extruded profile for improved thermal management; high-gloss reflector with faceted design; direct/indirect light distribution; indirect light component with integrated PC boards and high-quality lens system for maximum, homogeneous ceiling illumination, optionally separately controllable; energy-efficient LEDs with very good colour rendering

DE Leuchtenkörper aus Aluminiumstrangpressprofil, kantige Ausführung; extrem schlanke Bauform (nur 42 x 42 mm); keine sichtbaren Schrauben; Oberfläche pulverbeschichtet; abgedandelt mit Seilabhängung; werkzeuglose Höhenverstellung an der Leuchte; Befestigung an der Leuchte mittels Federclips; frei positionierbar; inkl. transp. Einspeiseleitung; Strangpressprofil für verbessertes Thermomanagement; hochglänzender Reflektor mit Facettenoptik; direkt/indirekte Abstrahlcharakteristik; Indirektlichtanteil mit eigenen Platinen und hochwertiger Linsenoptik für maximale, homogene Deckenaufhellung, wahlweise separat steuerbar; energieeffiziente LEDs mit sehr guter Farbwiedergabe

Quickinfo

3000K, 4000K, TW
 CRI ≥ 80, 3 SDCM
 UGR ≤ 16 / 65° ≤ 1500 cd/m²
 up to 142lm/W
 L90 @ 50 000h
 DALI-2, DALI sensor
 reflector (UGR ≤ 16)

Types

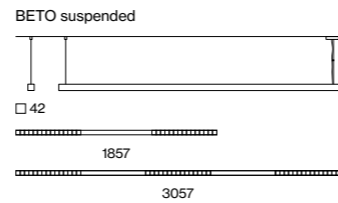

Colours



Light distributions

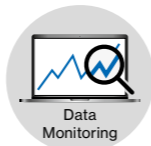

DiiA® standards
 251, 252, 253



DIN EN 12464-1
 UGR ≤ 19

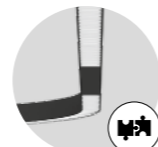

system
 solution (p. 838)

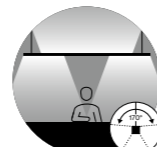

glare-free direct
 and 170° indirect
 illumination

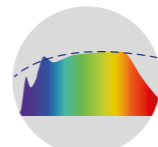

CRI ≥ 98
 XPECTRUM

Order options

COLOUR TEMPERATURE	
3000K	5
4000K	6
tunable white 2700–6500K*	
*DALI-2 DT8	
3000K + TW 2700–6500K*	
4000K + TW 2700–6500K*	
*DALI-2 DT8 (separately controllable)	

CONTROL	
DALI-2	3
DALI-2 D/I separately control.*	4
DALI sensor	7
*not for tunable white 1857 mm; not for indirect power	

MATERIAL COLOUR	
○ pure white RAL 9010	7
● jet black RAL 9005	8

LIGHT OPTIC COVER	
reflector (UGR ≤ 16)	

Options on request

COLOUR RENDERING INDEX	
CRI ≥ 90	
CRI ≥ 98 XPECTRUM	

CONTROL	
Casambi	

TUNABLE WHITE	
direct light static 3000K or 4000K and indirect light tunable 2700–6500K	

Light distribution

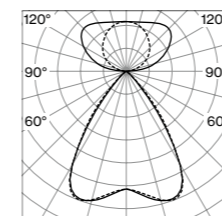

reflector (UGR ≤ 16)
 direct/indirect power

LUMINOUS FLUX value calculated for
 CRI ≥ 80, colour white, reflector chrome

BETO suspended



INDIRECT POWER

SYS. POWER	COLOUR TEMP.	LUM. FLUX	L (mm)	ORDER CODE
63W	3000K	± 7680lm	3457	074-62N9
60W	4000K	± 8120lm		
	2700–6500K	± 7020lm	3457	074-62N9D

DIRECT/INDIRECT POWER

SYS. POWER	COLOUR TEMP.	LUM. FLUX	L (mm)	ORDER CODE
55W	3000K	↓ 3350/± 3580lm	1857	074-6246
	4000K	↓ 3540/± 3790lm		
54W	3000K	↓ 3350lm	1857	074-62D654
(2×DALI)	2700–6500K	± 3120lm		
54W	4000K	↓ 3540lm	1857	074-62D664
(2×DALI)	2700–6500K	± 3120lm		
56W (2×)	2700–6500K	± 7030lm	1857	074-6246D
91W	3000K	↓ 5020/± 7160lm	3057	074-6249
	4000K	↓ 5310/± 7580lm		
90W	3000K	↓ 5020lm	3057	074-62D954
(2×DALI)	2700–6500K	± 6240lm		
90W	4000K	↓ 5310lm	3057	074-62D964
(2×DALI)	2700–6500K	± 6240lm		
93W (2×)	2700–6500K	± 12250lm	3057	074-6249D

Technical data

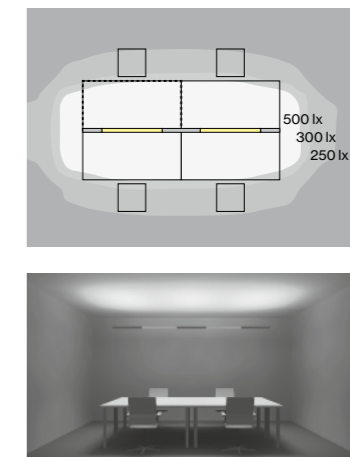

BETO suspended, 91W, 4000K
 direct/indirect power

ROOM VALUES	
Room dimensions	5.4 × 4 × 2.8m
Reflection factor	0.7 0.5 0.2
Maintenance factor	0.8
Mounting height	2.25m

CALCULATION SURFACE	
Surface dimensions	1.6 × 0.8
Surface height	0.75
Average illuminance (E _m)	> 500lx
Uniformity (U ₀)	> 0.6

GLARE EVALUATION	
Table Classification X=4H Y=8H S=0.25H	
UGR transversal	≤ 19
UGR axial	≤ 19
65° < 1500 cd/m²	

Creative Lab Barcelona, ES –
lighting design by MMAS Lighting



Granitlab Coworking St. Martin im Mühlkreis, AT –
by GHT-Plan GmbH with lighting design
by GHT-Plan GmbH, AREA C.I. Design GmbH



← back

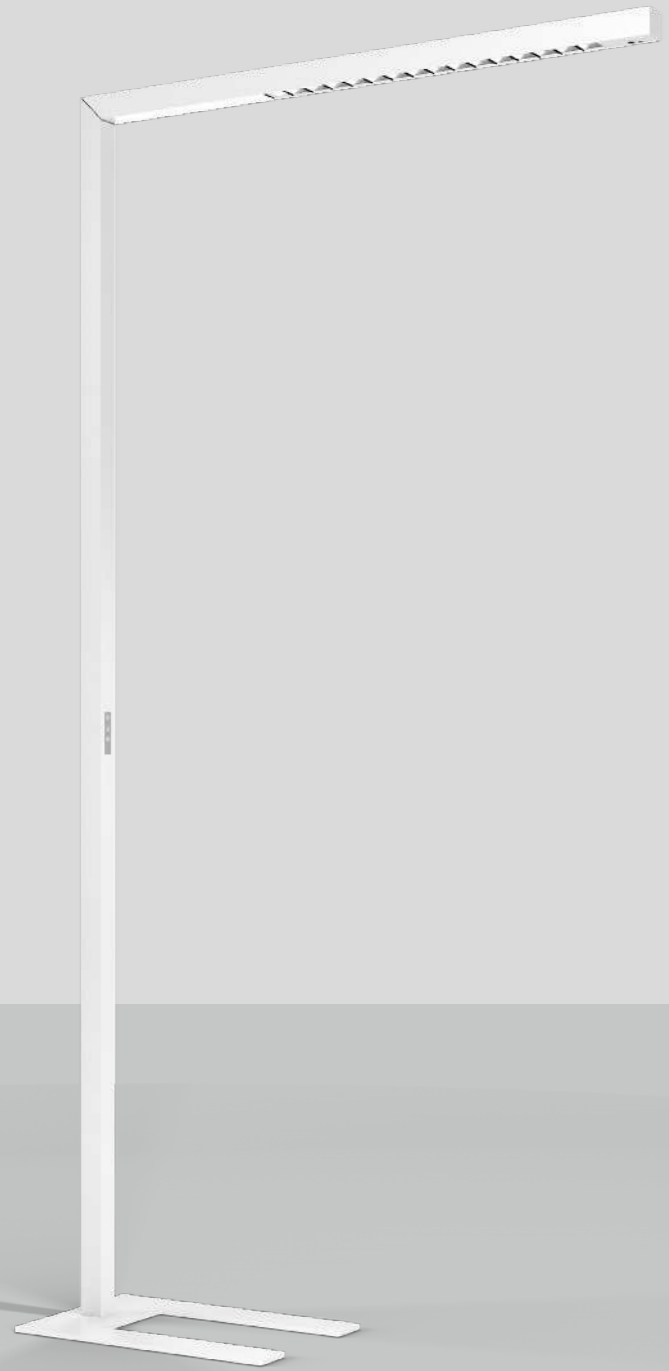

BETO

free standing

EN Free standing luminaire from extruded aluminium profile in angular design; extremely slim design (only 42 x 42 mm); rectangular downpipe; pedestal with recess for table base; surface powder coated; direct/indirect light distribution; direct light component with high-gloss reflector + faceted design and asymmetric radiation characteristic; indirect light component with integrated PC boards and high-quality lens system for maximum, homogeneous ceiling illumination; energy-efficient LEDs with very good colour rendering; switch installed in the downpipe; presence sensor detection range ø4.5 m on the floor (variant brightness & presence sensor); incl. connection cable (3m) with safety plug

DE Stehleuchte aus Aluminiumstrangpressprofil in kantiger Ausführung; extrem schlanke Bauform (nur 42 x 42 mm); Standrohr quadratisch; Standfuß mit Ausnehmung für Tischfuß; Oberfläche pulverbeschichtet; direkt/indirekte Abstrahlcharakteristik; Direktlichtanteil mit hochglänzendem Reflektor + Facettenoptik und asymmetrischer Abstrahlcharakteristik; Indirektlichtanteil mit eigenen Platinen und hochwertiger Linsenoptik für maximale, homogene Deckenaufhellung; energieeffiziente LEDs mit sehr guter Farbwiedergabe; Schalter im Standrohr verbaut; Anwesenheitssensor-Erfassungsbereich ø4,5 m am Fußboden (Variante brightness & presence sensor); inkl. Anschlussleitung (3m) mit Schutzkontaktstecker

Quickinfo

3000K, 4000K
 CRI ≥ 80, 3 SDCM
 up to 127lm/W
 L90 @ 50 000h
 touch DIM
 brightness & presence sensor
 reflector (UGR ≤ 13)

Type

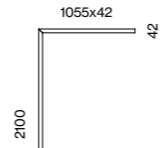

Colours



Light distributions



Order options

BASE PLATE	
U-shape	4
T-shape	5

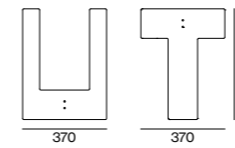

COLOUR TEMPERATURE	
3000K	5
4000K	6

CONTROL	
touch DIM on pole	1
ESSENTIAL sensor (brightness & presence)	7

MATERIAL COLOUR	
○ pure white RAL 9010	7
● jet black RAL 9005	8
● special colours p.992	X

LIGHT OPTIC COVER	
reflector (UGR ≤ 13)	

Options on request

COLOUR RENDERING INDEX	
CRI ≥ 90	
CRI ≥ 98 XPECTRUM	

COLOUR TEMPERATURE	
tunable white 2700–6500K	
DALI-2 DT8	

CONTROL	
SENSE sensor (brightness, presence, temperature, sound pressure, humidity, CO ₂)	
cluster network DIM	
dynamic daylight control (BPI)	
Zigbee 3.0	



lighting control by touch DIM on pole

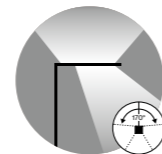

asymmetric illumination



SENSE sensor on request

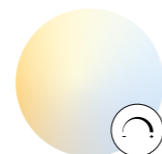

tunable white 2700–6500K

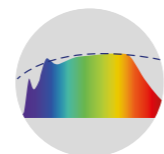

CRI ≥ 98 XPECTRUM

Light distributions

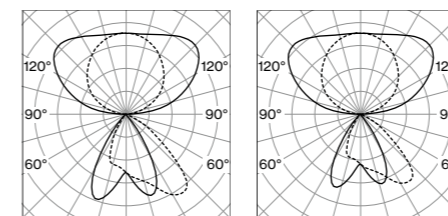

reflector (UGR ≤ 13) direct/indirect
 reflector (UGR ≤ 13) direct/indirect power

LUMINOUS FLUX value calculated for CRI ≥ 80, colour white, reflector chrome

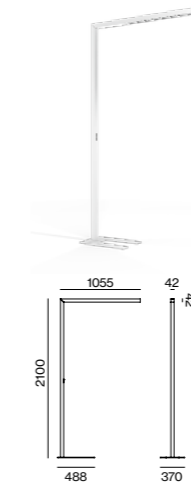

BETO free standing



DIRECT/INDIRECT SOFT

SYSTEM POWER	COLOUR TEMP.	LUMINOUS FLUX	ORDER CODE
59 W	3000 K	↓ 1850 / ± 5240 lm	0 7 4 - 6 9 4 U :: ⇄ R
	4000 K	↓ 1950 / ± 5550 lm	



DIRECT/INDIRECT POWER

SYSTEM POWER	COLOUR TEMP.	LUMINOUS FLUX	ORDER CODE
76 W	3000 K	↓ 2090 / ± 6920 lm	0 7 4 - 6 9 5 U :: ⇄ R
	4000 K	↓ 2210 / ± 7330 lm	

Technical data

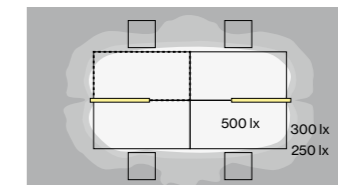

BETO free standing, 76W, 4000K
 direct/indirect power

ROOM VALUES	
Room dimensions	5.4 × 4 × 2.8m
Reflection factor	0.7 0.5 0.2
Maintenance factor	0.8

CALCULATION SURFACE	
Surface dimensions	1.6 × 0.8
Surface height	0.75
Average illuminance (E _m)	> 500 lx
Uniformity (U ₀)	> 0.6



GLARE EVALUATION	
Table Classification X=4H Y=8H S=0.25H	
UGR transversal	≤ 19
UGR axial	≤ 19



Tribünen der Trabrennbahn
Vienna, AT





Tribünen der Trabrennbahn
Vienna, AT

ALLPAN Österreich GmbH
Graz, AT



The art of round efficiency



SETA

EN The SETA luminaire was developed specifically for office environments. Its sleek design and powerful illumination are impressive. Special reflectors provide the ideal screen work light. The integrated indirect light component creates homogeneous ceiling illumination; the colour rendering value of up to $\text{CRI} \geq 98$ ensures a pleasant room and work atmosphere. SETA can be used as a pendant luminaire for double and quadruple workstations, and can optionally be equipped with a presence and brightness sensor. SETA is the optimum for minimalist design, excellent technology, and low energy costs. The luminaire comes in light colours 3000K, 4000K, or Tunable White.

DE Die SETA Leuchte wurde speziell für die Office-Umgebung entwickelt und besticht mit schlichtem Design und leistungsstarker Beleuchtung. Spezielle Reflektoren sorgen für das ideale Bildschirm-Arbeitslicht. Der integrierte Indirektlichtanteil bewirkt eine homogene Deckenaufhellung, der Farbwiedergabewert von bis zu $\text{CRI} \geq 98$ schafft eine angenehme Raum- und Arbeitsatmosphäre. SETA kann als Pendelleuchte für Doppel- und Vierfach-Arbeitsplätze eingesetzt und wahlweise mit einem Anwesenheits- und Helligkeitssensor ausgestattet werden. Die SETA ist das Optimum für minimalistisches Design, exzellente Technik und niedrige Energiekosten. Die Leuchte ist in den Lichtfarben 3000K, 4000K oder als Tunable White Option erhältlich.

Types

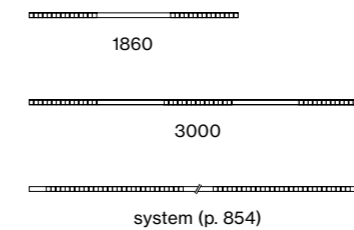

Mounting

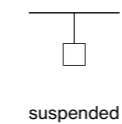

Light distributions

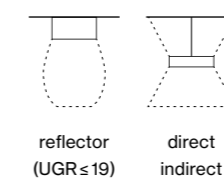

← back



SETA

suspended

EN Luminaire housing from extruded aluminium profile, round design; extremely slim design (only $\varnothing 61$ mm); no visible screws; surface powder coated; pendant fitting with cable suspension; with integrated tool-less suspension height adjustment; spring clip attachment to the luminaire; freely positionable; with transparent feeder cable; extruded profile for improved thermal management; high-gloss reflector with faceted design; direct/indirect light distribution; indirect light component with integrated PC boards and high-quality lens system for maximum, homogeneous ceiling illumination, optionally separately controllable; energy-efficient LEDs with very good colour rendering

DE Leuchtenkörper aus Aluminiumstrangpressprofil, runde Ausführung; extrem schlanke Bauform (nur $\varnothing 61$ mm); keine sichtbaren Schrauben; Oberfläche pulverbeschichtet; abgependelt mit Seilabhängung; werkzeuglose Höhenverstellung an der Leuchte; Befestigung an der Leuchte mittels Federclips; frei positionierbar; inkl. transp. Einspeiseleitung; Strangpressprofil für verbessertes Thermomanagement; hochglänzender Reflektor mit Facettenoptik; direkt/indirekte Abstrahlcharakteristik; Indirektlichtanteil mit eigenen Platinen und hochwertiger Linsenoptik für maximale, homogene Deckenaufhellung, wahlweise separat steuerbar; energieeffiziente LEDs mit sehr guter Farbwiedergabe

Quickinfo

3000K, 4000K, TW
 CRI ≥ 80 , 3 SDCM
 UGR ≤ 16 / $65^\circ \leq 1500$ cd/m²
 L 1860 up to $\downarrow 3540 / \uparrow 3790$ lm
 L 3000 up to $\downarrow 5310 / \uparrow 7580$ lm up to 142 lm/W
 L90 @ 50 000h
 DALI-2, DALI sensor reflector (UGR ≤ 16)

Types

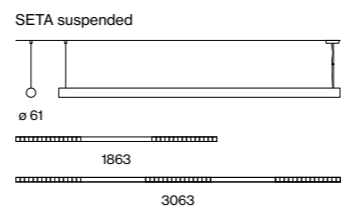

Colours



Light distribution



DiiA® standards
 251, 252, 253



special end cap & reflector design



DIN EN 12464-1
 UGR ≤ 19



system solution (p.854)

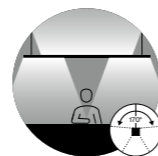

glare-free direct and 170° indirect illumination



tunable white
 2700–6500 K

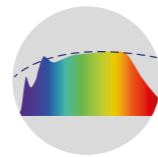

CRI ≥ 98
 XPECTRUM

Order options

COLOUR TEMPERATURE ☐☐
 3000 K 5
 4000 K 6
 tunable white 2700–6500 K*

*DALI-2 DT8

3000 K + TW 2700–6500 K*
 4000 K + TW 2700–6500 K*

*DALI-2 DT8 (separately controllable)

CONTROL

DALI-2 3
 DALI-2 D/I separately control.* 4
 DALI sensor 7

*not for tunable white 1857 mm

MATERIAL COLOUR

○ pure white RAL 9010 7
 ● jet black RAL 9005 8

LIGHT OPTIC COVER

reflector (UGR ≤ 16)

Options on request

COLOUR RENDERING INDEX

CRI ≥ 90
 CRI ≥ 98 XPECTRUM

TUNABLE WHITE

direct light static 3000 K
 or 4000 K and indirect light
 tunable 2700–6500 K

MATERIAL COLOUR

grey

Light distribution

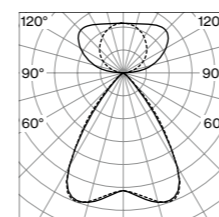

reflector (UGR ≤ 16)
 direct/indirect power

LUMINOUS FLUX value calculated for
 CRI ≥ 80 , colour white, reflector chrome

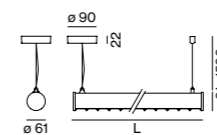
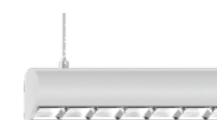

SETA suspended

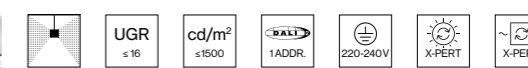

DIRECT/INDIRECT POWER

SYS. POWER	COLOUR TEMP.	LUM. FLUX	L (mm)	ORDER CODE
55 W	3000 K	$\downarrow 3350 / \uparrow 3580$ lm	1863	074-5246☐☐R
	4000 K	$\downarrow 3540 / \uparrow 3790$ lm		
54 W (2×DALI)	3000 K	$\downarrow 3350$ lm	1863	074-52D654☐R
	4000 K	$\downarrow 3540$ lm		
54 W (2×DALI)	2700–6500 K	$\uparrow 3120$ lm	1863	074-52D664☐R
	2700–6500 K	$\uparrow 3120$ lm		
56 W (2×)	2700–6500 K	$\uparrow 7030$ lm	1863	074-5246D☐R
91 W	3000 K	$\downarrow 5020 / \uparrow 7160$ lm	3063	074-5249☐☐R
	4000 K	$\downarrow 5310 / \uparrow 7580$ lm		
90 W (2×DALI)	3000 K	$\downarrow 5020$ lm	3063	074-52D954☐R
	2700–6500 K	$\uparrow 6240$ lm		
90 W (2×DALI)	4000 K	$\downarrow 5310$ lm	3063	074-52D964☐R
	2700–6500 K	$\uparrow 6240$ lm		
93 W (2×)	2700–6500 K	$\uparrow 12250$ lm	3063	074-5249D☐R

Technical data

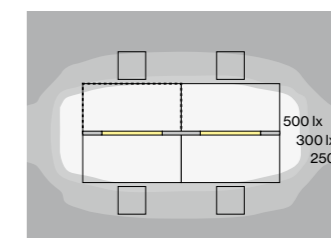

SETA suspended, 91W, 4000K
 direct/indirect power

ROOM VALUES
 Room dimensions 5.4 × 4 × 2.8 m
 Reflection factor 0.7 | 0.5 | 0.2
 Maintenance factor 0.8
 Mounting height 2.25 m

CALCULATION SURFACE
 Surface dimensions 1.6 × 0.8
 Surface height 0.75
 Average illuminance (E_m) > 500 lx
 Uniformity (U₀) > 0.6



GLARE EVALUATION
 Table Classification X=4H | Y=8H | S=0.25H
 UGR transversal ≤ 19
 UGR axial ≤ 19
 65° < 1500 cd/m²

Office
Visualisation



Quality along the line



LENO

EN The extremely flat LENO profile luminaire is surprisingly versatile. It is available as a recessed, semi-recessed or surface-mounted version for wall or ceiling mounting, in a suspended version. LENO and its microprismatic cover create ideal work light. The version with an opal cover is best suited for homogeneous room lighting. The variant with asymmetrical beam distribution illuminates walls homogeneously. LENO Jut-Out adds further ceiling illumination by employing discreet lateral radiation. By simply fixing the insets magnetically, assembly is quick and flexible.

DE Die extrem flache Profilleuchte LENO überrascht durch ihre Vielseitigkeit. Sie ist als Einbau-, Halbeinbau- oder Anbauvariante für die Wand- bzw. Deckenmontage und in abgehängter Version erhältlich. Mit mikroprismatischer Abdeckung schafft LENO bestes Arbeitslicht. Die Variante mit Opal-Cover eignet sich für homogene Raumausleuchtung. In der Variante mit asymmetrischer Abstrahlung werden Wände homogen beleuchtet, während LENO Jut-Out durch dezente seitliche Abstrahlung eine zusätzliche Deckenaufhellung erzeugt. Indem die Insets einfach magnetisch fixiert werden, erfolgt die Montage schnell und flexibel.

Type



90

Mountings

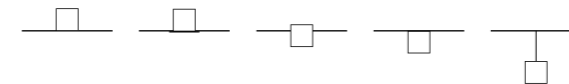
trimless
recessedtrim
recessedsemi-
recessed

surface

suspended

Light distributions

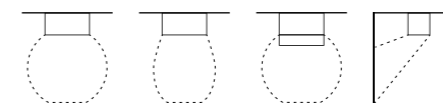

opal

microprismatic
(UGR ≤ 19)

jut-out

wallwasher

← back



LENO

recessed with trim/ trimless

EN Low profile recessed channel; suitable for trimless installation in 12.5mm plasterboard ceilings, or with trim; wall or ceiling mounting; powder coated; special edge design with grooves for better adhesion of filler (trimless); easy mounting without need to cut the substructure; fall-safe light inset made of extruded aluminium profile, can be inserted in the canal without tools by magnetic holders; side coupled light, directed downwards by LGP body (Light Guiding Prism) and highly efficient reflector; homogeneously illuminated, satinised (flush or jut-out) or microprismatic PMMA cover; optional asym. light distribution; energy-eff. LEDs – very good colour rendering; external converter for ceiling insertion

DE Extrem flacher Einbaukanal; geeignet für den randlosen Einbau in 12,5mm Gipskartondecken, oder mit umlaufendem Rand; Wand- oder Deckenmontage; pulverbeschichtet; spezielle Randausbildung mit Rillen für bessere Haftung der Spachtelmasse (trimless); einfache Montage ohne Schneiden der Unterkonstruktion; absturzesicherer Lichteinsatz aus stranggepresstem Aluminiumprofil werkzeuglos mittels Magnethalter in Kanal einsetzbar; seitlich eingekoppeltes Licht durch LGP-Body (Light-Guiding-Prism) und hocheffizientem Reflektor nach unten gelenkt; homogen ausgeleuchtete, satinierte (bündig oder herausragend) oder mikroprismatische Abdeckung aus PMMA; optional asym. Lichtverteilung; energieeff. LEDs – sehr gute Farbwiedergabe; externer Konverter für Deckeneinwurf

Quickinfo

3000K, 4000K
 CRI ≥ 80, 3 SDCM
 up to 137lm/W
 L90 @ 50 000h
 DALI-2
 opal, microprismatic (UGR ≤ 19),
 jut-out, asymmetric wallwasher

Types

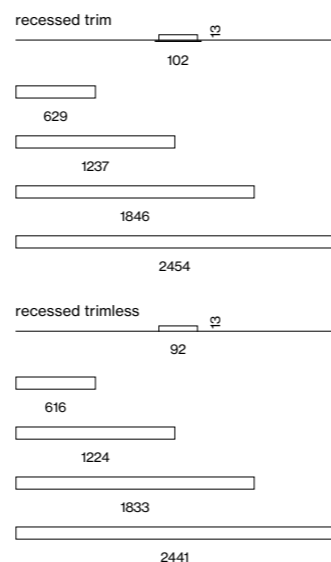

Colour



Light distributions

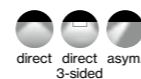

DiiA® standards
 251, 252, 253



system
 solution (p.862)

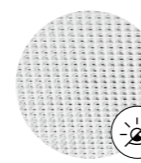

microprismatic
 UGR ≤ 19

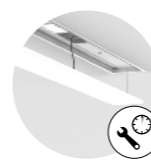

quick
 installation

Order options

COLOUR TEMPERATURE	
3000K	5
4000K	6

CONTROL
 DALI-2

MATERIAL COLOUR
 traffic white RAL 9016

LIGHT OPTIC COVER	
opal high performance	H
microprismatic (UGR ≤ 19)	G
jut-out	J
asymmetric	

Options on request

COLOUR RENDERING INDEX
 CRI ≥ 90

Light distribution

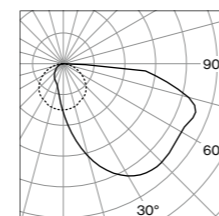

asymmetric

LUMINOUS FLUX value calculated for CRI ≥ 80, colour white, cover opal microprismatic -5%, jut-out -4%

LENO trim



LUMINAIRE

SYS. POWER	COLOUR TEMP.	LUM. FLUX	L (mm)	ORDER CODE
10.8 W	3000K	1230lm	629	05 1-8 4 1 2 :: 3 7 □
19.1 W	4000K	1300lm		
19.1 W	3000K	2450lm	1237	05 1-8 4 1 4 :: 3 7 □
	4000K	2600lm		
28.6 W	3000K	3680lm	1846	05 1-8 4 1 6 :: 3 7 □
	4000K	3890lm		
38 W	3000K	4900lm	2454	05 1-8 4 1 8 :: 3 7 □
	4000K	5190lm		
15.6 W	3000K	1570lm	616	05 1-8 4 1 2 :: 3 7 A
asym.	4000K	1660lm		
31 W	3000K	3140lm	1237	05 1-8 4 1 4 :: 3 7 A
asym.	4000K	3330lm		
47 W	3000K	4710lm	1846	05 1-8 4 1 6 :: 3 7 A
asym.	4000K	4990lm		
62 W	3000K	6280lm	2454	05 1-8 4 1 8 :: 3 7 A
asym.	4000K	6650lm		

LENO trimless



LUMINAIRE

SYS. POWER	COLOUR TEMP.	LUM. FLUX	L (mm)	ORDER CODE
10.8 W	3000K	1230lm	616	05 1-8 3 1 2 :: 3 7 □
	4000K	1300lm		
19.1 W	3000K	2450lm	1224	05 1-8 3 1 4 :: 3 7 □
	4000K	2600lm		
28.6 W	3000K	3680lm	1833	05 1-8 3 1 6 :: 3 7 □
	4000K	3890lm		
38 W	3000K	4900lm	2441	05 1-8 3 1 8 :: 3 7 □
	4000K	5190lm		
15.6 W	3000K	1570lm	616	05 1-8 3 1 2 :: 3 7 A
asym.	4000K	1660lm		
31 W	3000K	3140lm	1224	05 1-8 3 1 4 :: 3 7 A
asym.	4000K	3330lm		
47 W	3000K	4710lm	1833	05 1-8 3 1 6 :: 3 7 A
asym.	4000K	4990lm		
62 W	3000K	6280lm	2441	05 1-8 3 1 8 :: 3 7 A
asym.	4000K	6650lm		

Accessories

DISMOUNTING TOOL



TYPE	ORDER CODE
vacuum cup	086-30000

Technical data

see page 497

Vaucluse House Sydney, AU –
by EST Lighting



← back



LENO

semi-recessed

EN Low profile recessed mounted luminaire, 15 mm visible height; suitable for wall or ceiling mounting; suitable for installation in primed or exposed concrete, in plasterboard constructions and in plastered walls or ceilings; surface powder coated; fall-safe light inset made of extruded aluminium profile, can be inserted in the canal without tools by magnetic holders; side coupled light, directed downwards by LGP body (Light Guiding Prism) and highly efficient reflector; homogeneously illuminated, satinised (flush or jut-out) or microprismatic PMMA cover; energy-efficient LEDs with very good colour rendering

DE Extrem flache Einbauleuchte mit 15 mm sichtbarer Höhe; geeignet für die Wand- oder Deckenmontage; geeignet für den Einbau in gespachtelten Beton oder Sichtbeton, in Gipskartonkonstruktionen und in verputzten Wänden oder Decken; Oberfläche pulverbeschichtet; absturzesicherer Lichteinsatz aus stranggepresstem Aluminiumprofil werkzeuglos mittels Magnethalter in Kanal einsetzbar; seitlich eingekoppeltes Licht durch LGP-Body (Light-Guiding-Prism) und hocheffizientem Reflektor nach unten gelenkt; homogen ausgeleuchtete, satinierte (bündig oder herausragend) oder mikroprismatische Abdeckung aus PMMA; energieeffiziente LEDs mit sehr guter Farbwiedergabe

Quickinfo

3000K, 4000K
 CRI ≥ 80, 3 SDCM
 up to 137lm/W
 L90 @ 50 000h
 DALI-2
 opal, microprismatic (UGR ≤ 19),
 jut-out

Types

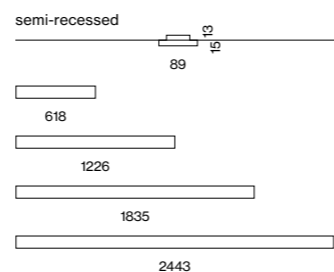

Colours



Light distributions



Order options

COLOUR TEMPERATURE	
3000K	5
4000K	6

CONTROL
 DALI-2

MATERIAL COLOUR	
○ traffic white RAL 9016	7
● jet black RAL 9005	8

LIGHT OPTIC COVER	
opal high performance	H
microprismatic (UGR ≤ 19)	G
jut-out	J

Options on request

COLOUR RENDERING INDEX
 CRI ≥ 90

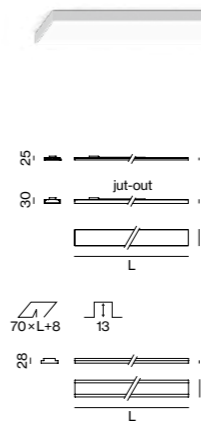

LENO semi-recessed



LUMINAIRE

SYS. POWER	COLOUR TEMP.	LUM. FLUX	L (mm)	ORDER CODE
10.8 W	3000K	1230lm	618	05 1-85 12 :: 3 ▣ □
19.1 W	4000K	1300lm	1226	05 1-85 14 :: 3 ▣ □
28.6 W	3000K	2450lm	1835	05 1-85 16 :: 3 ▣ □
38 W	4000K	2600lm	2443	05 1-85 18 :: 3 ▣ □
	3000K	3680lm		
	4000K	3890lm		
	3000K	4900lm		
	4000K	5190lm		

Accessories



DISMOUNTING TOOL

TYPE	ORDER CODE
vacuum cup	086-30000

Technical data

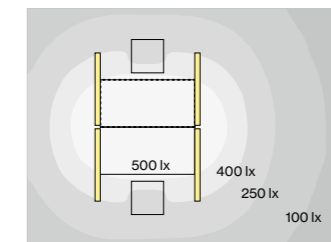

LENO semi-recessed, 19.1W, 4000K

ROOM VALUES	
Room dimensions	5.4 × 4 × 2.8 m
Reflection factor	0.7 0.5 0.2
Maintenance factor	0.8

CALCULATION SURFACE	
Surface dimensions	1.6 × 0.8
Surface height	0.75
Average illuminance (E _m)	> 500 lx
Uniformity (U ₀)	> 0.6

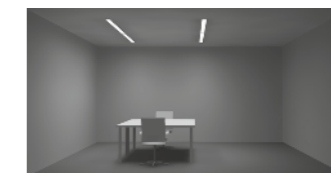

GLARE EVALUATION	
Table Classification X=4H Y=8H S=0.25H	
UGR transversal	≤ 19
UGR axial	≤ 19

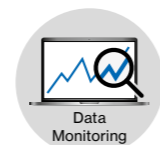

DiiA® standards
 251, 252, 253



system
 solution (p.870)

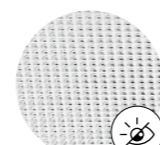

microprismatic
 UGR ≤ 19



quick
 installation

LUMINOUS FLUX value calculated for
 CRI ≥ 80, colour white, cover opal
 microprismatic -5%, jut-out -4%

Maunulan työväenopisto
Helsinki, FI –
by KS2 Architects



back



LENO

surface

EN Low profile surface mounted luminaire, 28 mm total height; suitable for wall or ceiling mounting; surface powder coated; fall-safe light inset made of extruded aluminium profile, can be inserted in the canal without tools by magnetic holders; side coupled light, directed downwards by LGP body (Light Guiding Prism) and highly efficient reflector; homogeneously illuminated, satinised (flush or jut-out) or microprismatic PMMA cover; energy-efficient LEDs with very good colour rendering

DE Extrem flache Anbauleuchte mit 28 mm Gesamthöhe; geeignet für die Wand- oder Deckenmontage; Oberfläche pulverbeschichtet; absturzesicherer Lichteinsatz aus stranggepresstem Aluminiumprofil werkzeuglos mittels Magnethalter in Kanal einsetzbar; seitlich eingekoppeltes Licht durch LGP-Body (Light-Guiding-Prism) und hocheffizientem Reflektor nach unten gelenkt; homogen ausgeleuchtete, satinierte (bündig oder herausragend) oder mikroprismatische Abdeckung aus PMMA; energieeffiziente LEDs mit sehr guter Farbwiedergabe

Quickinfo

3000K, 4000K
CRI ≥ 80, 3 SDCM
up to 137lm/W
L90 @ 50 000h
DALI-2
opal, microprismatic (UGR ≤ 19),
jut-out

Types

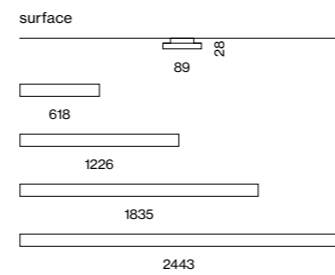

Colours



Light distributions



Order options

COLOUR TEMPERATURE	
3000K	5
4000K	6

CONTROL

DALI-2

MATERIAL COLOUR

<input type="radio"/> traffic white RAL 9016	7
<input checked="" type="radio"/> jet black RAL 9005	8

LIGHT OPTIC COVER

opal high performance	H
microprismatic (UGR ≤ 19)	G
jut-out	J

Options on request

COLOUR RENDERING INDEX

CRI ≥ 90

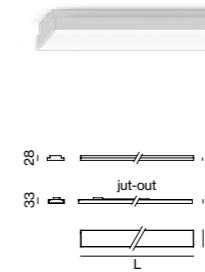

LENO surface



LUMINAIRE

SYS. POWER	COLOUR TEMP.	LUM. FLUX	L (mm)	ORDER CODE
10.8 W	3000K	1230 lm	618	05 1-9 1 1 2 :: 3 ▣ □
19.1 W	4000K	1300 lm	1226	05 1-9 1 1 4 :: 3 ▣ □
28.6 W	3000K	2450 lm	1835	05 1-9 1 1 6 :: 3 ▣ □
38 W	4000K	2600 lm	2443	05 1-9 1 1 8 :: 3 ▣ □
	3000K	3680 lm		
	4000K	3890 lm		
	3000K	4900 lm		
	4000K	5190 lm		

Technical data

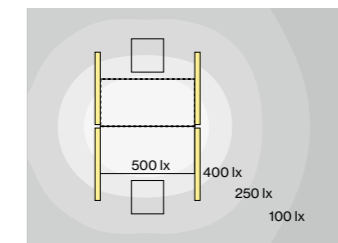

LENO surface, microprismatic, 19.1W, 4000K

ROOM VALUES

Room dimensions	5.4 × 4 × 2.8 m
Reflection factor	0.7 0.5 0.2
Maintenance factor	0.8

CALCULATION SURFACE

Surface dimensions	1.6 × 0.8
Surface height	0.75
Average illuminance (E _m)	> 500 lx
Uniformity (U ₀)	> 0.6

GLARE EVALUATION

Table Classification X=4H Y=8H S=0.25H	
UGR transversal	≤ 19
UGR axial	≤ 19

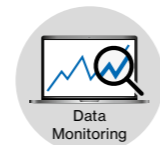
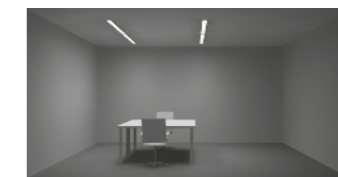

DiiA® standards
251, 252, 253



system
solution (p.874)

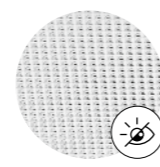

microprismatic
UGR ≤ 19

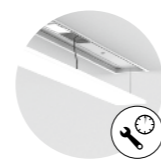

quick
installation

LUMINOUS FLUX value calculated for
CRI ≥ 80, colour white, cover opal
microprismatic -5%, jut-out -4%

Private Residence
Hausmannstätten, AT –
by DI Thomas Schwed



← back



LENO

suspended

EN Low profile suspended luminaire, 28 mm total height; pendant fitting with cable suspension; with integrated tool-less suspension height adjustment; incl. transparent feed; surface powder coated; fall-safe light inset made of extruded aluminium profile, can be inserted in the canal without tools by magnetic holders; side coupled light, directed downwards by LGP body (Light Guiding Prism) and highly efficient reflector; homogeneously illuminated, satinised (flush or jut-out) or microprismatic PMMA cover; energy-efficient LEDs with very good colour rendering

DE Extrem flache Pendelleuchte mit 28 mm Gesamthöhe; abgependelt mit Seilabhängung; werkzeuglose Höhenverstellung an der Leuchte; inkl. transparenter Einspeiseleitung; Oberfläche pulverbeschichtet; absturzesicherer Lichteinsatz aus stranggepresstem Aluminiumprofil werkzeuglos mittels Magnethalter in Kanal einsetzbar; seitlich eingekoppeltes Licht durch LGP-Body (Light-Guiding-Prism) und hocheffizientem Reflektor nach unten gelenkt; homogen ausgeleuchtete, satinierte (bündig oder herausragend) oder mikroprismatische Abdeckung aus PMMA; energieeffiziente LEDs mit sehr guter Farbwiedergabe



Quickinfo

3000K, 4000K
 CRI ≥ 80, 3 SDCM
 up to 137lm/W
 L90 @ 50 000h
 DALI-2
 opal, microprismatic (UGR ≤ 19),
 jut-out

Types

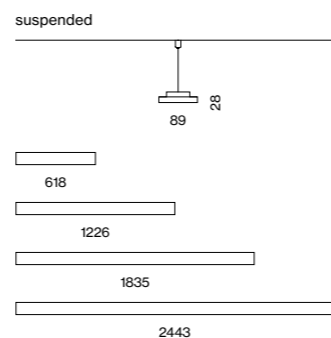

Colours



Light distributions



Order options

COLOUR TEMPERATURE	
3000K	5
4000K	6

CONTROL

DALI-2

MATERIAL COLOUR

- traffic white RAL 9016 7
- jet black RAL 9005 8

LIGHT OPTIC COVER

- opal high performance H
- microprismatic (UGR ≤ 19) G
- jut-out J

Options on request

COLOUR RENDERING INDEX

CRI ≥ 90

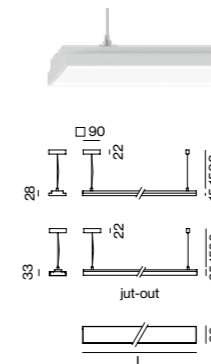

LENO suspended



LUMINAIRE

SYS. POWER	COLOUR TEMP.	LUM. FLUX	L (mm)	ORDER CODE
10.8 W	3000K	1230 lm	618	05 1-9 2 1 2 :: 3 ▣
19.1 W	3000K	2450 lm	1226	05 1-9 2 1 4 :: 3 ▣
28.6 W	3000K	3680 lm	1835	05 1-9 2 1 6 :: 3 ▣
38 W	3000K	4900 lm	2443	05 1-9 2 1 8 :: 3 ▣
	4000K	1300 lm		
	4000K	2600 lm		
	4000K	3890 lm		
	4000K	5190 lm		

Technical data

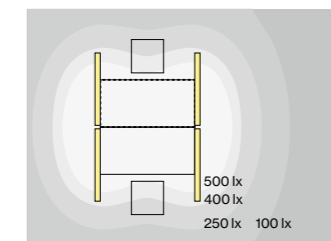

LENO suspended, microprismatic, 19.1W, 4000K

ROOM VALUES

Room dimensions	5.4 × 4 × 2.8 m
Reflection factor	0.7 0.5 0.2
Maintenance factor	0.8
Mounting height	2.25 m

CALCULATION SURFACE

Surface dimensions	1.6 × 0.8
Surface height	0.75
Average illuminance (E _m)	> 500 lx
Uniformity (U ₀)	> 0.9

GLARE EVALUATION

Table Classification X=4H Y=8H S=0.25H	
UGR transversal	≤ 19
UGR axial	≤ 19

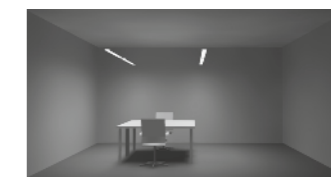

DiiA® standards
251, 252, 253

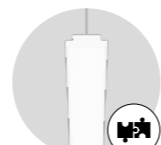

system
solution (p.876)

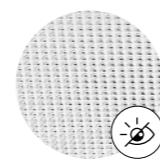

microprismatic
UGR ≤ 19



quick
installation

LUMINOUS FLUX value calculated for CRI ≥ 80, colour white, cover opal microprismatic -5%, jut-out -4%

Amvest headquarters Amsterdam, NL –
by Firm Architects with lighting design
by Maichel Kusters



Sharpen your profile



MINIMAL

EN Minimalism par excellence: If you like straightforward design, then MINIMAL is perfect for you. Aimed at interiors, the recessed profile luminaire can be seamlessly integrated into all rooms and interiors with style. The single luminaire is trimless, available in different lengths, and varies the desired room effect with the light colours 3000K, 4000K, or Tunable White. Homogenous room illumination is achieved with the opal cover. For standard-compliant workplace lighting, the microprismatic cover version is the best choice.

DE Minimalismus par excellence: Wenn Sie geradliniges Design mögen, ist die MINIMAL perfekt für Sie geeignet. Die auf Innenräume ausgerichtete Einbau-Profileuchte lässt sich nahtlos in alle Räume und deren Interior stilvoller integrieren. Die Einzelleuchte ist randlos, in verschiedenen Längen erhältlich und variiert die gewünschte Raumwirkung mit den Lichtfarben 3000K, 4000K oder Tunable White. Eine homogene Raumausleuchtung ist mit der Opal Abdeckung gegeben, für normgerechte Arbeitsplatzbeleuchtung wählen Sie am besten die Version mit mikroprismatischer Abdeckung.

Types



60

100

Mounting



trimless
recessed

Light distributions

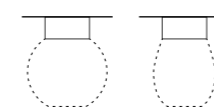

opal

microprismatic
(UGR ≤ 19)

← back



MINIMAL 60

recessed trimless

EN Luminaire housing made of extruded aluminium; for trimless installation in plasterboard ceilings; special edge design with grooves for better adhesion of filler; suitable for ceiling thickness of 8-25mm; surface powder coated; luminaire profile for mounting available in advance; remaining luminaire components mounted without tools; light inset consisting of highly reflective coated extruded profile for improved thermal management; HPO (High Performance Opal) cover for uniform illumination; microprismatic PMMA diffuser incl. diffuser film for homogeneous illumination and reduced luminance; energy-efficient LEDs with very good colour rendering

DE Leuchtenkörper aus Aluminiumstrangpressprofil; geeignet für den randlosen Einbau in Gipskartondecken; spezielle Randausbildung mit Rillen für bessere Haftung der Spachtelmasse; geeignet für Deckenstärken von 8-25mm; Oberfläche pulverbeschichtet; Leuchtenprofil für Montage vorab lieferbar; restliche Leuchtenkomponenten werkzeuglos montierbar; Lichteinsatz bestehend aus hochreflektierend lackiertem Strangpressprofil für verbessertes Thermomanagement; HPO (High Performance Opal) Abdeckung für homogene Ausleuchtung; mikroprismatische PMMA-Abdeckung inkl. Diffusorfolie zur Reduktion der Leuchtdichte bei homogener Ausleuchtung; energieeffiziente LEDs mit sehr guter Farbwiedergabe

Quickinfo

3000K, 4000K
 CRI ≥ 80, 3 SDCM
 up to 125lm/W
 L90 @ 50 000h
 non DIM, DALI-2
 opal, microprismatic (UGR ≤ 19)

Types

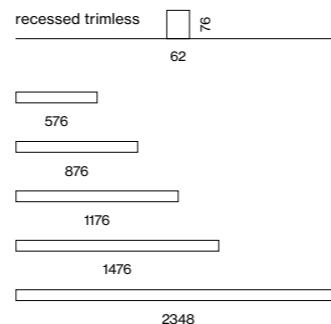

Colour



Light distributions

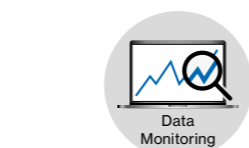

DiiA® standards
 251, 252, 253

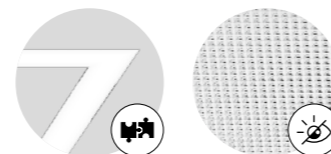

system solution (p. 880) microprismatic UGR ≤ 19

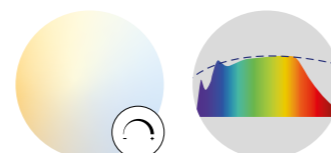

tunable white 2700–6500K CRI ≥ 98 XPECTRUM

Order options

COLOUR TEMPERATURE
 3000K 5
 4000K 6

CONTROL
 non DIM 1
 DALI-2 3

MATERIAL COLOUR
 traffic white RAL 9016

LIGHT OPTIC COVER
 opal high performance H
 microprismatic Z
 microprismatic (UGR ≤ 19)* G
 *UGR ≤ 19 only with mid lumen

Options on request

COLOUR RENDERING INDEX
 CRI ≥ 90
 CRI ≥ 98 XPECTRUM

COLOUR TEMPERATURE
 tunable white 2700–6500K
 DALI-2 DT8

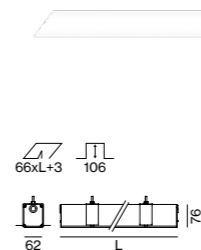

MINIMAL 60 trimless



MID LUMEN

SYS. POWER	COLOUR TEMP.	LUM. FLUX	L (mm)	ORDER CODE
8.7W	3000K	902lm	576	0 5 2 - 3 2 L 2 :: 1 7 □
	4000K	955lm		
13W	3000K	1350lm	876	0 5 2 - 3 2 L 3 :: 1 7 □
	4000K	1430lm		
15.3W	3000K	1800lm	1176	0 5 2 - 3 2 L 4 :: 1 7 □
	4000K	1910lm		
19.2W	3000K	2250lm	1476	0 5 2 - 3 2 L 5 :: 1 7 □
	4000K	2390lm		
31W	3000K	3610lm	2348	0 5 2 - 3 2 L 8 :: 1 7 □
	4000K	3820lm		

HIGH LUMEN

SYS. POWER	COLOUR TEMP.	LUM. FLUX	L (mm)	ORDER CODE
13.8W	3000K	1490lm	576	0 5 2 - 3 2 M 2 :: 7 □
	4000K	1580lm		
20.6W	3000K	2240lm	876	0 5 2 - 3 2 M 3 :: 7 □
	4000K	2370lm		
27.5W	3000K	2980lm	1176	0 5 2 - 3 2 M 4 :: 7 □
	4000K	3160lm		
34W	3000K	3730lm	1476	0 5 2 - 3 2 M 5 :: 7 □
	4000K	3950lm		
55W	3000K	5970lm	2348	0 5 2 - 3 2 M 8 :: 7 □
	4000K	6320lm		

Mounting accessories

CONCRETE INSTALLATION HOUSING

L (mm)	W-H (mm)	ORDER CODE
635	75-88	0 3 6 - 0 4 0 6 6
935	75-88	0 3 6 - 0 4 0 9 6
1235	75-88	0 3 6 - 0 4 1 2 6
1535	75-88	0 3 6 - 0 4 1 5 6
2407	75-88	0 3 6 - 0 4 2 3 6

no use for wall installation (only on request)

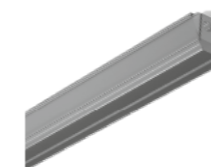

LUMINOUS FLUX value calculated for CRI ≥ 80, colour white, cover opal microprismatic -13%

← back

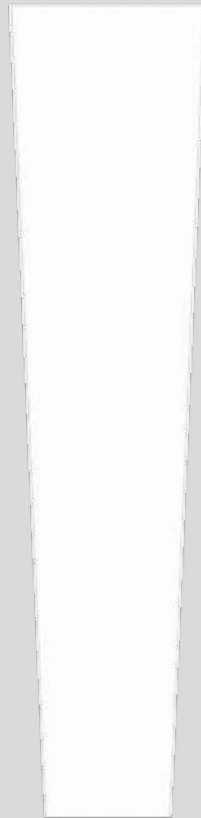

MINIMAL 100

recessed trimless

EN Luminaire housing made of extruded aluminium; for trimless installation in plasterboard ceilings; special edge design with grooves for better adhesion of filler; suitable for ceiling thickness of 8-25mm; surface powder coated; luminaire profile for mounting available in advance; remaining luminaire components mounted without tools; light inset consisting of highly reflective coated extruded profile for improved thermal management; HPO (High Performance Opal) cover for uniform illumination; microprismatic PMMA diffuser incl. diffuser film for homogeneous illumination and reduced luminance; energy-efficient LEDs with very good colour rendering

DE Leuchtenkörper aus Aluminiumstrangpressprofil; geeignet für den randlosen Einbau in Gipskartondecken; spezielle Randausbildung mit Rillen für bessere Haftung der Spachtelmasse; geeignet für Deckenstärken von 8-25mm; Oberfläche pulverbeschichtet; Leuchtenprofil für Montage vorab lieferbar; restliche Leuchtenkomponenten werkzeuglos montierbar; Lichteinsatz bestehend aus hochreflektierend lackiertem Strangpressprofil für verbessertes Thermomanagement; HPO (High Performance Opal) Abdeckung für homogene Ausleuchtung; mikroprismatische PMMA-Abdeckung inkl. Diffusorfolie zur Reduktion der Leuchtdichte bei homogener Ausleuchtung; energieeffiziente LEDs mit sehr guter Farbwiedergabe

Quickinfo

3000K, 4000K
CRI ≥ 80, 3 SDCM
UGR ≤ 19 / 65° ≤ 3000 cd/m²
up to 7070 lm
up to 140 lm/W
L90 @ 50 000h
non DIM, DALI-2
opal, microprismatic (UGR ≤ 19)

Types

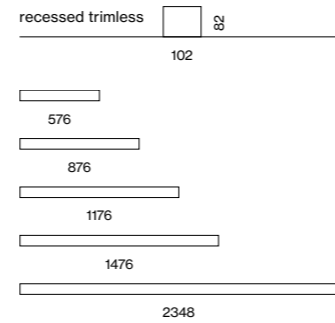

Colour



Light distributions



microp. opal

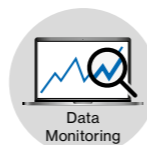

Data Monitoring
DiiA® standards
251, 252, 253



system
solution (p.882)



DIN EN 12464-1
UGR ≤ 19

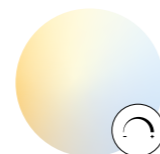

tunable white
2700–6500K

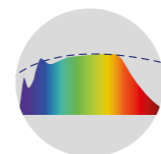

CRI ≥ 98
XPECTRUM

Order options

COLOUR TEMPERATURE	
3000K	5
4000K	6

CONTROL	
non DIM	1
DALI-2	3

MATERIAL COLOUR

○ traffic white RAL 9016

LIGHT OPTIC COVER

opal high performance	H
microprismatic	Z
microprismatic (UGR ≤ 19)	G

Options on request

COLOUR RENDERING INDEX

CRI ≥ 90
CRI ≥ 98 XPECTRUM

COLOUR TEMPERATURE

tunable white 2700–6500K
DALI-2 DT8

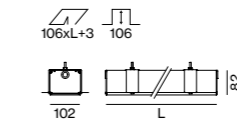

MINIMAL 100 trimless

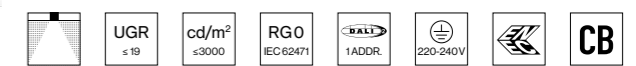

MID LUMEN

SYS. POWER	COLOUR TEMP.	LUM. FLUX	L (mm)	ORDER CODE
8.7W	3000K	1010lm	576	052-33L2::17 □
	4000K	1070lm		
13W	3000K	1520lm	876	052-33L3::17 □
	4000K	1600lm		
15.3W	3000K	2020lm	1176	052-33L4::17 □
	4000K	2140lm		
19.2W	3000K	2530lm	1476	052-33L5::17 □
	4000K	2670lm		
31W	3000K	4040lm	2348	052-33L8::17 □
	4000K	4280lm		

HIGH LUMEN

SYS. POWER	COLOUR TEMP.	LUM. FLUX	L (mm)	ORDER CODE
13.8W	3000K	1670lm	576	052-33M2::7 □
	4000K	1770lm		
20.6W	3000K	2510lm	876	052-33M3::7 □
	4000K	2650lm		
27.5W	3000K	3340lm	1176	052-33M4::7 □
	4000K	3540lm		
34W	3000K	4180lm	1476	052-33M5::7 □
	4000K	4420lm		
55W	3000K	6680lm	2348	052-33M8::7 □
	4000K	7070lm		

Mounting accessories

CONCRETE INSTALLATION HOUSING

L (mm)	W-H (mm)	ORDER CODE
635	116-94	036-05066
935	116-94	036-05096
1235	116-94	036-05126
1535	116-94	036-05156
2407	116-94	036-05236

no use for wall installation (only on request)

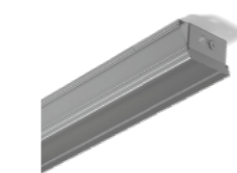

LUMINOUS FLUX value calculated for
CRI ≥ 80, colour white, cover opal
microprism. Z -8%, microprism. G -10%

Strozzigasse 10
Vienna, AT –
by Bernd Besenlehner



Outline your profile

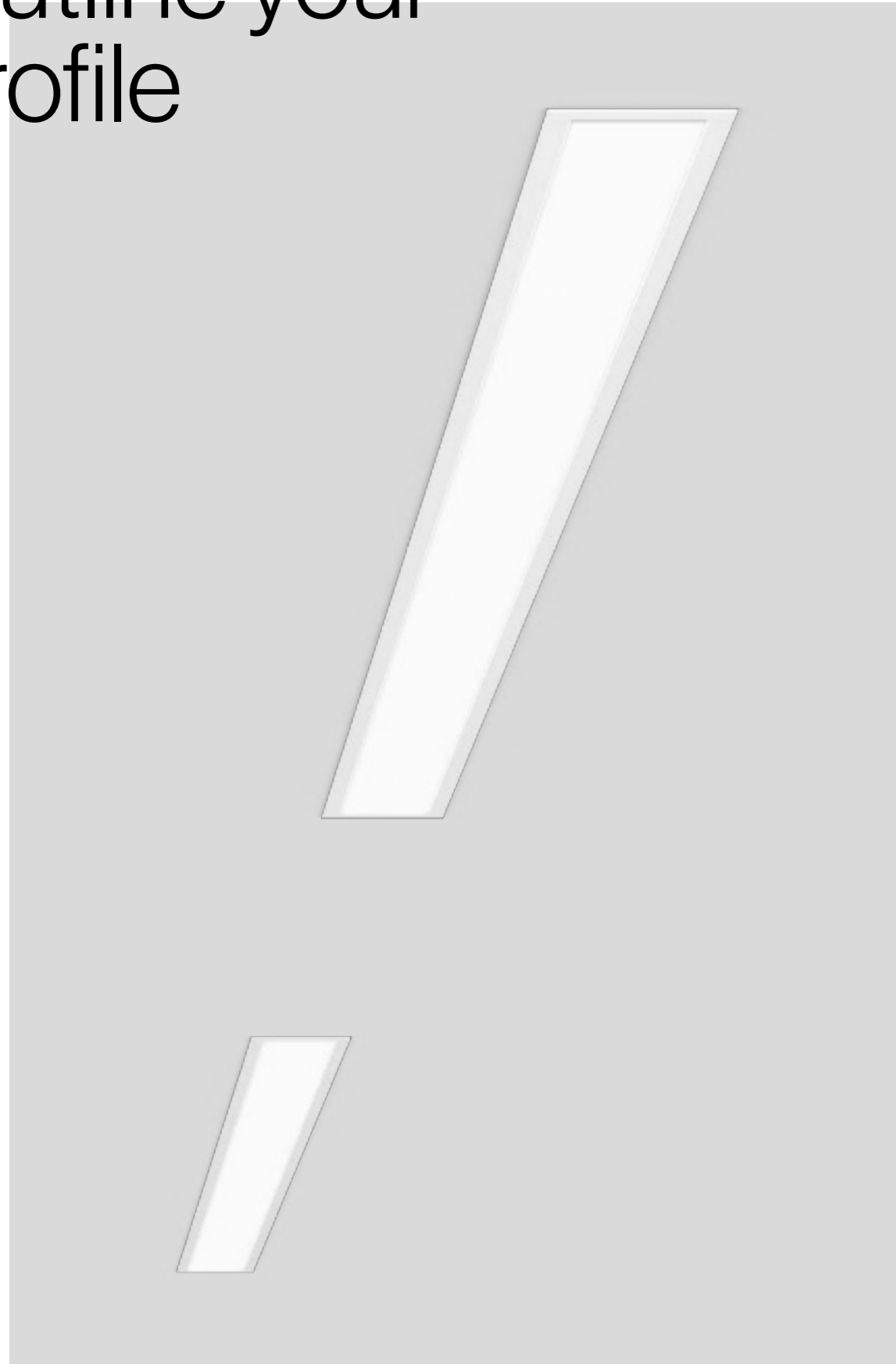

FRAME

EN FRAME makes flexible workplace lighting easy. The microprismatic cover ensures optimum glare control and thus standard-compliant illumination of the work areas. With a total of five lengths and three widths, this profile luminaire is versatile. Depending on the colour rendering requirement, the single luminaire is available up to $\text{CRI} \geq 98$ or in the light colours 3000K, 4000K, or Tunable White. FRAME's opal cover version delivers optimal and uniform room illumination.

DE Eine flexible Arbeitsplatzbeleuchtung ist mit der FRAME ein Leichtes. Die mikroprismatische Abdeckung sorgt für optimale Entblendung und somit für normgerechte Ausleuchtung der Arbeitsbereiche. Mit insgesamt fünf Längen und drei Breiten ist diese Profilleuchte vielseitig einsetzbar. Je nach Anforderung an die Farbwiedergabe ist die Einzeleuchte bis zu $\text{CRI} \geq 98$ bzw. in den Lichtfarben 3000K, 4000K oder Tunable White erhältlich. In der Variante mit Opal-Cover sorgt FRAME für eine optimale und gleichmäßige Raumausleuchtung.

Types



40

60

100

Mounting



with trim
recessed

Light distributions

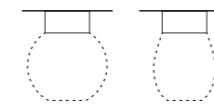

opal

microprismatic
($\text{UGR} \leq 19$)

back



FRAME 40

recessed with trim

EN Luminaire housing made of extruded aluminium; recessed luminaire with trim; suitable for ceiling thickness of 8-25 mm; surface powder coated; luminaire profile can be pre-mounted; remaining luminaire components mounted without tools; light inset consisting of highly reflective coated extruded profile for improved thermal management; HPO (High Performance Opal) cover for uniform illumination; energy-efficient LEDs with very good colour rendering

DE Leuchtenkörper aus Aluminiumstrangpressprofil; Einbauleuchte mit umlaufendem Rand; geeignet für Deckenstärken von 8-25 mm; Oberfläche pulverbeschichtet; Leuchtenprofil vorab montierbar; restliche Leuchtenkomponenten werkzeuglos montierbar; Lichteinsatz bestehend aus hochreflektierend lackiertem Strangpressprofil für verbessertes Thermomanagement; HPO (High Performance Opal) Abdeckung für homogene Ausleuchtung; energieeffiziente LEDs mit sehr guter Farbwiedergabe

Quickinfo

3000K, 4000K
CRI ≥ 90, 3 SDCM
up to 102lm/W
L90 @ 50 000h
DALI-2
opal

Types

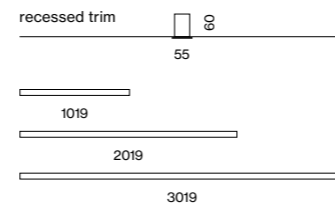

Colours



Light distribution



opal

Order options

COLOUR TEMPERATURE	
3000K	0
4000K	1

CONTROL

DALI-2

MATERIAL COLOUR

- traffic white RAL 9016 7
 white aluminium RAL 9006 G

LIGHT OPTIC COVER

opal high performance

Options on request

COLOUR RENDERING INDEX

CRI ≥ 98 XPECTRUM

COLOUR TEMPERATURE

tunable white 2700–6500 K

DALI-2 DT8

LIGHT OPTIC COVER

microprismatic



FRAME 40 trim

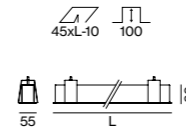

MID LUMEN

SYS. POWER	COLOUR TEMP.	LUM. FLUX	L (mm)	ORDER CODE
15.3W	3000K	1480lm	1019	0 4 2 - 7 1 1 2 :: 3 H
30.5W	3000K	2950lm	2019	0 4 2 - 7 1 1 4 :: 3 H
46W	3000K	4420lm	3019	0 4 2 - 7 1 1 6 :: 3 H
	4000K	1560lm		
	4000K	3120lm		
	4000K	4680lm		

HIGH LUMEN

SYS. POWER	COLOUR TEMP.	LUM. FLUX	L (mm)	ORDER CODE
22.9W	3000K	2210lm	1019	0 4 2 - 7 1 2 2 :: 3 H
46W	3000K	4420lm	2019	0 4 2 - 7 1 2 4 :: 3 H
69W	3000K	6630lm	3019	0 4 2 - 7 1 2 6 :: 3 H
	4000K	2340lm		
	4000K	4680lm		
	4000K	7020lm		

Mounting accessories

CONCRETE INSTALLATION HOUSING

L (mm)	W-H (mm)	ORDER CODE
1038	57-87	0 4 2 - 7 1 9 5 2 1 0
2038	57-87	0 4 2 - 7 1 9 5 4 1 0
3038	57-87	0 4 2 - 7 1 9 5 6 1 0

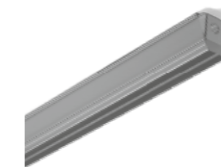

DiiA® standards
251, 252, 253



system
solution (p.890)

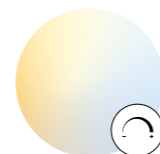

tunable white
2700–6500 K

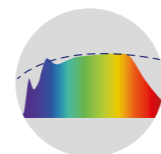

CRI ≥ 98
XPECTRUM

LUMINOUS FLUX value calculated for
CRI ≥ 90, colour white, cover opal

back



FRAME 60

recessed with trim

EN Luminaire housing made of extruded aluminium; recessed luminaire with trim; suitable for ceiling thickness of 8-25mm; surface powder coated; luminaire profile for mounting available in advance; remaining luminaire components mounted without tools; light inset consisting of highly reflective coated extruded profile for improved thermal management; HPO (High Performance Opal) cover for uniform illumination; microprismatic PMMA diffuser incl. diffuser film for homogeneous illumination and reduced luminance; energy-efficient LEDs with very good colour rendering

DE Leuchtenkörper aus Aluminiumstrangpressprofil; Einbauleuchte mit umlaufendem Rand; geeignet für Deckenstärken von 8-25 mm; Oberfläche pulverbeschichtet; Leuchtenprofil für Montage vorab lieferbar; restliche Leuchtenkomponenten werkzeuglos montierbar; Lichteinsatz bestehend aus hochreflektierend lackiertem Strangpressprofil für verbessertes Thermomanagement; HPO (High Performance Opal) Abdeckung für homogene Ausleuchtung; mikroprismatische PMMA-Abdeckung inkl. Diffusorfolie zur Reduktion der Leuchtdichte bei homogener Ausleuchtung; energieeffiziente LEDs mit sehr guter Farbwiedergabe

Quickinfo

3000K, 4000K
CRI ≥ 80, 3 SDCM
up to 125lm/W
L90 @ 50 000h
non DIM, DALI-2
opal, microprismatic (UGR ≤ 19)

Types

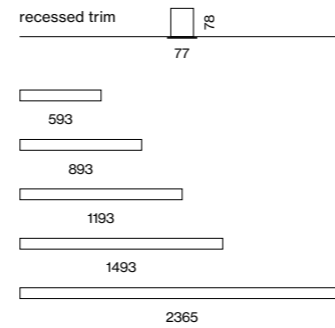

Colours



Light distributions



micropr. opal



DiiA® standards
251, 252, 253



system
solution (p.892)

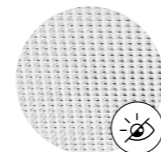

microprismatic
UGR ≤ 19

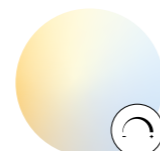

tunable white
2700–6500K

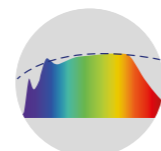

CRI ≥ 98
XPECTRUM

Order options

COLOUR TEMPERATURE	
3000K	5
4000K	6

CONTROL	
non DIM	1
DALI-2	3

MATERIAL COLOUR	
<input type="radio"/> traffic white RAL 9016	7
<input checked="" type="radio"/> white aluminium RAL 9006	G

LIGHT OPTIC COVER	
opal high performance	H
microprismatic	Z
microprismatic (UGR ≤ 19)*	G

*UGR ≤ 19 only with mid lumen

Options on request

COLOUR RENDERING INDEX	
CRI ≥ 90	
CRI ≥ 98 XPECTRUM	

COLOUR TEMPERATURE	
tunable white 2700–6500K	
DALI-2 DT8	

INDIVIDUAL MATERIAL COLOUR
please contact factory



FRAME 60 trim

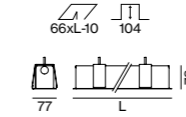

MID LUMEN

SYS. POWER	COLOUR TEMP.	LUM. FLUX	L (mm)	ORDER CODE
8.7W	3000K	902lm	593	0 5 2 - 4 7 L 2 :: 1 <input checked="" type="checkbox"/> <input type="checkbox"/>
	4000K	955lm		
13W	3000K	1350lm	893	0 5 2 - 4 7 L 3 :: 1 <input checked="" type="checkbox"/> <input type="checkbox"/>
	4000K	1430lm		
15.3W	3000K	1800lm	1193	0 5 2 - 4 7 L 4 :: 1 <input checked="" type="checkbox"/> <input type="checkbox"/>
	4000K	1910lm		
19.2W	3000K	2250lm	1493	0 5 2 - 4 7 L 5 :: 1 <input checked="" type="checkbox"/> <input type="checkbox"/>
	4000K	2390lm		
31W	3000K	3610lm	2365	0 5 2 - 4 7 L 8 :: 1 <input checked="" type="checkbox"/> <input type="checkbox"/>
	4000K	3820lm		

HIGH LUMEN

SYS. POWER	COLOUR TEMP.	LUM. FLUX	L (mm)	ORDER CODE
13.8W	3000K	1490lm	593	0 5 2 - 4 7 M 2 :: <input checked="" type="checkbox"/> <input checked="" type="checkbox"/> <input type="checkbox"/>
	4000K	1580lm		
20.6W	3000K	2240lm	893	0 5 2 - 4 7 M 3 :: <input checked="" type="checkbox"/> <input checked="" type="checkbox"/> <input type="checkbox"/>
	4000K	2370lm		
27.5W	3000K	2980lm	1193	0 5 2 - 4 7 M 4 :: <input checked="" type="checkbox"/> <input checked="" type="checkbox"/> <input type="checkbox"/>
	4000K	3160lm		
34W	3000K	3730lm	1493	0 5 2 - 4 7 M 5 :: <input checked="" type="checkbox"/> <input checked="" type="checkbox"/> <input type="checkbox"/>
	4000K	3950lm		
55W	3000K	5970lm	2365	0 5 2 - 4 7 M 8 :: <input checked="" type="checkbox"/> <input checked="" type="checkbox"/> <input type="checkbox"/>
	4000K	6320lm		

Mounting accessories

CONCRETE INSTALLATION HOUSING

L (mm)	W-H (mm)	ORDER CODE
635	75-88	0 3 5 - 0 4 0 6 6
935	75-88	0 3 5 - 0 4 0 9 6
1235	75-88	0 3 5 - 0 4 1 2 6
1535	75-88	0 3 5 - 0 4 1 5 6
2407	75-88	0 3 5 - 0 4 2 3 6

no use for wall installation (only on request)

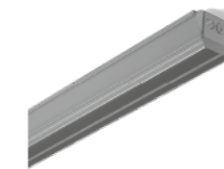

LUMINOUS FLUX value calculated for
CRI ≥ 80, colour white, cover opal
microprismatic -13%

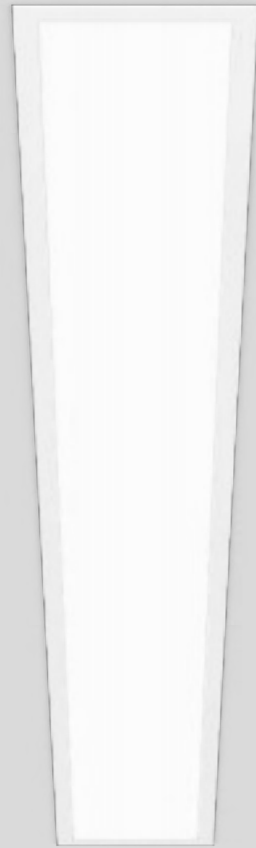
[← back](#)

FRAME 100

recessed with trim

EN Luminaire housing made of extruded aluminium; recessed luminaire with trim; suitable for ceiling thickness of 8-25mm; surface powder coated; luminaire profile for mounting available in advance; remaining luminaire components mounted without tools; light inset consisting of highly reflective coated extruded profile for improved thermal management; HPO (High Performance Opal) cover for uniform illumination; micro prismatic PMMA diffuser incl. diffuser film for homogeneous illumination and reduced luminance; energy-efficient LEDs with very good colour rendering

DE Leuchtenkörper aus Aluminiumstrangpressprofil; Einbauleuchte mit umlaufendem Rand; geeignet für Deckenstärken von 8-25mm; Oberfläche pulverbeschichtet; Leuchtenprofil für Montage vorab lieferbar; restliche Leuchtenkomponenten werkzeuglos montierbar; Lichteinsatz bestehend aus hochreflektierend lackiertem Strangpressprofil für verbessertes Thermomanagement; HPO (High Performance Opal) Abdeckung für homogene Ausleuchtung; mikroprismatische PMMA-Abdeckung inkl. Diffusorfolie zur Reduktion der Leuchtdichte bei homogener Ausleuchtung; energieeffiziente LEDs mit sehr guter Farbwiedergabe

Quickinfo

3000K, 4000K
 CRI ≥ 80, 3 SDCM
 UGR ≤ 19 / 65° ≤ 3000 cd/m²
 up to 7070 lm
 up to 140 lm/W
 L90 @ 50 000h
 non DIM, DALI-2
 opal, microprismatic (UGR ≤ 19)

Types

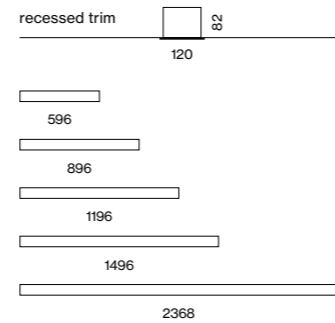

Colours



Light distributions

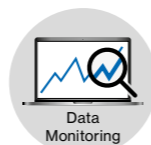

Data Monitoring
 DiiA® standards
 251, 252, 253



system
 solution (p.898)



DIN EN 12464-1
 UGR ≤ 19

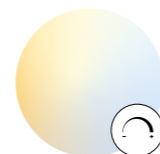

tunable white
 2700–6500K

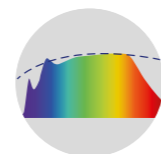

CRI ≥ 98
 XPECTRUM

Order options

COLOUR TEMPERATURE	
3000K	5
4000K	6

CONTROL	
non DIM	1
DALI-2	3

MATERIAL COLOUR	
<input type="radio"/> traffic white RAL 9016	7
<input checked="" type="radio"/> white aluminium RAL 9006	G

LIGHT OPTIC COVER	
opal high performance	H
microprismatic	Z
microprismatic (UGR ≤ 19)	G

Options on request

COLOUR RENDERING INDEX	
CRI ≥ 90	
CRI ≥ 98 XPECTRUM	

COLOUR TEMPERATURE	
tunable white 2700–6500K	
DALI-2 DT8	

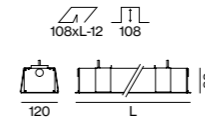

FRAME 100 trim

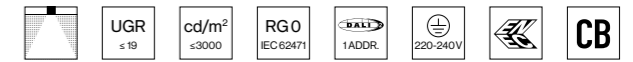

MID LUMEN

SYS. POWER	COLOUR TEMP.	LUM. FLUX	L (mm)	ORDER CODE
8.7W	3000K	1010lm	596	0 5 2 - 4 3 L 2 :: 1 ▣ □
	4000K	1070lm		
13W	3000K	1520lm	896	0 5 2 - 4 3 L 3 :: 1 ▣ □
	4000K	1600lm		
15.3W	3000K	2020lm	1196	0 5 2 - 4 3 L 4 :: 1 ▣ □
	4000K	2140lm		
19.2W	3000K	2530lm	1496	0 5 2 - 4 3 L 5 :: 1 ▣ □
	4000K	2670lm		
31W	3000K	4040lm	2368	0 5 2 - 4 3 L 8 :: 1 ▣ □
	4000K	4280lm		

HIGH LUMEN

SYS. POWER	COLOUR TEMP.	LUM. FLUX	L (mm)	ORDER CODE
13.8W	3000K	1670lm	596	0 5 2 - 4 3 M 2 :: ▣ ▣ □
	4000K	1770lm		
20.6W	3000K	2510lm	896	0 5 2 - 4 3 M 3 :: ▣ ▣ □
	4000K	2650lm		
27.5W	3000K	3340lm	1196	0 5 2 - 4 3 M 4 :: ▣ ▣ □
	4000K	3540lm		
34W	3000K	4180lm	1496	0 5 2 - 4 3 M 5 :: ▣ ▣ □
	4000K	4420lm		
55W	3000K	6680lm	2368	0 5 2 - 4 3 M 8 :: ▣ ▣ □
	4000K	7070lm		

Mounting accessories

CONCRETE INSTALLATION HOUSING

L (mm)	W-H (mm)	ORDER CODE
635	116-94	0 3 5 - 0 5 0 6 6
935	116-94	0 3 5 - 0 5 0 9 6
1235	116-94	0 3 5 - 0 5 1 2 6
1535	116-94	0 3 5 - 0 5 1 5 6
2407	116-94	0 3 5 - 0 5 2 3 6

no use for wall installation (only on request)

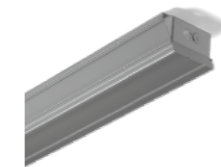

LUMINOUS FLUX value calculated for
 CRI ≥ 80, colour white, cover opal
 microprism. Z -8%, microprism. G -10%

Geriatrics Simmering, AT –
by Josef Weichenberger architects +
Partner including lighting design





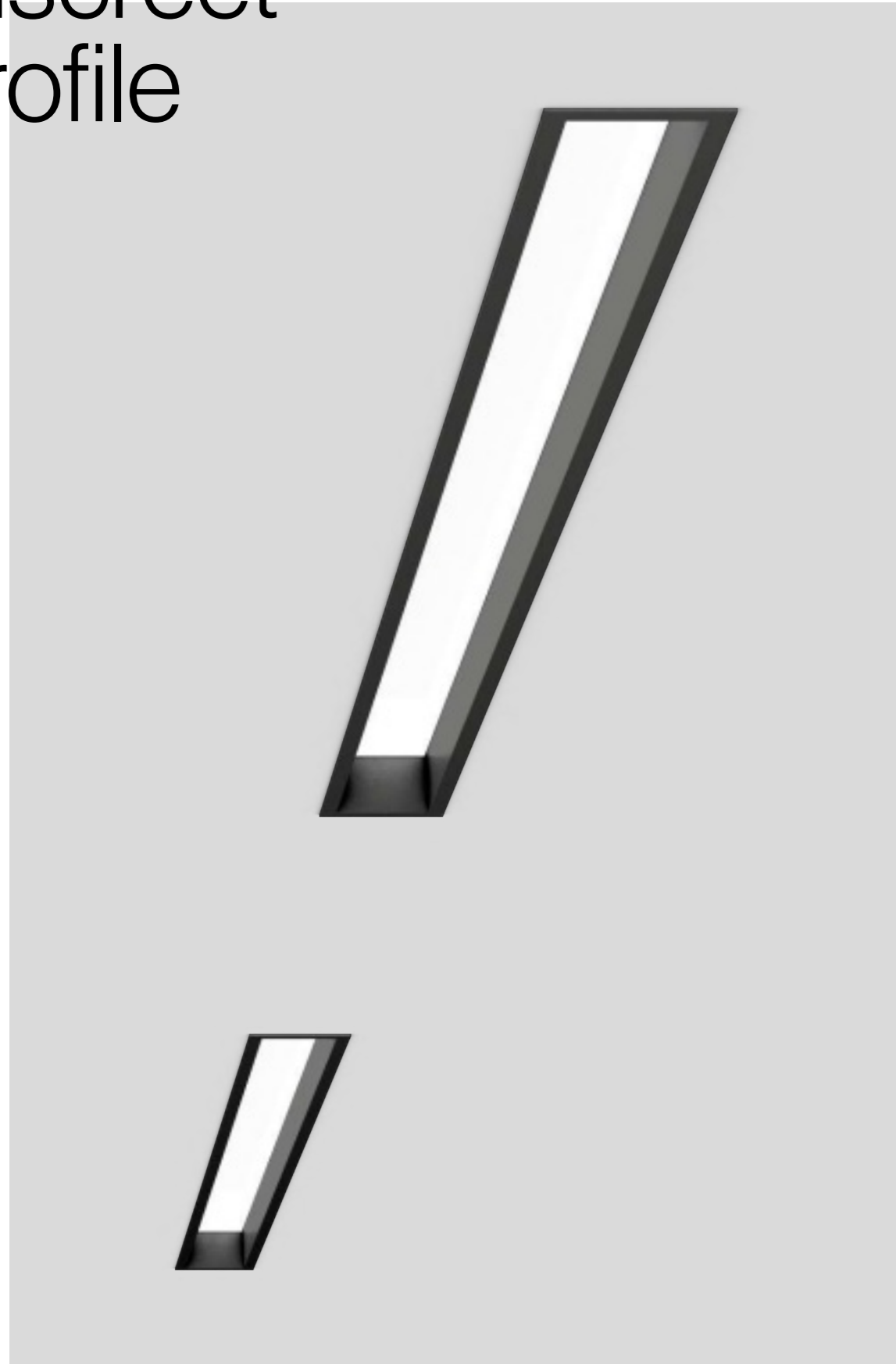

Discreet profile



CANYON

EN The perfect first impression: The CANYON luminaire and its simplicity create a calm ambience in the entrance area. CANYON also crafts a calm ceiling appearance in recreation rooms, corridors, or at the workplace thanks to the recessed luminaire level. The profile luminaire with a trim can be used universally as it comes in different lengths and with different covers, such as microprismatic or opal. The CANYON single luminaire's colour rendering reaches up to $\text{CRI} \geq 90$ with a total of three possible light colours: 3000K, 4000K, and Tunable White.

DE Der perfekte erste Eindruck: Die CANYON Leuchte sorgt im Eingangsbereich mit ihrer Schlichtheit für ruhiges Ambiente. Auch in Aufenthaltsräumen, Gängen oder am Arbeitsplatz bewirkt CANYON dank der zurückversetzten Leuchten-Ebene ein ruhiges Deckenbild. Die Profileuchte mit Rand kann dank verschiedener Längen und unterschiedlicher Abdeckungen, wie der Mikroprismatik oder dem Opal-Cover, universell verwendet werden. Die Farbwiedergabe der CANYON Einzelleuchte erreicht bis zu $\text{CRI} \geq 90$ bei insgesamt drei möglichen Lichtfarben – 3000K, 4000K und Tunable White.

Type	
	60
Mounting	
	trim recessed
Light distributions	 
	opal microprismatic ($\text{UGR} \leq 19$)

← back



CANYON 60

recessed offset with trim

EN Luminaire housing made of extruded aluminium; uncluttered ceiling look through recessed lighting level; recessed luminaire with trim; suitable for ceiling thickness of 8-25mm; surface powder coated; luminaire profile for mounting available in advance; remaining luminaire components mounted without tools; light inset consisting of highly reflective coated extruded profile for improved thermal management; HPO (High Performance Opal) cover for uniform illumination; micro prismatic PMMA diffuser incl. diffuser film for homogeneous illumination and reduced luminance; energy-efficient LEDs with very good colour rendering

DE Leuchtenkörper aus Aluminiumstrangpressprofil; ruhiges Deckenbild durch zurückversetzte Leuchtenebene; Einbauleuchte mit umlaufendem Rand; geeignet für Deckenstärken von 8-25mm; Oberfläche pulverbeschichtet; Leuchtenprofil für Montage vorab lieferbar; restliche Leuchtenkomponenten werkzeuglos montierbar; Lichteinsatz bestehend aus hochreflektierend lackiertem Strangpressprofil für verbessertes Thermomanagement; HPO (High Performance Opal) Abdeckung für homogene Ausleuchtung; mikroprismatische PMMA-Abdeckung inkl. Diffusorfolie zur Reduktion der Leuchtdichte bei homogener Ausleuchtung; energieeffiziente LEDs mit sehr guter Farbwiedergabe

Quickinfo

3000K, 4000K
 CRI ≥ 80, 3 SDCM
 up to 105lm/W
 L90 @ 50 000h
 non DIM, DALI-2
 opal, microprismatic

Types

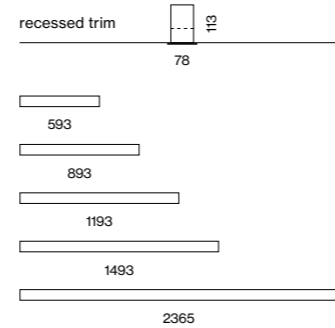

Colours



Light distributions

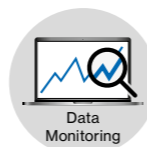

Data Monitoring
 DiiA® standards
 251, 252, 253



ball-impact-resistant

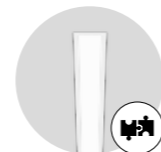

system solution (p.904)



glare control
 UGR ≤ 19



tunable white
 2700-6500K

Order options

COLOUR TEMPERATURE	
3000K	5
4000K	6

CONTROL	
non DIM	1
DALI-2	3

MATERIAL COLOUR	
○ traffic white RAL 9016	7
● jet black RAL 9005	8

LIGHT OPTIC COVER	
opal high performance	H
microprismatic	Z

Options on request

COLOUR RENDERING INDEX	
CRI ≥ 90	

COLOUR TEMPERATURE	
tunable white 2700-6500K	
DALI-2 DT8	



CANYON 60 trim offset

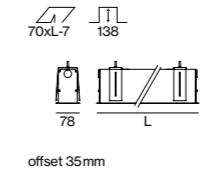

MID LUMEN	SYS. POWER	COLOUR TEMP.	LUM. FLUX	L (mm)	ORDER CODE
	8.7W	3000K	760lm	593	0 5 2 - 5 2 L 2 :: 1
		4000K	804lm		
	13W	3000K	1140lm	893	0 5 2 - 5 2 L 3 :: 1
		4000K	1210lm		
	15.3W	3000K	1520lm	1193	0 5 2 - 5 2 L 4 :: 1
		4000K	1610lm		
	19.2W	3000K	1900lm	1493	0 5 2 - 5 2 L 5 :: 1
		4000K	2010lm		
	31W	3000K	3040lm	2365	0 5 2 - 5 2 L 8 :: 1
		4000K	3220lm		

HIGH LUMEN	SYS. POWER	COLOUR TEMP.	LUM. FLUX	L (mm)	ORDER CODE
	13.8W	3000K	1260lm	593	0 5 2 - 5 2 M 2 :: 1
		4000K	1330lm		
	20.6W	3000K	1880lm	893	0 5 2 - 5 2 M 3 :: 1
		4000K	2000lm		
	27.5W	3000K	2510lm	1193	0 5 2 - 5 2 M 4 :: 1
		4000K	2660lm		
	34W	3000K	3140lm	1493	0 5 2 - 5 2 M 5 :: 1
		4000K	3300lm		
	55W	3000K	5030lm	2365	0 5 2 - 5 2 M 8 :: 1
		4000K	5320lm		

LUMINOUS FLUX value calculated for CRI ≥ 80, colour white, cover opal microprismatic -9%

Business-Quartier Sparkasse
Salzburg, AT – by OM/ARGE Neutor,
Schabelreiter Architektur



Define your profile

MINO

EN The MINO single luminaire's character is multifaceted. It can be mounted on walls and ceilings as a surface-mounted version, but is also available as a suspended version. The variety continues in its optical details; in white, grey, and black, the luminaire can be selected with a colour rendering of up to $\text{CRI} \geq 98$ XPECTRUM and in the light colours 3000K, 4000K, or Tunable White. MINO optionally also comes with a microprismatic cover for ideal work light or with an opal cover for homogeneous room illumination.

DE Facettenreichtum zeichnet die MINO Einzelleuchte aus. Als Anbauvariante kann sie an Wänden und Decken montiert werden, sie ist aber auch in abgehängter Version verfügbar. Die Vielfalt setzt sich auch bei den optischen Details fort: in Weiß, Grau und Schwarz kann die Leuchte mit einer Farbwiedergabe von bis zu $\text{CRI} \geq 98$ XPECTRUM und in den Lichtfarben 3000K, 4000K oder als Tunable White Variante gewählt werden. Ergänzend kann MINO mit einer mikroprismatischen Abdeckung für ideales Arbeitslicht oder mit Opal-Cover für eine homogene Raumausleuchtung gewählt werden.

Types



40

60

100

Mountings

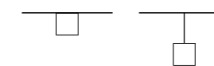

surface

suspended

Light distributions

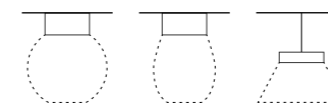

opal

microprismatic
($\text{UGR} \leq 19$)

direct

back



MINO 40

surface

^{EN} Luminaire housing from extruded aluminium profile, angular design; no visible screws; surface powder coated; luminaire profile can be pre-mounted; remaining luminaire components mounted without tools; light inset consisting of highly reflective coated extruded profile for improved thermal management; HPO (High Performance Opal) cover for uniform illumination; energy-efficient LEDs with very good colour rendering

^{DE} Leuchtenkörper aus Aluminiumstrangpressprofil, kantige Ausführung; keine sichtbaren Schrauben; Oberfläche pulverbeschichtet; Leuchtenprofil vorab montierbar; restliche Leuchtenkomponenten werkzeuglos montierbar; Lichteinsatz bestehend aus hochreflektierend lackiertem Strangpressprofil für verbessertes Thermomanagement; HPO (High Performance Opal) Abdeckung für homogene Ausleuchtung; energieeffiziente LEDs mit sehr guter Farbwiedergabe

Quickinfo

3000K, 4000K
CRI ≥ 90, 3 SDCM
up to 102lm/W
L90 @ 50 000h
DALI-2
opal

Types

surface

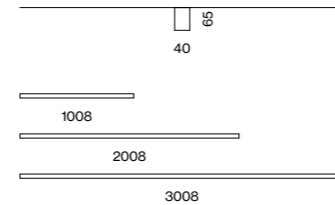

Colours



Light distribution

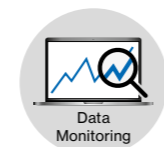

DiiA® standards
251, 252, 253



system
solution (p. 912)

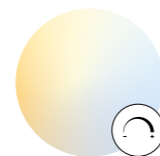

tunable white
2700–6500 K

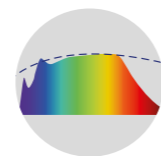

CRI ≥ 98
XPECTRUM

Order options

COLOUR TEMPERATURE	
3000K	0
4000K	1

CONTROL

DALI-2

MATERIAL COLOUR

<input type="radio"/> pure white RAL 9010	7
<input type="radio"/> white aluminium RAL 9006	G
<input checked="" type="radio"/> jet black RAL 9005	8

LIGHT OPTIC COVER

opal high performance

Options on request

COLOUR RENDERING INDEX

CRI ≥ 98 XPECTRUM

COLOUR TEMPERATURE

tunable white 2700–6500 K

DALI-2 DT8

LIGHT OPTIC COVER

microprismatic

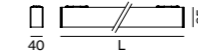

MINO 40 surface



MID LUMEN

SYS. POWER	COLOUR TEMP.	LUM. FLUX	L (mm)	ORDER CODE
15.3W	3000K	1480lm	1008	0 4 2 - 1 1 1 2 :: 3 H
	4000K	1560lm		
30.5W	3000K	2950lm	2008	0 4 2 - 1 1 1 4 :: 3 H
	4000K	3120lm		
46W	3000K	4420lm	3008	0 4 2 - 1 1 1 6 :: 3 H
	4000K	4680lm		

HIGH LUMEN

SYS. POWER	COLOUR TEMP.	LUM. FLUX	L (mm)	ORDER CODE
22.9W	3000K	2210lm	1008	0 4 2 - 1 1 2 2 :: 3 H
	4000K	2340lm		
46W	3000K	4420lm	2008	0 4 2 - 1 1 2 4 :: 3 H
	4000K	4680lm		
69W	3000K	6630lm	3008	0 4 2 - 1 1 2 6 :: 3 H
	4000K	7020lm		

LUMINOUS FLUX value calculated for
CRI ≥ 90, colour white, cover opal

back



MINO 40

suspended

EN Luminaire housing from extruded aluminium profile, angular design; no visible screws; surface powder coated; luminaire profile can be pre-mounted; remaining luminaire components mounted without tools; pendant fitting with cable suspension; height adjustment without tools; incl. transparent feed; light inset consisting of highly reflective coated extruded profile for improved thermal management; HPO (High Performance Opal) cover for uniform illumination; energy-efficient LEDs with very good colour rendering

DE Leuchtenkörper aus Aluminiumstrangpressprofil, kantige Ausführung; keine sichtbaren Schrauben; Oberfläche pulverbeschichtet; Leuchtenprofil vorab montierbar; restliche Leuchtenkomponenten werkzeuglos montierbar; abgependelt mit Seilabhängung; werkzeuglose Höhenverstellung; inkl. transparenter Einspeiseleitung; Lichteinsatz bestehend aus hochreflektierend lackiertem Strangpressprofil für verbessertes Thermomanagement; HPO (High Performance Opal) Abdeckung für homogene Ausleuchtung; energieeffiziente LEDs mit sehr guter Farbwiedergabe

Quickinfo

3000K, 4000K
CRI ≥ 90, 3 SDCM
up to 102lm/W
L90 @ 50 000h
DALI-2
opal

Types

suspended

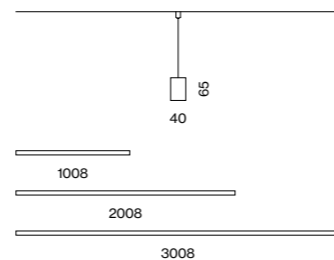

Colours



Light distribution



direct

Order options

COLOUR TEMPERATURE	
3000K	0
4000K	1

CONTROL

DALI-2

MATERIAL COLOUR

<input type="radio"/> pure white RAL 9010	7
<input checked="" type="radio"/> white aluminium RAL 9006	G
<input type="radio"/> jet black RAL 9005	8

LIGHT OPTIC COVER

opal high performance

Options on request

COLOUR RENDERING INDEX

CRI ≥ 98 XPECTRUM

COLOUR TEMPERATURE

tunable white 2700–6500 K

DALI-2 DT8

LIGHT OPTIC COVER

microprismatic

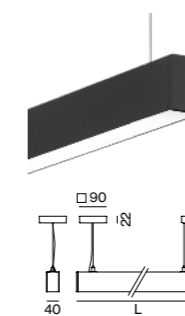

MINO 40 suspended



MID LUMEN

SYS. POWER	COLOUR TEMP.	LUM. FLUX	L (mm)	ORDER CODE
15.3W	3000K	1480lm	1008	0 4 2 - 1 2 1 2 :: 3 H
	4000K	1560lm		
30.5W	3000K	2950lm	2008	0 4 2 - 1 2 1 4 :: 3 H
	4000K	3120lm		
46W	3000K	4420lm	3008	0 4 2 - 1 2 1 6 :: 3 H
	4000K	4680lm		

HIGH LUMEN

SYS. POWER	COLOUR TEMP.	LUM. FLUX	L (mm)	ORDER CODE
22.9W	3000K	2210lm	1008	0 4 2 - 1 2 2 2 :: 3 H
	4000K	2340lm		
46W	3000K	4420lm	2008	0 4 2 - 1 2 2 4 :: 3 H
	4000K	4680lm		
69W	3000K	6630lm	3008	0 4 2 - 1 2 2 6 :: 3 H
	4000K	7030lm		

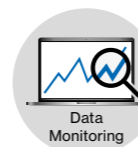

DiiA® standards
251, 252, 253



system
solution (p. 912)



tunable white
2700–6500 K

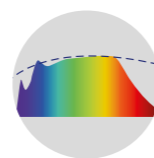

CRI ≥ 98
XPECTRUM

LUMINOUS FLUX value calculated for
CRI ≥ 90, colour white, cover opal

Sparkasse Lienz, AT –
by DI Matthias Viehhauser





MME
Zug, CH –
by Büronauten AG



Sparkasse, Bank
Nuremberg, DE –
by baum-kappler architekten



[← back](#)

MINO 60

surface

EN Luminaire housing from extruded aluminium profile, angular design; no visible screws; surface powder coated; luminaire profile for mounting available in advance; remaining luminaire components mounted without tools; light inset consisting of highly reflective coated extruded profile for improved thermal management; HPO (High Performance Opal) cover for uniform illumination; micro prismatic PMMA diffuser incl. diffuser film for homogeneous illumination and reduced luminance; energy-efficient LEDs with very good colour rendering

DE Leuchtenkörper aus Aluminiumstrangpressprofil, kantige Ausführung; keine sichtbaren Schrauben; Oberfläche pulverbeschichtet; Leuchtenprofil für Montage vorab lieferbar; restliche Leuchtenkomponenten werkzeuglos montierbar; Lichteinsatz bestehend aus hochreflektierend lackiertem Strangpressprofil für verbessertes Thermomanagement; HPO (High Performance Opal) Abdeckung für homogene Ausleuchtung; mikroprismatische PMMA-Abdeckung inkl. Diffusorfolie zur Reduktion der Leuchtdichte bei homogener Ausleuchtung; energieeffiziente LEDs mit sehr guter Farbwiedergabe

Quickinfo

3000K, 4000K
 CRI ≥ 80, 3 SDCM
 up to 125lm/W
 L90 @ 50 000h
 non DIM, DALI-2
 opal, microprismatic (UGR ≤ 19)

Types

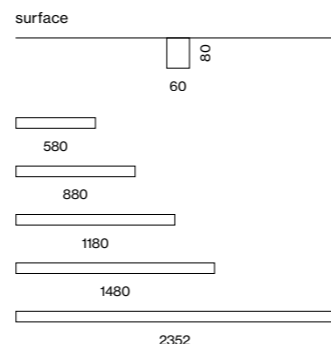

Colours



Light distribution



direct

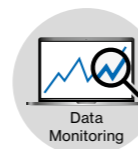

DiiA® standards
251, 252, 253

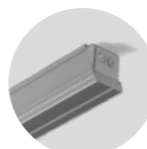

concrete install.
housing (p.946)

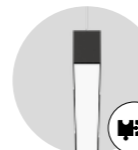

system
solution (p.914)

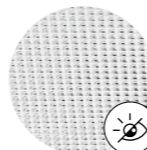

microprismatic
UGR ≤ 19



tunable white
2700–6500K

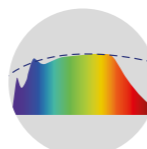

CRI ≥ 98
XPECTRUM

Order options

COLOUR TEMPERATURE	
3000K	5
4000K	6

CONTROL	
non DIM	1
DALI-2	3

MATERIAL COLOUR	
<input type="radio"/> pure white RAL 9010	7
<input checked="" type="radio"/> white aluminium RAL 9006	G
<input type="radio"/> jet black RAL 9005	8

LIGHT OPTIC COVER	
opal high performance	H
microprismatic	Z
microprismatic (UGR ≤ 19)*	G

*UGR ≤ 19 only with mid lumen

Options on request

COLOUR RENDERING INDEX	
CRI ≥ 90	
CRI ≥ 98 XPECTRUM	

COLOUR TEMPERATURE	
tunable white 2700–6500K	
DALI-2 DT8	

INDIVIDUAL MATERIAL COLOUR	
<input checked="" type="radio"/> MINO 60 ceiling system	

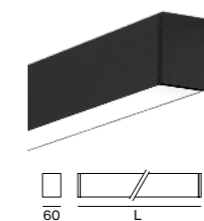

MINO 60 surface



MID LUMEN

SYS. POWER	COLOUR TEMP.	LUM. FLUX	L (mm)	ORDER CODE
8.7W	3000K	902lm	580	0 4 6 - 4 1 L 2 :: 1 <input type="checkbox"/>
	4000K	955lm		
13W	3000K	1350lm	880	0 4 6 - 4 1 L 3 :: 1 <input type="checkbox"/>
	4000K	1430lm		
15.3W	3000K	1800lm	1180	0 4 6 - 4 1 L 4 :: 1 <input type="checkbox"/>
	4000K	1910lm		
19.2W	3000K	2250lm	1480	0 4 6 - 4 1 L 5 :: 1 <input type="checkbox"/>
	4000K	2390lm		
31W	3000K	3610lm	2352	0 4 6 - 4 1 L 8 :: 1 <input type="checkbox"/>
	4000K	3820lm		

HIGH LUMEN

SYS. POWER	COLOUR TEMP.	LUM. FLUX	L (mm)	ORDER CODE
13.8W	3000K	1490lm	580	0 4 6 - 4 1 M 2 :: <input type="checkbox"/>
	4000K	1580lm		
20.6W	3000K	2240lm	880	0 4 6 - 4 1 M 3 :: <input type="checkbox"/>
	4000K	2370lm		
27.5W	3000K	2980lm	1180	0 4 6 - 4 1 M 4 :: <input type="checkbox"/>
	4000K	3160lm		
34W	3000K	3730lm	1480	0 4 6 - 4 1 M 5 :: <input type="checkbox"/>
	4000K	3950lm		
55W	3000K	5970lm	2352	0 4 6 - 4 1 M 8 :: <input type="checkbox"/>
	4000K	6320lm		

LUMINOUS FLUX value calculated for
 CRI ≥ 80, colour white, cover opal
 microprism. Z -13%, microprism. G -15%

Aros Forsikring-Mutual Insurance
Viby J, DK – lighting design by
anker & co



← back



MINO 60

suspended

EN Luminaire housing from extruded aluminium profile, angular design; no visible screws; surface powder coated; luminaire profile for mounting available in advance; remaining components mounted without tools; pendant fitting with cable suspension; with integrated tool-less suspension height adjustment; spring clip attachment to the luminaire; freely positionable; with transparent feeder cable; light inset consisting of highly reflective coated extruded profile for improved thermal management; HPO (High Performance Opal) cover for uniform illumination; micro prismatic PMMA diffuser incl. diffuser film for homogeneous illumination and reduced luminance; energy-eff. LEDs – very good colour rendering

DE Leuchtenkörper aus Aluminiumstrangpressprofil, kantige Ausführung; keine sichtbaren Schrauben; Oberfläche pulverbeschichtet; Leuchtenprofil für Montage vorab lieferbar; restl. Komponenten werkzeuglos montierbar; abgependelt mit Seilabhängung; werkzeuglose Höhenverstellung an der Leuchte; Befestigung an der Leuchte mittels Federclips; frei positionierbar; inkl. transp. Einspeiseleitung; Lichteinsatz bestehend aus hochreflektierend lackiertem Strangpressprofil für verbessertes Thermomanagement; HPO (High Performance Opal) Abdeckung für homogene Ausleuchtung; mikroprismatische PMMA-Abdeckung inkl. Diffusorfolie zur Reduktion der Leuchtdichte bei homogener Ausleuchtung; energieeff. LEDs – sehr gute Farbwiedergabe

Quickinfo

3000K, 4000K
 CRI ≥ 80, 3 SDCM
 up to 125lm/W
 L90 @ 50 000h
 non DIM, DALI-2
 opal, microprismatic (UGR ≤ 19)

Types

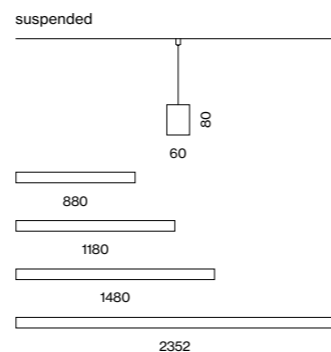

Colours



Light distribution



direct

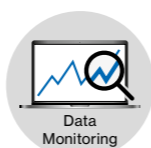

Data Monitoring
 DiiA® standards
 251, 252, 253

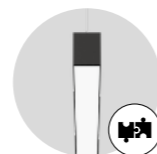

system
 solution (p.914)

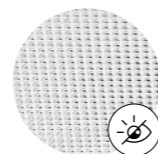

microprismatic
 solution UGR ≤ 19

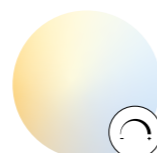

tunable white
 2700–6500K

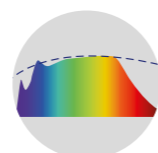

CRI ≥ 98
 XPECTRUM

Order options

COLOUR TEMPERATURE	
3000K	5
4000K	6

CONTROL	
non DIM	1
DALI-2	3

MATERIAL COLOUR	
○ pure white RAL 9010	7
● white aluminium RAL 9006	G
● jet black RAL 9005	8

LIGHT OPTIC COVER	
opal high performance	H
microprismatic	Z
microprismatic (UGR ≤ 19)*	G

*UGR ≤ 19 only with mid lumen

Options on request

COLOUR RENDERING INDEX	
CRI ≥ 90	
CRI ≥ 98 XPECTRUM	

COLOUR TEMPERATURE	
tunable white 2700–6500K	
DALI-2 DT8	

INDIVIDUAL MATERIAL COLOUR	
● MINO 60 suspended system	

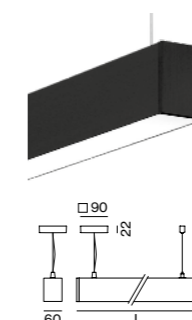

MINO 60 suspended



MID LUMEN

SYS. POWER	COLOUR TEMP.	LUM. FLUX	L (mm)	ORDER CODE
13W	3000K	1350lm	880	0 4 6 - 4 2 L 3 :: 1 ▣ □
	4000K	1430lm		
15.3W	3000K	1800lm	1180	0 4 6 - 4 2 L 4 :: 1 ▣ □
	4000K	1910lm		
19.2W	3000K	2250lm	1480	0 4 6 - 4 2 L 5 :: 1 ▣ □
	4000K	2390lm		
31W	3000K	3610lm	2352	0 4 6 - 4 2 L 8 :: 1 ▣ □
	4000K	3820lm		

HIGH LUMEN

SYS. POWER	COLOUR TEMP.	LUM. FLUX	L (mm)	ORDER CODE
20.6W	3000K	2240lm	880	0 4 6 - 4 2 M 3 :: ▣ ▣ □
	4000K	2370lm		
27.5W	3000K	2980lm	1180	0 4 6 - 4 2 M 4 :: ▣ ▣ □
	4000K	3160lm		
34W	3000K	3730lm	1480	0 4 6 - 4 2 M 5 :: ▣ ▣ □
	4000K	3950lm		
55W	3000K	5970lm	2352	0 4 6 - 4 2 M 8 :: ▣ ▣ □
	4000K	6320lm		

Technical data

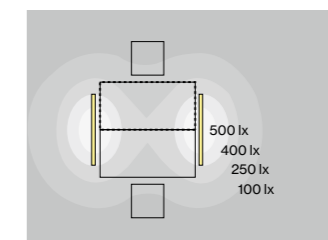

MINO 60 suspended, 15.3W, 4000K, direct

ROOM VALUES	
Room dimensions	5.4 × 4 × 2.8m
Reflection factor	0.7 0.5 0.2
Maintenance factor	0.8
Suspension height	2.25m

CALCULATION SURFACE	
Surface dimensions	1.6 × 0.8m
Surface height	0.75m
Average illuminance (E _{av})	> 500lx
Uniformity (U ₀)	> 0.6



GLARE EVALUATION	
Table Classification	X=4H Y=8H S=0.25H
UGR transversal	≤ 19
UGR axial	≤ 19

LUMINOUS FLUX value calculated for CRI ≥ 80, colour white, cover opal microprism. Z -13%, microprism. G -15%

HeidelbergCement AG Heidelberg, DE –
by Albert Speer + Partner Architekten with
lighting design by Hailight Lichtplanung,
Andreas Haidegger



← back



MINO 100

surface

EN Luminaire housing from extruded aluminium profile, angular design; no visible screws; surface powder coated; luminaire profile for mounting available in advance; remaining luminaire components mounted without tools; light inset consisting of highly reflective coated extruded profile for improved thermal management; HPO (High Performance Opal) cover for uniform illumination; micro prismatic PMMA diffuser incl. diffuser film for homogeneous illumination and reduced luminance; energy-efficient LEDs with very good colour rendering

DE Leuchtenkörper aus Aluminiumstrangpressprofil, kantige Ausführung; keine sichtbaren Schrauben; Oberfläche pulverbeschichtet; Leuchtenprofil für Montage vorab lieferbar; restliche Leuchtenkomponenten werkzeuglos montierbar; Lichteinsatz bestehend aus hochreflektierend lackiertem Strangpressprofil für verbessertes Thermomanagement; HPO (High Performance Opal) Abdeckung für homogene Ausleuchtung; mikroprismatische PMMA-Abdeckung inkl. Diffusorfolie zur Reduktion der Leuchtdichte bei homogener Ausleuchtung; energieeffiziente LEDs mit sehr guter Farbwiedergabe

Quickinfo

3000K, 4000K
 CRI ≥ 80, 3 SDCM
 UGR ≤ 19 / 65° ≤ 3000 cd/m²
 up to 7070 lm
 up to 140 lm/W
 L90 @ 50 000h
 non DIM, DALI-2
 opal, microprismatic (UGR ≤ 19)

Types

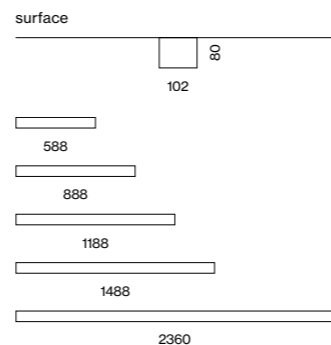

Colours



Light distribution

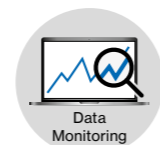

DiiA® standards
251, 252, 253

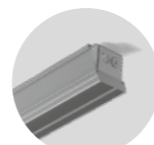

concrete install.
housing (p. 946)

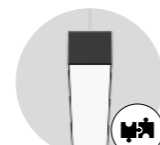

system
solution (p. 928)



DIN EN 12464-1
UGR ≤ 19

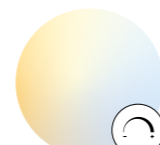

tunable white
2700–6500K

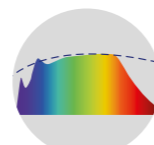

CRI ≥ 98
XPECTRUM

Order options

COLOUR TEMPERATURE	
3000K	5
4000K	6

CONTROL	
non DIM	1
DALI-2	3

MATERIAL COLOUR	
○ pure white RAL 9010	7
● white aluminium RAL 9006	G
● jet black RAL 9005	8

LIGHT OPTIC COVER	
opal high performance	H
microprismatic	Z
microprismatic (UGR ≤ 19)	G

Options on request

COLOUR RENDERING INDEX	
CRI ≥ 90	
CRI ≥ 98 XPECTRUM	

COLOUR TEMPERATURE	
tunable white 2700–6500K	
DALI-2 DT8	

INDIVIDUAL MATERIAL COLOUR	
● MINO 100 ceiling system	

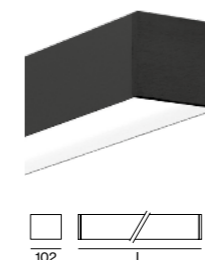

MINO 100 surface



MID LUMEN

SYS. POWER	COLOUR TEMP.	LUM. FLUX	L (mm)	ORDER CODE
8.7W	3000K	1010lm	588	0 5 6 - 4 1 L 2 :: 1
	4000K	1070lm		
13W	3000K	1520lm	888	0 5 6 - 4 1 L 3 :: 1
	4000K	1600lm		
15.3W	3000K	2020lm	1188	0 5 6 - 4 1 L 4 :: 1
	4000K	2140lm		
19.2W	3000K	2530lm	1488	0 5 6 - 4 1 L 5 :: 1
	4000K	2670lm		
31W	3000K	4040lm	2360	0 5 6 - 4 1 L 8 :: 1
	4000K	4280lm		

HIGH LUMEN

SYS. POWER	COLOUR TEMP.	LUM. FLUX	L (mm)	ORDER CODE
13.8W	3000K	1670lm	588	0 5 6 - 4 1 M 2 :: 1
	4000K	1770lm		
20.6W	3000K	2510lm	888	0 5 6 - 4 1 M 3 :: 1
	4000K	2650lm		
27.5W	3000K	3340lm	1188	0 5 6 - 4 1 M 4 :: 1
	4000K	3540lm		
34W	3000K	4180lm	1488	0 5 6 - 4 1 M 5 :: 1
	4000K	4420lm		
55W	3000K	6680lm	2360	0 5 6 - 4 1 M 8 :: 1
	4000K	7070lm		

LUMINOUS FLUX value calculated for CRI ≥ 80, colour white, cover opal microprism. Z -8%, microprism. G -10%

← back

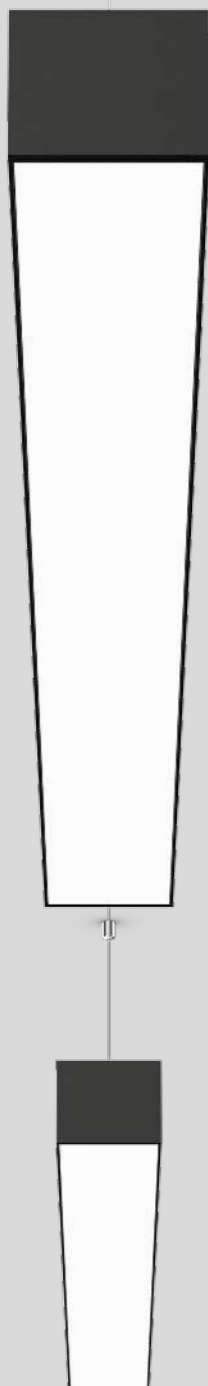

MINO 100

suspended

EN Luminaire housing from extruded aluminium profile, angular design; no visible screws; surface powder coated; luminaire profile for mounting available in advance; remaining components mounted without tools; pendant fitting with cable suspension; with integrated tool-less suspension height adjustment; spring clip attachment to the luminaire; freely positionable; with transparent feeder cable; light inset consisting of highly reflective coated extruded profile for improved thermal management; HPO (High Performance Opal) cover for uniform illumination; micro prismatic PMMA diffuser incl. diffuser film for homogeneous illumination and reduced luminance; energy-eff. LEDs – very good colour rendering

DE Leuchtenkörper aus Aluminiumstrangpressprofil, kantige Ausführung; keine sichtbaren Schrauben; Oberfläche pulverbeschichtet; Leuchtenprofil für Montage vorab lieferbar; restl. Komponenten werkzeuglos montierbar; abgependelt mit Seilabhängung; werkzeuglose Höhenverstellung an der Leuchte; Befestigung an der Leuchte mittels Federclips; frei positionierbar; inkl. transp. Einspeiseleitung; Lichteinsatz bestehend aus hochreflektierend lackiertem Strangpressprofil für verbessertes Thermomanagement; HPO (High Performance Opal) Abdeckung für homogene Ausleuchtung; mikroprismatische PMMA-Abdeckung inkl. Diffusorfolie zur Reduktion der Leuchtdichte bei homogener Ausleuchtung; energieeff. LEDs – sehr gute Farbwiedergabe

Quickinfo

3000K, 4000K
 CRI ≥ 80, 3 SDCM
 UGR ≤ 19 / 65° ≤ 3000 cd/m²
 up to 140 lm/W
 L90 @ 50 000h
 non DIM, DALI-2
 opal, microprismatic (UGR ≤ 19)

Types

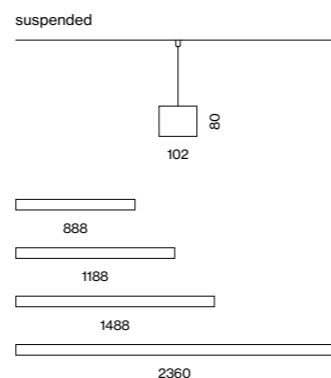

Colours



Light distribution

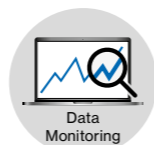

DiiA® standards
 251, 252, 253

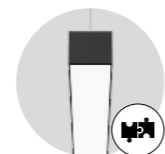

system
 solution (p.928)



DIN EN 12464-1
 UGR ≤ 19

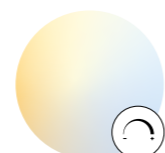

tunable white
 2700–6500K

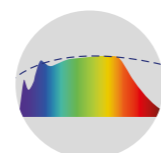

CRI ≥ 98
 XPECTRUM

Order options

COLOUR TEMPERATURE	
3000K	5
4000K	6

CONTROL	
non DIM	1
DALI-2	3

MATERIAL COLOUR	
○ pure white RAL 9010	7
● white aluminium RAL 9006	G
● jet black RAL 9005	8

LIGHT OPTIC COVER	
opal high performance	H
microprismatic	Z
microprismatic (UGR ≤ 19)	G

Options on request

COLOUR RENDERING INDEX	
CRI ≥ 90	
CRI ≥ 98 XPECTRUM	

COLOUR TEMPERATURE	
tunable white 2700–6500K	
DALI-2 DT8	

INDIVIDUAL MATERIAL COLOUR	
● MINO 100 suspended system	

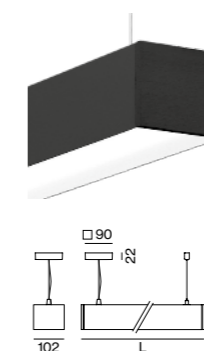

MINO 100 suspended



SYS. POWER	COLOUR TEMP.	LUM. FLUX	L (mm)	ORDER CODE
13W	3000K	1520lm	888	056-42L3::1
	4000K	1600lm		
15.3W	3000K	2020lm	1188	056-42L4::1
	4000K	2140lm		
19.2W	3000K	2530lm	1488	056-42L5::1
	4000K	2670lm		
31W	3000K	4040lm	2360	056-42L8::1
	4000K	4280lm		

SYS. POWER	COLOUR TEMP.	LUM. FLUX	L (mm)	ORDER CODE
20.6W	3000K	2510lm	888	056-42M3::1
	4000K	2650lm		
27.5W	3000K	3340lm	1188	056-42M4::1
	4000K	3540lm		
34W	3000K	4180lm	1488	056-42M5::1
	4000K	4420lm		
55W	3000K	6680lm	2360	056-42M8::1
	4000K	7070lm		

Technical data

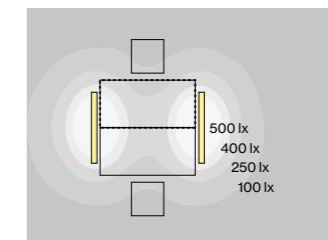

MINO 100 suspended, 15.3W, 4000K, direct

ROOM VALUES	
Room dimensions	5.4 × 4 × 2.8m
Reflection factor	0.7 0.5 0.2
Maintenance factor	0.8
Suspension height	2.25m

CALCULATION SURFACE	
Surface dimensions	1.6 × 0.8m
Surface height	0.75m
Average illuminance (E _{av})	> 500 lx
Uniformity (U ₀)	> 0.6



GLARE EVALUATION	
Table Classification X=4H Y=8H S=0.25H	
UGR transversal	≤ 19
UGR axial	≤ 19
≥ 65° ≤ 3000 cd/m²	

LUMINOUS FLUX value calculated for CRI ≥ 80, colour white, cover opal microprism. Z -8%, microprism. G -10%

Outside with profile



BASO IP54

EN BASO IP54 is a powerful profile luminaire that has been specially adapted to demanding environmental conditions: from public outdoor areas to wet rooms. It has increased dust and insect protection (IP54). BASO IP54 is available as a single luminaire or as a system variant. It is easy to install and suitable for recessed or surface fitting as well as for wall or ceiling mounting. An opal cover delivers homogeneous basic illumination. The luminaire has a colour rendering of up to $\text{CRI} \geq 98$ XPECTRUM and can be selected with a dark grey or white housing and in two light colours (3000K and 4000K).

DE BASO IP54 ist eine leistungsstarke Profilleuchte, die speziell an fordernde Umgebungsbedingungen angepasst wurde: von öffentlichen Outdoor-Bereichen bis hin zu Nassräumen. Zudem verfügt sie über einen erhöhten Staub- und Insektenschutz (IP54). BASO IP54 ist als Einzeilleuchte oder als Systemvariante verfügbar, einfach zu montieren und sowohl für Ein- oder Anbau als auch für Wand- oder Deckenmontage geeignet. Eine Opal-Abdeckung sorgt für homogene Grundausleuchtung. Außerdem verfügt die Leuchte über eine Farbwiedergabe von bis zu $\text{CRI} \geq 98$ XPECTRUM und kann mit dunkelgrauem oder weißem Gehäuse sowie in zwei Lichtfarben (3000K und 4000K) gewählt werden.

Type



60

Mountings

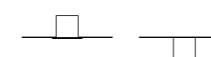
trim
recessed

surface

Light distribution

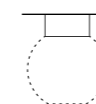

opal

back



BASO 60 IP54

recessed with trim

EN Luminaire housing made of extruded aluminium; recessed luminaire with trim; suitable for ceiling thickness of 8-20 mm; surface powder coated; suitable for wall or ceiling mounting; luminaire profile (end caps come pre-assembled) can be pre-mounted; remaining luminaire components mounted without tools; closed light insert made of PMMA, consisting of converter unit and circuit board unit; light inset with screwed-on, thus maintenance-friendly, transparent end cap in PMMA; HPO (High Performance Opal) cover for uniform illumination; energy-efficient LEDs with very good colour rendering; IP67 socket connector system for easy and sealed electrical connection

DE Leuchtenkörper aus Aluminiumstrangpressprofil; Einbauleuchte mit umlaufendem Rand; geeignet für Deckenstärken von 8-20 mm; Oberfläche pulverbeschichtet; geeignet für Wand- oder Deckenmontage; Leuchtenprofil (Enddeckel werkseitig vormontiert) vorab montierbar; restliche Leuchtenkomponenten werkzeuglos montierbar; geschlossener Lichteinsatz aus PMMA, bestehend aus Konvertereinheit und Platineneinheit; Lichteinsatz mit verschraubtem, dadurch wartungsfreundlichen, transparenten PMMA Enddeckel; HPO (High Performance Opal) Abdeckung für homogene Ausleuchtung; energieeffiziente LEDs mit sehr guter Farbwiedergabe; IP67-Buchsen-Steckersystem für dichten elektrischen Anschluss

Quickinfo

3000K, 4000K
CRI ≥ 80, 3 SDCM
up to 125lm/W
L90 @ 50 000h
DALI-2
opal, IP 54

Types

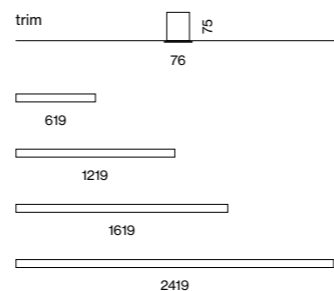

Colours



Light distribution



direct

Order options

IP RATING

IP54

COLOUR TEMPERATURE

3000K	5
4000K	6

CONTROL

DALI-2

MATERIAL COLOUR

<input type="radio"/> traffic white RAL 9016	7
<input checked="" type="radio"/> umbra grey RAL 7022	D

LIGHT OPTIC COVER

opal high performance

Options on request

COLOUR RENDERING INDEX

CRI ≥ 90
CRI ≥ 98 XPECTRUM

LUMINOUS FLUX value calculated for CRI ≥ 80, colour white, cover opal

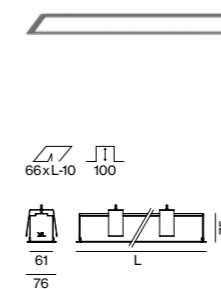

BASO 60 trim



IP 54 LUMINAIRE

SYS. POWER	COLOUR TEMP.	LUM. FLUX	L (mm)	ORDER CODE
11.2W	3000K	1320lm	619	8 4 5 - 3 5 2 2 :: 3 H
22.4W	4000K	1400lm		8 4 5 - 3 5 2 4 :: 3 H
29.9W	3000K	2640lm	1219	8 4 5 - 3 5 2 4 :: 3 H
	4000K	2790lm		8 4 5 - 3 5 2 5 :: 3 H
45W	3000K	3530lm	1619	8 4 5 - 3 5 2 5 :: 3 H
	4000K	3720lm		8 4 5 - 3 5 2 8 :: 3 H
	3000K	5290lm	2419	8 4 5 - 3 5 2 8 :: 3 H
	4000K	5590lm		8 4 5 - 3 5 2 8 :: 3 H

Mounting accessories

CONCRETE INSTALLATION HOUSING

L-W-H (mm)	ORDER CODE
662-75-88	0 4 5 - 3 5 9 2 0 1 0
1262-75-88	0 4 5 - 3 5 9 4 0 1 0
1662-75-88	0 4 5 - 3 5 9 5 0 1 0
2462-75-88	0 4 5 - 3 5 9 8 0 1 0



quick
installation

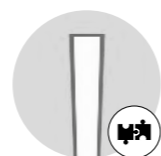

system
solution (p.936)



dust & splash water
protection (IP54)

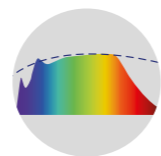

CRI ≥ 98
XPECTRUM

Private Residence Plane House
Skiathos, GR – by K-Studio



ÖBB passage Graz, AT –
by skyline architekten ZT gmbh with lighting design
by ESC engineering Service & Consulting kg



← back



BASO 60 IP54

surface

EN Luminaire housing from extruded aluminium profile, angular design; light-tight end caps in aluminium, no visible screws; surface powder coated; suitable for wall or ceiling mounting; luminaire profile (end caps come pre-assembled) can be pre-mounted; remaining luminaire components mounted without tools; closed light insert made of PMMA, consisting of converter unit and circuit board unit; light inset with screwed-on, thus maintenance-friendly, transparent end cap in PMMA; HPO (High Performance Opal) cover for uniform illumination; energy-efficient LEDs with very good colour rendering; IP67 socket connector system for easy and sealed electrical connection

DE Leuchtenkörper aus Aluminiumstrangpressprofil, kantige Ausführung; lichtdicht abschließende Enddeckel aus Aluminium, keine sichtbaren Schrauben; Oberfläche pulverbeschichtet; geeignet für Wand- oder Deckenmontage; Leuchtenprofil (Enddeckel werkseitig vormontiert) vorab montierbar; restliche Leuchtenkomponenten werkzeuglos montierbar; geschlossener Lichteinsatz aus PMMA, bestehend aus Konvertereinheit und Platineneinheit; Lichteinsatz mit verschraubtem, dadurch wartungsfreundlichen, transparenten PMMA Enddeckel; HPO (High Performance Opal) Abdeckung für homogene Ausleuchtung; energieeffiziente LEDs mit sehr guter Farbwiedergabe; IP67-Buchsen-Stecker-system für dichten elektrischen Anschluss

Quickinfo

3000K, 4000K
 CRI ≥ 80, 3 SDCM
 up to 125lm/W
 L90 @ 50 000h
 DALI-2
 opal, IP 54

Types

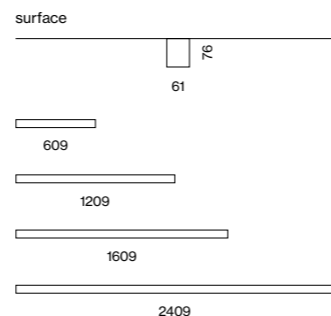

Colours



Light distribution



Order options

IP RATING

IP54

COLOUR TEMPERATURE

3000K	5
4000K	6

CONTROL

DALI-2

MATERIAL COLOUR

- traffic white RAL 9016 7
- umbra grey RAL 7022 D

LIGHT OPTIC COVER

opal high performance

Options on request

COLOUR RENDERING INDEX

CRI ≥ 90
 CRI ≥ 98 XPECTRUM

MOUNTING

concrete installation housing

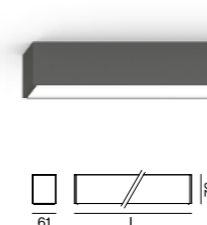

BASO 60 surface



IP 54 LUMINAIRE

SYS. POWER	COLOUR TEMP.	LUM. FLUX	L (mm)	ORDER CODE
11.2W	3000K	1320lm	609	8 4 5 - 4 1 2 2 :: 3 H
	4000K	1400lm		
22.4W	3000K	2640lm	1209	8 4 5 - 4 1 2 4 :: 3 H
	4000K	2790lm		
29.9W	3000K	3530lm	1609	8 4 5 - 4 1 2 5 :: 3 H
	4000K	3720lm		
45W	3000K	5290lm	2409	8 4 5 - 4 1 2 8 :: 3 H
	4000K	5590lm		

quick installation

system solution (p.940)

dust & splash water protection (IP54)

CRI ≥ 98 XPECTRUM

LUMINOUS FLUX value calculated for CRI ≥ 80, colour white, cover opal

University Research Institute
Ulm, DE – by bizer architekten



Perfect allrounder

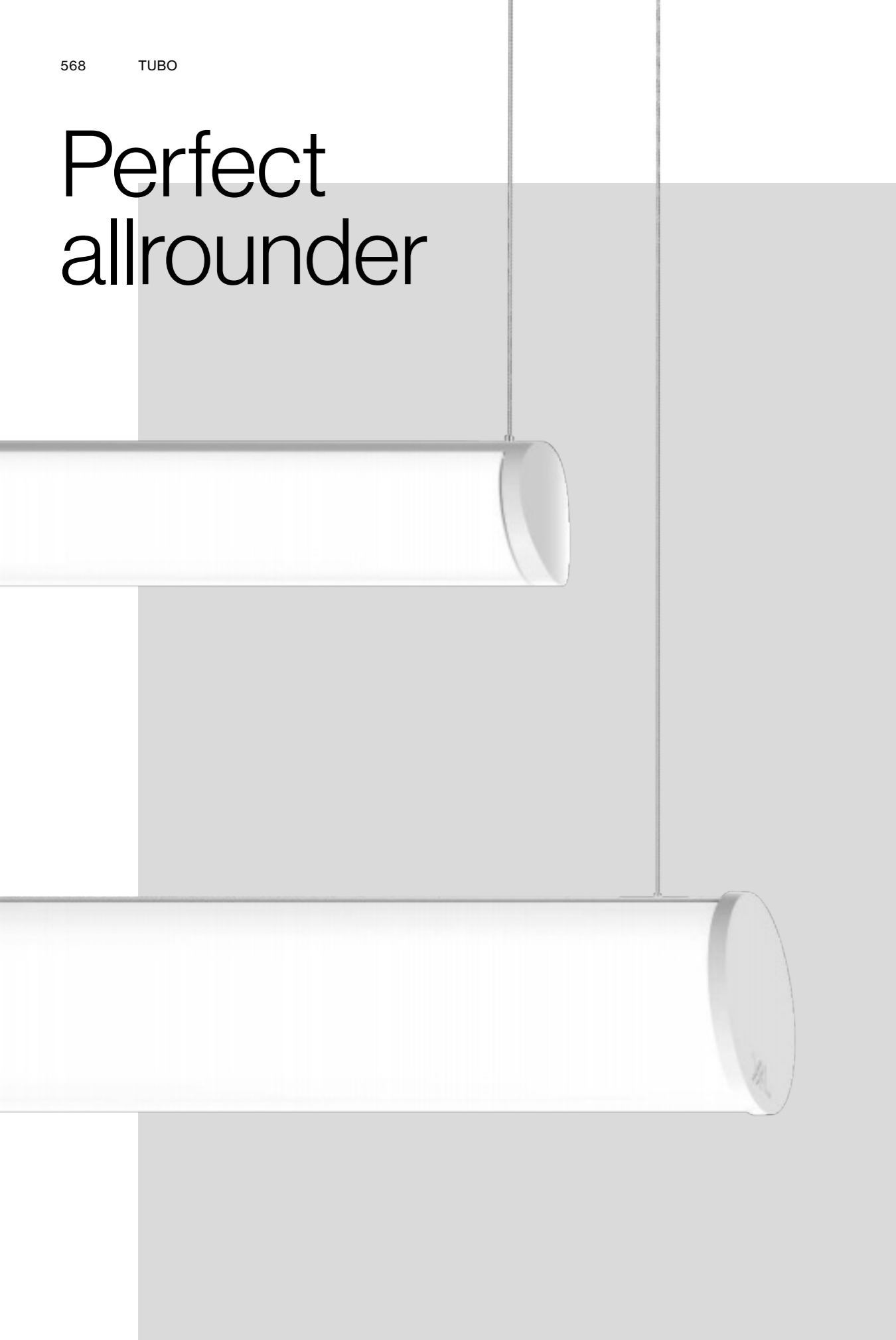

TUBO

EN TUBO places no limits on creativity. Thanks to the height-adjustable cable suspension, the luminaire is particularly popular combined with other TUBO single luminaires for fancy patterns or creative arrangements. Maximum design freedom goes hand in hand with a pleasant room ambiance, as TUBO's characteristic beam angle of up to 340° provides gentle ceiling illumination. TUBO can be used as a pendant luminaire, or as a surface-mounted version for walls and ceilings. Especially in entrance areas, corridors, and public spaces, the luminaire with light colours 3000 K or 4000 K and opal cover provides homogeneous ambient lighting.

DE Mit TUBO sind der Kreativität keine Grenzen gesetzt. Die Leuchte wird dank der höhenverstellbaren Seilabhängung besonders gerne mit weiteren TUBO Einzeleuchten für ausgefallene Muster oder kreative Arrangements kombiniert. Die maximale Gestaltungsfreiheit geht mit angenehmer Raumatmosphäre einher, da der für die TUBO charakteristische Abstrahlwinkel von bis zu 340° eine sanfte Deckenaufhellung bewirkt. TUBO kann nicht nur als Pendelleuchte, sondern auch als Anbau-Variante für Wände und Decken eingesetzt werden. Vor allem in Eingangsbereichen, Korridoren und öffentlichen Bereichen sorgt die Leuchte mit den Lichtfarben 3000 K oder 4000 K sowie Opal-Cover für eine homogene Grundausleuchtung.

Types



60

100

Mountings

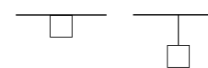

surface

suspended

Light distribution



opal

340° light distribution

EN With its 340° beam pattern and opal cover, TUBO delivers homogeneous illumination as well as slight ceiling brightening. This makes the luminaire perfect for places where a pleasant ambient lighting is desired, such as reception areas, corridors, or foyers.

DE Durch ihre 340° Abstrahlcharakteristik und Opal-Abdeckung erzielt TUBO eine homogene Beleuchtung sowie eine leichte Deckenaufhellung. Dadurch ist die Leuchte perfekt geeignet für Orte, an denen eine angenehme Grundausleuchtung gewünscht ist, wie Empfangsbereiche, Flure oder Foyers.

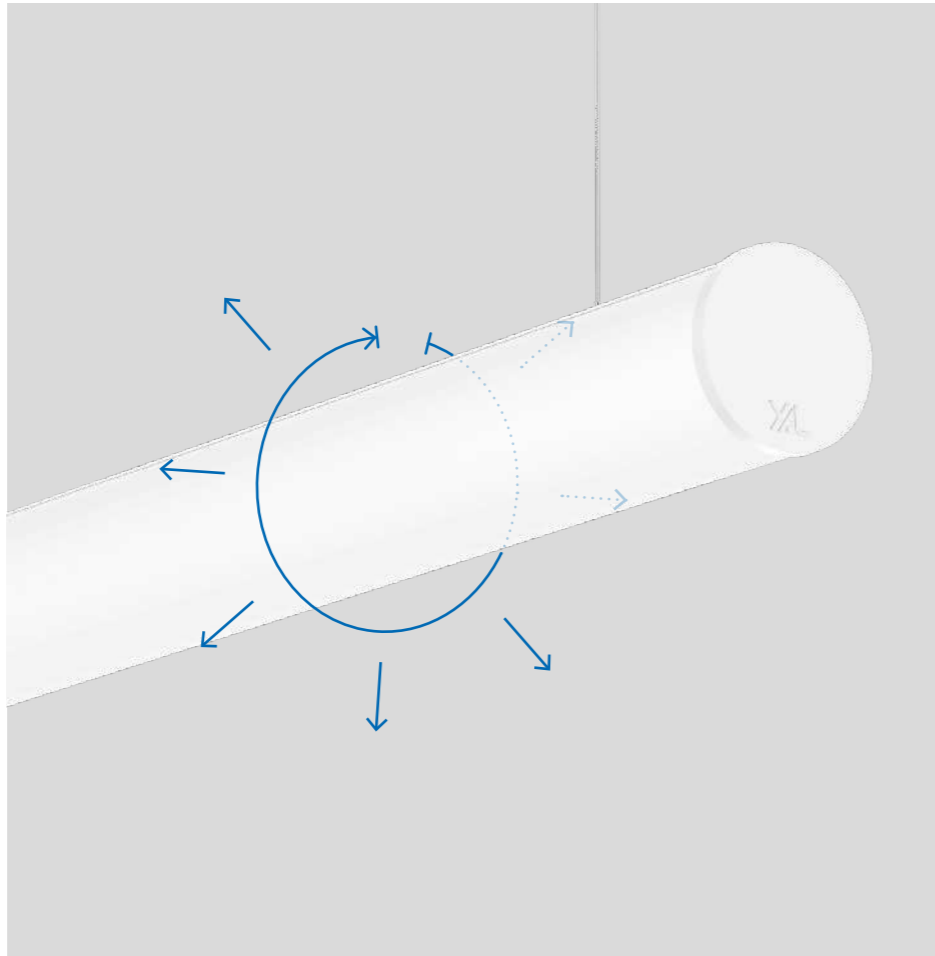

Bespoke arrangements

EN Mounting the pendant luminaire is highly flexible. The height-adjustable cable suspension with a joint allows TUBO to be suspended horizontally, or at an angle at different heights. The luminaire thus offers enormous creative freedom in designing bespoke patterns and unusual light formations.

DE Die Montage der Pendelleuchte ist höchst flexibel. Durch eine höhenverstellbare Seilabhängung mit Gelenk kann TUBO nicht nur horizontal, sondern auch schräg auf verschiedenen Höhen abgehängt werden. Dadurch bietet die Leuchte viel kreative Freiheit bei der Gestaltung individueller Muster und ausgefallener Lichtformationen.

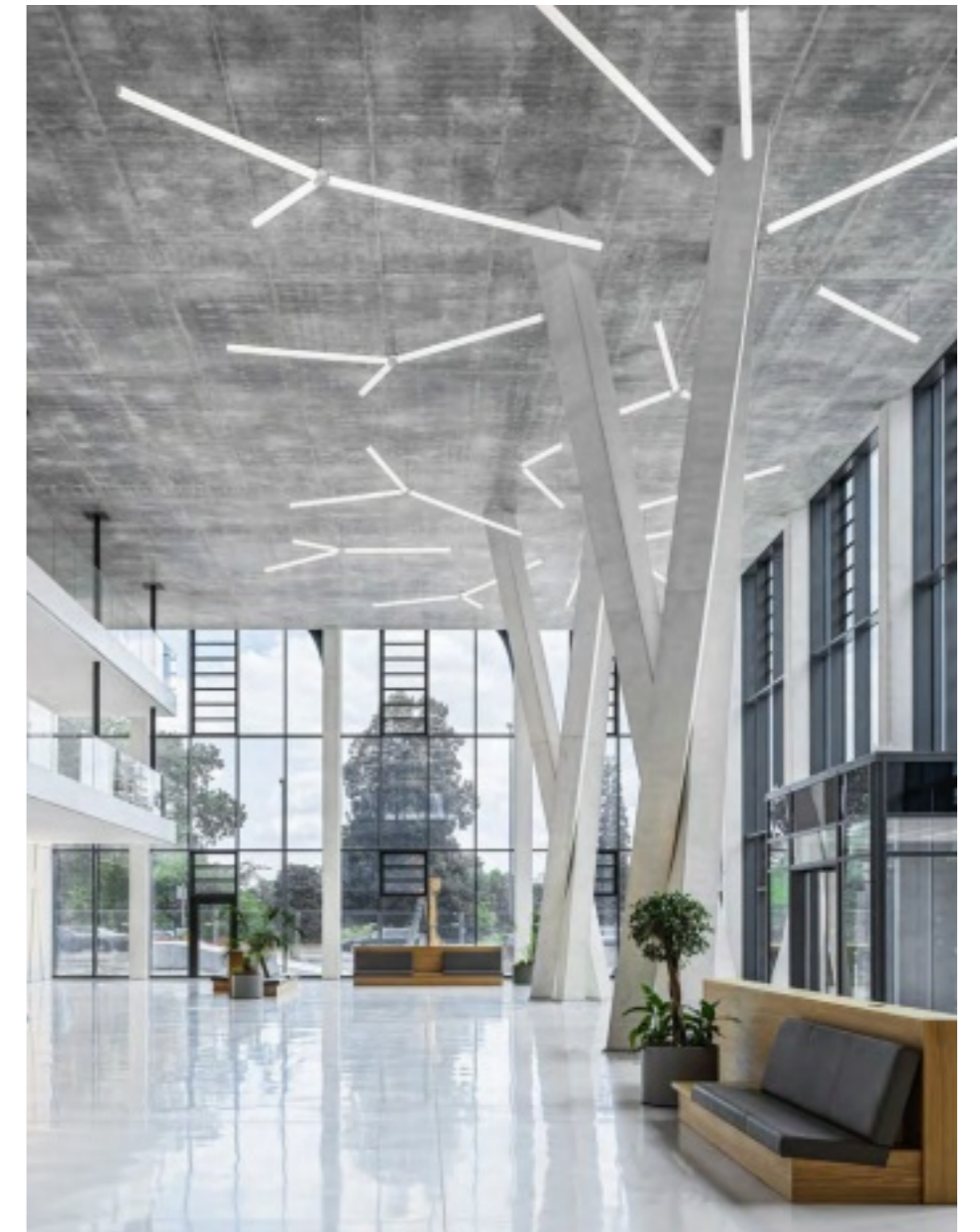

Mounting options

EN TUBO is available in both surface-mounted and pendant versions. It is suitable for mounting on ceilings and walls and supports a room's interior design.

DE TUBO ist sowohl in einer Anbau- als auch Pendelvariante erhältlich. Sie eignet sich für die Montage an der Decke ebenso wie an der Wand und unterstützt die innenarchitektonische Gestaltung des Raumes.



Quickinfo

3000K, 4000K
CRI ≥ 80, 3 SDCM
up to 114 lm/W
L90 @ 50 000h
non DIM, DALI-2
opal

Types

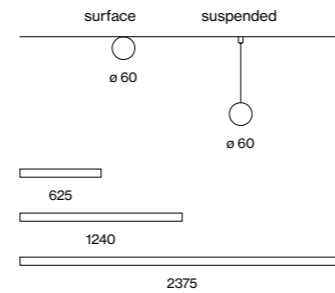

Colour



Light distributions



Order options

COLOUR TEMPERATURE	
3000K	5
4000K	6

CONTROL	
non DIM	1
DALI-2	3

MATERIAL COLOUR

pure white RAL 9010

LIGHT OPTIC COVER

opal

TUBO 60 surface

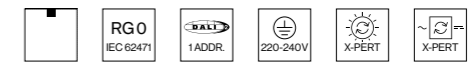

LUMINAIRE

SYS. POWER	COLOUR TEMP.	LUM. FLUX	L (mm)	ORDER CODE
16.5 W	3000K	1780 lm	625	0 5 8 - 3 1 1 2 :: 7 0
	4000K	1880 lm		
33 W	3000K	3560 lm	1240	0 5 8 - 3 1 1 4 :: 7 0
	4000K	3760 lm		
66 W	3000K	7110 lm	2375	0 5 8 - 3 1 1 8 :: 7 0
	4000K	7530 lm		

TUBO 60 suspended

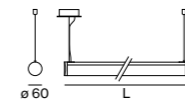
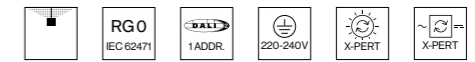

LUMINAIRE

SYS. POWER	COLOUR TEMP.	LUM. FLUX	L (mm)	ORDER CODE
16.5 W	3000K	1780 lm	625	0 5 8 - 3 2 1 2 :: 7 0
	4000K	1880 lm		
33 W	3000K	3560 lm	1240	0 5 8 - 3 2 1 4 :: 7 0
	4000K	3760 lm		
66 W	3000K	7110 lm	2375	0 5 8 - 3 2 1 8 :: 7 0
	4000K	7530 lm		



TUBO 60

surface / suspended

EN Supporting profile in extruded aluminium; end cap in aluminium; surface powder coated; suitable for wall or ceiling mounting (TUBO 60 surface); surface mounted or suspended luminaire with cable suspension; height adjustment without tools; with transparent feeder cable; light control via high-quality lens system for maximum, homogeneous illumination; completely homogeneously illuminated, cylindrical HPO (High Performance Opal) cover; energy-efficient LEDs with very good colour rendering

DE Tragprofil aus Aluminiumstrangpressprofil; Enddeckel aus Aluminium; Oberfläche pulverbeschichtet; geeignet für Wand- oder Deckenmontage (TUBO 60 surface); Anbau- bzw. Pendelleuchte mit Seilabhängung; werkzeuglose Höhenverstellung; inkl. transp. Einspeiseleitung; Lichtlenkung mittels hochwertiger Linsenoptik für maximale, homogene Ausleuchtung; absolut homogen ausgeleuchtete, zylindrische HPO (High Performance Opal) Abdeckung; energieeffiziente LEDs mit sehr guter Farbwiedergabe

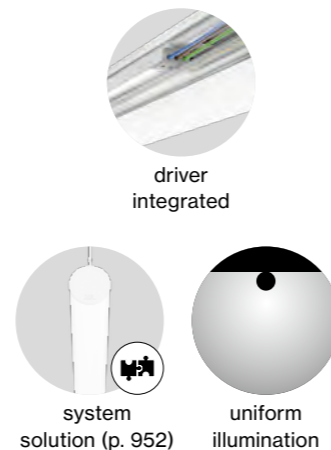

Light distribution

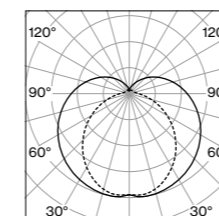

opal
direct

LUMINOUS FLUX value calculated for CRI ≥ 80, colour white, cover opal

Heidelberg Cement AG Heidelberg, DE –
by Albert Speer + Partner Architekten with lighting
design by Hailight Lichtplanung, Andreas Haidegger

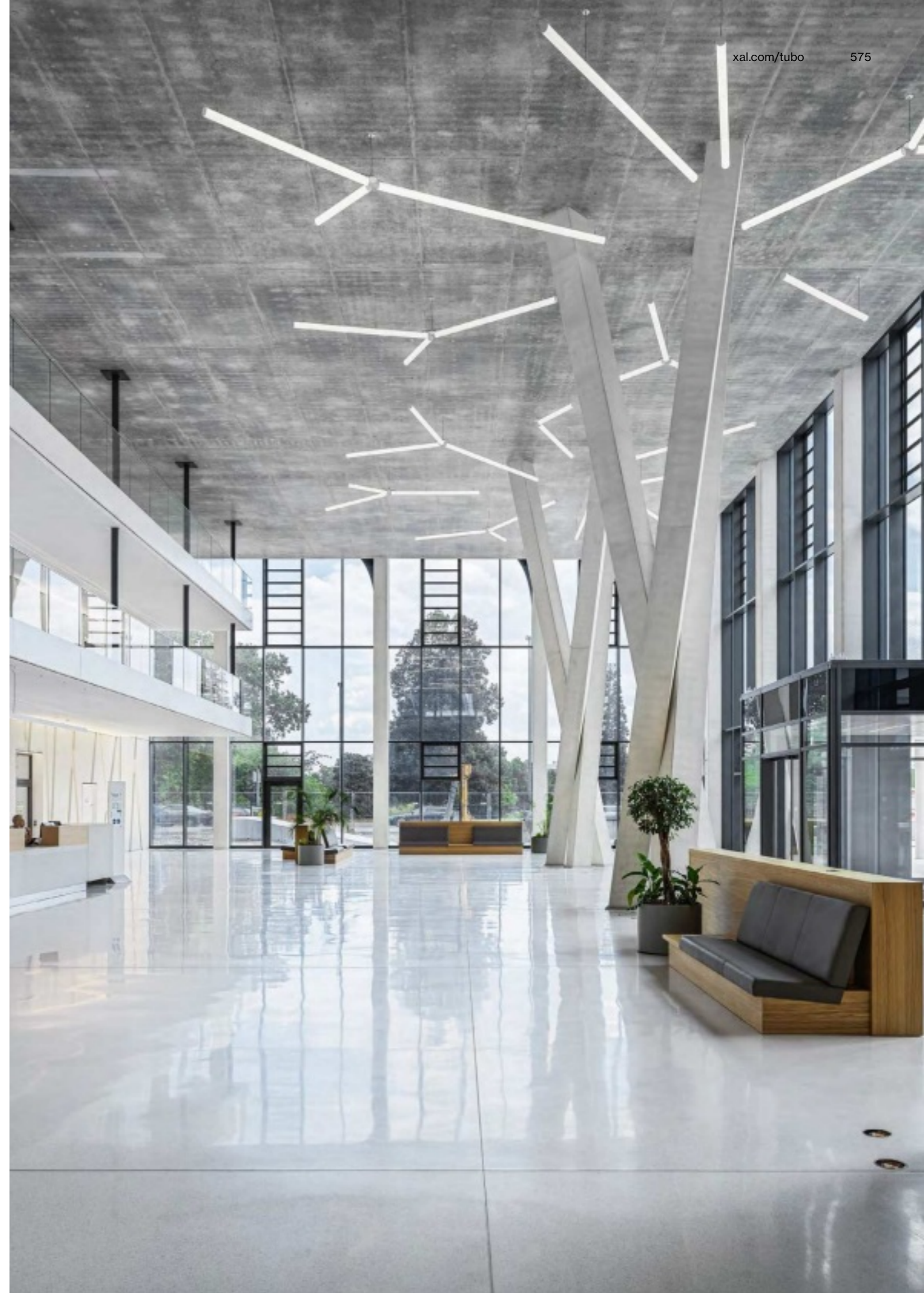



TUBO 100

surface / suspended

EN Supporting profile in extruded aluminium; end cap in aluminium, no visible screws; powder coated; suitable for wall or ceiling mounting (TUBO 100 surface); surface mounted or suspended luminaire with cable suspension; height adjustment without tools; spring clip attachment to the luminaire; freely positionable; with transparent feeder cable; luminaire profile for mounting available in advance; remaining components mounted without tools; light inset consisting of highly reflective coated extruded profile for improved thermal management; cylindrical cover made of satinised PMMA for homogeneous illumination; with 340° light emission and light ceiling illumination; energy-eff. LEDs – very good colour rendering

DE Tragprofil aus Aluminiumstrangpressprofil; Enddeckel aus Aluminium, keine sichtbaren Schrauben; pulverbeschichtet; geeignet für Wand- oder Deckenmontage (TUBO 100 surface); Anbau- bzw. Pendelleuchte mit Seilabhängung; werkzeuglose Höhenverstellung; Befestigung an der Leuchte mittels Federclips; frei positionierbar; inkl. transp. Einspeiseleitung; Leuchtenprofil für Montage vorab lieferbar; restl. Komponenten werkzeuglos montierbar; Lichteinsatz bestehend aus hochreflektierend lackiertem Strangpressprofil für verbessertes Thermomanagement; zylindrische Abdeckung aus satiniertem PMMA für homogene Ausleuchtung; mit 340° Lichtabstrahlung und leichter Deckenaufhellung; energieeff. LEDs – sehr gute Farbwiedergabe

Quickinfo

3000K, 4000K
CRI ≥ 80, 3 SDCM
up to 138lm/W
L90 @ 50 000h
non DIM, DALI-2
opal

Types

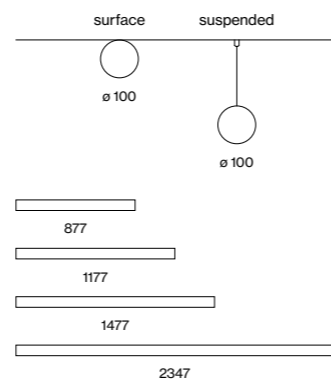

Colour



Light distributions



direct direct

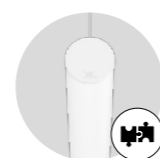

system
solution (p. 954)



uniform
illumination

Order options

COLOUR TEMPERATURE	
3000K	5
4000K	6

CONTROL	
non DIM	1
DALI-2	3

MATERIAL COLOUR

○ pure white RAL 9010

LIGHT OPTIC COVER

opal

Options on request

CONTROL

Casambi



TUBO 100 surface

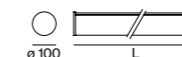
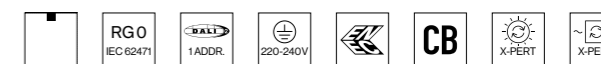

LUMINAIRE

SYS. POWER	COLOUR TEMP.	LUM. FLUX	L (mm)	ORDER CODE
27.5 W	3000K	3580lm	877	058-1133::70
	4000K	3790lm		
37 W	3000K	4770lm	1177	058-1134::70
	4000K	5050lm		
46 W	3000K	5960lm	1477	058-1135::70
	4000K	6310lm		
73 W	3000K	9540lm	2347	058-1138::70
	4000K	10100lm		



TUBO 100 suspended

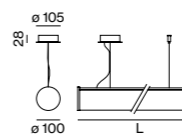

LUMINAIRE

SYS. POWER	COLOUR TEMP.	LUM. FLUX	L (mm)	ORDER CODE
27.5 W	3000K	3580lm	877	058-1233::70
	4000K	3790lm		
37 W	3000K	4770lm	1177	058-1234::70
	4000K	5050lm		
46 W	3000K	5960lm	1477	058-1235::70
	4000K	6310lm		
73 W	3000K	9540lm	2347	058-1238::70
	4000K	10100lm		

LUMINOUS FLUX value calculated for
CRI ≥ 80, colour white, cover opal

DR Byen
Copenhagen, DK –
by Vilhelm Lauritzen Arkitekter
with lighting design by Willerup&Heinsvig

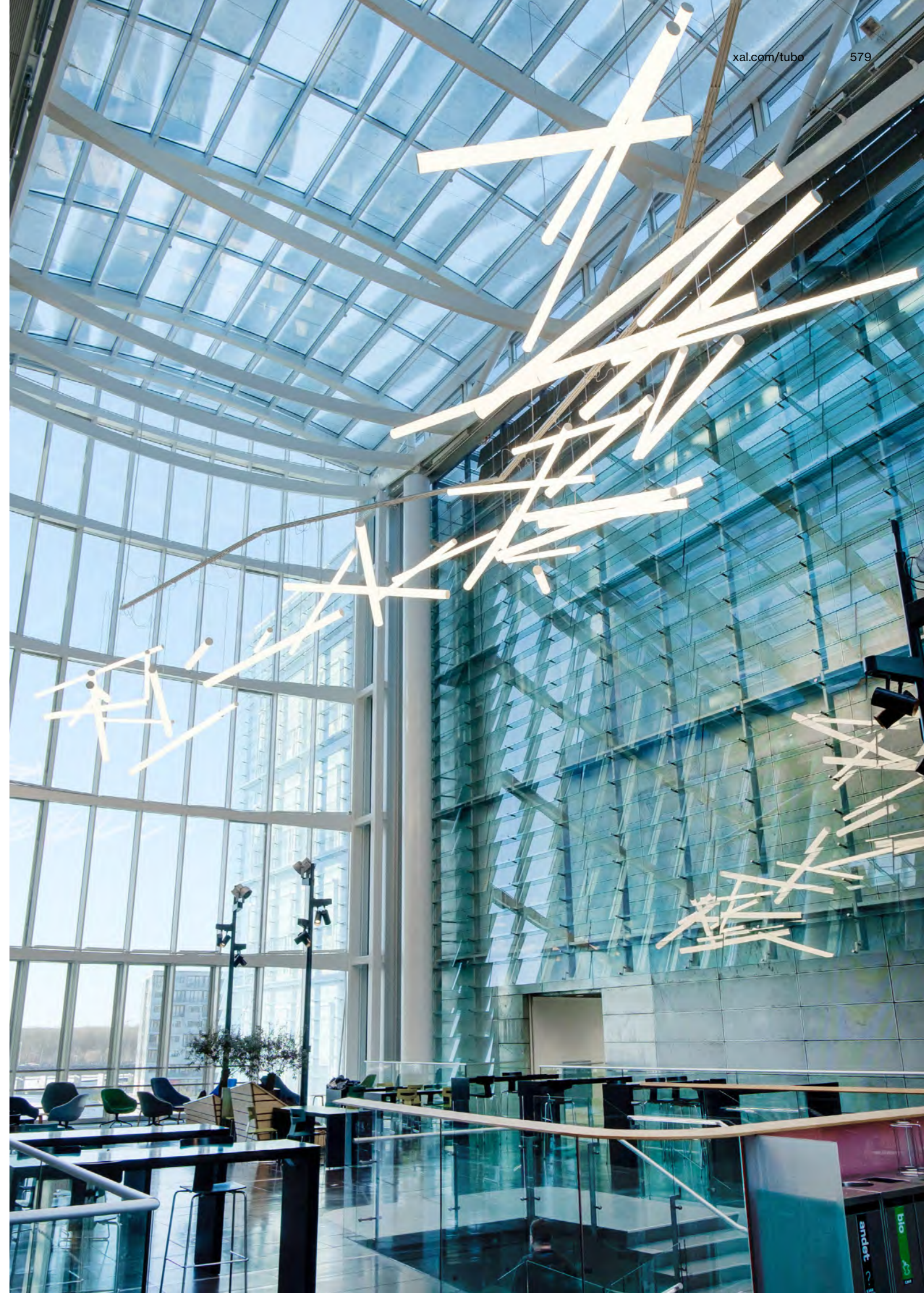

Create light sculptures



INO

EN A classic in lighting design, redefined. Create exciting, multidimensional light sculptures by combining different INO shapes. INO's lighting characteristics are extraordinary. Light is emitted upwards and downwards through a sole exit surface, surrounding the luminaire like an aura. The circular and square luminaires are mounted horizontally or vertically. INO is available in white, black, and grey, as well as in numerous custom colours. All versions come in the light colours 2700K, 3000K, 4000K, or Tunable White.

DE Ein Klassiker in der Lichtplanung neu definiert. Durch die Kombination verschiedener geometrischer Formen lassen sich spannende, mehrdimensionale Lichtskulpturen kreieren. Das besondere an INO ist ihre Abstrahlcharakteristik. Durch nur eine Austrittsfläche nach innen, wird Licht nach oben und unten abgestrahlt und umgibt die Leuchte fast wie eine Aura. Wahlweise können die quadratischen oder kreisrunden Leuchten montiert werden. INO ist in den Farben Weiß, Schwarz und Grau sowie in weiteren Spezialfarben verfügbar. Alle Varianten können in den Lichtfarben 2700K, 3000K, 4000K oder Tunable White gewählt werden.

Types



700	750
900	1000
1200	1250
1500	1500

Mounting



suspended

Light distributions

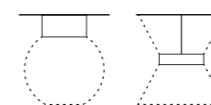

opal direct
indirect

Light distribution

EN INO's beam characteristics make it unique. It boasts a three-dimensional light-emitting surface that sends light upwards, downwards, and inwards, surrounding the luminaire with an aura. This high-quality luminaire's surroundings are illuminated evenly, while the inside of the ring stays visible even from a distance.

DE Das besondere an INO ist ihre Abstrahlcharakteristik. Durch eine dreidimensionale Austrittsfläche wird Licht nach oben, nach unten und nach innen abgestrahlt und umgibt die Leuchte fast wie eine Aura. Das hochqualitative Licht erhellt die Umgebung gleichmäßig, während die Innenseite des Rings weithin sichtbar ist.



Geometric variety

EN Discover even more INO design options through different sizes and shapes. The luminaire is available in square and circular versions. Up to four different sizes provide even more creative freedom.

DE Entdecken Sie noch mehr gestalterische Möglichkeiten von INO durch unterschiedliche Größen und Formen. Die Leuchte ist wahlweise als quadratische oder kreisrunde Variante verfügbar. Durch bis zu vier verschiedene Größen ergeben sich noch weitere kreative Kombinationsmöglichkeiten.

Colour variety

EN INO comes in the standard white, grey, or black. Other colours are available, unlocking maximum design freedom for your project. Find out more about our palette at: xal.com/colours

DE INO ist in den Standardfarben Weiß, Grau und Schwarz erhältlich. Darüber hinaus stehen weitere Farbvarianten zur Verfügung – die ermöglichen Ihnen einen maximalen Gestaltungsfreiraum bei Ihrem Projekt. Mehr zu unserer Farbpalette erfahren Sie auf xal.com/colours



xal.com/colours

TW – Tunable White

EN Changes in the colour of light have a substantial effect on our mood. Tunable White allows the colour temperature to be continuously adjusted from 2700 K (warm light) to 6500 K (cool light) to dynamically adapt the lighting to the time of day or ambient brightness.

DE Veränderungen in der Lichtfarbe haben eine starke Wirkung auf unsere Stimmung. Tunable White ermöglicht die stufenlose Verschiebung der Farbtemperatur von 2700 K (warmes Licht) bis 6500 K (kühles Licht), um die Beleuchtung dynamisch an Uhrzeit oder Umgebungshelligkeit anzupassen.

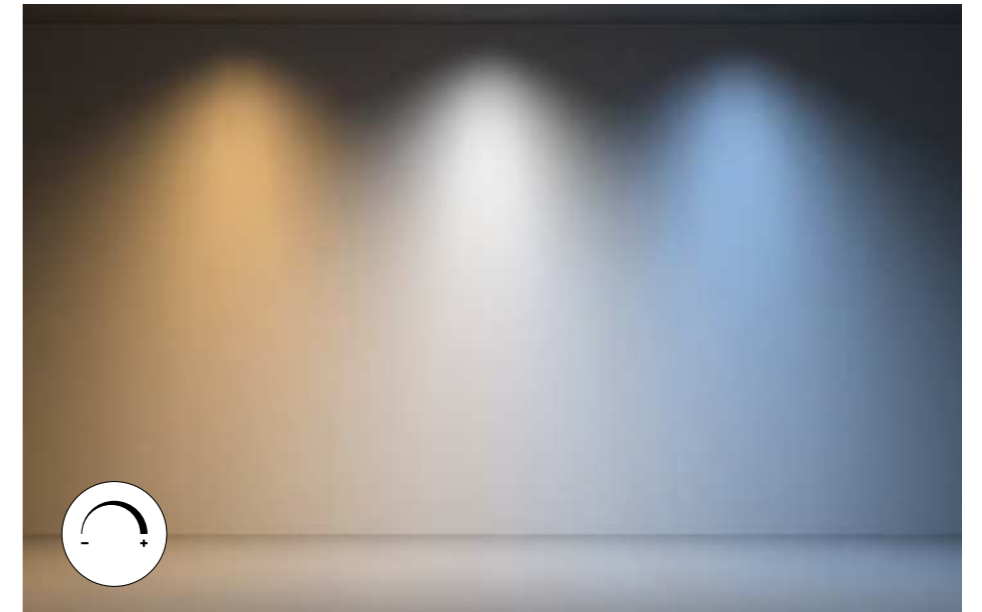

Effective from every perspective

EN INO can be suspended horizontally or vertically from the ceiling. INO offers a range of options for creating bespoke arrangements and effective ceiling and wall sculptures.

DE INO kann nicht nur horizontal, sondern auch vertikal von der Decke abgehängt werden. Dadurch bietet INO die Möglichkeit, individuelle Arrangements und wirkungsvolle Decken- und Wandskulpturen zu gestalten.

XPECTRUM LED

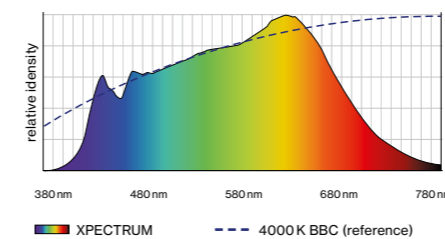

Commercially available LED 4000 K

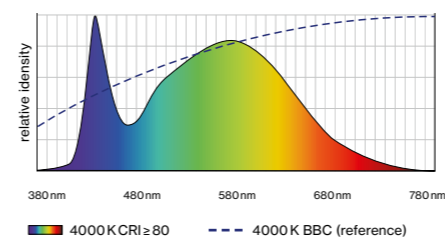

Full-spectrum LED

EN XAL's new XPECTRUM LEDs deliver healthy, biologically effective light. The reduced blue light and increased cyan values reduce the blue light hazard for the eye to daylight-equivalent levels. The resulting non-visual, so-called melanopic light effect, improves concentration and increases sleep quality. The excellent colour rendering of IES TM 30-15 $R_f = 98$ and $R_g = 101$ further helps visual comfort.

DE Die neue XPECTRUM LED von XAL sorgt für gesundes, biologisch wirksames Licht. Der reduzierte Blaulichtanteil sowie die erhöhten Cyan-Werte minimieren die Blaulichtgefahr für das Auge auf ein tageslichtähnliches Niveau. Die daraus resultierende nichtvisuelle, auch melanopische Lichtwirkung genannt, fördert die Konzentration und steigert die Schlafqualität. Die hervorragende Farbwiedergabe von IES TM 30-15 $R_f = 98$ und $R_g = 101$ ermöglicht zudem einen verbesserten Sehkomfort.

← back



INO circle suspended

EN Ring shaped luminaire housing from rolled aluminium extruded profile, seamlessly welded; surface powder coated; pendant fitting with cable suspension; height adjustment without tools; with transparent feeder cable; electronic operating unit installed in the canopy; completely homogeneously illuminated, satinised PMMA cover; inwards facing emission characteristics; direct/indirect illumination characteristic for additional emphasis of the ceiling and more visual comfort; energy-efficient LEDs with very good colour rendering; canopy with 2 cable openings and plug-in terminal for through wiring

DE Ringförmiger Leuchtenkörper aus gerolltem Aluminiumstrangpressprofil nahtlos verschweißt; Oberfläche pulverbeschichtet; abgependelt mit Seilabhängung; werkzeuglose Höhenverstellung; inkl. transp. Einspeiseleitung; elektronisches Betriebsgerät im Baldachin verbaut; absolut homogen ausgeleuchtete, satinierte PMMA-Abdeckung; nach innen gerichtete Abstrahlcharakteristik; direkt/indirekte Abstrahlcharakteristik für zusätzliche Akzentuierung der Decke und mehr Sehkomfort; energieeffiziente LEDs mit sehr guter Farbwiedergabe; Baldachin mit 2 Kabelöffnungen und Steckklemme für Weiterverdrahtung

Quickinfo

2700 K, 3000 K, 4000 K
CRI ≥ 80, 3 SDCM
up to 143 lm/W
L90 @ 50 000 h
DALI-2
opal

Types

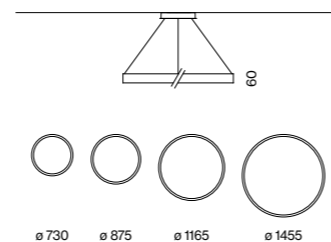

Colours



Light distribution



DiiA® standards
251, 252, 253



direct/indirect
illumination

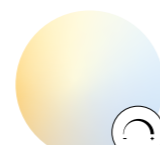

tunable white
2700–6500 K

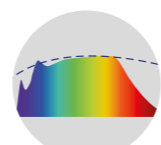

CRI ≥ 98
XPECTRUM

Order options

SUSPENSION
cable 2000 mm / canopy central

COLOUR TEMPERATURE
2700 K 4
3000 K 5
4000 K 6

CONTROL
DALI-2

MATERIAL COLOUR
○ pure white RAL 9010 7
● white aluminium RAL 9006 G
● jet black RAL 9005 8
● special colours* ● p. 992 X
*canopy always in white

LIGHT OPTIC COVER
opal high performance

Options on request

SUSPENSION
cable 2000 mm

COLOUR RENDERING INDEX
CRI ≥ 90
CRI ≥ 98 XPECTRUM

CONTROL
Casambi

COLOUR TEMPERATURE
tunable white 2700–6500 K
DALI-2 DT8

SHAPES
INO trig suspended
INO hex suspended
INO circle vertical suspended

Light distribution

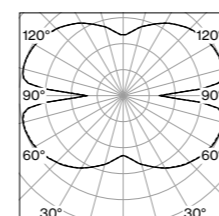

opal high performance
direct/indirect

LUMINOUS FLUX value calculated for
CRI ≥ 80, colour white, cover opal

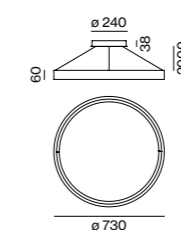

INO 700 circle suspended



DIRECT / INDIRECT			ORDER CODE
SYSTEM POWER	COLOUR TEMP.	LUMINOUS FLUX	
32 W	2700 K	4060 lm	0 3 4 - 3 4 1 2 :: 3 H
	3000 K	4310 lm	
	4000 K	4570 lm	

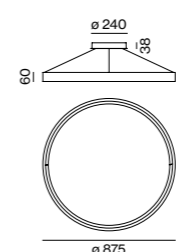

INO 900 circle suspended



DIRECT / INDIRECT			ORDER CODE
SYSTEM POWER	COLOUR TEMP.	LUMINOUS FLUX	
39 W	2700 K	4870 lm	0 3 4 - 3 4 1 3 :: 3 H
	3000 K	5180 lm	
	4000 K	5480 lm	

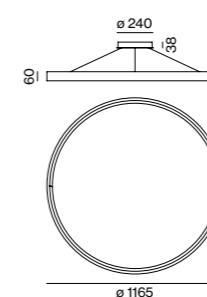

INO 1200 circle suspended



DIRECT / INDIRECT			ORDER CODE
SYSTEM POWER	COLOUR TEMP.	LUMINOUS FLUX	
51 W	2700 K	6490 lm	0 3 4 - 3 4 1 4 :: 3 H
	3000 K	6900 lm	
	4000 K	7310 lm	

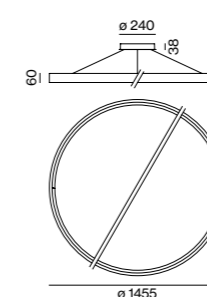

INO 1500 circle suspended



DIRECT / INDIRECT			ORDER CODE
SYSTEM POWER	COLOUR TEMP.	LUMINOUS FLUX	
64 W	2700 K	8120 lm	0 3 4 - 3 4 1 5 :: 3 H
	3000 K	8630 lm	
	4000 K	9130 lm	

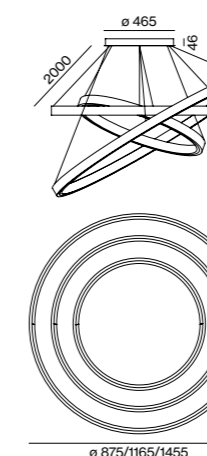

INO TRIPLE circle suspended



DIRECT / INDIRECT			ORDER CODE
SYSTEM POWER	COLOUR TEMP.	LUMINOUS FLUX	
154 W	2700 K	19580 lm	0 3 4 - 3 8 1 5 :: 3 H
	3000 K	20710 lm	
	4000 K	21920 lm	

Villa Mayfair Barcelona, ES

PrimeTime Touristik und
Marketing GmbH Graz, AT

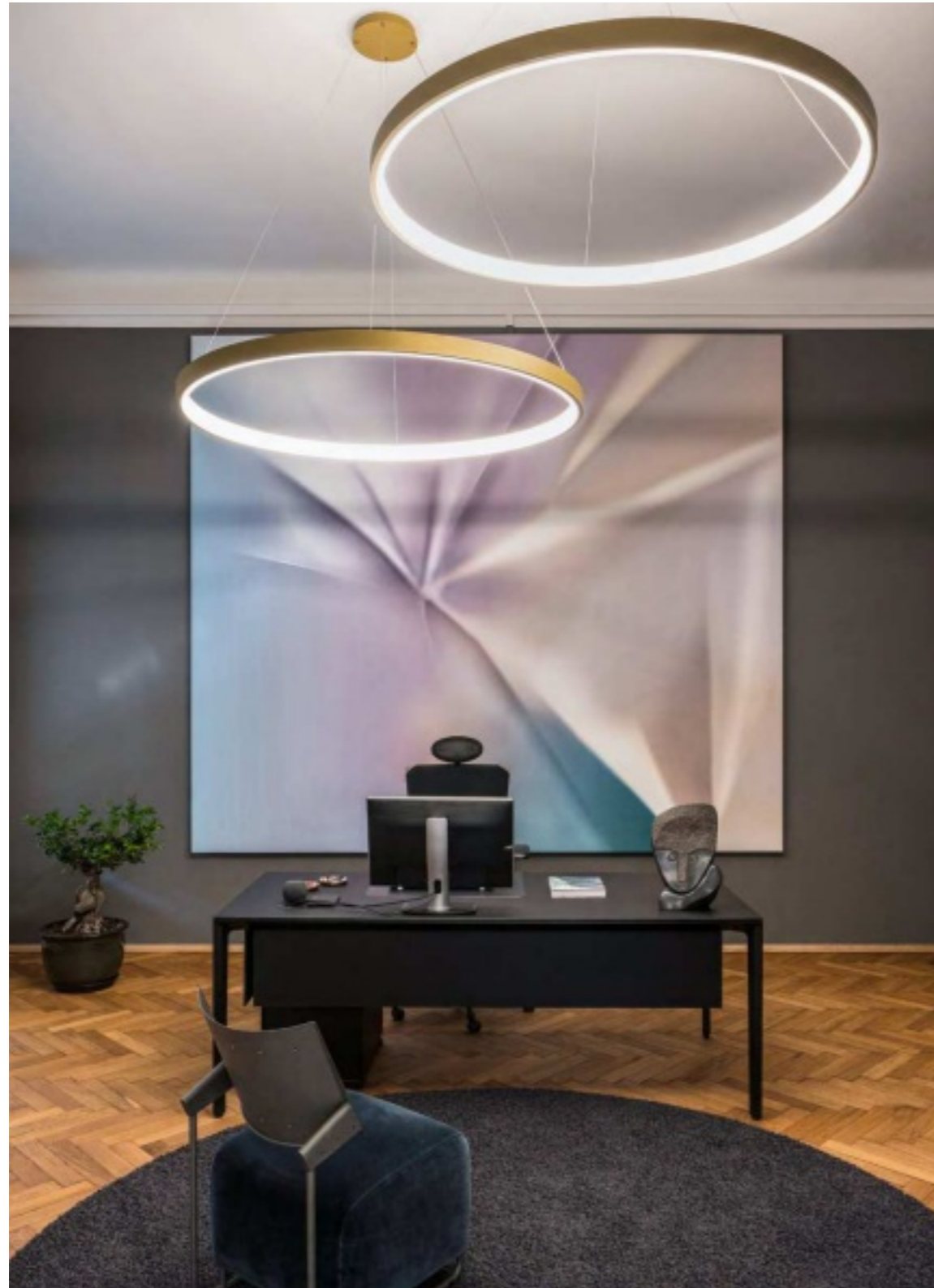

← back



INO square suspended

EN Square aluminium luminaire housing; surface powder coated; pendant fitting with cable suspension; height adjustment without tools; with transparent feeder cable; electronic operating unit installed in the canopy; completely homogeneously illuminated, satinised PMMA cover; inwards facing emission characteristics; direct/indirect illumination characteristic for additional emphasis of the ceiling and more visual comfort; energy-efficient LEDs with very good colour rendering; canopy with 2 cable openings and plug-in terminal for through wiring

DE Quadratischer Leuchtenkörper aus Aluminium; Oberfläche pulverbeschichtet; abgependelt mit Seilabhängung; werkzeuglose Höhenverstellung; inkl. transp. Einspeiseleitung; elektronisches Betriebsgerät im Baldachin verbaut; absolut homogen ausgeleuchtete, satinierte PMMA-Abdeckung; nach innen gerichtete Abstrahlcharakteristik; direkt/indirekte Abstrahlcharakteristik für zusätzliche Akzentuierung der Decke und mehr Sehkomfort; energieeffiziente LEDs mit sehr guter Farbwiedergabe; Baldachin mit 2 Kabelöffnungen und Steckklemme für Weiterverdrahtung

Quickinfo

2700 K, 3000 K, 4000 K
 CRI ≥ 80, 3 SDCM
 up to 144 lm/W
 L90 @ 50 000 h
 DALI-2
 opal

Types

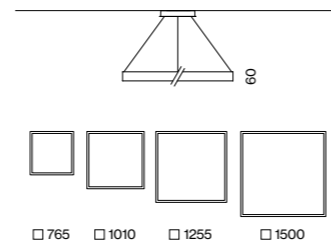

Colours



Light distribution



Order options

SUSPENSION
 cable 2000 mm / canopy central

COLOUR TEMPERATURE	
2700 K	4
3000 K	5
4000 K	6

CONTROL

DALI-2

MATERIAL COLOUR

○ pure white RAL 9010	7
● white aluminium RAL 9006	G
● jet black RAL 9005	8
● special colours* ● p. 992	X

*canopy always in white

LIGHT OPTIC COVER

opal high performance

Options on request

SUSPENSION

cable 2000 mm

COLOUR RENDERING INDEX

CRI ≥ 90
 CRI ≥ 98 XPECTRUM

CONTROL

Casambi

COLOUR TEMPERATURE

tunable white 2700–6500 K
 DALI-2 DT8

SHAPES

INO trig suspended
 INO hex suspended
 INO circle vertical suspended

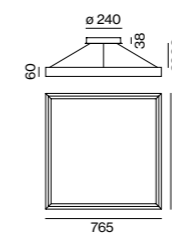

INO 750 square suspended



DIRECT / INDIRECT

SYSTEM POWER	COLOUR TEMP.	LUMINOUS FLUX	ORDER CODE
40 W	2700 K	5120 lm	0 3 4 - 4 4 1 2 :: 3 H
	3000 K	5440 lm	
	4000 K	5760 lm	

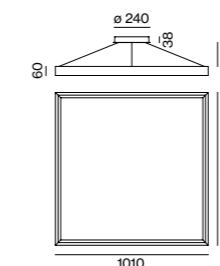

INO 1000 square suspended



DIRECT / INDIRECT

SYSTEM POWER	COLOUR TEMP.	LUMINOUS FLUX	ORDER CODE
54 W	2700 K	6830 lm	0 3 4 - 4 4 1 3 :: 3 H
	3000 K	7250 lm	
	4000 K	7680 lm	

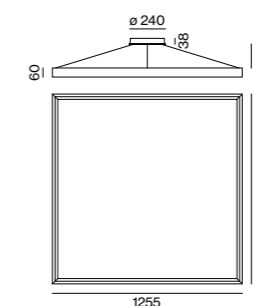

INO 1250 square suspended



DIRECT / INDIRECT

SYSTEM POWER	COLOUR TEMP.	LUMINOUS FLUX	ORDER CODE
67 W	2700 K	8530 lm	0 3 4 - 4 4 1 4 :: 3 H
	3000 K	9070 lm	
	4000 K	9600 lm	

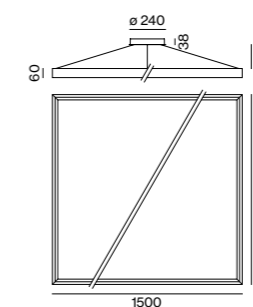

INO 1500 square suspended



DIRECT / INDIRECT

SYSTEM POWER	COLOUR TEMP.	LUMINOUS FLUX	ORDER CODE
81 W	2700 K	10200 lm	0 3 4 - 4 4 1 5 :: 3 H
	3000 K	10900 lm	
	4000 K	11500 lm	

Light distribution

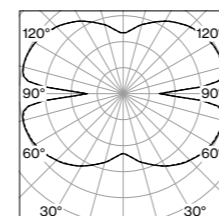

opal high performance
 direct/indirect

LUMINOUS FLUX value calculated for CRI ≥ 80, colour white, cover opal

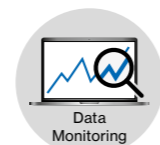

DiiA® standards
 251, 252, 253



direct/indirect
 illumination

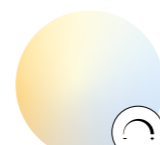

tunable white
 2700–6500 K

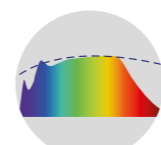

CRI ≥ 98
 XPECTRUM

Granitlab Coworking

St. Martin im Mühlkreis, AT –
by GHT-Plan GmbH with lighting design
by GHT-Plan GmbH, AREA C.I. Design GmbH



Light in perfect circles



MINO CIRCLE

EN Beautiful circular arrangements: The grouping of MINO CIRCLE variants in different sizes and colours creates interesting and fresh ceiling patterns and figures. For optimal room acoustics, the luminaires can be supplemented with highly effective, round acoustic elements. Combine the surface-mounted ceiling and suspended versions, as well as the light colours 3000K and 4000K, for more design variety. MINO CIRCLE with indirect beam patterns provides plenty of light where additional ceiling illumination is required. For homogeneous illumination, choose luminaires with opal covers. The microprismatic cover ensures glare-free lighting.

DE Ästhetische Kreisarrangements: Die Anordnung von MINO CIRCLE Varianten in verschiedenen Größen und Farben ermöglicht interessante, immer wieder neue Deckenmuster und Figuren. Für optimale Raumakustik können die Leuchtkörper durch hocheffektive runde Akustikelemente ergänzt werden. Kombinieren Sie die Deckenanbau- und abgehängte Varianten sowie die Lichtfarben 3000K und 4000K für mehr gestalterische Vielfalt. Wo zusätzliche Deckenaufhellung gewünscht ist, sorgt MINO CIRCLE mit indirekter Abstrahlcharakteristik für genug Licht. Für eine homogene Ausleuchtung wählen Sie Leuchten mit Opal-Cover, die mikroprismatische Abdeckung gewährleistet blendfreie Beleuchtung.

Types

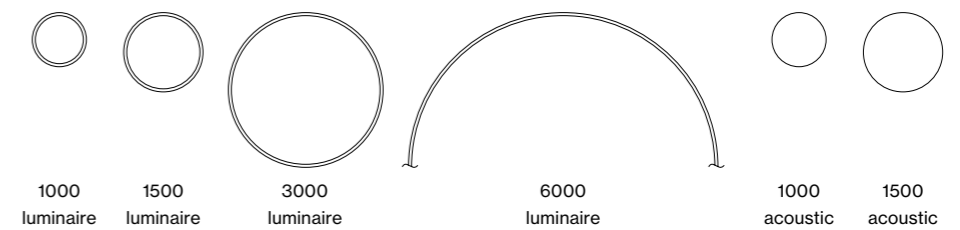

Mountings

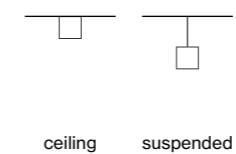

Light distributions

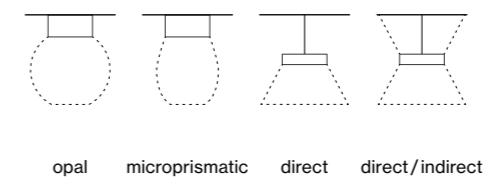

← back



Quickinfo

3000K, 4000K
 CRI ≥ 80, 3 SDCM
 up to 123lm/W
 L90 @ 50 000h
 DALI-2
 opal, microprismatic

Types

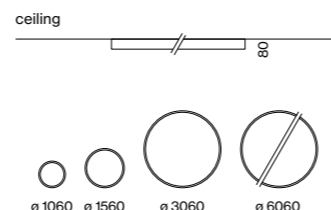

Luminaire colours



Light distribution



MINO CIRCLE

ceiling

EN Ring shaped luminaire housing from rolled aluminium extruded profile, seamlessly welded; surface powder coated; light inset consisting of highly reflective coated die-cast aluminium for improved thermal management; HPO (High Performance Opal) cover for uniform illumination; micro prismatic PMMA diffuser incl. diffuser film for homogeneous illumination and reduced luminance; sound absorbing elements available; energy-efficient LEDs with very good colour rendering

DE Ringförmiger Leuchtenkörper aus gerolltem Aluminiumstrangpressprofil nahtlos verschweißt; Oberfläche pulverbeschichtet; Lichteinsatz bestehend aus hochreflektierend lackiertem Aluminiumdruckguss für verbessertes Thermomanagement; HPO (High Performance Opal) Abdeckung für homogene Ausleuchtung; mikroprismatische PMMA-Abdeckung inkl. Diffusorfolie zur Reduktion der Leuchtdichte bei homogener Ausleuchtung; schallabsorbierende Elemente erhältlich; energieeffiziente LEDs mit sehr guter Farbwiedergabe

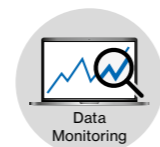

DiiA® standards 251, 252, 253



direct/indirect illumination

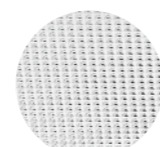

microprismatic



acoustic elements (p. 606)

Order options

COLOUR TEMPERATURE

3000K	5
4000K	6

CONTROL
 DALI-2

MATERIAL COLOUR

○ pure white RAL 9010	7
● white aluminium RAL 9006	G
● jet black RAL 9005	8
● special colours p. 992	X

LIGHT OPTIC COVER

opal high performance	H
microprismatic	Z

Options on request

COLOUR RENDERING INDEX
 CRI ≥ 90

CONTROL
 Casambi



MINO 60 CIRCLE 1000 ceiling



DIRECT

SYSTEM POWER	COLOUR TEMP.	LUMINOUS FLUX	ORDER CODE
65 W	3000 K	7130 lm	0 3 4 - 2 1 1 2 :: 3
	4000 K	7550 lm	



MINO 60 CIRCLE 1500 ceiling



DIRECT

SYSTEM POWER	COLOUR TEMP.	LUMINOUS FLUX	ORDER CODE
99 W	3000 K	11400 lm	0 3 4 - 2 1 1 0 :: 3
	4000 K	12100 lm	

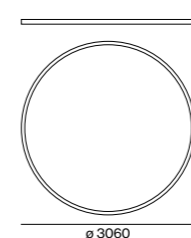

MINO 60 CIRCLE 3000 ceiling



DIRECT

SYSTEM POWER	COLOUR TEMP.	LUMINOUS FLUX	ORDER CODE
198 W	3000 K	23000 lm	0 3 4 - 2 1 1 4 :: 3 7 H
	4000 K	24300 lm	

other configurations see MINO 60 CURVE system

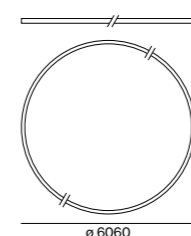

MINO 60 CIRCLE 6000 ceiling



DIRECT

SYSTEM POWER	COLOUR TEMP.	LUMINOUS FLUX	ORDER CODE
396 W	3000 K	45900 lm	0 3 4 - 2 1 1 6 :: 3 7 H
	4000 K	48600 lm	

other configurations see MINO 60 CURVE system

Acoustic elements

see page 606

LUMINOUS FLUX value calculated for CRI ≥ 80, colour white, cover opal

← back

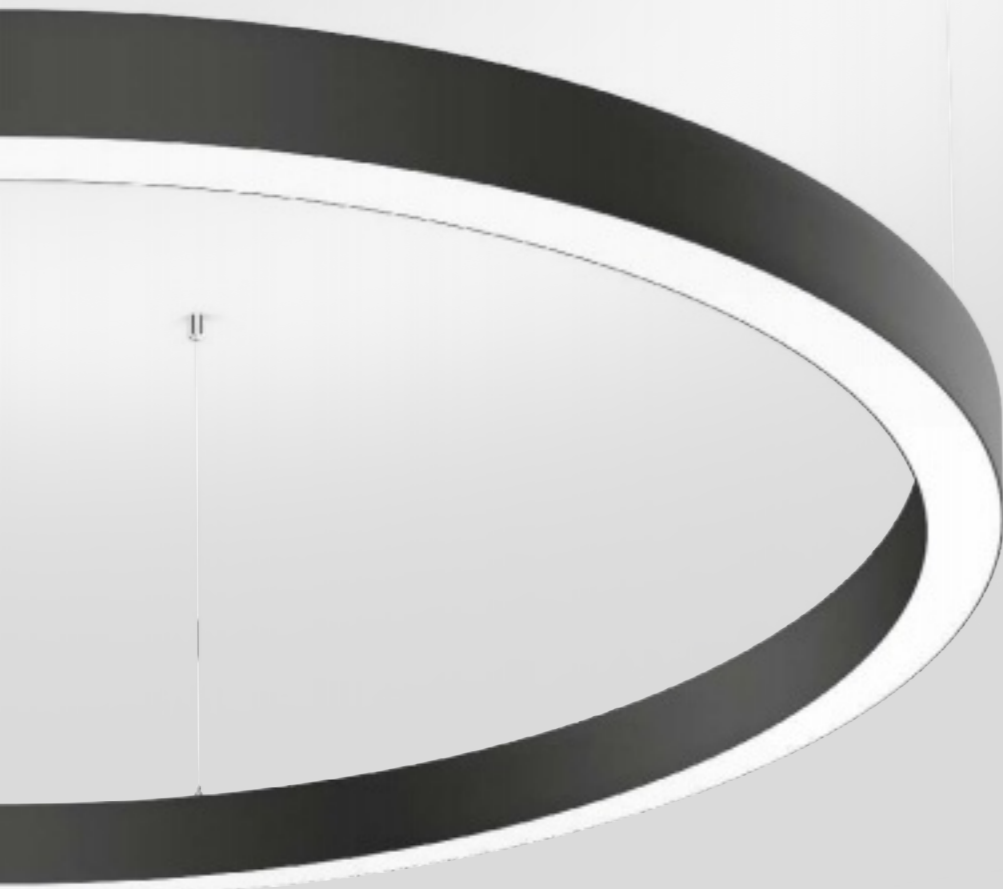

MINO CIRCLE

suspended

EN Ring shaped luminaire housing from rolled aluminium extruded profile, seamlessly welded; surface powder coated; pendant fitting with cable suspension; with integrated tool-less suspension height adjustment; incl. transparent feed; light inset consisting of highly reflective coated die-cast aluminium for improved thermal management; HPO (High Performance Opal) cover for uniform illumination; micro prismatic PMMA diffuser incl. diffuser film for homogeneous illumination and reduced luminance; optional with direct/indirect illumination characteristic for additional emphasis of the ceiling and more visual comfort; energy-efficient LEDs with very good colour rendering; sound absorbing elements available

DE Ringförmiger Leuchtenkörper aus gerolltem Aluminiumstrangpressprofil nahtlos verschweißt; Oberfläche pulverbeschichtet; abgependelt mit Seilabhängung; werkzeuglose Höhenverstellung an der Leuchte; inkl. transparenter Einspeiseleitung; Lichteinsatz bestehend aus hochreflektierend lackiertem Aluminiumdruckguss für verbessertes Thermomanagement; HPO (High Performance Opal) Abdeckung für homogene Ausleuchtung; mikroprismatische PMMA-Abdeckung inkl. Diffusorfolie zur Reduktion der Leuchtdichte bei homogener Ausleuchtung; optional mit direkt/indirekter Abstrahlcharakteristik für zusätzliche Akzentuierung der Decke und mehr Sehkomfort; energieeffiziente LEDs mit sehr guter Farbwiedergabe; schallabsorbierende Elemente erhältlich

Quickinfo

3000K, 4000K
 CRI ≥ 80, 3 SDCM
 up to 132lm/W
 L90 @ 50 000h
 DALI-2
 opal, microprismatic

Types

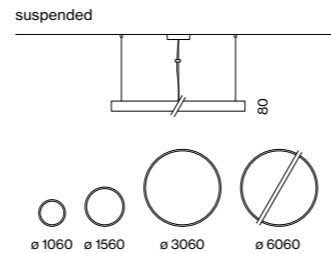

Luminaire colours

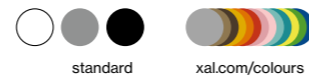

Light distributions

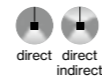

Order options

SUSPENSION
 cable 1500mm 2
 cable 1500mm/canopy central 4

COLOUR TEMPERATURE
 3000K 5
 4000K 6

CONTROL
 DALI-2

LUMINAIRE COLOUR
 ○ pure white RAL 9010 7
 ● white aluminium RAL 9006 G
 ● jet black RAL 9005 8
 ● special colours* ● p.992 X
 *canopy always in white

LIGHT OPTIC COVER
 opal high performance H
 microprismatic Z

Options on request

COLOUR RENDERING INDEX
 CRI ≥ 90

CONTROL
 Casambi

Light distributions

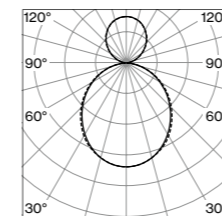

opal
 direct/indirect

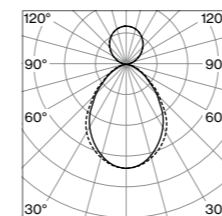

microprismatic
 direct/indirect

LUMINOUS FLUX value calculated for CRI ≥ 80, colour white, cover opal

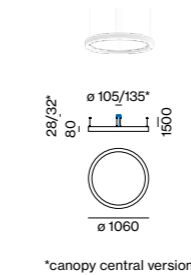

*canopy central version

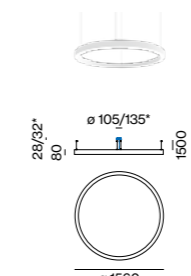

*canopy central version

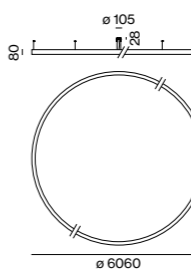
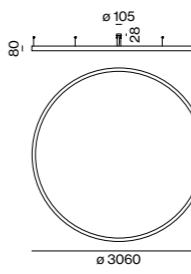

MINO 60 CIRCLE 1000 suspended



DIRECT		ORDER CODE	
SYSTEM POWER	COLOUR TEMP.	LUMINOUS FLUX	
65 W	3000 K	7130 lm	0 3 4 - 2 5 1 2 :: 3 7 H
	4000 K	7550 lm	



DIRECT / INDIRECT		ORDER CODE	
SYSTEM POWER	COLOUR TEMP.	LUMINOUS FLUX	
87 W	3000 K	↓ 7120 / ↑ 3190 lm	0 3 4 - 2 5 1 3 :: 3 7 H
	4000 K	↓ 7540 / ↑ 3380 lm	

MINO 60 CIRCLE 1500 suspended

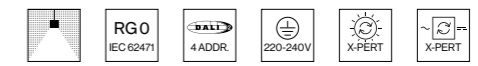

DIRECT		ORDER CODE	
SYSTEM POWER	COLOUR TEMP.	LUMINOUS FLUX	
99 W	3000 K	11400 lm	0 3 4 - 2 5 1 0 :: 3 7 H
	4000 K	12100 lm	



DIRECT / INDIRECT		ORDER CODE	
SYSTEM POWER	COLOUR TEMP.	LUMINOUS FLUX	
132 W	3000 K	↓ 11400 / ↑ 5100 lm	0 3 4 - 2 5 1 1 :: 3 7 H
	4000 K	↓ 12100 / ↑ 5400 lm	

MINO 60 CIRCLE 3000 suspended



DIRECT		ORDER CODE	
SYSTEM POWER	COLOUR TEMP.	LUMINOUS FLUX	
198 W	3000 K	23000 lm	0 3 4 - 2 2 1 4 :: 3 7 H
	4000 K	24300 lm	

other configurations see MINO 60 CURVE system

MINO 60 CIRCLE 6000 suspended

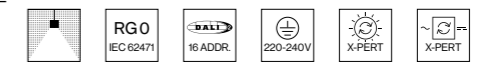

DIRECT		ORDER CODE	
SYSTEM POWER	COLOUR TEMP.	LUMINOUS FLUX	
396 W	3000 K	45900 lm	0 3 4 - 2 2 1 6 :: 3 7 H
	4000 K	48600 lm	

other configurations see MINO 60 CURVE system

Acoustic elements

see page 606

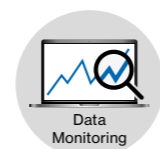

DiiA® standards
 251, 252, 253



direct/indirect
 illumination

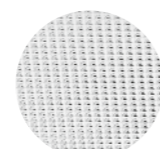

microprismatic



acoustic
 elements (p. 606)

Private Residence SPV29
Sofia, BG –
by ALL in STUDIO LTD
including lighting design





Crown Square's Lobby
Warsaw, PL



Vifor Pharma St. Gallen, CH –
by Aroma Architecture -
Alessandro Nicotra with lighting
design by SLG Lichtdesigner



← back

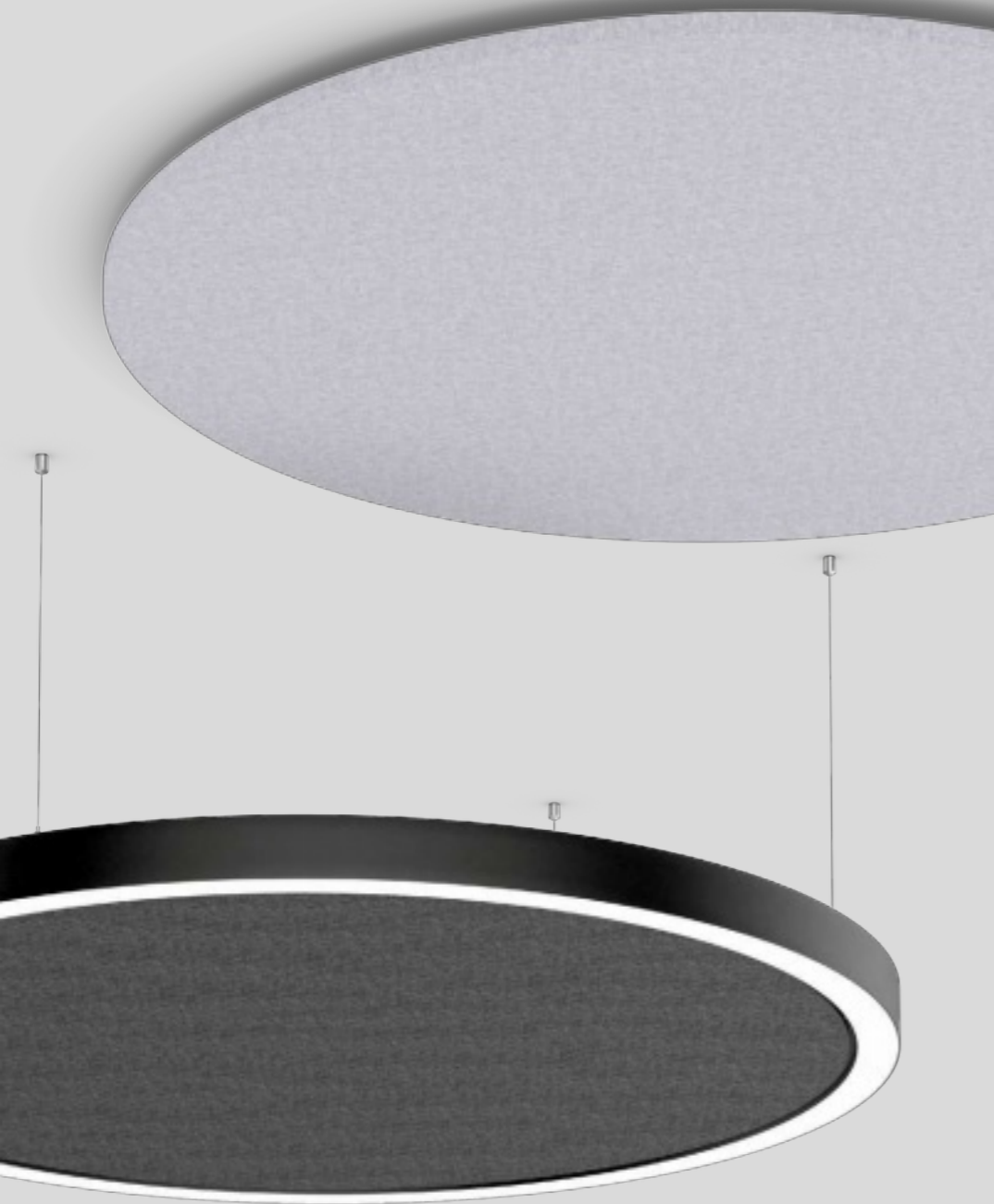

MINO CIRCLE

acoustic elements

EN Acoustic element made of high-quality, self-supporting, recycled PET felt with sound absorbing properties; round design; high-quality visual and tactile surface; absorption of direct sound and sound reflected from the ceiling; this creates high acoustic performance; for insertion into MINO circle ceiling and MINO circle suspended; or single installation, choice of surface mounted and pendant versions with cable suspension; tool-less suspension height adjustment of the acoustic element

DE Akustikelement aus hochwertigem, selbsttragendem, recyceltem PET-Filz mit schallabsorbierenden Eigenschaften; Bauform rund; optisch und haptisch hochwertige Oberfläche; Absorption des Direktschalls und des von der Decke reflektierten Schalls; dadurch hohe akustische Performance; zum Einlegen in MINO circle ceiling und MINO circle suspended; oder Einzelmontage, wahlweise angebaute oder abgehängte Variante mit Seilabhängung; werkzeuglose Höhenverstellung am Akustikelement

Quickinfo

PET felt
 ♻️ from recycled material
 up to absorption class A
 🔥 B-s1, d0

Types

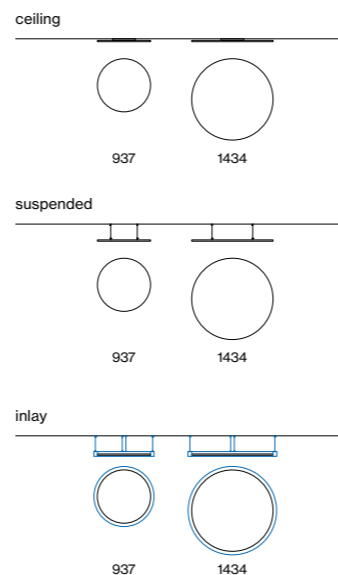

Colours



Order options

MATERIAL COLOUR

white W

marble grey D

black L

other colours on request

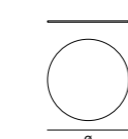
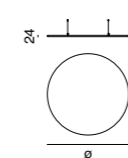
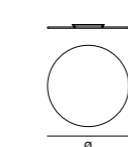

MINO CIRCLE ACOUSTIC ceiling

ACOUSTIC ELEMENT		
TYPE	Ø-H (mm)	ORDER CODE
1000 ceiling	937-25	034-271111 <input checked="" type="checkbox"/>
1500 ceiling	1434-25	034-271211 <input checked="" type="checkbox"/>

MINO CIRCLE ACOUSTIC suspended

ACOUSTIC ELEMENT		
TYPE	L-W-H (mm)	ORDER CODE
1000 suspended	937-25	034-272111 <input checked="" type="checkbox"/>
1500 suspended	1434-25	034-272211 <input checked="" type="checkbox"/>

cable suspension 1500 mm

MINO CIRCLE ACOUSTIC inlay

ACOUSTIC ELEMENT		
TYPE	L-W-H (mm)	ORDER CODE
1 MINO circle 1000	937-25	034-270111 <input checked="" type="checkbox"/>
2 MINO circle 1500	1434-25	034-270211 <input checked="" type="checkbox"/>

only in combination with MINO 60 CIRCLE ceiling or MINO 60 CIRCLE suspended; acoustic inlay for MINO 60 CIRCLE suspended with central canopy on request;

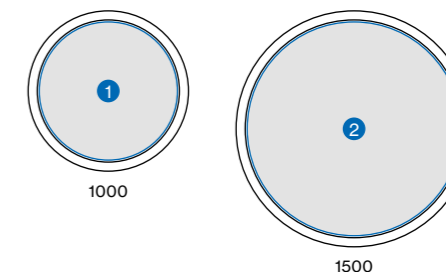

Planday Copenhagen, DK –
lighting design by anker & co



Elegance at work



LITO

EN LITO is a versatile, elegant, and strikingly slim office luminaire. It is available in three standard colours: white, black, and grey. The available versions comply with the standard specifications for workstations. LITO with a microprismatic cover ensures homogeneous illumination, while the reflector version with faceted optics casts directed, glare-free light onto the work surface. LITO comes with a 170° wide beam indirect light to provide pleasant ceiling illumination. Optionally equipped with a brightness & presence sensor, LITO reacts dynamically to people in the office and changing daylight. This generates a friendly working environment and saves energy.

DE LITO ist eine vielseitige, elegante und auffallend schmale Office-Leuchte in drei Standardfarben: Weiß, Schwarz und Grau. Die verfügbaren Varianten entsprechen den Normvorgaben für Arbeitsplätze: LITO mit mikroprismatischer Abdeckung sorgt für eine homogene Ausleuchtung, während die Reflektor-Variante mit Facettenoptik gerichtetes, entblendetes Licht auf die Arbeitsfläche lenkt. Für eine angenehme Deckenaufhellung bietet LITO ein 170° weit abstrahlendes Indirektlicht. Wahlweise ausgestattet mit einem Helligkeits- und Anwesenheitssensor reagiert LITO dynamisch auf Menschen im Büro und sich veränderndes Tageslicht – das schafft ein angenehmes Arbeitsumfeld und spart Energie.

Type



60

Mounting



suspended

Light distributions

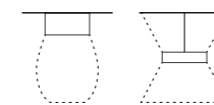
microprismatic
(UGR ≤ 19)direct
indirect

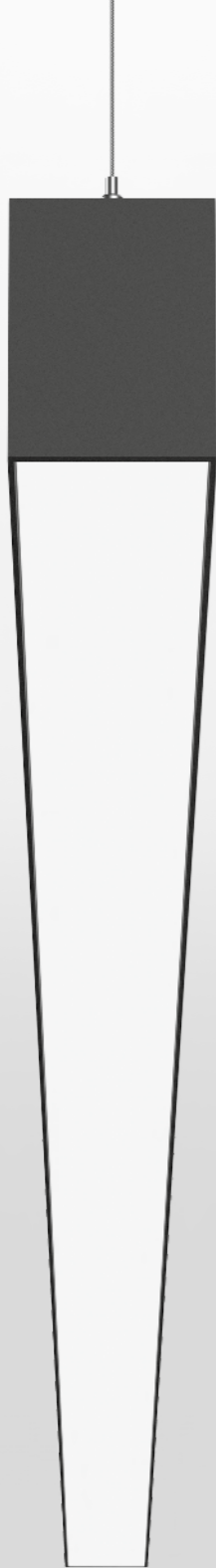

LITO 60

suspended

EN Luminaire housing from extruded aluminium profile, angular design; no visible screws; surface powder coated; suspended; with integrated tool-less suspension height adjustment; spring clip attachment to the luminaire; freely positionable; with transparent feeder cable; light inset made from extruded profile for improved thermal management; micro prismatic PMMA diffuser incl. diffuser film for homogeneous illumination and reduced luminance; direct / indirect light distribution; indirect light component with integrated PC boards for maximum, homogeneous ceiling illumination; energy-efficient LEDs with very good colour rendering

DE Leuchtenkörper aus Aluminiumstrangpressprofil, kantige Ausführung; keine sichtbaren Schrauben; Oberfläche pulverbeschichtet; abgependelt; werkzeuglose Höhenverstellung an der Leuchte; Befestigung an der Leuchte mittels Federclips; frei positionierbar; inkl. transp. Einspeiseleitung; Lichteinsatz aus Strangpressprofil für verbessertes Thermomanagement; mikroprismatische PMMA-Abdeckung inkl. Diffusorfolie zur Reduktion der Leuchtdichte bei homogener Ausleuchtung; direkt / indirekte Abstrahlcharakteristik; Indirektlichtanteil mit eigenen Platinen für maximale, homogene Deckenaufhellung; energieeffiziente LEDs mit sehr guter Farbwiedergabe

Quickinfo

3000K, 4000K
 CRI ≥ 80, 3 SDCM
 up to 116lm/W
 L90 @ 50 000h
 non DIM, DALI-2
 brightness & presence sensor
 microprismatic (UGR ≤ 19)

Types

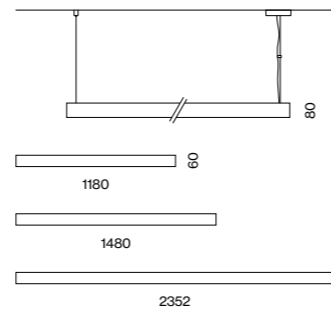

Colours



Light distribution



Order options

COLOUR TEMPERATURE	
3000K	5
4000K	6

CONTROL	
non DIM	1
DALI-2	3
ESSENTIAL sensor (brightness & presence)	7

MATERIAL COLOUR	
○ pure white RAL 9010	7
● white aluminium RAL 9006	G
● jet black RAL 9005	8

LIGHT OPTIC COVER
 microprismatic (UGR ≤ 19)

Options on request

COLOUR RENDERING INDEX
 CRI ≥ 90

CONTROL
 dynamic daylight control

LITO 60 suspended



DIRECT / INDIRECT

SYS. POWER	COLOUR TEMP.	LUM. FLUX	L (mm)	ORDER CODE
41W	3000K	↓ 2610 / ± 1880lm	1180	0 4 6 - 5 2 2 4 :: ▢ ▢ Z
	4000K	↓ 2760 / ± 1990lm		
51W	3000K	↓ 3260 / ± 2350lm	1480	0 4 6 - 5 2 2 5 :: ▢ ▢ Z
	4000K	↓ 3450 / ± 2480lm		
82W	3000K	↓ 5220 / ± 3750lm	2352	0 4 6 - 5 2 2 8 :: ▢ ▢ Z
	4000K	↓ 5520 / ± 3980lm		

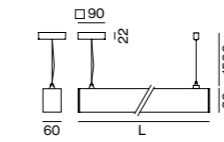

Technical data

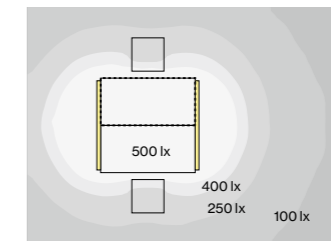

LITO 60 suspended, 51W, 4000K
 direct/indirect

ROOM VALUES
 Room dimensions 5.4 × 4 × 2.8m
 Reflection factor 0.7 | 0.5 | 0.2
 Maintenance factor 0.8
 Mounting height 2.25m

CALCULATION SURFACE
 Surface dimensions 1.6 × 0.8
 Surface height 0.75
 Average illuminance (E_m) > 500lx
 Uniformity (U₀) > 0.6

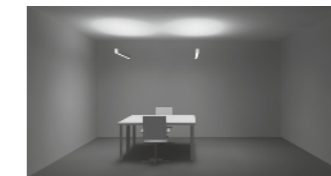

GLARE EVALUATION
 Table Classification X=4H | Y=8H | S=0.25H
 UGR transversal ≤ 19
 UGR axial ≤ 19

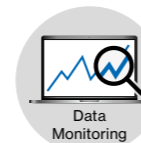

DiiA® standards
 251, 252, 253

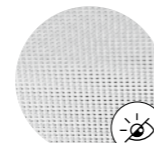

microprismatic
 (UGR ≤ 19)

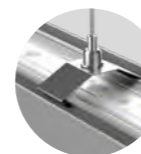

suspension freely
 positionable

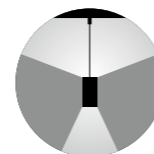

170° indirect
 illumination

Light distribution

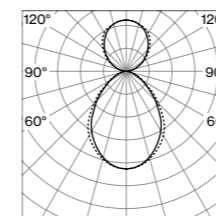

microprismatic
 direct/indirect

LUMINOUS FLUX value calculated for
 CRI ≥ 80, colour white, cover microprismatic



Deutsche Wohnwerte GmbH & Co. KG
Heidelberg, DE - by brandherm + krumrey
with lighting design by notholt lighting design

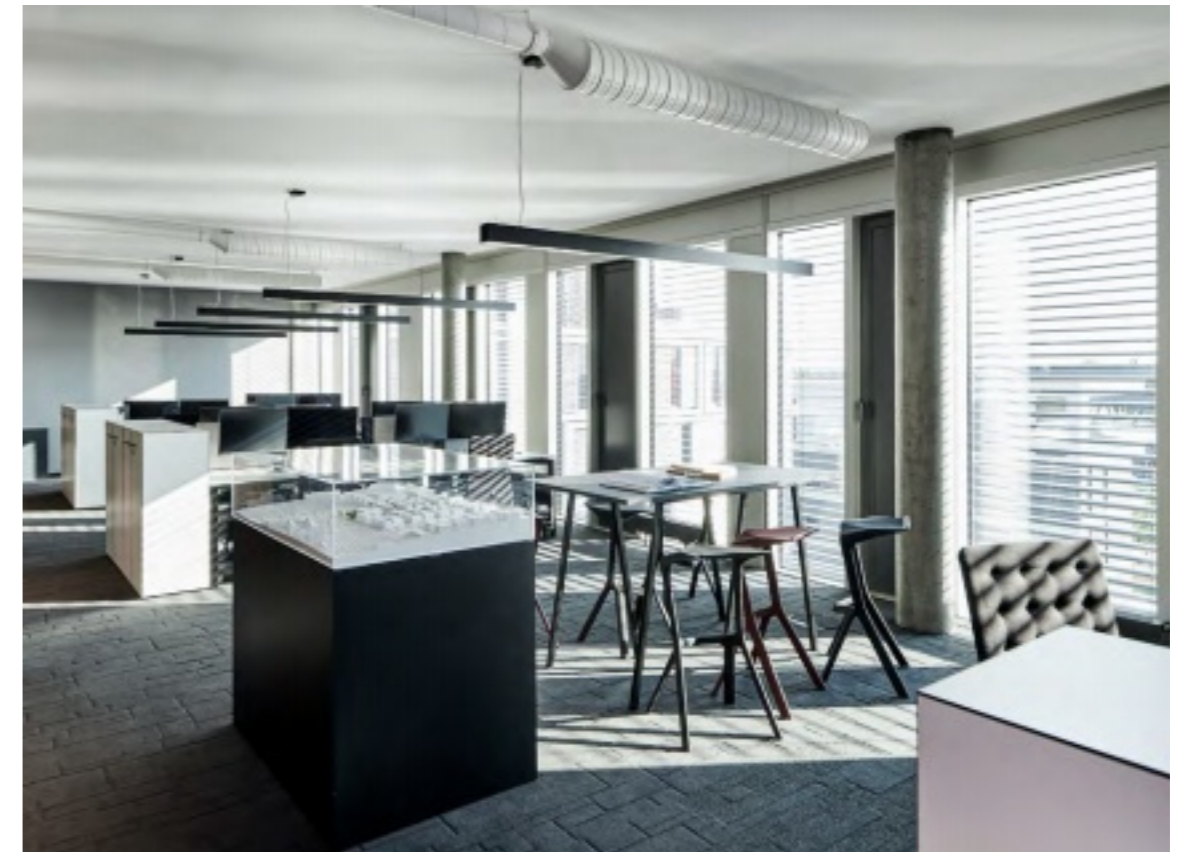

Enlightened by acoustics



SONIC

EN SONIC optimises lighting and room acoustics in one. The optional absorber elements emphasise the luminaire's modern design and ensure a pleasant acoustic environment. Alternatively, you can combine SONIC with sound-absorbing luminaire shades in 14 different colours. The cover with embossed microprisms promises outstanding lighting quality and workplace-friendly light. SONIC is available in the light colours 3000K or 4000K, and can be selected with a brightness and movement sensor, allowing the luminaire to react actively and energy-efficiently to its environment.

DE Mit SONIC optimieren Sie Beleuchtung und Raumakustik in einem. Die optionalen Absorber-Elemente unterstreichen das moderne Design der Leuchte und sorgen für ein angenehmes akustisches Umfeld. Alternativ können Sie SONIC mit schallabsorbierenden Leuchtschirmen in 14 verschiedenen Farben kombinieren. Die Abdeckung mit geprägten Mikroprismen verspricht sehr gute Lichtqualität und arbeitsplatztaugliches Licht. SONIC ist in den Lichtfarben 3000K bzw. 4000K verfügbar und kann auch mit einem Helligkeits- und Bewegungssensor ausgewählt werden – so reagiert die Leuchte aktiv und energieeffizient auf ihre Umwelt.

Types

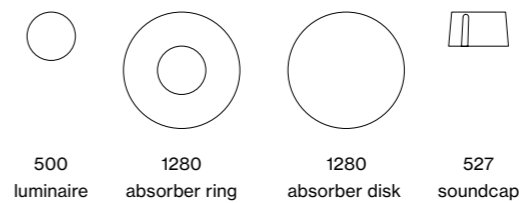

Mountings

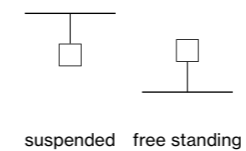

Light distributions

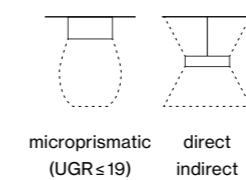



SONIC

suspended

EN Conical light housing in die-cast aluminium; powder coated; pendant fitting with cable suspension; with integrated tool-less suspension height adjustment; incl. transparent feed or with height adjustable rod suspension (chrome), feed in rod; direct/indirect light distribution; indirect component – special PCBs for increased luminous flux (max. ceiling illumination); completely homogeneous illumination; energy-eff. LEDs – very good colour rendering; canopy for through wiring; acoustic elements made of high-quality, self-supporting, recycled PET felt (high acoustic performance by doubling the material) or as an acoustically effective lampshade (large selection of colours) with sound absorbing properties

DE Konischer Leuchtenkörper aus Aluminium-druckguss; pulverbeschichtet; abgependelt mit Seilabhängung; werkzeuglose Höhenverstellung an der Leuchte; inkl. transparenter Einspeiseleitung oder mit kürzbarer Pendelrohrabhängung (chrom), Einspeiseleitung in Pendelrohr; direkt/indirekte Abstrahlcharakteristik; Indirektlichtant. – eigene Platinen f. erhöhten Lichtstrom (max. Deckenaufhellung); absolut homogene Ausleuchtung; energieeff. LEDs – sehr gute Farbwiedergabe; Baldachin für Weiterverdrahtung; Akustikelemente aus hochwertigem, selbsttragendem, recyceltem PET-Filz (hohe akustische Performance durch Materialaufdopplung) oder als akustisch wirksamer Leuchtschirm (große Farbauswahl) mit schallabsorbierenden Eigenschaften

Quickinfo

3000K, 4000K
CRI ≥ 80, 3 SDCM
up to 152lm/W
L90 @ 50 000h
DALI-2
brightness & presence sensor
microprismatic (UGR ≤ 19)

acoustic elements
♻️ from recycled material
🔥 available as B-s1, d0

Types

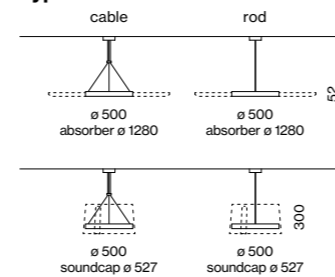

Luminaire colours



Acoustic colours



Light distribution

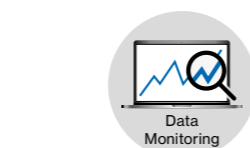

DiiA® standards
251, 252, 253

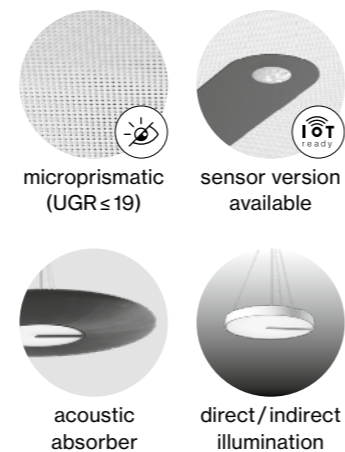

Order options

SUSPENSION 
cable 1500mm 2
rod 1000mm 4

COLOUR TEMPERATURE 
3000K 5
4000K 6

CONTROL 
DALI-2 3
ESSENTIAL sensor
(brightness & presence) 7

LUMINAIRE COLOUR 
○ pure white RAL 9010 7
● black grey RAL 7021 6
● special colours*  p. 992 X
*canopy always in white

ACOUSTIC COLOUR 
○ white W
● marble grey D
● felt grey G
● black L
● special colours  p. 992 X

LIGHT OPTIC COVER
microprismatic (UGR ≤ 19)

Options on request

COLOUR RENDERING INDEX
CRI ≥ 90

Light distribution

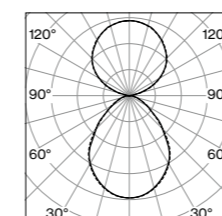

microprismatic
direct/indirect

LUMINOUS FLUX value calculated for
CRI ≥ 80, colour white, cover microprismatic

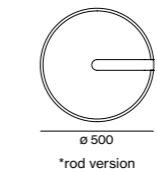
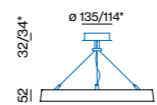

SONIC suspended



DIRECT/INDIRECT

SYSTEM POWER	COLOUR TEMP.	LUMINOUS FLUX	ORDER CODE
69W	3000K	↓ 5000/± 4940lm	0 5 9 - 7 7 2 1 1 1 P
	4000K	↓ 5290/± 5230lm	

Technical data

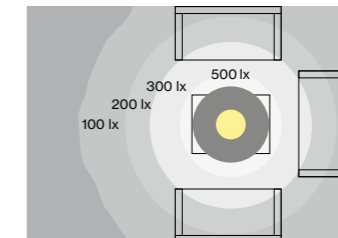

SONIC suspended, 69W, 4000K
direct/indirect with absorber

ROOM VALUES
Room dimensions 5.4 x 4 x 2.8m
Reflection factor 0.7 | 0.5 | 0.2
Maintenance factor 0.8
Mounting height 2.25m

CALCULATION SURFACE
Surface dimensions Floor
Surface height 0.5m



GLARE EVALUATION
Table Classification X=4H | Y=8H | S=0.25H
UGR transversal ≤ 19
UGR axial ≤ 19

Acoustic elements

SONIC ABSORBER ring

COLOUR	Ø-H (mm)	ORDER CODE
white	1280-50	0 5 9 - 7 7 1 1 1 1 W
marble grey	1280-50	0 5 9 - 7 7 1 1 1 1 D
black	1280-50	0 5 9 - 7 7 1 1 1 1 L

only in combination with SONIC suspended or SONIC free standing

SONIC ABSORBER DISK suspended

COLOUR	Ø-H (mm)	ORDER CODE
white	1280-50	0 5 9 - 7 7 2 2 1 1 W
marble grey	1280-50	0 5 9 - 7 7 2 2 1 1 D
black	1280-50	0 5 9 - 7 7 2 2 1 1 L

cable suspension 1500mm

SONIC SOUND CAP

TYPE	Ø-H (mm)	ORDER CODE
soundcap	527-300	0 5 9 - 7 7 3 1 1 1 ■

only in combination with SONIC suspended or SONIC free standing;
bracket colour white; other bracket colours on request;



C&P Immobilien AG headquarters
Graz, AT – by INNOCAD Architektur ZT



Secure Link Antwerp, BE –
by PROJECTARCHITECTUUR
including lighting design



← back

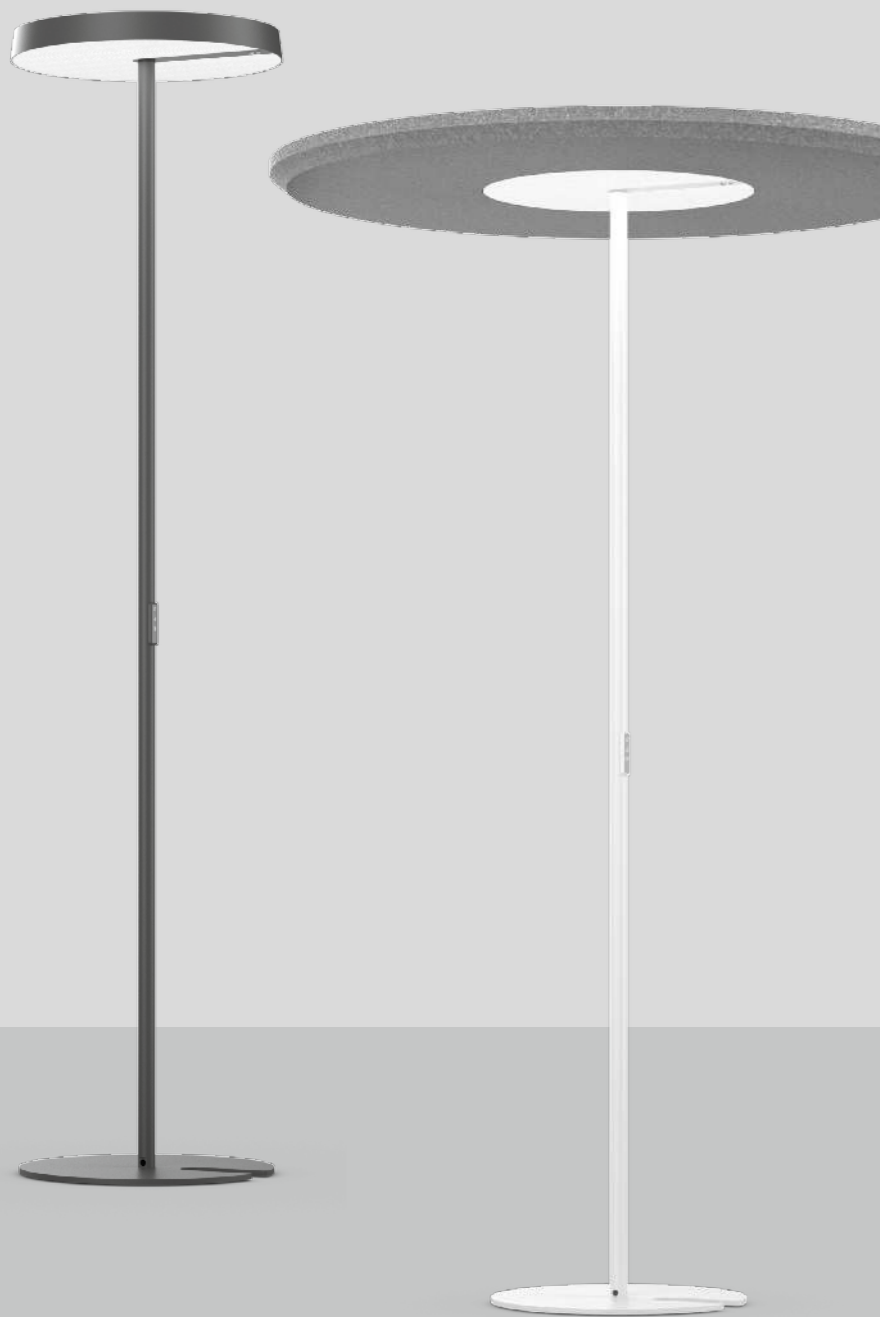

SONIC

free standing

EN Free standing luminaire with conical luminaire head in die-cast aluminium; powder coated; round aluminium downpipe arranged centralised or decentralised; round pedestal with recess for table base; direct/indirect light distribution; indirect component – special PCBs for increased luminous flux (max. ceiling illumination); optional: indirect component with special, inclined PCBs for asymmetric radiation characteristic; completely homogeneous illumination; energy-eff. LEDs – very good colour rendering; incl. connection cable (3 m) with safety plug; acoustic elements made of high-quality, self-supporting, recycled PET felt (high acoustic performance by doubling the material) or as an acoustically effective lampshade (large selection of colours) with sound absorbing properties

DE Stehleuchte mit konischem Leuchtenkopf aus Aluminiumdruckguss; pulverbeschichtet; rundes Aluminiumstandrohr wahlweise zentral oder dezentral angeordnet; runder Standfuß mit Ausnehmung für Tischfuß; direkt/indirekte Abstrahlcharakteristik; Indirektlichtant. – eigene Platinen f. erhöhten Lichtstrom (max. Deckenaufhellung); optional: Indirektlichtanteil mit eigenen, schräg gerichteten Platinen für asymmetrische Abstrahlcharakteristik; absolut homogene Ausleuchtung; energieeff. LEDs – sehr gute Farbwiedergabe; inkl. Anschlussleitung (3m) mit Schutzkontaktstecker; Akustikelemente aus hochwertigem, selbsttragendem, recyceltem PET-Filz (hohe akustische Performance durch Materialaufdopplung) oder als akustisch wirksamer Leuchtschirm (große Farbauswahl) mit schallabsorbierenden Eigenschaften

Quickinfo

3000K, 4000K
CRI ≥ 80, 3 SDCM
UGR ≤ 19 / 65° ≤ 3000 cd/m²
up to 152lm/W
L90 @ 50 000h
non DIM, touch DIM on pole
brightness & presence sensor
microprismatic (UGR ≤ 19)

acoustic elements
♻️ from recycled material
🔥 available as B-s1, d0

Types

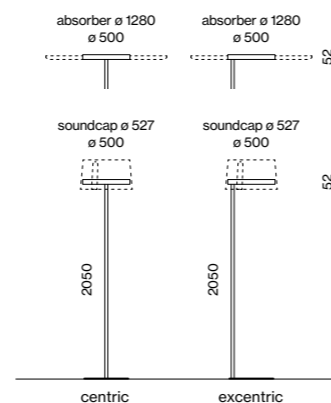

Luminaire colours



Acoustic colours



Light distribution

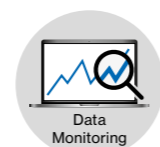

DiiA® standards
251, 252, 253



microprismatic
(UGR ≤ 19)



sensor version
available



direct/indirect
illumination

Order options

COLOUR TEMPERATURE	
3000K	5
4000K	6

CONTROL	
non DIM switch	1
touch DIM on pole	5
ESSENTIAL sensor (brightness & presence)	7

LUMINAIRE COLOUR	
○ pure white RAL 9010	7
● black grey RAL 7021	6
🌈 special colours p.992	X

ACOUSTIC COLOUR	
○ white	W
● marble grey	D
● felt grey	G
● black	L
🌈 special colours p.992	X

LIGHT OPTIC COVER	
microprismatic (UGR ≤ 19)	

Options on request

COLOUR RENDERING INDEX	
CRI ≥ 90	

CONTROL	
cluster network DIM	
dynamic daylight control (BPI)	
Zigbee 3.0	

Light distributions

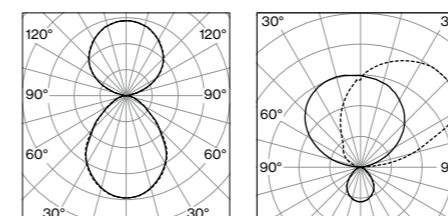

microprismatic
direct/indirect

microprismatic
direct/indirect asym. power

LUMINOUS FLUX value calculated for
CRI ≥ 80, colour white, cover microprismatic

SONIC centric pole free standing



DIRECT/INDIRECT

SYSTEM POWER	COLOUR TEMP.	LUMINOUS FLUX	ORDER CODE
69W	3000K	↓ 5000/± 4940lm	0 5 9 - 7 9 2 1 :: ▣ ▣ P
	4000K	↓ 5290/± 5230lm	

DIRECT/INDIRECT ASYMMETRIC POWER

SYSTEM POWER	COLOUR TEMP.	LUMINOUS FLUX	ORDER CODE
98W	3000K	↓ 2580/± 9300lm	0 5 9 - 7 9 4 1 :: ▣ ▣ P
	4000K	↓ 2730/± 9960lm	

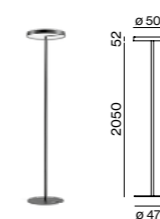

SONIC excentric pole free standing



DIRECT/INDIRECT

SYSTEM POWER	COLOUR TEMP.	LUMINOUS FLUX	ORDER CODE
69W	3000K	↓ 5000/± 4940lm	0 5 9 - 7 9 2 2 :: ▣ ▣ P
	4000K	↓ 5290/± 5230lm	

DIRECT/INDIRECT ASYMMETRIC POWER

SYSTEM POWER	COLOUR TEMP.	LUMINOUS FLUX	ORDER CODE
98W	3000K	↓ 2580/± 9300lm	0 5 9 - 7 9 4 2 :: ▣ ▣ P
	4000K	↓ 2730/± 9960lm	

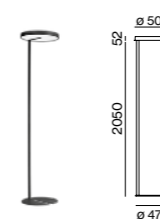

Technical data

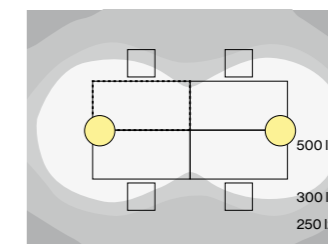

SONIC excentric pole free standing
69W, 4000K, direct/indirect

ROOM VALUES	
Room dimensions	5.4 × 4 × 2.8m
Reflection factor	0.7 0.5 0.2
Maintenance factor	0.8

CALCULATION SURFACE	
Surface dimensions	1.6 × 0.8
Surface height	0.75
Average illuminance (E _m)	> 500 lx
Uniformity (U ₀)	> 0.6

GLARE EVALUATION	
Table Classification X=4H Y=8H S=0.25H	
UGR transversal	≤ 19
UGR axial	≤ 19

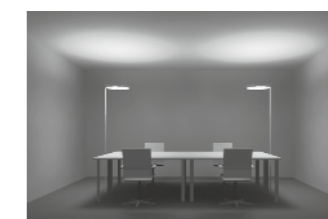

Acoustic elements

SONIC ABSORBER ring

COLOUR	Ø-H (mm)	ORDER CODE
white	1280-50	0 5 9 - 7 7 1 1 1 1 W
marble grey	1280-50	0 5 9 - 7 7 1 1 1 1 D
black	1280-50	0 5 9 - 7 7 1 1 1 1 L

only in combination with SONIC centric pole free standing;
for SONIC ABSORBER DISK suspended see p.619

SONIC SOUND CAP

TYPE	Ø-H (mm)	ORDER CODE
soundcap	527-300	0 5 9 - 7 7 3 1 1 1 ▣

only in combination with SONIC suspended or SONIC free standing;
bracket colour white; other bracket colours on request

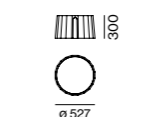
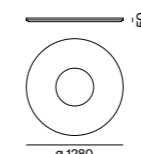

DocSander - Dentist Practice Room Munich, DE –
by architopia_christine detering
gramming Architekten



Lotus Bakeries Baar, CH –
lighting design by Lilarosso



Borealis AG Vienna, AT –
by burghardt zt gesmbh



Define the horizon

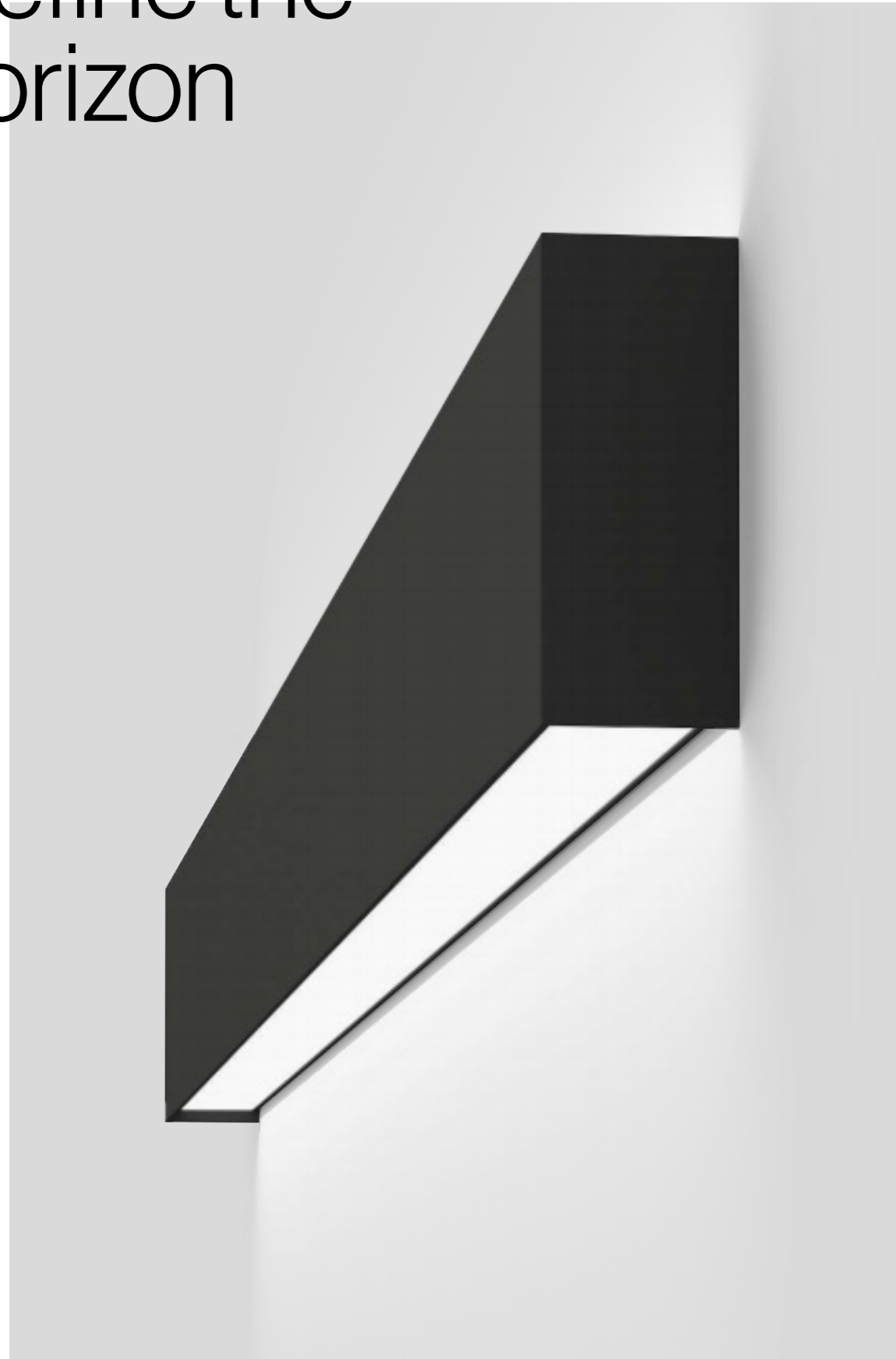

LINEA

EN Elegant room accentuation, highest performance. LINEA is a reduced, convertible luminaire for stylish wall, floor, and ceiling illumination. The extraordinarily narrow wall profile is completed by various lighting insets. Different beam patterns can be easily combined. For example, an opal cover for homogeneous illumination and asymmetrical illumination for brightening floors or ceilings. Spotlights can be chosen for elegant accentuation or as reading lights. LINEA is available as an individual decorative luminaire in different lengths. Choose between white, black, and special colours for the profile. The inserts optionally have a colour rendering of up to $\text{CRI} \geq 98$. In addition, the light inserts themselves can be selected in the light colours 2700K, 3000K, 4000K, or as a Tunable White option.

DE Elegante Raumakzentuierung und höchste Performance: LINEA ist eine reduzierte, jedoch wandelbare Leuchte für die stilvolle Wand-, Boden- und Deckenaufhellung. Das außerordentlich schmale Wandprofil wird durch unterschiedliche Lichteinsätze vervollständigt. Verschiedene Abstrahlcharakteristiken lassen sich einfach kombinieren: beispielsweise Opal-Cover für die homogene Ausleuchtung sowie asymmetrische Beleuchtung für Boden- oder Deckenaufhellung. Spots können zur eleganten Akzentuierung oder als Leselicht gewählt werden. LINEA ist als dekorative Einzelleuchte in verschiedenen Längen verfügbar. Bei der Profilfarbe haben Sie die Wahl zwischen Weiß, Schwarz und Spezialfarben. Die Inserts verfügen wahlweise über eine Farbwiedergabe von bis zu $\text{CRI} \geq 98$. Außerdem können die Lichteinsätze selbst in den Lichtfarben 2700K, 3000K, 4000K oder als Tunable White Option gewählt werden.

Mounting

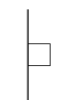

wall

Light distributions

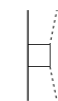

opal
opal

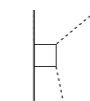

asymmetric
opal

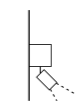

spot

← back

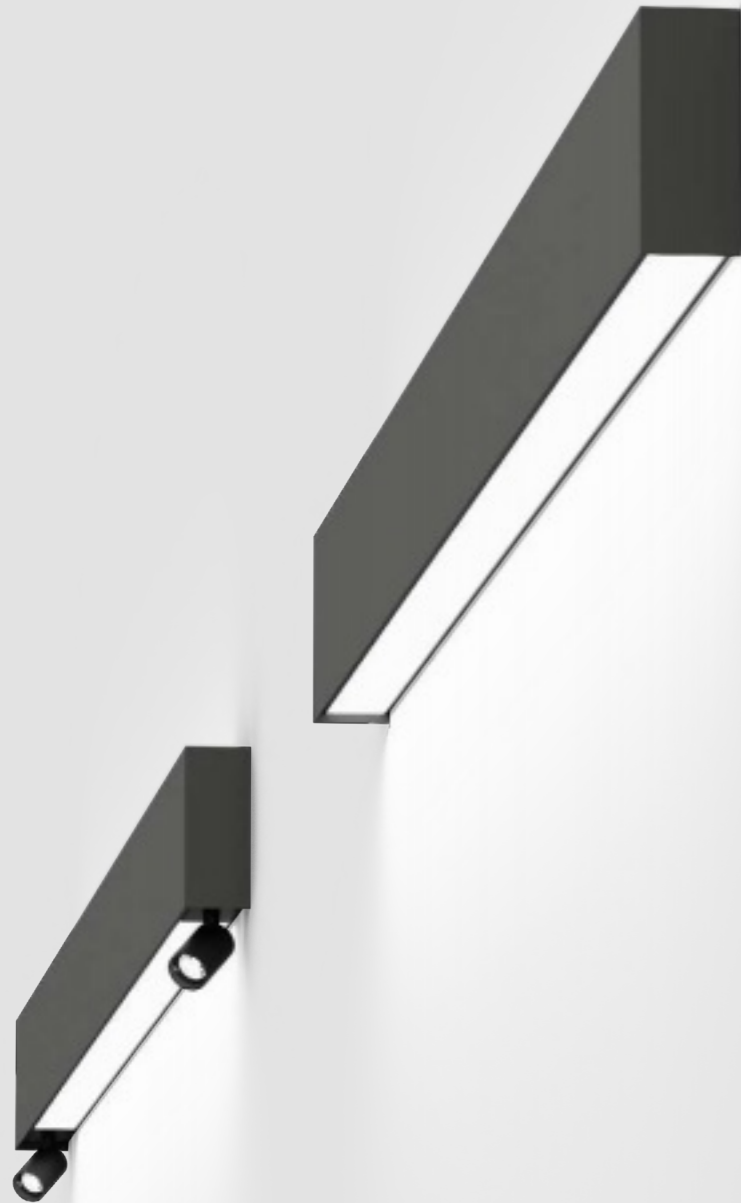

LINEA

wall

EN Luminaire housing and front cover from extruded aluminium profile, angular version; no visible screws; surface powder coated; suitable for wall mounting; homogeneous wall or ceiling illumination through uniform direct/indirect light distribution; HPO (High Performance Opal) cover for uniform illumination; or with specially computed, asymmetrical lens for homogeneous lighting intensity (installation optionally for floor or ceiling illumination); energy-efficient LEDs with very good colour rendering; optionally with switch for the JUST 26 spotlight modules

DE Leuchtenkörper und Frontabdeckung aus Aluminiumstrangpressprofil, kantige Ausführung; keine sichtbaren Schrauben; Oberfläche pulverbeschichtet; geeignet für Wandmontage; homogene Wand- bzw. Deckenaufhellung durch gleichmäßige direkt/indirekte Lichtverteilung; HPO (High Performance Opal) Abdeckung für homogene Ausleuchtung; oder mit speziell berechneter, asymmetrischer Linse für homogene Beleuchtungsstärken (Montage wahlweise zur Boden- oder Deckenaufhellung); energieeffiziente LEDs mit sehr guter Farbwiedergabe; optional mit Schalter für JUST 26 Strahlereinsätze

Quickinfo

3000K, 4000K, TW
 CRI ≥ 90, 3 SDCM
 up to 117lm/W
 L85 @ 50 000 h
 non DIM, DALI-2

Types

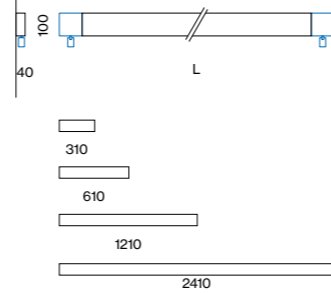

Colours



Light distributions

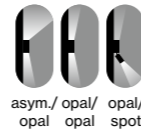

system solution (p.960)

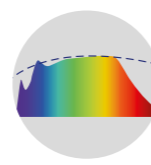

CRI ≥ 98 XPECTRUM

Order options

COLOUR TEMPERATURE	
3000K	5
4000K	6
tunable white 2700–5000K*	D

*available from L 610 mm | DALI-2 DT8

CONTROL	
non DIM	1
non DIM/switch (only spotlights)	2
DALI-2	3
DALI-2/switch (only spotlights)	4

MATERIAL COLOUR	
○ pure white RAL 9010	7
● jet black RAL 9005	8

SPOTLIGHT ALIGNMENT	
left	B
right	C
left and right	

spotlight(s) only with 3000K

Options on request

COLOUR RENDERING INDEX	
CRI ≥ 98 XPECTRUM	

COLOUR TEMPERATURE	
2700K	

MATERIAL COLOUR	
special colours	

Light distributions

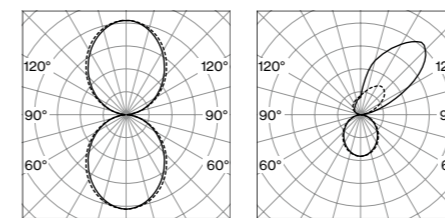

↓ opal high performance
 ↑ opal high performance

↓ opal high performance
 ↑ asymmetric

LUMINOUS FLUX value calculated for CRI ≥ 90, colour white, cover opal

LINEA wall

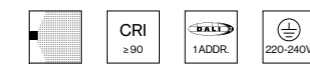

↓ OPAL HIGH PERFORMANCE / ↑ OPAL HIGH PERFORMANCE				
SYS. POWER	COLOUR TEMP.	LUMINOUS FLUX	L (mm)	ORDER CODE
14.7W	3000K	↓ 648/↑ 648lm	310	058-6171::↕↔AH
	4000K	↓ 715/↑ 715lm		
29.3W	3000K	↓ 1300/↑ 1300lm	610	058-6172::↕↔AH
	4000K	↓ 1430/↑ 1430lm		
59W	3000K	↓ 2590/↑ 2590lm	1210	058-6174::↕↔AH
	4000K	↓ 2860/↑ 2860lm		
111W	3000K	↓ 5190/↑ 5190lm	2410	058-6178::↕↔AH
	4000K	↓ 5720/↑ 5720lm		

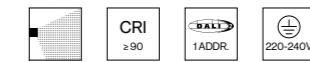

↓ OPAL HIGH PERFORMANCE / ↑ ASYMMETRIC				
SYS. POWER	COLOUR TEMP.	LUMINOUS FLUX	L (mm)	ORDER CODE
14.7W	3000K	↓ 648/↑ 821lm	310	058-6171::↕↔AA
	4000K	↓ 715/↑ 906lm		
29.3W	3000K	↓ 1300/↑ 1640lm	610	058-6172::↕↔AA
	4000K	↓ 1430/↑ 1810lm		
59W	3000K	↓ 2590/↑ 3280lm	1210	058-6174::↕↔AA
	4000K	↓ 2860/↑ 3620lm		
111W	3000K	↓ 5190/↑ 6570lm	2410	058-6178::↕↔AA
	4000K	↓ 5720/↑ 7250lm		



↓ OPAL HIGH PERFORMANCE / 1 SPOTLIGHT				
SYS. POWER	COLOUR TEMP.	LUMINOUS FLUX	L (mm)	ORDER CODE
29.3W	3000K	↓ 1300/↑ 1300lm	710	058-6172::↕↔H
	4000K	↓ 1430/↑ 1430lm		
59W	3000K	↓ 2590/↑ 2590lm	1310	058-6174::↕↔H
	4000K	↓ 2860/↑ 2860lm		
111W	3000K	↓ 5190/↑ 5190lm	2510	058-6178::↕↔H
	4000K	↓ 5720/↑ 5720lm		



↓ OPAL HIGH PERFORMANCE / 2 SPOTLIGHTS				
SYS. POWER	COLOUR TEMP.	LUMINOUS FLUX	L (mm)	ORDER CODE
59W/2x6W	3000K	↓ 2590/3280lm	1410	058-6174::↕↔DH
	4000K	↓ 2860/3620lm		
111W/2x6W	3000K	↓ 5190/6570lm	2610	058-6178::↕↔DH
	4000K	↓ 5720/7250lm		



Shaping the office environment

HEX-O

EN HEX-O is a sculptural light acoustics solution that features a modern design and fulfils two essential functions: lighting and room acoustics. State-of-the-art LED technology meets highly efficient acoustic elements to create an optimal working environment. The microprismatic cover provides glare-free light with $UGR \leq 19$. HEX-O with an opal cover creates a pleasant and homogeneous room illumination. The combinable polygonal acoustic elements made of 60% recycled PET fleece work through sound absorption and scattering for all-round balanced room acoustics.

DE HEX-O ist eine skulpturale Licht-Akustik-Lösung, die nicht nur durch ihr modernes Design überzeugt, sondern zwei wesentliche Funktionen erfüllt: Beleuchtung und Raumakustik. Modernste LED-Technologie trifft auf hocheffiziente Akustik Elemente, um ein optimales Arbeitsumfeld zu schaffen. Die mikroprismatische Abdeckung sorgt für blendfreies Licht mit $UGR \leq 19$. HEX-O mit Opal-Cover schafft eine angenehm homogene Raumausleuchtung. Die kombinierbaren polygonalen Akustik Elemente aus 60% recycelten PET-Vlies wirken durch Schallabsorption und gleichmäßige Streuung mehrfach für eine rundum ausgewogene Raumakustik.

Types

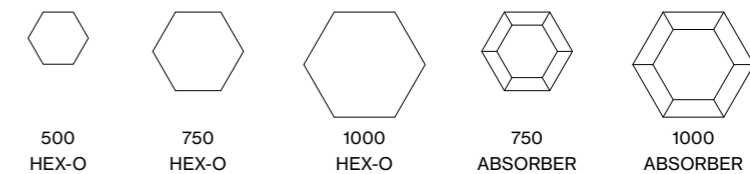

Mountings

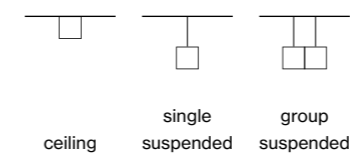

Light distributions

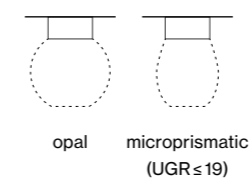

Recycled PET

EN HEX-O sound absorbers are made of optically high-quality PET fleece. The velvety, structured material is 60% recycled PET fleece and has optimal room-acoustic properties. A folding technique specially developed by XAL achieves completely smooth edges, which round off the acoustic bodies visually and in their acoustic efficiency.

DE HEX-O Schallabsorber bestehen aus optisch hochwertigem PET-Vlies. Das samtige, strukturierte Material aus 60% recyceltem PET-Vlies verfügt über optimale raumakustische Eigenschaften. Eine von XAL speziell entwickelte Falttechnik erzielt vollständig glatte Kanten, welche die Akustikkörper optisch und in ihrer Schallwirksamkeit abrunden.



Acoustic planning by XAL

EN Acoustic spatial planning calculates, measures, or simulates the behaviour of sound in a room. This planning includes, in particular, reverberation time and speech intelligibility. We create a bespoke concept from the results. Through close coordination with contracting planners and customers, we can achieve the optimum balance between light, ambience, and spatial acoustic conditions.

DE Bei einer akustischen Raumplanung berechnen, messen oder simulieren wir das Verhalten von Schall im Raum, darunter vor allem Nachhallzeit und Sprachverständlichkeit. Aus den Ergebnissen erstellen wir ein individuelles Konzept. Durch enge Abstimmung mit auftraggebenden Planern und Kunden können wir die optimale Balance zwischen Licht, Ambiente und raumakustischen Bedingungen erzielen.

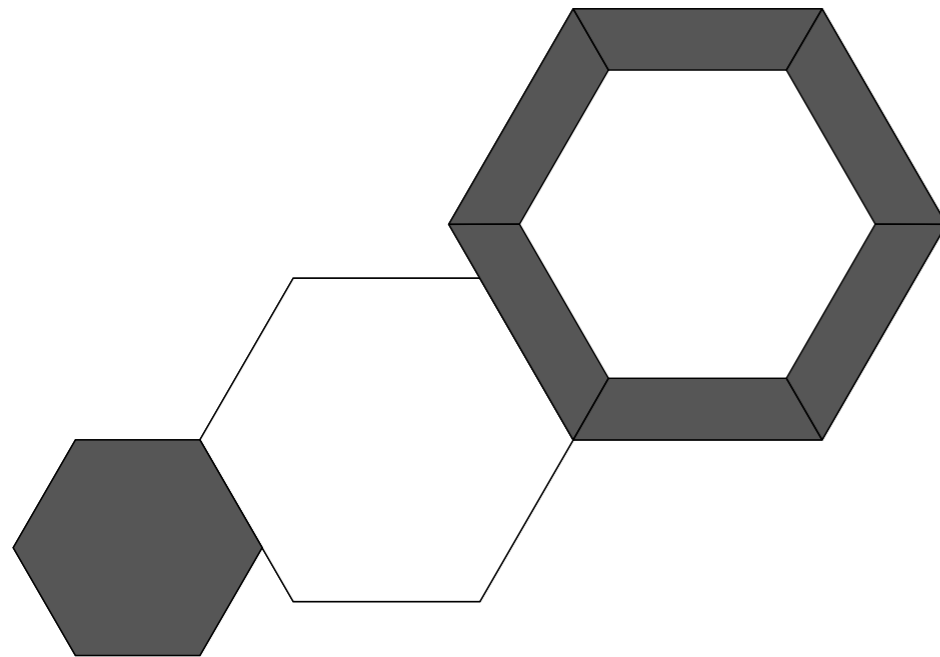

Sculpturing room acoustics

EN HEX-O effortlessly harmonises sound absorption and illumination. The flexible geometric elements can be arranged into decorative ceiling patterns and expanded at any time. The shape and surface of the three combinable acoustic components – Module, Flat, and Absorber – have multiple effects. The elements absorb higher, midlevel, and down to low frequencies, and scatter sound waves, resulting in noticeably balanced room acoustics.

DE HEX-O bringt Schallabsorption und Beleuchtung mühelos in Einklang. Die flexiblen, geometrischen Elemente lassen sich zu dekorativen Deckenbildern arrangieren und jederzeit erweitern. Form und Oberfläche der drei kombinierbaren Akustikelemente – Module, Flat und Absorber – wirken gleich mehrfach: Sie absorbieren hohe und mittlere bis tiefe Frequenzen und streuen Schall, mit dem Ergebnis einer spürbar ausgewogenen Raumakustik.

Light and sound for office

EN HEX-O was developed explicitly for office environments. Anti-glare prisms embossed into the cover create a uniform and glare-free light at the workplace. A striking design language combines standard-compliant office lighting and optimal room acoustics.

DE HEX-O wurde speziell für Office-Umgebungen entwickelt. In die Abdeckung geprägte Entblendungsprismen schaffen gleichmäßiges und blendfreies Licht am Arbeitsplatz. Normgerechte Bürobeleuchtung und optimale Raumakustik – vereint in einer markanten Formensprache.



← back

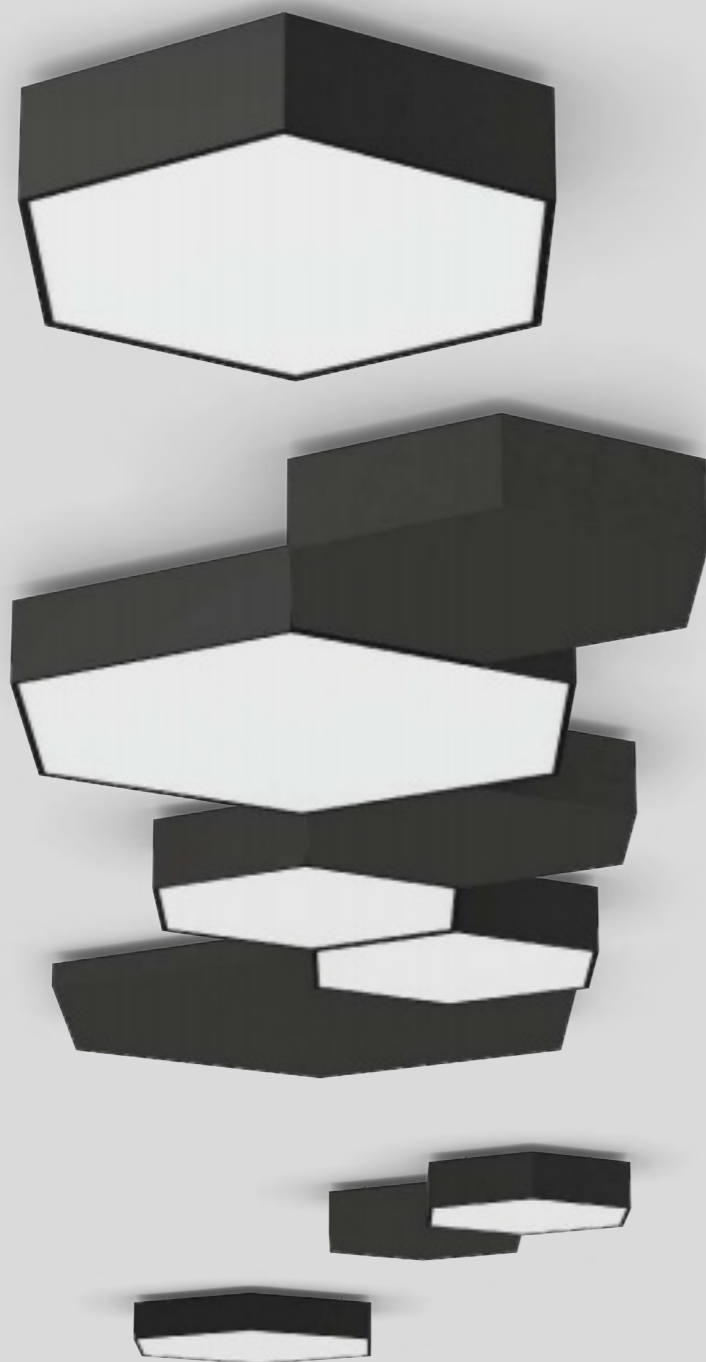

HEX-O

ceiling

EN Hexagonal luminaires & acoustic elements, suitable for single or group installation; quick mounting system without tools; light housing from extruded aluminium profile, seamlessly welded; surface powder coated; same luminance for all size versions; energy-efficient LEDs with very good colour rendering; plug-in terminals for through wiring; acoustic elements: MODULE in the luminaires' dimensions, FLAT with reduced height, ABSORBER to combine with other housings; acoustic element made of high-quality, recycled PET felt; improvement of room acoustics through absorption and scattering of sound waves

DE Sechseckige Leuchten & Akustikelemente, geeignet für Einzel- und Gruppenmontage; werkzeugloses Schnellmontagesystem; Leuchtenkörper aus Aluminiumstrangpressprofil, nahtlos verschweißt; Oberfläche pulverbeschichtet; gleiche Leuchtdichte bei allen Größenvarianten; energieeffiziente LEDs mit sehr guter Farbwiedergabe; Steckklemme für Weiterverdrahtung; Akustikelemente: MODULE in Abmessungen der Leuchten, FLAT mit reduzierter Höhe, ABSORBER zur Kombination mit anderen Körpern; Akustikelemente aus hochwertigem, recyceltem PET-Filz; Verbesserung der Raumakustik durch Absorption und Schallstreuung

Quickinfo

3000K, 4000K
 CRI ≥ 80, 3 SDCM
 UGR ≤ 19 / 65° ≤ 3000 cd/m²
 up to 142lm/W
 L90 @ 50 000h
 DALI-2
 opal, microprismatic (UGR ≤ 19)

acoustic elements
 up to absorption class A
 available as B-s1, d0

Types

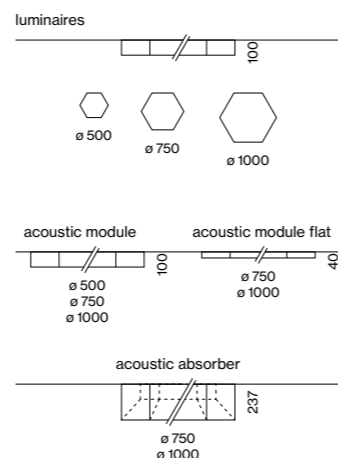

Luminaire colours



Acoustic colours



Light distribution



DiiA® standards
 251, 252, 253

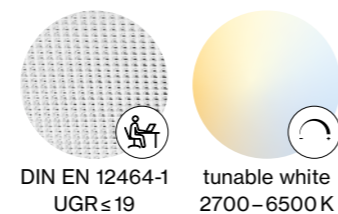

DIN EN 12464-1 UGR ≤ 19
 tunable white 2700–6500K

Order options

COLOUR TEMPERATURE	
3000K	5
4000K	6

CONTROL

DALI-2

LUMINAIRE COLOUR

<input type="radio"/> pure white RAL 9010	7
<input type="radio"/> jet black RAL 9005	8
<input type="radio"/> special colours p.992	X

ACOUSTIC COLOUR

<input type="radio"/> white	W
<input type="radio"/> marble grey	D
<input type="radio"/> felt grey	G
<input type="radio"/> black	L
<input type="radio"/> special colours p.992	X

LIGHT OPTIC COVER

opal	O
microprismatic (UGR ≤ 19)	P

Options on request

COLOUR RENDERING INDEX
 CRI ≥ 90

COLOUR TEMPERATURE

tunable white 2700–6500K
 DALI-2 DT8

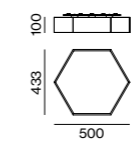

HEX-O 500 ceiling



SINGLE AND GROUP MOUNTING

SYSTEM POWER	COLOUR TEMP.	LUMINOUS FLUX	ORDER CODE
16.3W	3000K	2160lm	073-615113
	4000K	2290lm	

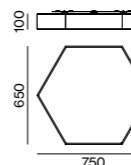

HEX-O 750 ceiling



SINGLE AND GROUP MOUNTING

SYSTEM POWER	COLOUR TEMP.	LUMINOUS FLUX	ORDER CODE
35W	3000K	4680lm	073-616113
	4000K	4960lm	

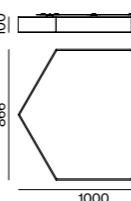

HEX-O 1000 ceiling



SINGLE AND GROUP MOUNTING

SYSTEM POWER	COLOUR TEMP.	LUMINOUS FLUX	ORDER CODE
68W	3000K	9110lm	073-617113
	4000K	9640lm	

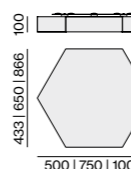

Acoustic elements

HEX-O MODULE ceiling

SINGLE AND GROUP MOUNTING

TYPE	ORDER CODE
MODULE 500 ceiling	073-691510
MODULE 750 ceiling	073-691610
MODULE 1000 ceiling	073-691710

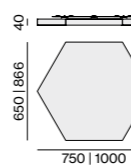

HEX-O MODULE FLAT ceiling

SINGLE AND GROUP MOUNTING

TYPE	ORDER CODE
MODULE FLAT 750 ceiling	073-691620
MODULE FLAT 1000 ceiling	073-691720

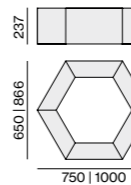

HEX-O ABSORBER

SINGLE AND GROUP MOUNTING

TYPE	ORDER CODE
ABSORBER 750*	073-691640
ABSORBER 1000**	073-691740

*only in combination with HEX-O 500 or MODULE 500

**only in combination with HEX-O 750, MODULE 750 or FLAT 750

LUMINOUS FLUX value calculated for
 CRI ≥ 80, colour white, cover opal



← back



HEX-O

suspended (single mounted)

EN Hexagonal luminaires & acoustic elements; suitable for single installation; pendant fitting with cable suspension (3 cables); height adjustment without tools; light housing from extruded aluminium profile, seamlessly welded; powder coated; same luminance for all size versions; energy-efficient LEDs with very good colour rendering; transparent feed, canopy for through wiring (included); acoustic element made of high-quality, recycled PET felt: MODULE in the luminaires' dimensions, FLAT with reduced height, ABSORBER to combine with other housings; improvement of room acoustics (absorption & scattering of sound waves)

DE Sechseckige Leuchten & Akustikelemente; geeignet für Einzelmontage; abgependelt mit Seilabhängung (3 Seile); werkzeuglose Höhenverstellung; Leuchtenkörper aus Aluminiumstrangpressprofil, nahtlos verschweißt; pulverbeschichtet; gleiche Leuchtdichte bei allen Größenvarianten; energieeffiziente LEDs mit sehr guter Farbwiedergabe; transparente Einspeiseleitung, Baldachin für Weiterverdrahtung (inkludiert); Akustikelemente aus hochwertigem, recyceltem PET-Filz: MODULE in Abmessungen der Leuchten, FLAT mit reduzierter Höhe, ABSORBER zur Kombination mit anderen Körpern; Verbesserung der Raumakustik (Absorption & Schallstreuung)

Quickinfo

3000K, 4000K
 CRI ≥ 80, 3 SDCM
 UGR ≤ 19 / 65° ≤ 3000 cd/m²
 up to 142lm/W
 L90 @ 50 000h
 DALI-2
 opal, microprismatic (UGR ≤ 19)

acoustic elements
 up to absorption class A
 available as B-s1, d0

Types

luminaires

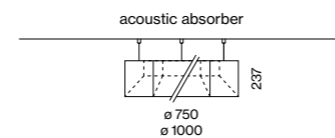
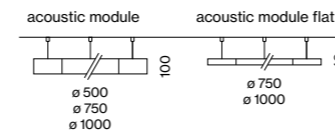
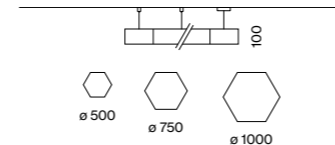

Luminaire colours



Acoustic colours



Light distribution

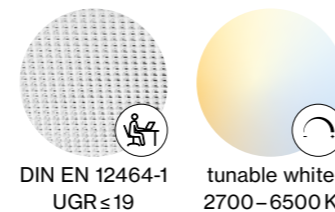
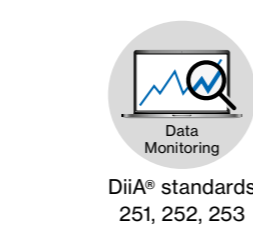

Order options

COLOUR TEMPERATURE	
3000K	5
4000K	6

CONTROL	
DALI-2	

LUMINAIRE COLOUR	
○ pure white RAL 9010	7
● jet black RAL 9005	8
● special colours* p. 992	X

*canopy always in white

ACOUSTIC COLOUR	
○ white	W
● marble grey	D
● felt grey	G
● black	L
● special colours p. 992	X

LIGHT OPTIC COVER	
opal	O
microprismatic (UGR ≤ 19)	P

Options on request

COLOUR RENDERING INDEX	
CRI ≥ 90	

COLOUR TEMPERATURE	
tunable white 2700-6500K	
DALI-2 DT8	

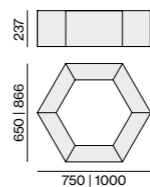
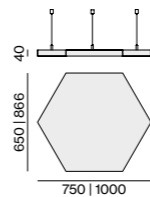
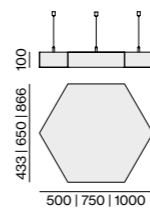
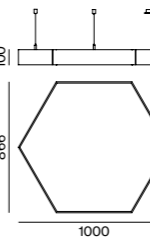
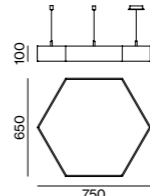
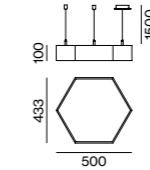

HEX-O 500 suspended

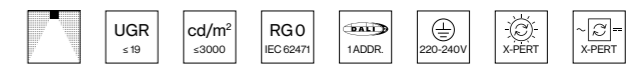

SINGLE MOUNTING				ORDER CODE
SYSTEM POWER	COLOUR TEMP.	LUMINOUS FLUX		
16.3W	3000K	2160lm		073-62510
	4000K	2290lm		

HEX-O 750 suspended

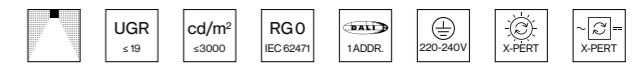

SINGLE MOUNTING				ORDER CODE
SYSTEM POWER	COLOUR TEMP.	LUMINOUS FLUX		
35W	3000K	4680lm		073-62610
	4000K	4960lm		

HEX-O 1000 suspended

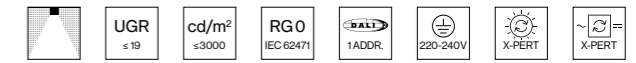

SINGLE MOUNTING				ORDER CODE
SYSTEM POWER	COLOUR TEMP.	LUMINOUS FLUX		
68W	3000K	9110lm		073-62710
	4000K	9640lm		

Acoustic elements

HEX-O MODULE suspended

SINGLE MOUNTING		ORDER CODE
TYPE		
MODULE 500 suspended		073-692510
MODULE 750 suspended		073-692610
MODULE 1000 suspended		073-692710

HEX-O MODULE FLAT suspended

SINGLE MOUNTING		ORDER CODE
TYPE		
MODULE FLAT 750 suspended		073-692620
MODULE FLAT 1000 suspended		073-692720

HEX-O ABSORBER

SINGLE MOUNTING		ORDER CODE
TYPE		
ABSORBER 750*		073-691640
ABSORBER 1000**		073-691740

*only in combination with HEX-O 500 or MODULE 500

**only in combination with HEX-O 750, MODULE 750 or FLAT 750

LUMINOUS FLUX value calculated for CRI ≥ 80, colour white, cover opal

← back



HEX-O

suspended (group mounted)

EN Hexagonal luminaires & acoustic elements; suitable for group installation; pendant fitting with cable suspension (1 cable); height adjustment without tools; rear rail for alignment; light housing from extruded aluminium profile, seamlessly welded; powder coated; same luminance for all size versions; energy-efficient LEDs with very good colour rendering; transparent feed, canopy for through wiring (separately available); acoustic element made of high-quality, recycled PET felt: MODULE in the luminaires' dimensions, FLAT with reduced height, ABSORBER to combine with other housings; improvement of room acoustics (absorption & scattering of sound waves)

DE Sechseckige Leuchten & Akustikelemente; geeignet für Gruppenmontage; abgependelt mit Seilabhängung (1 Seil); werkzeuglose Höhenverstellung; rückseitige Schiene zur Ausrichtung; Leuchtenkörper aus Aluminiumstrangpressprofil, nahtlos verschweißt; pulverbeschichtet; gleiche Leuchtdichte bei allen Größenvarianten; energieeffiziente LEDs mit sehr guter Farbwiedergabe; transparente Einspeiseleitung, Baldachin für Weiterverdrahtung (separat zu bestellen); Akustikelemente aus hochwertigem, recyceltem PET-Filz: MODULE in Abmessungen der Leuchten, FLAT mit reduzierter Höhe, ABSORBER zur Kombination mit anderen Körpern; Verbesserung der Raumakustik (Absorption & Schallstreuung)

Quickinfo

3000K, 4000K
 CRI ≥ 80, 3 SDCM
 UGR ≤ 19 / 65° ≤ 3000 cd/m²
 up to 142lm/W
 L90 @ 50 000h
 DALI-2
 opal, microprismatic (UGR ≤ 19)

acoustic elements
 up to absorption class A
 available as B-s1, d0

Types

luminaires

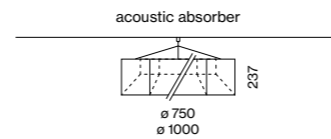
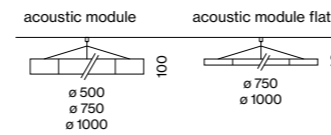
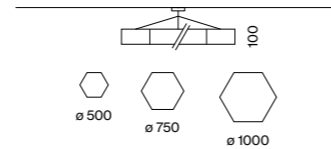

Luminaire colours



Acoustic colours



Light distribution



direct



DiiA® standards
 251, 252, 253

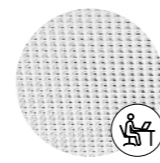

DIN EN 12464-1
 UGR ≤ 19

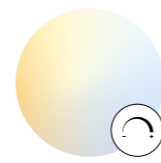

tunable white
 2700-6500K

Order options

COLOUR TEMPERATURE	
3000K	5
4000K	6

CONTROL

DALI-2

LUMINAIRE COLOUR

<input type="radio"/> pure white RAL 9010	7
<input type="radio"/> jet black RAL 9005	8
<input type="radio"/> special colours* p.992	X

*canopy always in white;
 not for power feeder

ACOUSTIC COLOUR

<input type="radio"/> white	W
<input type="radio"/> marble grey	D
<input type="radio"/> felt grey	G
<input type="radio"/> black	L
<input type="radio"/> special colours p.992	X

LIGHT OPTIC COVER

<input type="radio"/> opal	O
<input type="radio"/> microprismatic (UGR ≤ 19)	P

Options on request

COLOUR RENDERING INDEX

CRI ≥ 90

COLOUR TEMPERATURE

tunable white 2700-6500K

DALI-2 DT8

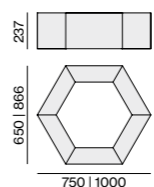
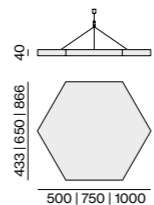
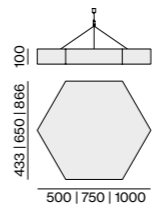
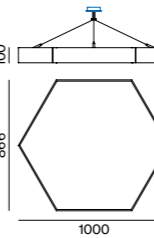
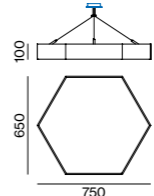
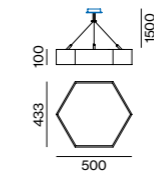

HEX-O 500 suspended

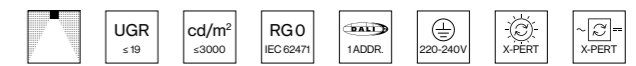

GROUP MOUNTING

SYSTEM POWER	COLOUR TEMP.	LUMINOUS FLUX	ORDER CODE
16.3W	3000K	2160lm	073-63510
	4000K	2290lm	

HEX-O 750 suspended

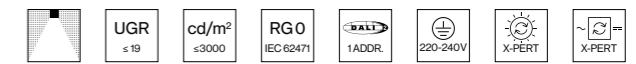

GROUP MOUNTING

SYSTEM POWER	COLOUR TEMP.	LUMINOUS FLUX	ORDER CODE
35W	3000K	4680lm	073-63610
	4000K	4960lm	

HEX-O 1000 suspended

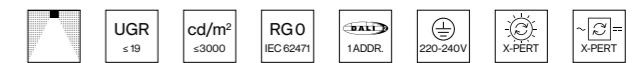

GROUP MOUNTING

SYSTEM POWER	COLOUR TEMP.	LUMINOUS FLUX	ORDER CODE
68W	3000K	9110lm	073-63710
	4000K	9640lm	

Electrical accessories

CANOPY

TYPE	L (mm)	ORDER CODE
canopy / feeder cable 5 × 1.5 mm²	1500	005-223241

one per group needed; can be placed above luminaires or acoustic elements for electrical system configuration see luminaire data sheet at xal.com

Acoustic elements

HEX-O MODULE suspended

GROUP MOUNTING

TYPE	ORDER CODE
MODULE 500 suspended	073-693510
MODULE 750 suspended	073-693610
MODULE 1000 suspended	073-693710

HEX-O MODULE FLAT suspended

GROUP MOUNTING

TYPE	ORDER CODE
MODULE FLAT 750 suspended	073-693620
MODULE FLAT 1000 suspended	073-693720

HEX-O ABSORBER

GROUP MOUNTING

TYPE	ORDER CODE
ABSORBER 750*	073-691640
ABSORBER 1000**	073-691740

*only in combination with HEX-O 500 or MODULE 500

**only in combination with HEX-O 750, MODULE 750 or FLAT 750

LUMINOUS FLUX value calculated for
 CRI ≥ 80, colour white, cover opal

OLX GROUP Poznań, PL –
by Trzop Architekci with
lighting design by Pluslighting



EANS Flight Control Centre
Harju Grafschaft, EE –
by KAMP Arhitektid



The sound of stress-free work



MUSE

EN We developed MUSE for holistic office lighting and acoustic concepts. All of the three-part product family's elements optimise room acoustics. The two luminous versions create standard-compliant, screen-friendly workplace lighting per $UGR \leq 19$ thanks to high-quality reflectors with faceted optics. Its characteristic design language, different colours, and the haptically appealing surface make MUSE a confident design element in the office.

DE Mit MUSE haben wir ein Produkt für ganzheitliche Licht- und Akustikkonzepte für Büros entwickelt. Alle Elemente der dreiteiligen Produktfamilie optimieren die Raumakustik effektiv, die zwei leuchtenden Varianten schaffen zudem durch hochwertige Reflektoren mit Facettenoptik normgerechte bildschirmtaugliche Arbeitsplatzbeleuchtung gemäß $UGR \leq 19$. In ihrer charakteristischen Formensprache, den verschiedenen Farben und der haptisch ansprechenden Oberfläche ist MUSE zudem ein selbstbewusstes Designelement im Office.

Types

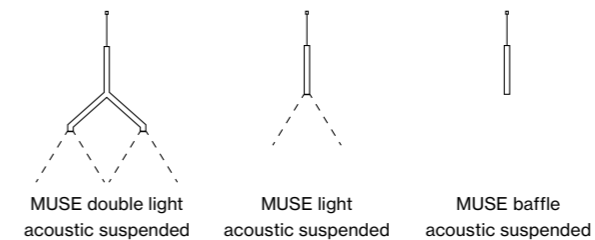

Light and sound for offices

EN Light and acoustics are the most critical factors influencing well-being at work. A quiet working environment boosts concentration and enhances the enjoyment of work and productivity. That is why XAL developed the three-part MUSE system in response to the most significant challenges of modern office environments.

DE Licht und Akustik sind die wichtigsten Einflussfaktoren auf Wohlbefinden am Arbeitsplatz: Ein ruhiges Arbeitsumfeld erhöht die Konzentration und steigert sowohl die Freude an der Arbeit als auch die Produktivität. Deshalb entwickelte XAL das dreiteilige MUSE-System als Antwort auf die größten Herausforderungen moderner Bürowelten.

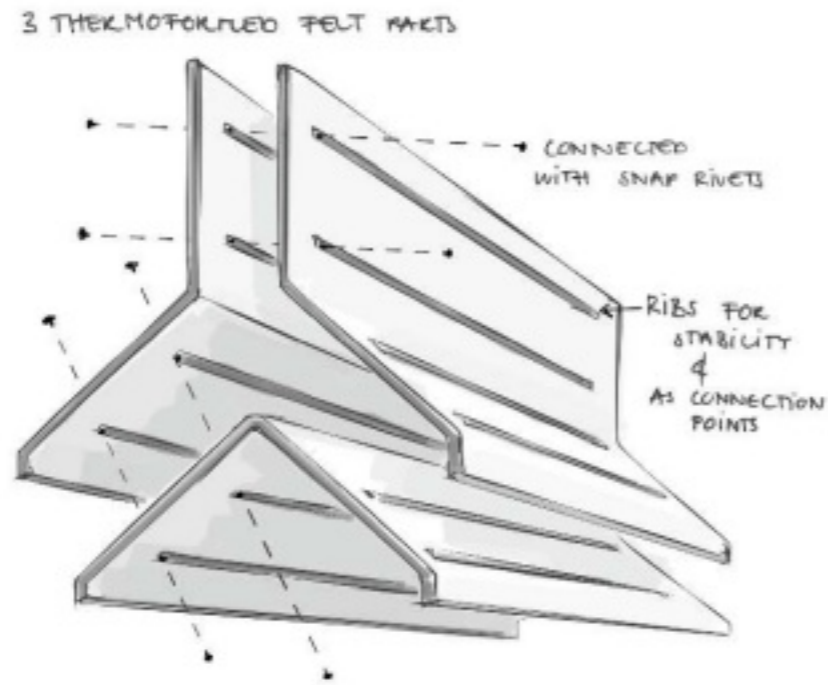

Full-spectrum LED

EN XAL's new XPECTRUM LEDs deliver healthy, biologically effective light. The reduced blue light and increased cyan values reduce the blue light hazard for the eye to daylight-equivalent levels. The resulting non-visual, so-called melanopic light effect, improves concentration and increases sleep quality. The excellent colour rendering of IES TM 30-15 $R_f=98$ and $R_g=101$ further helps visual comfort.

DE Die neue XPECTRUM LED von XAL sorgt für gesundes, biologisch wirksames Licht. Der reduzierte Blaulichtanteil sowie die erhöhten Cyan-Werte minimieren die Blaulichtgefahr für das Auge auf ein tagelichtähnliches Niveau. Die daraus resultierende nichtvisuelle, auch melanopische Lichtwirkung genannt, fördert die Konzentration und steigert die Schlafqualität. Die hervorragende Farbwiedergabe von IES TM 30-15 $R_f=98$ und $R_g=101$ ermöglicht zudem einen verbesserten Sehkomfort.

XPECTRUM LED

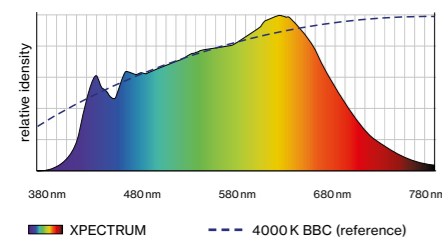

Commercially available LED 4000K

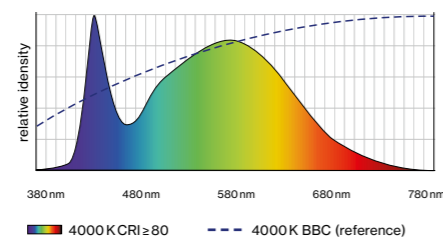

Second life for PET bottles

EN The MUSE acoustic elements' felt-like material is made of 50% recycled PET. Pressed precisely into shape, it combines three advantages. It is inherently stable, acoustically highly effective, and has a visually and haptically inspiring surface. This is how MUSE creates a pleasant atmosphere while taking its environmental responsibility seriously.

DE Das filzartige Material der MUSE Akustikelemente wird zu 50% aus recyceltem PET hergestellt. Präzise in Form gepresst, verbindet es drei Vorteile: Es ist eigenstabil, akustisch höchst wirksam und hat eine optisch wie haptisch spannende Oberfläche. So schafft MUSE eine angenehme Atmosphäre bei gleichzeitig hoher Umweltverantwortung.



Colour variety

EN What kind of office should be equipped with MUSE? With two neutral shades and two accent colours, MUSE can be integrated into any furnishing concept whether classically understated or hip and unconventional.

DE Welche Art von Büro soll mit MUSE ausgestattet werden? Ob klassisch dezent oder hip und unkonventionell: Mit zwei neutralen Farbtönen und zwei Akzentfarben integriert sich MUSE in jedes Einrichtungskonzept.

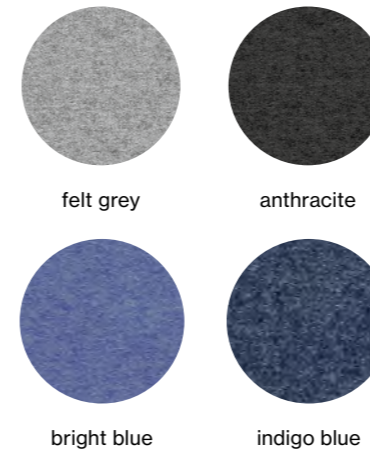

Screen-work friendly

EN MUSE has been optimised for computer workstations. Thanks to glare-free reflectors, the luminaires achieve a $UGR \leq 19$ value, creating a pleasantly bright working environment without glare.

DE MUSE wurde speziell für den Bildschirmarbeitsplatz optimiert. Durch entblendende Reflektoren erreichen die Leuchten einen UGR -Wert ≤ 19 : Es entsteht eine angenehm helle Arbeitsumgebung ohne Blendung.



Acoustic planning by XAL

EN Acoustic spatial planning calculates, measures, or simulates the behaviour of sound in a room. This planning includes, in particular, reverberation time and speech intelligibility. We create a bespoke concept from the results. Through close coordination with contracting planners and customers, we can achieve the optimum balance between light, ambience, and spatial acoustic conditions.

DE Bei der akustischen Raumplanung berechnen, messen oder simulieren wir das Verhalten von Schall im Raum, darunter vor allem Nachhallzeit und Sprachverständlichkeit. Aus den Ergebnissen erstellen wir ein individuelles Konzept. Durch enge Abstimmung mit auftraggebenden Planern und Kunden können wir die optimale Balance zwischen Licht, Ambiente und raumakustischen Bedingungen erzielen.

← back



MUSE double light

acoustic suspended

EN Luminaire body made of high-quality, self-supporting, recycled PET felt with sound absorbing properties; high-quality visual and tactile surface; constructed of 2 shells to form cavities that improve acoustic performance; large sound absorbing surface; pendant fitting with cable suspension; with integrated tool-less suspension height adjustment; optimised for the illumination of 2 office workstations opposite each other; incl. transparent feed; light inset made from extruded profile for improved thermal management; high-gloss reflector with faceted design; energy-efficient LEDs with very good colour rendering

DE Leuchtenkörper aus hochwertigem, selbsttragendem, recyceltem PET-Filz mit schallabsorbierenden Eigenschaften; optisch und haptisch hochwertige Oberfläche; Aufbau aus 2 Schalen, dadurch bilden sich Hohlräume zur Verbesserung der akustischen Performance; große schallabsorbierende Oberfläche; abgependelt mit Seilabhängung; werkzeuglose Höhenverstellung an der Leuchte; optimiert zur Ausleuchtung von 2 gegenüberliegend angeordneten Büroarbeitsplätzen; inkl. transparenter Einspeiseleitung; Lichteinsatz aus Strangpressprofil für verbessertes Thermomanagement; hochglänzender Reflektor mit Facettenoptik; energieeffiziente LEDs mit sehr guter Farbwiedergabe

Quickinfo

3000K, 4000K
 CRI ≥ 80, 3 SDCM
 UGR ≤ 19 / 65° ≤ 1500 cd/m²
 up to 108lm/W
 L90 @ 50 000h
 DALI-2
 reflector (UGR ≤ 19)

PET felt
 ♻️ from recycled material
 up to absorber class A

Type

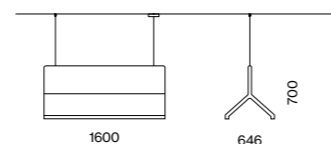

Colours



Light distribution



direct

Order options

COLOUR TEMPERATURE	
3000K	5
4000K	6

CONTROL

DALI-2

MATERIAL COLOUR

- anthracite B
- felt grey G
- bright blue P
- indigo blue E

canopy always in white
 other colours on request

LIGHT INSET COLOUR

grey cover / chrome reflector

Options on request

COLOUR RENDERING INDEX
 CRI ≥ 98 XPECTRUM

CONTROL

brightness & presence sensor

LIGHT INSET COLOUR

- black cover / black reflector
- white cover / chrome reflector
- black cover / chrome reflector

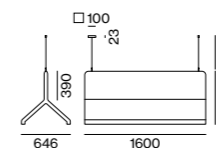
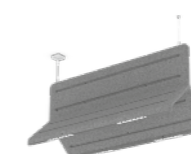

MUSE DOUBLE LIGHT suspended



ACOUSTIC LUMINAIRE

SYS. POWER	COLOUR TEMP.	LUM. FLUX	L (mm)	ORDER CODE
41W	3000K	4160lm	1600	0 9 1 - 1 2 2 1 :: 3 ▣ F
	4000K	4400lm		

Lighting calculation



MUSE DOUBLE LIGHT

41W direct, 4000K, chrome reflector

ROOM VALUES

Room dimensions	5.4 × 4 × 3 m
Room volume	64.8 m³
Reflection factor	0.7 0.5 0.2
Maintenance factor	0.8
Mounting height	2.23 m

CALCULATION SURFACE

Surface dimensions	1.6 × 0.8
Surface height	0.75 m
Average illuminance (E _m)	> 500 lx
Uniformity (U ₀)	> 0.6

GLARE EVALUATION

Table Classification X=4H Y=8H S=0.25H	
UGR transversal	≤ 19
UGR axial	≤ 19
≥ 65° ≤ 1500 cd/m²	

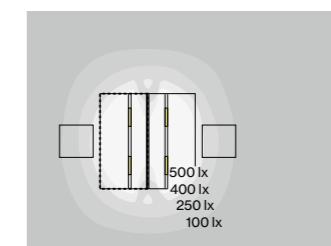

Data Monitoring
 DiiA® standards
 251, 252, 253



DIN EN 12464-1
 UGR ≤ 19

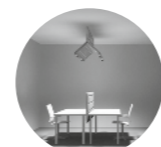

suitable for double
 workstation

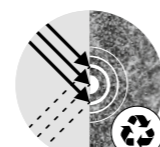

sound absorption
 by recycled PET

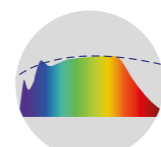

CRI ≥ 98
 XPECTRUM

Light distribution

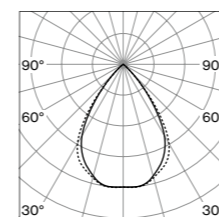

chrome reflector
 direct

LUMINOUS FLUX value calculated for
 CRI ≥ 80, cover grey, reflector chrome



Inter-pool Immobilien Vienna, AT –
by Inter-pool Immobilien GmbH /
Architekt DI Stephan Kopinits includ-
ing lighting design



Vogel Corporate Solutions GmbH
Würzburg, DE – by Dipl. Ing. FH
Katharina Maatz/ designfunktion
Aschaffenburg GmbH



← back

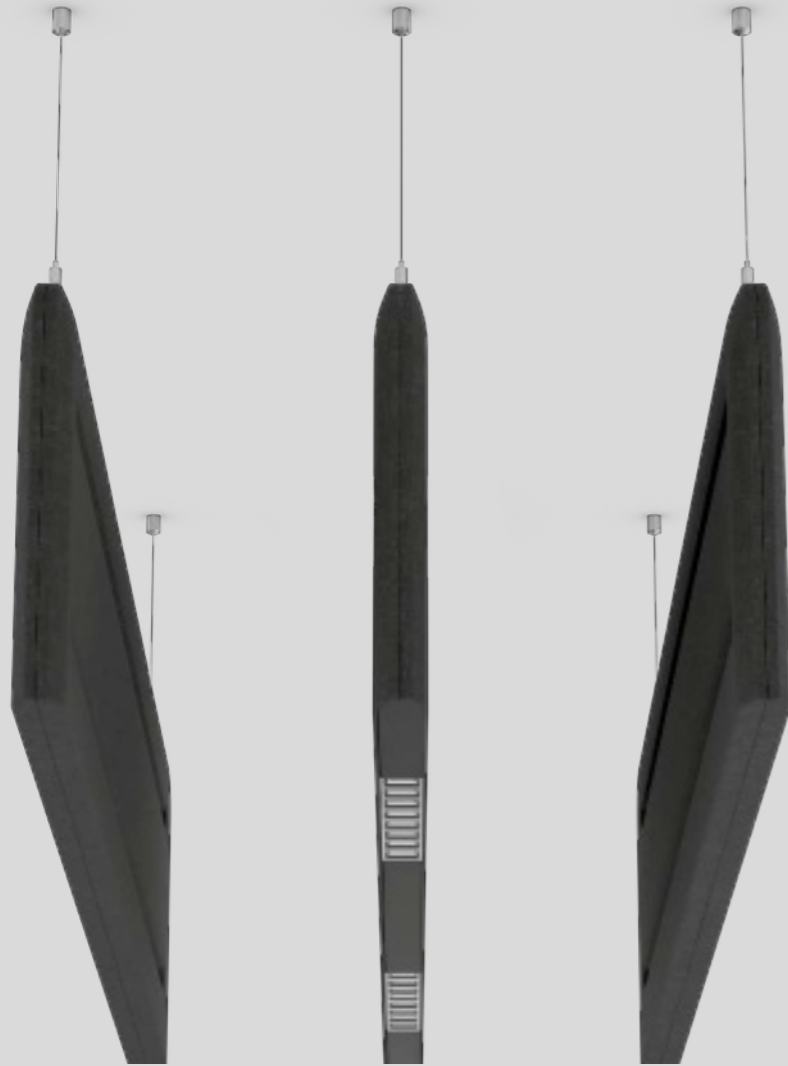

MUSE light/baffle

acoustic suspended

EN Luminaire body or acoustic element made of high-quality, self-supporting, recycled PET felt with sound absorbing properties; high-quality visual and tactile surface; constructed of 2 shells to form cavities that improve acoustic performance; large sound absorbing surface; pendant fitting with cable suspension; tool-less suspension height adjustment of the luminaire or of the acoustic element; MUSE LIGHT: optimised for the illumination of office workstations; incl. transparent feed; light inset made from extruded profile for improved thermal management; high-gloss reflector with faceted design; energy-efficient LEDs with very good colour rendering

DE Leuchtenkörper bzw. Akustikelement aus hochwertigem, selbsttragendem, recyceltem PET-Filz mit schallabsorbierenden Eigenschaften; optisch und haptisch hochwertige Oberfläche; Aufbau aus 2 Schalen, dadurch bilden sich Hohlräume zur Verbesserung der akustischen Performance; große schallabsorbierende Oberfläche; abgependelt mit Seilabhängung; werkzeuglose Höhenverstellung an der Leuchte bzw. am Akustikelement; MUSE LIGHT: optimiert zur Ausleuchtung von Büroarbeitsplätzen; inkl. transparenter Einspeiseleitung; Lichteinsatz aus Strangpressprofil für verbessertes Thermomanagement; hochglänzender Reflektor mit Facettenoptik; energieeffiziente LEDs mit sehr guter Farbwiedergabe

Quickinfo

3000K, 4000K
 CRI ≥ 80, 3 SDCM
 UGR ≤ 19 / 65° ≤ 1500 cd/m²
 up to 109lm/W
 L90 @ 50 000h
 DALI-2
 reflector (UGR ≤ 19)

PET felt
 ♻️ from recycled material
 up to absorber class A

Type

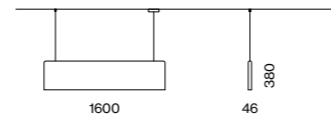

Colours



Light distribution



direct

Order options

COLOUR TEMPERATURE	
3000K	5
4000K	6

CONTROL

DALI-2

MATERIAL COLOUR

● anthracite	B
● felt grey	G
● bright blue	P
● indigo blue	E

canopy always in white
 other colours on request

LIGHT INSET COLOUR

grey cover / chrome reflector

Options on request

COLOUR RENDERING INDEX
 CRI ≥ 98 XPECTRUM

CONTROL

brightness & presence sensor

LIGHT INSET COLOUR

black cover / black reflector
 white cover / chrome reflector
 black cover / chrome reflector



DiiA® standards
 251, 252, 253



DIN EN 12464-1
 UGR ≤ 19

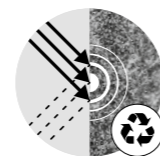

sound absorption
 by recycled PET

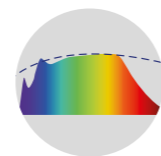

CRI ≥ 98
 XPECTRUM

Light distribution

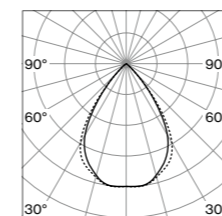

chrome reflector
 direct

LUMINOUS FLUX value calculated for
 CRI ≥ 80, cover grey, reflector chrome

MUSE BAFFLE suspended

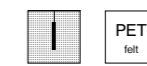

ACOUSTIC BAFFLE

L (mm)
 1600

ORDER CODE
 091-101111

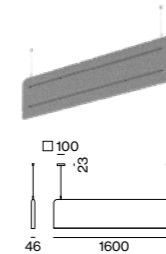

MUSE LIGHT suspended



ACOUSTIC LUMINAIRE

SYS. POWER	COLOUR TEMP.	LUM. FLUX	L (mm)	ORDER CODE
20W	3000K 4000K	2080lm 2200lm	1600	091-121111

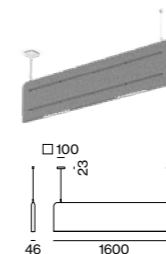

Lighting calculation



MUSE LIGHT
 20W direct, 4000K, chrome reflector
 + MUSE BAFFLE (every 2nd)

ROOM VALUES

Room dimensions	9 × 5 × 3 m
Room volume	135 m³
Reflection factor	0.7 0.5 0.2
Maintenance factor	0.8
Mounting height	2.23 m

CALCULATION SURFACE

Surface dimensions	8 × 4
Surface height	0.75 m
Average illuminance (E _m)	> 500 lx

GLARE EVALUATION

Table Classification X=4H | Y=8H | S=0.25H
 UGR transversal ≤ 19
 UGR axial ≤ 19
 ≥ 65° ≤ 1500 cd/m²

Acoustic calculation

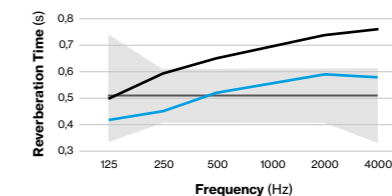

ACOUSTIC PARAMETERS

Target Reverberation Time	0.51s*
RT without MUSE	0.66s
RT with MUSE	0.52s

*according to DIN 18041, room category
 A3 (education/communication)

MATERIALS

Walls	Hardboard
Ceiling	Gypsum Board
Floor	Hardwood

Art-Invest Berlin, DE –
by LEPEL & LEPEL Architekt





XAL Office
Vienna, AT

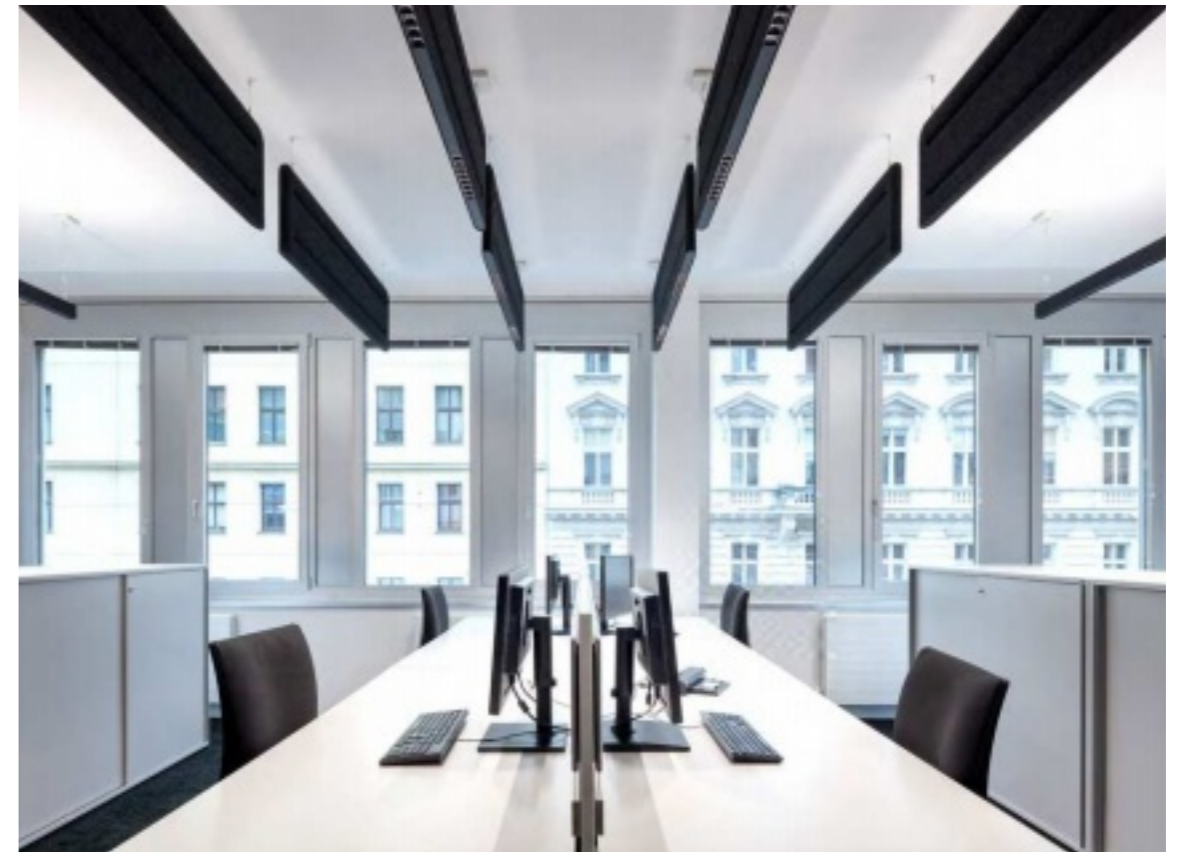

For the right kind of reflection



STRETTA

EN Whether in the bathroom or in the fitting room, STRETTA is a fantastic exclusive mirror luminaire. Thanks to its excellent colour rendering of $CRI \geq 90$, it is used wherever colours, shapes, and designs are to be shown in their best and authentic light. STRETTA emits light on three sides and has been equipped with an opal cover to guarantee particularly homogeneous wall illumination. The IP44 protection class ensures safe use in wet rooms.

DE Ob im Badezimmer oder in der Umkleidekabine: STRETTA überzeugt als exklusive Spiegelleuchte. Dank ihrer guten Farbwiedergabe von $CRI \geq 90$ wird sie überall dort eingesetzt, wo Farben, Formen und Designs authentisch zur Geltung kommen sollen. Für eine besonders homogene Wandaufhellung verfügt STRETTA über eine dreiseitige Lichtabstrahlung und wurde mit einer Opal-Abdeckung ausgestattet. Die Schutzart IP44 garantiert einen sicheren Einsatz in Nassräumen.

Mountings

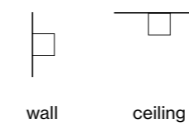

wall

ceiling

Light distribution

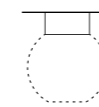

opal

← back



STRETTA

surface

EN Luminaire housing from extruded aluminium profile, angular design; no visible screws; surface powder coated; luminaire profile can be pre-mounted; end cap galvanically chromed or in same colour as housing (chromed border); suitable for wall or ceiling mounting; with three sided light beam; HPO (High Performance Opal) cover for uniform illumination; energy-efficient LEDs with very good colour rendering

DE Leuchtenkörper aus Aluminiumstrangpressprofil, kantige Ausführung; keine sichtbaren Schrauben; Oberfläche pulverbeschichtet; Leuchtenprofil vorab montierbar; Enddeckel galvanisch verchromt oder in Leuchtenfarbe pulverbeschichtet (Umrandung verchromt); geeignet für Wand- oder Deckenmontage; mit dreiseitiger Lichtabstrahlung; HPO (High Performance Opal) Abdeckung für homogene Ausleuchtung; energieeffiziente LEDs mit sehr guter Farbwiedergabe

Quickinfo

3000K, 4000K
CRI ≥ 90, 3 SDCM
up to 112lm/W
L80 @ 50 000h
non DIM, DALI-2
opal cover
IP 44

Types

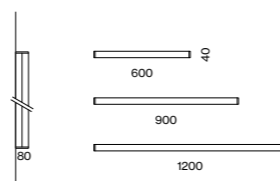

Luminaire colours



End caps colours



Light distribution

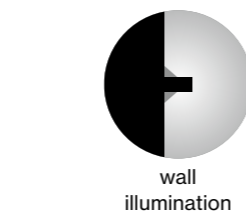

splash water protection (IP44)

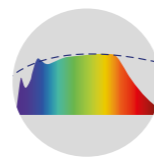

CRI ≥ 98 XPECTRUM

Order options

COLOUR TEMPERATURE	
3000K	5
4000K	6

CONTROL	
non DIM	1
DALI-2	3

MATERIAL COLOUR	
○ pure white RAL 9010*	7
○ pure white / ◊ chrome**	C
● jet black RAL 9005*	8

*end caps in housing colour with chromed border
**end caps completely in chrome

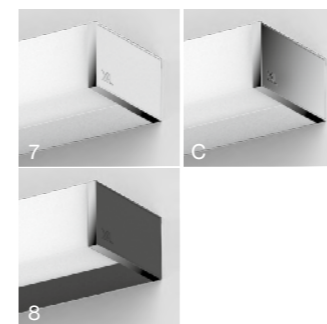

LIGHT OPTIC COVER
opal high performance

Options on request

COLOUR RENDERING INDEX
CRI ≥ 98 XPECTRUM

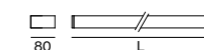

STRETTA surface



LUMINAIRE

SYS. POWER	COLOUR TEMP.	LUM. FLUX	L (mm)	ORDER CODE
13W	3000K	1370lm	600	057-0132::◆H
	4000K	1460lm		
19.5W	3000K	2050lm	900	057-0133::◆H
	4000K	2190lm		
26.1W	3000K	2740lm	1200	057-0134::◆H
	4000K	2920lm		

Light distribution

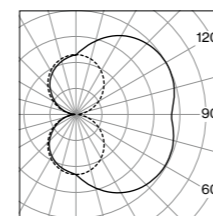

opal high performance

LUMINOUS FLUX value calculated for
CRI ≥ 90, colour white, cover opal

Private Residence
Visualisation



Sharpen your edges

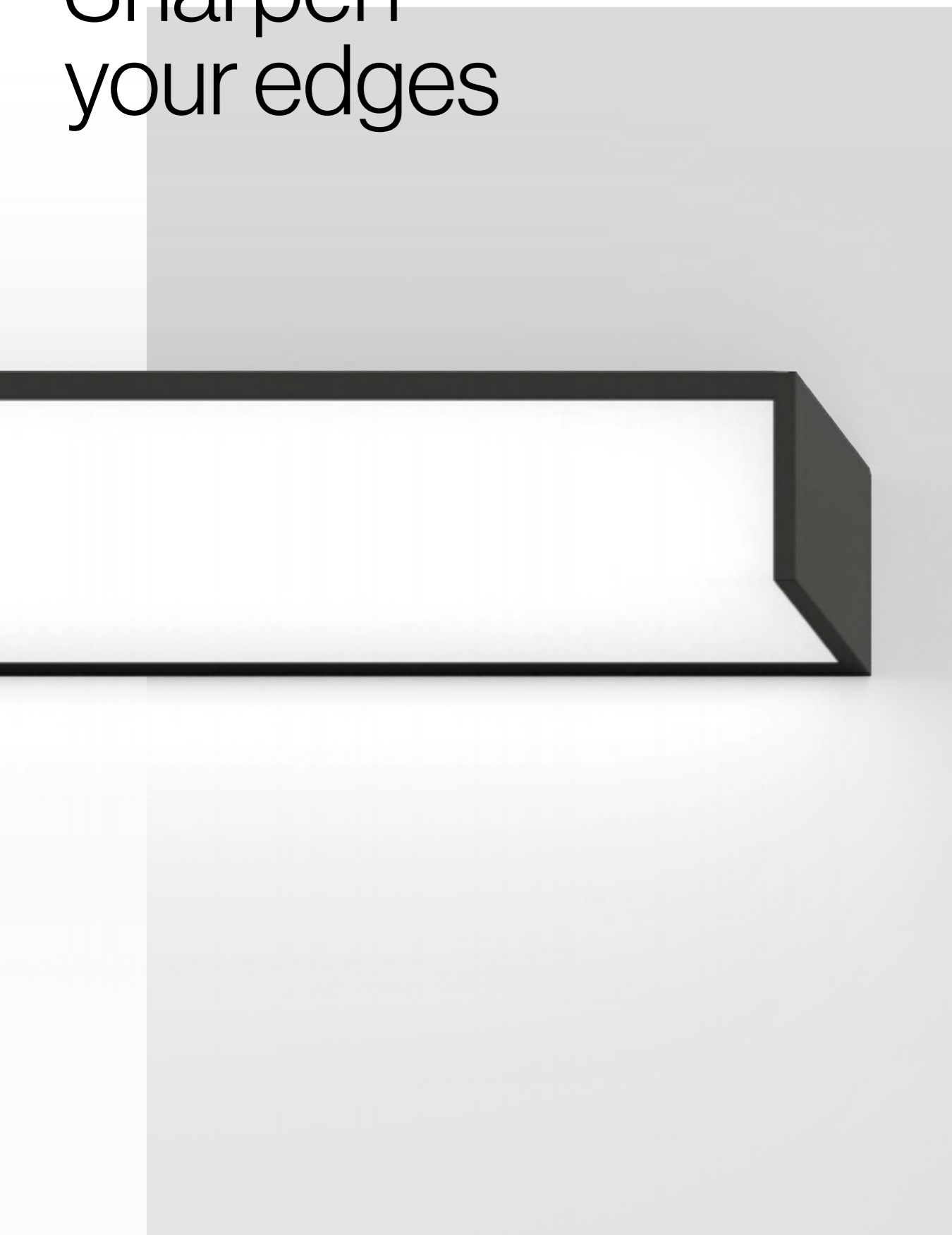

CORNER

EN The best wall light is right around the CORNER. It is preferred for ceiling edges or wall corners and is mainly used in staircases, reception halls, or corridors. Wall and ceiling are equally well illuminated by the CORNER single luminaire thanks to the light insert with opal cover. The bidirectional beam pattern delivers ambient lighting. CORNER is available in the light colours 3000 K or Tunable White and two different power levels. CORNER comes in different lengths and in white, grey, and black.

DE Die beste Wand-Leuchte befindet sich mit CORNER direkt um die Ecke. Sie wird präferiert für Deckenkanten oder Wandecken und wird vor allem in Treppenhäusern, Empfangshallen oder Gängen eingesetzt. Wand und Decke werden von der CORNER Einzelleuchte durch den Lichteinsatz mit Opal Cover gleichermaßen gut ausgeleuchtet. Die zweiseitige Abstrahlcharakteristik sorgt für eine homogene Grundausleuchtung. CORNER steht in den Lichtfarben 3000 K oder Tunable White und in zwei unterschiedlichen Leistungsstufen zur Verfügung. CORNER ist in verschiedenen Längen und in den Farben Weiß, Grau und Schwarz erhältlich.

Mountings

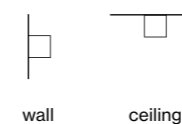

Light distribution

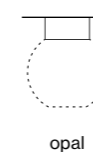

← back



CORNER

surface

EN Luminaire housing from extruded aluminium profile, angular design; no visible screws; surface powder coated; luminaire profile for mounting available in advance; suitable for wall or ceiling mounting; with double-sided light beam; HPO (High Performance Opal) cover for uniform illumination; energy-efficient LEDs with very good colour rendering

DE Leuchtenkörper aus Aluminiumstrangpressprofil, kantige Ausführung; keine sichtbaren Schrauben; Oberfläche pulverbeschichtet; Leuchtenprofil für Montage vorab lieferbar; geeignet für Wand- oder Deckenmontage; mit zweiseitiger Lichtabstrahlung; HPO (High Performance Opal) Abdeckung für homogene Ausleuchtung; energieeffiziente LEDs mit sehr guter Farbwiedergabe

Quickinfo

3000K
CRI ≥ 80, 3 SDCM
up to 131lm/W
L90 @ 50 000h
non DIM
opal

Types

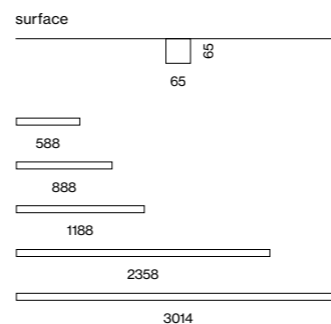

Colours



Light distribution



direct

Order options

COLOUR TEMPERATURE

3000K

CONTROL

non DIM

MATERIAL COLOUR

- pure white (RAL 9010) 7
- white aluminium (RAL 9006) G
- jet black (RAL 9005) 8

LIGHT OPTIC COVER

opal high performance

Options on request

SYSTEM SOLUTION

installation channel, etc.

COLOUR TEMPERATURE

4000K

tunable white 2700–6500 K*

*DALI-2 DT8

CONTROL

DALI-2

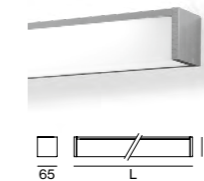

CORNER surface



MID LUMEN

SYS. POWER	COLOUR TEMP.	LUM. FLUX	L (mm)	ORDER CODE
13.8W	3000K	1810lm	588	040-895251
20.7W	3000K	2720lm	888	040-895351
27.6W	3000K	3620lm	1188	040-895451
55W	3000K	7250lm	2358	040-895851
81W	3000K	9830lm	3014	040-895951

HIGH LUMEN

SYS. POWER	COLOUR TEMP.	LUM. FLUX	L (mm)	ORDER CODE
20.2W	3000K	2460lm	588	040-896251
30W	3000K	3690lm	888	040-896351
40W	3000K	4910lm	1188	040-896451
71W	3000K	9340lm	2358	040-896851
98W	3000K	12700lm	3014	040-896951

Light distribution

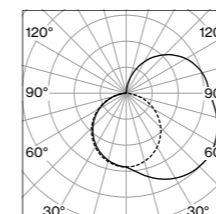

asymmetric

LUMINOUS FLUX value calculated for CRI ≥ 80, colour white, cover opal



wall/ceiling
illumination

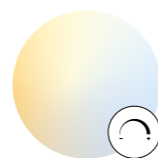

tunable white
2700–5000K

Office Stadsbader
Harelbeke, BE

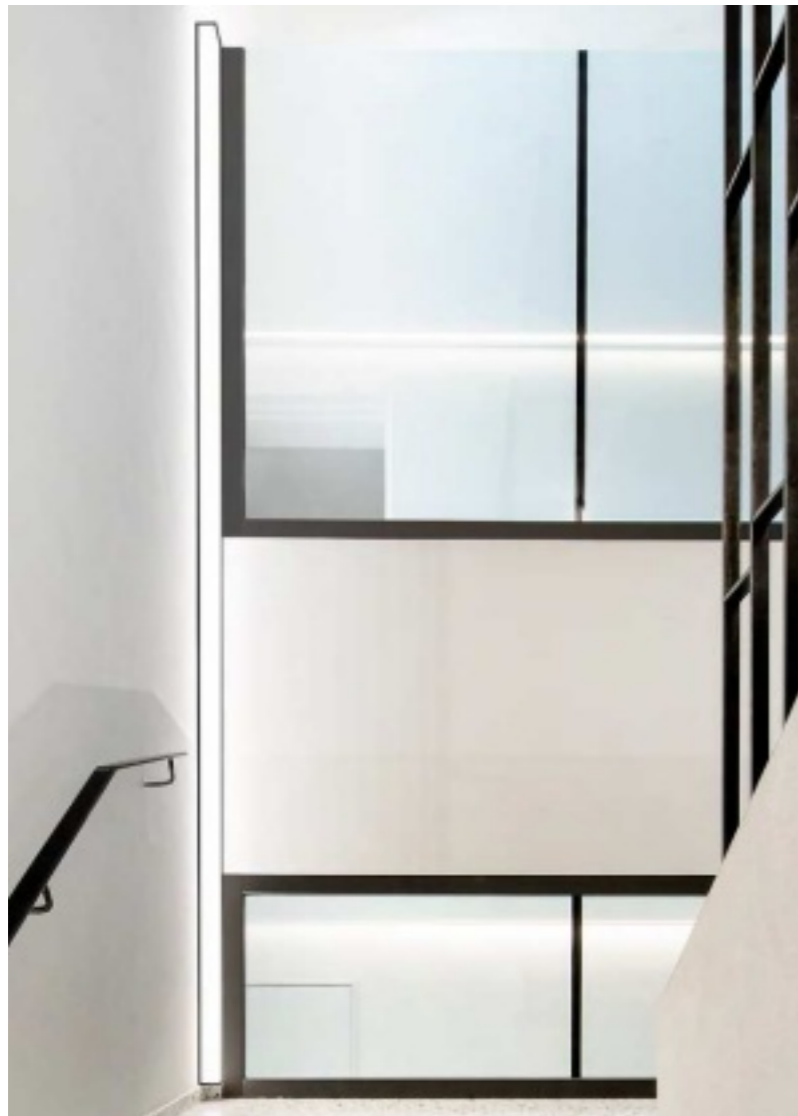

Getting well with light



RECOVER

EN The next generation of contemporary healthcare lighting, RECOVER has been developed to simulate a natural light pattern. This is achieved by the dynamically changing colour temperature. It varies from activating morning light to a sleep-promoting evening glow. The luminaire supports the natural regeneration of the patient by supporting the human biorhythm. The 4-in-1 system includes ambient light, a reading light, a nurse's night light, and an examination light with a high CRI value that displays amorphous three-dimensional surfaces, such as the skin, correctly. RECOVER is designed to be particularly user-friendly. Lighting programmes can be quickly and flexibly adapted.

DE Die nächste Generation zeitgemäßer Beleuchtung im Gesundheitswesen: RECOVER wurde speziell entwickelt, um einen natürlichen Lichtverlauf zu simulieren. Das gelingt durch die dynamisch veränderliche Farbtemperatur, die von aktivierendem Morgenlicht bis zu schlaffördernder Abendröte wechselt. Indem das Licht den menschlichen Biorhythmus fördert, unterstützt die Leuchte die natürliche Regeneration der Patienten. Das 4-in-1-System umfasst Raumlicht, Leselicht, Schwesternnachtlicht und ein Untersuchungslicht mit hohem CRI-Wert für die perfekte Darstellung dreidimensionaler amorpher Flächen wie der Haut. Die Bedienung von RECOVER wurde besonders benutzerfreundlich gestaltet, sodass Lichtprogramme einfach und flexibel anpassbar sind.

Mounting



wall

Light distributions

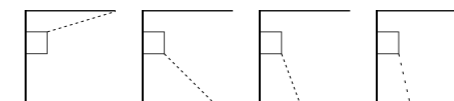

ambient
light

examination
light

reading
light

nurse night
light

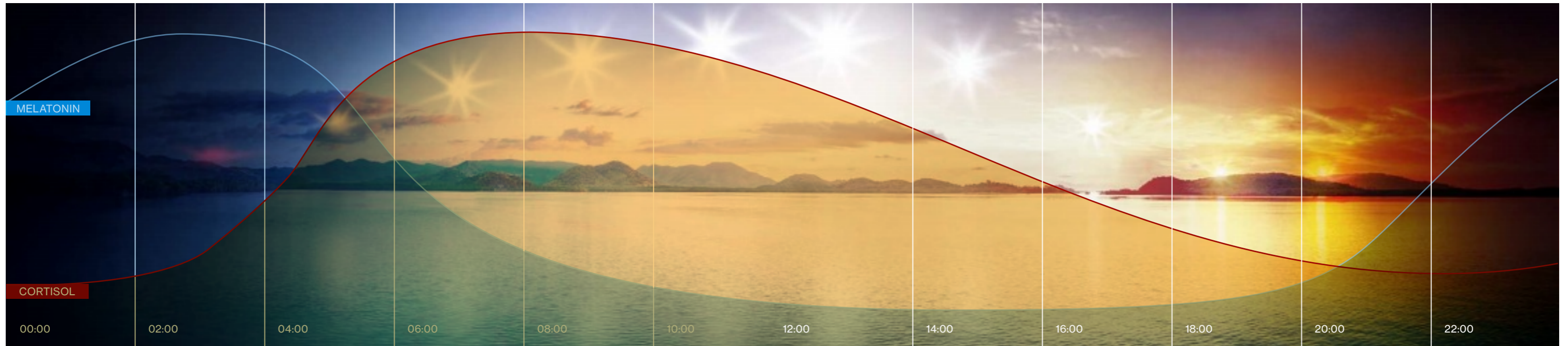

Day-night rhythm

EN Light affects well-being and health. Cool morning light promotes cortisol, the activating hormone. In the evening, when the blue component is missing, the sleep hormone melatonin is formed. High melatonin levels at night lead to more restful sleep, and we enjoy a positive start to the day through an increased release of the happiness hormone serotonin. The RECOVER luminaire taps this knowledge and supports the natural regeneration of patients, as the high indirect illuminance provides clear impulses to the inner clock.

DE Licht beeinflusst das Wohlbefinden und die Gesundheit. Kühles Morgenlicht fördert das aktivierende Hormon Cortisol; abends, bei fehlendem Blauanteil, bildet sich das Schlafhormon Melatonin. Ist der nächtliche Melatoninspiegel hoch, schlafen wir erholsamer und starten durch eine erhöhte Ausschüttung des Glückshormons Serotonin positiv in den Tag. Die RECOVER Leuchte nutzt dieses Wissen und unterstützt so die natürliche Regeneration von Patienten, da die hohe indirekte Beleuchtungsstärke eine klare Taktung der inneren Uhr vorgibt.

Schedule light moods

EN The aim was to make RECOVER particularly user-friendly. Lighting moods and intensity levels can be programmed with simple software. You can even string together several different programmes to form an annual schedule. The intensity and colour temperature change automatically with the season. The factory settings already store different daily sequences, which you can quickly adapt to your time requirements.

DE Ziel war es, RECOVER besonders benutzerfreundlich zu machen. Mit einer einfachen Software können Lichtstimmungen und Intensitätsstufen programmiert werden. So können Sie mehrere, variierende Programme sogar zu einem Jahresprogramm aneinanderreihen. Die Intensität und Farbtemperatur verändert sich automatisch mit der Jahreszeit. In den Werkseinstellungen sind bereits unterschiedliche Tagesverläufe gespeichert, die Sie einfach an Ihre zeitlichen Anforderungen anpassen können.

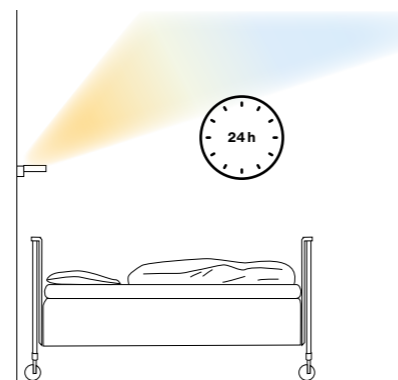

Four lights in one

EN RECOVER combines four luminaires. Indirect, homogeneous ceiling lighting provides daytime brightness for the patient, while the examination light is used for doctors' visits. A reading light ensures reflection-free illumination of the reading area. The nurse night light mounted on the side of the luminaire was integrated to avoid dazzling the patient at night.

DE RECOVER vereint vier Leuchten: Indirekte, homogene Deckenbeleuchtung vermittelt dem Patienten Tageshelligkeit, während das Untersuchungslicht zur Arztvisite dient. Ein Leselicht sorgt für eine reflexionsfreie Ausleuchtung des Lesebereichs. Das seitlich an der Leuchte montierte Schwestern-Nachtlicht wurde integriert, um den Patienten in der Nacht nicht zu blenden.

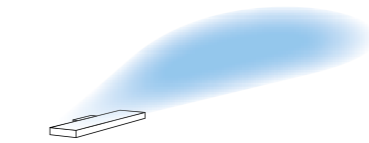

Ambient light

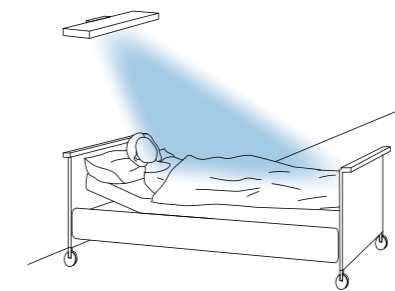

Examination light

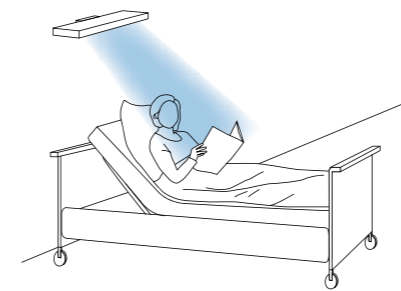

Reading light

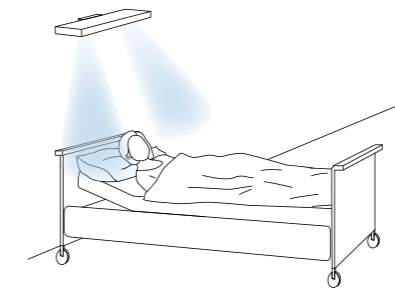

Nurse night light

CRI ≥ 95

EN The RECOVER examination and reading light achieve excellent R_a and R_e values of ≥ 95 . The unusually small luminous surface of the LED and the high luminance display amorphous three-dimensional surfaces, such as the skin, correctly.

DE Das RECOVER Untersuchungs- und das Leselicht erreichen hervorragende R_a und R_e Werte von ≥ 95 . Durch die besonders kleine leuchtende Fläche der LED und die hohe Leuchtdichte gelingt die perfekte Darstellung von amorphon dreidimensionalen Flächen wie der Haut.



typical CRI ≥ 95



CRI ≥ 80

back

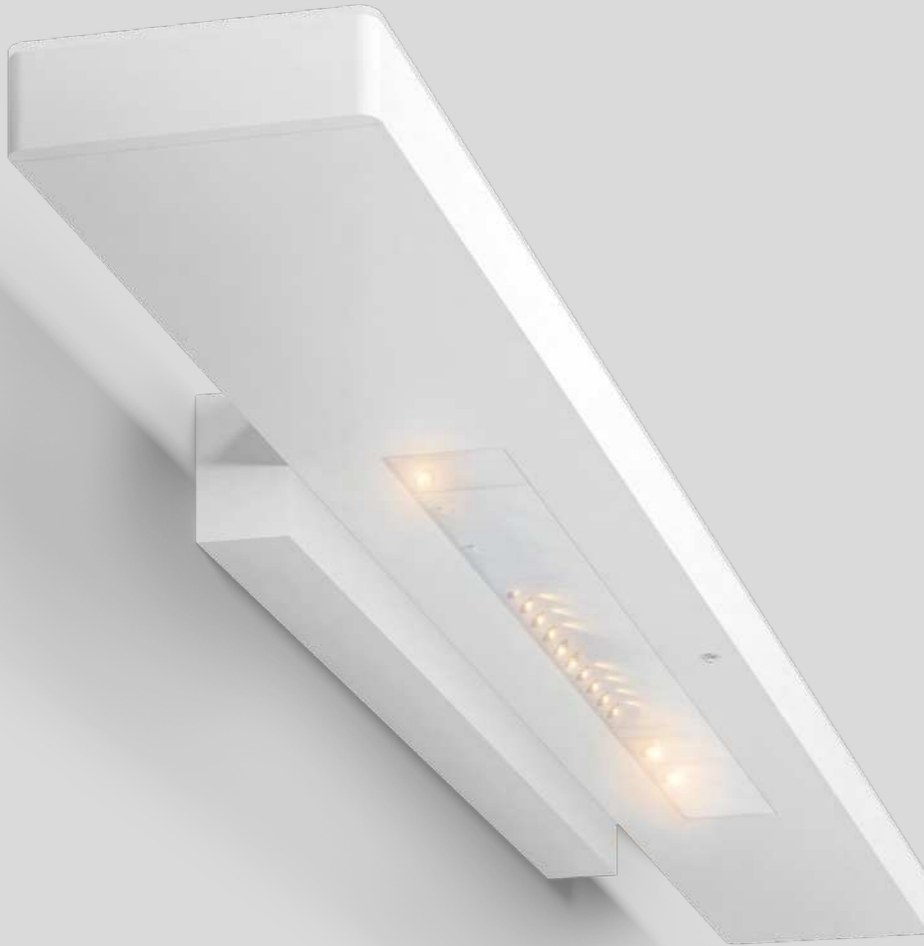

RECOVER

wall

EN RECOVER is available in three versions:

RECOVER BASIC allows switching of the indirect ambient light, the examination light and the reading light.

RECOVER DALI allows individual dimming of the indirect ambient light, the examination light and the reading light.

RECOVER PRO allows for natural progressive lighting. Used in combination with the RECOVER Master Unit, four dynamic light transitions can be run. The four programs can be combined, through the RECOVER software, to form an annual light program. The examination light can be dimmed using the master unit, and the reading light can be switched in 2 stages. There are buttons built into the lamp to switch the two nurse night lights.

DE RECOVER ist in drei Varianten erhältlich:

RECOVER BASIC ermöglicht die Schaltung des indirekten Raumlichts, des Untersuchungslichts und des Leselichts.

RECOVER DALI ermöglicht ein individuelles Dimmen des indirekten Raumlichts das Untersuchungslichtes und des Leselichtes.

RECOVER PRO ermöglicht naturnahe Lichtverläufe. In Kombination mit der RECOVER Master Unit können vier dynamische Lichtverläufe abgespielt werden. Mittels der RECOVER Software können die vier Programme zu einem Jahreslichtprogramm aneinandergesetzt werden. Das Untersuchungslicht ist über die Master Unit dimmbar, das Leselicht in 2 Stufen schaltbar. Die beiden Schwestern-Nachtlichter sind mittels in der Leuchte eingebaute Taster schaltbar.

Quickinfo

2200–31000 K, TW
CRI ≥ 95, 3 SDCM
up to 96 lm/W
L80 @ 50 000 h
glass cover
non DIM, DALI

Types

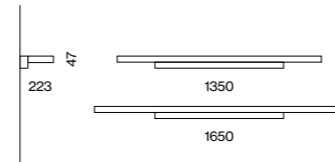

Colour



Light distributions

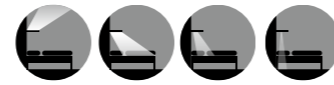

ambient light examination light reading light nurse night light

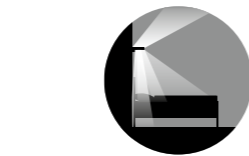

four in one light distribution



master unit



circadian light
2200–31000 K

MATERIAL COLOUR

○ pure white RAL 9010

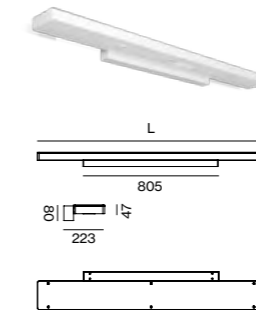

RECOVER



BASIC

SYS. POWER	COLOUR TEMP.	LUM. FLUX	L (mm)	ORDER CODE
108 W	3000 K	7870 lm	1350	099-2210517
127 W	3000 K	9380 lm	1650	099-2211517



DALI

SYS. POWER	COLOUR TEMP.	LUM. FLUX	L (mm)	ORDER CODE
91 W	2700–6500 K*	8550 lm**	1350	099-2210D37
106 W	2700–6500 K*	10200 lm**	1650	099-2211D37

*examination and reading light 3000 K **measured at 6500 K



PRO

SYS. POWER	COLOUR TEMP.	LUM. FLUX	L (mm)	ORDER CODE
198 W	2200–31000 K*	16900 lm**	1350	099-2210037
237 W	2200–31000 K*	206004 lm**	1650	099-2211037

*examination and reading light 3000 K, nurse night light 2200 K

**measured at 5000 K

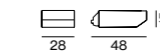
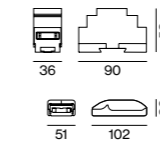

Accessories for RECOVER DALI

DALI POWER SUPPLY 220-240 V

TYPE	L-W-H (mm)	ORDER CODE
for top-hat-rail mounting 240 mA	90-36-58	002-59871
for ceiling insertion 200 mA	102-51-30	002-59880

DALI MODULE for group/scene control

TYPE	L-W-H (mm)	ORDER CODE
DALI control of 4 scenes/2 groups	48-28-15	002-54026

Accessories for RECOVER DALI/PRO

MASTER UNIT (DALI optional/PRO mandatory)

TYPE	L-W-H (mm)	ORDER CODE
single patient room	85-48-160	099-2291137
double patient room	85-48-160	099-2291237
three patient room	85-48-160	099-2291337
four patient room	85-48-160	099-2291437
five patient room	85-48-160	099-2291537
six patient room	85-48-160	099-2291637

INSTALLATION HOUSING (mandatory for MASTER UNIT)

for installation in solid walls

TYPE	L-W-H (mm)	ORDER CODE
installation housing	71-75-135	099-2290000

SAFETY FRAME FOR MASTER UNIT (optional)

TYPE	L-W-H (mm)	ORDER CODE
safety frame	108-15-182	099-2298007

LIGHT SENSOR / MOTION DETECTOR DALI, PRO (optional)

TYPE	ORDER CODE
recessed ceiling mounted	002-54051
surface mounted	002-54058
socket mounted	002-54053

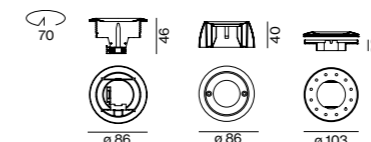
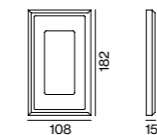
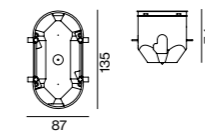
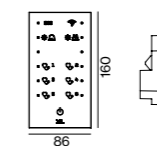

EMCO private clinic
Bad Dürrenberg/Salzburg, AT –
by FLEOS architektur with
lighting design by Das Licht



Systems



Systems

MOVE IT 25

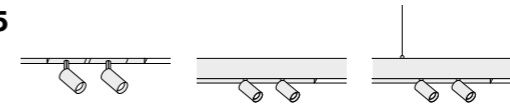

694 recessed surface suspended

MOVE IT 45

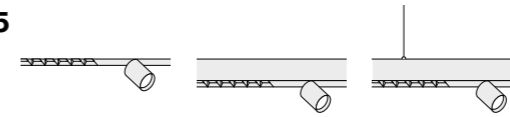

778 recessed surface suspended

TASK

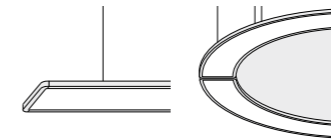

808 S suspended acoustic

BETO

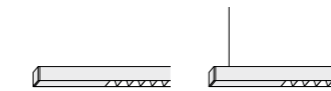

834 ceiling suspended

SETA

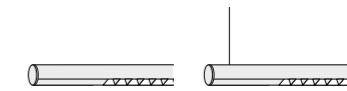

NEW 850 ceiling suspended

LENO



858 recessed semi-recessed surface suspended

MINIMAL

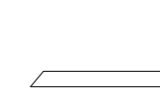

878 recessed

FRAME

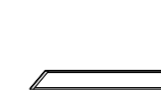

888 recessed trim

CANYON



902 recessed offset

MINO



908 ceiling suspended

BASO



934 recessed surface

TUBO



NEW 948 surface suspended

LINEA



NEW 958 wall

Everything on track



MOVE IT 25 system

EN The sleek, elegant MOVE IT 25 system has revolutionised low-voltage track systems. The tool-free magnetic mounting of spotlights, decorative, or linear insets allows flexible, ever-new combinations. The various mounting options offer even more freedom: at two heights each, as trimless recessed and surface-mounted for wall or ceiling mounting, and suspended with a direct or direct / indirect light component. The individual profiles can be interconnected with each other, or linked via the CORNER, CURVE or NODE Connector elements. This allows for a variety of creative ceiling patterns. Square or triangular acoustic elements that can be optionally integrated additionally create balanced room acoustics.

DE Das schlichte, elegante MOVE IT 25 System hat Niedervolt-Stromschienensysteme revolutioniert: Die werkzeuglose Magnetbefestigung von Strahlern sowie von dekorativen oder linearen Einsätzen erlaubt flexible, immer wieder neue Kombinationsmöglichkeiten. Noch mehr Freiheiten bieten die verschiedenen Montagevarianten: in jeweils zwei Höhen als randloser Ein- und Anbau für die Wand- bzw. Deckenmontage sowie abgehängt mit Direkt- oder Direkt / Indirekt-Lichtanteil. Die einzelnen Profile können miteinander oder über die Elemente CORNER, CURVE oder NODE Connector verbunden werden. Dadurch sind vielfältige, kreative Deckenmuster möglich. Optional integrierbare Akustik-elemente in quadratischer oder dreieckiger Form schaffen zusätzlich eine optimale Raumakustik.

Types



25 S

25

Mountings

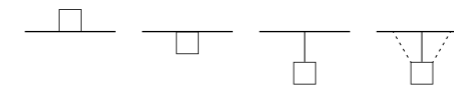
trimless
recessed

surface

suspended

indirect
suspended

Configurations



linear

corner

curve

node

flextrack

Light distributions

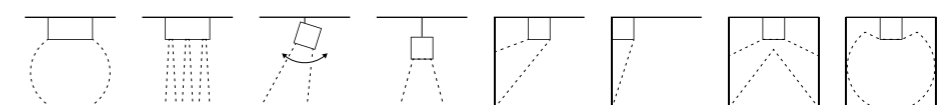

opal

spot line

spotlight

decorative

wallwasher

wall grazer

batwing

pivot

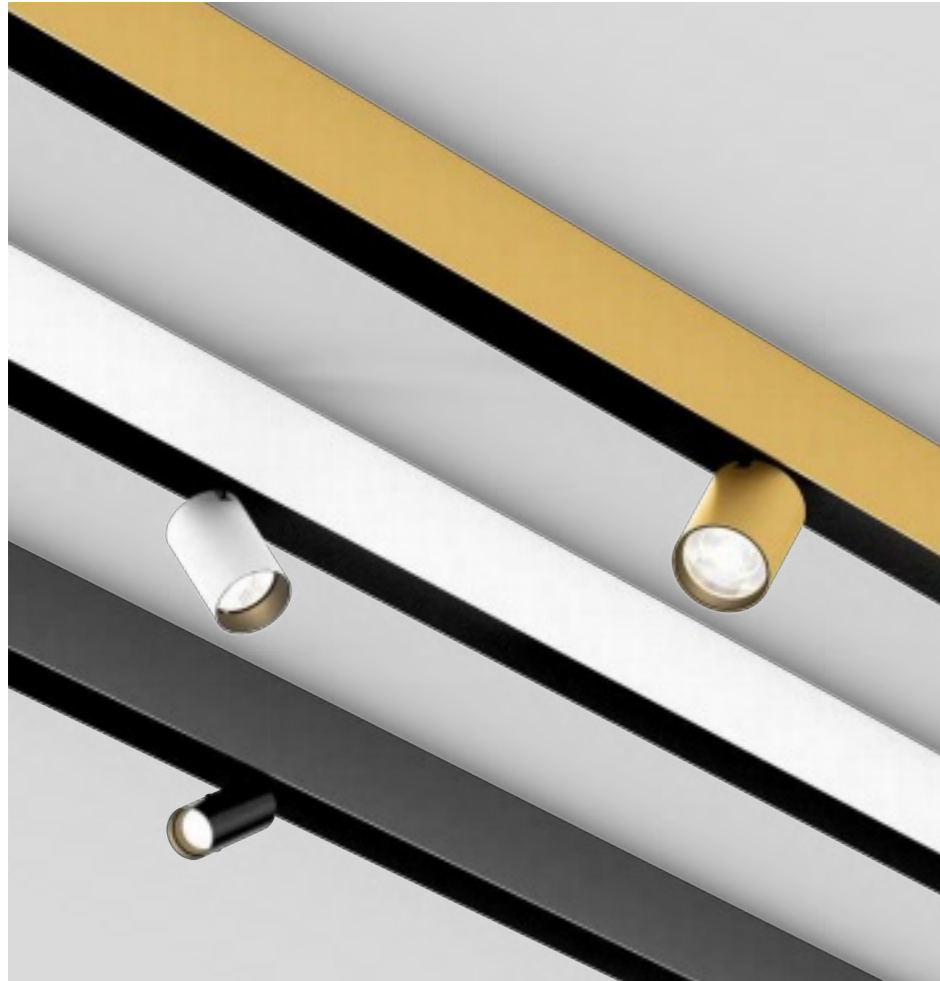

Colour variety

EN MOVE IT profiles are available in the standard colours black, white, and gold. Further colour variations are also available, granting your project maximum design freedom. You can learn more about our colour palette at xal.com/colours.

DE MOVE IT Profile sind in den Standardfarben Schwarz, Weiß und Gold erhältlich. Darüber hinaus stehen weitere Farbvarianten zur Verfügung – dies ermöglicht ihnen einen maximalen Gestaltungsfreiraum bei Ihrem Projekt. Mehr zu unserer Farbpalette erfahren Sie auf xal.com/colours.



xal.com/colours

Individual grids & room acoustics

EN The NODE Connector lets you create different ceiling patterns from up to six MOVE IT 25 profiles per node. Attractive geometric shapes are created by connecting the profiles at a 60° or 90° angle. Create seamless 90° corners with a special corner connector. Simply extend the MOVE IT Suspended System with triangular and square acoustic elements for optimised room acoustics. Curved elements and special corner connectors that are rotated 35° to the left and right provide even more design freedom.

DE Mit dem NODE Connector kreieren Sie unterschiedliche Deckenmuster aus bis zu sechs MOVE IT 25 Profilen je Knotenpunkt. Indem Sie die Profile im 60° oder 90° Winkel verbinden, entstehen ansprechende geometrische Formen. Für die zusätzliche Optimierung der Raumakustik kann das MOVE IT Suspended System einfach um dreieckige und quadratische Akustikelemente erweitert werden. Für noch mehr Gestaltungsfreiraum sorgen Kurvenelemente und spezielle Eckverbinder, die um 35° nach links und rechts gedreht werden.

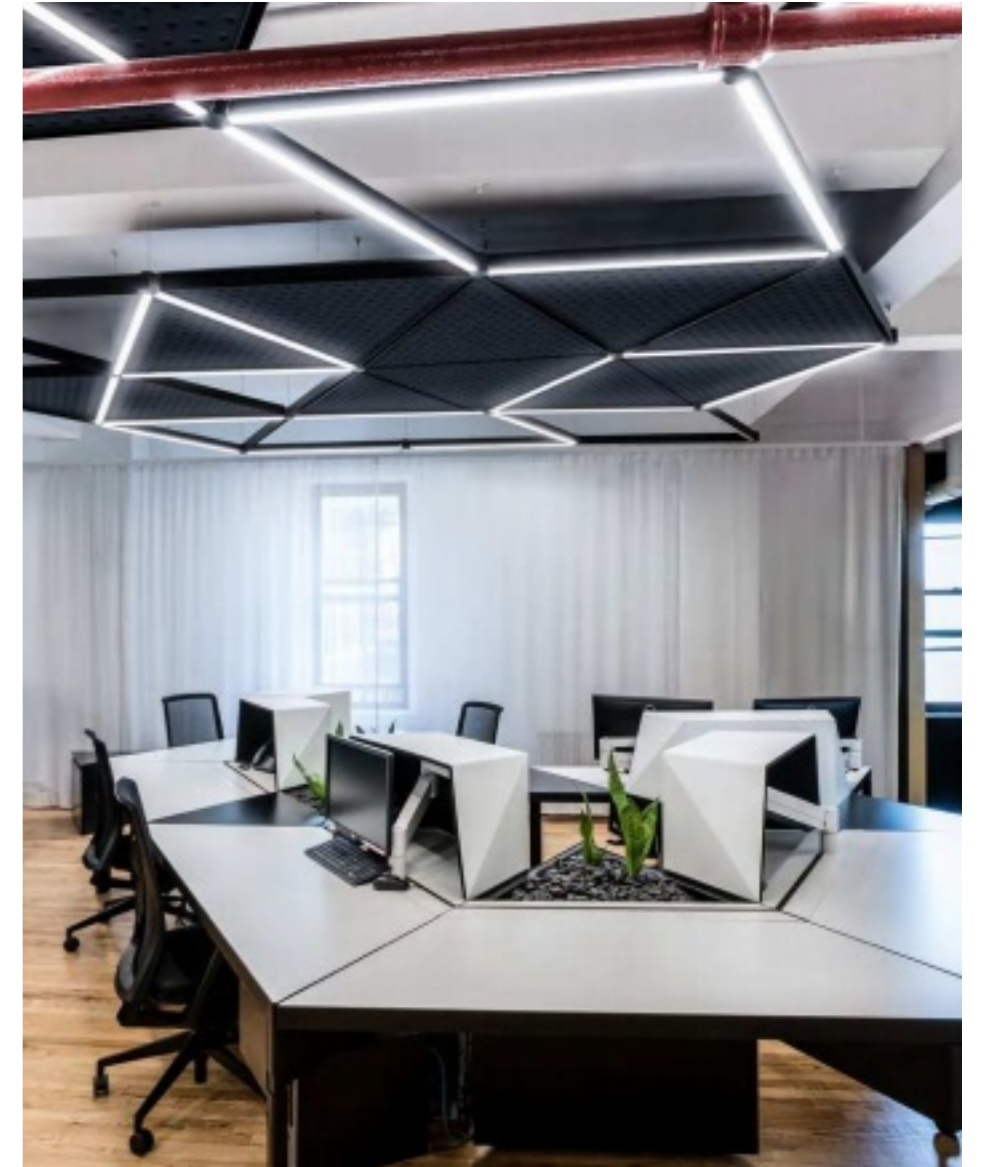

Mounting options

EN The slim, elegant MOVE IT 25 system offers a wide variety of installation options: as a trimless recessed or surface-mounted variant for wall or ceiling mounting and suspended at two depths. The direct/indirect variant provides additional homogeneous ceiling illumination.

DE Das schmale, elegante MOVE IT 25 System bietet eine große Vielfalt an Montagemöglichkeiten: Als randlose Ein- sowie Anbauvariante für Wand- oder Deckenmontage sowie abgehängt in zwei Tiefen. Die direkt/indirekt Variante sorgt für eine zusätzliche homogene Deckenaufhellung.

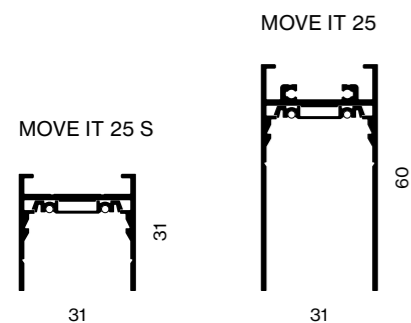
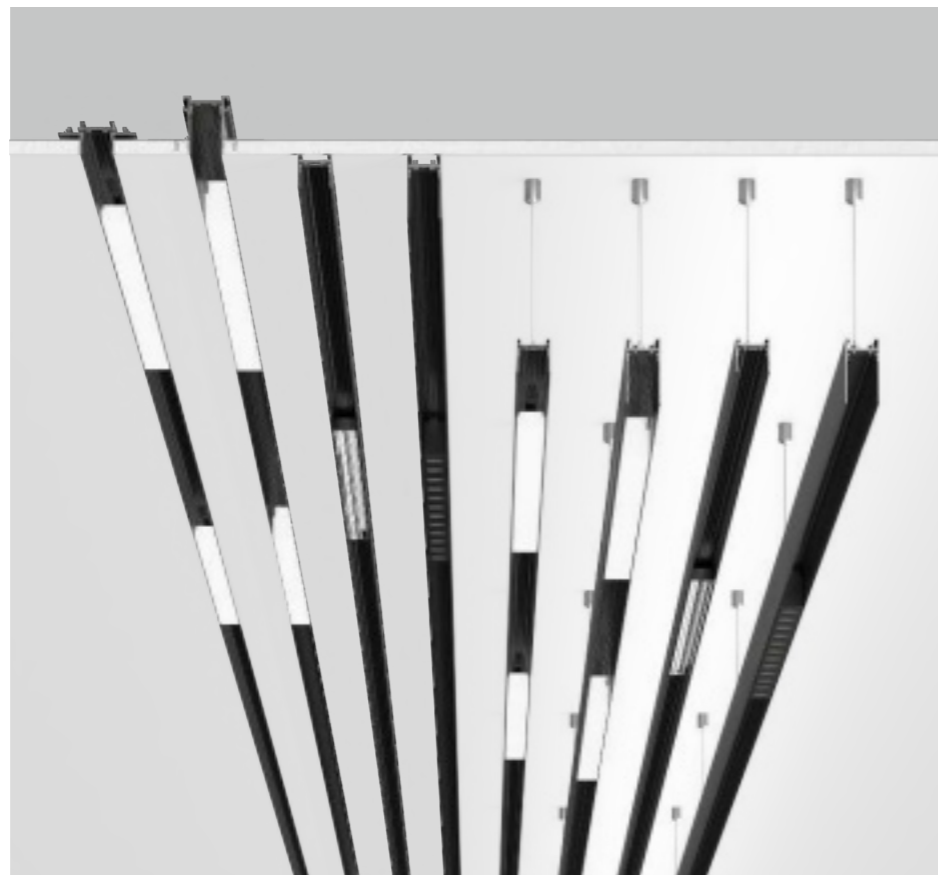

XPECTRUM LED

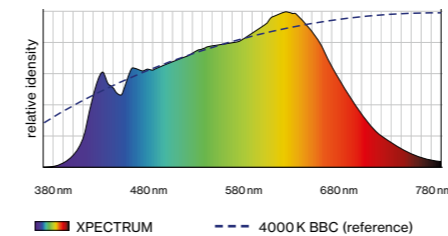

Commercially available LED 4000 K

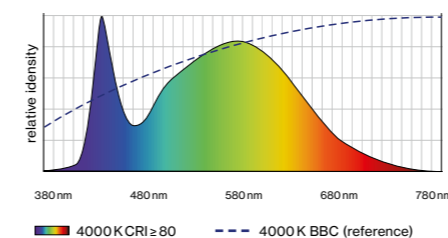

Full-spectrum LED

EN XAL's new XPECTRUM LEDs deliver healthy, biologically effective light. The reduced blue light and increased cyan values reduce the blue light hazard for the eye to daylight-equivalent levels. The resulting non-visual, so-called melanopic light effect, improves concentration and increases sleep quality. The excellent colour rendering of IES TM 30-15 $R_i=98$ and $R_g=101$ further helps visual comfort.

DE Die neue XPECTRUM LED von XAL sorgt für gesundes, biologisch wirksames Licht. Der reduzierte Blaulichtanteil sowie die erhöhten Cyan-Werte minimieren die Blaulichtgefahr für das Auge auf ein tageslichtähnliches Niveau. Die daraus resultierende nichtvisuelle, auch melanopische Lichtwirkung genannt, fördert die Konzentration und steigert die Schlafqualität. Die hervorragende Farbwiedergabe von IES TM 30-15 $R_i=98$ und $R_g=101$ ermöglicht zudem einen verbesserten Sehkomfort.



Optical accessories

EN Use a wide range of optical accessories to adapt spotlights for special applications. The optical light accessories can be attached or removed in one easy step and provide glare-free light at any point.

DE Nutzen Sie vielfältiges optisches Zubehör, um Strahler für spezielle Anwendungsbereiche anzupassen. Die optischen Licht-Accessoires lassen sich mit nur einem Handgriff aufsetzen oder abnehmen und sorgen an jeder Stelle für blendfreies Licht.

Control options

EN MOVE IT Insets are available with DALI-2 and can be controlled individually. Configuration and control are simply done via DALI. As the open DALI communication standard is fully supported, all compatible luminaires can be easily integrated into the system. The Wireless-to-DALI Inset enables wireless control of DALI luminaire systems by using a communication module.

DE MOVE IT Insets sind mit DALI-2 verfügbar und einzeln ansteuerbar. Konfiguration und Steuerung erfolgt einfach über DALI. Da der offene Kommunikationsstandard DALI vollständig unterstützt wird, lassen sich damit alle kompatiblen Leuchten unkompliziert in das System integrieren. Das Wireless to DALI Inset ermöglicht die kabellose Ansteuerung von DALI Leuchtensystemen durch Einsatz eines Kommunikationsmoduls.

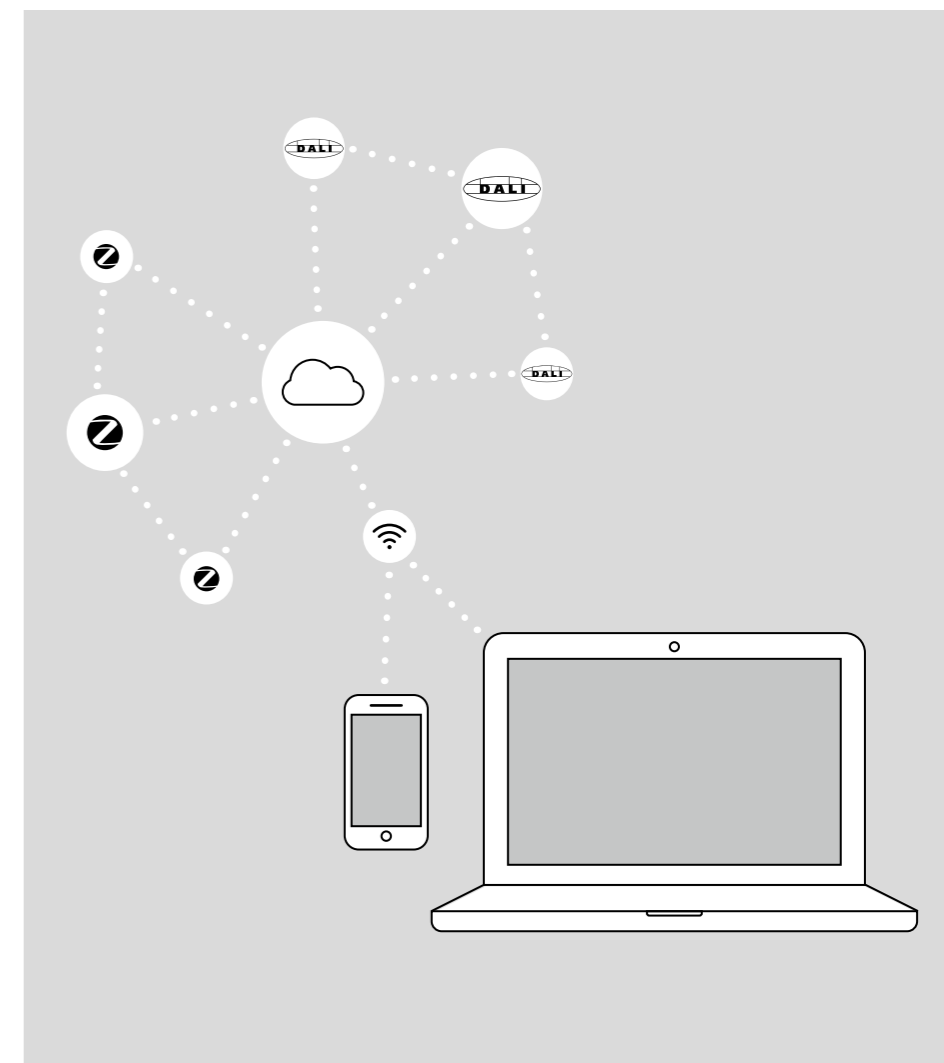

Magnetic attachment

EN MOVE IT Insets are mounted without tools and magnetically fixed within the profile. They can, therefore, be adjusted and adapted according to the lighting requirements with just one movement.

DE MOVE IT Insets werden werkzeuglos montiert und innerhalb des Profils magnetisch fixiert. So lassen sie sich mit nur einem Handgriff beliebig verstellen und anpassen – je nach Anforderung an die Beleuchtung.

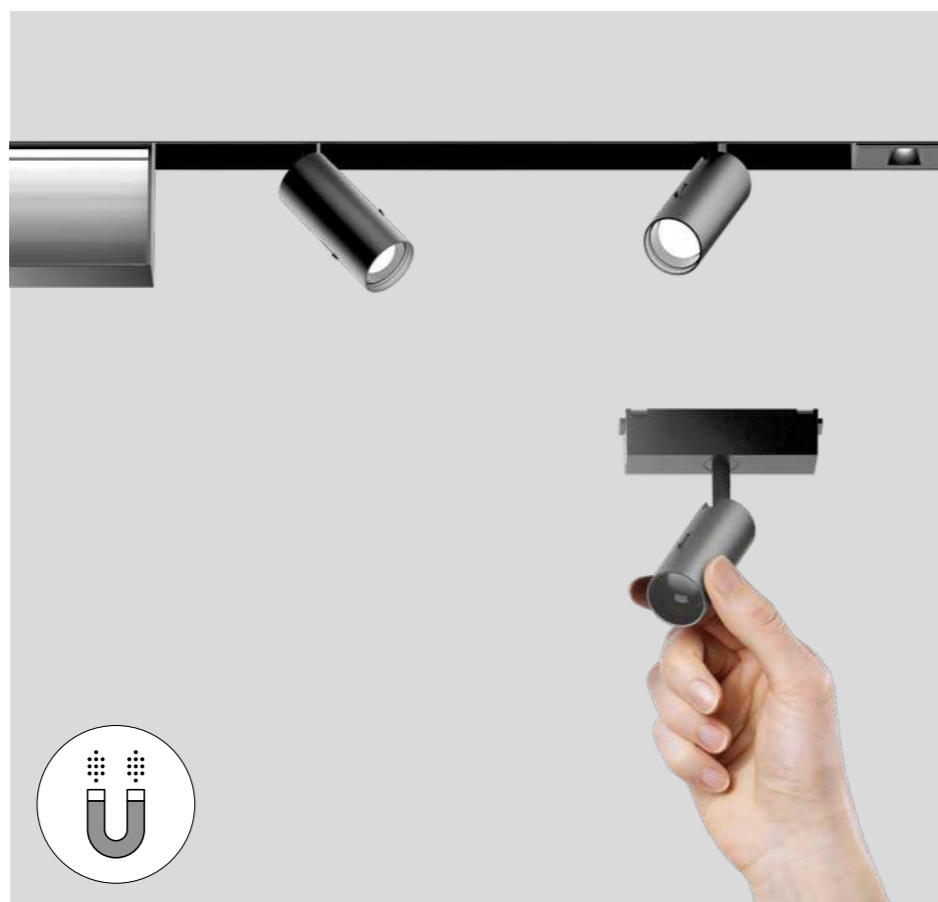

IoT ready

EN IoT ready refers to the possibility of equipping luminaires with smart sensor technology. You receive valuable information, such as your lighting system's energy consumption or your rooms' utilisation over the day. You can set shut-off delay times and brightness values or plan time-controlled light sequences. The sensor is magnetically inserted into the track system like a spotlight and can be individually configured without restriction by existing standards.

DE IoT ready bezeichnet die Möglichkeit, Leuchten mit smarter Sensorik auszustatten. Auf diesem Weg erhalten Sie wertvolle Informationen, wie den Energieverbrauch Ihrer Beleuchtungsanlage oder die Auslastung Ihrer Räume über den Tagesverlauf. Sie können zudem Nachlaufzeiten und Helligkeitswerte einstellen oder zeitgesteuerte Lichtverläufe planen. Der Sensor wird wie ein Strahler magnetisch in das Schienensystem eingesetzt und ist individuell konfigurierbar – ohne Einschränkung durch bestehende Standards.

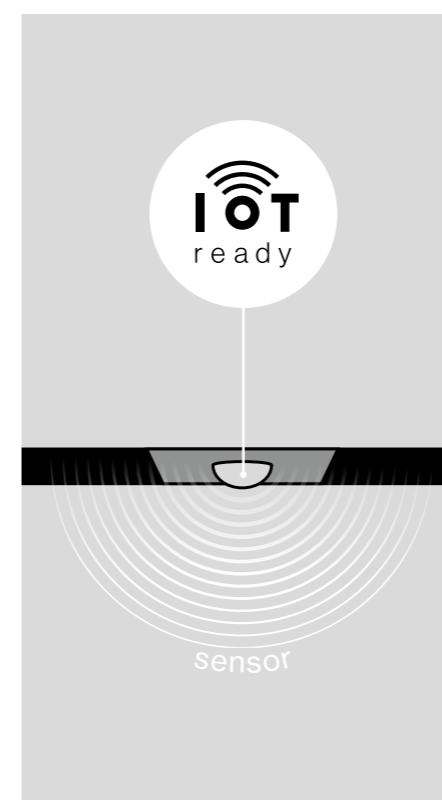

← back



MOVE IT 25 S system

trimless / surface / suspended

Thin extruded aluminium profile with 31mm height and 28mm width groove; optionally for trimless installation in plasterboard ceilings (wall or ceiling mounting) with 12.5mm ceiling thickness; or for wall-/ceiling surface mounting or suspended mounting (cable suspension, height adjustment without tools, incl. black feed); optional with indirect light component for additional accentuation of the ceiling; for lighting systems; linear, 90° angle connectors or 90° CURVE segment; with integrated power track profile for take off of supply voltage and DALI signal; surface anodised or powder coated; insets can be installed flexibly and without tools by means of magnetic holders + locking

Niedriges Aluminiumstrangpressprofil mit 31mm Höhe und 28mm Fugenbreite; wahlweise für den randlosen Einbau in Gipskartondecken (Wand- oder Deckenmontage) mit 12,5mm Deckenstärke; oder für Wand-/Deckenanbaumontage oder für abgehängte Montage (Seilabhängung, werkzeuglose Höhenverstellung, inkl. schwarzer Einspeisleitung); optional mit indirekter Lichtkomponente für zusätzliche Akzentuierung der Decke; für Lichtsysteme; linear, 90° Winkelverbinder oder 90° CURVE Element; mit integriertem Stromschienenprofil für Abnahme von Versorgungsspannung und DALI Signal; Oberfläche eloxiert bzw. pulverbeschichtet; flexible und werkzeuglose Montage der Einsätze durch Magnethalterung + Verriegelung

Quickinfo

3000K
CRI ≥ 90, 2 SDCM
up to 117lm/W
L80 @ 50 000h
non DIM, DALI-2

Types

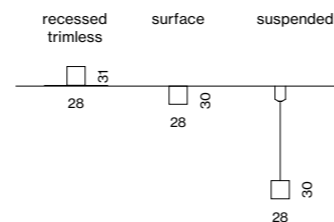

connector

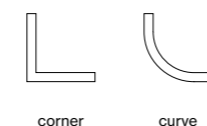

Colours



Order options

CONTROL	
non DIM	1
DALI-2	3

MATERIAL COLOUR

● jet black RAL 9005

Options on request

CONNECTOR

T-connector

X-connector

INSTALLATION TRACK

acoustic soft ceilings

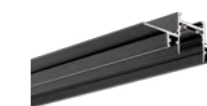

MOVE IT 25 S trimless

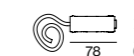
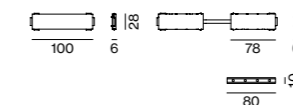
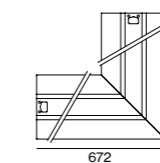
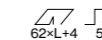

INSTALLATION TRACK

L (mm)

617	channel
1217	channel
2417	channel
3622	channel
672x645	channel corner* 90°
661x661	channel corner* ceiling to wall 90°

*incl. electrical connector set

Accessories

END CAPS

TYPE

end caps (pair)

ORDER CODE	
050-72120	8
050-72140	8
050-72180	8
050-72190	8
050-72110	8
050-72111	8

ORDER CODE	
050-7210008	

BLIND COVER

L (mm)

1217	
2417	
3622	

ORDER CODE	
050-7004008	
050-7008008	
050-7009008	

blind cover can be shortened as desired

CONNECTOR SET

TYPE

linear connector (non DIM, DALI-2)
linear connector flexible
mechanical linear connector (pair)

ORDER CODE	
050-2031130	
050-20321	0
050-2011110	

POWER FEEDER UNIT

TYPE

non DIM 2 × 2,5mm²
DALI-2 2 × 2,5 + 2 × 0,5mm²

ORDER CODE	
050-2020110	
050-2020130	

cable length 500mm

Electrical accessories

see page 708

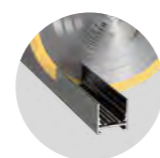

custom cut on building site

← back

Order options

CONTROL

non DIM	1
DALI-2	3

MATERIAL COLOUR

● jet black RAL 9005	8
● traffic white 9016 / jet black 9005 P	
● gold dust 260-M / jet black 9005 G	
● special colours* p.992 X	

*inside always in black

MATERIAL COLOUR ACCESSORIES

○ traffic white RAL 9016	7
● jet black RAL 9005	8

MATERIAL COLOUR CABLE SUSPENSION

chrome	0
black	8

Options on request

CONNECTOR

T-connector	
X-connector	



MOVE IT 25 S surface/suspended

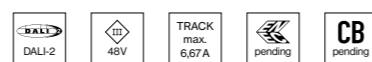

INSTALLATION TRACK / BLIND COVER

L (mm)		ORDER CODE
620	channel	050-73120
1220	channel	050-73140
2420	channel	050-73180
3625	channel	050-73190
637x610	channel corner* 90°	050-73110
666x666	channel corner* ceiling to wall 90°	050-73111

*incl. electrical connector set

1217	blind cover	050-7004008
2417	blind cover	050-7008008
3622	blind cover	050-7009008

CURVE CONNECTOR

TYPE	ORDER CODE
mechanical & electrical R 300mm	050-731303
mechanical R 300mm	050-731311

Accessories

END CAPS

TYPE	ORDER CODE
end caps (pair)	050-731000

CONNECTOR SET

TYPE	ORDER CODE
mechanical linear conn. incl. 1500mm cable susp.	050-201131
mechanical linear connector surface	050-2011210
mechanical & electrical linear connector	050-2031230
mechanical & electrical corner connector flex	050-2032238

POWER FEEDER UNIT

TYPE	ORDER CODE
non DIM 2×2,5mm ²	050-2022110
DALI-2 2×2,5 + 2×0,5mm ²	050-2022130

cable length 2000mm

CEILING FASTENER / CABLE SUSPENSION / CANOPY

TYPE	L (mm)	ORDER CODE
ceiling fastener	10	050-204111
cable suspension	1500	005-215211
canopy		005-231121

*use every 1200mm

Electrical accessories

see page 708

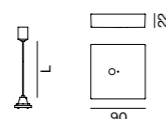
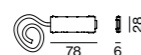
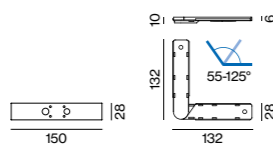
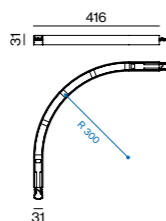
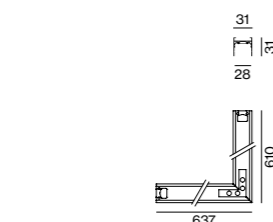

Order options

COLOUR TEMPERATURE

3000K	
-------	--

CONTROL

non DIM	1
DALI-2	3

MATERIAL COLOUR

● jet black RAL 9005	8
● traffic white 9016 / jet black 9005 P	
● gold dust 260-M / jet black 9005 G	
● special colours* p.992 X	

*inside always in black

MATERIAL COLOUR ACCESSORIES

○ traffic white RAL 9016	7
● jet black RAL 9005	8

MATERIAL COLOUR CABLE SUSPENSION

chrome	0
black	8

Options on request

COLOUR RENDERING INDEX

CRI ≥ 98 XPECTRUM	
-------------------	--

COLOUR TEMPERATURE

2700K	
4000K	
tunable white 2700–6500K*	

*DALI-2 DT8

CONNECTOR

T-connector	
X-connector	



MOVE IT 25 S suspended indirect



INSTALLATION TRACK INDIRECT

L (mm)	SYSTEM POWER	LUMINOUS FLUX	ORDER CODE
620	6.2W	638lm	050-74125
1220	15W	1790lm	050-74145
2420	33W	3830lm	050-74185
3625	50W	5745lm	050-74195
637x610	13W	1530lm	050-74110

corner* no custom cut on building side; *incl. electrical connector set

1217	blind cover	050-7004008
2417	blind cover	050-7008008
3622	blind cover	050-7009008

Accessories

END CAPS

TYPE	ORDER CODE
end caps (pair)	050-731000

CONNECTOR SET

TYPE	ORDER CODE
mechanical linear conn. incl. 1500mm cable susp.	050-201131
mechanical & electrical linear connector	050-2031230
mechanical & electrical corner connector flex	050-2032238

POWER FEEDER UNIT

TYPE	ORDER CODE
non DIM 2×2,5mm ²	050-2022110
DALI-2 2×2,5 + 2×0,5mm ²	050-2022130

cable length 2000mm

CABLE SUSPENSION / CANOPY

TYPE	L (mm)	ORDER CODE
cable suspension	1500	005-215211
canopy		005-231121

*use every 1200mm

Electrical accessories

see page 708

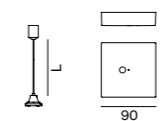
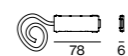
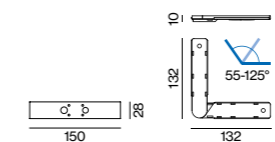
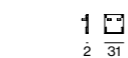
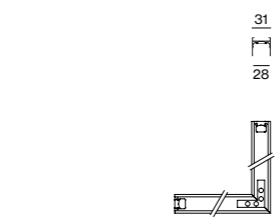



MOVE IT 25 system

trimless / surface / suspended

Extruded aluminium profile with 28 mm width groove; for trimless installation in plasterboard ceilings (wall or ceiling mounting) with 12.5 mm ceiling thickness; or for wall-/ceiling surface mounting or suspended mounting (cable suspension, height adjustment without tools, incl. black feed); optional indirect light component for additional accentuation of the ceiling; for lighting systems; linear, 90° angle connectors or 90° CURVE segment; node connectors, up to 6 profile connection options; with power track profile for take off of supply voltage and DALI signal; surf. anod. or powder coated; insets can be installed flexibly and without tools by means of magnetic holders + locking; sound absorbing accessories available

Aluminiumstrangpressprofil mit 28 mm Fugenbreite; für randlosen Einbau in Gipskartondecken (Wand- oder Deckenmontage) mit 12,5 mm Deckenstärke; oder für Wand-/Deckenanbaumontage oder für abgehängte Montage (Seilabhängung, werkzeuglose Höhenverstellung, inkl. schwarzer Einspeiseleitung); optional indirekte Lichtkomponente für zusätzliche Akzentuierung der Decke; für Lichtsysteme; linear, 90° Winkelverbinder oder 90° CURVE Element; Knotenverbinder, bis zu 6 Profilanchlussmöglichkeiten; mit Stromschienenprofil für Abnahme von Versorgungsspannung und DALI Signal; Oberfl. elox. bzw. pulverbeschichtet; flexible und werkzeuglose Montage der Einsätze durch Magnethalterung + Verriegelung; schallabsorbierendes Zubehör erhältlich

Quickinfo

3000K
CRI ≥ 90, 2 SDCM
up to 117 lm/W
L80 @ 50 000 h
non DIM, DALI-2

Types

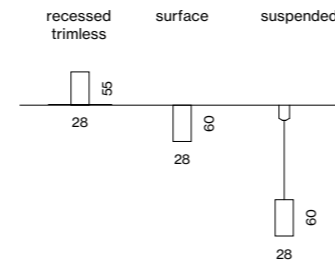

connectors

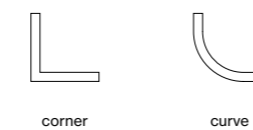
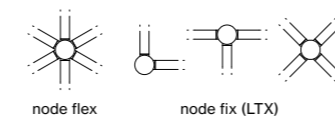

Colours



Order options

CONTROL	
non DIM	1
DALI-2	3

MATERIAL COLOUR

● jet black RAL 9005

Options on request

CONNECTOR

T-connector

X-connector

INSTALLATION TRACK

acoustic soft ceilings

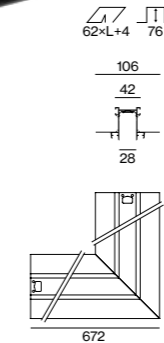
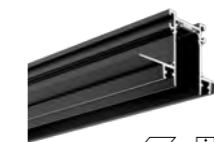

MOVE IT 25 trimless



INSTALLATION TRACK

L (mm)		ORDER CODE
617	channel	050-72020-8
1217	channel	050-72040-8
2417	channel	050-72080-8
3622	channel	050-72090-8
672x645	channel corner* 90°	050-72010-8
661x661	channel corner* ceiling to wall 90°	050-72011-8

*incl. electrical connector set

Accessories

END CAPS

TYPE	ORDER CODE
end caps (pair)	050-7200008

BLIND COVER

L (mm)	ORDER CODE
1217	050-7004008
2417	050-7008008
3622	050-7009008

blind cover can be shortened as desired

CONNECTOR SET

TYPE	ORDER CODE
linear connector (non DIM, DALI-2)	050-2031130
linear connector flexible	050-20321-0
mechanical linear connector (pair)	050-2011110

POWER FEEDER UNIT

TYPE	ORDER CODE
non DIM 2 × 2,5 mm ²	050-2020110
DALI-2 2 × 2,5 + 2 × 0,5 mm ²	050-2020130

cable length 500 mm

Electrical accessories

see page 708

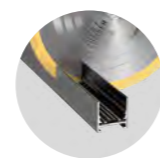

custom cut on building site



acoustic elements (p. 772)

← back

Order options

CONTROL	
non DIM	1
DALI-2	3

**MATERIAL COLOUR
INSTALLATION TRACK**

● jet black RAL 9005	8
● traffic white 9016 / jet black 9005 P	
● gold dust 260-M / jet black 9005 G	
● special colours* p.992 X	

*inside always in black

**MATERIAL COLOUR
NODE CONNECTOR**

○ traffic white RAL 9016	7
● jet black RAL 9005	8
● special colours* p.992 X	

**MATERIAL COLOUR
NODE LTX / END CAP**

● jet black RAL 9005	8
● traffic white 9016 / jet black 9005 P	
● special colours* p.992 X	

**MATERIAL COLOUR
ACCESSORIES**

○ traffic white RAL 9016	7
● jet black RAL 9005	8

**MATERIAL COLOUR
CABLE SUSPENSION**

chrome	0
black	8

**NODE CONNECTOR
MOUNTING TYPE**

surface*	1
1500 mm cable susp. chrome	3
1500 mm cable susp. black	4

*only for L/T/X



MOVE IT 25 surface/suspended



INSTALLATION TRACK / BLIND COVER

L (mm)		ORDER CODE
620	channel	050-73020
1220	channel	050-73040
2420	channel	050-73080
3625	channel	050-73090
637x610	channel corner* 90°	050-73010
666x666	channel corner* ceiling to wall 90°	050-73011

*incl. electrical connector set

1217	blind cover	050-7004008
2417	blind cover	050-7008008
3622	blind cover	050-7009008

CURVE CONNECTOR

TYPE	ORDER CODE
mechanical & electrical R 300 mm	050-730303
mechanical R 300 mm	050-730311

Accessories

TYPE	ORDER CODE
end caps (pair)	050-730000

FLEX NODE CONNECTOR

TYPE	ORDER CODE
FLEX NODE surface mounted	050-203333
FLEX NODE surface mounted incl. feeder	050-202243
FLEX NODE cable suspension 1500 mm	050-20331
FLEX NODE cable susp. 1500 mm incl. feeder	050-20222
NODE end cap* incl. electrical connector	050-730010

*order for every node connection (channel to node) 1 end cap

FIX NODE CONNECTOR

TYPE	ORDER CODE
L NODE incl. end cap & electrical connector	050-73054
T NODE incl. end cap & electrical connector	050-73052
X NODE incl. end cap & electrical connector	050-73053

CONNECTOR SET

TYPE	ORDER CODE
mechanical linear conn. incl. 1500 mm cable susp.	050-201131
mechanical linear connector surface	050-2011210
mechanical & electrical linear connector	050-2031230
mechanical & electrical corner connector flex	050-2032238

POWER FEEDER UNIT

TYPE	ORDER CODE
non DIM 2×2,5 mm ²	050-2020110
DALI-2 2×2,5 + 2×0,5 mm ²	050-2020130

cable length 2000 mm

CEILING FASTENER / CABLE SUSPENSION / CANOPY

TYPE	L (mm)	ORDER CODE
ceiling fastener	10	050-204111
cable susp. (use very 1200 mm)	1500	005-215211
canopy		005-231121

Electrical accessories

see page 708

Acoustic elements

see page 772

Order options

COLOUR TEMPERATURE
3000K

CONTROL	
non DIM	1
DALI-2	3

**MATERIAL COLOUR
INSTALLATION TRACK**

● jet black RAL 9005	8
● traffic white 9016 / jet black 9005 P	
● gold dust 260-M / jet black 9005 G	
● special colours* p.992 X	

*inside always in black

**MATERIAL COLOUR
NODE CONNECTOR**

○ traffic white RAL 9016	7
● jet black RAL 9005	8
● special colours* p.992 X	

**MATERIAL COLOUR
NODE LTX / END CAP**

● jet black RAL 9005	8
● traffic white 9016 / jet black 9005 P	
● special colours* p.992 X	

**MATERIAL COLOUR
ACCESSORIES**

○ traffic white RAL 9016	7
● jet black RAL 9005	8

**MATERIAL COLOUR
CABLE SUSPENSION**

chrome	0
black	8

**NODE CONNECTOR
MOUNTING TYPE**

surface*	1
1500 mm cable susp. chrome	3
1500 mm cable susp. black	4

*only for L/T/X

Options on request

COLOUR RENDERING INDEX
CRI ≥ 98 XPECTRUM

COLOUR TEMPERATURE
2700K
4000K
tunable white 2700–6500K*

*DALI-2 DT8

LUMINOUS FLUX value calculated for 3000K, CRI ≥ 90, colour white/black



MOVE IT 25 suspended indirect



INSTALLATION TRACK INDIRECT

L (mm)	SYSTEM POWER	LUMINOUS FLUX	ORDER CODE
620	6.2 W	638 lm	050-74025
1220	15 W	1790 lm	050-74045
2420	33 W	3830 lm	050-74085
3625	50 W	5745 lm	050-74095
637x610	13 W	1530 lm	050-74010

*incl. electrical connector set

1217	blind cover	050-7004008
2417	blind cover	050-7008008
3622	blind cover	050-7009008

Accessories

TYPE	ORDER CODE
end caps (pair)	050-730000

FLEX NODE CONNECTOR

TYPE	ORDER CODE
FLEX NODE cable suspension 1500 mm	050-20331
FLEX NODE cable susp. 1500 mm incl. feeder	050-20222
FLEX NODE end cap* incl. electrical connector	050-730010

*order for every node connection (channel to node) 1 end cap

FIX NODE CONNECTOR

TYPE	ORDER CODE
L NODE incl. end cap & electrical connector	050-73054
T NODE incl. end cap & electrical connector	050-73052
X NODE incl. end cap & electrical connector	050-73053

CONNECTOR SET

TYPE	ORDER CODE
mechanical linear conn. incl. 1500 mm cable susp.	050-201131
mechanical & electrical linear connector	050-2031230
mechanical & electrical corner connector flex	050-2032238

POWER FEEDER UNIT

TYPE	ORDER CODE
non DIM 2×2,5 mm ²	050-2020110
DALI-2 2×2,5 + 2×0,5 mm ²	050-2020130

cable length 2000 mm

CABLE SUSPENSION / CANOPY

TYPE	L (mm)	ORDER CODE
cable suspension*	1500	005-215211
canopy		005-231121

*use every 1200 mm

Electrical accessories

see page 708

Acoustic elements

see page 772

← back

Order options

CONTROL

non DIM	1
DALI-2	3

MATERIAL COLOUR

○ traffic white RAL 9016	7
● jet black RAL 9005	8

Electrical accessories

POWER SUPPLY INTRACK supply 220-240 V AC, 48 V, 50-60 Hz

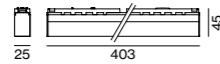

TYPE	EFFICIENCY	MOUNTING	L-W-H (mm)	ORDER CODE
100W* <input type="checkbox"/>	η 92%	intrack	403-26-46	050-2071038
150W* <input type="checkbox"/>	η 92%	intrack	403-26-46	050-2071138

*ENEC approved, incl. feeder cable 2000 mm PC I PC II

POWER SUPPLY SURFACE supply 220-240 V AC, 48 V, 50-60 Hz

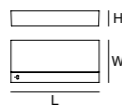

TYPE	EFFICIENCY	MOUNTING	L-W-H (mm)	ORDER CODE
60W <input type="checkbox"/>	η 88%	surface	305-144-54	050-20551 <input type="checkbox"/>
100W <input type="checkbox"/>	η 92%	surface	455-104-40	050-20554 <input type="checkbox"/>
150W <input type="checkbox"/>	η 92%	surface	455-104-40	050-20552 <input type="checkbox"/>
250W <input type="checkbox"/>	η 93%	surface	455-104-40	050-20555 <input type="checkbox"/>
320W <input type="checkbox"/>	η 94%	surface	305-144-54	050-20553 <input type="checkbox"/>

*ENEC approved, incl. feeder cable 2000 mm PC I PC II

POWER SUPPLY EXTERNAL supply 220-240 V AC, 48 V, 50-60 Hz

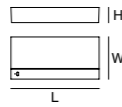

TYPE	EFFICIENCY	MOUNTING	L-W-H (mm)	ORDER CODE
60W <input type="checkbox"/>	η 88%	external	163-43-32	002-62133
100W <input type="checkbox"/>	η 92%	external	350-30-18	002-62134
150W <input type="checkbox"/>	η 92%	external	350-30-18	002-62135
250W <input type="checkbox"/>	η 93%	external	400-40-22	002-62139
320W <input type="checkbox"/>	η 94%	external	252-90-44	002-60320

*ENEC approved, incl. feeder cable 2000 mm PC I PC II

DIN RAIL POWER SUPPLY BASIC 48 V

220-240 V | 50-60 Hz | PC II | MTBF @ 55° ambient temperature

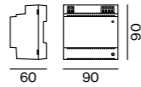

TYPE	EFFICIENCY / MTBF	W-H-D (mm)	ORDER CODE
96W <input type="checkbox"/>	η 89% / > 300.000h	90-90-60	005-6520010

DIN RAIL POWER SUPPLY PRO 48 V

220-240 V | 50-60 Hz | PC I | MTBF @ 55° ambient temperature
cascadable max. 5 devices (240 W) or 3 devices (480 W)

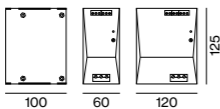

TYPE	EFFICIENCY / MTBF	W-H-D (mm)	ORDER CODE
240W <input type="checkbox"/>	η 92% / > 400.000h	60-125-100	005-6220110
480W <input type="checkbox"/>	η 93% / > 350.000h	120-125-100	005-6220210

DALI-2 SELV DEVICE

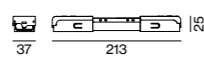

TYPE	L-W-H (mm)	ORDER CODE
control unit	213-37-25	050-2061130

necessary to create DALI-2 SELV signal

DALI-2 SENSOR

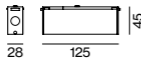

TYPE	L-W-H (mm)	ORDER CODE
ESSENTIAL sensor (brightness & presence)	125-28-45	050-2063178

WIRELESS TO DALI-2 CONTROL DEVICE



TYPE	L-W-H (mm)	ORDER CODE
Zigbee 3.0	111-25-45	050-2065130
Casambi	111-25-45	050-2065230

WIRELESS TO DALI-2 REPEATER



TYPE	L-W-H (mm)	ORDER CODE
Zigbee 3.0	111-25-45	050-2066130
Casambi	111-25-45	050-2066230

MIDDLE FEED

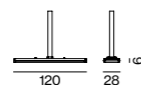

TYPE	ORDER CODE
non DIM 2×2,5mm ²	050-2038110
DALI-2 2×2,5 + 2×0,5mm ²	050-2038130

Blique by Nobis
Stockholm, SE –
by Wingårdhs

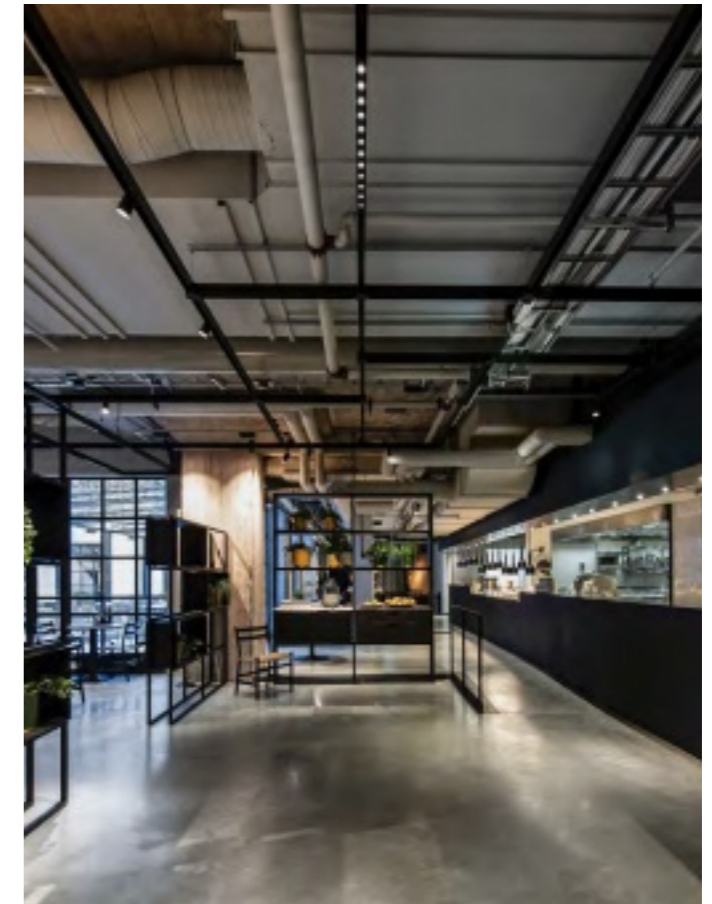

← back



JUST
spotlight inset 25/25 S

Quickinfo

2700K, 3000K, 4000K, TW, CWD
CRI ≥ 90, 2 SDCM
non DIM, DALI-2

L95 @ 50 000h
JUST 32 focus up to 47lm/W

L80 @ 50 000h
JUST 45 up to 72lm/W

L90 @ 50 000h
JUST 55 up to 75lm/W

Types

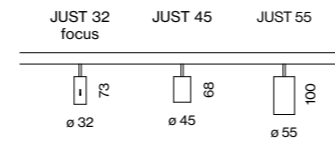

Colours



Light distributions

JUST 32 focus



JUST 45

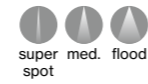

JUST 55

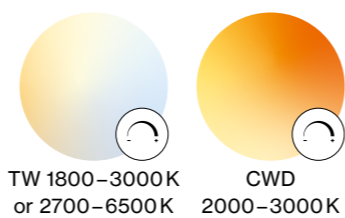

Order options

COLOUR TEMPERATURE

2700K	4
3000K	5
4000K	6
colour warm dim. 2000-3000K*	
tunable white 1800-3000K**	
tunable white 2700-6500K**	

*DALI-2 **DALI-2 DT8

CONTROL

non DIM	1
DALI-2	3

MATERIAL COLOUR

○ traffic white RAL 9016	7
● jet black RAL 9005	8
● special colours p. 992	X

BEAM ANGLE JUST 45

medium 23°	M
flood 44°	F

BEAM ANGLE JUST 55

spot 16°	S
medium 28°	M
flood 37°	F

Options on request

OPTICAL ACCESSORIES
elliptical sculpture foil
snoot
colour filter (red, blue, green, etc.)
only for JUST 32 focus

INSET POWER in watts is the current consumption excluding any ballast
LUMINOUS FLUX value calculated for 3000K, CRI ≥ 90, colour white, lens flood
2700K -5%, 4000K +5%

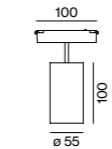
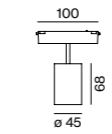
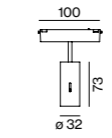

JUST 32 focus 17-43°

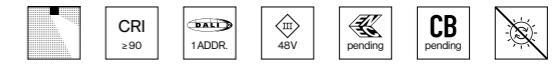

SPOTLIGHT

INSET POWER	LUMINOUS FLUX	ORDER CODE
8.3W	393lm	050-01111

JUST 45

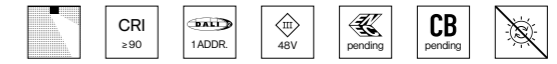

SPOTLIGHT

INSET POWER	LUMINOUS FLUX	ORDER CODE
6.1W super spot 8°	297lm	050-01313
11W	788lm	050-01311
12W CWD 2000-3000K	430lm	050-0131E3
11W TW 1800-3000K	555lm	050-0131L3
11W TW 2700-6500K	683lm	050-0131D3

JUST 55

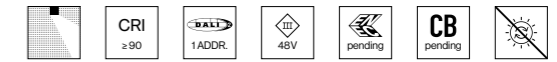

SPOTLIGHT

INSET POWER	LUMINOUS FLUX	ORDER CODE
15.9W	1300lm	050-01433
30W	2090lm	050-01423

Optical accessories

HONEYCOMB LOUVER

TYPE	Ø-H (mm)	ORDER CODE
JUST 32 focus	30·4	007-1965168
JUST 45	42·3	007-1965188
JUST 55	50·3	007-1965598



Hotel & Restaurant Mühlthof
Neufelden, AT –
by AllesWirdGut Architekten



Private Residence Århus, DK –
by Friis Moltke Architects
with lighting design by anker & co



Petersen Tegl Copenhagen, DK –
by Annette Petersen & Peter Zinck
with lighting design by anker & co



Office of ENTASIS Architects
Copenhagen, DK –
by Christian Cold including lighting
design by Christian Cold / anker & co



← back



Quickinfo

2700 K, 3000 K, TW
 CRI ≥ 90, 3 SDCM
 up to 146 lm/W
 L90 @ 50 000 h
 non DIM, DALI-2

Types

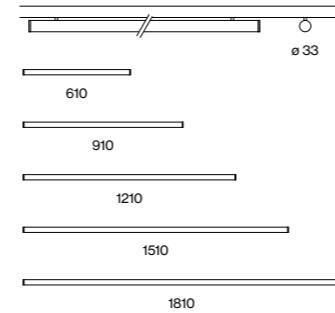

Colour



Light distribution



Order options

COLOUR TEMPERATURE

2700 K	4
3000 K	5
tunable white 1800–4000 K*	L

*DALI-2 DT8

CONTROL

non DIM	1
DALI-2	3

MATERIAL COLOUR

● jet black RAL 9005

Options on request

COLOUR RENDERING INDEX
 CRI ≥ 98 XPECTRUM

COLOUR TEMPERATURE
 4000 K

MATERIAL COLOUR

○ traffic white RAL 9016

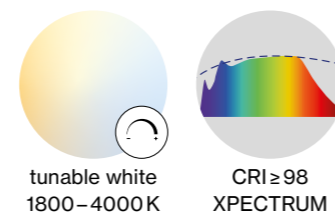

LUMINOUS FLUX value calculated for CRI ≥ 90, colour black

LIGHT INSET 25 S

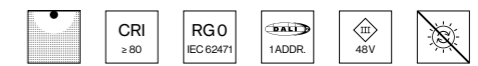
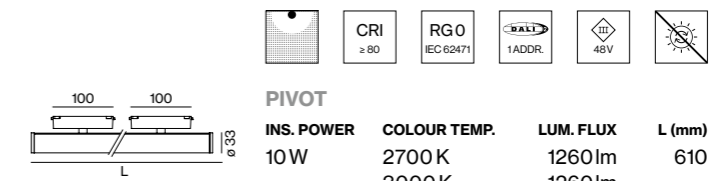

PIVOT

INS. POWER	COLOUR TEMP.	LUM. FLUX	L (mm)	ORDER CODE
10 W	2700 K	1260 lm	610	0 5 0 - 1 3 1 2 :: 8 0
	3000 K	1260 lm		
13 W	2700 K	1900 lm	910	0 5 0 - 1 3 1 3 :: 8 0
	3000 K	1890 lm		
17 W	2700 K	2530 lm	1210	0 5 0 - 1 3 1 4 :: 8 0
	3000 K	2530 lm		
22 W	2700 K	3160 lm	1510	0 5 0 - 1 3 1 5 :: 8 0
	3000 K	3160 lm		
26 W	2700 K	3790 lm	1810	0 5 0 - 1 3 1 6 :: 8 0
	3000 K	3790 lm		

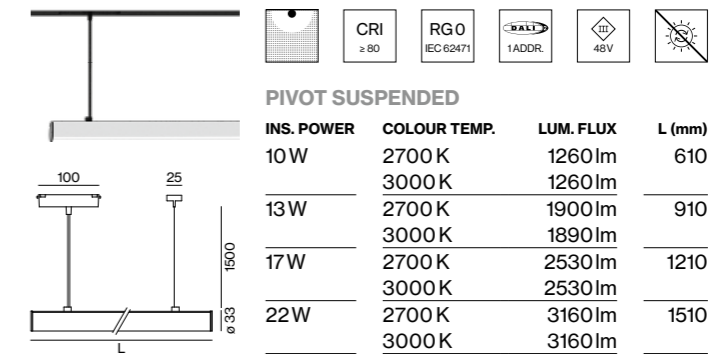

PIVOT SUSPENDED

INS. POWER	COLOUR TEMP.	LUM. FLUX	L (mm)	ORDER CODE
10 W	2700 K	1260 lm	610	0 5 0 - 0 3 2 2 :: 8 0
	3000 K	1260 lm		
13 W	2700 K	1900 lm	910	0 5 0 - 0 3 2 3 :: 8 0
	3000 K	1890 lm		
17 W	2700 K	2530 lm	1210	0 5 0 - 0 3 2 4 :: 8 0
	3000 K	2530 lm		
22 W	2700 K	3160 lm	1510	0 5 0 - 0 3 2 5 :: 8 0
	3000 K	3160 lm		

LIGHT INSET 25

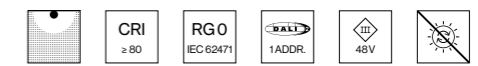
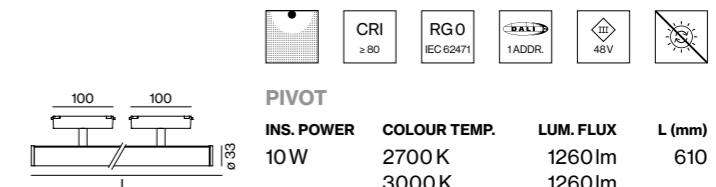

PIVOT

INS. POWER	COLOUR TEMP.	LUM. FLUX	L (mm)	ORDER CODE
10 W	2700 K	1260 lm	610	0 5 0 - 0 3 1 2 :: 8 0
	3000 K	1260 lm		
13 W	2700 K	1900 lm	910	0 5 0 - 0 3 1 3 :: 8 0
	3000 K	1890 lm		
17 W	2700 K	2530 lm	1210	0 5 0 - 0 3 1 4 :: 8 0
	3000 K	2530 lm		
22 W	2700 K	3160 lm	1510	0 5 0 - 0 3 1 5 :: 8 0
	3000 K	3160 lm		
26 W	2700 K	3790 lm	1810	0 5 0 - 0 3 1 6 :: 8 0
	3000 K	3790 lm		

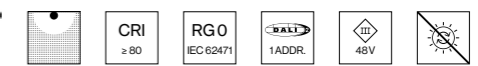
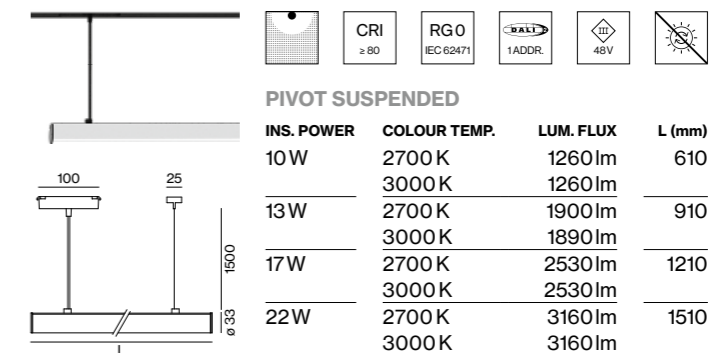

PIVOT SUSPENDED

INS. POWER	COLOUR TEMP.	LUM. FLUX	L (mm)	ORDER CODE
10 W	2700 K	1260 lm	610	0 5 0 - 0 3 2 2 :: 8 0
	3000 K	1260 lm		
13 W	2700 K	1900 lm	910	0 5 0 - 0 3 2 3 :: 8 0
	3000 K	1890 lm		
17 W	2700 K	2530 lm	1210	0 5 0 - 0 3 2 4 :: 8 0
	3000 K	2530 lm		
22 W	2700 K	3160 lm	1510	0 5 0 - 0 3 2 5 :: 8 0
	3000 K	3160 lm		



PIVOT
 graphic light inset 25/25 S



Autodesk Krakow, PL –
by The Design Group with
lighting design by Plus Lighting





Büroausbau in Soho
London, UK – by Design Haus
Liberty / DHL with lighting design
by Alkestie Skarlatou, lightinspace



The Raum Bolzano, IT –
by bergundtal gmbh.



Design Fair Marbella, ES –
by Welcome Design



Quickinfo

non DIM, DALI-2

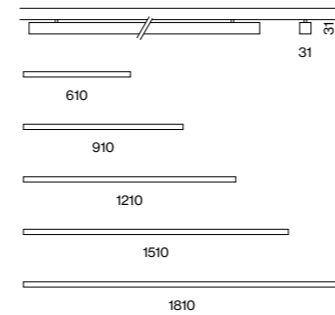
Types**Colours****Order options**

CONTROL	
non DIM	1
DALI-2	3

MATERIAL COLOUR

- jet black RAL 9005 8
- traffic white 9016 / jet black 9005 P
- gold dust 260-M / jet black 9005 G
- special colours* p. 992 X

*inside always in black

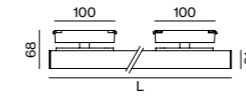
MOVE IT 25 S**FLEXTRACK**

L (mm)	ORDER CODE
610	050-45120
910	050-45130
1210	050-45140
1510	050-45150
1810	050-45160

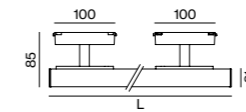
MOVE IT 25**FLEXTRACK**

L (mm)	ORDER CODE
610	050-45020
910	050-45030
1210	050-45040
1510	050-45050
1810	050-45060

FLEXTRACK

system extension 25/25S

EN Thin extruded aluminium profile with 31mm height and 28mm width groove; with integrated power track profile for take off of supply voltage and DALI signal; surface anodised or powder coated; for installation in two MOVE IT 25 or 25 S profiles; profile can be installed and moved without tools by means of magnetic holders+locking; mount 360° rotatable and freely slidable on one end; light insets can be installed flexibly and without tools by means of magnetic holders+locking

DE Niedriges Aluminiumstrangpressprofil mit 31mm Höhe und 28mm Fugenbreite; mit integriertem Stromschienenprofil für Abnahme von Versorgungsspannung und DALI Signal; Oberfläche eloxiert bzw. pulverbeschichtet; zum Einsetzen in zwei MOVE IT 25 bzw. MOVE IT 25 S Profile; Profil mittels Magnethalter+Verriegelung werkzeuglos einsetz- und verschiebbar; Halterung 360° drehbar und an einem Ende beliebig verschiebbar; flexible und werkzeuglose Montage der Lichteinsätze durch Magnethalterung + Verriegelung



Jewelery + Optical Store
Ludwigsburg, DE –
by Ippolito Fleitz Group –
Identity Architects



← back



Quickinfo

2700 K, 3000 K, 4000 K, TW
 CRI ≥ 90, 3 SDCM
 up to 84 lm/W
 L90 @ 50 000 h
 non DIM, DALI-2

Types

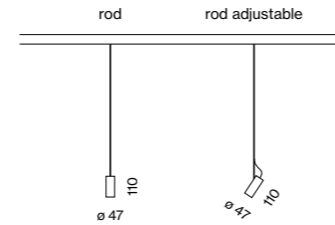

Colours

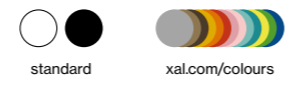

Light distributions



Order options

CABLE SUSPENSION

1500 mm	5
2000 mm with hook*	6

*one ring included

COLOUR TEMPERATURE

2700 K	4
3000 K	5
4000 K	6
tunable white 2200–4000 K*	

*DALI-2 DT8

CONTROL

non DIM	1
DALI-2	3

MATERIAL COLOUR

○ traffic white RAL 9016	7
● jet black RAL 9005	8
🌈 special colours p.992	X

ACCESSORY COLOUR

○ traffic white RAL 9016	7
● jet black RAL 9005	8

BEAM ANGLE

medium 25°	M
flood 44°	F

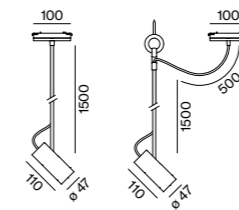
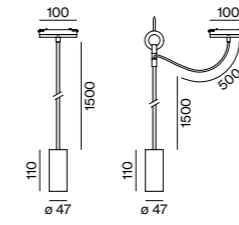

ARY rod



DOWNLIGHT

INSET POWER	COLOUR TEMP.	LUMINOUS FLUX	ORDER CODE
14 W	2700 K	1050 lm	0 5 0 - 0 3 2 1
	3000 K	1100 lm	
	4000 K	1180 lm	
5.4 W TW	2200–4000 K	284 lm	0 5 0 - 0 3 2 1 D 3

ARY rod adjustable



SPOTLIGHT

INSET POWER	COLOUR TEMP.	LUMINOUS FLUX	ORDER CODE
14 W	2700 K	1050 lm	0 5 0 - 0 3 3 1
	3000 K	1100 lm	
	4000 K	1180 lm	
5.4 W TW	2200–4000 K	284 lm	0 5 0 - 0 3 3 1 D 3

Mounting accessories

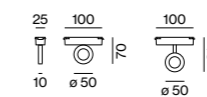

RING track mounted

TYPE	Ø-H (mm)	ORDER CODE
MOVE IT 25 S	50-70	0 5 0 - 1 5 1 0 1 1
MOVE IT 25	50-91	0 5 0 - 0 5 1 0 1 1



RING ceiling mounted

TYPE	Ø-H (mm)	ORDER CODE
MOVE IT 25S/25	50-88	0 5 0 - 0 5 1 0 2 1

reddot winner 2020

DESIGN AWARD 2020

ARY rod
 decorative inset 25/25 S

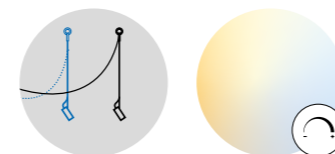

free positioning by ring and hook tunable white 2200 – 4000 K

LUMINOUS FLUX value calculated for CRI ≥ 90, colour white, lens flood

← back



 **reddot** winner 2020

 **DESIGN AWARD 2020**

ARY cable
decorative inset 25/25 S

Quickinfo

2700 K, 3000 K, 4000 K, TW
CRI ≥ 90, 3 SDCM
up to 84 lm/W
L90 @ 50 000 h
non DIM, DALI-2

Types

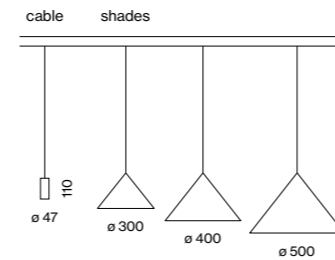

Colours



Light distributions



Order options

CABLE SUSPENSION 

1500 mm	5
2000 mm with hook*	6

*one ring included

COLOUR TEMPERATURE 

2700 K	4
3000 K	5
4000 K	6
tunable white 2200–4000 K*	

*DALI-2 DT8

CONTROL 

non DIM	1
DALI-2	3

MATERIAL COLOUR 

○ traffic white RAL 9016	7
● jet black RAL 9005	8
 special colours  p. 992	X

ACCESSORY COLOUR 

○ traffic white RAL 9016	7
● jet black RAL 9005	8

BEAM ANGLE 

medium 25°	M
flood 44°	F

SHADE COLOUR 

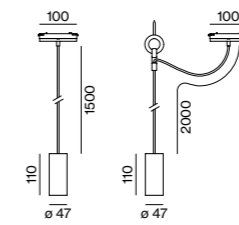
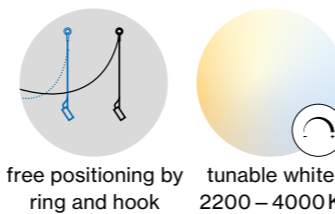

● velvet beige RAL 085 80 10	C
● madeira brown RAL 050 40 40	T
● kingfisher grey RAL 230 60 10	L
● woodpecker olive RAL 1050 20	G
○ signal white RAL 9003	W
● signal black RAL 9004	B



ARY cable





DOWNLIGHT

INSET POWER	COLOUR TEMP.	LUMINOUS FLUX	ORDER CODE
14 W	2700 K	1050 lm	0 5 0 - 0 5 1 1 1 
	3000 K	1100 lm	
	4000 K	1180 lm	
5.4 W TW	2200–4000 K	284 lm	0 5 0 - 0 5 1 1 D 3 

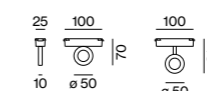
Mounting accessories



RING track mounted

TYPE	Ø-H (mm)	ORDER CODE
MOVE IT 25 S	50-70	0 5 0 - 1 5 1 0 1 1 
MOVE IT 25	50-91	0 5 0 - 0 5 1 0 1 1 





RING ceiling mounted

TYPE	Ø-H (mm)	ORDER CODE
MOVE IT 25S/25	50-88	0 5 0 - 0 5 1 0 2 1 

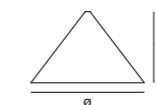
Optical accessories



SHADE

TYPE	Ø-H (mm)	ORDER CODE
cone 300	300-188	0 4 9 - 5 9 3 3 1 1 
cone 400	400-253	0 4 9 - 5 9 3 4 1 1 
cone 500	500-318	0 4 9 - 5 9 3 5 1 1 

only available for ARY cable

LUMINOUS FLUX value calculated for CRI ≥ 90, colour white, lens flood



Noma 2.0
Copenhagen, DK –
by BIG with interior design
by Studio David Thulstrup

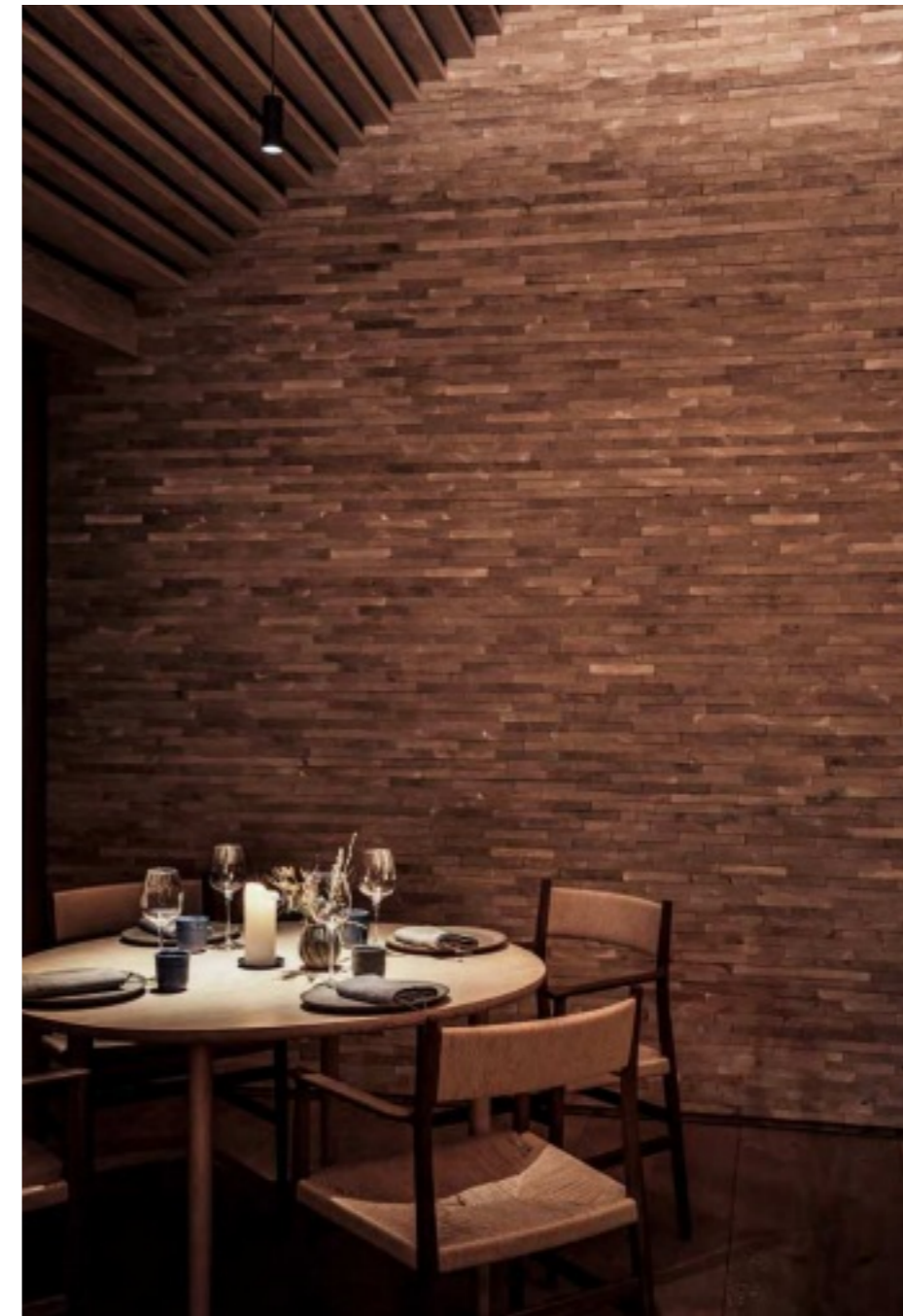

Gwerder Fidel Energietechnik AG
Ibach, CH – by FORM
Innenarchitektur GmbH



← back

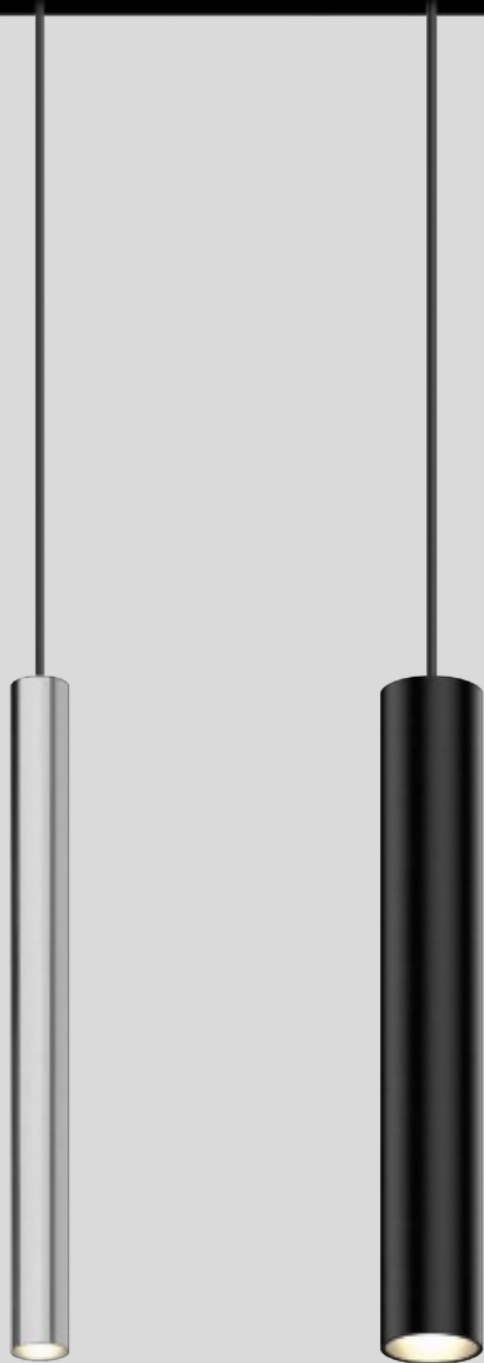

Quickinfo

2700K, 3000K, TW
 CRI ≥ 90, 3 SDCM
 up to 75 lm/W
 L80 @ 50 000 h
 non DIM, DALI-2

Types

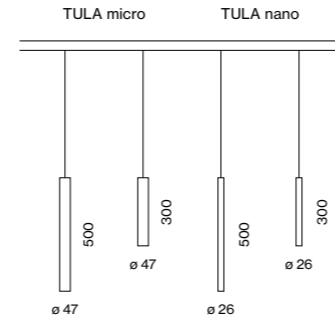

Colours



Light distributions



Order options

HOUSING HEIGHT

300 mm	0
500 mm	1

CABLE SUSPENSION

1500 mm	7
2000 mm with hook*	6

*one ring included

COLOUR TEMPERATURE

2700K	4
3000K	5
tunable white 2200 – 4000K*	

*DALI-2 DT8

CONTROL

non DIM	1
DALI-2	3

MATERIAL COLOUR

chrome	4
traffic white RAL 9016	7
jet black RAL 9005	8
special colours p. 992	X

ACCESSORY COLOUR

traffic white RAL 9016	7
jet black RAL 9005	8

BEAM ANGLE

medium 25°	M
flood 44°	F

Options on request

COLOUR TEMPERATURE

4000K	
-------	--

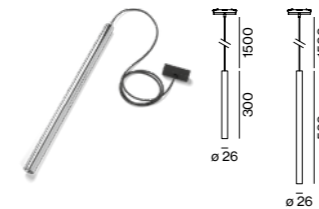

TULA nano suspended



DOWNLIGHT

INSET POWER	COLOUR TEMP.	LUMINOUS FLUX	ORDER CODE
11W	2700K	642lm	050-L 8 1 1 :: ▣ ▣ ▲
	3000K	688lm	

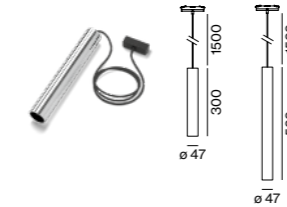

TULA micro suspended

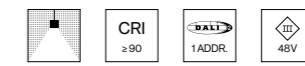

DOWNLIGHT

INSET POWER	COLOUR TEMP.	LUMINOUS FLUX	ORDER CODE
14W	2700K	998lm	050-L 8 1 5 :: ▣ ▣ ▲
	3000K	1048lm	
5.4W	2200 – 4000K	254lm	050-L 8 1 5 D 3 ▣ ▲

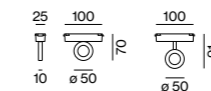

Mounting accessories

RING track mounted

TYPE	Ø-H (mm)	ORDER CODE
MOVE IT 25 S	50-70	050-151011 ▣
MOVE IT 25	50-91	050-051011 ▣



RING ceiling mounted

TYPE	Ø-H (mm)	ORDER CODE
MOVE IT 25S/25	50-88	050-051021 ▣

TULA
 decorative inset 25/25S

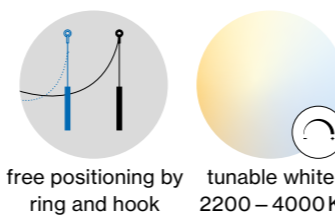

LUMINOUS FLUX value calculated for CRI ≥ 90, colour white, lens flood

Mape kitchen & interior Putte, BE



Private Residence Århus, DK –
by Friis Moltke Architects with
lighting design by anker & co





Private Residence Linz, AT –
by ARKD, architekturbüro arkade
zt gmbh including lighting design



← back

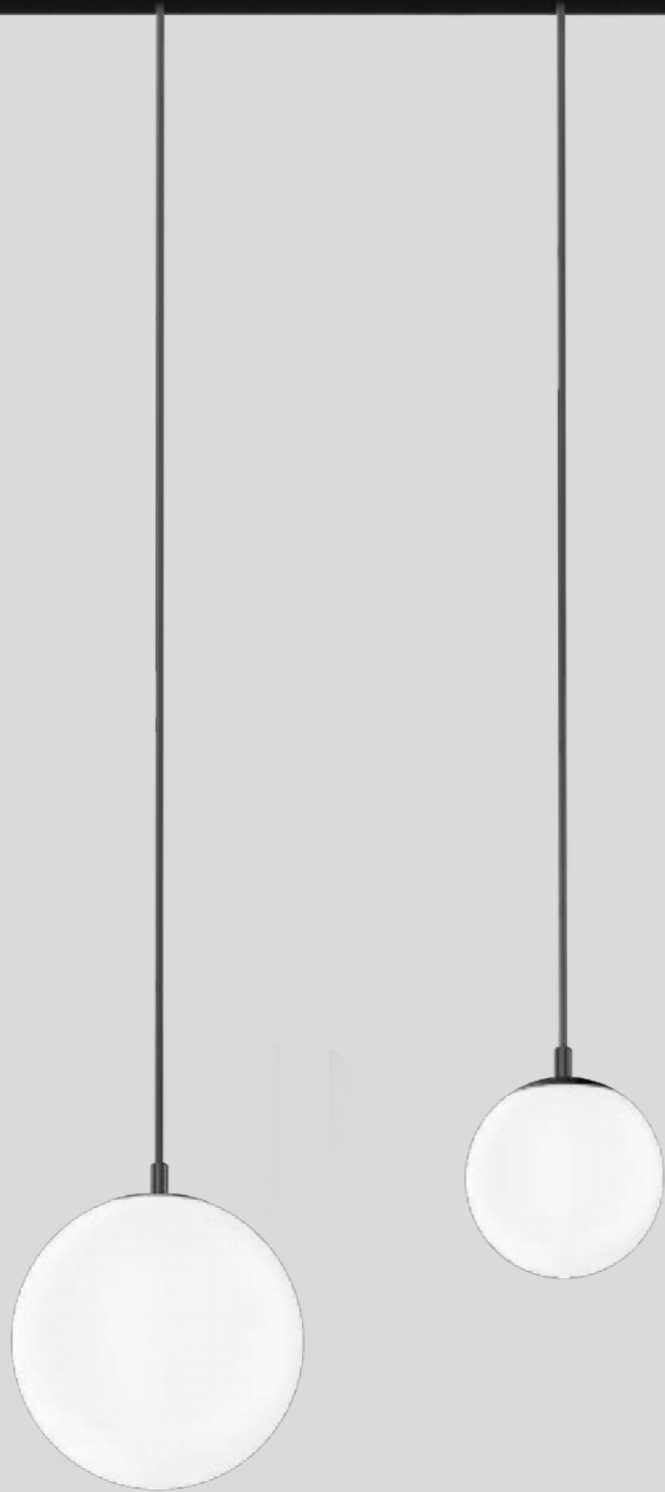

Quickinfo

2700 K, 3000 K
 CRI ≥ 90, 3 SDCM
 up to 55 lm/W
 L80 @ 50 000 h
 non DIM, DALI-2
 IP 40

Types

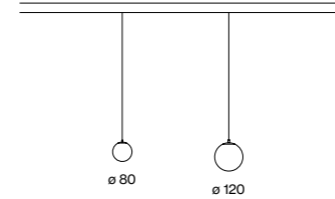

Colours



Light distribution



Order options

CABLE SUSPENSION

1500 mm	5
2000 mm with hook*	6

*one ring included

COLOUR TEMPERATURE

2700 K	4
3000 K	5

CONTROL

non DIM	1
DALI-2	3

MATERIAL COLOUR

○ pure white RAL 9010	7
● jet black RAL 9005	8
🌈 special colours p.992	X

ACCESSORY COLOUR

○ pure white RAL 9010	7
● jet black RAL 9005	8

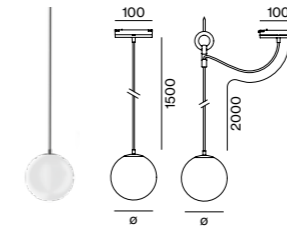

PAL suspended



DOWNLIGHT

INS. POWER	COLOUR TEMP.	LUM. FLUX	Ø (mm)	ORDER CODE
9.1W	2700 K	472lm	80	050-1 11 11
	3000 K	498lm		
9.1W	2700 K	472lm	120	050-1 13 13
	3000 K	498lm		

Mounting accessories

RING track mounted

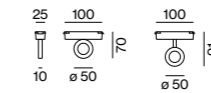

TYPE	Ø-H (mm)	ORDER CODE
MOVE IT 25 S	50-70	050-151011
MOVE IT 25	50-91	050-051011

RING ceiling mounted



TYPE	Ø-H (mm)	ORDER CODE
MOVE IT 25S/25	50-88	050-051021

Restaurant
Visualisation



← back

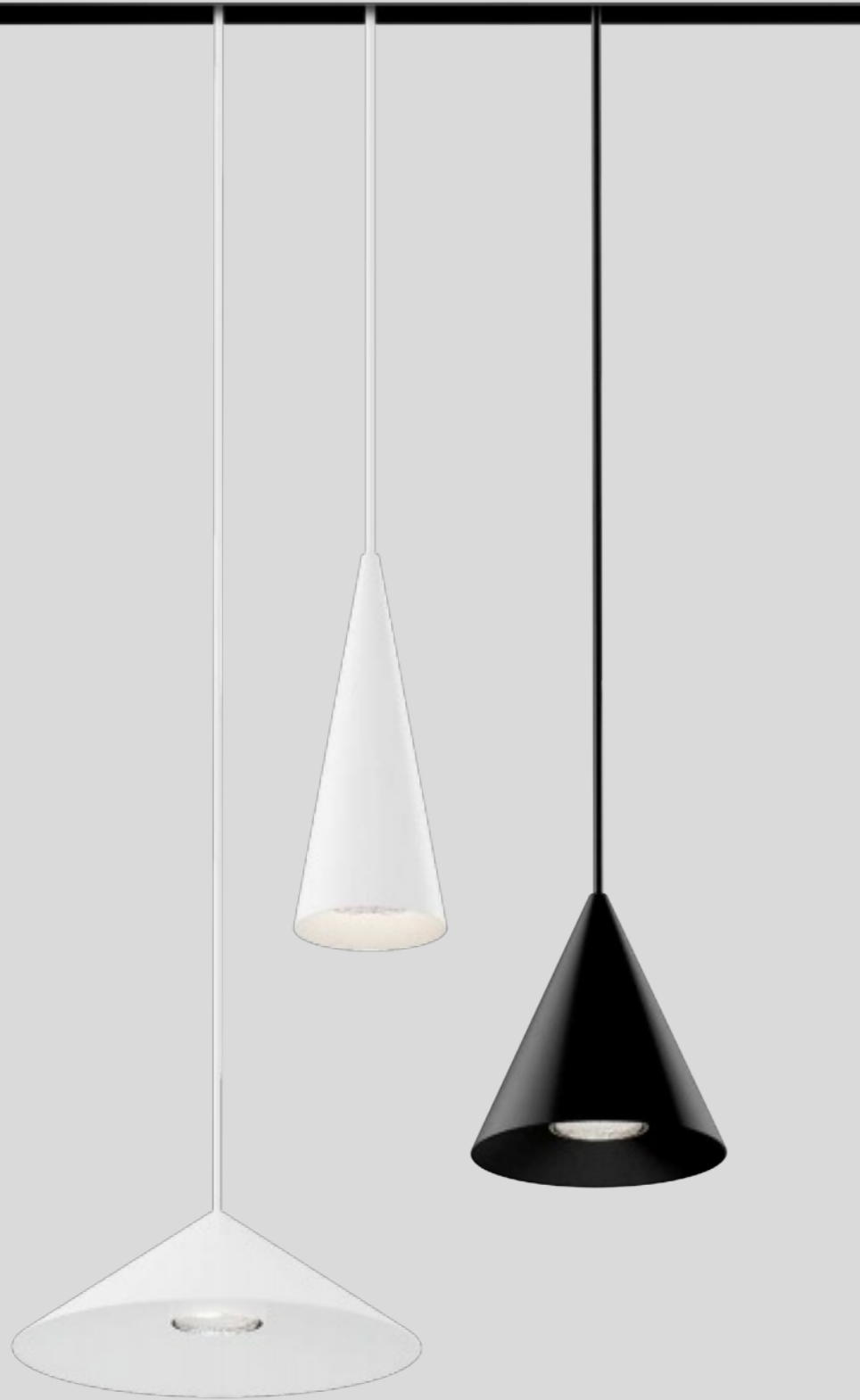

Quickinfo

2700 K
 CRI ≥ 95, 3 SDCM
 up to 97lm/W
 L90 @ 50 000h
 non DIM, DALI-2

Types

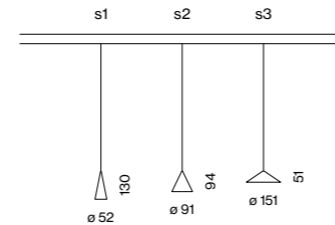

Colours



Order options

CABLE SUSPENSION

3000mm	5
3000mm with hook	6

COLOUR TEMPERATURE

2700K	
-------	--

CONTROL

non DIM	1
DALI-2	3

MATERIAL COLOUR

○ traffic white RAL 9016	7
● jet black RAL 9005	8

ACCESSORY COLOUR

○ pure white RAL 9010	7
● jet black RAL 9005	8

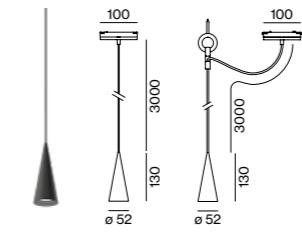

w201 Extra small pendant s1



DOWNLIGHT

INSET POWER	COLOUR TEMP.	LUMINOUS FLUX	ORDER CODE
6W	2700K	445lm	050-04815

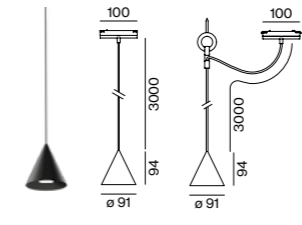

w201 Extra small pendant s2



DOWNLIGHT

INSET POWER	COLOUR TEMP.	LUMINOUS FLUX	ORDER CODE
6W	2700K	509lm	050-04825

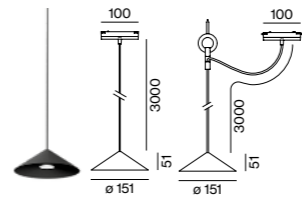

w201 Extra small pendant s3



DOWNLIGHT

INSET POWER	COLOUR TEMP.	LUMINOUS FLUX	ORDER CODE
6W	2700K	579lm	050-04835

Mounting accessories

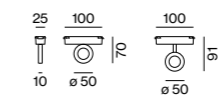

RING track mounted

TYPE	Ø-H (mm)	ORDER CODE
MOVE IT 25 S	50-70	050-151011
MOVE IT 25	50-91	050-051011



RING ceiling mounted

TYPE	Ø-H (mm)	ORDER CODE
MOVE IT 25S/25	50-88	050-051021

wästberg
w201 Extra small pendant

Design by Claesson Koivisto Rune

INSET POWER in watts is the current consumption excluding any ballast
LUMINOUS FLUX value calculated for CRI ≥ 95, colour white

← back

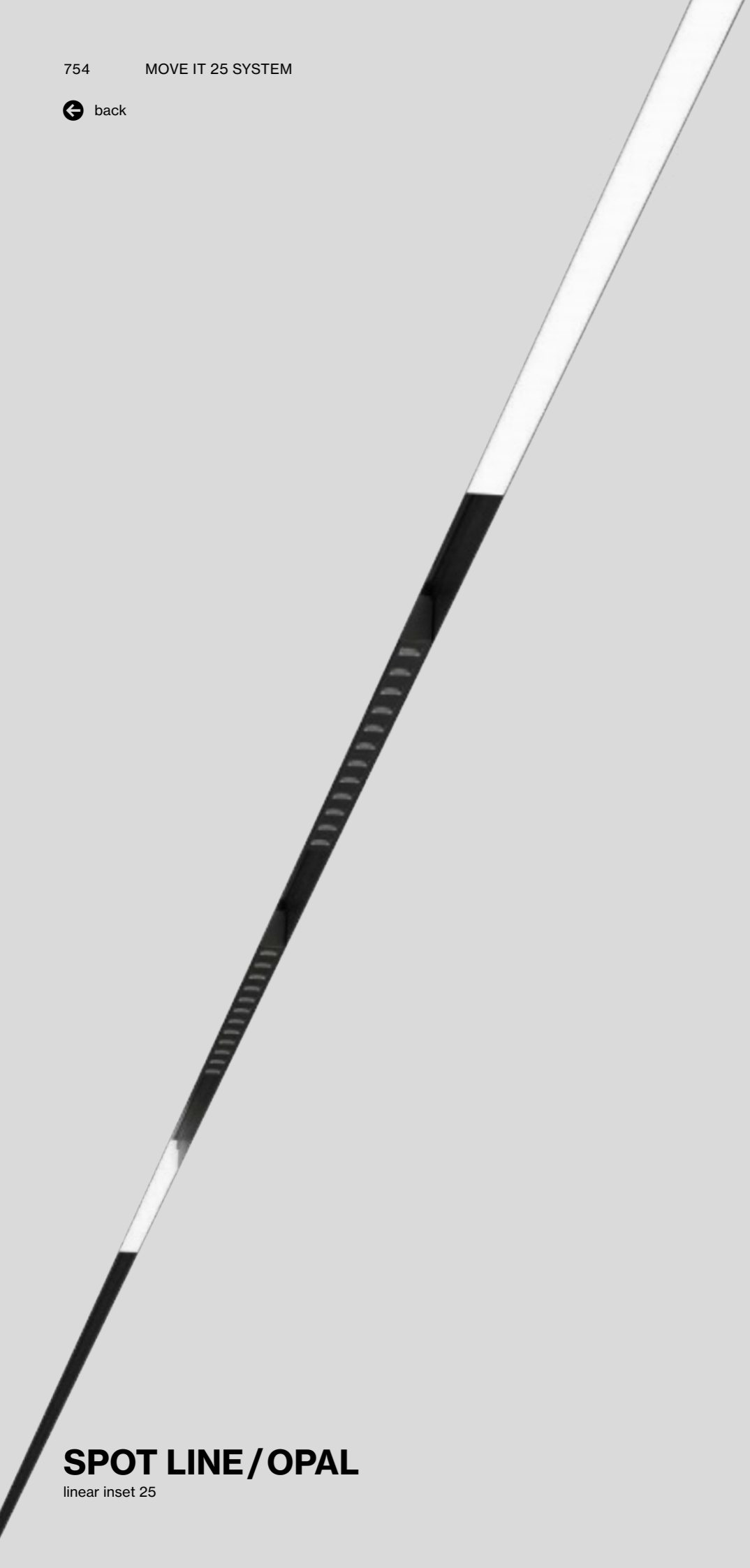

SPOT LINE / OPAL

linear inset 25

Quickinfo

2700K, 3000K, TW (opal)
 CRI ≥ 90, 3 SDCM
 SPOT LINE up to 80 lm/W
 OPAL up to 109 lm/W
 L80 @ 50 000 h
 non DIM, DALI-2

Types

MOVE IT 25

SPOT LINE

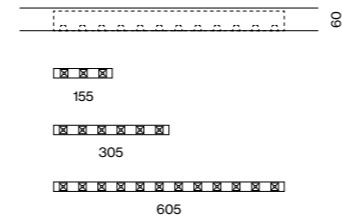

OPAL

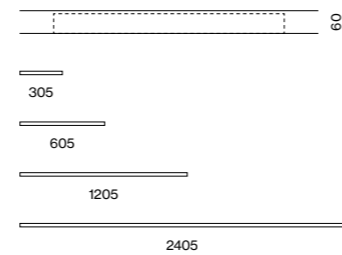

Light distributions

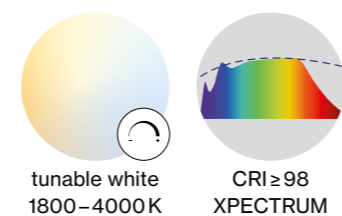
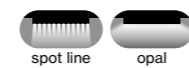

Order options

COLOUR TEMPERATURE	
2700K	4
3000K	5
tunable white 1800-4000K*	L

*only available for opal high performance inset | DALI-2 DT8

CONTROL	
non DIM	1
DALI-2	3

MATERIAL COLOUR

● jet black RAL 9005

Options on request

COLOUR RENDERING INDEX
 CRI ≥ 98 XPECTRUM

COLOUR TEMPERATURE
 4000K

Light distribution

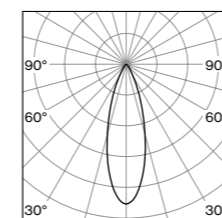

spot line

INSET POWER in watts is the current consumption excluding any ballast
LUMINOUS FLUX value calculated for CRI ≥ 90, colour black

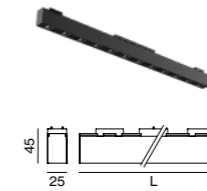

LIGHT INSET 25

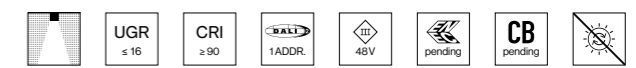

SPOT LINE

INS. POWER	COLOUR TEMP.	LUM. FLUX	L (mm)	ORDER CODE
3 × 1.4 W	2700K	309lm	155	050-0220 :: 8 M
	3000K	336lm		
6 × 1.4 W	2700K	618lm	305	050-0221 :: 8 M
	3000K	672lm		
12 × 1.4 W	2700K	1240lm	605	050-0222 :: 8 M
	3000K	1340lm		

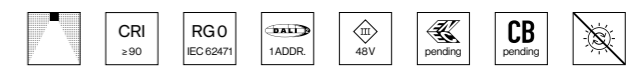
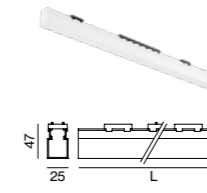

OPAL HIGH PERFORMANCE

INS. POWER	COLOUR TEMP.	LUM. FLUX	L (mm)	ORDER CODE
5 W	2700K	445lm	305	050-0211 :: 8 H
	3000K	477lm		
10 W	2700K	890lm	605	050-0212 :: 8 H
	3000K	954lm		
17 W	2700K	1780lm	1205	050-0214 :: 8 H
	3000K	1910lm		
35 W	2700K	3560lm	2405	050-0218 :: 8 H
	3000K	3820lm		

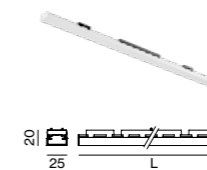

LIGHT INSET 25 S



OPAL HIGH PERFORMANCE

INS. POWER	COLOUR TEMP.	LUM. FLUX	L (mm)	ORDER CODE
5 W	2700K	397lm	305	050-1211 :: 8 H
	3000K	426lm		
10 W	2700K	795lm	605	050-1212 :: 8 H
	3000K	851lm		
17 W	2700K	1590lm	1205	050-1214 :: 8 H
	3000K	1700lm		
35 W	2700K	3180lm	2405	050-1218 :: 8 H
	3000K	3410lm		

canyon solution for MOVE IT 25



Private Residence Sofia, BG –
by Modify studio, Arch Kamelia
Georgieva



ReFuture Clinic Kiev, UA –
by YODEZEEN Architects with lighting
design by Svetlana Osadcha



Deansgate Square Manchester, UK –
by Lister & Lister with lighting design
by Troup, Bywaters & Anders Lighting

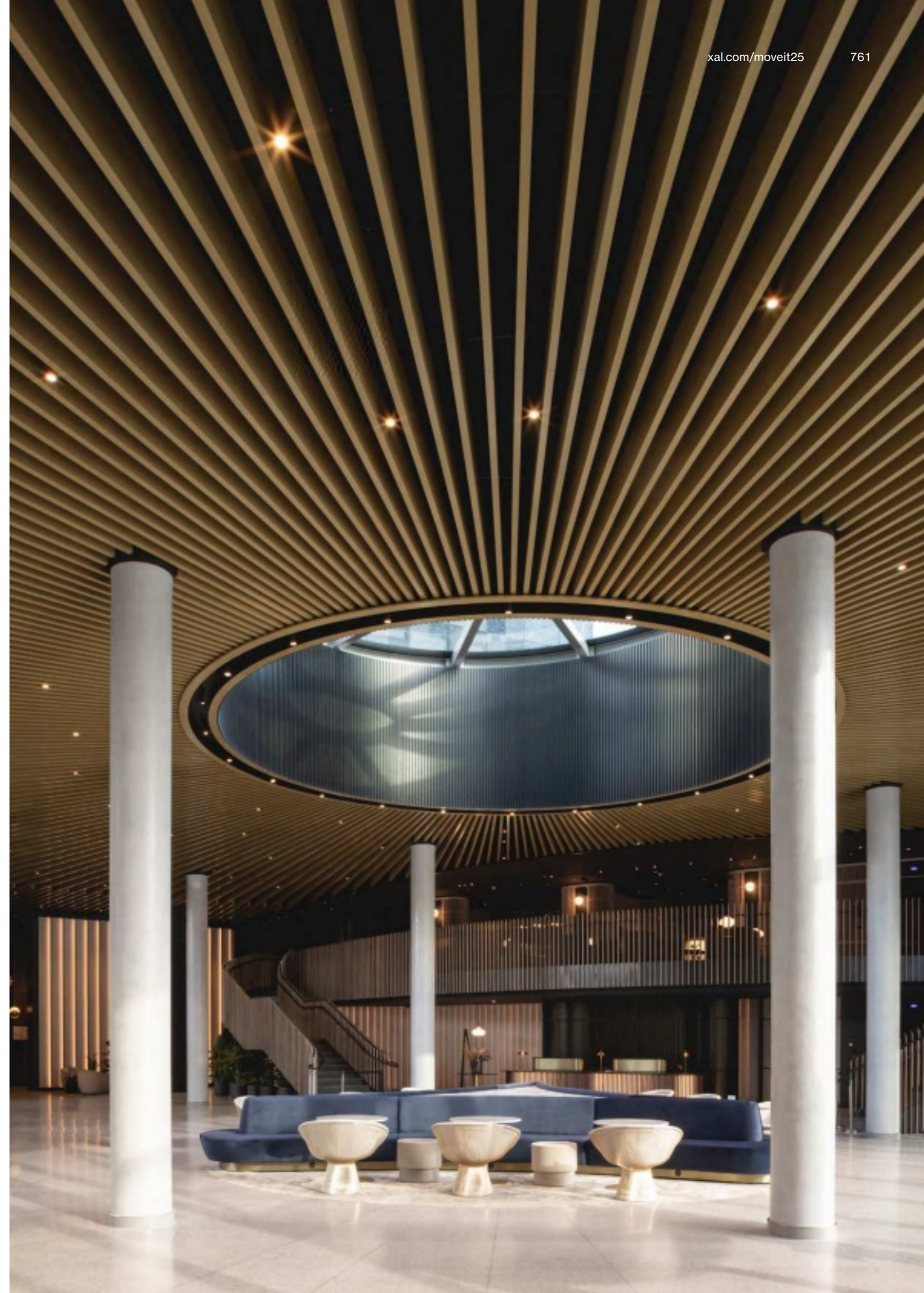
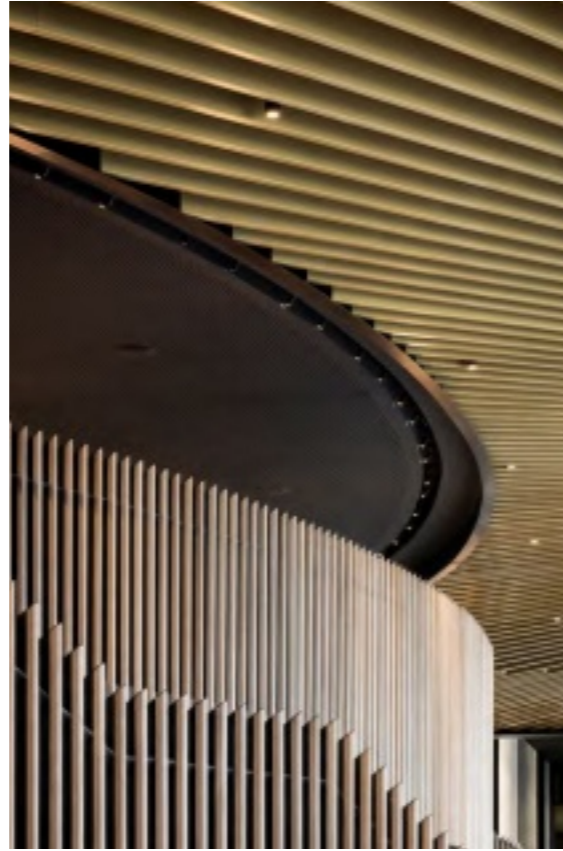

Aertssen Group
Beveren, BE –
by Mertens Architecten



← back



WALLWASHER

linear inset 25/25 S

Quickinfo

2700 K, 3000 K
 CRI ≥ 90, 3 SDCM
 WALLWASHER up to 81lm/W
 WW flush up to 77lm/W
 L80 @ 50 000 h
 non DIM, DALI-2

Types

MOVE IT 25

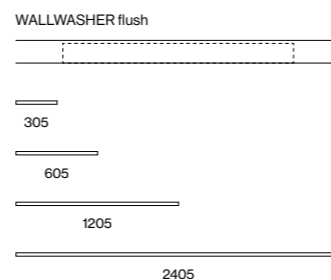
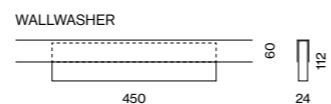

MOVE IT 25 S

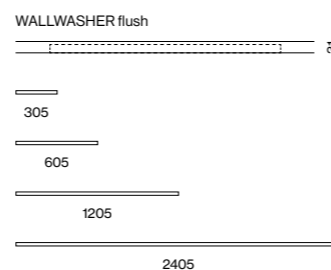

Light distribution



wall washer

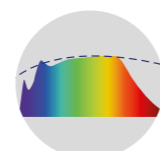

CRI ≥ 98
 XPECTRUM

Order options

COLOUR TEMPERATURE	
2700 K	4
3000 K	5

CONTROL	
non DIM	1
DALI-2	3

MATERIAL COLOUR

● jet black RAL 9005

Options on request

COLOUR RENDERING INDEX
 CRI ≥ 98 XPECTRUM

COLOUR TEMPERATURE
 4000 K

Light distributions

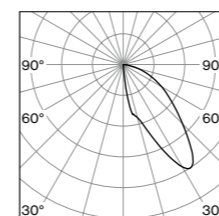

wallwasher

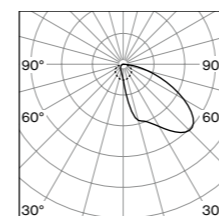

wallwasher flush

INSET POWER in watts is the current consumption excluding any ballast
LUMINOUS FLUX value calculated for CRI ≥ 90, colour black



LIGHT INSET 25



WALLWASHER

INS. POWER	COLOUR TEMP.	LUM. FLUX	L (mm)	ORDER CODE
13 W	2700 K	983 lm	450	0 50-0 2 3 2 :: 3 8 A
	3000 K	1050 lm		

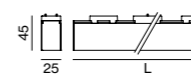
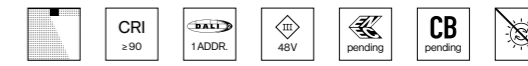

WALLWASHER FLUSH

INS. POWER	COLOUR TEMP.	LUM. FLUX	L (mm)	ORDER CODE
5 W	2700 K	329 lm	305	0 50-0 2 1 1 :: 8 A
	3000 K	367 lm		
11 W	2700 K	658 lm	605	0 50-0 2 1 2 :: 8 A
	3000 K	735 lm		
19 W	2700 K	1320 lm	1205	0 50-0 2 1 4 :: 8 A
	3000 K	1470 lm		
38 W	2700 K	2630 lm	2405	0 50-0 2 1 8 :: 8 A
	3000 K	2940 lm		

Optical accessories

ANTI-GLARE GRID

TYPE	L-W (mm)	ORDER CODE
WALLWASHER FLUSH	303-25	0 50-0 2 3 0 9 1 8

cluster solution to create anti-glare grid for all lengths



LIGHT INSET 25 S

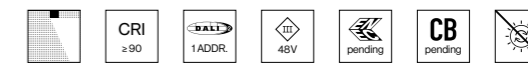

WALLWASHER FLUSH

INS. POWER	COLOUR TEMP.	LUM. FLUX	L (mm)	ORDER CODE
5 W	2700 K	329 lm	305	0 50-1 2 1 1 :: 8 A
	3000 K	367 lm		
11 W	2700 K	658 lm	605	0 50-1 2 1 2 :: 8 A
	3000 K	735 lm		
19 W	2700 K	1320 lm	1205	0 50-1 2 1 4 :: 8 A
	3000 K	1470 lm		
38 W	2700 K	2630 lm	2405	0 50-1 2 1 8 :: 8 A
	3000 K	2940 lm		

Jewelery + Optical Store

Ludwigsburg, DE –

by Ippolito FleitzGroup – Identity Architects



← back

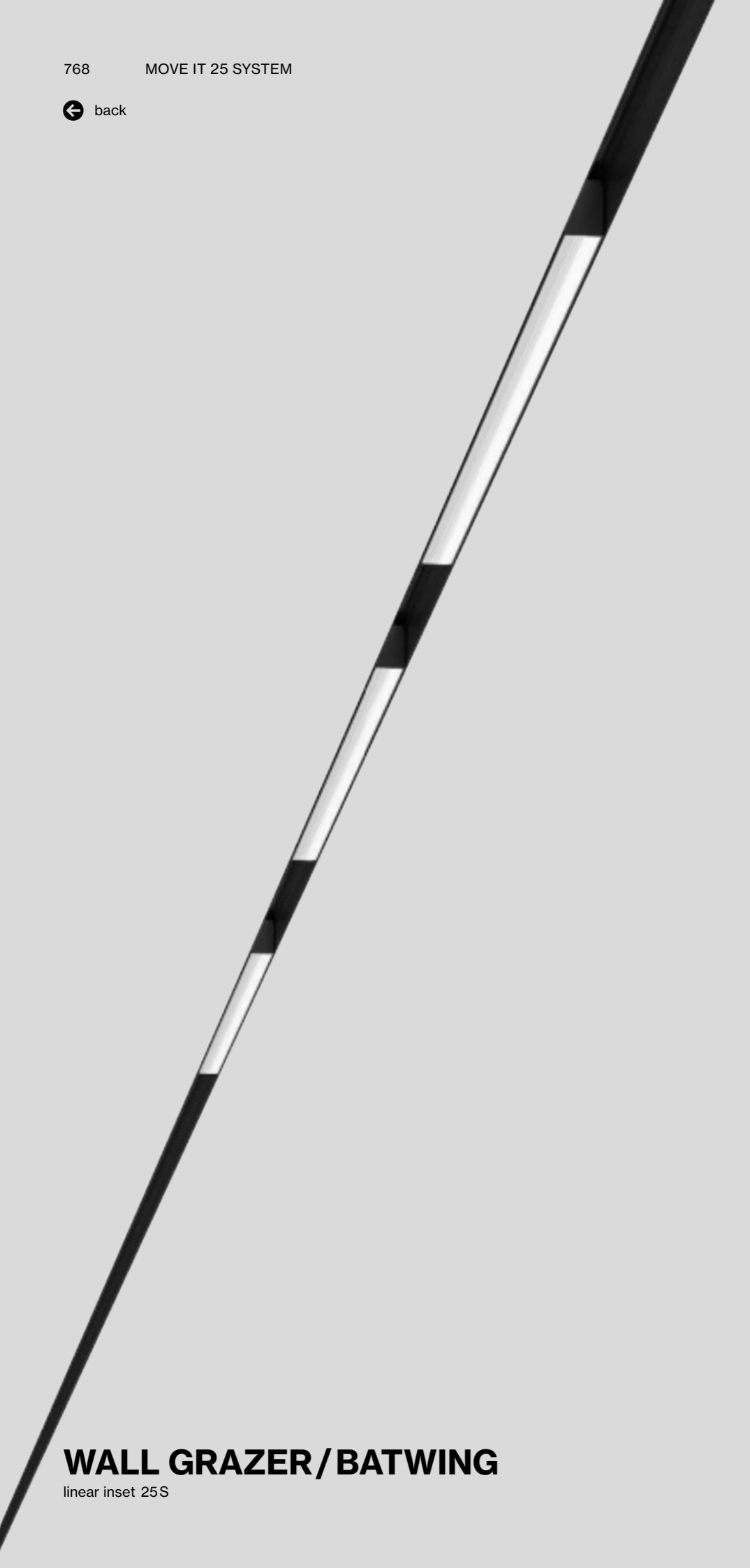

WALL GRAZER/BATWING

linear inset 25S

Quickinfo

2700 K, 3000 K
 CRI ≥ 90, 3 SDCM
 WALL GRAZER up to 127lm/W
 BATWING up to 124lm/W
 L80 @ 50 000h
 non DIM, DALI-2

Types

MOVE IT 25 S

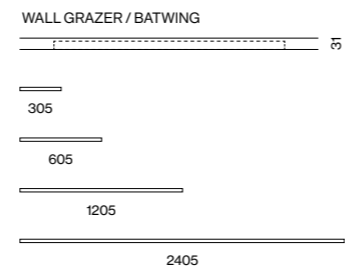

Light distributions



wall grazer bat wing

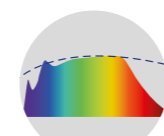

CRI ≥ 98
 XPECTRUM

Order options

COLOUR TEMPERATURE	
2700 K	4
3000 K	5

CONTROL	
non DIM	1
DALI-2	3

MATERIAL COLOUR	
● jet black RAL 9005	

Options on request

COLOUR RENDERING INDEX	
CRI ≥ 98 XPECTRUM	

COLOUR TEMPERATURE	
4000 K	

Light distributions

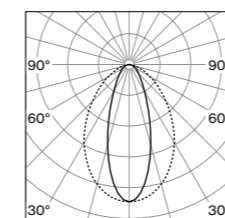

wall grazer

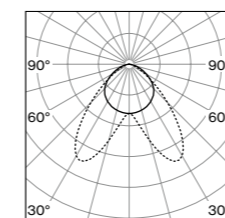

batwing

INSET POWER in watts is the current consumption excluding any ballast
LUMINOUS FLUX value calculated for CRI ≥ 90, colour black

LIGHT INSET 25 S					
WALL GRAZER					
INS. POWER	COLOUR TEMP.	LUM. FLUX	L (mm)	ORDER CODE	
5 W	2700 K	518 lm	305	0 5 0 - 1 2 1 1 :: ⇨ 8 S	
10 W	2700 K	1040 lm	605	0 5 0 - 1 2 1 2 :: ⇨ 8 S	
17 W	2700 K	2070 lm	1205	0 5 0 - 1 2 1 4 :: ⇨ 8 S	
35 W	2700 K	4150 lm	2405	0 5 0 - 1 2 1 8 :: ⇨ 8 S	
	3000 K	555 lm			
	3000 K	1110 lm			
	3000 K	2220 lm			
	3000 K	4440 lm			
BATWING					
INS. POWER	COLOUR TEMP.	LUM. FLUX	L (mm)	ORDER CODE	
5 W	2700 K	506 lm	305	0 5 0 - 1 2 1 1 :: ⇨ 8 B	
10 W	2700 K	1010 lm	605	0 5 0 - 1 2 1 2 :: ⇨ 8 B	
17 W	2700 K	2020 lm	1205	0 5 0 - 1 2 1 4 :: ⇨ 8 B	
35 W	2700 K	4040 lm	2405	0 5 0 - 1 2 1 8 :: ⇨ 8 B	
	3000 K	542 lm			
	3000 K	1080 lm			
	3000 K	2170 lm			
	3000 K	4330 lm			

**Dental Practice Coornaert -
Tandartscentrum Atlas**
Kortrijk, BE – by Maison Jane

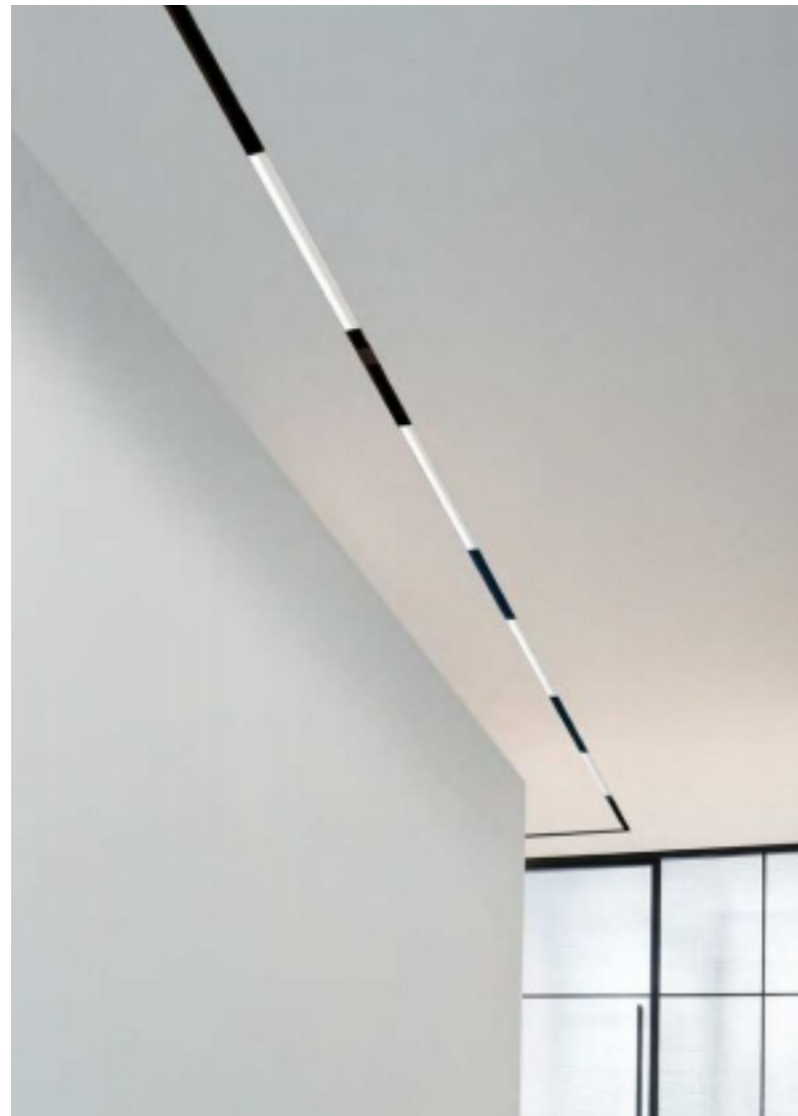

← back

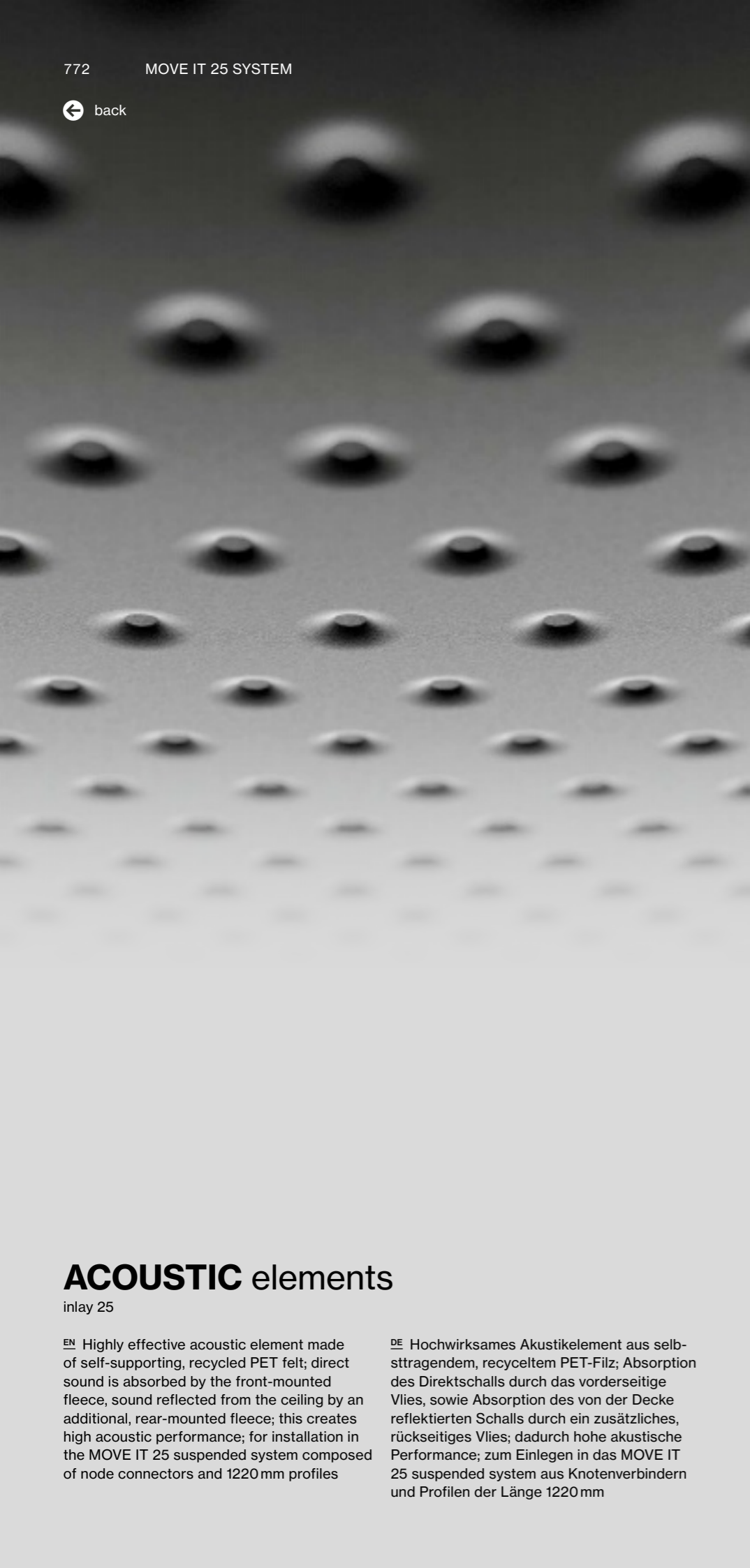

Quickinfo

PET felt
 ♻️ from recycled material
 up to absorption class A

Types

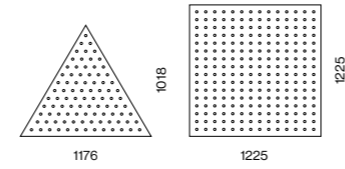

Colours



Order options

MATERIAL COLOUR
 ○ white W
 ● black L

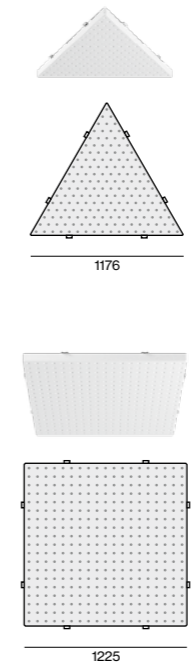

MOVE IT 25 suspended

MOVE IT ACOUSTIC TRIANGLE

TYPE	L-W-H (mm)	ORDER CODE
1200 inlay MOVE IT system*	1176-1018-57	050-230122 <input checked="" type="checkbox"/>

*NODE connector + track 1220mm

MOVE IT ACOUSTIC SQUARE

TYPE	L-W-H (mm)	ORDER CODE
1200 inlay MOVE IT system*	1225-1225-57	050-230222 <input checked="" type="checkbox"/>

*NODE connector + track 1220mm

ACOUSTIC EXAMPLES

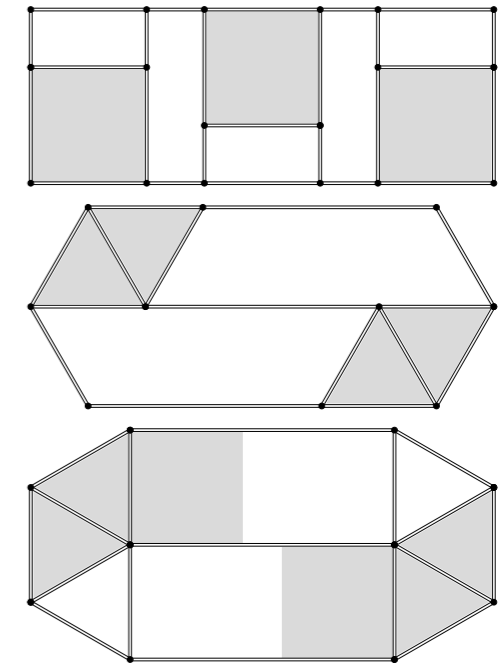

ACOUSTIC elements

inlay 25

EN Highly effective acoustic element made of self-supporting, recycled PET felt; direct sound is absorbed by the front-mounted fleece, sound reflected from the ceiling by an additional, rear-mounted fleece; this creates high acoustic performance; for installation in the MOVE IT 25 suspended system composed of node connectors and 1220 mm profiles

DE Hochwirksames Akustikelement aus selbsttragendem, recyceltem PET-Filz; Absorption des Direktschalls durch das vorderseitige Vlies, sowie Absorption des von der Decke reflektierten Schalls durch ein zusätzliches, rückseitiges Vlies; dadurch hohe akustische Performance; zum Einlegen in das MOVE IT 25 suspended system aus Knotenverbindern und Profilen der Länge 1220 mm

has-to-be gmbH
Radstadt, AT

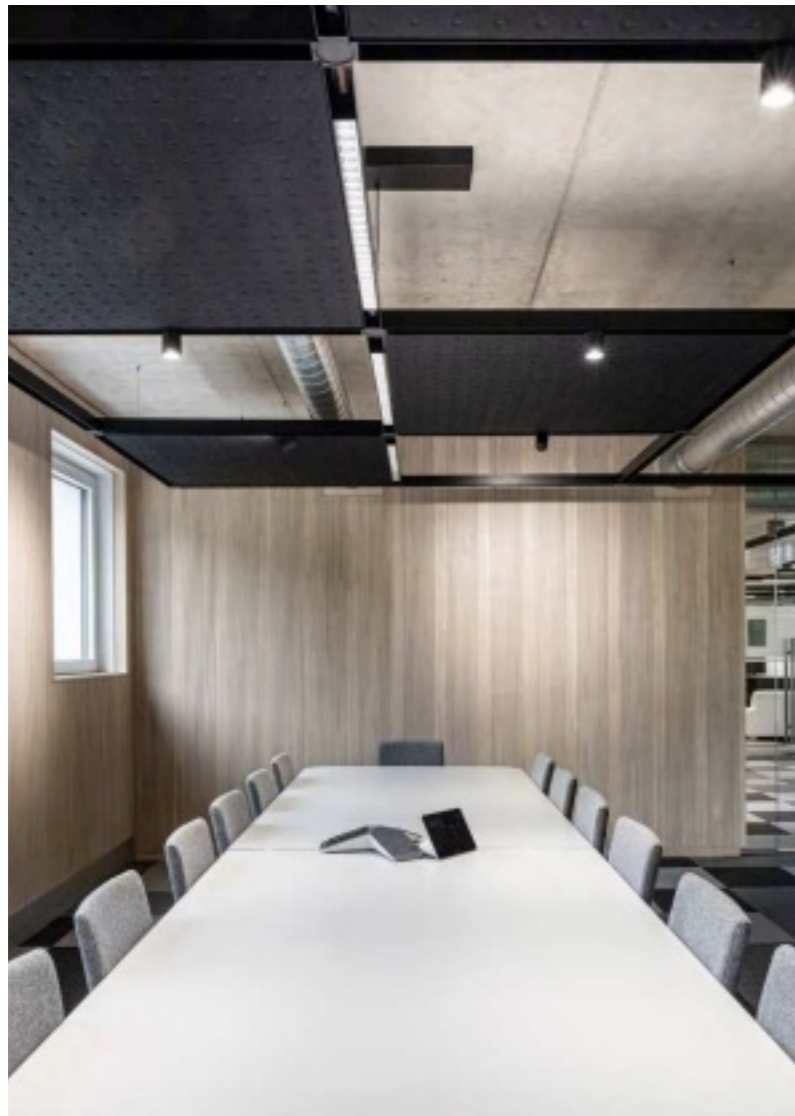

FlexOffice, Messeturm Basel
Basel, CH



Office on track

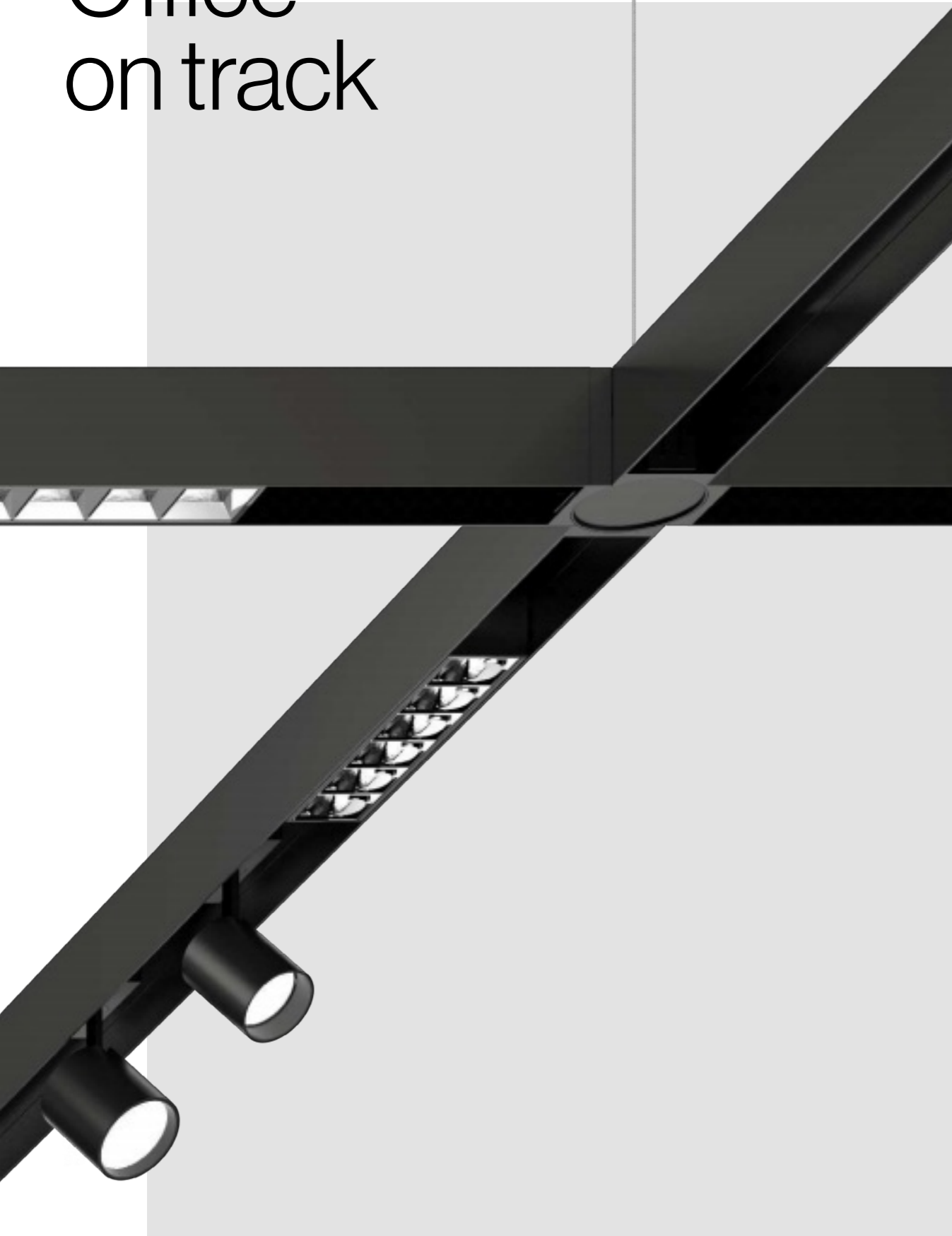

MOVE IT 45 system

EN MOVE IT 45 offers glare-free office lighting with the flexibility of a track system. It is available as a suspended version, or as a recessed or surface-mounted variant for wall or ceiling mounting. Indirect light for homogeneous ceiling illumination is available as an option. The profiles are connected using corner elements or NODE connectors. Spotlights, linear office insets, and decorative luminaires are installed in the system without tools and can be flexibly adapted to changes in the room. With just one track system and the appropriate insets, completely different areas in the office – such as workstations, meeting rooms, and corridors – can be individually illuminated and controlled. Square acoustic elements that can be optionally integrated additionally create balanced room acoustics.

DE Blendfreie Office-Beleuchtung, flexibles Schienensystem: MOVE IT 45 ist sowohl als Einbau- oder Anbauvariante für Wand- bzw. Deckenmontage als auch abgehängt verfügbar – wahlweise mit Indirektlichtanteil für eine homogene Deckenaufhellung. Die Profile werden mittels Eckelementen oder NODE Connectoren verbunden. Strahler, lineare Office-Einsätze und dekorative Leuchten lassen sich im System werkzeuglos montieren und flexibel an räumliche Veränderungen anpassen. Mit nur einem Schienensystem und den passenden Einsätzen können so unterschiedliche Bereiche im Büro – wie Arbeitsplätze, Besprechungsräume und Gänge – individuell beleuchtet und gesteuert werden. Optional integrierbare, quadratische Akustik-elemente erzeugen zusätzlich eine ausgewogene Raumakustik.

Type



45

Mountings

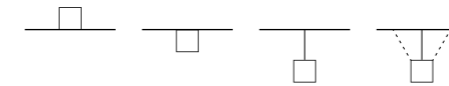
trimless
recessed

ceiling

suspended

indirect
suspended

Configurations

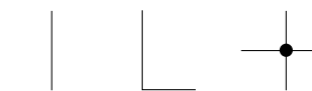

linear

corner

node

Light distributions

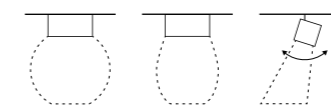

opal

reflector
(UGR ≤ 19)

spotlight

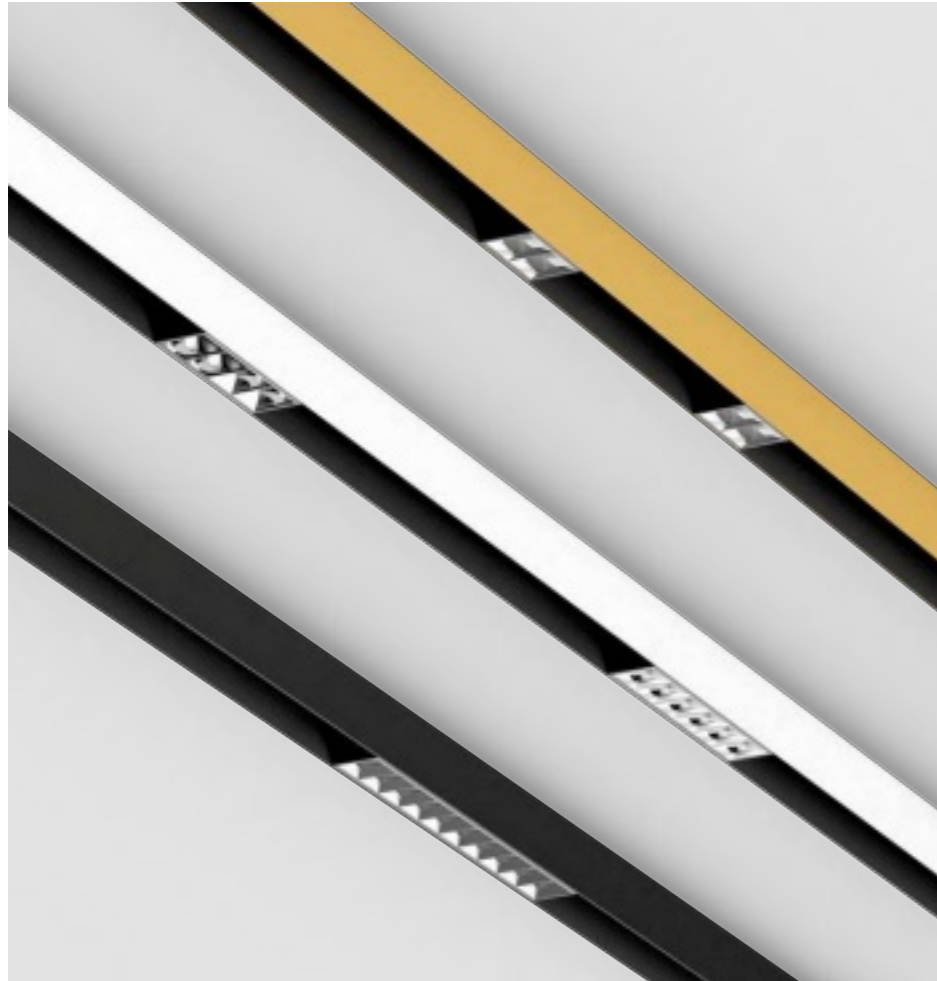

Colour variety

EN MOVE IT profiles are available in various standard colours. Further colour variations are also available, granting your project maximum design freedom. You can learn more about our colour palette at xal.com/colours.

DE MOVE IT Profile sind in den Standardfarben Schwarz, Weiß und Gold erhältlich. Darüber hinaus stehen weitere Farbvarianten zur Verfügung – dies ermöglicht Ihnen einen maximalen Gestaltungsfreiraum bei Ihrem Projekt. Mehr zu unserer Farbpalette erfahren Sie auf xal.com/colours.



xal.com/colours

Individual grids & room acoustics

EN The NODE Connector lets you create different ceiling patterns from up to four MOVE IT 45 profiles per node. Create attractive geometric shapes by connecting the profiles at a 90° angle. Special corner connectors that are rotated 35° to the left and right provide even more design freedom. Simply extend the MOVE IT Suspended System with square acoustic elements for optimised room acoustics.

DE Mit dem NODE Connector kreieren Sie unterschiedliche Deckenmuster aus bis zu vier MOVE IT 45 Profilen je Knotenpunkt. Indem Sie die Profile im 90° Winkel verbinden, entstehen ansprechende geometrische Formen. Für noch mehr Gestaltungsfreiraum sorgen spezielle Eckverbinder, die um 35° nach links und rechts gedreht werden können. Für die zusätzliche Optimierung der Raumakustik kann das MOVE IT Suspended System einfach um quadratische Akustikelemente erweitert werden.

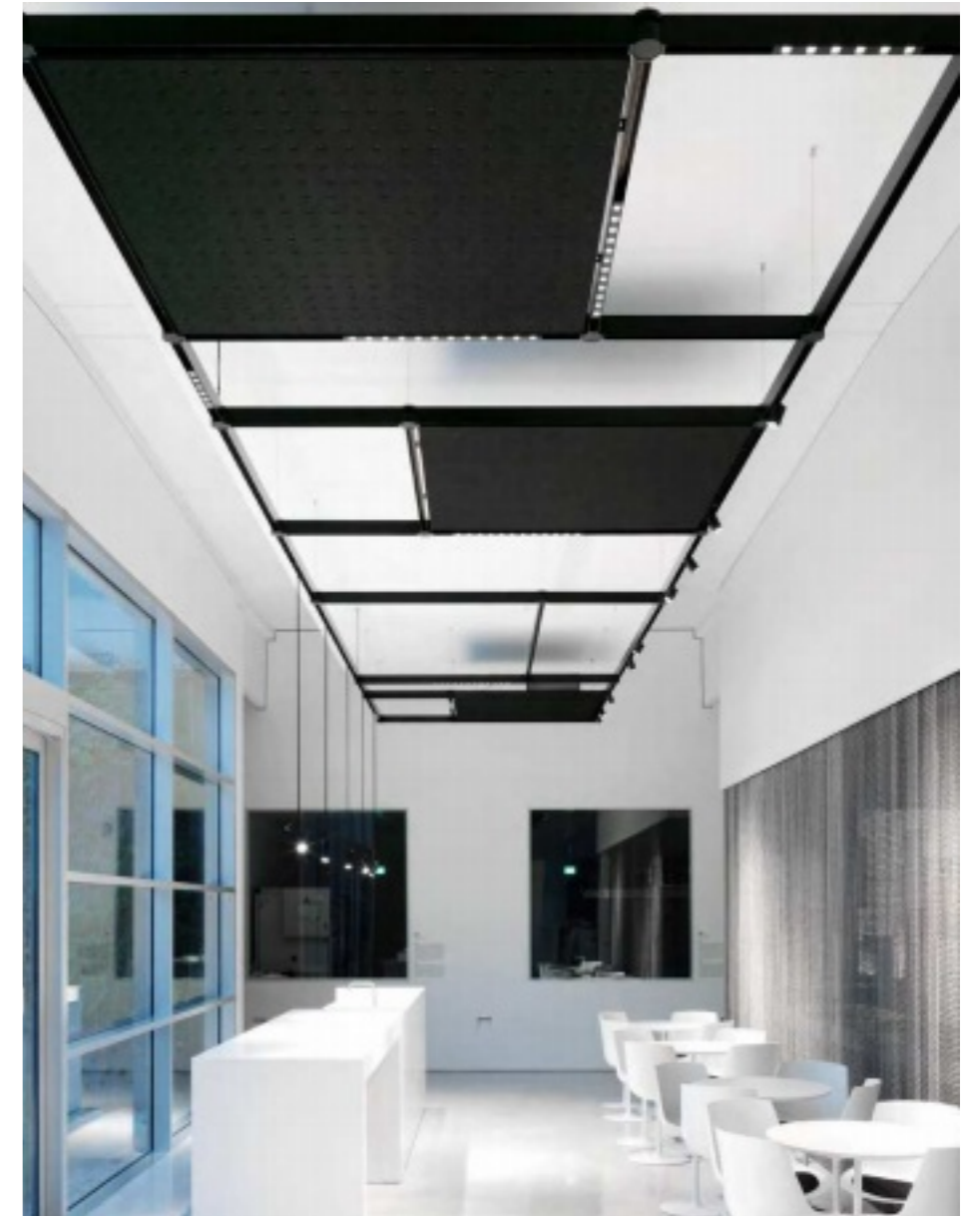

Mounting options

EN The elegant MOVE IT 45 System offers a wide variety of installation options: as a trimless recessed or surface-mounted variant for wall or ceiling mounting and suspended. The suspended direct/indirect variant provides additional homogeneous ceiling illumination.

DE Das elegante MOVE IT 45 System bietet eine große Vielfalt an Montagemöglichkeiten: Als randlose Ein- und Anbauvariante für Wand- oder Deckenmontage. Die abgehängte direkt/indirekt Variante sorgt für eine zusätzliche homogene Deckenaufhellung.

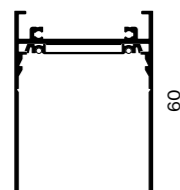

45

XPECTRUM LED

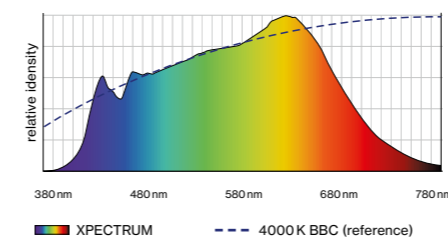

Commercially available LED 4000K

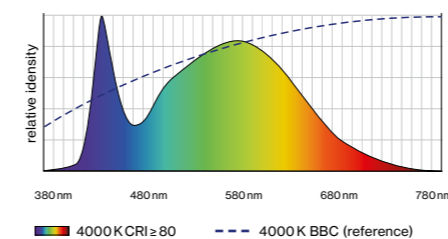

Full-spectrum LED

EN XAL's new XPECTRUM LEDs deliver healthy, biologically effective light. The reduced blue light and increased cyan values reduce the blue light hazard for the eye to daylight-equivalent levels. The resulting non-visual, so-called melanopic light effect, improves concentration and increases sleep quality. The excellent colour rendering of IES TM 30-15 $R_i = 98$ and $R_g = 101$ further helps visual comfort. These LEDs are available for different MOVE IT System insets and indirect insets.

DE Die neue XPECTRUM LED von XAL sorgt für gesundes, biologisch wirksames Licht. Der reduzierte Blaulichtanteil sowie die erhöhten Cyan-Werte minimieren die Blaulichtgefahr für das Auge auf ein tageslichtähnliches Niveau. Die daraus resultierende nichtvisuelle, auch melanopische Lichtwirkung genannt, fördert die Konzentration und steigert die Schlafqualität. Die hervorragende Farbwiedergabe von IES TM 30-15 $R_i = 98$ und $R_g = 101$ ermöglicht zudem einen verbesserten Sehkomfort. Diese LED steht Ihnen für verschiedene Insets sowie Indirektlichteinsätze von MOVE IT System zur Verfügung.

Variety of office reflector insets

EN Office lighting faces various requirements, ranging from standards for workplace lighting ($UGR \leq 19$), homogeneous basic illumination, to spot accentuation. Changing the design or use of office space also requires a flexible lighting solution. MOVE IT 45 responds to this with a wide range of lighting insets that are easily installed and replaced in the track system.

DE Office-Beleuchtung steht vor unterschiedlichen Anforderungen: von der genormten Arbeitsplatzbeleuchtung ($UGR \leq 19$), über die homogene Grundausleuchtung, bis hin zur Spot-Akzentuierung. Auch die veränderliche Gestaltung oder Nutzung von Büroräumen erfordert eine flexible Lichtlösung. Darauf antwortet MOVE IT 45 mit vielfältigen Lichteinsätzen, die sich unkompliziert im Schienensystem montieren und austauschen lassen.



Control options

EN MOVE IT Insets are available with DALI-2 and can be controlled individually. Configuration and control are simply done via DALI. As the open DALI communication standard is fully supported, all compatible luminaires can be easily integrated into the system. The Wireless-to-DALI Inset enables wireless control of DALI luminaire systems by using a communication module.

DE MOVE IT Insets sind mit DALI-2 verfügbar und einzeln ansteuerbar. Konfiguration und Steuerung erfolgt einfach über DALI. Da der offene Kommunikationsstandard DALI vollständig unterstützt wird, lassen sich damit alle kompatiblen Leuchten unkompliziert in das System integrieren. Das Wireless to DALI Inset ermöglicht die kabellose Ansteuerung von DALI Leuchtensystemen durch Einsatz eines Kommunikationsmoduls.

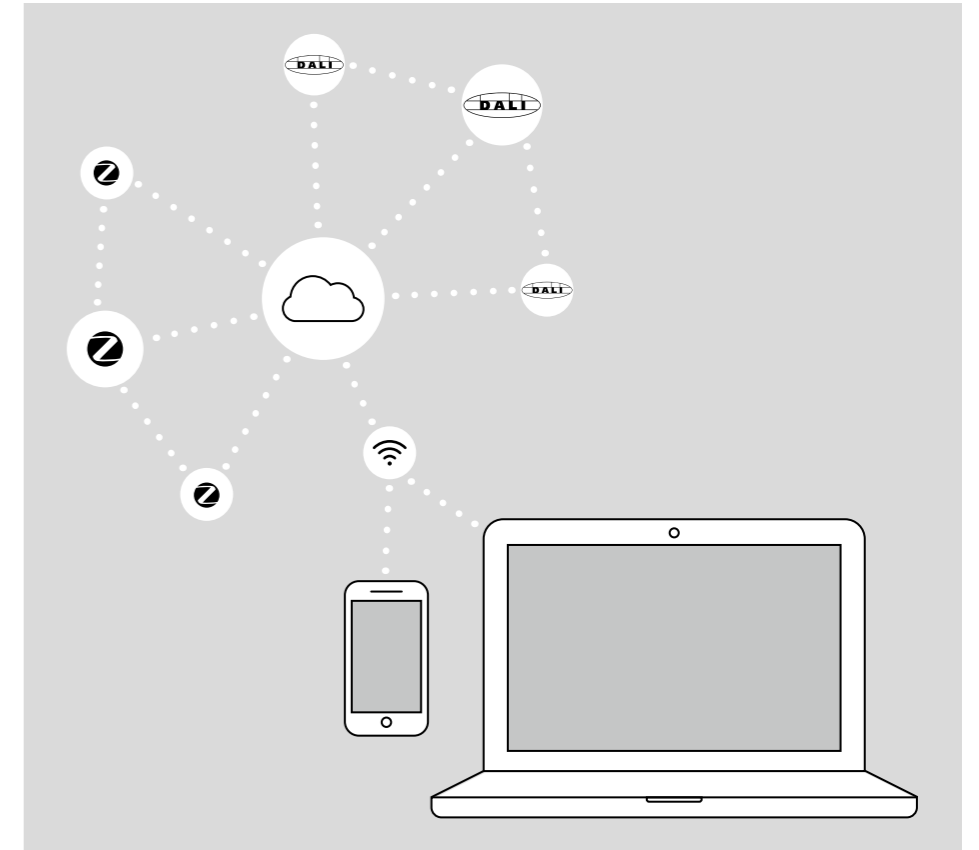

Light optics

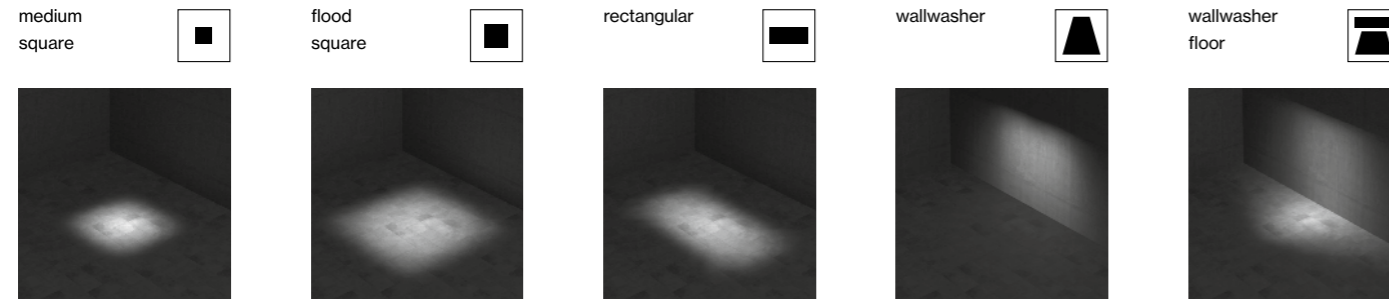

Inset variety

L1 Applications



L2 Applications



L24 OFFICE $UGR \leq 19$



L4 Applications



L6 Applications



L10 OFFICE $UGR \leq 19$



OPAL



IoT ready

EN IoT ready refers to the possibility of equipping luminaires with smart sensor technology. You receive valuable information, such as your lighting system's energy consumption or your rooms' utilisation over the day. You can set shut-off delay times and brightness values or plan time-controlled light sequences. The sensor is magnetically inserted into the track system like a spotlight and can be individually configured without restriction by existing standards.

DE IoT ready bezeichnet die Möglichkeit, Leuchten mit smarter Sensorik auszustatten. Auf diesem Weg erhalten Sie wertvolle Informationen, wie den Energieverbrauch Ihrer Beleuchtungsanlage oder die Auslastung Ihrer Räume über den Tagesverlauf. Sie können zudem Nachlaufzeiten und Helligkeitswerte einstellen oder zeitgesteuerte Lichtverläufe planen. Der Sensor wird wie ein Strahler magnetisch in das Schienensystem eingesetzt und ist individuell konfigurierbar – ohne Einschränkung durch bestehende Standards.

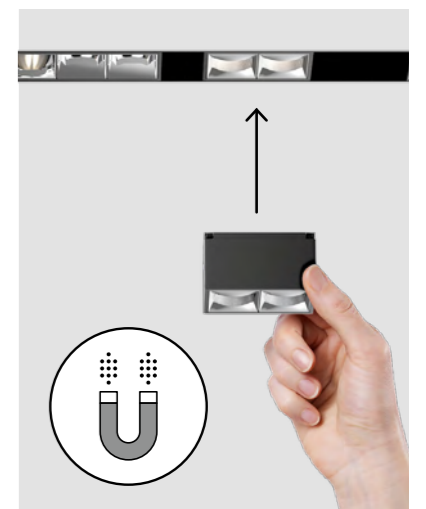
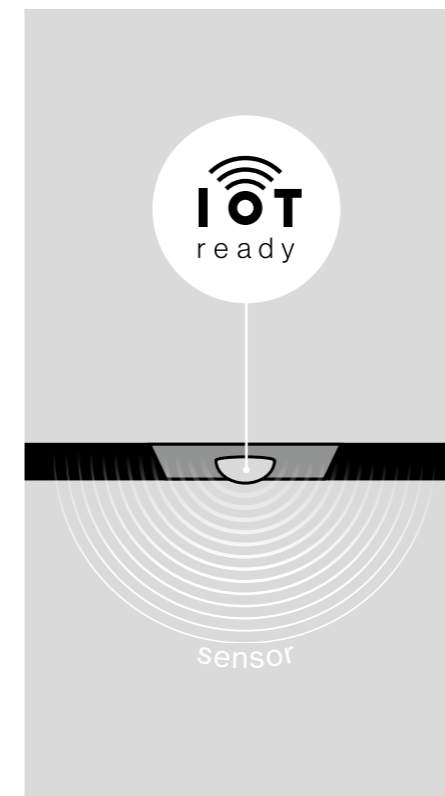

Magnetic attachment

EN MOVE IT Insets are mounted without tools and magnetically fixed within the profile. They can, therefore, be adjusted and adapted according to the lighting requirements with just one movement.

DE MOVE IT Insets werden werkzeuglos montiert und innerhalb des Profils magnetisch fixiert. So lassen sie sich mit nur einem Handgriff beliebig verstellen und anpassen – je nach Anforderung an die Beleuchtung.



MOVE IT 45 system

trimless / surface / suspended

EN Extruded aluminium profile with 45 mm width groove; for trimless installation in plasterboard ceilings (wall or ceiling mounting) with 12.5 mm ceiling thickness; or for wall-/ceiling surface mounting or suspended mounting (cable suspension, height adjustment without tools, incl. black feed); optional with indirect light component for additional accentuation of the ceiling; for lighting systems, 90° angle connectors for flexible system design; node connectors, up to 4 profile connection options; with power track profile for take off of supply voltage and DALI signal; surf. anod. or powder coated; insets can be installed flexibly and without tools by means of magnetic holders + locking; sound absorbing accessories available

DE Aluminiumstrangpressprofil mit 45 mm Fugenbreite; für randlosen Einbau in Gipskartondecken (Wand- oder Deckenmontage) mit 12,5 mm Deckenstärke; oder für Wand-/Deckenanbaumontage oder für abgehängte Montage (Seilabhängung, werkzeuglose Höhenverstellung, inkl. schwarzer Einspeiseleitung); optional mit indirekter Lichtkomponente für zusätzliche Akzentuierung der Decke; für Lichtsysteme, 90° Winkelverbinder für flexiblen Systemaufbau; Knotenverbinder, bis zu 4 Profilanschlussmöglichkeiten; mit Stromschienenprofil für Abnahme von Versorgungsspannung und DALI Signal; Oberfl. elox. bzw. pulverbeschichtet; flexible und werkzeuglose Montage der Einsätze durch Magnethalterung + Verriegelung; schallabsorbierendes Zubehör erhältlich

Quickinfo

3000K
CRI ≥ 90, 2 SDCM
up to 117 lm/W
L80 @ 50 000 h
non DIM, DALI-2

Types

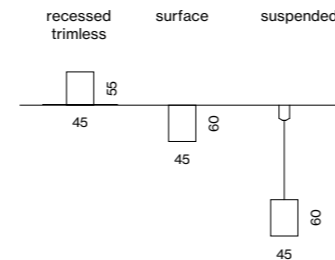

connectors

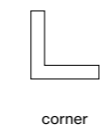
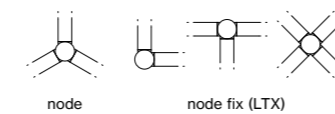

Colours



Order options

CONTROL	
non DIM	1
DALI-2	3

MATERIAL COLOUR

● jet black RAL 9005

Options on request

CONNECTOR

T-connector

X-connector

INSTALLATION TRACK

acoustic soft ceilings



MOVE IT 45 trimless



INSTALLATION TRACK

L (mm)		ORDER CODE
617	channel	050-72320-8
1217	channel	050-72340-8
2417	channel	050-72380-8
3622	channel	050-72390-8
692x648	channel corner* 90°	050-72310-8
661x661	channel corner* ceiling to wall 90°	050-72311-8

*incl. electrical connector set

Accessories

END CAPS

TYPE	ORDER CODE
end caps (pair)	050-72300-8

BLIND COVER

L (mm)	ORDER CODE
1217	050-70340-8
2417	050-70380-8
3622	050-70390-8

blind cover can be shortened as desired

CONNECTOR SET

TYPE	ORDER CODE
linear connector (non DIM, DALI-2)	050-20311-30
linear connector flexible	050-20321-0
mechanical linear connector (pair)	050-20111-10

POWER FEEDER UNIT

TYPE	ORDER CODE
non DIM 2 × 2,5 mm ²	050-20201-10
DALI-2 2 × 2,5 + 2 × 0,5 mm ²	050-20201-30

cable length 500 mm

Electrical accessories

see page 788



custom cut on building site



acoustic elements (p. 806)

← back

Order options

CONTROL	
non DIM	1
DALI-2	3

MATERIAL COLOUR
INSTALLATION TRACK

● jet black RAL 9005	8
● traffic white 9016 / jet black 9005 P	
● gold dust 260-M / jet black 9005 G	
● special colours* p.335	X

*inside always in black

MATERIAL COLOUR
NODE CONNECTOR

○ traffic white RAL 9016	7
● jet black RAL 9005	8
● special colours* p.992	X

MATERIAL COLOUR
NODE LTX / END CAP

● jet black RAL 9005	8
● traffic white 9016 / jet black 9005 P	
● special colours* p.992	X

MATERIAL COLOUR
ACCESSORIES

○ traffic white RAL 9016	7
● jet black RAL 9005	8

NODE CONNECTOR
MOUNTING TYPE

surface*	1
1500 mm cable susp. chrome	3
1500 mm cable susp. black	4

*only for L/T/X

MATERIAL COLOUR
CABLE SUSPENSION

chrome	0
black	8



MOVE IT 45 surface/suspended

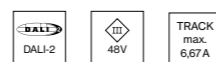

INSTALLATION TRACK

L (mm)		ORDER CODE
620	channel	050-73320
1220	channel	050-73340
2420	channel	050-73380
3625	channel	050-73390
653x609	channel corner* 90°	050-73310
661x661	channel corner* ceiling to wall 90°	050-73311

*incl. electrical connector set

Accessories

END CAPS

TYPE		ORDER CODE
end caps (pair)		050-733000



BLIND COVER

L (mm)	ORDER CODE
1217	050-7034008
2417	050-7038008
3622	050-7039008

blind cover can be shortened as desired

FLEX NODE CONNECTOR

TYPE	ORDER CODE
FLEX NODE surface mounted	050-203333
FLEX NODE surface mounted incl. feeder	050-202243
FLEX NODE cable suspension 1500 mm	050-20331
FLEX NODE cable susp. 1500 mm incl. feeder	050-20222
NODE end cap* incl. electrical connector	050-733010

*order for every node connection (channel to node) 1 end cap

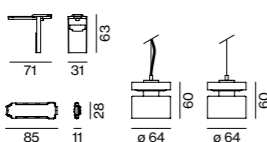

FIX NODE CONNECTOR

TYPE	ORDER CODE
L NODE incl. end cap & electrical connector	050-73354
T NODE incl. end cap & electrical connector	050-73352
X NODE incl. end cap & electrical connector	050-73353

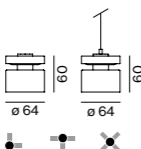

CONNECTOR SET

TYPE	ORDER CODE
mechanical linear conn. incl. 1500 mm cable susp.	050-201131
mechanical linear connector surface	050-2011210
mechanical & electrical linear connector	050-2031230
mechanical & electrical corner connector flex	050-2032238

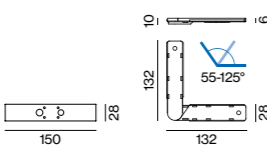

POWER FEEDER UNIT

TYPE	ORDER CODE
non DIM 2x2,5mm ²	050-2020110
DALI-2 2x2,5 + 2x0,5mm ²	050-2020130

cable length 2000 mm

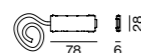

CEILING FASTENER / CABLE SUSPENSION / CANOPY

TYPE	L (mm)	ORDER CODE
ceiling fastener	10	050-204121
cable suspension*	1500	005-215211
canopy		005-231121

*use every 1200 mm

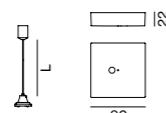

Electrical accessories

see page 788

Acoustic elements

see page 806

Order options

COLOUR TEMPERATURE
3000K

CONTROL	
non DIM	1
DALI-2	3

MATERIAL COLOUR
INSTALLATION TRACK

● jet black RAL 9005	8
● traffic white 9016 / jet black 9005 P	
● gold dust 260-M / jet black 9005 G	
● special colours* p.992	X

*inside always in black

MATERIAL COLOUR
NODE CONNECTOR

○ traffic white RAL 9016	7
● jet black RAL 9005	8
● special colours* p.992	X

MATERIAL COLOUR
NODE LTX / END CAP

● jet black RAL 9005	8
● traffic white 9016 / jet black 9005 P	
● special colours* p.992	X

MATERIAL COLOUR
ACCESSORIES

○ traffic white RAL 9016	7
● jet black RAL 9005	8

NODE CONNECTOR
MOUNTING TYPE

surface*	1
1500 mm cable susp. chrome	3
1500 mm cable susp. black	4

*only for L/T/X

MATERIAL COLOUR
CABLE SUSPENSION

chrome	0
black	8

Options on request

COLOUR RENDERING INDEX
CRI ≥ 98 XPECTRUM

COLOUR TEMPERATURE
2700K
4000K
tunable white 2700–6500 K*

*DALI-2 DT8

LUMINOUS FLUX value calculated for 3000K, CRI ≥ 90, colour white/black



MOVE IT 45 suspended indirect



INSTALLATION TRACK INDIRECT

L (mm)	SYSTEM POWER	LUMINOUS FLUX	ORDER CODE
620	6.2W	638lm	050-74325
1220	15W	1790lm	050-74345
2420	33W	3830lm	050-74385
3625	50W	5745lm	050-74395
653x609	13W	1420lm	050-74310

corner* no custom cut on building side; *incl. electrical connector set

Accessories

END CAPS

TYPE	ORDER CODE
end caps (pair)	050-733000



BLIND COVER

L (mm)	ORDER CODE
1217	050-7034008
2417	050-7038008
3622	050-7039008

blind cover can be shortened as desired

FLEX NODE CONNECTOR

TYPE	ORDER CODE
FLEX NODE cable suspension 1500 mm	050-20331
FLEX NODE cable susp. 1500 mm incl. feeder	050-20222
NODE end cap* incl. electrical connector	050-733010

*order for every node connection (channel to node) 1 end cap

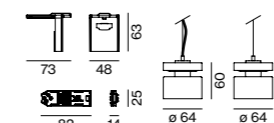

FIX NODE CONNECTOR

TYPE	ORDER CODE
L NODE incl. end cap & electrical connector	050-73354
T NODE incl. end cap & electrical connector	050-73352
X NODE incl. end cap & electrical connector	050-73353

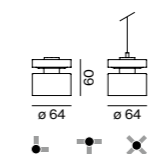

CONNECTOR SET

TYPE	ORDER CODE
mechanical linear conn. incl. 1500 mm cable susp.	050-201131
mechanical & electrical linear connector	050-2031230
mechanical & electrical corner connector flex	050-2032238

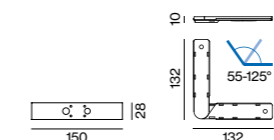

POWER FEEDER UNIT

TYPE	ORDER CODE
non DIM 2x2,5mm ²	050-2020110
DALI-2 2x2,5 + 2x0,5mm ²	050-2020130

cable length 2000 mm

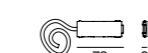

CABLE SUSPENSION / CANOPY

TYPE	L (mm)	ORDER CODE
cable suspension*	1500	005-215211
canopy		005-231121

*use every 1200 mm

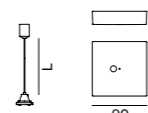

Electrical accessories

see page 788

Acoustic elements

see page 806

← back

Order options

CONTROL

non DIM	1
DALI-2	3

MATERIAL COLOUR

○ traffic white RAL 9016	7
● jet black RAL 9005	8



Electrical accessories

POWER SUPPLY INTRACK supply 220-240 V AC, 48 V, 50-60 Hz

TYPE	EFFICIENCY	MOUNTING	L-W-H (mm)	ORDER CODE
100W* <input type="checkbox"/>	η 92%	intrack	403-26-46	050-2071038
150W* <input type="checkbox"/>	η 92%	intrack	403-26-46	050-2071138

*ENEC approved, incl. feeder cable 2000 mm PC I PC II

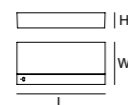

POWER SUPPLY SURFACE supply 220-240 V AC, 48 V, 50-60 Hz

TYPE	EFFICIENCY	MOUNTING	L-W-H (mm)	ORDER CODE
60W <input type="checkbox"/>	η 88%	surface	305-144-54	050-20551
100W <input type="checkbox"/>	η 92%	surface	455-104-40	050-20554
150W <input type="checkbox"/>	η 92%	surface	455-104-40	050-20552
250W <input type="checkbox"/>	η 93%	surface	455-104-40	050-20555
320W <input type="checkbox"/>	η 94%	surface	305-144-54	050-20553

*ENEC approved, incl. feeder cable 2000 mm PC I PC II

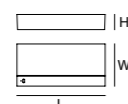

POWER SUPPLY EXTERNAL supply 220-240 V AC, 48 V, 50-60 Hz

TYPE	EFFICIENCY	MOUNTING	L-W-H (mm)	ORDER CODE
60W <input type="checkbox"/>	η 88%	external	163-43-32	002-62133
100W <input type="checkbox"/>	η 92%	external	350-30-18	002-62134
150W <input type="checkbox"/>	η 92%	external	350-30-18	002-62135
250W <input type="checkbox"/>	η 93%	external	400-40-22	002-62139
320W <input type="checkbox"/>	η 94%	external	252-90-44	002-60320

*ENEC approved, incl. feeder cable 2000 mm PC I PC II

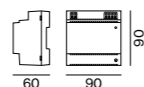

DIN RAIL POWER SUPPLY BASIC 48 V

220-240 V | 50-60 Hz | PC II | MTBF @ 55° ambient temperature

TYPE	EFFICIENCY / MTBF	W-H-D (mm)	ORDER CODE
96W <input type="checkbox"/>	η 89% / > 300.000h	90-90-60	005-6520010



DIN RAIL POWER SUPPLY PRO 48 V

220-240 V | 50-60 Hz | PC I | MTBF @ 55° ambient temperature
cascadable max. 5 devices (240 W) or 3 devices (480 W)

TYPE	EFFICIENCY / MTBF	W-H-D (mm)	ORDER CODE
240W <input type="checkbox"/>	η 92% / > 400.000h	60-125-100	005-6220110
480W <input type="checkbox"/>	η 93% / > 350.000h	120-125-100	005-6220210

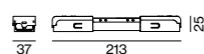

DALI-2 SELV DEVICE

TYPE	L-W-H (mm)	ORDER CODE
control unit	213-37-25	050-2061130

necessary to create DALI-2 SELV signal



DALI-2 SENSOR

TYPE	L-W-H (mm)	ORDER CODE
ESSENTIAL sensor (brightness & presence)	43-43-48	050-2063378
SENSE sensor (brightness, presence, temperature, sound pressure, humidity, CO ₂)	43-43-48	050-2063278



WIRELESS TO DALI-2 CONTROL DEVICE

TYPE	L-W-H (mm)	ORDER CODE
Zigbee 3.0	111-25-45	050-2065130
Casambi	111-25-45	050-2065230



WIRELESS TO DALI-2 REPEATER

TYPE	L-W-H (mm)	ORDER CODE
Zigbee 3.0	111-25-45	050-2066130
Casambi	111-25-45	050-2066230

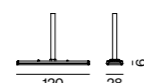

MIDDLE FEED

TYPE	ORDER CODE
non DIM 2x2,5mm ²	050-2038110
DALI-2 2x2,5 + 2x0,5mm ²	050-2038130



← back



LIGHT INSET 45

linear inset 45

Quickinfo

3000K, 4000K, TW
 CRI ≥ 90, 3 SDCM
 DALI-2

L85 @ 50 000 h
 opal / opal jut-out up to 99 lm/W
 microprism. (≤ 19) up to 88 lm/W
 microprism. (≤ 22) up to 78 lm/W

L80 @ 50 000 h
 UGR ≤ 19 / 65° ≤ 1500 cd/m²
 L1 up to 106 lm/W
 L2 up to 97 lm/W
 L4 up to 104 lm/W
 L6 up to 90 lm/W

L90 @ 50 000 h
 UGR ≤ 19 / 65° ≤ 1500 cd/m²
 L10 office up to 102 lm/W
 L24 office up to 120 lm/W

Types

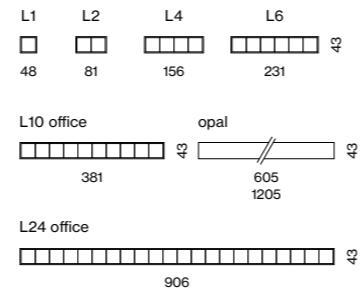

Colour



Light distributions

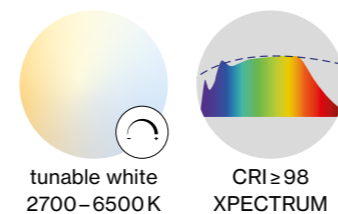

Order options

COLOUR TEMPERATURE	
3000K	5
4000K	6
tunable white 2700–6500 K*	D

*DALI-2 DT8

CONTROL

DALI-2

MATERIAL COLOUR

● jet black RAL 9005

Options on request

COLOUR RENDERING INDEX
 CRI ≥ 98 XPECTRUM

CONTROL

Zigbee 3.0

LIGHT INSET 45

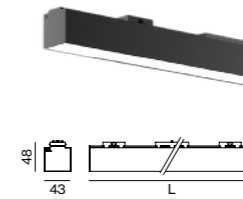

OPAL HIGH PERFORMANCE

INSET POWER	COLOUR TEMP.	LUM. FLUX	L (mm)	ORDER CODE
12W	3000K	1120lm	605	0 5 0 - 3 2 1 2 :: 38H
24W	3000K	2240lm	1205	0 5 0 - 3 2 1 4 :: 38H
	4000K	1190lm		
	4000K	2380lm		

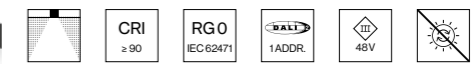
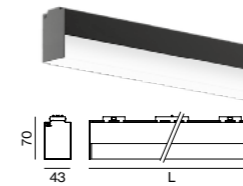

OPAL JUT-OUT

INSET POWER	COLOUR TEMP.	LUM. FLUX	L (mm)	ORDER CODE
12W	3000K	1120lm	605	0 5 0 - 3 2 1 2 :: 38J
24W	3000K	2240lm	1205	0 5 0 - 3 2 1 4 :: 38J
	4000K	1190lm		
	4000K	2380lm		

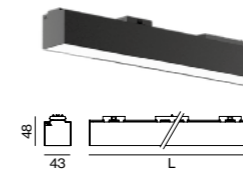

MICROPRISMATIC UGR ≤ 19

INSET POWER	COLOUR TEMP.	LUM. FLUX	L (mm)	ORDER CODE
9.9W	3000K	704lm	605	0 5 0 - 3 2 1 2 :: 38P
17W	3000K	1410lm	1205	0 5 0 - 3 2 1 4 :: 38P
	4000K	751lm		
	4000K	1500lm		

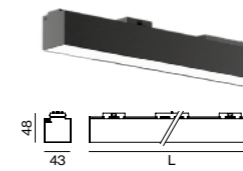

MICROPRISMATIC UGR ≤ 22

INSET POWER	COLOUR TEMP.	LUM. FLUX	L (mm)	ORDER CODE
23W	3000K	1640lm	605	0 5 0 - 3 2 4 2 :: 38P
45W	3000K	3280lm	1205	0 5 0 - 3 2 4 4 :: 38P
	4000K	1750lm		
	4000K	3500lm		

INSET POWER in watts is the current consumption excluding any ballast
 LUMINOUS FLUX value calculated for CRI ≥ 90, colour black

← back

Order options

COLOUR TEMPERATURE

3000K	5
4000K	6
tunable white 2700–6500K*	D

*DALI-2 DT8

CONTROL
DALI-2

LIGHT OPTIC

medium square (UGR≤10)	E
flood square (UGR≤19)	F

LIGHT OPTIC COLOUR

chrome reflector	0
black reflector*	B

*not available for spot round, narrow medium round and wallwasher

MATERIAL COLOUR
● jet black RAL 9005

Options on request

LIGHT OPTIC

spot round	
narrow medium round	
medium round (UGR≤19)	
medium square (UGR≤10)	
flood round (UGR≤19)	
flood square (UGR≤19)	
wide flood round	
wide flood square	
rectangular	
wallwasher	
wallwasher floor	

LIGHT OPTIC COLOUR

gold reflector	
----------------	--

Planning information

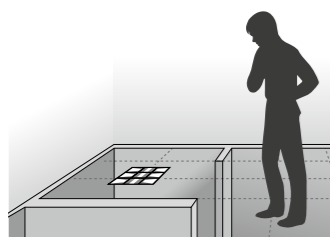

The icons of the light optics are shown in the reflected ceiling plan (RCP) view.

INSET POWER in watts is the current consumption excluding any ballast
LUMINOUS FLUX value calculated for CRI≥90, colour black, reflector chrome

L1 LIGHT INSET

UGR ≤10, cd/m² ≤1500, CRI ≥90, DALI 1ADDR, 48V

FLOOR

INSET POWER	COLOUR TEMP.	LUMINOUS FLUX	ORDER CODE
3.4 W	3000 K	up to 338 lm	0 90 - 9 L 1 :: 3 ▲ B ▣ 0 1
	4000 K	up to 361 lm	

choose one light optic ▲ from the options on the left depending on your room needs

L2 LIGHT INSET

CRI ≥90, DALI 1ADDR, 48V

WALL
2 × wallwasher

INSET POWER	COLOUR TEMP.	LUMINOUS FLUX	ORDER CODE
6.9 W	3000 K	590 lm	0 90 - 9 L 2 :: 3 A B 0 0 1
	4000 K	633 lm	

WALL FLOOR
2 × wallwasher floor

INSET POWER	COLOUR TEMP.	LUMINOUS FLUX	ORDER CODE
6.9 W	3000 K	620 lm	0 90 - 9 L 2 :: 3 ▲ B ▣ 0 1
	4000 K	662 lm	

CORRIDOR
2 × rectangular

INSET POWER	COLOUR TEMP.	LUMINOUS FLUX	ORDER CODE
6.9 W	3000 K	624 lm	0 90 - 9 L 2 :: 3 R B ▣ 0 1
	4000 K	667 lm	

L4 LIGHT INSET

UGR ≤10, CRI ≥90, cd/m² ≤1500, DALI 1ADDR, 48V

FLOOR/CORRIDOR

INSET POWER	COLOUR TEMP.	LUMINOUS FLUX	ORDER CODE
14 W	3000 K	up to 1350 lm	0 90 - 9 L 4 :: 3 ▲ B ▣ 0 1
	4000 K	up to 1450 lm	

choose one light optic ▲ from the options on the left depending on your room needs

WALL
4 × wallwasher

INSET POWER	COLOUR TEMP.	LUMINOUS FLUX	ORDER CODE
14 W	3000 K	1180 lm	0 90 - 9 L 4 :: 3 A B 0 0 1
	4000 K	1270 lm	

WALL
2 × wallwasher 180° + 2 × wallwasher

INSET POWER	COLOUR TEMP.	LUMINOUS FLUX	ORDER CODE
14 W	3000 K	1180 lm	0 90 - 9 L 4 :: 3 A B 0 0 2
	4000 K	1270 lm	

WALL FLOOR
4 × wallwasher floor

INSET POWER	COLOUR TEMP.	LUMINOUS FLUX	ORDER CODE
14 W	3000 K	1240 lm	0 90 - 9 L 4 :: 3 W B ▣ 0 1
	4000 K	1320 lm	

WALL FLOOR
2 × wallwasher floor 180° + 2 × wallwasher floor

INSET POWER	COLOUR TEMP.	LUMINOUS FLUX	ORDER CODE
14 W	3000 K	1240 lm	0 90 - 9 L 4 :: 3 W B ▣ 0 2
	4000 K	1320 lm	

Order options

COLOUR TEMPERATURE

3000K	5
4000K	6
tunable white 2700–6500K*	D

*DALI-2 DT8

CONTROL
DALI-2

LIGHT OPTIC COLOUR

chrome reflector	0
black reflector*	B

*not available for spot round, narrow medium round and wallwasher

MATERIAL COLOUR
● jet black RAL 9005

Options on request

COLOUR RENDERING INDEX
CRI ≥98 XPECTRUM*

*only for L24 light inset

LIGHT OPTIC

spot round	
narrow medium round	
medium round (UGR≤19)	
medium square (UGR≤10)	
flood round (UGR≤19)	
flood square (UGR≤19)	
wide flood round	
wide flood square	
rectangular	
wallwasher	
wallwasher floor	

LIGHT OPTIC COLOUR
gold reflector

INSET POWER in watts is the current consumption excluding any ballast
LUMINOUS FLUX value calculated for CRI≥90, colour black, reflector chrome

L6 LIGHT INSET

CRI ≥90, DALI 1ADDR, 48V

WALL
6 × wallwasher

INSET POWER	COLOUR TEMP.	LUMINOUS FLUX	ORDER CODE
21 W	3000 K	1780 lm	0 90 - 9 L 6 :: 3 A B 0 0 1
	4000 K	1900 lm	

L10 LIGHT INSET

UGR ≤19, cd/m² ≤1500, CRI ≥90, DALI 1ADDR, 48V, pending, CB pending

OFFICE UGR≤19
10 × medium square

INSET POWER	COLOUR TEMP.	LUMINOUS FLUX	ORDER CODE
30 W	3000 K	2840 lm	0 50 - 3 2 1 1 :: 3 8 ▣ R
	4000 K	3060 lm	

L24 LIGHT INSET

UGR ≤19, cd/m² ≤1500, CRI ≥90, DALI 1ADDR, 48V

OFFICE UGR≤19
24 × medium square

INSET POWER	COLOUR TEMP.	LUMINOUS FLUX	ORDER CODE
21 W	3000 K	2350 lm	0 50 - 3 2 1 3 :: 3 8 R
	4000 K	2510 lm	

SENABStockholm, SE –
by SENAB

Tribünen der Trabrennbahn
Vienna, AT



Press Glass Headquarters
Konopiska, PL – by Konior Studio,
Tomasz Konior



Langzauner GmbH Ried im Innkreis, AT –
by Architektur Mugrauer ZT GmbH with
lighting design by planbox Interior Design GmbH

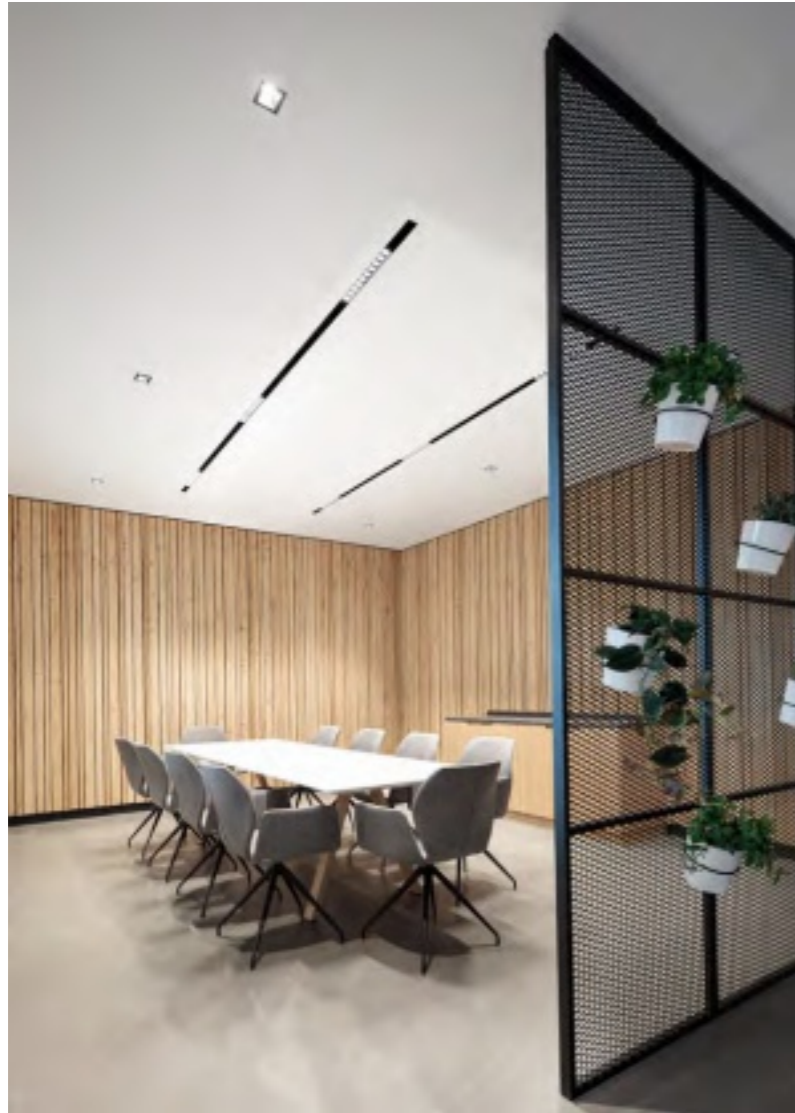

← back



JUST 45/55

spotlight inset 45

Quickinfo

2700K, 3000K, 4000K, CWD, TW
CRI ≥ 90, 2 SDCM

non DIM, DALI-2

L80 @ 50 000h
JUST 45 up to 72lm/W

L90 @ 50 000h
JUST 55 up to 75lm/W

Types

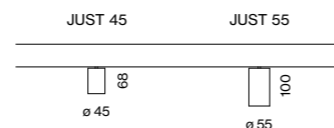

Colours



Light distributions

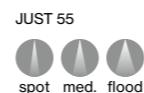
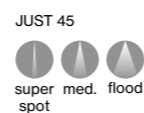

ARY rod
p.734

ARY shade
p.736



TULA
p.742

PAL
p.748

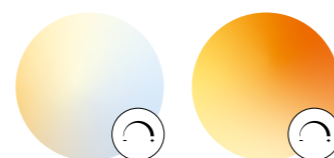

TW 1800-3000K
or 2700-6500K

CWD
2000-3000K

Order options

COLOUR TEMPERATURE	
2700K	4
3000K	5
4000K	6
colour warm dim. 2000-3000K*	
tunable white 1800-3000K**	
tunable white 2700-6500K**	

*DALI-2 **DALI-2 DT8

CONTROL	
non DIM	1
DALI-2	3

MATERIAL COLOUR	
○ traffic white RAL 9016	7
● jet black RAL 9005	8
● special colours p.992	X

BEAM ANGLE JUST 45	
medium 23°	M
flood 44°	F

BEAM ANGLE JUST 55	
spot 16°	S
medium 28°	M
flood 37°	F

INSET POWER in watts is the current consumption excluding any ballast
LUMINOUS FLUX value calculated for 3000K, CRI ≥ 90, colour white, lens flood 2700K -5%, 4000K +5%

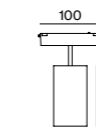
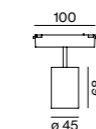

JUST 45

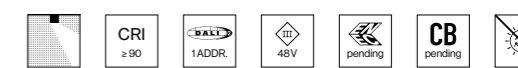

SPOTLIGHT

INSET POWER	LUMINOUS FLUX	ORDER CODE
6.1W super spot 8°	297lm	050-0131::3V
11W	788lm	050-0131::3V
12W CWD 2000-3000K	430lm	050-0131E3V
11W TW 1800-3000K	555lm	050-0131L3V
11W TW 2700-6500K	683lm	050-0131D3V

JUST 55

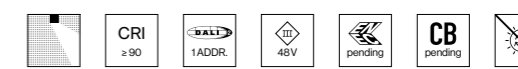

SPOTLIGHT

INSET POWER	LUMINOUS FLUX	ORDER CODE
15.9W	1300lm	050-0143::3V
30W	2090lm	050-0142::3V

Optical accessories

HONEYCOMB LOUVER

TYPE	Ø-H (mm)	ORDER CODE
JUST 45	42·3	007-1965188
JUST 55	50·3	007-1965598

The Raum Bolzano, IT –
by bergundtal gmbh.



[← back](#)

Quickinfo

PET felt
 ♻️ from recycled material
 up to absorption class A

Type

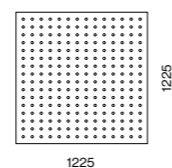

Colours



Order options

MATERIAL COLOUR **W**
 white **W**
 black **L**

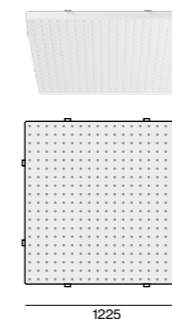

MOVE IT 45 suspended

MOVE IT ACOUSTIC SQUARE

TYPE	L-W-H (mm)	ORDER CODE
1200 inlay MOVE IT system*	1225·1225·57	050-230222 <input checked="" type="checkbox"/>

*NODE connector + track 1220mm

ACOUSTIC EXAMPLES

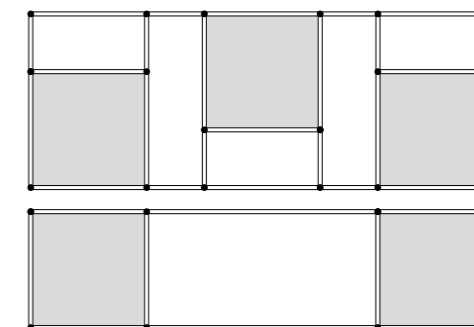

ACOUSTIC elements

accessory 45

EN Highly effective acoustic element made of self-supporting, recycled PET felt; direct sound is absorbed by the front-mounted fleece, sound reflected from the ceiling by an additional, rear-mounted fleece; this creates high acoustic performance; for installation in the MOVE IT 45 suspended system composed of node connectors and 1220 mm profiles

DE Hochwirksames Akustikelement aus selbsttragendem, recyceltem PET-Filz; Absorption des Direktschalls durch das vorderseitige Vlies, sowie Absorption des von der Decke reflektierten Schalls durch ein zusätzliches, rückseitiges Vlies; dadurch hohe akustische Performance; zum Einlegen in das MOVE IT 45 suspended system aus Knotenverbindern und Profilen der Länge 1220 mm

Ultra-slim office series



TASK system

EN In addition to impressive flexibility, the ultra-slim TASK series meets all requirements of modern office lighting. Innovative technology and highly efficient LEDs meet minimalistic design. Thanks to its microprismatic cover, TASK provides bright and glare-minimised work light. The product family with a shared sleek design is impressive: TASK can be expanded into a system via a click mechanism. The optional indirect light delivers pleasant ceiling illumination. Additional built-in sensors allow the TASK S system to adapt to motion and ambient brightness. The system can be expanded with optional acoustic elements to optimise room acoustics.

DE Die ultraschlanke TASK Serie erfüllt alle Anforderungen an moderne Bürobeleuchtung – neben beeindruckender Flexibilität. Innovative Technologie und hocheffiziente LEDs treffen auf minimalistisches Design. Dank mikroprismatischer Abdeckung spendet TASK brillantes und blendungsminimiertes Arbeitslicht. Die Produktfamilie überzeugt mit einem einheitlich schlanken Design: Dabei ist TASK via Klick-Mechanismus zu einem System erweiterbar. Das optionale Indirektlicht sorgt für eine angenehme Deckenaufhellung. Zusätzlich eingebaute Sensorik ermöglicht die Anpassung des TASK S Systems an Bewegung und Umgebungshelligkeit. Für optimale Raumakustik kann das System um optionale Akustikelemente erweitert werden.

Types

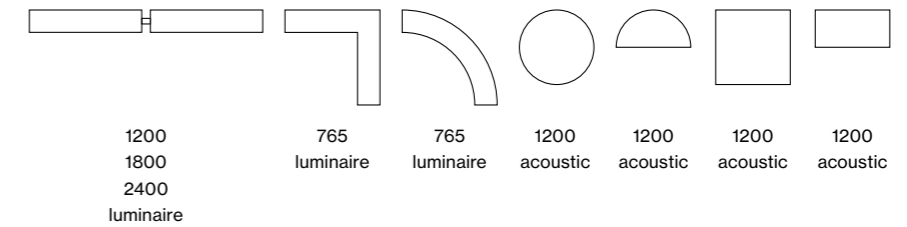

Mounting

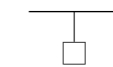

suspended

Configurations



linear corner curve

Light distributions

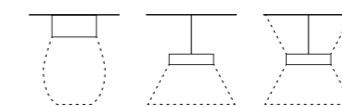

microprismatic (UGR ≤ 19) direct direct/indirect

Ultra-slim and versatile

EN TASK combines an ultra-slim design with innovative lighting technology. These include, in particular, an LGP (Light Guiding Prism), which directs the laterally coupled light from highly efficient LEDs upwards and downwards. It creates a pleasant room atmosphere through a balanced relationship between direct and indirect light.

DE TASK vereint ultraschlankes Design mit innovativer Lichttechnik. Dazu gehören insbesondere ein LGP (Light Guiding Prism), welches das seitlich eingekoppelte Licht aus hocheffizienten LEDs nach oben und unten lenkt. Es schafft ein ausgewogenes Verhältnis zwischen Direkt- und Indirektlicht und somit eine angenehme Raum Atmosphäre.

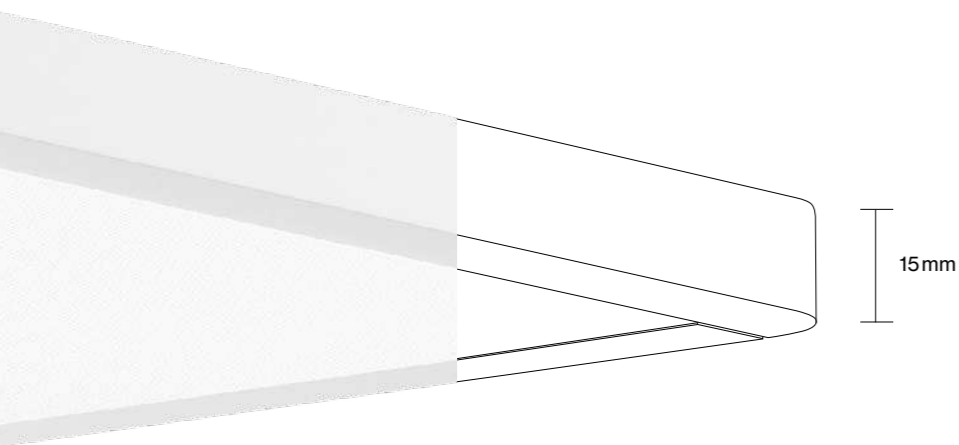

Simple click

EN Design freedom thanks to plug-in connections. Each TASK S system luminaire can be rearranged, combined, and electrically connected with just one click and without any tools. Whether office extension or interior redesign, this lighting system can handle any change.

DE Gestaltungs-freiraum dank Steckverbindung: Jede TASK S System Leuchte lässt sich ohne Werkzeug mit nur einem Klick neu arrangieren, kombinieren und elektrisch verbinden. Ob Büroerweiterung oder räumliches Redesign: Das Lichtsystem macht jede Veränderung mit.

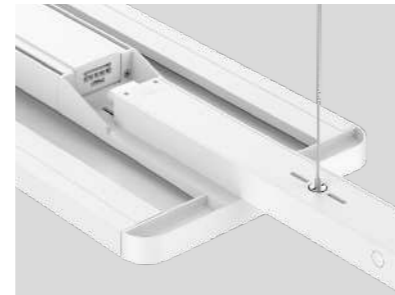

Pleasant room acoustics

EN In addition to lighting, pleasant room acoustics have an impact on job satisfaction. Acoustic element panels in different colours and made of 60% recycled PET complement the TASK series and reduce background noise around the office. For focused, productive work.

DE Neben Beleuchtung wirkt sich eine angenehme Raumakustik auf die Zufriedenheit am Arbeitsplatz aus. Akustik-elemente in verschiedenen Farben und aus 60% recyceltem PET ergänzen die TASK Serie und reduzieren Nebengeräusche im Büro. Für konzentriertes, produktives Arbeiten.

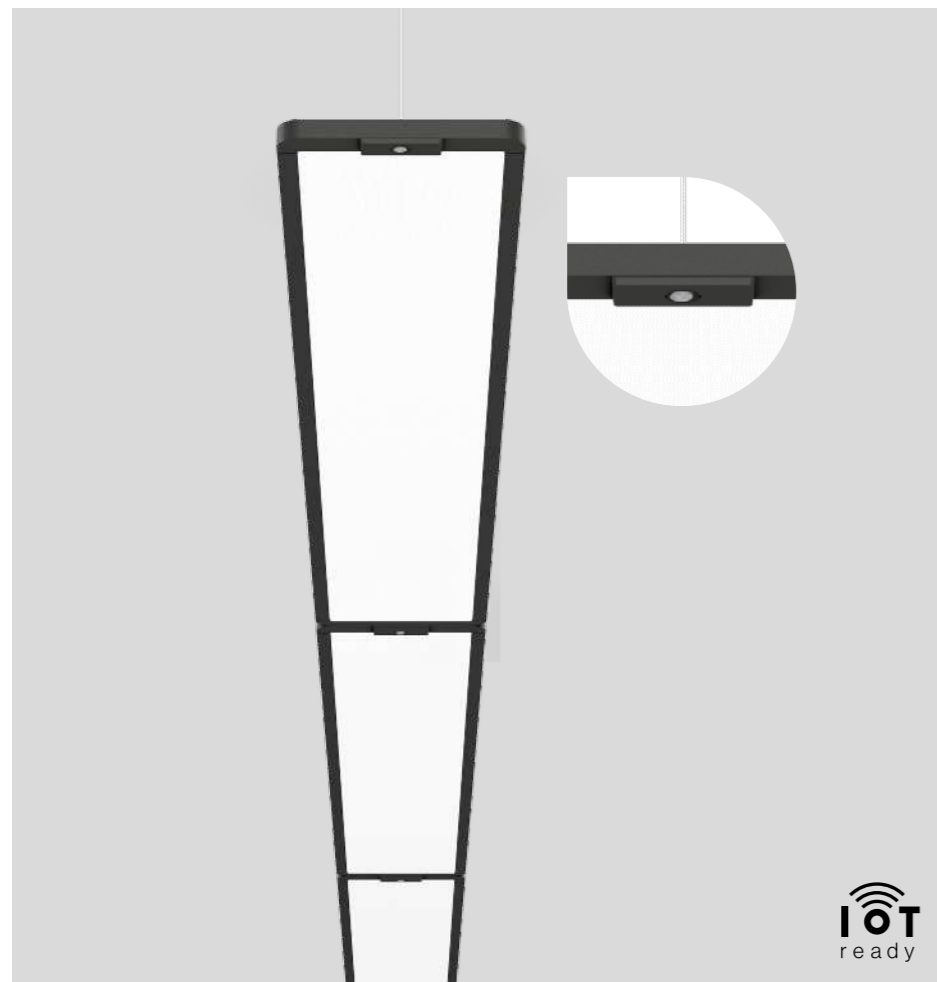

Advanced sensor technology

EN The TASK S system luminaire adapts to daylight and room activity. Integrated motion sensors automatically dim the lighting when no one is in the room. Smart movement sensors enable the light intensity to be adjusted to the ambient brightness. This saves energy and creates a dynamic, natural lighting atmosphere.

DE Die TASK S Systemleuchte passt sich an Tageslicht und Raumaktivität an. Integrierte Bewegungssensoren dimmen automatisch die Beleuchtung, wenn niemand im Raum ist. Smarte Daylight-Sensorik ermöglicht die Anpassung der Lichtstärke an die Umgebungshelligkeit. Das spart Energie und schafft eine dynamisch-natürliche Lichtstimmung.

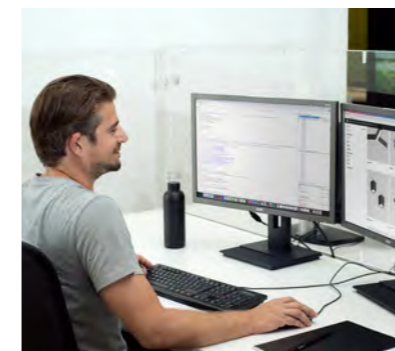

Screen-work friendly

EN TASK guarantees standard-compliant illumination of workplaces with custom anti-glare prisms. An ideal light source for double workstations in open-plan offices and for single workstations in smaller offices – all with reduced reflections.

DE Durch spezielle Entblendungsprismen garantiert TASK eine normgerechte Ausleuchtung von Arbeitsplätzen. Eine ideale Lichtquelle für Doppelarbeitsplätze in Großraumbüros aber auch für Einzelarbeitsplätze in kleineren Büroräumen und das bei reduzierten Spiegelungen.

Full-spectrum LED

EN XAL's new XPECTRUM LEDs deliver healthy, biologically effective light. The reduced blue light and increased cyan values reduce the blue light hazard for the eye to daylight-equivalent levels. The resulting non-visual, so-called melanopic light effect, improves concentration and increases sleep quality. The excellent colour rendering of IES TM 30-15 $R_f=98$ and $R_g=101$ further helps visual comfort.

DE Die neue XPECTRUM LED von XAL sorgt für gesundes, biologisch wirksames Licht. Der reduzierte Blaulichtanteil sowie die erhöhten Cyan-Werte minimieren die Blaulichtgefahr für das Auge auf ein tageslichtähnliches Niveau. Die daraus resultierenden nichtvisuellen, auch melanopische Lichtwirkung genannt, fördert die Konzentration und steigert die Schlafqualität. Die hervorragende Farbwiedergabe von IES TM 30-15 $R_f=98$ und $R_g=101$ ermöglicht zudem einen verbesserten Sehkomfort.

XPECTRUM LED

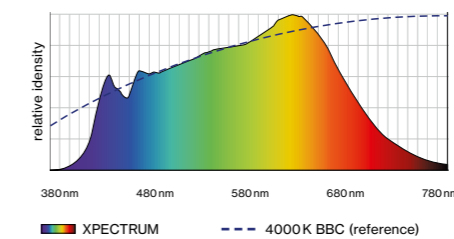

Commercially available LED 4000K

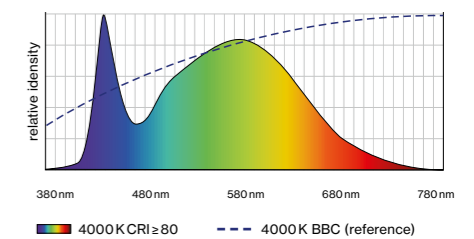

← back



TASK S system

suspended

EN Luminaire housing made of aluminium – rounded edges; rectangular, L-shaped or quarter circle segment design; ultra low-profile design (only 15 mm); for lighting systems; powder coated; cable suspension, tool-less height adjustment; convenient quick mounting system without tools; direct or direct/indirect light distribution by LGP body (Light Guiding Prism); side coupled light, directed downwards or up and down by laser engraving; light control via highly reflective reflector material; optional: indirect component – special PCBs for increased luminous flux (max. ceiling illumination); completely homogeneous illumination; energy-eff. LEDs – very good colour rendering; canopy for through wiring; sound absorb. accessories available

DE Leuchtenkörper aus Aluminium – abgerundete Kanten; rechteckig, L-förmig oder als Viertelkreis-Segment; extrem flache Bauform (nur 15 mm); für Lichtsysteme; pulverbeschichtet; werkzeuglos höhenverstellbare Seilabhangung; komfortables, werkzeugloses Schnellmontagesystem; direkte bzw. direkt/indirekte Lichtverteilung durch LGP-Body (Light-Guiding-Prism); seitlich eingekoppeltes Licht durch Lasergravur nach unten bzw. oben und unten gelenkt; Lichtlenkung mittels hochreflektierenden Reflektormaterials; optional: Indirektlichtant. – eigene Platinen f. erhoheten Lichtstrom (max. Deckenaufhellung); absolut homogene Ausleuchtung; energieeff. LEDs – sehr gute Farbwiedergabe; Baldachin fur Weiterverdrahtung; schallabsorb. Zubehor erhaltlich

Quickinfo

3000K, 4000K, TW
 CRI ≥ 90, 3 SDCM
 UGR ≤ 19 / 65° ≤ 3000 cd/m²
 up to 124 lm/W
 L80 @ 50 000 h
 DALI-2, DALI sensor
 microprismatic (UGR ≤ 19)

Types

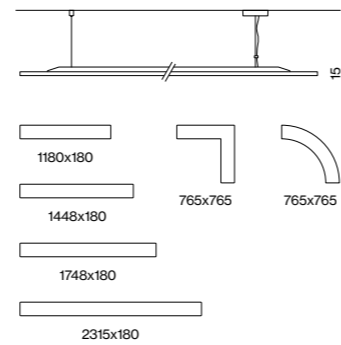

Colours



Light distributions

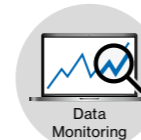
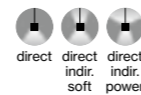

DiiA® standards
251, 252, 253



single luminaire
(p. 432)



acoustic
elements (p. 456)



DIN EN 12464-1
UGR ≤ 19



click-
system

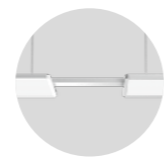

system
connector

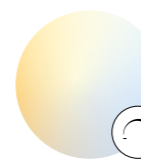

tunable white
2700–6500 K

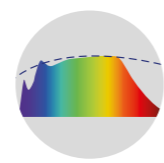

CRI ≥ 98
XPECTRUM

Order options

COLOUR TEMPERATURE	
3000 K	0
4000 K	1
tunable white 2700–6500 K*	

*DALI-2 DT8; CRI ≥ 80

3000 K + TW 2700–6500 K
4000 K + TW 2700–6500 K
DALI-2 DT8 (separately controllable)

CONTROL	
DALI-2	3
DALI sensor*	7

*version with sensor: length + 9 mm

MATERIAL COLOUR	
○ pure white RAL 9010	7
● jet black RAL 9005	8

Options on request

COLOUR RENDERING INDEX	
CRI ≥ 80	
CRI ≥ 98 XPECTRUM	

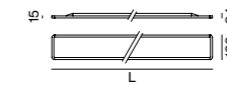

TASK S LINEAR suspended



DIRECT	SYS. POWER	COLOUR TEMP.	LUM. FLUX	L (mm)	ORDER CODE
	12.9 W	3000 K	1460 lm	1180	0 5 9 - 5 7 4 4 :: ◆ ◆ K
	16.1 W	3000 K	1820 lm	1448	0 5 9 - 5 7 4 5 :: ◆ ◆ K
	19.3 W	3000 K	2190 lm	1748	0 5 9 - 5 7 4 6 :: ◆ ◆ K
	25.7 W	3000 K	2920 lm	2315	0 5 9 - 5 7 4 8 :: ◆ ◆ K



DIRECT / INDIRECT SOFT	SYS. POWER	COLOUR TEMP.	LUM. FLUX	L (mm)	ORDER CODE
	19.5 W	3000 K	↓ 1900 / ± 327 lm	1180	0 5 9 - 5 7 5 4 :: ◆ ◆ K
	24.4 W	3000 K	↓ 2380 / ± 408 lm	1448	0 5 9 - 5 7 5 5 :: ◆ ◆ K
	29.2 W	3000 K	↓ 2860 / ± 490 lm	1748	0 5 9 - 5 7 5 6 :: ◆ ◆ K
	39 W	3000 K	↓ 3810 / ± 653 lm	2315	0 5 9 - 5 7 5 8 :: ◆ ◆ K



DIRECT / INDIRECT POWER	SYS. POWER	COLOUR TEMP.	LUM. FLUX	L (mm)	ORDER CODE
	42 W	3000 K	↓ 3190 / ± 1680 lm	1180	0 5 9 - 5 7 6 4 :: ◆ ◆ K
	49 W	3000 K	↓ 3190 lm	1180	0 5 9 - 5 7 D 4 0 ◆ ◆ K
	49 W (2 × DALI)	2700–6500 K	± 2090 lm	1180	0 5 9 - 5 7 D 4 1 ◆ ◆ K
	49 W (2 × DALI)	4000 K	± 3400 lm	1180	0 5 9 - 5 7 D 4 1 ◆ ◆ K
	62 W (2 ×)	2700–6500 K	± 2090 lm	1180	0 5 9 - 5 7 6 4 D ◆ ◆ K

53 W	3000 K	↓ 3990 / ± 2100 lm	1448	0 5 9 - 5 7 6 5 :: ◆ ◆ K
61 W	3000 K	↓ 3990 lm	1448	0 5 9 - 5 7 D 5 0 ◆ ◆ K
61 W (2 × DALI)	2700–6500 K	± 2610 lm	1448	0 5 9 - 5 7 D 5 1 ◆ ◆ K
61 W (2 × DALI)	4000 K	± 4250 lm	1448	0 5 9 - 5 7 D 5 1 ◆ ◆ K
78 W (2 ×)	2700–6500 K	± 2610 lm	1448	0 5 9 - 5 7 6 5 D ◆ ◆ K

63 W	3000 K	↓ 4790 / ± 2520 lm	1748	0 5 9 - 5 7 6 6 :: ◆ ◆ K
71 W	3000 K	↓ 5100 / ± 2680 lm	1748	0 5 9 - 5 7 D 6 0 ◆ ◆ K
71 W (2 × DALI)	2700–6500 K	± 2940 lm	1748	0 5 9 - 5 7 D 6 1 ◆ ◆ K
71 W (2 × DALI)	4000 K	± 5100 lm	1748	0 5 9 - 5 7 D 6 1 ◆ ◆ K
85 W (2 ×)	2700–6500 K	± 2940 lm	1748	0 5 9 - 5 7 6 6 D ◆ ◆ K

84 W	3000 K	↓ 6390 / ± 3360 lm	2315	0 5 9 - 5 7 6 8 :: ◆ ◆ K
92 W	3000 K	↓ 6800 / ± 3580 lm	2315	0 5 9 - 5 7 D 8 0 ◆ ◆ K
92 W (2 × DALI)	2700–6500 K	± 4180 lm	2315	0 5 9 - 5 7 D 8 1 ◆ ◆ K
92 W (2 × DALI)	4000 K	± 6800 lm	2315	0 5 9 - 5 7 D 8 1 ◆ ◆ K
118 W (2 ×)	2700–6500 K	± 4180 lm	2315	0 5 9 - 5 7 6 8 D ◆ ◆ K

Mounting accessories

see page 814

Light distributions

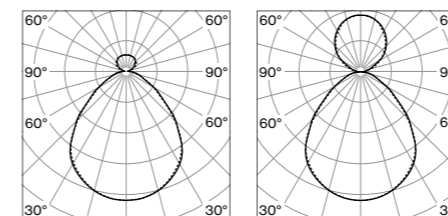

microprismatic direct/indirect soft
 microprismatic direct/indirect power

LUMINOUS FLUX value calculated for CRI ≥ 90, colour white, cover microprismatic

Order options

CORNER

without power feeder	2
with power feeder	3

COLOUR TEMPERATURE

3000K	0
4000K	1

CONTROL

DALI-2	
--------	--

MATERIAL COLOUR

<input type="radio"/> pure white RAL 9010	7
<input checked="" type="radio"/> jet black RAL 9005	8

Options on request

COLOUR RENDERING INDEX

CRI ≥ 80
CRI ≥ 98 XPECTRUM

TASK S CORNER/CURVE suspended

incl. cable suspension 1500 mm

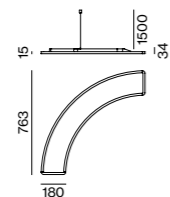
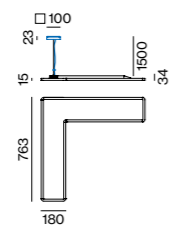

	CRI ≥ 98	UGR ≤ 19	cd/m² ≤ 3000	RG0 IEC 62471	DALI 1ADDR.	220-240V	X-PERT	X-PERT
--	----------	----------	--------------	---------------	-------------	----------	--------	--------

DIRECT

SYS. POWER	COLOUR TEMP.	LUM. FLUX	L (mm)	ORDER CODE
15W	3000K	1700lm	765	0 5 9 - 5 8 4 3 K
corner	4000K	1810lm		

12.9W	3000K	1460lm	765	0 5 9 - 5 5 4 2 3 K
curve	4000K	1550lm		

	CRI ≥ 98	UGR ≤ 19	cd/m² ≤ 3000	RG0 IEC 62471	DALI 1ADDR.	220-240V	X-PERT	X-PERT
--	----------	----------	--------------	---------------	-------------	----------	--------	--------

DIRECT / INDIRECT SOFT

SYS. POWER	COLOUR TEMP.	LUM. FLUX	L (mm)	ORDER CODE
22.7W	3000K	↓ 2220 / ↑ 381lm	765	0 5 9 - 5 8 5 3 K
corner	4000K	↓ 2370 / ↑ 407lm		

	CRI ≥ 98	UGR ≤ 19	RG0 IEC 62471	DALI 1ADDR.	220-240V	X-PERT	X-PERT
--	----------	----------	---------------	-------------	----------	--------	--------

DIRECT / INDIRECT POWER

SYS. POWER	COLOUR TEMP.	LUM. FLUX	L (mm)	ORDER CODE
49W	3000K	↓ 3680 / ↑ 1890lm	765	0 5 9 - 5 8 6 3 K
corner	4000K	↓ 3920 / ↑ 2010lm		

42W	3000K	↓ 3150 / ↑ 1610lm	765	0 5 9 - 5 5 6 2 3 K
curve	4000K	↓ 3350 / ↑ 1720lm		

Mounting accessories

LINEAR / CORNER 90° CONNECTOR incl. cable suspension 1500 mm

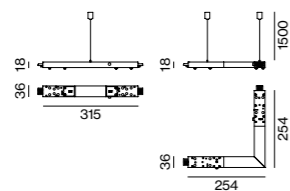

TYPE	L (mm)	ORDER CODE
linear mechanical & electrical	10	0 5 9 - 2 7 9 2 3 1
linear mechanical	10	0 5 9 - 2 7 9 2 4 1
corner 90° mechanical & electrical	254x254	0 5 9 - 2 7 9 2 7 1
corner 90° mechanical	254x254	0 5 9 - 2 7 9 2 8 1

SYSTEM CONNECTOR incl. cable suspension 1500 mm

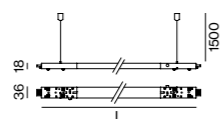

TYPE	L (mm)	ORDER CODE
mechanical & electrical	800	0 5 9 - 2 7 9 2 3 2
mechanical & electrical	1200	0 5 9 - 2 7 9 2 3 3
mechanical & electrical cuttable	1200	0 5 9 - 2 7 9 2 3 0
mechanical & electrical cuttable	2400	0 5 9 - 2 7 9 2 3 4
optional cable suspension	1500	0 5 9 - 2 7 9 2 1 2 7

END PIECE incl. cable suspension 1500 mm

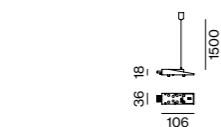

TYPE	L (mm)	ORDER CODE
end piece	1500	0 5 9 - 2 7 9 2 1 1

POWER FEEDER incl. cable suspension 1500 mm and canopy / feeder cable

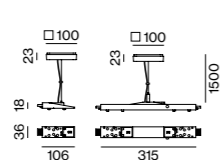

TYPE	L (mm)	ORDER CODE
power feeder 5x1.5mm²	1500	0 5 9 - 2 7 9 2 2 1
middle power feeder 5x1.5mm²	1500	0 5 9 - 2 7 9 2 5 1

for electrical system configuration see luminaire data sheet at xal.com

Light distributions

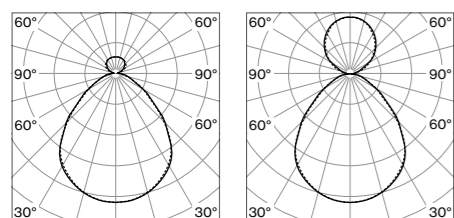

microprismatic direct/indirect soft microprismatic direct/indirect power

LUMINOUS FLUX value calculated for colour white, cover microprismatic



L'Oréal Vienna, AT – by Philipp Grem

Clariant Lodz, PL –
by The Design Group
with lighting design
by Plus Lighting



Training center GBU Ritual
Moscow, RU – by Khvorostyaniy T. &
Semionov A. with lighting design by
KA2 Light Architecture



← back

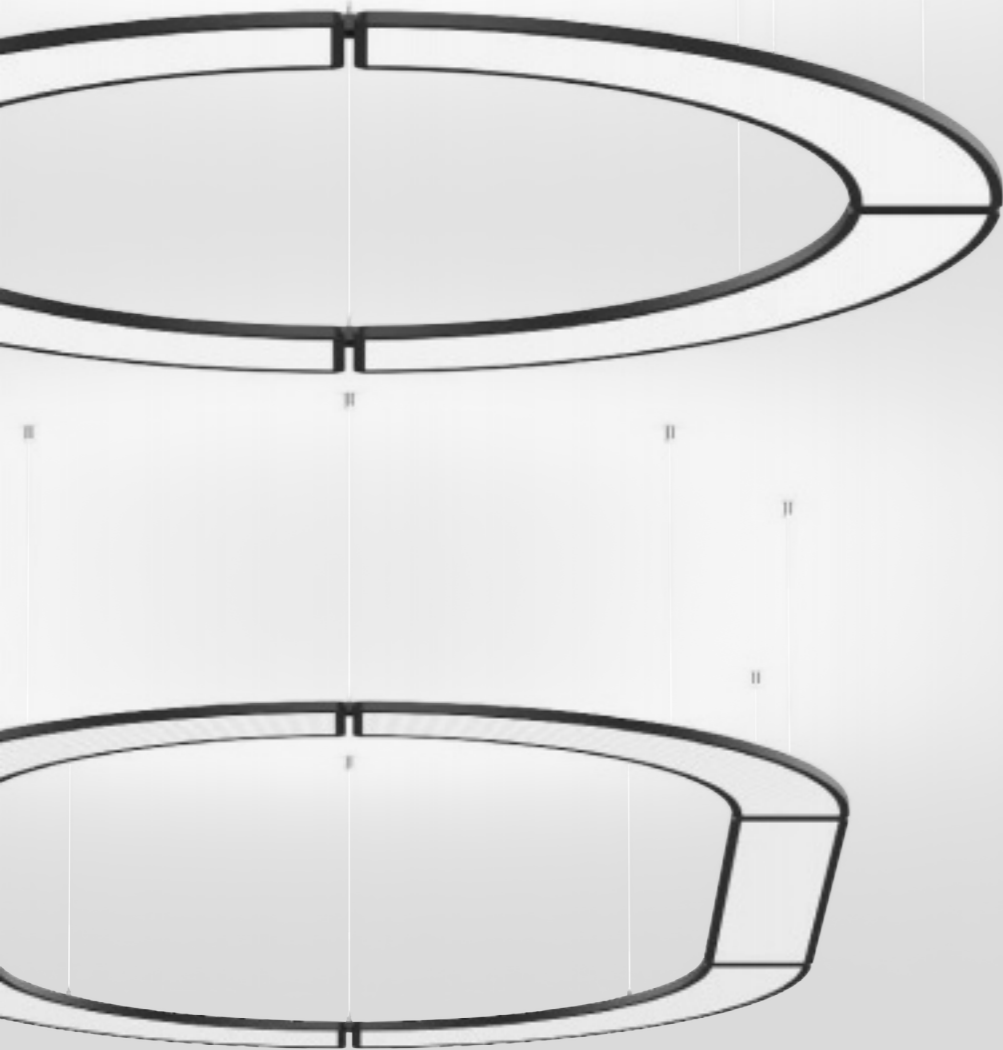

TASK circle

suspended

EN Ring-shaped suspended luminaire, consisting of single elements in quarter circle or rectangular shape; Luminaire housing made of aluminium – rounded edges; ultra low-profile design (only 15 mm); surface powder coated; cable suspension, tool-less height adjustment; convenient quick mounting system without tools; incl. transparent feed; direct light distribution by LGP body (Light Guiding Prism); side coupled light directed downwards by laser engraving; indirect component with special PCBs for increased luminous flux and maximum ceiling illumination; completely homogeneous illumination; energy-eff. LEDs – very good colour rendering; canopy for through wiring; optional acoustic elements available

DE Ringförmige Pendelleuchte, bestehend aus einzelnen Elementen in Viertelring- bzw. Rechteck-Form; Leuchtenkörper aus Aluminium – abgerundete Kanten; extrem flache Bauform (nur 15 mm); Oberfläche pulverbeschichtet; werkzeuglos höhenverstellbare Seilabhängung; komfortables, werkzeugloses Schnellmontagesystem; inkl. transparenter Einspeiseleitung; direkte Lichtverteilung durch LGP-Body (Light-Guiding-Prism); seitlich eingekoppeltes Licht durch Lasergravur nach unten gelenkt; Indirektlichtanteil mit eigenen Platinen für erhöhten Lichtstrom und maximale Deckenaufhellung; absolut homogene Ausleuchtung; energieeff. LEDs – sehr gute Farbwiedergabe; Baldachin für Weiterverdrahtung; optional Akustikelemente erhältlich

Quickinfo

4000K
 CRI ≥ 90, 3 SDCM
 UGR ≤ 19 / 65° ≤ 3000 cd/m²
 up to 117 lm/W
 L95 @ 50 000h
 DALI-2
 microprismatic (UGR ≤ 19)

acoustic elements
 PET felt
 ♻️ from recycled material
 up to absorption class A
 🔥 available as B-s1, d0

Types

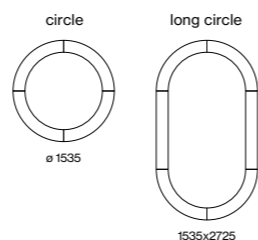

Luminaire colours



Acoustic colours

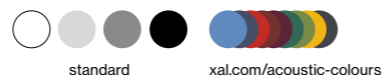

Light distribution

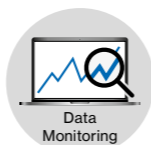

DiiA® standards
 251, 252, 253



click-system

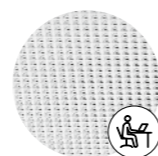

DIN EN 12464-1
 UGR ≤ 19

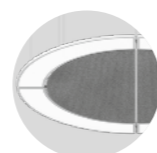

acoustic elements

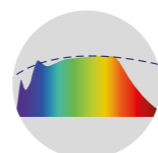

CRI ≥ 98
 XPECTRUM

Order options

COLOUR TEMPERATURE
 4000K

CONTROL
 DALI-2

LUMINAIRE COLOUR
 pure white RAL 9010 7
 jet black RAL 9005 8

ACOUSTIC COLOUR
 white W
 marble grey D
 felt grey G
 black L
 special colours p. 992 X

LIGHT OPTIC COVER
 microprismatic (UGR ≤ 19)

Options on request

COLOUR RENDERING INDEX
 CRI ≥ 80
 CRI ≥ 98 XPECTRUM

FORM

for other configurations see
 TASK S suspended system

Light distribution

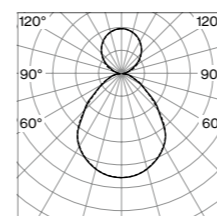

microprismatic
 direct/indirect power

LUMINOUS FLUX value calculated for
 CRI ≥ 90, colour white, cover microprismatic

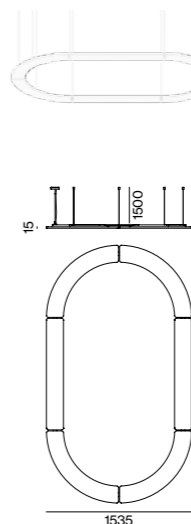
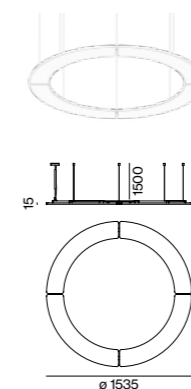

TASK circle suspended



DIRECT / INDIRECT POWER

SYSTEM POWER	COLOUR TEMP.	LUMINOUS FLUX	ORDER CODE
169W	4000K	↓ 12900 / ± 6870 lm	0 5 9 - 5 2 8 1 1 3 <input checked="" type="checkbox"/> K

TASK long circle suspended



DIRECT / INDIRECT POWER

SYSTEM POWER	COLOUR TEMP.	LUMINOUS FLUX	ORDER CODE
252W	4000K	↓ 20200 / ± 10460 lm	0 5 9 - 5 2 8 2 1 3 <input checked="" type="checkbox"/> K

Technical data

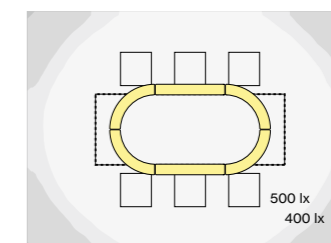

TASK long circle
 252W, 4000K, direct/indirect power

ROOM VALUES

Room dimensions	5.4 × 4 × 2.8 m
Reflection factor	0.7 0.5 0.2
Maintenance factor	0.8
Suspension height	2.25 m

CALCULATION SURFACE

Surface dimensions	3.2 × 1.2 m
Surface height	0.75 m
Average illuminance (E _m)	> 500 lx
Uniformity (U ₀)	> 0.6

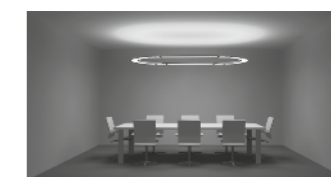

GLARE EVALUATION
 Table Classification X=4H | Y=8H | S=0.25H

UGR transversal	≤ 19
UGR axial	≤ 19

Acoustic elements

TASK ACOUSTIC inlay

TYPE	L-W-H (mm)	ORDER CODE
1 TASK circle suspended	1155-1155-30	0 5 9 - 5 7 9 7 3 6 <input checked="" type="checkbox"/>
2 TASK long circle suspended	1155-2346-30	0 5 9 - 5 7 9 7 3 8 <input checked="" type="checkbox"/>

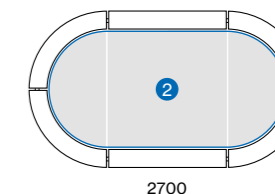
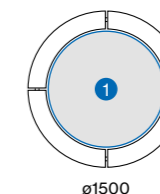



Art Invest Millenium Tower
Vienna, AT –
by LOVE architecture and urbanism

**Compound Semiconductor
Applications Catapult**
Wales, UK – by Monteith Scott



← back

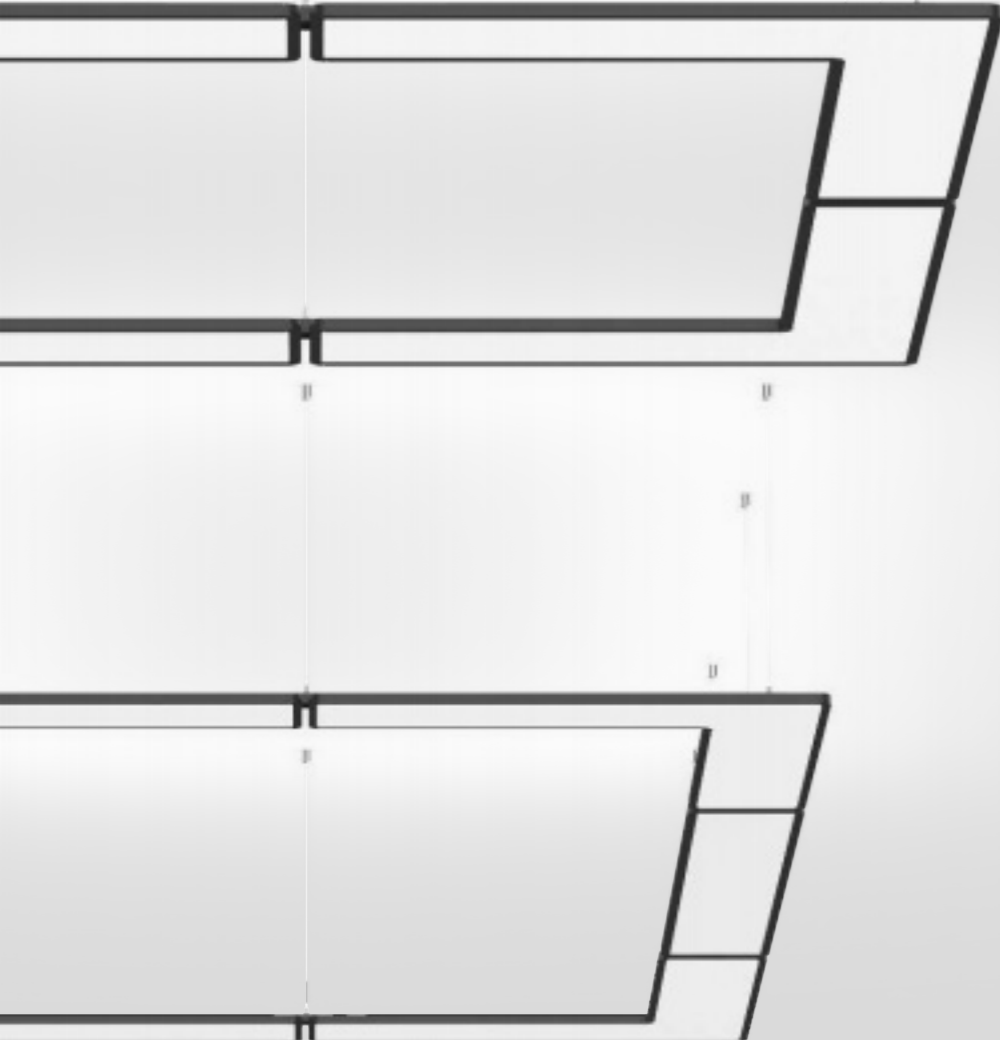

TASK angular suspended

EN Rectangular suspended luminaire, consisting of single L-shaped or rectangular elements; Luminaire housing made of aluminium – rounded edges; ultra low-profile design (only 15 mm); surface powder coated; cable suspension, tool-less height adjustment; convenient quick mounting system without tools; incl. transparent feed; direct light distribution by LGP body (Light Guiding Prism); side coupled light directed downwards by laser engraving; indirect component with special PCBs for increased luminous flux and maximum ceiling illumination; completely homogeneous illumination; energy-eff. LEDs – very good colour rendering; canopy for through wiring; optional acoustic elements available

DE Rechteckige Pendelleuchte, bestehend aus einzelnen L-förmigen bzw. rechteckigen Elementen; Leuchtenkörper aus Aluminium – abgerundete Kanten; extrem flache Bauform (nur 15 mm); Oberfläche pulverbeschichtet; werkzeuglos höhenverstellbare Seilabhängung; komfortables, werkzeugloses Schnellmontagesystem; inkl. transparenter Einspeiseleitung; direkte Lichtverteilung durch LGP-Body (Light-Guiding-Prism); seitlich eingekoppeltes Licht durch Lasergravur nach unten gelenkt; Indirektlichtanteil mit eigenen Platinen für erhöhten Lichtstrom und maximale Deckenaufhellung; absolut homogene Ausleuchtung; energieeff. LEDs – sehr gute Farbwiedergabe; Baldachin für Weiterverdrahtung; optional Akustikelemente erhältlich

Quickinfo

4000K
 CRI ≥ 90, 3 SDCM
 up to 118lm/W
 L95 @ 50 000h
 DALI-2
 microprismatic (UGR ≤ 19)

acoustic elements
 PET felt
 ♻️ from recycled material
 up to absorption class A
 🔥 available as B-s1, d0

Types

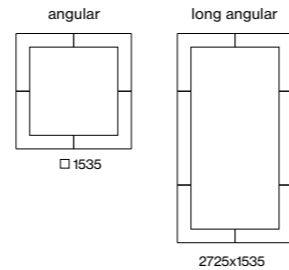

Luminaire colours



Acoustic colours



Light distribution



DiiA® standards
 251, 252, 253

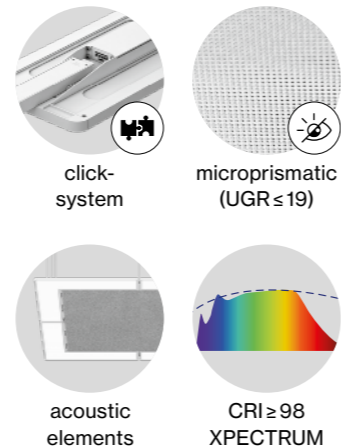

Order options

COLOUR TEMPERATURE
 4000K

CONTROL
 DALI-2

LUMINAIRE COLOUR
 pure white RAL 9010 7
 jet black RAL 9005 8

ACOUSTIC COLOUR
 white W
 marble grey D
 felt grey G
 black L
 special colours p.992 X

LIGHT OPTIC COVER
 microprismatic (UGR ≤ 19)

Options on request

COLOUR RENDERING INDEX
 CRI ≥ 80
 CRI ≥ 98 XPECTRUM

FORM

for other configurations see
 TASK S suspended system

Light distribution

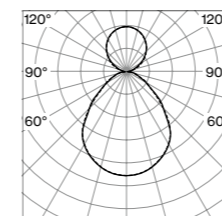

microprismatic
 direct/indirect power

LUMINOUS FLUX value calculated for
 CRI ≥ 90, colour white, cover microprismatic

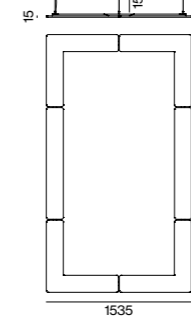
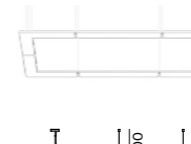
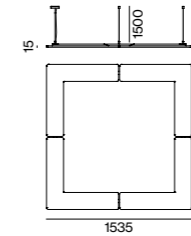
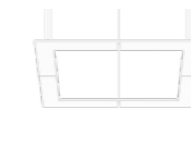

TASK angular suspended



DIRECT / INDIRECT POWER

SYSTEM POWER	COLOUR TEMP.	LUMINOUS FLUX	ORDER CODE
197W	4000K	↓ 15200/± 8050 lm	0 5 9 - 5 2 8 3 1 3 <input checked="" type="checkbox"/> K

TASK long angular suspended



DIRECT / INDIRECT POWER

SYSTEM POWER	COLOUR TEMP.	LUMINOUS FLUX	ORDER CODE
280W	4000K	↓ 22480/± 11620 lm	0 5 9 - 5 2 8 4 1 3 <input checked="" type="checkbox"/> K

Technical data

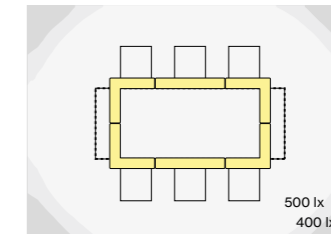

TASK long angular, 280W, 4000K,
 direct/indirect power

ROOM VALUES

Room dimensions	5.4 × 4 × 2.8 m
Reflection factor	0.7 0.5 0.2
Maintenance factor	0.8
Suspension height	2.25 m

CALCULATION SURFACE

Surface dimensions	3.2 × 1.2 m
Surface height	0.75 m
Average illuminance (E _m)	> 500 lx
Uniformity (U ₀)	> 0.6

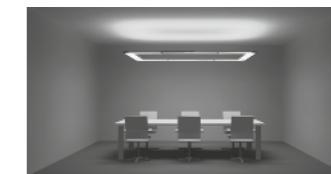

GLARE EVALUATION

Table Classification X=4H Y=8H S=0.25H	
UGR transversal	≤ 19
UGR axial	≤ 19

Acoustic elements

TASK ACOUSTIC inlay

TYPE	L-W-H (mm)	ORDER CODE
1 TASK angular suspended	1155-1155-30	0 5 9 - 5 7 9 7 1 6 <input checked="" type="checkbox"/>
2 TASK long angular suspended	1155-2346-30	0 5 9 - 5 7 9 7 1 8 <input checked="" type="checkbox"/>

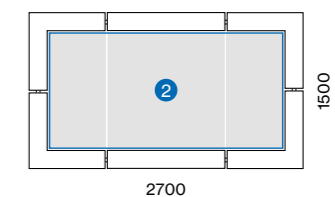
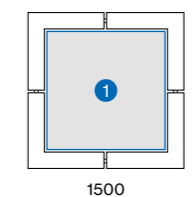

L'Oréal
Vienna, AT –
by Philipp Grem



Community Windpower
Cheshire, UK



Training center GBU Ritual
Moscow, RU – by Khvorostyaniy T. &
Semionov A. with lighting design by
KA2 Light Architecture

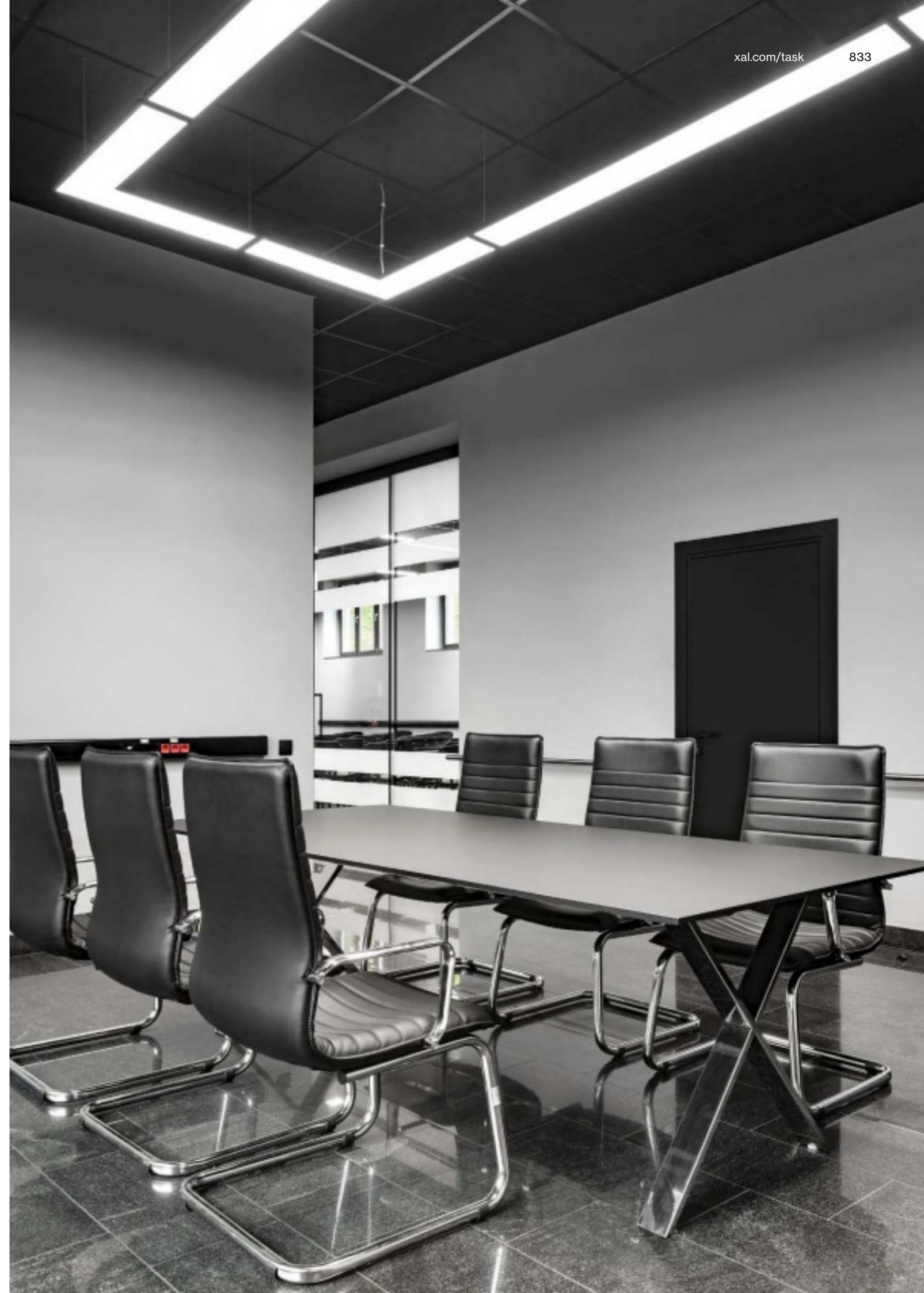

Slim and smart office system

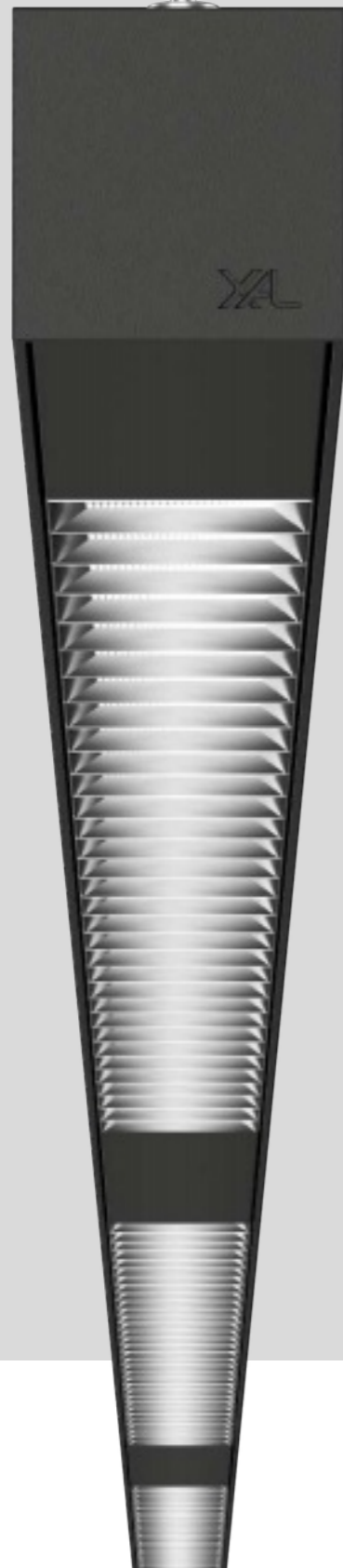

BETO system

EN BETO is extremely slim, powerful, and optimised for office use. It is a system luminaire with an impressive range of flexible elements that can be lined up like building blocks. Available in ceiling-mounted and suspended versions, the system combines technical excellence with subtle, minimalist design. Designed specifically for offices, BETO has custom reflectors to give the best possible user-friendly, ambient monitor lighting. Some variants can be fitted with a brightness and presence sensor. This adapts the lighting to the activity in the office while reducing energy costs. The BETO System has an optional indirect light component for additional ceiling illumination. All curved and straight elements come in 3000 K or 4000 K light colours, and some also have a Tunable White option.

DE Extrem schlank, leistungsstark und optimiert für den Einsatz im Office: Als Systemleuchte überzeugt BETO durch ihre flexiblen Elemente, die bausteinartig aneinandergereiht werden können. Sowohl die Deckenanbau- als auch die abgehängte System-Variante vereinen technische Exzellenz und subtiles, minimalistisches Design. BETO wurde für den Office-Bereich konzipiert und verfügt über spezielle Reflektoren für bestes, bildschirmtaugliches Arbeitslicht. Zudem kann die Leuchte in manchen Varianten mit einem Anwesenheits- und Helligkeitssensor ausgestattet werden. Indem die Beleuchtung den Dynamiken im Büro angepasst wird, reduzieren sich gleichzeitig Energiekosten. Das BETO System verfügt über einen optionalen Indirektlichtanteil zur zusätzlichen Deckenaufhellung. Alle gebogenen oder geraden Elemente sind in den Lichtfarben 3000 K, 4000 K oder teilweise mit Tunable White Option erhältlich.

Types

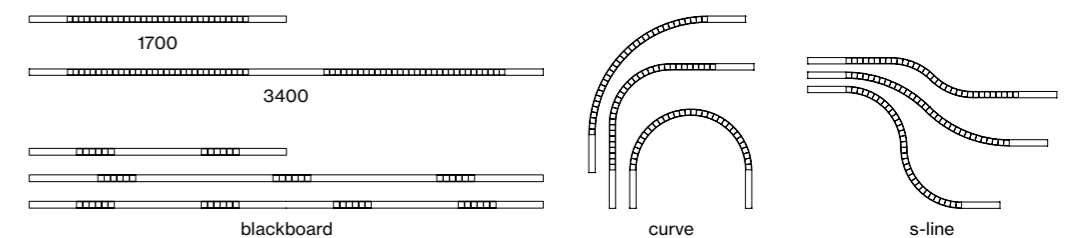

Mountings

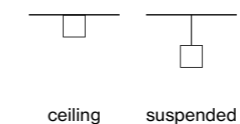

Light distributions

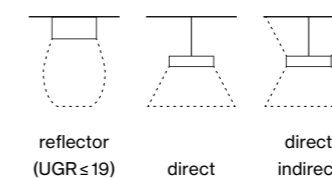

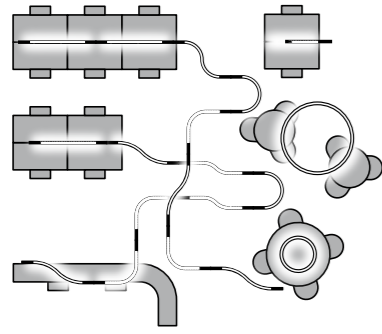

Straight or curved

EN BETO System comes as a suspended luminaire with both straight or curved system elements. Regardless of whether in a linear, curved, or s-shaped design, BETO offers a multifunctional lighting solution that can be integrated into any lighting concept. With an optional indirect light component, the light is distributed homogeneously, creating a pleasant atmosphere.

DE BETO System steht als abgehängte Leuchte mit geradlinigen oder gebogenen Systemelementen zur Verfügung. Egal ob linear, kurvig oder als s-förmig, BETO bietet eine multifunktionale Lichtlösung, die sich in jedes Lichtplanungskonzept einfügt. Optional mit Indirektlichtanteil wird das Licht homogen im Raum verteilt und erzeugt ein angenehmes Raumgefühl.

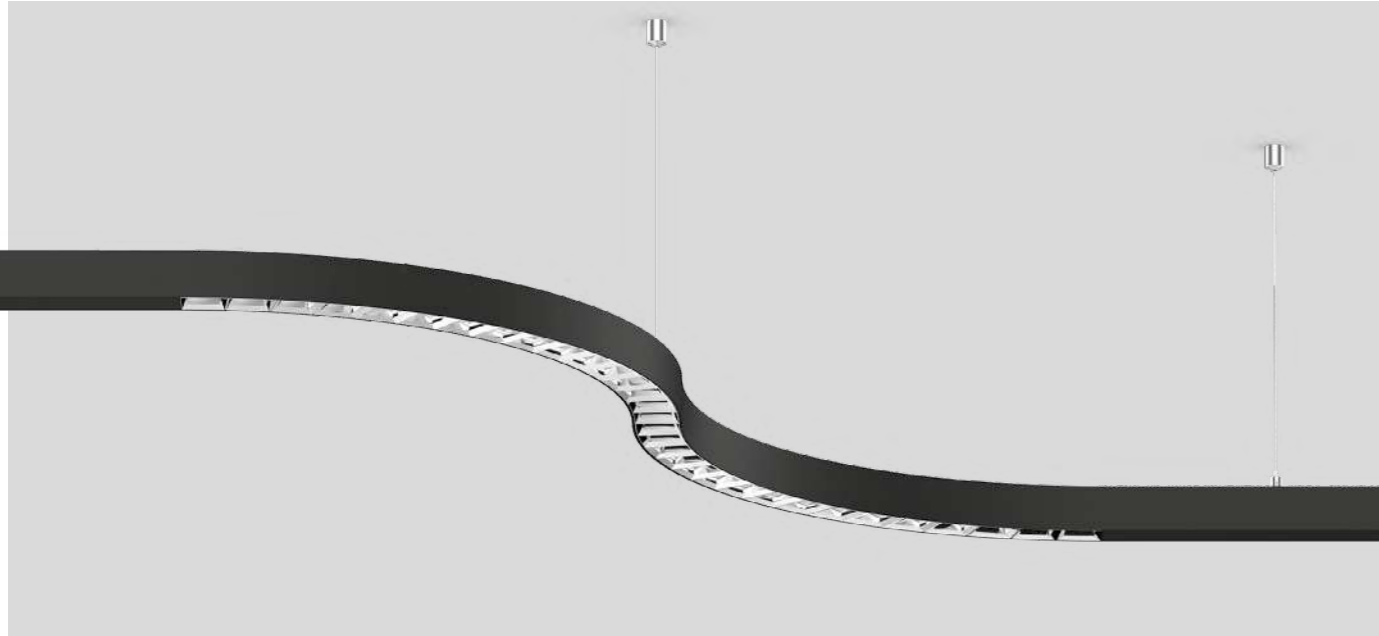

Work-friendly light

EN As an office luminaire, BETO guarantees illumination that is compliant with workplace standards (up to $UGR \leq 13$). Custom glare-free reflectors and the selected use of blind covers direct the light precisely to the work surface and reduce reflections. The direct/indirect version comes with special lens technology that distributes the indirect light component homogeneously and broadly into the room.

DE Als Office-Leuchte garantiert BETO eine normgerechte Ausleuchtung von Arbeitsplätzen (bis zu $UGR \leq 13$). Speziell entblendete Reflektoren und der gezielte Einsatz von Blind-Covers richten das Licht zielgenau auf die Arbeitsfläche und reduzieren Spiegelungen. Bei der direkt/indirekt Variante, verteilt eine spezielle Linsentechnik, den sehr breit ausstrahlenden Indirektlichtanteil homogen an der Decke für eine angenehme Raumatmosphäre.



Blackboard lighting

EN Uniform blackboard illumination is still a primary focus of good classroom lighting to hold attention and remain legible even from the back. It is often helpful during presentations to dim the lighting or to illuminate parts of the room. Pre-programmed lighting scenes can be activated, thus supporting varying teaching requirements.

DE Im Fokus einer guten Klassenzimmerbeleuchtung liegt nach wie vor die gleichmäßige Illumination der Tafel, um auch in der letzten Bankreihe noch eine optimale Wahrnehmung und Lesbarkeit zu garantieren. Bei Präsentationen ist es wiederum sinnvoll, die Beleuchtungsanlage zu dimmen, oder nur Teilbereiche des Raumes zu beleuchten. Vorprogrammierte Szenen können abgerufen werden und somit wechselnde Unterrichts-anforderungen unterstützen.

Advanced sensor technology



EN BETO System is equipped with a DALI sensor and can be controlled as a network. A presence sensor controls the light at the workstation if someone is there. A brightness sensor adjusts the light intensity to the ambient brightness. If desks, rooms, or corridors are unoccupied, the light automatically switches off after a defined delay. This saves energy and extends the service life.

DE Ausgestattet mit einem DALI-Sensor kann BETO System als Netzwerk gesteuert werden. Ein Anwesenheitssensor regelt abhängig von der Präsenz einer Person das Licht am Arbeitsplatz. Zusätzlich passt ein Helligkeitssensor die Lichtstärke an die Umgebungshelligkeit an. Damit schaltet sich das Licht bei unbesetzten Schreibtischen, Räumen oder Gängen nach einer definierten Nachlaufzeit automatisch aus. Das spart Energie und erhöht die Lebensdauer.

Full-spectrum LED

EN XAL's new XPECTRUM LEDs deliver healthy, biologically effective light. The reduced blue light and increased cyan values reduce the blue light hazard for the eye to daylight-equivalent levels. The resulting non-visual, so-called melanopic light effect, improves concentration and increases sleep quality. The excellent colour rendering of IES TM 30-15 $R_f = 98$ and $R_g = 101$ further helps visual comfort.

DE Die neue XPECTRUM LED von XAL sorgt für gesundes, biologisch wirksames Licht. Der reduzierte Blaulichtanteil sowie die erhöhten Cyan-Werte minimieren die Blaulichtgefahr für das Auge auf ein tageslichtähnliches Niveau. Die daraus resultierende nichtvisuelle, auch melanopische Lichtwirkung genannt, fördert die Konzentration und steigert die Schlafqualität. Die hervorragende Farbwiedergabe von IES TM 30-15 $R_f = 98$ und $R_g = 101$ ermöglicht zudem einen verbesserten Sehkomfort.

XPECTRUM LED

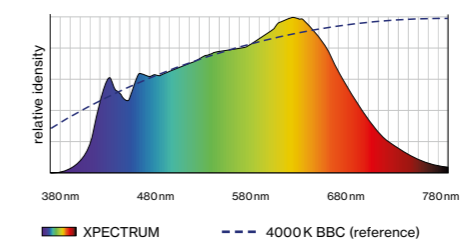

Commercially available LED 4000 K

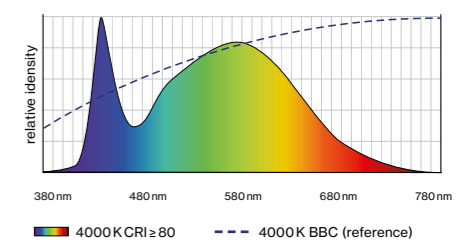

← back

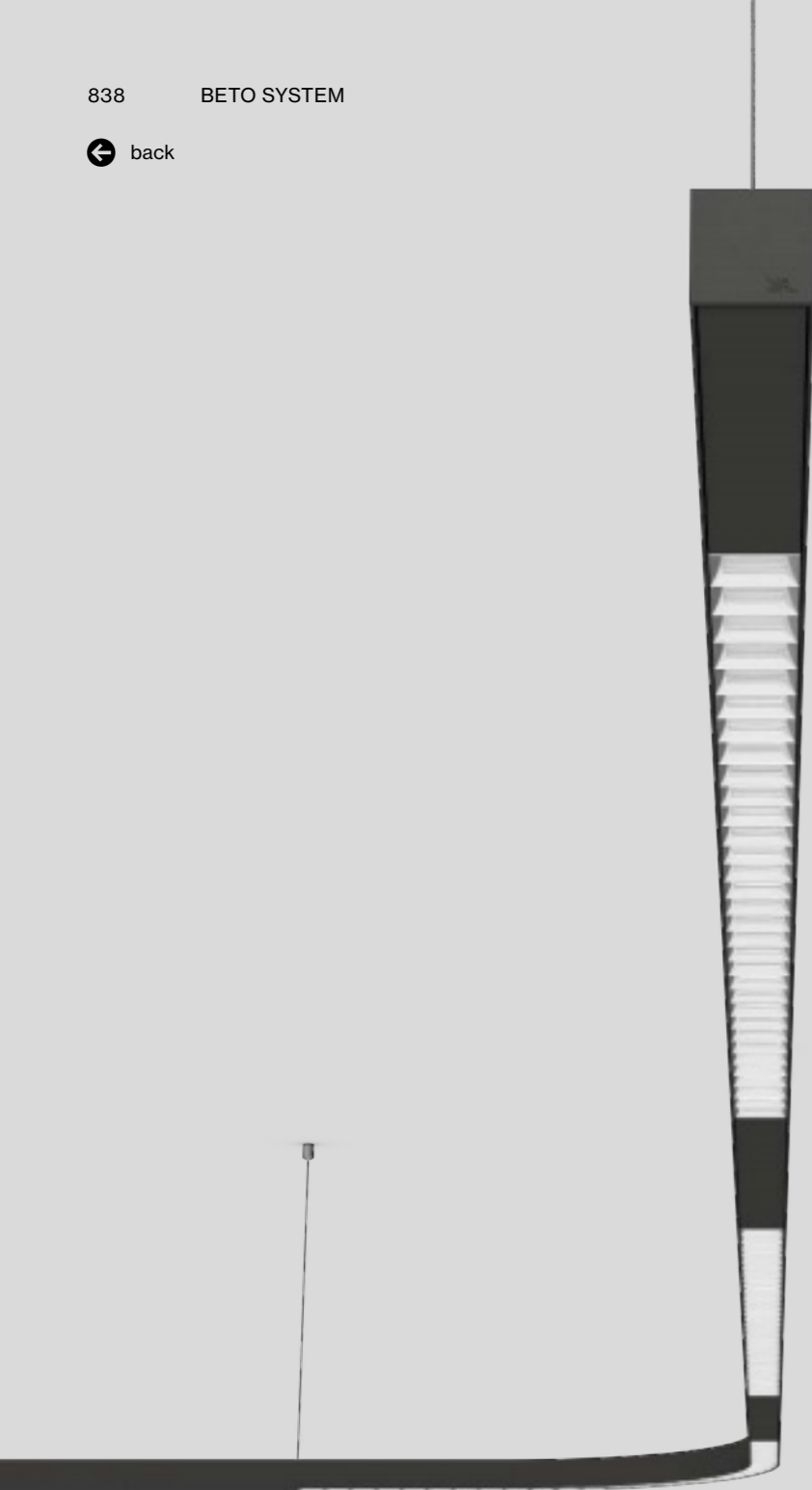

BETO system

ceiling / suspended

EN Luminaire housing from extruded aluminium profile, angular design (only 42x42mm); no visible screws; for lighting systems; linear, S-shaped or CURVE segment (90° or 180°); powder coated; pendant fitting with cable suspension; height adjustment without tools; with transparent feeder cable; extruded profile for improved thermal management; high-gloss reflector with faceted design; direct or direct/indirect light distribution, or with high-quality aluminum-vaporised micro-faceted reflector for homogeneous vertical lighting intensity; indirect light component with integrated PCboards and high-quality lens system for max., homog. ceiling illumination, separately controllable; energy-eff. LEDs – very good colour rendering

DE Leuchtenkörper aus Aluminiumstrangpressprofil, kantige Ausführung (nur 42 x 42 mm); keine sichtbaren Schrauben; für Lichtsysteme; linear, S-förmig, oder CURVE Element (90° bzw. 180°); pulverbeschichtet; abgependelt mit Seilabhängung; werkzeuglose Höhenverstellung; inkl. transp. Einspeiseleitung; Strangpressprofil für verbessertes Thermomanagement; hochglänzender Reflektor mit Facettenoptik; direkte bzw. direkt/indirekte Abstrahlcharakteristik, oder mit hochwert. aluminiumbedampften microfacettierte Refl. für homogene vertikale Beleuchtung; Indirektlichtanteil mit eigenen Platinen u. hochwertiger Linsenoptik für max., homog. Deckenaufhellung, separat steuerbar; energieeff. LEDs – sehr gute Farbwiedergabe

Quickinfo

3000K, 4000K, TW
 CRI ≥ 80, 3 SDCM
 UGR ≤ 19 / 65° ≤ 1500 cd/m²
 L 3400 direct up to 136lm/W
 L 3400 D/I up to 140lm/W
 L 3400 blackboard up to 124lm/W
 L90 @ 50 000 h
 DALI-2, DALI sensor
 reflector (UGR ≤ 19)

Types

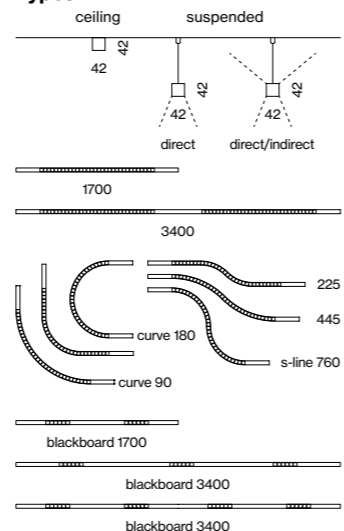

Colours



Light distributions

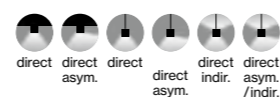

Data Monitoring

curve elements

single luminaire (p. 470)

DIN EN 12464-1 UGR ≤ 19

glare-free direct and 170° indirect illumination

CRI ≥ 98 XPECTRUM

Order options

COLOUR TEMPERATURE	
3000K	5
4000K	6
tunable white 2700–6500 K*	
*DALI-2 DT8	
CONTROL	
DALI-2	3
DALI sensor*	7

*brightness & presence only linear 3400 mm (not blackboard)

MATERIAL COLOUR	
○ pure white RAL 9010	7
● jet black RAL 9005	8

LIGHT OPTIC COVER
 reflector (UGR ≤ 19)

Options on request

COLOUR RENDERING INDEX
 CRI ≥ 90
 CRI ≥ 98 XPECTRUM

SYSTEM SOLUTION
 continuous reflector
 individual length

Light distributions

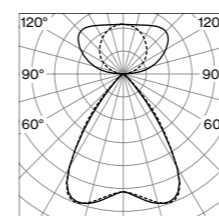

reflector (UGR ≤ 16)
 direct/indirect power

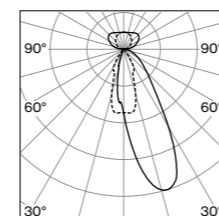

blackboard
 direct/indirect

LUMINOUS FLUX value calculated for CRI ≥ 80, colour white, reflector chrome

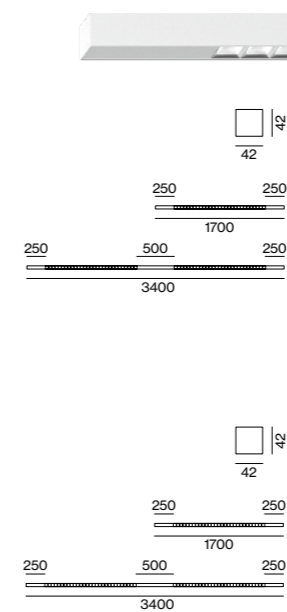

BETO linear ceiling / suspended system

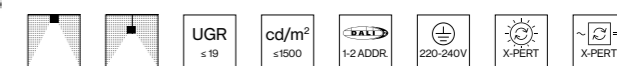

DIRECT				
SYS. POWER	COLOUR TEMP.	LUM. FLUX	L (mm)	ORDER CODE
26.1W (1×DALI)	3000K	3340lm	1700	074-6006
52W (2×DALI)	4000K	3540lm	3400	074-6009
	3000K	6680lm		
	4000K	7080lm		

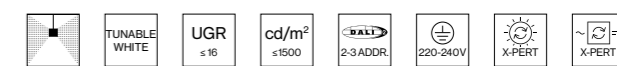

DIRECT / INDIRECT POWER				
SYS. POWER	COLOUR TEMP.	LUM. FLUX	L (mm)	ORDER CODE
57W (2×DALI)	3000K	↓ 3350 / ± 3790lm	1700	074-6036
109W (3×DALI)	4000K	↓ 3540 / ± 4020lm	3400	074-6039
109W (3×DALI)	3000K	↓ 6690 / ± 7590lm	3400	074-60D95
109W (3×DALI)	4000K	↓ 7080 / ± 8040lm	3400	074-60D96
109W (3×DALI)	2700–6500K	± 6810lm		
109W (3×DALI)	4000K	± 6810lm		
109W (3×DALI)	2700–6500K	± 6810lm		

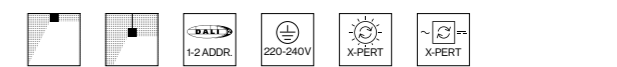

BLACKBOARD WALLWASHER				
SYS. POWER	COLOUR TEMP.	LUM. FLUX	L (mm)	ORDER CODE
48W (1×DALI)	3000K	4940lm	1700	074-7706
72W (2×DALI)	4000K	5100lm	3400	074-7719
90W (2×DALI)	3000K	7420lm	3400	074-7729
	4000K	7630lm		
	3000K	9890lm		
	4000K	10180lm		



BLACKBOARD WALLWASHER / INDIRECT				
SYS. POWER	COLOUR TEMP.	LUM. FLUX	L (mm)	ORDER CODE
79W (2×DALI)	3000K	↓ 4940 / ± 3780lm	1700	074-7736
127W (3×DALI)	4000K	↓ 5090 / ± 4000lm	3400	074-7749
150W (3×DALI)	3000K	↓ 7420 / ± 7680lm	3400	074-7759
	4000K	↓ 7630 / ± 8130lm		
	3000K	↓ 9890 / ± 7680lm		
	4000K	↓ 10180 / ± 8130lm		

Accessories

END CAPS	
TYPE	ORDER CODE
end caps (pair)	074-609001

LINEAR CONNECTOR	
TYPE	ORDER CODE
mechanical linear connector ceiling	074-6091110

CEILING FASTENER / CABLE SUSPENSION / POWER FEEDER		
TYPE	L (mm)	ORDER CODE
ceiling fastener	10	050-204121
cable suspension	1500	005-2152110
canopy / feeder cable 5 × 1.5 mm²	1500	005-221241
through wire 5 × 1.5 mm² (10 pieces)		004-90005

more accessories see page 841

← back

Order options

COLOUR TEMPERATURE	
3000K	5
4000K	6

CONTROL	
DALI-2	

MATERIAL COLOUR	
○ pure white RAL 9010	7
● jet black RAL 9005	8

LIGHT OPTIC COVER	
reflector (UGR ≤ 16)	

Options on request

COLOUR RENDERING INDEX	
CRI ≥ 90	
CRI ≥ 98 XPECTRUM	

BETO curve ceiling/suspended system

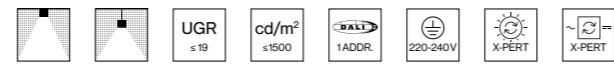
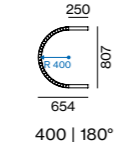
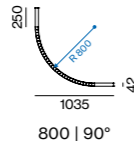
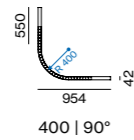

DIRECT				
SYS. POWER	COLOUR TEMP.	LUM. FLUX	R (mm)	ORDER CODE
26.1W	3000K	3470 lm	400 90°	0 7 4 - 7 1 0 1 :: 3
	4000K	3680 lm		
26.1W	3000K	3470 lm	800 90°	0 7 4 - 7 1 0 3 :: 3
	4000K	3680 lm		
26.1W	3000K	3470 lm	400 180°	0 7 4 - 7 1 0 2 :: 3
	4000K	3680 lm		



DIRECT / INDIRECT POWER				
S. POWER	COLOUR TEMP.	LUM. FLUX	R (mm)	ORDER CODE
57W	3000K	↓ 3470 / ↑ 3860 lm	400 90°	0 7 4 - 7 1 3 1 :: 3
	4000K	↓ 3680 / ↑ 4080 lm		
57W	3000K	↓ 3470 / ↑ 3860 lm	800 90°	0 7 4 - 7 1 3 3 :: 3
	4000K	↓ 3680 / ↑ 4080 lm		
57W	3000K	↓ 3470 / ↑ 3860 lm	400 180°	0 7 4 - 7 1 3 2 :: 3
	4000K	↓ 3680 / ↑ 4080 lm		

BETO s-line ceiling/suspended system

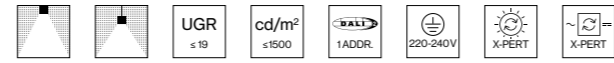
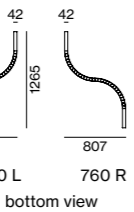
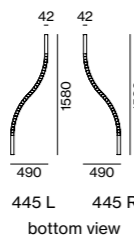
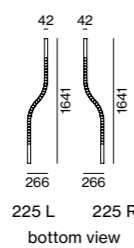

DIRECT				
SYS. POWER	COLOUR TEMP.	LUM. FLUX	TYPE	ORDER CODE
26.1W	3000K	3470 lm	225 L	0 7 4 - 7 2 0 1 :: 3
	4000K	3680 lm		
26.1W	3000K	3470 lm	225 R	0 7 4 - 7 2 0 2 :: 3
	4000K	3680 lm		
26.1W	3000K	3470 lm	445 L	0 7 4 - 7 2 0 5 :: 3
	4000K	3680 lm		
26.1W	3000K	3470 lm	445 R	0 7 4 - 7 2 0 6 :: 3
	4000K	3680 lm		
26.1W	3000K	3470 lm	760 L	0 7 4 - 7 2 0 3 :: 3
	4000K	3680 lm		
26.1W	3000K	3470 lm	760 R	0 7 4 - 7 2 0 4 :: 3
	4000K	3680 lm		



DIRECT / INDIRECT POWER				
S. POWER	COLOUR TEMP.	LUM. FLUX	TYPE	ORDER CODE
57W	3000K	↓ 3470 / ↑ 3860 lm	225 L	0 7 4 - 7 2 3 1 :: 3
	4000K	↓ 3680 / ↑ 4080 lm		
57W	3000K	↓ 3470 / ↑ 3860 lm	225 R	0 7 4 - 7 2 3 2 :: 3
	4000K	↓ 3680 / ↑ 4080 lm		
57W	3000K	↓ 3470 / ↑ 3860 lm	445 L	0 7 4 - 7 2 3 5 :: 3
	4000K	↓ 3680 / ↑ 4080 lm		
57W	3000K	↓ 3470 / ↑ 3860 lm	445 R	0 7 4 - 7 2 3 6 :: 3
	4000K	↓ 3680 / ↑ 4080 lm		
57W	3000K	↓ 3470 / ↑ 3860 lm	760 L	0 7 4 - 7 2 3 3 :: 3
	4000K	↓ 3680 / ↑ 4080 lm		
57W	3000K	↓ 3470 / ↑ 3860 lm	760 R	0 7 4 - 7 2 3 4 :: 3
	4000K	↓ 3680 / ↑ 4080 lm		

Light distribution

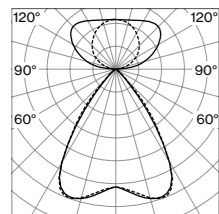

reflector (UGR ≤ 16)
direct / indirect power

LUMINOUS FLUX value calculated for CRI ≥ 80, colour white, reflector chrome

Order options

MATERIAL COLOUR	
○ pure white RAL 9010	7
● jet black RAL 9005	8

Accessories

END CAPS		ORDER CODE
TYPE	end caps (pair)	0 7 4 - 6 0 9 0 0 1

LINEAR CONNECTOR		ORDER CODE
TYPE	mechanical linear connector suspended	0 7 4 - 6 0 9 1 1 2 0
incl. 1500mm cable suspension		

CORNER CONNECTOR 90°		ORDER CODE
TYPE	corner connector 90°	0 7 4 - 6 0 9 1 2 1
incl. through wire 5 × 1.5 mm ² ; order two mechanical linear connectors separately		

BLIND COVER		ORDER CODE
TYPE	blind cover 250 mm	0 7 4 - 6 0 9 9 1 0
	blind cover 500 mm	0 7 4 - 6 0 9 9 1 1
order 1 × blind cover 500 mm for each linear connector and 1 × 250 mm for each end		

CABLE SUSPENSION / CANOPY / THROUGH WIRE		
TYPE	L (mm)	ORDER CODE
cable suspension	1500	0 0 5 - 2 1 5 2 1 1 0
canopy / feeder cable 5 × 1.5 mm ²	1500	0 0 5 - 2 2 1 2 4 1
through wire 5 × 1.5 mm ² (10 pieces)		0 0 4 - 9 0 0 0 5
for electrical system configuration see luminaire data sheet at xal.com		

Arrangement examples (top view)

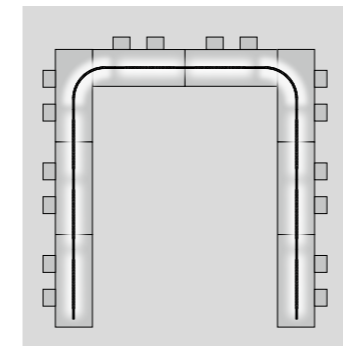

BETO CURVE 90
conference/seminar

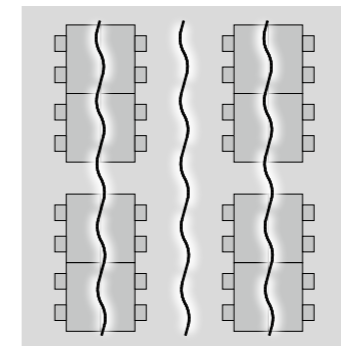

BETO S-LINE 445
office

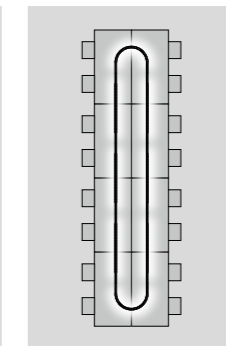

BETO CURVE 180
conference/seminar

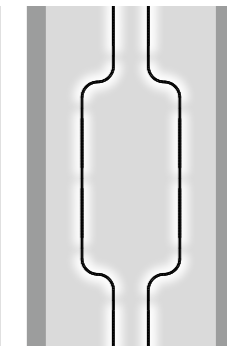

BETO S-LINE 760
corridor

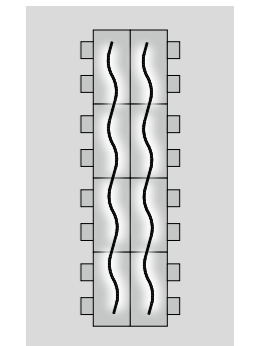

BETO S-LINE 445
conference/seminar

Technical data (top view)

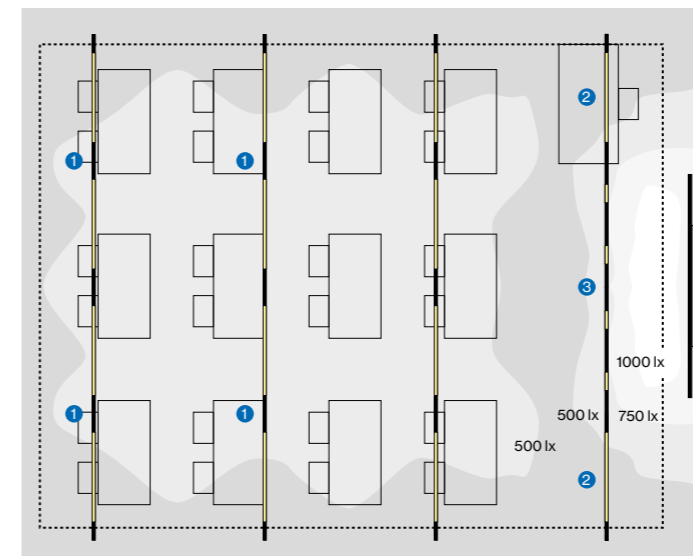

- 1 BETO 3400 ceiling system, 52 W, 4000 K
- 2 BETO 1700 ceiling system, 26.1 W, 4000 K
- 3 BETO 3400 blackboard ceiling system, 90 W, 4000 K

ROOM VALUES		CALCULATION SURFACE	
Room dimensions	9.5 × 7.5 × 3 m	Surface dimensions	8.5 × 6.5
Reflection factor	0.7 0.5 0.2	Surface height	0.75
Maintenance factor	0.8	Average illuminance (E _v)	> 500 lx
Mounting height	3 m	Uniformity (U ₀)	> 0.6

GLARE EVALUATION	
Table Classification X=4H Y=8H S=0.25H	
UGR transversal	≤ 19
UGR axial	≤ 19

Office
Visualisation





Creative Lab Barcelona, ES –
lighting design by MMAS Lighting
tables designed by James Burleigh



F+P Architekten ZT GmbH
Vienna, AT – by F+P Architekten ZT
GmbH with lighting design by Ing.
Gerald Pummer, Illuminazione



Office Inarto Architecten
Herentals, BE – by Inarto Architecten



The art of round efficiency

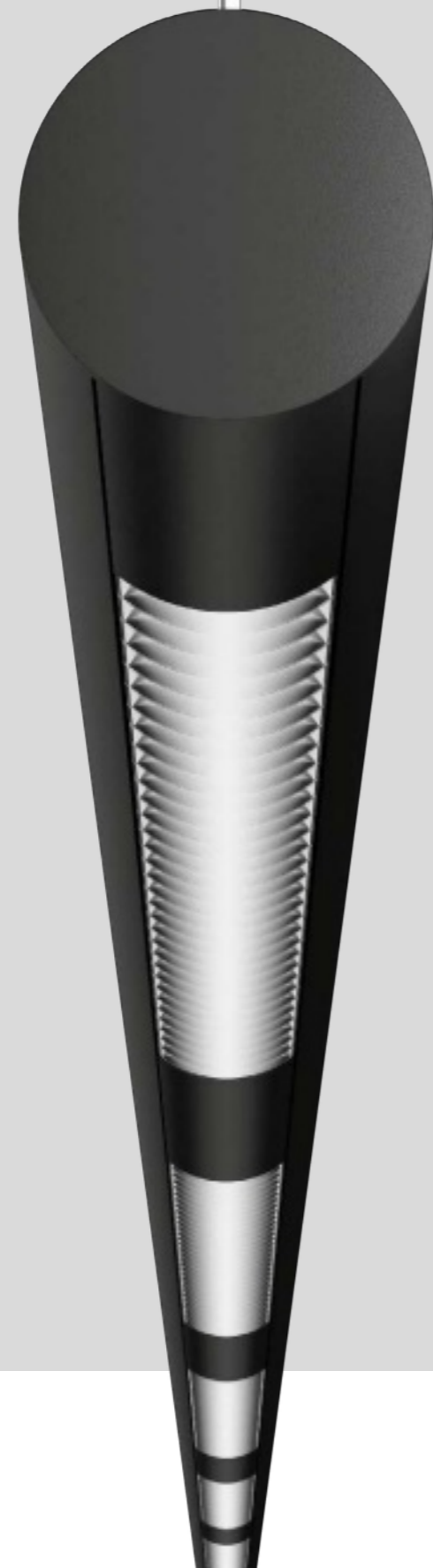

SETA system

EN The SETA system luminaire is perfect for bespoke office needs with a choice of straight or angular elements that can be arranged in any order. The minimalist yet powerful luminaire is available in ceiling-mounted or suspended system versions. Particularly noteworthy are the reflectors optimised for office spaces, which were designed specifically for working on screens. The indirect light component creates a pleasant, homogeneous ceiling illumination for every work area. The SETA System luminaire is also available on request with presence and brightness sensors, and in the light colours 3000 K, 4000 K, and, depending on the version, also in Tunable White.

DE Die Systemleuchte SETA ist mit wahlweise geraden oder eckigen Elementen, welche beliebig aneinandergereiht werden können, perfekt für individuelle Office-Bedürfnisse. Die minimalistische, aber dennoch leistungsstarke Leuchte ist als Deckenanbau- oder als abgehängte System-Variante erhältlich. Besonders hervorzuheben sind die eigens für Büroräumlichkeiten optimierten Reflektoren, welche speziell für die Arbeit an Bildschirmen konzipiert wurden. Durch den Indirektlichtanteil entsteht eine für jeden Arbeitsbereich angenehme, homogene Deckenaufhellung. Die SETA Systemleuchte ist auf Wunsch auch mit Anwesenheits- und Helligkeitssensoren und in den Lichtfarben 3000 K, 4000 K sowie je nach Variante auch in Tunable White erhältlich.

Types

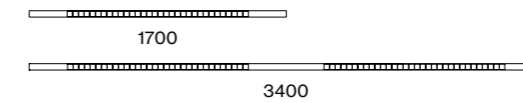

Mountings

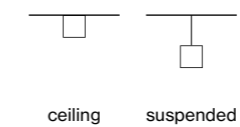

ceiling suspended

Configurations

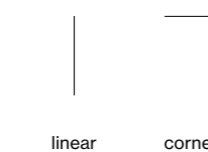

linear corner

Light distributions

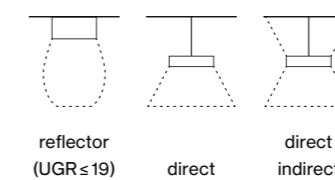

reflector
(UGR ≤ 19) direct direct
indirect

Work-friendly light

EN As an office luminaire, SETA guarantees illumination that is compliant with workplace standards (up to $UGR \leq 16$). Custom glare-free reflectors and the selected use of blind covers direct the light precisely to the work surface and reduce reflections. The direct/indirect version comes with special lens technology that distributes the indirect light component homogeneously and broadly towards the ceiling.

DE SETA als Office-Leuchte garantiert eine normgerechte Ausleuchtung von Arbeitsplätzen (bis zu $UGR \leq 16$). Speziell entblendete Reflektoren und der gezielte Einsatz von Blind-Covers richten das Licht zielgenau auf die Arbeitsfläche und reduzieren Spiegelungen. Bei der direkt/indirekt Variante, verteilt eine spezielle Linsentechnik den sehr breit ausstrahlenden Indirektlichtanteil homogen an der Decke.



Advanced sensor technology

EN SETA System is equipped with a DALI sensor and can be controlled as a network. A presence sensor controls the light at the workstation depending on whether anyone is in the vicinity. If desks, rooms, or corridors are unoccupied, the light automatically switches off after a defined delay. This saves energy and extends the service life. A brightness sensor adjusts the light intensity to the ambient brightness.

DE Ausgestattet mit einem DALI-Sensor kann SETA System als Netzwerk gesteuert werden. Ein Anwesenheitssensor regelt abhängig von der Präsenz einer Person das Licht am Arbeitsplatz. Damit schaltet sich das Licht bei unbesetzten Schreibtischen, Räumen oder Gängen nach einer definierten Nachlaufzeit automatisch aus. Das spart Energie und erhöht die Lebensdauer. Zusätzlich passt ein Helligkeitssensor die Lichtstärke an die Umgebungshelligkeit an.



Lines & edges

EN SETA System comes as a suspended luminaire with straight and angular system elements. Thus, SETA offers a lighting solution that fits into any lighting design concept. Optionally with an indirect light component, the light is distributed homogeneously across the ceiling and creates a pleasant room atmosphere.

DE SETA System steht als abgehängte Leuchte mit geradlinigen und eckigen Systemelementen zur Verfügung, so bietet SETA eine Lichtlösung, die sich in jedes Lichtplanungskonzept einfügt. Optional mit Indirektlichtanteil wird das Licht homogen an der Decke verteilt und erzeugt eine angenehme Raumatmosphäre.

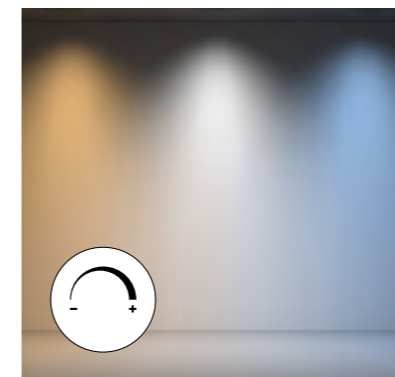

TW – Tunable White

EN Changes in the colour of light have a substantial effect on our mood. Tunable White allows the colour temperature to be continuously adjusted from 2700 K (warm light) to 6500 K (cool light) to dynamically adapt the lighting to the time of day or ambient brightness.

DE Veränderungen in der Lichtfarbe haben eine starke Wirkung auf unsere Stimmung. Tunable White ermöglicht die stufenlose Verschiebung der Farbtemperatur von 2700 K (warmes Licht) bis 6500 K (kühles Licht), um die Beleuchtung dynamisch an Uhrzeit oder Umgebungshelligkeit anzupassen.

Full-spectrum LED

EN XAL's new XPECTRUM LEDs deliver healthy, biologically effective light. The reduced blue light component and increased cyan values reduce the blue light hazard for the eye to daylight-equivalent levels. The resulting non-visual, so-called melanopic light effect, improves concentration and increases sleep quality. The excellent colour rendering of IES TM 30-15 $R_f = 98$ and $R_g = 101$ further helps visual comfort.

DE Die neue XPECTRUM LED von XAL sorgt für gesundes, biologisch wirksames Licht. Der reduzierte Blaulichtanteil sowie die erhöhten Cyan-Werte minimieren die Blaulichtgefahr für das Auge auf ein tageslichtähnliches Niveau. Die daraus resultierende nichtvisuelle, auch melanopische Lichtwirkung genannt, fördert die Konzentration und steigert die Schlafqualität. Die hervorragende Farbwiedergabe von IES TM 30-15 $R_f = 98$ und $R_g = 101$ ermöglicht zudem einen verbesserten Sehkomfort.

XPECTRUM LED

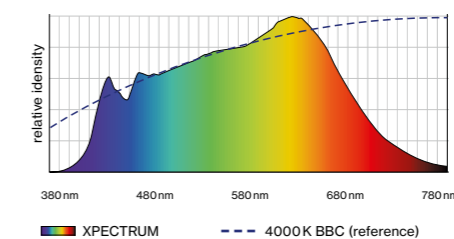

Commercially available LED 4000 K

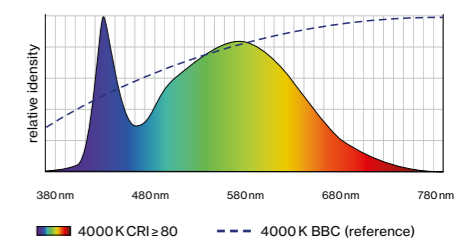

← back



SETA system

ceiling / suspended

EN Luminaire housing from extruded aluminium profile, round design (only $\varnothing 61\text{mm}$); no visible screws; for lighting systems; linear; powder coated; pendant fitting with cable suspension; height adjustment without tools; with transparent feeder cable; extruded profile for improved thermal management; high-gloss reflector with faceted design; direct or direct/indirect light distribution; indirect light component with integrated PC boards and high-quality lens system for max., homog. ceiling illumination, separately controllable; energy-eff. LEDs – very good colour rendering

DE Leuchtenkörper aus Aluminiumstrangpressprofil, runde Ausführung (nur $\varnothing 61\text{mm}$); keine sichtbaren Schrauben; für Lichtsysteme; linear; pulverbeschichtet; abgependelt mit Seilabhängung; werkzeuglose Höhenverstellung; inkl. transp. Einspeiseleitung; Strangpressprofil für verbessertes Thermomanagement; hochglänzender Reflektor mit Facettenoptik; direkte bzw. direkt/indirekte Abstrahlcharakteristik; Indirektlichtanteil mit eigenen Platinen u. hochwertiger Linsenoptik für max., homog. Deckenaufhellung, separat steuerbar; energieeff. LEDs – sehr gute Farbwiedergabe

Quickinfo

3000K, 4000K, TW
 CRI ≥ 80 , 3 SDCM
 UGR ≤ 19 / $65^\circ \leq 1500\text{cd/m}^2$
 L 3400 direct up to 136lm/W
 L 3400 D/I up to 140lm/W
 L90 @ 50 000h
 DALI-2, DALI sensor
 reflector (UGR ≤ 19)

Types

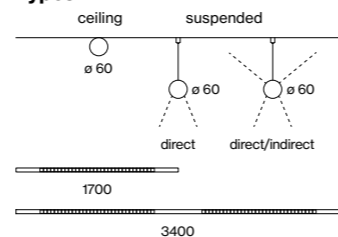

Colours



Light distributions



DiiA® standards
251, 252, 253



special end cap design



corner connector

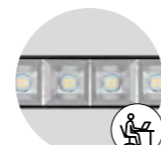

DIN EN 12464-1 UGR ≤ 19



single luminaire (p. 486)

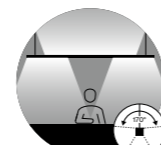

glare-free direct and 170° indirect illumination



tunable white 2700–6500 K

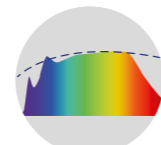

CRI ≥ 98 XPECTRUM

Order options

COLOUR TEMPERATURE	
3000K	5
4000K	6
tunable white 2700–6500 K*	
*DALI-2 DT8	

CONTROL	
DALI-2	3
DALI sensor*	7
*brightness & presence only 3400 mm	

MATERIAL COLOUR	
white	7
black	8

LIGHT OPTIC COVER	
reflector (UGR ≤ 19)	

Options on request

COLOUR RENDERING INDEX	
CRI ≥ 90	
CRI ≥ 98 XPECTRUM	

MATERIAL COLOUR	
grey	

Light distribution

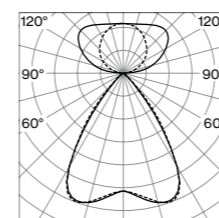

reflector (UGR ≤ 19)
direct/indirect power

LUMINOUS FLUX value calculated for CRI ≥ 80 , colour white, reflector chrome

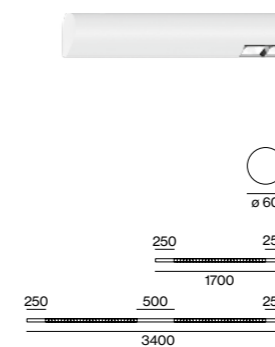

SETA ceiling/suspended system

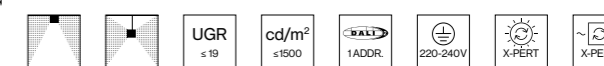

LINEAR DIRECT				
SYS. POWER	COLOUR TEMP.	LUM. FLUX	L (mm)	ORDER CODE
26.1W (1×DALI)	3000K	3340lm	1700	074-5006
52W (2×DALI)	4000K	3540lm		
	3000K	6680lm	3400	074-5009
	4000K	7080lm		

SETA suspended system

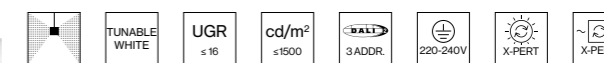

LINEAR DIRECT / INDIRECT POWER				
SYS. POWER	COLOUR TEMP.	LUM. FLUX	L (mm)	ORDER CODE
57W (2×DALI)	3000K	3350 / 3790lm	1700	074-5036
	4000K	3540 / 4020lm		
109W (3×DALI)	3000K	6690 / 7590lm	3400	074-5039
	4000K	7080 / 8040lm		
109W (3×DALI)	3000K	6690lm	3400	074-50D95
	2700–6500K	6810lm		
109W (3×DALI)	4000K	7080lm	3400	074-50D96
	2700–6500K	6810lm		

Accessories

END CAPS		ORDER CODE
TYPE	end caps (pair)	074-509001

LINEAR CONNECTOR / CORNER CONNECTOR 90°		ORDER CODE
TYPE	mechanical linear connector ceiling	074-5091110
	mechanical linear connector suspended*	074-6091120
	corner connector 90°**	074-5091210

* incl. 1500 mm cable suspension; ** incl. through wire 5 × 1.5 mm²; order two mechanical linear connectors separately

BLIND COVER		ORDER CODE
TYPE	blind cover 250 mm	074-509910
	blind cover 500 mm	074-509911

order 1 × blind cover 500 mm for each linear connector and 1 × 250 mm for each end

CEILING FASTENER		ORDER CODE
TYPE	ceiling fastener	050-204121

CABLE SUSPENSION / CANOPY / THROUGH WIRE		ORDER CODE
TYPE	cable suspension	005-2152110
	canopy / feeder cable 5 × 1.5 mm ²	005-221241
	through wire 5 × 1.5 mm ² (10 pieces)	004-90005

for electrical system configuration see luminaire data sheet at xal.com

Office
Visualisation





Quality along the line



LENO system

EN The extremely flat LENO profile luminaire is surprisingly versatile. It is available as a recessed, semi-recessed, or surface-mounted version for wall or ceiling mounting, in a suspended version. LENO and its microprismatic cover create ideal work light. The version with an opal cover is best suited for homogeneous room lighting. The variant with asymmetrical beam distribution illuminates walls homogeneously. LENO Jut-Out adds further ceiling illumination by employing discreet lateral radiation. By simply fixing the insets magnetically, assembly is quick and flexible.

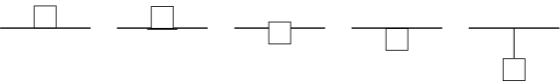
DE Die extrem flache Profilleuchte LENO überrascht durch ihre Vielseitigkeit. Sie ist als Einbau-, Halbeinbau- oder Anbauvariante für die Wand- bzw. Deckenmontage und in abgehängter Version. Mit mikroprismatischer Abdeckung schafft LENO bestes Arbeitslicht. Die Variante mit Opal-Cover eignet sich für homogene Raumausleuchtung. In der Variante mit asymmetrischer Abstrahlung werden Wände homogen beleuchtet, während LENO Jut-Out durch dezente seitliche Abstrahlung eine zusätzliche Deckenaufhellung erzeugt. Indem die Insets einfach magnetisch fixiert werden, erfolgt die Montage schnell und flexibel.

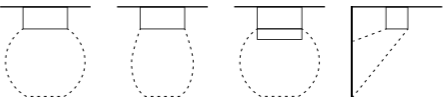
Type	
	90
Mountings	
	trimless recessed trim recessed semi-recessed surface suspended
Configuration	
	linear
Light distributions	
	opal microprismatic (UGR ≤ 19) jut-out wallwasher

Magnetic attachment

EN Simple and utterly tool-free installation: LENO luminaire insets are magnetically fixed in the profile. The patented system saves time and money when installing the luminaire.

DE Einfache und vollkommen werkzeuglose Montage: LENO Leuchteneinsätze werden magnetisch im Profil fixiert. Durch das patentierte System kann beim Einbau der Leuchte zusätzlich Zeit und Geld gespart werden.



Slim and efficient

EN Innovative lighting technology, minimal profile heights. The extremely flat flush-mounted variants, both with and without a trim, match the height of plasterboard. They are therefore easily mounted on any ceiling, regardless of its substructure. This grants maximum design freedom with a slim appearance and impressive efficiency.

DE Innovative Lichttechnik, minimale Profilhöhen. Die extrem flachen Einbauvarianten mit oder ohne Rand sind gerade so hoch wie eine Gipskartonplatte. Dadurch können sie an jeder Decke, unabhängig von ihrer Unterstruktur, problemlos montiert werden. Größter Gestaltungsfreiraum bei einer schlanken Erscheinung und beeindruckender Effizienz.

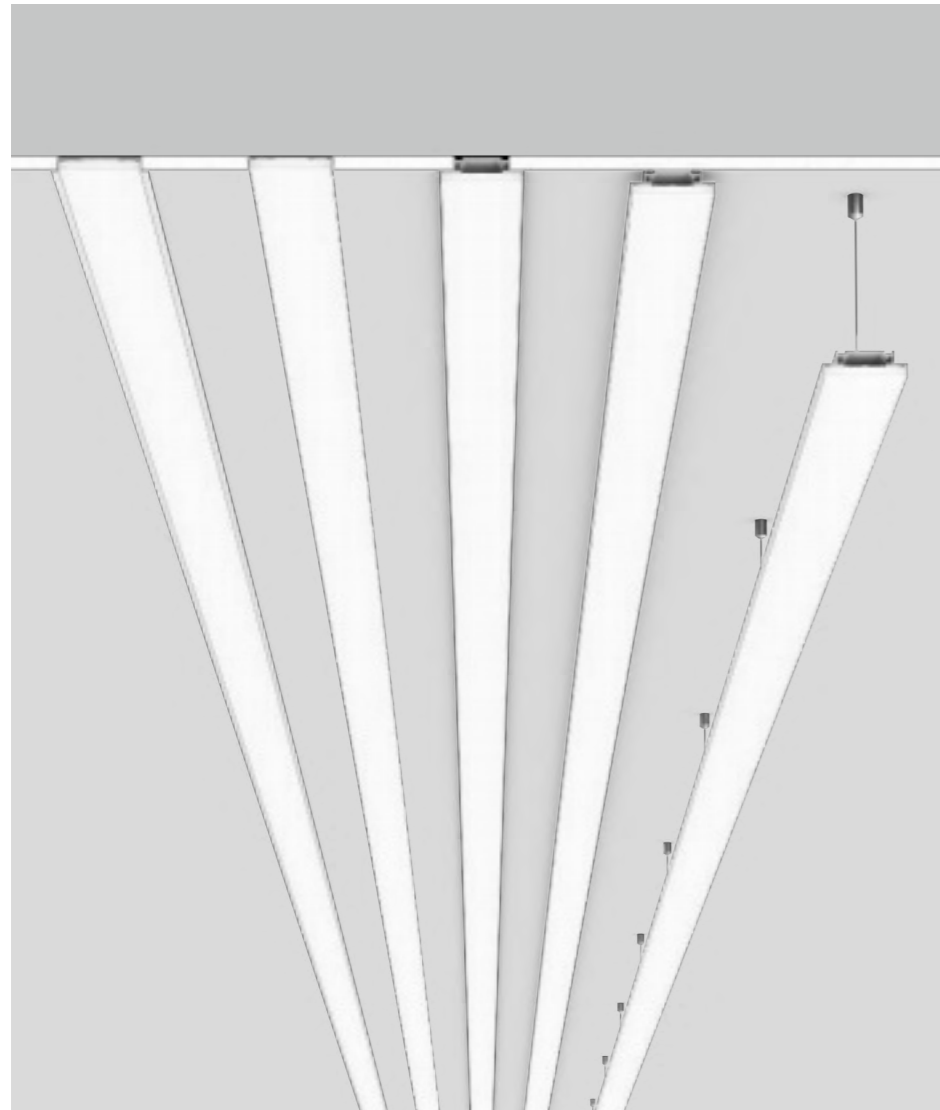
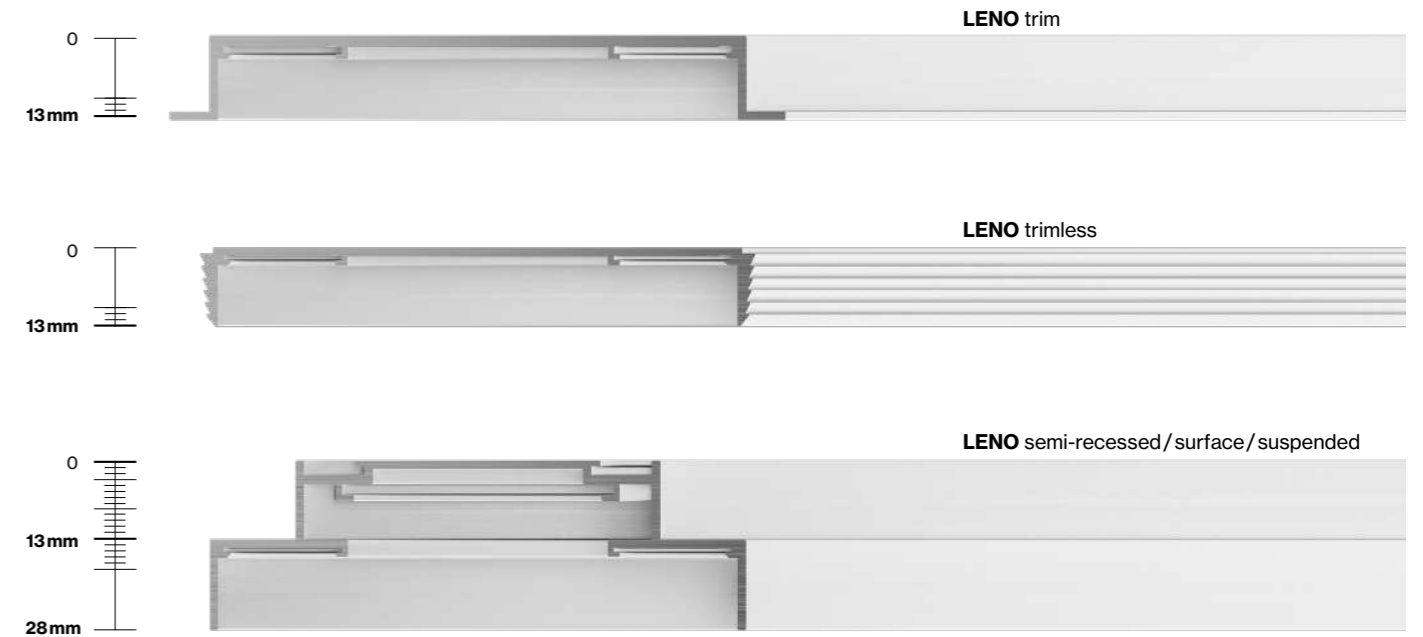

Variety

EN Available for installation in plasterboard ceilings, suspended, or as a surface-mounted variant, this exceptionally flat profile luminaire has precise, homogeneously illuminated edges and can be used in a variety of ways. Choose between the high-performance Opal Cover inset for homogeneous illumination, the workplace-compatible micro-prismatic cover ($UGR \leq 19$) or the opal Jut-Out version for improved room and ceiling illumination. Different lengths and optional asymmetrical light distribution complete the range.

DE Ob für den Einbau in Gipskartondecken, abgehängt oder als Anbauvariante: Die extrem flache Profilleuchte mit präzisen, homogen ausgeleuchteten Kanten ist vielfältig einsetzbar. Bei den Einsätzen kann zwischen dem High Performance Opal Cover für eine homogene Ausleuchtung, der arbeitsplatztauglichen mikropismatischen Abdeckung ($UGR \leq 19$) oder der opalen Jut-Out Variante für eine bessere Raum- und Deckenaufhellung gewählt werden. Verschiedene Längen und eine optional asymmetrische Lichtverteilung komplettieren die Vielfalt.



Single or system

EN LENO is flexible and available in four lengths, and as a system luminaire in any length. Depending on requirements, the elements are simply mechanically connected – tailored to match the design of the interior. LENO can create a particularly powerful, continuous lighting system, granting maximum freedom of design.

DE LENO ist flexibel und in vier Längen sowie als Systemleuchte in beliebiger Länge erhältlich. Je nach Anforderung werden die Elemente einfach mechanisch verbunden – individuell passend zum Design des Innenraums. Mit LENO lässt sich auch ein besonders wirkungsvolles, durchgehendes Lichtsystem gestalten, wodurch maximale Gestaltungsfreiheit geschaffen wird.

← back

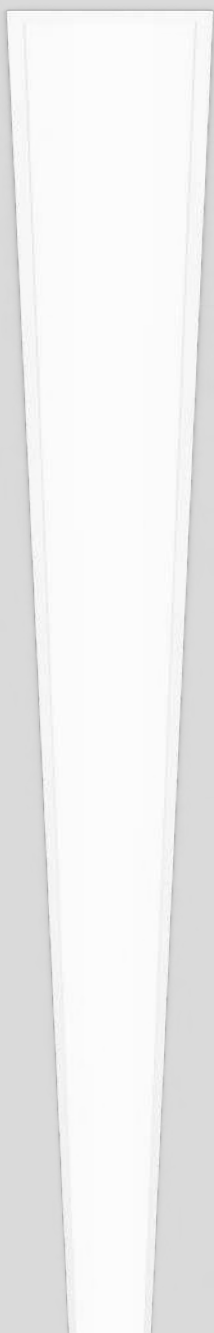

LENO system

recessed with trim

EN Low profile recessed channel; suitable for installation in 12.5mm ceilings, with trim; suitable for wall or ceiling mounting; for continuous lighting systems; surface powder coated; easy mounting without need to cut the substructure; fall-safe light inset made of extruded aluminium profile, can be inserted in the canal without tools by magnetic holders; side coupled light, directed downwards by LGP body (Light Guiding Prism) and highly efficient reflector; homogeneously illuminated, satinised (flush or jut-out) or microprismatic PMMA cover; optional with asymmetric light distribution; energy-eff. LEDs – very good colour rendering; incl. external converter for ceiling insertion

DE Extrem flacher Einbaukanal; geeignet für den Einbau in 12,5mm Decken, mit umlaufendem Rand; geeignet für die Wand- oder Deckenmontage; für durchgehende Lichtsysteme; Oberfläche pulverbeschichtet; einfache Montage ohne Schneiden der Unterkonstruktion; absturzsicherer Licht-einsatz aus stranggepresstem Aluminiumprofil werkzeuglos mittels Magnethalter in Kanal einsetzbar; seitlich eingekoppeltes Licht durch LGP-Body (Light-Guiding-Prism) und hocheffizientem Reflektor nach unten gelenkt; homogen ausgeleuchtete, satinierte (bündig oder herausragend) oder mikroprismatische Abdeckung aus PMMA; optional mit asymmetrischer Lichtverteilung; energieeff. LEDs – sehr gute Farbwiedergabe; inkl. externem Konverter für Deckeneinwurf

Quickinfo

3000K, 4000K
 CRI ≥ 80, 3 SDCM
 up to 137lm/W
 L90 @ 50 000h
 DALI-2
 opal, microprismatic (UGR ≤ 19),
 jut-out, asymmetric wallwasher

Types

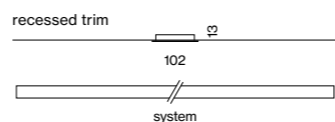

Colour



Light distributions

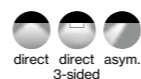

Order options

COLOUR TEMPERATURE	
3000K	5
4000K	6

CONTROL

DALI-2

MATERIAL COLOUR

○ traffic white RAL 9016

LIGHT OPTIC COVER

opal high performance	H
microprismatic (UGR ≤ 19)	G
jut-out	J
asymmetric	A

Options on request

COLOUR RENDERING INDEX

CRI ≥ 90

EMERGENCY LIGHT

1h accupack
 3h accupack

LENO trim

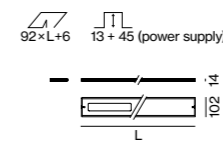

INSTALLATION CHANNEL

TYPE	L (mm)	ORDER CODE
channel	613	051-8910067
channel	1221	051-8910127
channel	1830	051-8910187
channel	2438	051-8910247

order installation channel, light inset + mounting accessories separately



LIGHT INSET

SYS. POWER (OPAL, MP, JUT-OUT / ASYM.)	L (mm)	ORDER CODE
10.8W/15.6W	612	051-8012370
19.1W/31W	1220	051-8014370
28.6W/47W	1828	051-8016370
38W/62W	2436	051-8018370

COVER	COLOUR TEMP.	SYSTEM POWER	DELIVERED LUMENS	EFFICACY
opal high	3000K	17.6 W/m	2010 lm/m	129 lm/W
performance	4000K		2130 lm/m	137 lm/W
microprismatic	3000K	17.6 W/m	1900 lm/m	122 lm/W
UGR ≤ 19	4000K		2010 lm/m	129 lm/W
jut-out	3000K	17.6 W/m	1930 lm/m	124 lm/W
	4000K		2040 lm/m	131 lm/W
asymmetric	3000K	25.5 W/m	2580 lm/m	101 lm/W
	4000K		2730 lm/m	107 lm/W

Accessories



END CAPS

TYPE	ORDER CODE
end caps (pair)	051-8991217



LINEAR CONNECTOR

TYPE	ORDER CODE
linear connector (pair)	051-8990110
linear connector (10 pairs)	051-8990110.10



DISMOUNTING TOOL

TYPE	ORDER CODE
vacuum cup	086-30000

Light distribution

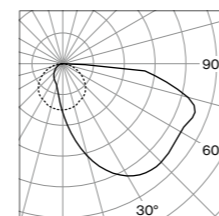

asymmetric

LUMINOUS FLUX value calculated for colour white, cover opal microprismatic -5%, jut-out-4%



DiiA® standards
 251, 252, 253



single luminaire
 (p. 492)

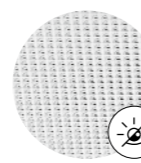

microprismatic
 UGR ≤ 19



quick
 installation

Technical data

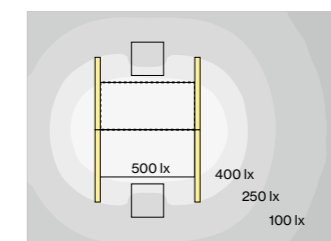

LENO trim, microprismatic,
 19.1W, 4000K

ROOM VALUES	
Room dimensions	5.4 × 4 × 2.8m
Reflection factor	0.7 0.5 0.2
Maintenance factor	0.8

CALCULATION SURFACE	
Surface dimensions	1.6 × 0.8
Surface height	0.75
Average illuminance (E _a)	> 500 lx
Uniformity (U ₀)	> 0.6

GLARE EVALUATION	
Table Classification X=4H Y=8H S=0.25H	
UGR transveral	≤ 19
UGR axial	≤ 19

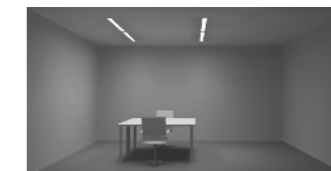



Vaucluse House Sydney, AU –
by EST Lighting



← back



LENO system

recessed trimless

EN Low profile recessed channel; for trimless installation in 12.5 mm plasterboard ceilings; wall or ceiling mounting; for lighting systems; powder coated; special edge design with grooves for better adhesion of filler; easy mounting without need to cut the substructure; fall-safe light inset made of extruded aluminium profile, can be inserted in the canal without tools by magnetic holders; side coupled light, directed downwards by LGP body (Light Guiding Prism) and highly efficient reflector; homogeneously illuminated, satinised (flush or jut-out) or microprismatic PMMA cover; optional asym. light distribution; energy-eff. LEDs – very good colour rendering; external converter for ceiling insertion

DE Extrem flacher Einbaukanal; für randlosen Einbau in 12,5 mm Gipskartondecken; Wand- oder Deckenmontage; für Lichtsysteme; pulverbeschichtet; spezielle Randausbildung mit Rillen für bessere Haftung der Spachtelmasse; einfache Montage ohne Schneiden der Unterkonstruktion; absturzesicherer Lichteinsatz aus stranggepresstem Aluminiumprofil werkzeuglos mittels Magnethalter in Kanal einsetzbar; seitlich eingekoppeltes Licht durch LGP-Body (Light-Guiding-Prism) und hocheffizientem Reflektor nach unten gelenkt; homogen ausgeleuchtete, satinierte (bündig oder herausragend) oder mikroprismatische Abdeckung aus PMMA; optional asym. Lichtverteilung; energieeff. LEDs – sehr gute Farbwiedergabe; externer Konverter für Deckeneinwurf

Quickinfo

3000K, 4000K
 CRI ≥ 80, 3 SDCM
 up to 137lm/W
 L90 @ 50 000h
 DALI-2
 opal, microprismatic (UGR ≤ 19),
 jut-out, asymmetric wallwasher

Types

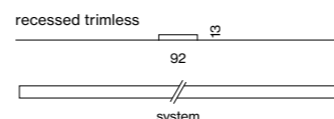

Colour



Light distributions

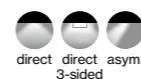

Order options

COLOUR TEMPERATURE	
3000K	5
4000K	6

CONTROL

DALI-2

MATERIAL COLOUR

○ traffic white RAL 9016

LIGHT OPTIC COVER

opal high performance	H
microprismatic (UGR ≤ 19)	G
jut-out	J
asymmetric	A

Options on request

COLOUR RENDERING INDEX

CRI ≥ 90

EMERGENCY LIGHT

1h accupack
 3h accupack

LENO trimless

INSTALLATION CHANNEL

TYPE	L (mm)	ORDER CODE
channel	613	051-8900067
channel	1221	051-8900127
channel	1830	051-8900187
channel	2438	051-8900247

order installation channel, light inset + mounting accessories separately



LIGHT INSET

SYS. POWER (OPAL, MP, JUT-OUT / ASYM.)	L (mm)	ORDER CODE
10.8W/15.6W	612	051-8012370
19.1W/31W	1220	051-8014370
28.6W/47W	1828	051-8016370
38W/62W	2436	051-8018370

COVER	COLOUR TEMP.	SYSTEM POWER	DELIVERED LUMENS	EFFICACY
opal high	3000K	17.6 W/m	2010 lm/m	129 lm/W
performance	4000K	17.6 W/m	2130 lm/m	137 lm/W
microprismatic	3000K	17.6 W/m	1900 lm/m	122 lm/W
UGR ≤ 19	4000K	17.6 W/m	2010 lm/m	129 lm/W
jut-out	3000K	17.6 W/m	1930 lm/m	124 lm/W
	4000K	17.6 W/m	2040 lm/m	131 lm/W
asymmetric	3000K	25.5 W/m	2580 lm/m	101 lm/W
	4000K	25.5 W/m	2730 lm/m	107 lm/W

Accessories

END CAPS	
TYPE	ORDER CODE
end caps (pair)	051-8990217

LINEAR CONNECTOR	
TYPE	ORDER CODE
linear connector (pair)	051-8990110
linear connector (10 pairs)	051-8990110.10

DISMOUNTING TOOL	
TYPE	ORDER CODE
vacuum cup	086-30000

Light distribution

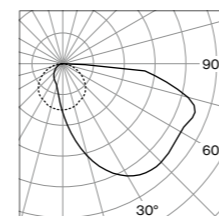

asymmetric

LUMINOUS FLUX value calculated for colour white, cover opal microprismatic -5%, jut-out-4%



DiiA® standards 251, 252, 253



single luminaire (p. 492)

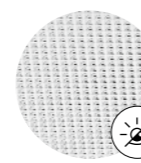

microprismatic UGR ≤ 19



quick installation

Technical data

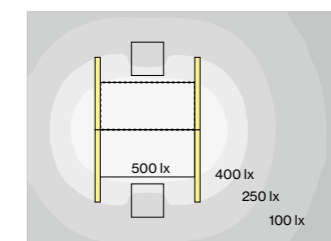

LENO trimless, microprismatic, 19.1W, 4000K

ROOM VALUES	
Room dimensions	5.4 × 4 × 2.8 m
Reflection factor	0.7 0.5 0.2
Maintenance factor	0.8

CALCULATION SURFACE	
Surface dimensions	1.6 × 0.8
Surface height	0.75
Average illuminance (E _{av})	> 500 lx
Uniformity (U ₀)	> 0.6

GLARE EVALUATION	
Table Classification X=4H Y=8H S=0.25H	
UGR transversal	≤ 19
UGR axial	≤ 19

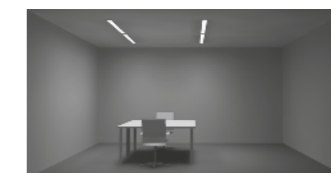

**Office Gemüsekiye**

Kramsach, AT –

by STUDIODESIGN, Herbert Lanzinger KG



← back



LENO system

semi-recessed

EN Low profile recessed mounted luminaire, 15 mm visible height; suitable for wall or ceiling mounting; suitable for installation in primed or exposed concrete, in plasterboard constructions and in plastered walls or ceilings; designed for continuous lighting systems; surface powder coated; fall-safe light inset made of extruded aluminium profile, can be inserted in the canal without tools by magnetic holders; side coupled light, directed downwards by LGP body (Light Guiding Prism) and highly efficient reflector; homogeneously illuminated, satinised (flush or jut-out) or microprismatic PMMA cover; energy-efficient LEDs with very good colour rendering

DE Extrem flache Einbauleuchte mit 15 mm sichtbarer Höhe; geeignet für die Wand- oder Deckenmontage; geeignet für den Einbau in gespachtelten Beton oder Sichtbeton, in Gipskartonkonstruktionen und in verputzten Wänden oder Decken; ausgelegt für durchgehende Lichtsysteme; Oberfläche pulverbeschichtet; absturzgesicherter Lichteinsatz aus stranggepresstem Aluminiumprofil werkzeuglos mittels Magnethalter in Kanal einsetzbar; seitlich eingekoppeltes Licht durch LGP-Body (Light-Guiding-Prism) und hocheffizientem Reflektor nach unten gelenkt; homogen ausgeleuchtete, satinierte (bündig oder herausragend) oder mikroprismatische Abdeckung aus PMMA; energieeffiziente LEDs mit sehr guter Farbwiedergabe



Quickinfo

3000K, 4000K
 CRI ≥ 80, 3 SDCM
 up to 137lm/W
 L90 @ 50 000h
 DALI-2
 opal, microprismatic (UGR ≤ 19),
 jut-out

Types

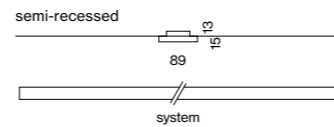

Colours



Light distributions



Order options

COLOUR TEMPERATURE	
3000K	5
4000K	6

CONTROL
 DALI-2

MATERIAL COLOUR	
○ traffic white RAL 9016	7
● jet black RAL 9005	8

LIGHT OPTIC COVER	
opal high performance	H
microprismatic (UGR ≤ 19)	G
jut-out	J

Options on request

COLOUR RENDERING INDEX
 CRI ≥ 90

Technical data

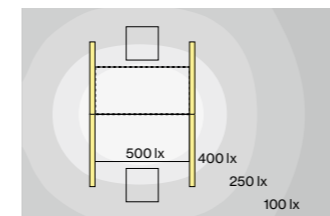

LENO semi-recessed,
 microprismatic, 19.1W, 4000K

ROOM VALUES	
Room dimensions	5.4 × 4 × 2.8m
Reflection factor	0.7 0.5 0.2
Maintenance factor	0.8

CALCULATION SURFACE	
Surface dimensions	1.6 × 0.8
Surface height	0.75
Average illuminance (E _m)	> 500 lx
Uniformity (U ₀)	> 0.6

GLARE EVALUATION	
Table Classification X=4H Y=8H S=0.25H	
UGR transversal	≤ 19
UGR axial	≤ 19

LUMINOUS FLUX value calculated for
 colour white, cover opal
 microprismatic -5 %, jut-out-4 %



DiiA® standards
 251, 252, 253



single luminaire
 (p. 496)

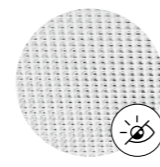

microprismatic
 UGR ≤ 19



quick
 installation

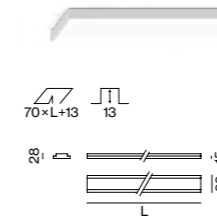

LENO semi-recessed

INSTALLATION CHANNEL		
TYPE	L (mm)	ORDER CODE
channel	613	05 1-892006
channel	1221	05 1-892012
channel	1830	05 1-892018
channel	2438	05 1-892024

order installation channel, light inset + mounting accessories separately



LIGHT INSET

SYSTEM POWER		L (mm)	ORDER CODE
10.8W		612*	05 1-811237
19.1W		1220	05 1-821437
28.6W		1828	05 1-821637
38W		2436	05 1-821837

*only available as end unit

COVER	COLOUR TEMP.	SYSTEM POWER	DELIVERED LUMENS	EFFICACY
opal high	3000K	17.6W/m	2010lm/m	129lm/W
performance	4000K		2130lm/m	137lm/W
microprismatic	3000K	17.6W/m	1900lm/m	122lm/W
UGR ≤ 19	4000K		2010lm/m	129lm/W
jut-out	3000K	17.6W/m	1930lm/m	124lm/W
	4000K		2040lm/m	131lm/W

Accessories

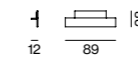

END CAPS		ORDER CODE
TYPE		
end caps mounting housing (pair)		05 1-8996210
end caps semi-recessed		05 1-899221



LINEAR CONNECTOR		ORDER CODE
TYPE		
linear connector (pair)		05 1-8992110
linear connector (10 pairs)		05 1-8992110.10

POWER FEEDER CONNECTOR 220-240V | 13A



POWER FEEDER CONNECTOR 220-240V 13A		ORDER CODE
TYPE		
power feeder connector		05 1-8992330

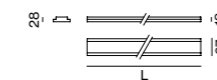

CONCRETE MOUNTING HOUSING		
L (mm)	UNIT	ORDER CODE
616	end	05 1-8960060
1224	start/end	05 1-8960120
1221	middle	05 1-8961120
1833	start/end	05 1-8960180
1830	middle	05 1-8961180
2441	start/end	05 1-8960240
2438	middle	05 1-8961240



DISMOUNTING TOOL		ORDER CODE
TYPE		
vacuum cup		086-30000



Jungheinrich Hauptverwaltung
Hamburg, DE –
by reichardt+partner architekten



← back



LENO system

surface

EN Low profile surface mounted luminaire, 28mm total height; suitable for wall or ceiling mounting; designed for continuous lighting systems; surface powder coated; fall-safe light inset made of extruded aluminium profile, can be inserted in the canal without tools by magnetic holders; side coupled light, directed downwards by LGP body (Light Guiding Prism) and highly efficient reflector; homogeneously illuminated, satinised (flush or jut-out) or microprismatic PMMA cover; energy-efficient LEDs with very good colour rendering

DE Extrem flache Anbauleuchte mit 28 mm Gesamthöhe; geeignet für die Wand- oder Deckenmontage; ausgelegt für durchgehende Lichtsysteme; Oberfläche pulverbeschichtet; absturzesicherer Lichteinsatz aus stranggepresstem Aluminiumprofil werkzeuglos mittels Magnethalter in Kanal einsetzbar; seitlich eingekoppeltes Licht durch LGP-Body (Light-Guiding-Prism) und hocheffizientem Reflektor nach unten gelenkt; homogen ausgeleuchtete, satinierte (bündig oder herausragend) oder mikroprismatische Abdeckung aus PMMA; energieeffiziente LEDs mit sehr guter Farbwiedergabe



Quickinfo

3000K, 4000K
 CRI ≥ 80, 3 SDCM
 up to 137lm/W
 L90 @ 50 000h
 DALI-2
 opal, microprismatic (UGR ≤ 19),
 jut-out

Types

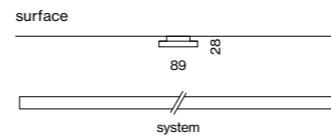

Colours



Light distributions



Order options

COLOUR TEMPERATURE	
3000K	5
4000K	6

CONTROL

DALI-2

MATERIAL COLOUR

○ traffic white RAL 9016	7
● jet black RAL 9005	8

LIGHT OPTIC COVER

opal high performance	H
microprismatic (UGR ≤ 19)	G
jut-out	J

Options on request

COLOUR RENDERING INDEX

CRI ≥ 90

Technical data

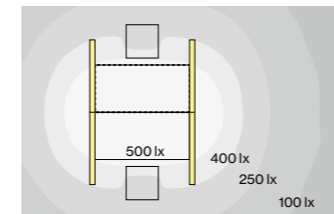

LENO surface, microprismatic,
 19.1W, 4000K

ROOM VALUES	
Room dimensions	5.4 × 4 × 2.8 m
Reflection factor	0.7 0.5 0.2
Maintenance factor	0.8

CALCULATION SURFACE	
Surface dimensions	1.6 × 0.8
Surface height	0.75
Average illuminance (E _m)	> 500 lx
Uniformity (U ₀)	> 0.6

GLARE EVALUATION

Table Classification X=4H Y=8H S=0.25H	
UGR transversal	≤ 19
UGR axial	≤ 19

LUMINOUS FLUX value calculated for
 colour white, cover opal
 microprismatic -5%, jut-out-4%

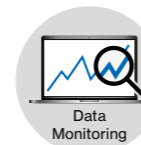

DiiA® standards
 251, 252, 253



single luminaire
 (p. 500)

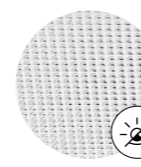

microprismatic
 UGR ≤ 19

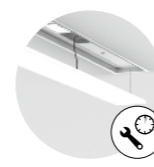

quick
 installation

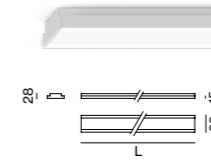

LENO surface

INSTALLATION CHANNEL

TYPE	L (mm)	ORDER CODE
channel	613	05 1-892006
channel	1221	05 1-892012
channel	1830	05 1-892018
channel	2438	05 1-892024

order installation channel, light inset + mounting accessories separately



LIGHT INSET

SYSTEM POWER	L (mm)	ORDER CODE
10.8W	612*	05 1-811237
19.1W	1220	05 1-821437
28.6W	1828	05 1-821637
38W	2436	05 1-821837

*only available as end unit

COVER	COLOUR TEMP.	SYSTEM POWER	DELIVERED LUMENS	EFFICACY
opal high performance	3000 K	17.6 W/m	2010 lm/m	129 lm/W
microprismatic UGR ≤ 19	4000 K	17.6 W/m	2130 lm/m	137 lm/W
jut-out	3000 K	17.6 W/m	1900 lm/m	122 lm/W
	4000 K		2010 lm/m	129 lm/W
	3000 K	17.6 W/m	1930 lm/m	124 lm/W
	4000 K		2040 lm/m	131 lm/W

Accessories

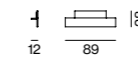

END CAPS

TYPE	ORDER CODE
end caps (pair)	05 1-899221



LINEAR CONNECTOR

TYPE	ORDER CODE
linear connector (pair)	05 1-899211
linear connector (10 pairs)	05 1-899211.10

POWER FEEDER CONNECTOR 220-240V | 13A

TYPE	ORDER CODE
power feeder connector	05 1-899233



DISMOUNTING TOOL

TYPE	ORDER CODE
vacuum cup	086-30000

← back



LENO system

suspended

EN Low profile suspended luminaire, 28 mm total height; pendant fitting with cable suspension; with integrated tool-less suspension height adjustment; incl. transparent feed; designed for continuous lighting systems; surface powder coated; fall-safe light inset made of extruded aluminium profile, can be inserted in the canal without tools by magnetic holders; side coupled light, directed downwards by LGP body (Light Guiding Prism) and highly efficient reflector; homogeneously illuminated, satinised (flush or jut-out) or microprismatic PMMA cover; energy-efficient LEDs with very good colour rendering

DE Extrem flache Pendelleuchte mit 28 mm Gesamthöhe; abgependelt mit Seilabhängung; werkzeuglose Höhenverstellung an der Leuchte; inkl. transparenter Einspeiseleitung; ausgelegt für durchgehende Lichtsysteme; Oberfläche pulverbeschichtet; absturzgesicherter Lichteinsatz aus stranggepresstem Aluminiumprofil werkzeuglos mittels Magnethalter in Kanal einsetzbar; seitlich eingekoppeltes Licht durch LGP-Body (Light-Guiding-Prism) und hocheffizientem Reflektor nach unten gelenkt; homogen ausgeleuchtete, satinierte (bündig oder herausragend) oder mikroprismatische Abdeckung aus PMMA; energieeffiziente LEDs mit sehr guter Farbwiedergabe



Quickinfo

3000K, 4000K
 CRI ≥ 80, 3 SDCM
 up to 137lm/W
 L90 @ 50 000h
 DALI-2
 opal, microprismatic (UGR ≤ 19),
 jut-out

Types

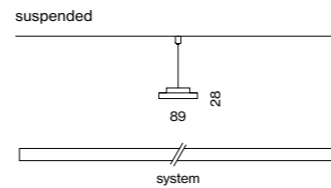

Colours



Light distributions



Order options

COLOUR TEMPERATURE	
3000K	5
4000K	6

CONTROL

DALI-2

MATERIAL COLOUR

○ traffic white RAL 9016	7
● jet black RAL 9005	8

LIGHT OPTIC COVER

opal high performance	H
microprismatic (UGR ≤ 19)	G
jut-out	J

Options on request

COLOUR RENDERING INDEX
 CRI ≥ 90

Technical data

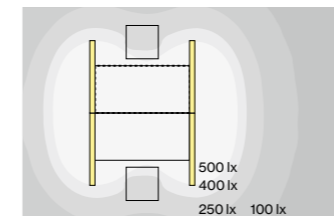

LENO suspended, microprismatic, 19.1W, 4000K

ROOM VALUES	
Room dimensions	5.4 × 4 × 2.8m
Reflection factor	0.7 0.5 0.2
Maintenance factor	0.8
Mounting height	2.25m

CALCULATION SURFACE	
Surface dimensions	1.6 × 0.8
Surface height	0.75
Average illuminance (E _m)	> 500lx
Uniformity (U _y)	> 0.6

GLARE EVALUATION	
Table Classification X=4H Y=8H S=0.25H	
UGR transversal	≤ 19
UGR axial	≤ 19

LUMINOUS FLUX value calculated for colour white, cover opal
 microprismatic -5%, jut-out-4%

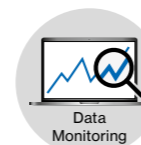

DiiA® standards
 251, 252, 253



single luminaire
 (p. 504)

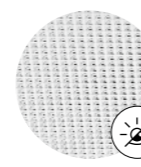

microprismatic
 UGR ≤ 19

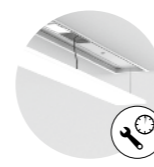

quick
 installation

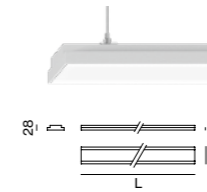

LENO suspended

INSTALLATION CHANNEL

TYPE	L (mm)	ORDER CODE
channel	613	05 1-893006
channel	1221	05 1-893012
channel	1830	05 1-893018
channel	2438	05 1-893024

order installation channel, light inset + mounting accessories separately



LIGHT INSET

SYSTEM POWER	L (mm)	ORDER CODE
10.8W	612*	05 1-811237
19.1W	1220	05 1-821437
28.6W	1828	05 1-821637
38W	2436	05 1-821837

*only available as end unit

COVER	COLOUR TEMP.	SYSTEM POWER	DELIVERED LUMENS	EFFICACY
opal high performance	3000K	17.6W/m	2010lm/m	129lm/W
microprismatic	4000K	17.6W/m	2130lm/m	137lm/W
UGR ≤ 19	3000K	17.6W/m	1900lm/m	122lm/W
jut-out	4000K	17.6W/m	2010lm/m	129lm/W
	4000K	17.6W/m	1930lm/m	124lm/W
	4000K	17.6W/m	2040lm/m	131lm/W

Accessories

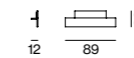

END CAPS

TYPE	ORDER CODE
end caps (pair)	05 1-899221

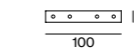

LINEAR CONNECTOR

TYPE	ORDER CODE
linear connector (pair)	05 1-899311
linear connector (10 pairs)	05 1-899311.10

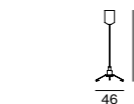

CABLE SUSPENSION

L (mm)	ORDER CODE
1500	005-2122110

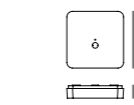

CANOPY / CABLE RAIL

TYPE	L (mm)	ORDER CODE
canopy / feeder cable 5 × 1.5 mm ²	1500	005-221241
cable rail	1200	005-2491110

for electrical system configuration see luminaire data sheet at xal.com

POWER FEEDER CONNECTOR 220-240V | 13A

TYPE	ORDER CODE
power feeder connector	05 1-8992330



DISMOUNTING TOOL

TYPE	ORDER CODE
vacuum cup	086-30000

Sharpen your profile system

MINIMAL system

EN A minimalist, continuous lighting system with maximum design freedom – MINIMAL makes this combination possible. The system luminaire is rimless, can be varied in length and thus be individually combined. CORNER elements create the perfect connection between the individual system luminaires. Designed for indoor use, the microprismatic cover version offers a standard-compliant reduced glare value for ideal workplace lighting. When using the opal cover, homogeneous room illumination is achieved, whereas the wallwasher insert provides uniform wall illumination. The MINIMAL system luminaire is available in the light colours 3000K, 4000K, and optionally in Tunable White.

DE Ein minimalistisches, durchgängiges Lichtsystem mit maximaler Gestaltungsfreiheit – diese Kombination wird durch MINIMAL möglich. Die Systemleuchte ist randlos, kann in ihrer Länge variiert und somit individuell kombiniert werden. CORNER Elemente schaffen dabei die perfekte Verbindung zwischen den einzelnen Systemleuchten. Für Innenräume konzipiert, bietet die Variante mit mikroprismatischer Abdeckung einen normkonformen, reduzierten Blendwert für ideale Arbeitsplatzbeleuchtung. Bei Einsatz des Opal-Covers erreichen Sie eine homogene Raumausleuchtung, wohingegen der Wallwasher Inset für eine gleichmäßige Wandaufhellung sorgt. Die MINIMAL Systemleuchte ist in den Lichtfarben 3000K, 4000K und optional in Tunable White erhältlich.

Types



60

100

Mounting



trimless
recessed

Configurations



linear

corner

Light distributions

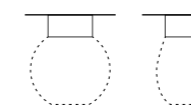

opal

microprismatic
(UGR ≤ 19)

← back



MINIMAL 60 system

recessed trimless

^{EN} Luminaire housing made of extruded aluminium; for trimless installation in plasterboard ceilings; special edge design with grooves for better adhesion of filler; for continuous lighting systems; for ceiling thickness of 8-25mm; surface powder coated; luminaire profile for mounting available in advance; remaining components mounted without tools; light inset consisting of highly reflective coated extruded profile for improved thermal management; option: lighting module is versatile in length; HPO (High Performance Opal) cover for uniform illumination; micro prismatic PMMA diffuser incl. diffuser film for homogeneous illumination and reduced luminance; wallwasher light inset; energy-eff. LEDs – very good colour rendering

^{DE} Leuchtenkörper aus Aluminiumstrangpressprofil; für randlosen Einbau in Gipskartendecken; spezielle Randausbildung mit Rillen für bessere Haftung der Spachtelmasse; für durchgehende Lichtsysteme; für Deckenstärken von 8-25 mm; Oberfläche pulverbeschichtet; Leuchtenprofil für Montage vorab lieferbar; restl. Komponenten werkzeuglos montierbar; Lichteinsatz bestehend aus hochreflektierend lackiertem Strangpressprofil für verbessertes Thermomanagement; optional flexibel abblängbarer Lichteinsatz; HPO (High Performance Opal) Abdeckung für homogene Ausleuchtung; mikroprismatische PMMA-Abdeckung inkl. Diffusorfolie zur Reduktion der Leuchtdichte bei homogener Ausleuchtung; Wallwasher Lichteinsatz; energieeff. LEDs – sehr gute Farbwiedergabe

Quickinfo

3000K, 4000K, TW
 CRI ≥ 80, CRI ≥ 90, 3 SDCM
 up to 2760 lm/m
 up to 125 lm/W
 L90 @ 50 000h
 non DIM, DALI-2
 opal, microprismatic (UGR ≤ 19)

Types

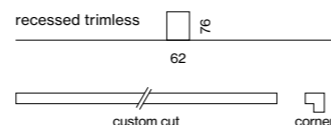

Colour



Light distributions



micropr. opal



DiiA® standards
 251, 252, 253



single luminaire
 (p.510)

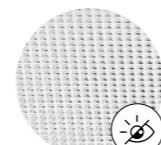

microprismatic
 UGR ≤ 19



wallwasher
 inset (p.944)

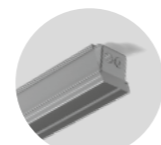

concrete install.
 housing (p.946)



tunable white
 2700–6500K

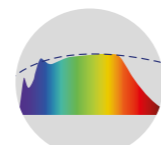

CRI ≥ 98
 XPECTRUM

Order options

LED TYPE	
mid lumen	L
high lumen	M

COLOUR TEMPERATURE	
3000K (CRI ≥ 90)	0
4000K (CRI ≥ 90)	1
3000K (CRI ≥ 80)	5
4000K (CRI ≥ 80)	6
tunable white 2700–6500K*	

*DALI-2 DT8

CONTROL	
non DIM	1
DALI-2 (only high lumen)	3

MATERIAL COLOUR

○ traffic white RAL 9016

LIGHT OPTIC COVER

opal high performance	H
microprismatic	Z
microprismatic (UGR ≤ 19)*	G
blind cover**	B

*UGR ≤ 19 only with mid lumen

**only for channel corner 90°

EMERGENCY LIGHT

1h Accupack	N L 1
3h Accupack	N L 3

Options on request

COLOUR RENDERING INDEX

CRI ≥ 98 XPECTRUM

MINIMAL 60 trimless

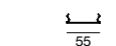
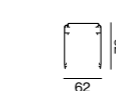
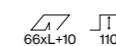

INSTALLATION CHANNEL / CORNER 90°

TYPE	L (mm)	ORDER CODE
channel	1172	036-01247
channel	1472	036-01547
channel	3000	036-03047
channel	custom	E82030...7
channel corner 90° + cover	140x140	036-12647

LIGHT OPTIC COVER / BLIND COVER

TYPE	L (mm)	ORDER CODE
linear	1171	006-16122
linear	1470	006-16152
linear	2997	006-16302
linear	custom	E80630...0
continuous linear	6000	006-23061H
continuous linear	25000	006-23251H
blind cover	3000	006-18307
blind cover	custom	E80630...7B



LIGHT INSET 60

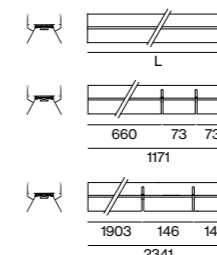

SYSTEM POWER (MID / HIGH LUMEN)	L (mm)	ORDER CODE
8.7 / 13.8 W	571	007-93...2
13 / 20.6 W	871	007-93...3
15.3 / 27.5 W	1171	007-93...4
19.2 / 34 W	1463	007-93...5
31 / 55 W	2341	007-93...8
38 / 68 W	2997	007-93...9
flexible inset 15.3 / 27.5 W	660-1171	007-93...F
flexible inset 31 / 55 W	1903-2341	007-93...G

COVER	COLOUR TEMP.	SYSTEM POWER	DELIVERED LUMENS	EFFICACY
mid lumen / opal	3000K	14 W/m	1540 lm/m	118 lm/W
high performance	4000K		1640 lm/m	125 lm/W
high lumen / opal	3000K	24 W/m	2540 lm/m	110 lm/W
high performance	4000K		2700 lm/m	116 lm/W

LIGHT INSET 60 tunable white 2700–6500K

SYSTEM POWER	L (mm)	ORDER CODE
12 W	871	007-9333D37
14.1 W	1171	007-9334D37
17.6 W	1463	007-9335D37
28.2 W	2341	007-9338D37

Accessories



END CAPS

TYPE	ORDER CODE
end caps (pair)	036-13047

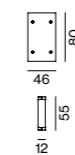

LINEAR CONNECTOR / THROUGH WIRE

TYPE	ORDER CODE
linear connector (1 piece)	005-40046
linear connector (10 pieces)	005-40046.10
opal cover linear connector	006-14000
through wire 3 × 1.5 mm ² (non DIM, 10 pieces)	004-90003
through wire 5 × 1.5 mm ² (DALI-2, 10 pieces)	004-90005

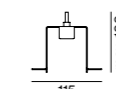

MOUNTING BRACKET

TYPE	CEILING THICKNESS (mm)	ORDER CODE
mounting bracket (1 piece)	8-25	036-10200
mounting bracket (25 pieces)	8-25	036-10200.25

number of brackets required: length of your system in metres+1

LUMINOUS FLUX value calculated for CRI ≥ 80, colour white, cover opal microprismatic -13%

← back

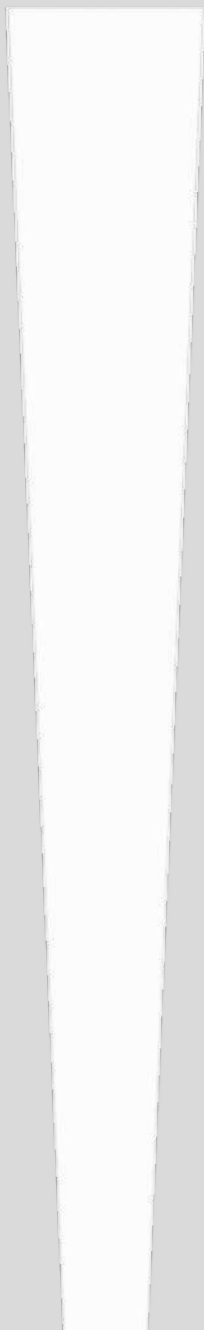

MINIMAL 100 system

recessed trimless

^{EN} Luminaire housing made of extruded aluminium; for trimless installation in plasterboard ceilings; special edge design with grooves for better adhesion of filler; for continuous lighting systems; for ceiling thickness of 8-25mm; surface powder coated; luminaire profile for mounting available in advance; remaining components mounted without tools; light inset consisting of highly reflective coated extruded profile for improved thermal management; option: lighting module is versatile in length; HPO (High Performance Opal) cover for uniform illumination; micro prismatic PMMA diffuser incl. diffuser film for homogeneous illumination and reduced luminance; wallwasher light inset; energy-eff. LEDs – very good colour rendering

^{DE} Leuchtenkörper aus Aluminiumstrangpressprofil; für randlosen Einbau in Gipskartondecken; spezielle Randausbildung mit Rillen für bessere Haftung der Spachtelmasse; für durchgehende Lichtsysteme; für Deckenstärken von 8-25 mm; Oberfläche pulverbeschichtet; Leuchtenprofil für Montage vorab lieferbar; restl. Komponenten werkzeuglos montierbar; Lichteinsatz bestehend aus hochreflektierend lackiertem Strangpressprofil für verbessertes Thermomanagement; optionale flexibel abblägbare Lichteinsatz; HPO (High Performance Opal) Abdeckung für homogene Ausleuchtung; mikroprismatische PMMA-Abdeckung inkl. Diffusorfolie zur Reduktion der Leuchtdichte bei homogener Ausleuchtung; Wallwasher Lichteinsatz; energieeff. LEDs – sehr gute Farbwiedergabe

Quickinfo

3000K, 4000K, TW
 CRI ≥ 80, CRI ≥ 90, 3 SDCM
 UGR ≤ 19 / 65° ≤ 3000 cd/m²
 up to 3090 lm/m
 up to 140 lm/W
 L90 @ 50 000h
 non DIM, DALI-2
 opal, microprismatic (UGR ≤ 19)

Types

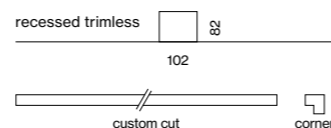

Colour



Light distributions

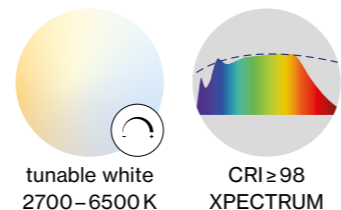
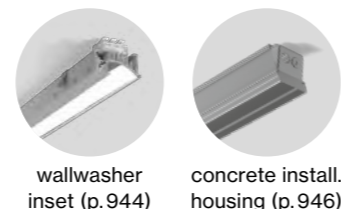
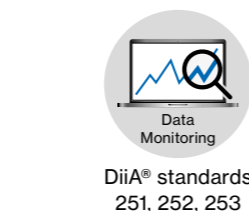

Order options

LED TYPE	
mid lumen	L
high lumen	M

COLOUR TEMPERATURE	
3000K (CRI ≥ 90)	0
4000K (CRI ≥ 90)	1
3000K (CRI ≥ 80)	5
4000K (CRI ≥ 80)	6
tunable white 2700–6500K*	

CONTROL	
non DIM	1
DALI-2 (only high lumen)	3

MATERIAL COLOUR	
traffic white RAL 9016	

LIGHT OPTIC COVER	
opal high performance	H
microprismatic	Z
microprismatic (UGR ≤ 19)*	G
blind cover**	B

EMERGENCY LIGHT	
1h Accupack	N L 1
3h Accupack	N L 3

Options on request

COLOUR RENDERING INDEX	
CRI ≥ 98 XPECTRUM	

LUMINOUS FLUX value calculated for CRI ≥ 80, colour white, cover opal microprism. Z -8%, microprism. G -10%

MINIMAL 100 trimless

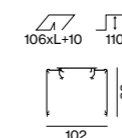

INSTALLATION CHANNEL / CORNER 90°	L (mm)	ORDER CODE
channel	1172	036-01267
channel	1472	036-01567
channel	3000	036-03067
channel	custom	E82050...7
channel corner 90° + cover	200x200	036-12667

LIGHT OPTIC COVER / BLIND COVER	L (mm)	ORDER CODE
linear	1171	006-12122
linear	1470	006-12152
linear	2997	006-12302
linear	custom	E80650...0
blind cover	3000	006-11307
blind cover	custom	E80650...7B

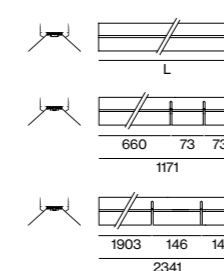

LIGHT INSET 100	SYSTEM POWER (MID/HIGH LUMEN)	L (mm)	ORDER CODE
	8.7/13.8W	571	007-86...2
	13/20.6W	871	007-86...3
	15.3/27.5W	1171	007-86...4
	19.2/34W	1463	007-86...5
	31/55W	2341	007-86...8
	38/68W	2997	007-86...9
	flexible inset 15.3/27.5W	660-1171	007-86...F
	flexible inset 31/55W	1903-2341	007-86...G

COVER	COLOUR TEMP.	SYSTEM POWER	DELIVERED LUMENS	EFFICACY
mid lumen/opal	3000K	14 W/m	1770lm/m	132lm/W
high performance	4000K		1870lm/m	140lm/W
high lumen/opal	3000K	24 W/m	2920lm/m	123lm/W
high performance	4000K		3090lm/m	130lm/W

LIGHT INSET 100 tunable white 2700–6500K	SYSTEM POWER	L (mm)	ORDER CODE
	12W	871	007-8633D37
	14.1W	1171	007-8634D37
	17.6W	1463	007-8635D37
	28.2W	2341	007-8638D37

Accessories

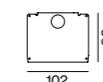

END CAPS	ORDER CODE
end caps (pair)	036-13067

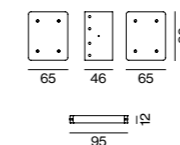

LINEAR CONNECTOR / THROUGH WIRE	ORDER CODE
linear connector (1 piece)	005-40066
linear connector (10 pieces)	005-40066.10
opal cover linear connector	006-10000
through wire 3 × 1.5 mm² (non DIM, 10 pieces)	004-90003
through wire 5 × 1.5 mm² (DALI-2, 10 pieces)	004-90005

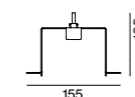

MOUNTING BRACKET	CEILING THICKNESS (mm)	ORDER CODE
mounting bracket (1 piece)	8-25	036-10300
mounting bracket (25 pieces)	8-25	036-10300.25

number of brackets required: length of your system in metres+1

Bank of Ireland Dublin, IE –
by Henry J Lyons Architects with lighting
design by O'Connor Sutton Cronin

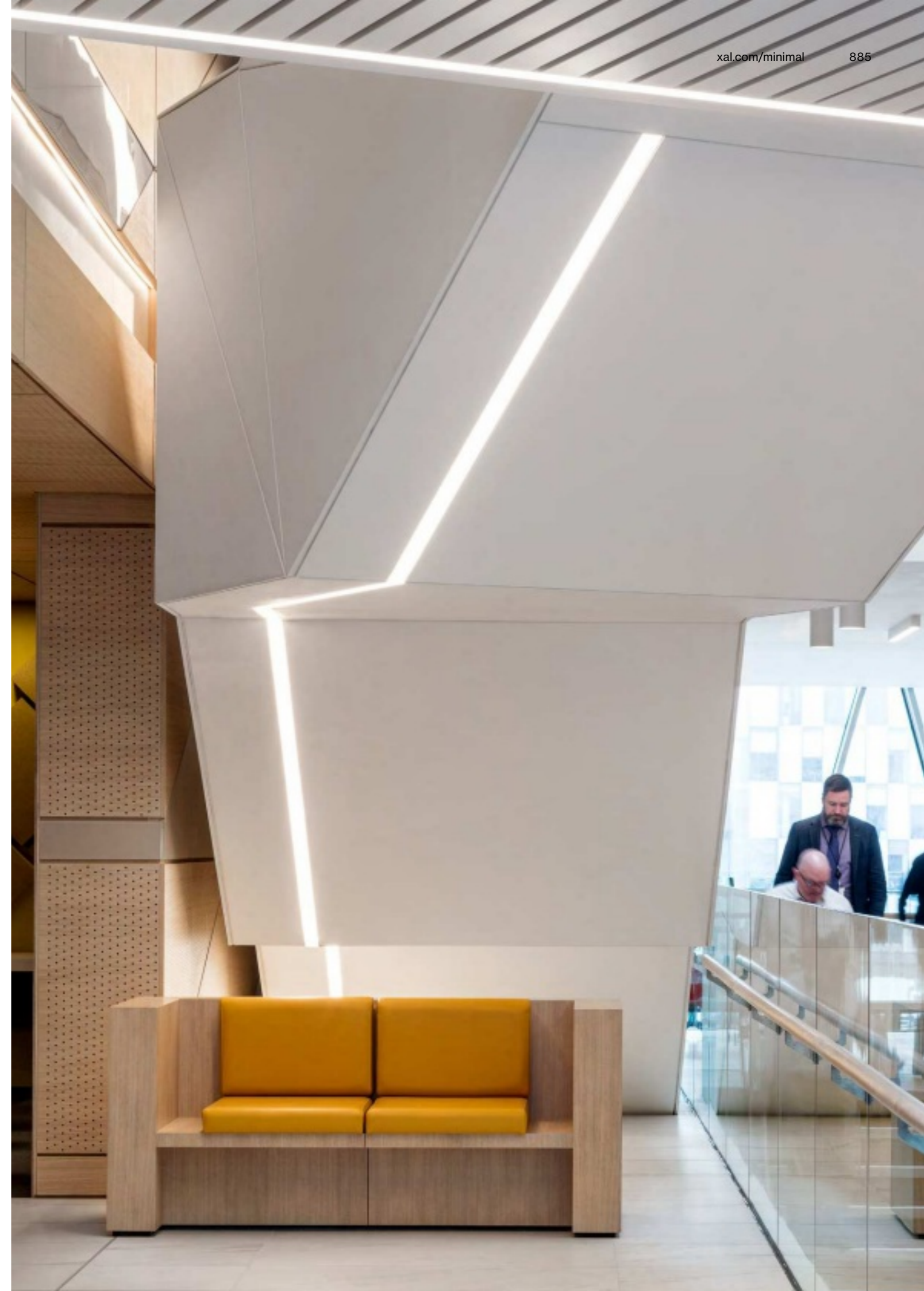



Telecable
Gijón, ES –
by Arquitectos
Pablo Poch Duo Comunicación with
lighting design by Lux Gijón



Outline your profile system

FRAME system

EN The FRAME system luminaire sets no limits on office lighting and profile-based ambient lighting. Thanks to special flex insets, FRAME can be shortened on-site and thus adapted to all conditions. The system luminaire connects to form a light band, creating continuous lighting. Corner connectors thus create a continuous lighting system. The lighting insets also leave nothing to be desired – whether insets with opal cover for uniform room illumination, or the microprismatic cover for light suitable for workplaces. Available light colours range from 3000 K to 4000 K and optional Tunable White, and a colour rendering of up to $\text{CRI} \geq 98$ (XPECTRUM).

DE Mit der FRAME Systemleuchte sind Ihnen in punkto Office-Beleuchtung und profilbasierter Grundausleuchtung keine Grenzen gesetzt. Aufgrund spezieller Flex-Insets kann FRAME vor Ort gekürzt und somit an alle Gegebenheiten angepasst werden. Die Systemleuchte lässt sich zu einem Lichtband verbinden um eine durchgängige Beleuchtung zu schaffen. Durch Eckverbinder entsteht so ein durchgängiges Lichtsystem. Auch die Lichteinsätze lassen keine Wünsche offen – ob Einsätze mit Opal-Cover für eine einheitliche Raumausleuchtung oder die Mikroprismatik-Abdeckung für arbeitsplatztaugliches Licht. Die Lichtfarbe ist aus 3000 K, 4000 K und wahlweise Tunable White und einer Farbwiedergabe von bis zu $\text{CRI} \geq 98$ (XPECTRUM) wählbar.

Types



40

60

100

Mounting



with trim
recessed

Configurations



linear

corner

Light distributions

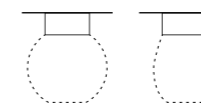

opal

 microprismatic
($\text{UGR} \leq 19$)

← back

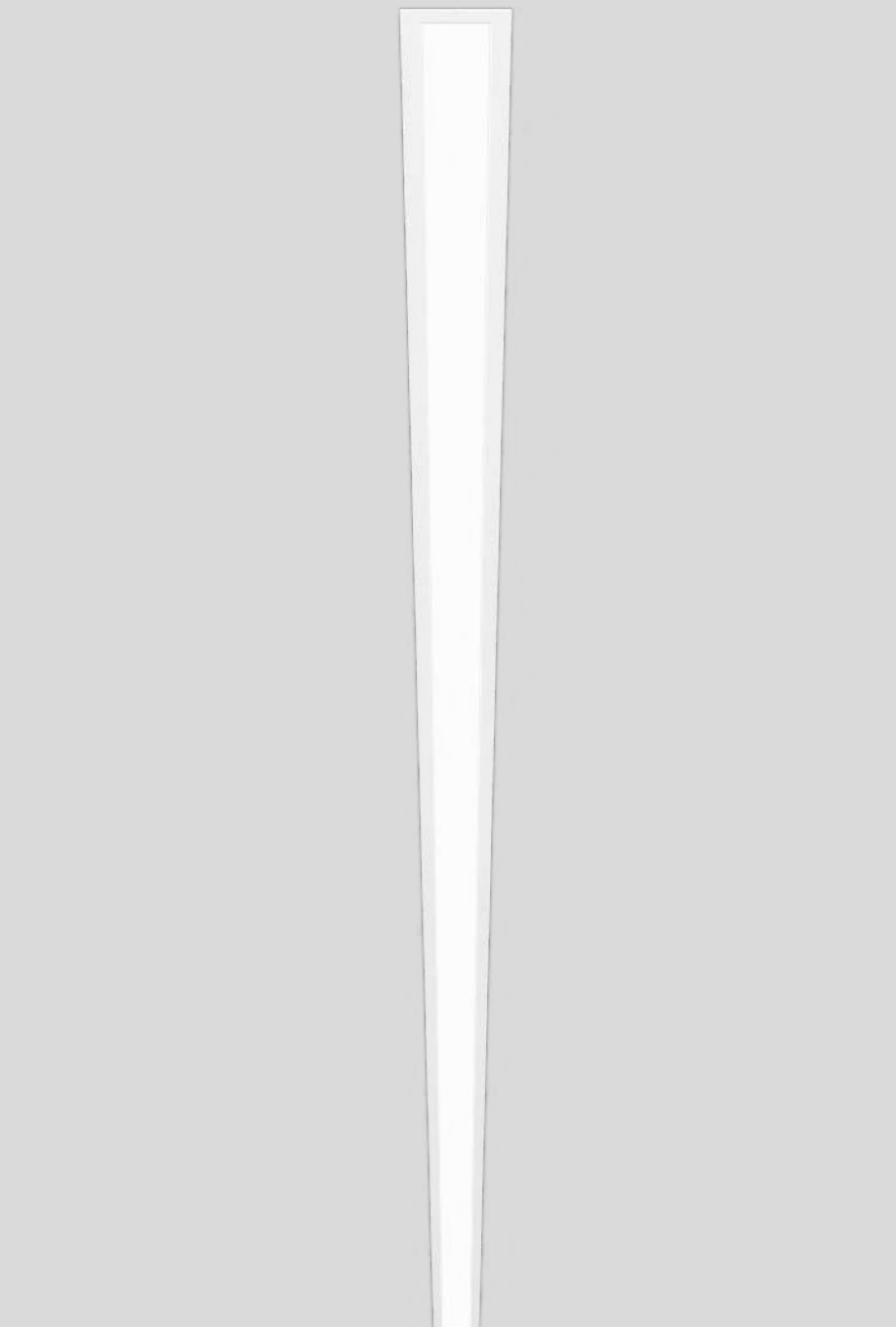

FRAME 40 system

recessed with trim

EN Luminaire housing made of extruded aluminium; recessed luminaire with trim; designed for continuous lighting systems; suitable for ceiling thickness of 8-25 mm; surface powder coated; luminaire profile incl. light inset; cover in the length of the light inset or continuous cover (both separately available); pre-assembled power rail for power supply in luminaire profile; voltage tap of the light inset on the power rail; light inset consisting of highly reflective coated extruded profile for improved thermal management; HPO (High Performance Opal) cover for uniform illumination; energy-efficient LEDs with very good colour rendering

DE Leuchtenkörper aus Aluminiumstrangpressprofil; Einbauleuchte mit umlaufendem Rand; ausgelegt für durchgehende Lichtsysteme; geeignet für Deckenstärken von 8-25 mm; Oberfläche pulverbeschichtet; Leuchtenprofil inkl. Lichteinsatz; Abdeckung in Lichteinsatzlänge oder durchgängige Abdeckung in Lichteinsatzlänge oder durchgängige Abdeckung in Lichteinsatzlänge; vormontierte Stromschiene zur Spannungsversorgung im Leuchtenprofil; Lichteinsatz-Spannungsabgriff an der Stromschiene; Lichteinsatz bestehend aus hochreflektierend lackiertem Strangpressprofil für verbessertes Thermomanagement; HPO (High Performance Opal) Abdeckung für homogene Ausleuchtung; energieeffiziente LEDs mit sehr guter Farbwiedergabe

Quickinfo

3000K, 4000K
 CRI ≥ 90, 3 SDCM
 up to 2340 lm/m
 up to 102 lm/W
 L90 @ 50 000h
 DALI-2
 opal

Types

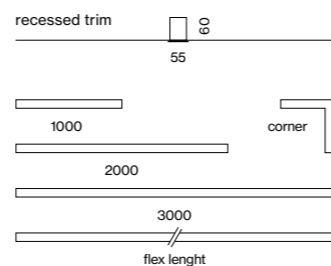

Colours



Light distribution

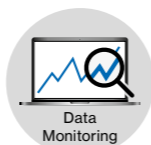

DiiA® standards
 251, 252, 253



single luminaire
 (p. 518)

flexible
 inset

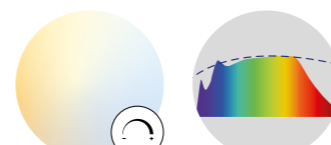

tunable white
 2700–6500K

CRI ≥ 98
 XPECTRUM

Order options

LED TYPE
 mid lumen 1
 high lumen 2

COLOUR TEMPERATURE
 3000K 0
 4000K 1

CONTROL
 DALI-2

MATERIAL COLOUR
 traffic white RAL 9016 7
 white aluminium RAL 9006 G

LIGHT OPTIC COVER
 opal high performance

Options on request

COLOUR RENDERING INDEX
 CRI ≥ 98 XPECTRUM

COLOUR TEMPERATURE
 tunable white 2700–6500K

LIGHT OPTIC COVER
 microprismatic

FRAME 40 trim

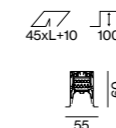

INSTALLATION CHANNEL + LIGHT INSET

SYSTEM POWER (MID/HIGH LUMEN)	L (mm)	ORDER CODE
15.3/22.9W	1000	042-70▲2::3
30.5/46W	2000	042-70▲4::3
46/69W	3000	042-70▲6::3
15.3/22.9W flex	500–1000	042-70▲F::3
30.5/46W flex	1500–2000	042-70▲G::3
15.3/22.9W corner	500×500	042-70▲C::3

COVER	COLOUR TEMP.	SYSTEM POWER	DELIVERED LUMENS	EFFICACY
mid lumen / opal	3000K	15.3 W/m	1480 lm/m	97 lm/W
high performance	4000K		1560 lm/m	102 lm/W
high lumen / opal	3000K	22.9 W/m	2210 lm/m	97 lm/W
high performance	4000K		2340 lm/m	102 lm/W

LIGHT OPTIC COVER 40

TYPE	L (mm)	ORDER CODE
linear	1000	006-22011H
linear	2000	006-22021H
linear	3000	006-22031H
corner	500×500	006-220C1H
continuous linear	6000	006-22061H
continuous linear	30000	006-22301H

Accessories

END CAPS

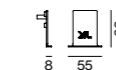

TYPE	ORDER CODE
end caps (pair)	042-709001

CHANNEL + BLIND COVER

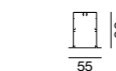

TYPE	L (mm)	ORDER CODE
linear	1000	042-709421
linear	2000	042-709441
linear	3000	042-709461
corner	500×500	042-7094C1

POWER FEEDER UNIT

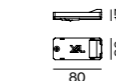

TYPE	ORDER CODE
power feeder unit	042-1093230

LINEAR CONNECTOR

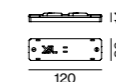

TYPE	ORDER CODE
mechanical linear connector	042-7091110
mechanical + electrical linear connector	042-7091210
opal cover linear connector	042-1091910

MOUNTING BRACKET

TYPE	CEILING THICKNESS (mm)	ORDER CODE
mounting bracket (1 piece)	8-25	042-7092110
mounting bracket (25 pieces)	8-25	042-7092110.25

number of brackets required: length of your system in metres+1

LUMINOUS FLUX value calculated for
 CRI ≥ 90, colour white, cover opal

← back



FRAME 60 system

recessed with trim

EN Luminaire housing made of extruded aluminium; recessed luminaire with trim; designed for continuous lighting systems; suitable for ceiling thickness of 8-25 mm; surface powder coated; luminaire profile for mounting available in advance; remaining luminaire components mounted without tools; light inset consisting of highly reflective coated extruded profile for improved thermal management; option: lighting module is versatile in length; HPO (High Performance Opal) cover for uniform illumination; micro prismatic PMMA diffuser incl. diffuser film for homogeneous illumination and reduced luminance; wall-washer light inset; energy-efficient LEDs with very good colour rendering

DE Leuchtenkörper aus Aluminiumstrangpressprofil; Einbauleuchte mit umlaufendem Rand; ausgelegt für durchgehende Lichtsysteme; geeignet für Deckenstärken von 8-25 mm; Oberfläche pulverbeschichtet; Leuchtenprofil für Montage vorab lieferbar; restliche Leuchtenkomponenten werkzeuglos montierbar; Lichteinsatz bestehend aus hochreflektierend lackiertem Strangpressprofil für verbessertes Thermomanagement; optional flexibel ablänger Lichteinsatz; HPO (High Performance Opal) Abdeckung für homogene Ausleuchtung; mikroprismatische PMMA-Abdeckung inkl. Diffusorfolie zur Reduktion der Leuchtdichte bei homogener Ausleuchtung; Wallwasher Lichteinsatz; energieeffiziente LEDs mit sehr guter Farbwiedergabe

Quickinfo

3000K, 4000K, TW
 CRI ≥ 80, CRI ≥ 90, 3 SDCM
 up to 2760 lm/m
 up to 125 lm/W
 L90 @ 50 000h
 non DIM, DALI-2
 opal, microprismatic (UGR ≤ 19)

Types

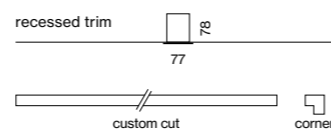

Colours



Light distributions



DiiA® standards
251, 252, 253



single luminaire
(p.520)



wallwasher
inset (p.944)

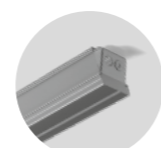

concrete install.
housing (p.946)



flexible
inset

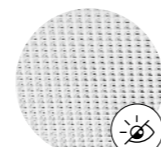

microprismatic
UGR ≤ 19



tunable white
2700–6500 K

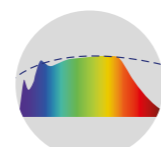

CRI ≥ 98
XPECTRUM

Order options

LED TYPE	
mid lumen	L
high lumen	M

COLOUR TEMPERATURE	
3000 K (CRI ≥ 90)	0
4000 K (CRI ≥ 90)	1
3000 K (CRI ≥ 80)	5
4000 K (CRI ≥ 80)	6
tunable white 2700–6500 K*	

*DALI-2 DT8

CONTROL	
non DIM	1
DALI-2 (only high lumen)	3

MATERIAL COLOUR	
○ traffic white RAL 9016	7
● white aluminium RAL 9006	G

LIGHT OPTIC COVER	
opal high performance	H
microprismatic	Z
microprismatic (UGR ≤ 19)*	G
blind cover**	B

*UGR ≤ 19 only with mid lumen
 **only for channel corner 90°

EMERGENCY LIGHT	
1h Accupack	N L 1
3h Accupack	N L 3

Options on request

COLOUR RENDERING INDEX	
CRI ≥ 98 XPECTRUM	

INSTALLATION CHANNEL	
curve	

CONNECTOR	
X- and T-connector	

LUMINOUS FLUX value calculated for CRI ≥ 80, colour white, cover opal microprismatic -13%

FRAME 60 trim



INSTALLATION CHANNEL / CORNER 90°	L (mm)	ORDER CODE
channel	1172	035-0123
channel	1472	035-0153
channel	3000	035-0303
channel	custom	E82140
channel corner 90° + cover	144x144	035-1263

LIGHT OPTIC COVER / BLIND COVER	L (mm)	ORDER CODE
linear	1171	006-16122
linear	1470	006-16152
linear	2997	006-16302
linear	custom	E80630
continuous linear	6000	006-23061H
continuous linear	25000	006-23251H
blind cover	3000	006-1830
blind cover	custom	E80630



LIGHT INSET 60	L (mm)	ORDER CODE
SYSTEM POWER (MID/HIGH LUMEN)		
8.7 / 13.8 W	571	007-932
13 / 20.6 W	871	007-933
15.3 / 27.5 W	1171	007-934
19.2 / 34 W	1463	007-935
31 / 55 W	2341	007-938
38 / 68 W	2997	007-939
flexible inset 15.3 / 27.5 W	660-1171	007-93F
flexible inset 31 / 55 W	1903-2341	007-93G

COVER	COLOUR TEMP.	SYSTEM POWER	DELIVERED LUMENS	EFFICACY
mid lumen / opal	3000 K	14 W/m	1540 lm/m	118 lm/W
high performance	4000 K		1640 lm/m	125 lm/W
high lumen / opal	3000 K	24 W/m	2540 lm/m	110 lm/W
high performance	4000 K		2700 lm/m	116 lm/W

LIGHT INSET 60 tunable white 2700–6500 K	L (mm)	ORDER CODE
SYSTEM POWER		
12 W	871	007-9333D37
14.1 W	1171	007-9334D37
17.6 W	1463	007-9335D37
28.2 W	2341	007-9338D37

Accessories

END CAPS	ORDER CODE
TYPE	
end caps (pair)	035-1313

LINEAR CONNECTOR / THROUGH WIRE	ORDER CODE
TYPE	
linear connector (1 piece)	005-40046
linear connector (10 pieces)	005-40046.10
opal cover linear connector	006-14000
through wire 3 × 1.5 mm ² (non DIM, 10 pieces)	004-90003
through wire 5 × 1.5 mm ² (DALI-2, 10 pieces)	004-90005

MOUNTING BRACKET	CEILING THICKNESS (mm)	ORDER CODE
TYPE		
mounting bracket (1 piece)	8-25	035-10200
mounting bracket (25 pieces)	8-25	035-10200.25

number of brackets required: length of your system in metres+1



Dr. Schaer Burgstall, IT –
by monovolume architecture+design
with lighting design by VON LUTZ -
electrical and lighting projects /
Alexa von Lutz

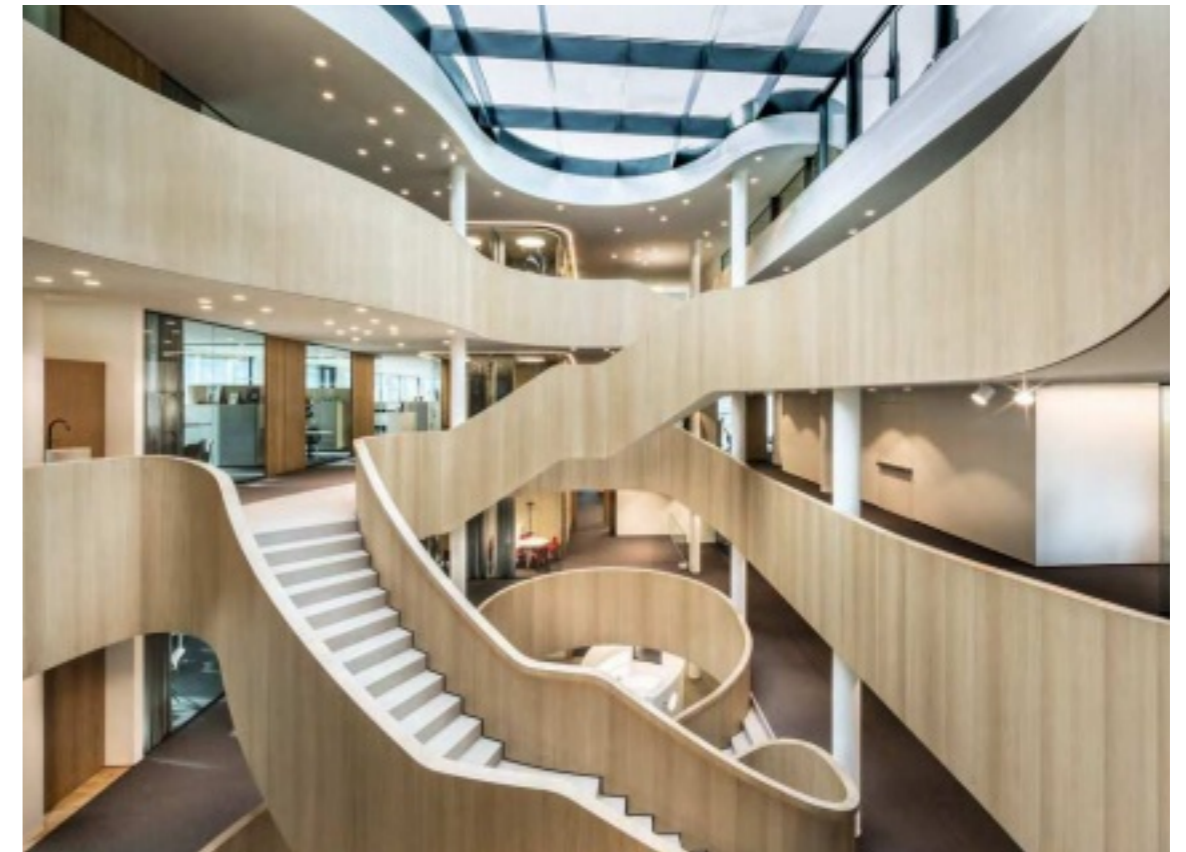
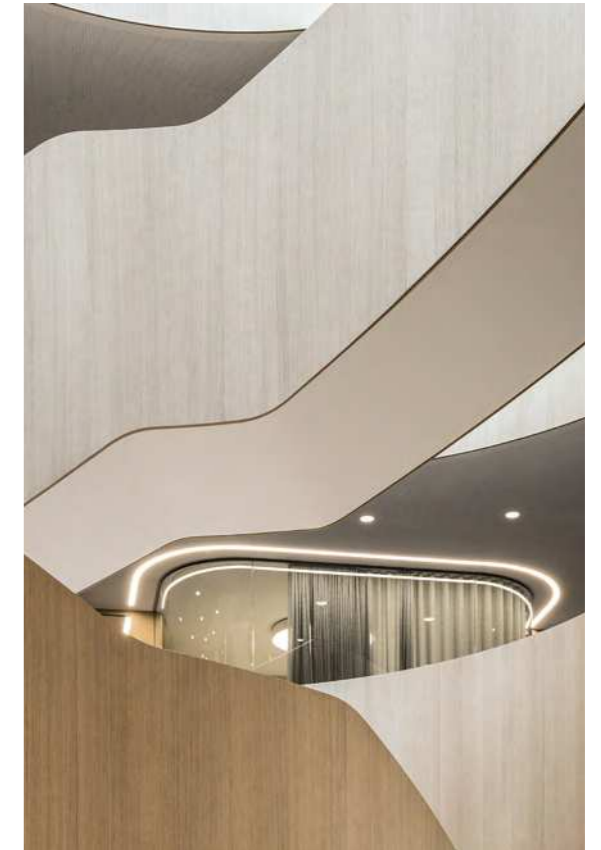

RLB headquarters Graz, AT –
by Strohecker ZT GmbH with lighting
design by Klaus Elektro-Anlagen



← back

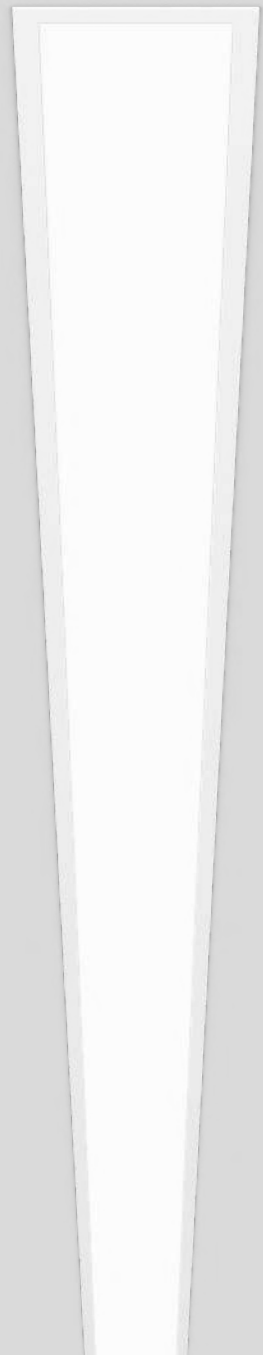

FRAME 100 system

recessed with trim

EN Luminaire housing made of extruded aluminium; recessed luminaire with trim; for continuous lighting systems; for ceiling thickness of 8-25 mm; surface powder coated; luminaire profile for mounting available in advance; remaining luminaire components mounted without tools; light inset consisting of highly reflective coated extruded profile for improved thermal management; option: lighting module is versatile in length; HPO (High Performance Opal) cover for uniform illumination; micro prismatic PMMA diffuser incl. diffuser film for homogeneous illumination and reduced luminance; wallwasher light inset; energy-efficient LEDs with very good colour rendering

DE Leuchtenkörper aus Aluminiumstrangpressprofil; Einbauleuchte mit umlaufendem Rand; für durchgehende Lichtsysteme; für Deckenstärken von 8-25 mm; Oberfläche pulverbeschichtet; Leuchtenprofil für Montage vorab lieferbar; restliche Leuchtenkomponenten werkzeuglos montierbar; Lichteinsatz bestehend aus hochreflektierend lackiertem Strangpressprofil für verbessertes Thermomanagement; optional flexibel ablängbarer Lichteinsatz; HPO (High Performance Opal) Abdeckung für homogene Ausleuchtung; mikroprismatische PMMA-Abdeckung inkl. Diffusorfolie zur Reduktion der Leuchtdichte bei homogener Ausleuchtung; Wallwasher Lichteinsatz; energieeffiziente LEDs mit sehr guter Farbwiedergabe

Quickinfo

3000K, 4000K, TW
 CRI ≥ 80, CRI ≥ 90, 3 SDCM
 UGR ≤ 19 / 65° ≤ 3000 cd/m²
 up to 3090 lm/m
 up to 140 lm/W
 L90 @ 50 000h
 non DIM, DALI-2
 opal, microprismatic (UGR ≤ 19)

Types

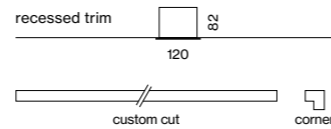

Colours



Light distributions



DiiA® standards
251, 252, 253



single luminaire
(p.522)



wallwasher
inset (p.944)

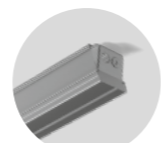

concrete install.
housing (p.946)



flexible
inset

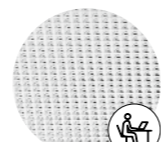

DIN EN 12464-1
UGR ≤ 19

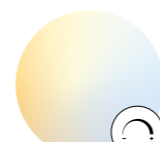

tunable white
2700–6500 K

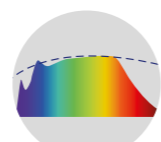

CRI ≥ 98
XPECTRUM

Order options

LED TYPE	
mid lumen	L
high lumen	M

COLOUR TEMPERATURE	
3000 K (CRI ≥ 90)	0
4000 K (CRI ≥ 90)	1
3000 K (CRI ≥ 80)	5
4000 K (CRI ≥ 80)	6
tunable white 2700–6500 K*	

*DALI-2 DT8

CONTROL	
non DIM	1
DALI-2 (only high lumen)	3

MATERIAL COLOUR	
○ traffic white RAL 9016	7
● white aluminium RAL 9006	G

LIGHT OPTIC COVER	
opal high performance	H
microprismatic	Z
microprismatic (UGR ≤ 19)*	G
blind cover**	B

*UGR ≤ 19 only with mid lumen
 **only for channel corner 90°

EMERGENCY LIGHT	
1h Accupack	N L 1
3h Accupack	N L 3

Options on request

COLOUR RENDERING INDEX	
CRI ≥ 98 XPECTRUM	

CONNECTOR	
X- and T-connector	

LUMINOUS FLUX value calculated for CRI ≥ 80, colour white, cover opal microprism. Z -8%, microprism. G -10%

FRAME 100 trim

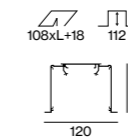

INSTALLATION CHANNEL / CORNER 90°	L (mm)	ORDER CODE
channel	1172	035-0125
channel	1472	035-0155
channel	3000	035-0305
channel	custom	E 82150
channel corner 90° + cover	205x205	035-1265

LIGHT OPTIC COVER / BLIND COVER	L (mm)	ORDER CODE
linear	1171	006-12122
linear	1470	006-12152
linear	2997	006-12302
linear	custom	E 80650
blind cover	3000	006-1130
blind cover	custom	E 80650

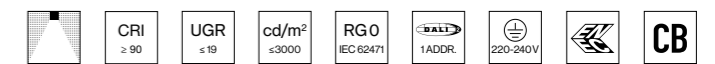

LIGHT INSET 100	L (mm)	ORDER CODE
SYSTEM POWER (MID/HIGH LUMEN)		
8.7/13.8 W	571	007-862
13/20.6 W	871	007-863
15.3/27.5 W	1171	007-864
19.2/34 W	1463	007-865
31/55 W	2341	007-868
38/68 W	2997	007-869
15.3/27.5 W flex	660-1171	007-86F
31/55 W flex	1903-2341	007-86G

COVER	COLOUR TEMP.	SYSTEM POWER	DELIVERED LUMENS	EFFICACY
mid lumen/opal	3000 K	14 W/m	1770 lm/m	132 lm/W
high performance	4000 K		1870 lm/m	140 lm/W
high lumen/opal	3000 K	24 W/m	2920 lm/m	123 lm/W
high performance	4000 K		3090 lm/m	130 lm/W

LIGHT INSET 100 tunable white 2700–6500 K	L (mm)	ORDER CODE
SYSTEM POWER		
12 W	871	007-8633D37
14.1 W	1171	007-8634D37
17.6 W	1463	007-8635D37
28.2 W	2341	007-8638D37

Accessories

END CAPS	ORDER CODE
TYPE	
end caps (pair)	035-1315

LINEAR CONNECTOR / THROUGH WIRE	ORDER CODE
TYPE	
linear connector (1 piece)	005-40066
linear connector (10 pieces)	005-40066.10
opal cover linear connector	006-10000
through wire 3 × 1.5 mm² (non DIM, 10 pieces)	004-90003
through wire 5 × 1.5 mm² (DALI-2, 10 pieces)	004-90005

MOUNTING BRACKET	CEILING THICKNESS (mm)	ORDER CODE
TYPE		
mounting bracket (1 piece)	8-25	035-10230
mounting bracket (25 pieces)	8-25	035-10230.25

number of brackets required: length of your system in metres+1



CMS Office Paris, FR –
by Lobjoy & Bouvier & Boisseau



Discreet profile system

CANYON system

EN The CANYON system luminaire radiates calm and makes visitors feel welcome – whether in entrance halls, at the reception, or in corridors or lounges. The specially developed, flex insets, which can be shortened, make the luminaire a true all-round talent; with its tailored profile length, the luminaire can also be transformed into a customised lighting system by using CORNER elements. Also noteworthy: When combined with the opal cover, the CANYON system luminaire creates uniform ambient lighting. For workstations, it can be perfectly adapted to office conditions using insets with microprismatic covers.

DE Die CANYON Systemleuchte strahlt Ruhe aus und bewirkt, dass sich Besucher – egal ob in Eingangshallen, beim Empfang, in Gängen oder Aufenthaltsräumen – willkommen fühlen. Durch die speziell entwickelten, kürzbaren Flex-Insets ist die Leuchte ein wahres All-round-Talent: Mit der Wunsch-Profillänge lässt sich die Leuchte durch den Einsatz von CORNER Elementen auch zu einem individuellen Lichtsystem verwandeln. Weiters bemerkenswert: Bei Kombination mit dem Opal-Cover kreiert die CANYON Systemleuchte eine einheitliche Grundbeleuchtung. Bei Arbeitsplätzen lässt sie sich durch Insets mit mikroprismatischer Abdeckung perfekt auf Office-Bedingungen anpassen.

Type



60

Mounting

trim
recessed

Configurations



linear



corner

Light distributions

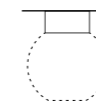

opal

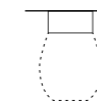
microprismatic
(UGR ≤ 19)

← back



CANYON 60 system

recessed offset with trim

EN Luminaire housing made of extruded aluminium; uncluttered ceiling look through recessed lighting level; recessed luminaire with trim; for continuous lighting systems; for ceiling thickness of 8-25mm; surface powder coated; luminaire profile for mounting available in advance; remaining luminaire components mounted without tools; light inset consisting of highly reflective coated extruded profile for improved thermal management; option: lighting module is versatile in length; HPO (High Performance Opal) cover for uniform illumination; micro prismatic PMMA diffuser incl. diffuser film for homogeneous illumination and reduced luminance; wallwasher light inset; energy-efficient LEDs with very good colour rendering

DE Leuchtenkörper aus Aluminiumstrangpressprofil; ruhiges Deckenbild durch zurückversetzte Leuchtenebene; Einbauleuchte mit umlaufendem Rand; für durchgehende Lichtsysteme; für Deckenstärken von 8-25mm; Oberfläche pulverbeschichtet; Leuchtenprofil für Montage vorab lieferbar; restliche Leuchtenkomponenten werkzeuglos montierbar; Lichteinsatz bestehend aus hochreflektierend lackiertem Strangpressprofil für verbessertes Thermomanagement; optional flexibel ablängbarer Lichteinsatz; HPO (High Performance Opal) Abdeckung für homogene Ausleuchtung; mikroprismatische PMMA-Abdeckung inkl. Diffusorfolie zur Reduktion der Leuchtdichte bei homogener Ausleuchtung; Wallwasher Lichteinsatz; energieeffiziente LEDs mit sehr guter Farbwiedergabe

Quickinfo

3000K, 4000K, TW
 CRI ≥ 80, CRI ≥ 90, 3 SDCM
 up to 2280lm/m
 up to 105lm/W
 L90 @ 50 000h
 non DIM, DALI-2
 opal, microprismatic

Types

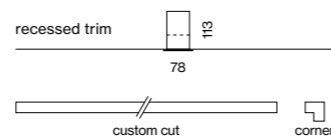

Colours



Light distributions



Order options

LED TYPE	
mid lumen	L
high lumen	M

COLOUR TEMPERATURE	
3000K (CRI ≥ 90)	0
4000K (CRI ≥ 90)	1
3000K (CRI ≥ 80)	5
4000K (CRI ≥ 80)	6
tunable white 2700–6500K*	

*DALI-2 DT8

CONTROL	
non DIM	1
DALI-2 (only high lumen)	3

MATERIAL COLOUR	
○ traffic white RAL 9016	7
● jet black RAL 9005	8

LIGHT OPTIC COVER	
opal high performance	H
microprismatic	Z
blind cover*	B

*only for channel corner 90°

EMERGENCY LIGHT	
1h Accupack	N L 1
3h Accupack	N L 3

Options on request

COLOUR RENDERING INDEX	
CRI ≥ 98 XPECTRUM	

CONNECTOR	
X- and T-connector	

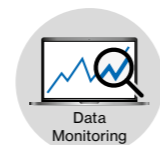

DiiA® standards
251, 252, 253



single luminaire
(p.528)



wallwasher
inset (p.944)



ball-impact-
resistant



glare control
UGR ≤ 19



tunable white
2700–6500K

LUMINOUS FLUX value calculated for CRI ≥ 80, colour white, cover opal microprismatic -13%

CANYON 60 trim offset

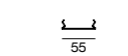
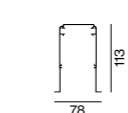

INSTALLATION CHANNEL / CORNER 90°	L (mm)	ORDER CODE
channel	1172	038-5127
channel	1472	038-5157
channel	3000	038-5307
channel	custom	E82330
channel corner 90° + cover	144x144	038-6267

LIGHT OPTIC COVER / BLIND COVER	L (mm)	ORDER CODE
linear	1171	006-16122
linear	1470	006-16152
linear	2997	006-16302
linear	custom	E80630
blind cover	1472	006-1815
blind cover	custom	E80630



LIGHT INSET 60	L (mm)	ORDER CODE
SYSTEM POWER (MID/HIGH LUMEN)		
8.7/13.8W	571	007-932
13/20.6W	871	007-933
15.3/27.5W	1171	007-934
19.2/34W	1463	007-935
31/55W	2341	007-938
38/68W	2997	007-939
15.3/27.5W flex	660-1171	007-93F
31/55W flex	1903-2341	007-93G

COVER	COLOUR TEMP.	SYSTEM POWER	DELIVERED LUMENS	EFFICACY
mid lumen/opal	3000K	14 W/m	1300lm/m	99lm/W
high performance	4000K		1380lm/m	105lm/W
high lumen/opal	3000K	24 W/m	2160lm/m	92lm/W
high performance	4000K		2280lm/m	98lm/W

LIGHT INSET 60 tunable white 2700–6500K	L (mm)	ORDER CODE
SYSTEM POWER		
12W	871	007-9333D37
14.1W	1171	007-9334D37
17.6W	1463	007-9335D37
28.2W	2341	007-9338D37

Accessories

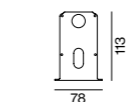

END CAPS	ORDER CODE
TYPE	
end caps (pair)	038-6307

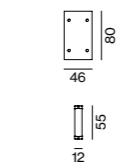

LINEAR CONNECTOR / THROUGH WIRE	ORDER CODE
TYPE	
linear connector (1 piece)	005-40046
linear connector (10 pieces)	005-40046.10
opal cover linear connector	006-14000
through wire 3 × 1.5 mm² (non DIM, 10 pieces)	004-90003
through wire 5 × 1.5 mm² (DALI-2, 10 pieces)	004-90005

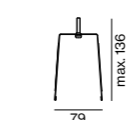

MOUNTING BRACKET	CEILING THICKNESS (mm)	ORDER CODE
TYPE		
mounting bracket (1 piece)	8-25	038-60700
mounting bracket (25 pieces)	8-25	038-60700.25

number of brackets required: length of your system in metres+1

**Microsoft headquarters**

Vienna, AT – by INNOCAD Architektur ZT



Define your profile system

MINO system

EN The MINO system luminaire complements the multifaceted nature of the MINO single luminaire. Whether as a surface-mounted version for wall or ceiling mounting, or as a suspended version with an indirect light component, the MINO System luminaire is truly versatile. Using CURVE elements, which come in various radii, and CORNER elements, the luminaires are transformed into a continuous lighting system. With three standard and additional special colours available, MINO can be customised according to the desired room concept. You can also combine the light insets for homogeneous ambient lighting with an opal cover. Other options include the use of a wallwasher for a uniformly illuminated wall surface, or the microprismatic cover specially designed for workstations. Excellent colour rendering and three possible light colours complete the MINO system luminaire.

DE Die MINO Systemleuchte ergänzt den Facettenreichtum der MINO Einzel-leuchte. Ob als Anbauvariante für eine Wand- oder Deckenmontage oder in abgehängter Version mit Indirektlichtanteil: die MINO Systemleuchte ist vielseitig einsetzbar. Mittels CORNER und den in verschiedenen Radien erhältlichen CURVE Elementen verwandeln sich die einzelnen Leuchten in ein durchgehendes Lichtsystem. Durch drei Standardfarben und weitere erhältliche Spezialfarben lässt sich die MINO je nach gewünschtem Raumkonzept anpassen. Optional können Sie - auch stellenweise - die Lichteinsätze für eine homogene Grundbeleuchtung mit einem Opal-Cover kombinieren, einen Wallwasher für eine gleichmäßig ausgeleuchtete Wandfläche oder die speziell für Arbeitsplätze konzipierte mikroprismatische Abdeckung einsetzen. Die sehr gute Farbwiedergabe und drei mögliche Lichtfarben komplettieren die MINO Systemleuchte.

Types

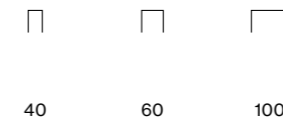

40 60 100

Mountings

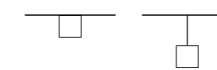

surface suspended

Configurations

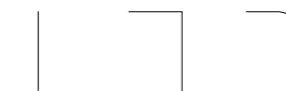

linear corner curve

Light distributions

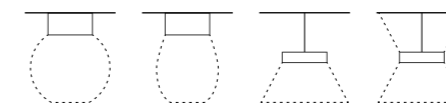

opal microprismatic
(UGR ≤ 19) direct direct
indirect

TW – Tunable White

EN Changes in the colour of light have a substantial effect on our mood. Tunable White allows the colour temperature to be continuously adjusted from 2700 K (warm light) to 6500 K (cool light) to dynamically adapt the lighting to the time of day or ambient brightness.

DE Veränderungen in der Lichtfarbe haben eine starke Wirkung auf unsere Stimmung. Tunable White ermöglicht die stufenlose Verschiebung der Farbtemperatur von 2700 K (warmes Licht) bis 6500 K (kühles Licht), um die Beleuchtung dynamisch an Uhrzeit oder Umgebungshelligkeit anzupassen.



Precise planning with flex insets

EN Your lighting system can be easily adapted to existing room dimensions. You can determine bespoke lengths for MINO. The special flex insets are precisely and flexibly adapted on-site during assembly. Boards are simply cut off at prefabricated breakpoints. This gives you a free hand and minimal restrictions in the lighting design.

DE Ihr Lichtsystem lässt sich einfach an vorhandene Raumdimensionen anpassen. Für MINO können Sie individuelle Längen bestimmen. Die speziellen Flex-Insets werden vor Ort bei der Montage exakt und flexibel angepasst: Platinen werden einfach an vorgefertigten Bruchstellen abgetrennt. Dadurch haben Sie freie Hand und kaum Einschränkungen bei der Lichtplanung.

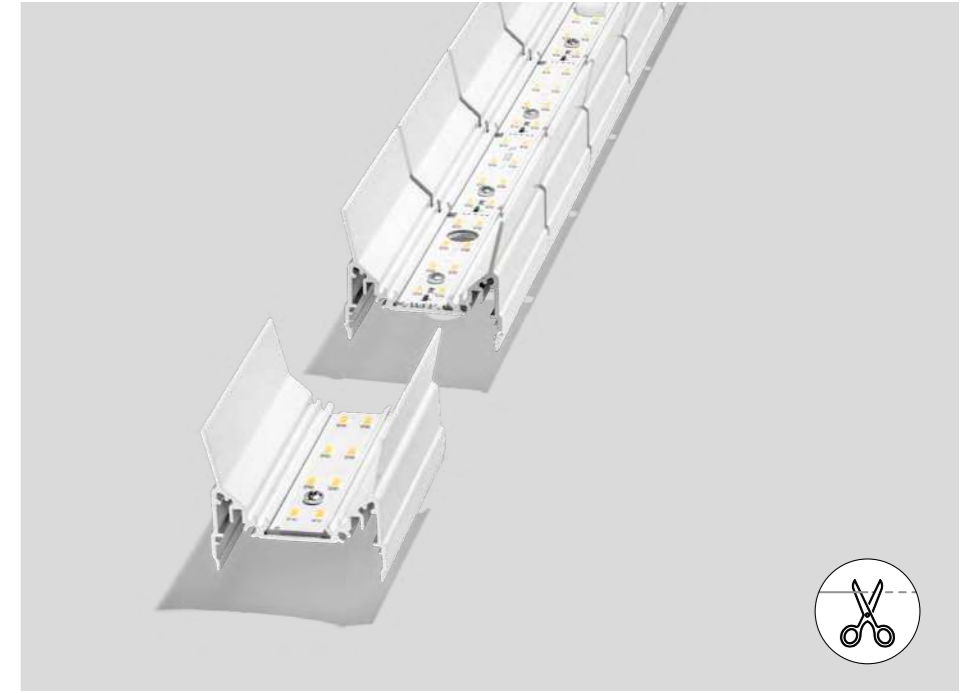

Full-spectrum LED

EN XAL's new XPECTRUM LEDs deliver healthy, biologically effective light. The reduced blue light component and increased cyan values reduce the blue light hazard for the eye to daylight-equivalent levels. The resulting non-visual, so-called melanopic light effect, improves concentration and increases sleep quality. The excellent colour rendering of IES TM 30-15 $R_f = 98$ and $R_g = 101$ further helps visual comfort.

DE Die neue XPECTRUM LED von XAL sorgt für gesundes, biologisch wirksames Licht. Der reduzierte Blaulichtanteil sowie die erhöhten Cyan-Werte minimieren die Blaulichtgefahr für das Auge auf ein tagelichtähnliches Niveau. Die daraus resultierende nichtvisuelle, auch melanopische Lichtwirkung genannt, fördert die Konzentration und steigert die Schlafqualität. Die hervorragende Farbwiedergabe von IES TM 30-15 $R_f = 98$ und $R_g = 101$ ermöglicht zudem einen verbesserten Sehkomfort.

XPECTRUM LED

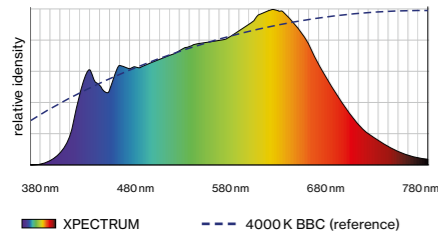

Commercially available LED 4000 K

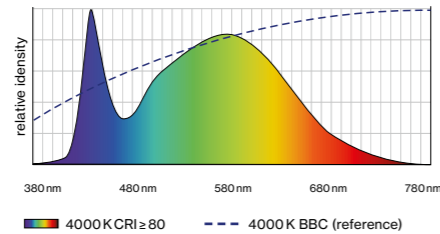

Colour variety

EN MINO is available in the standard colours black, grey, and white. Further colour variations are also available, granting your project maximum design freedom. You can learn more about our colour palette at xal.com/colours.

DE MINO ist in den Standardfarben Schwarz, Grau und Weiß erhältlich. Darüber hinaus stehen weitere Farbvarianten zur Verfügung – dies ermöglicht Ihnen einen maximalen Gestaltungsfreiraum bei Ihrem Projekt. Mehr zu unserer Farbpalette erfahren Sie auf xal.com/colours.



xal.com/colours

Curves & edges

EN Let your creativity run wild and combine straight profiles with precise corners or harmonious curves. The curve profiles are available in different radii to generate maximum design freedom.

DE Lassen Sie Ihrer Kreativität freien Lauf und verbinden Sie geradlinige Profile durch präzise Ecken oder harmonische Kurven. Die Kurvenprofile sind in unterschiedlichen Radien verfügbar, um maximalen Gestaltungsfreiraum zu generieren.



← back

MINO 40 system

ceiling/suspended

EN Luminaire housing from extruded aluminium profile, angular design; no visible screws; for lighting systems; powder coated; luminaire profile incl. light inset; cover in the length of the light inset or continuous cover (both separately available); pre-assembled power rail for power supply in luminaire profile; voltage tap of the light inset on the power rail; pendant fitting with cable suspension; height adjustment without tools; with transparent feeder cable; light inset consisting of highly reflective coated extruded profile for improved thermal management; HPO (High Performance Opal) cover for uniform illumination; energy-eff. LEDs – very good colour rendering

DE Leuchtenkörper aus Aluminiumstrangpressprofil, kantige Ausführung; keine sichtbaren Schrauben; für Lichtsysteme; pulverbeschichtet; Leuchtenprofil inkl. Lichteinsatz; Abdeckung in Lichteinsatzlänge oder durchgängige Abdeckung (beide separat zu bestellen); vormontierte Stromschiene zur Spannungsversorgung im Leuchtenprofil; Lichteinsatz-Spannungsabgriff an der Stromschiene; abgependelt mit Seilabhängung; werkzeuglose Höhenverstellung; inkl. transp. Einspeiseleitung; Lichteinsatz bestehend aus hochreflektierend lackiertem Strangpressprofil für verbessertes Thermomanagement; HPO (High Performance Opal) Abdeckung für homogene Ausleuchtung; energieeff. LEDs – sehr gute Farbwiedergabe

Quickinfo

3000K, 4000K
 CRI ≥ 90, 3 SDCM
 up to 2340lm/m
 up to 102lm/W
 L90 @ 50 000h
 DALI-2
 opal

Types

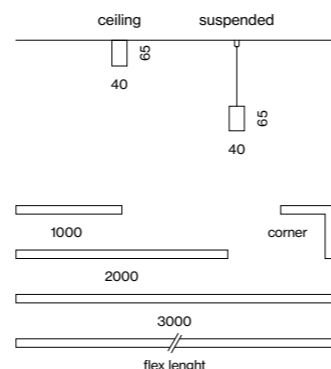

Colours



Light distribution

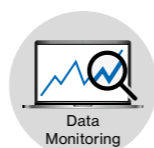

DiiA® standards
 251, 252, 253



single luminaire
 (p. 536)

flexible
 inset

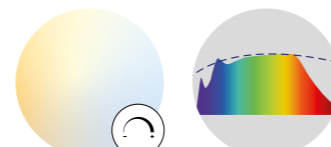

tunable white
 2700–6500K

CRI ≥ 98
 XPECTRUM

Order options

LED TYPE	
mid lumen	1
high lumen	2

COLOUR TEMPERATURE	
3000K	0
4000K	1

CONTROL
 DALI-2

MATERIAL COLOUR	
○ pure white RAL 9010	7
● white aluminium RAL 9006	G
● jet black RAL 9005	8
● special colours p. 992	X

LIGHT OPTIC COVER
 opal high performance

Options on request

COLOUR RENDERING INDEX
 CRI ≥ 98 XPECTRUM

COLOUR TEMPERATURE
 tunable white 2700–6500K

LIGHT OPTIC COVER
 microprismatic

LUMINOUS FLUX value calculated for
 CRI ≥ 90, colour white, cover opal

MINO 40 ceiling/suspended



INSTALLATION CHANNEL + LIGHT INSET

SYSTEM POWER (MID/HIGH LUMEN)	L (mm)	ORDER CODE
15.3/22.9W	1000	0 4 2 - 1 0 A 2 3 3
30.5/46W	2000	0 4 2 - 1 0 A 4 3 3
46/69W	3000	0 4 2 - 1 0 A 6 3 3
15.3/22.9W flex	500–1000	0 4 2 - 1 0 A F 3 3
30.5/46W flex	1500–2000	0 4 2 - 1 0 A G 3 3
15.3/22.9W corner	500×500	0 4 2 - 1 0 A C 3 3

COVER	COLOUR TEMP.	SYSTEM POWER	DELIVERED LUMENS	EFFICACY
mid lumen/opal	3000K	15.3 W/m	1480lm/m	97lm/W
high performance	4000K		1560lm/m	102lm/W
high lumen/opal	3000K	22.9 W/m	2210lm/m	97lm/W
high performance	4000K		2340lm/m	102lm/W

LIGHT OPTIC COVER 40

TYPE	L (mm)	ORDER CODE
linear	1000	0 0 6 - 2 2 0 1 1 H
linear	2000	0 0 6 - 2 2 0 2 1 H
linear	3000	0 0 6 - 2 2 0 3 1 H
corner	500 × 500	0 0 6 - 2 2 0 C 1 H
continuous linear	6000	0 0 6 - 2 2 0 6 1 H
continuous linear	30000	0 0 6 - 2 2 3 0 1 H

Accessories



END CAPS	ORDER CODE
TYPE end caps (pair)	0 4 2 - 1 0 9 0 0 1



CHANNEL + BLIND COVER	L (mm)	ORDER CODE
TYPE linear	1000	0 4 2 - 1 0 9 4 2 1
linear	2000	0 4 2 - 1 0 9 4 4 1
linear	3000	0 4 2 - 1 0 9 4 6 1
corner	500 × 500	0 4 2 - 1 0 9 4 C 1



POWER FEEDER UNIT	ORDER CODE
TYPE power feeder unit	0 4 2 - 1 0 9 3 2 3 0



LINEAR CONNECTOR	ORDER CODE
TYPE mechanical linear connector	0 4 2 - 7 0 9 1 1 1 0
mechanical + electrical linear connector	0 4 2 - 7 0 9 1 2 1 0
opal cover linear connector	0 4 2 - 1 0 9 1 9 1 0

CEILING FASTENER/CABLE SUSPENSION/CANOPY

TYPE	L (mm)	ORDER CODE
ceiling fastener	10	0 5 0 - 2 0 4 1 1 1
cable suspension	1500	0 0 5 - 2 1 5 2 1 1 0
canopy		0 0 5 - 2 3 1 1 2 1
feeder cable (transparent)		0 0 5 - 2 4 1 2 4 1 0

for electrical system configuration see luminaire data sheet at xal.com

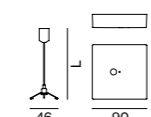

← back

MINO 60 system

ceiling / suspended

EN Luminaire housing from extruded aluminium profile, angular design; no visible screws; for lighting systems; powder coated; luminaire profile for mounting available in advance; remaining components mounted without tools; pendant fitting with cable suspension; height adjustment without tools; spring clip attachment to the luminaire; with transparent feeder cable; light inset consisting of highly reflective coated extruded profile for improved thermal management; option: lighting module is versatile in length; HPO (High Performance Opal) cover for uniform illumination; micro prismatic PMMA diffuser incl. diffuser film for homogeneous illumination and reduced luminance; wallwasher light inset; energy-eff. LEDs – very good colour rendering

DE Leuchtenkörper aus Aluminiumstrangpressprofil, kantige Ausführung; keine sichtbaren Schrauben; für Lichtsysteme; pulverbeschichtet; Leuchtenprofil für Montage vorab lieferbar; restl. Komponenten werkzeuglos montierbar; abgependelt mit Seilabhängung; werkzeuglose Höhenverstellung; Federclips-Befestigung an der Leuchte; inkl. transp. Einspeiseleitung; Lichteinsatz bestehend aus hochreflektierend lackiertem Strangpressprofil für verbessertes Thermomanagement; optional flexibel ablängbarer Lichteinsatz; HPO (High Performance Opal) Abdeckung für homogene Ausleuchtung; mikroprismatische PMMA-Abdeckung inkl. Diffusorfolie zur Reduktion der Leuchtdichte bei homogener Ausleuchtung; Wallwasher Lichteinsatz; energieeff. LEDs – sehr gute Farbwiedergabe

Quickinfo

3000K, 4000K, TW
 CRI ≥ 80, CRI ≥ 90, 3 SDCM
 up to 2760 lm/m
 up to 125 lm/W
 L90 @ 50 000h
 non DIM, DALI-2
 opal, microprismatic (UGR ≤ 19)

Types

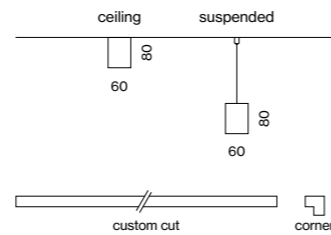

Colours



Light distributions



DiiA® standards
251, 252, 253



single luminaire
(p.544)



wallwasher
inset (p.944)

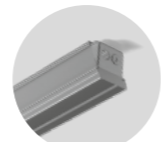

concrete install.
housing (p.946)



flexible
inset

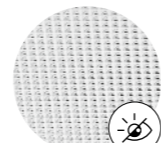

microprismatic
UGR ≤ 19



tunable white
2700 – 6500 K

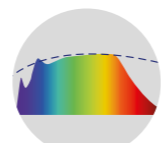

CRI ≥ 98
XPECTRUM

Order options

LED TYPE	
mid lumen	L
high lumen	M

COLOUR TEMPERATURE	
3000 K (CRI ≥ 90)	0
4000 K (CRI ≥ 90)	1
3000 K (CRI ≥ 80)	5
4000 K (CRI ≥ 80)	6
tunable white 2700–6500 K*	

*DALI-2 DT8

CONTROL	
non DIM	1
DALI-2 (only high lumen)	3

MATERIAL COLOUR	
pure white RAL 9010	7
white aluminium RAL 9006	G
jet black RAL 9005	8
special colours p.992	X

LIGHT OPTIC COVER	
opal high performance	H
microprismatic	Z
microprismatic (UGR ≤ 19)*	G
blind cover only for corner 90°	B

*UGR ≤ 19 only with mid lumen

EMERGENCY LIGHT	
1h Accupack	N L 1
3h Accupack	N L 3

Options on request

COLOUR RENDERING INDEX	
CRI ≥ 98 XPECTRUM	

CONNECTORS	
X- and T-connector	

LUMINOUS FLUX value calculated for CRI ≥ 80, colour white, cover opal microprismatic -13%

MINO 60 ceiling / suspended



INSTALLATION CHANNEL / CORNER 90°	L (mm)	ORDER CODE
channel	1172	046-400401
channel	1472	046-400501
channel	3000	046-400901
channel	custom	E85031
channel corner 90° + cover	150x150	046-401121



LIGHT OPTIC COVER / BLIND COVER	L (mm)	ORDER CODE
linear	1171	006-16122
linear	1470	006-16152
linear	2997	006-16302
linear	custom	E80630
corner	500x500	006-220C1H
continuous linear	6000	006-23061H
continuous linear	25000	006-23251H
blind cover	3000	006-1830
blind cover	custom	E80630

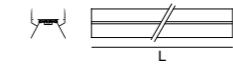

LIGHT INSET 60	SYSTEM POWER (MID/HIGH LUMEN)	L (mm)	ORDER CODE
	8.7 / 13.8 W	571	007-932
	13 / 20.6 W	871	007-933
	15.3 / 27.5 W	1171	007-934
	19.2 / 34 W	1463	007-935
	31 / 55 W	2341	007-938
	38 / 68 W	2997	007-939
	15.3 / 27.5 W flex	660-1171	007-93F
	31 / 55 W flex	1903-2341	007-93G

COVER	COLOUR TEMP.	SYSTEM POWER	DELIVERED LUMENS	EFFICACY
mid lumen / opal	3000 K	14 W/m	1540 lm/m	118 lm/W
high performance	4000 K		1640 lm/m	125 lm/W
high lumen / opal	3000 K	24 W/m	2540 lm/m	110 lm/W
high performance	4000 K		2700 lm/m	116 lm/W

LIGHT INSET 60 tunable white 2700–6500K	SYSTEM POWER	L (mm)	ORDER CODE
	12 W	871	007-9333D37
	14.1 W	1171	007-9334D37
	17.6 W	1463	007-9335D37
	28.2 W	2341	007-9338D37

Accessories



END CAPS	ORDER CODE
end caps (pair)	046-501001



LINEAR CONNECTOR / THROUGH WIRE	ORDER CODE
linear connector (1 piece)	005-40046
linear connector (10 pieces)	005-40046.10
opal cover linear connector	006-14000
through wire 3 × 1.5 mm ² (non DIM, 10 pieces)	004-90003
through wire 5 × 1.5 mm ² (DALI-2, 10 pieces)	004-90005



CEILING CLIP / CABLE SUSPENSION / CANOPY	L (mm)	ORDER CODE
ceiling clip	10	034-11636
cable suspension	1500	005-2122110
canopy / feeder cable 3 × 1.5 mm ²	1500	005-221231
canopy / feeder cable 5 × 1.5 mm ²	1500	005-221241
cable rail	1200	005-2491110

for electrical system configuration see luminaire data sheet at xal.com

← back



MINO 60 CURVE system

ceiling / suspended

EN Circular segment of rolled aluminium profile, angular design, seamlessly welded; no visible screws; for lighting systems; powder coated; luminaire profile for mounting available in advance; remaining components mounted without tools; pendant fitting with cable suspension; height adjustment without tools; spring clip attachment to the luminaire; freely positionable; with transparent feeder cable; light inset consisting of highly reflective coated die-cast aluminium for improved thermal management; HPO (High Performance Opal) cover for uniform illumination; micro prismatic PMMA diffuser incl. diffuser film for homogeneous illumination and reduced luminance; energy-eff. LEDs – very good colour rendering

DE Kreissegment aus gerolltem Aluminiumprofil, kantige Ausführung, nahtlos verschweißt; keine sichtbaren Schrauben; für Lichtsysteme; pulverbeschichtet; Leuchtenprofil für Montage vorab lieferbar; restl. Komponenten werkzeuglos montierbar; abgependelt mit Seilabhängung; werkzeuglose Höhenverstellung; Federclips-Befestigung an der Leuchte; frei positionierbar; inkl. transp. Einspeiseleitung; Lichteinsatz bestehend aus hochreflektierend lackiertem Aluminiumdruckguss für verbessertes Thermomanagement; HPO (High Performance Opal) Abdeckung für homogene Ausleuchtung; mikroprismatische PMMA-Abdeckung inkl. Diffusorfolie zur Reduktion der Leuchtdichte bei homogener Ausleuchtung; energieeff. LEDs – sehr gute Farbwiedergabe

Quickinfo

3000K, 4000K
 CRI ≥ 80, 3 SDCM
 up to 2850lm/m
 up to 125lm/W
 L90 @ 50 000h
 non DIM, DALI-2
 opal, microprismatic

Types

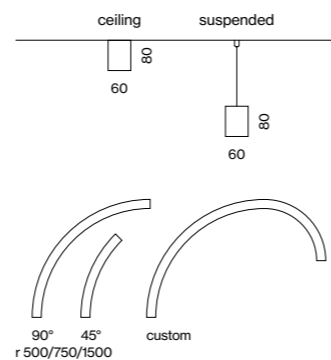

Colours



Light distributions



Order options

LED TYPE
 mid lumen 4
 high lumen 5

COLOUR TEMPERATURE
 3000K 5
 4000K 6

CONTROL
 non DIM 1
 DALI-2 (only high lumen) 3

MATERIAL COLOUR
 pure white RAL 9010 7
 white aluminium RAL 9006 G
 jet black RAL 9005 8
 special colours p. 992 X

LIGHT OPTIC COVER
 opal high performance H
 microprismatic Z

Options on request

COLOUR RENDERING INDEX
 CRI ≥ 90
 CRI ≥ 98 XPECTRUM

LIGHT OPTIC COVER
 microprismatic (UGR ≤ 19)

MINO 60 CURVE ceiling/suspended

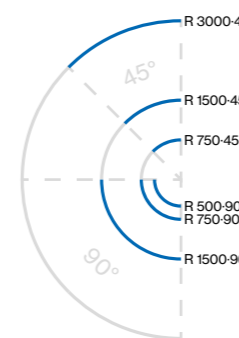

INSTALLATION CHANNEL + LIGHT INSET + LIGHT OPTIC COVER

SYSTEM POWER (MID/HIGH LUMEN)	R (mm)	ORDER CODE
12.8 / 16.3 W	500-90°	034-09 5 5 :: ▣ ▣
10.2 / 12.8 W	750-45°	034-09 0 0 :: ▣ ▣
18.1 / 26.1 W	750-90°	034-09 1 1 :: ▣ ▣
18.1 / 26.1 W	1500-45°	034-09 2 2 :: ▣ ▣
36 / 52 W (2×DALI)	1500-90°	034-09 3 3 :: ▣ ▣
36 / 52 W (2×DALI)	3000-45°	034-09 4 4 :: ▣ ▣

COVER	COLOUR TEMP.	SYSTEM POWER	DELIVERED LUMENS	EFFICACY
mid lumen / opal	3000 K	16 W/m	1780 lm/m	116 lm/W
high performance	4000 K		1880 lm/m	122 lm/W
high lumen / opal	3000 K	22 W/m	2420 lm/m	110 lm/W
high performance	4000 K		2560 lm/m	116 lm/W

Accessories

END CAPS

TYPE	ORDER CODE
end caps (pair)	034-090201 ▣

LINEAR CONNECTOR

TYPE	ORDER CODE
linear to curve profile	005-40159
curve to curve profile	005-40158
opal cover linear connector	006-14000

CEILING CLIP / CABLE SUSPENSION / CANOPY

TYPE	L (mm)	ORDER CODE
ceiling clip	10	034-11636
cable suspension	1500	005-2122110
canopy / feeder cable 3 × 1.5 mm ²	1500	005-221231 ▣
canopy / feeder cable 5 × 1.5 mm ²	1500	005-221241 ▣
cable rail	1200	005-2491110

for electrical system configuration see luminaire data sheet at xal.com

THROUGH WIRE

TYPE	ORDER CODE
3 × 1.5 mm ² (non DIM, 10 pieces)	004-90003
5 × 1.5 mm ² (DALI-2, 10 pieces)	004-90005



DiiA® standards
 251, 252, 253

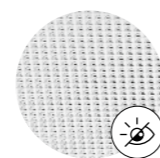

microprismatic
 UGR ≤ 19

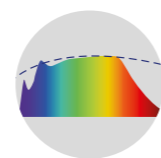

CRI ≥ 98
 XPECTRUM

LUMINOUS FLUX value calculated for CRI ≥ 80, colour white, cover opal microprismatic -13%

← back



MINO 60 direct/indirect system

ceiling / suspended

EN Luminaire housing from extruded aluminium profile, angular design; direct/indirect light distribution; no visible screws; designed for continuous lighting systems; surface powder coated; pendant fitting with cable suspension; with integrated tool-less suspension height adjustment; spring clip attachment to the luminaire; freely positionable; incl. transparent feed; light inset consisting of highly reflective coated extruded profile for improved thermal management; HPO (High Performance Opal) cover for uniform illumination; micro prismatic PMMA diffuser incl. diffuser film for homogeneous illumination and reduced luminance; energy-efficient LEDs with very good colour rendering

DE Leuchtenkörper aus Aluminiumstrangpressprofil, kantige Ausführung; direkt / indirekte Abstrahlcharakteristik; keine sichtbaren Schrauben; ausgelegt für durchgehende Lichtsysteme; Oberfläche pulverbeschichtet; abgependelt mit Seilabhangung; werkzeuglose Hohenverstellung an der Leuchte; Befestigung an der Leuchte mittels Federclips; frei positionierbar; inkl. transparenter Einspeiseleitung; Lichteinsatz bestehend aus hochreflektierend lackiertem Strangpressprofil fur verbessertes Thermomanagement; HPO (High Performance Opal) Abdeckung fur homogene Ausleuchtung; mikroprismatische PMMA-Abdeckung inkl. Diffusorfolie zur Reduktion der Leuchtdichte bei homogener Ausleuchtung; energieeffiziente LEDs mit sehr guter Farbwiedergabe

Quickinfo

3000K, 4000K
 CRI ≥ 80, 3 SDCM
 up to ↓ 2470 / ↑ 1610 lm/m
 up to 120 lm/W
 L90 @ 50 000h
 non DIM, DALI-2
 opal, microprismatic (UGR ≤ 19)

Types

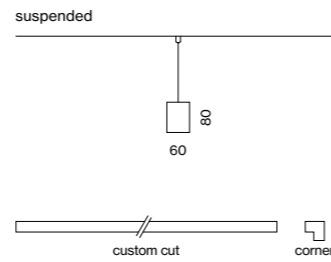

Colours



Light distributions



Order options

LED TYPE
 mid lumen 1
 high lumen 2

COLOUR TEMPERATURE
 3000K 5
 4000K 6

CONTROL
 non DIM 1
 DALI-2 (only high lumen) 3

MATERIAL COLOUR
 ○ pure white RAL 9010 7
 ● white aluminium RAL 9006 G
 ● jet black RAL 9005 8
 ● special colours p. 992 X

LIGHT OPTIC COVER
 opal high performance H
 microprismatic (UGR ≤ 19) Z

Options on request

COLOUR RENDERING INDEX
 CRI ≥ 90
 CRI ≥ 98 XPECTRUM

CHANNEL LENGTH
 3000mm

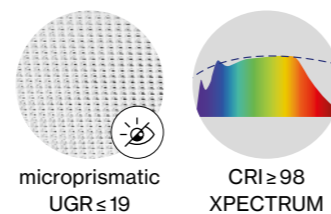
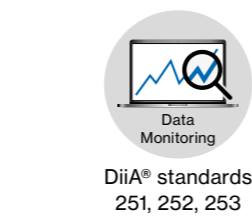

Light distributions

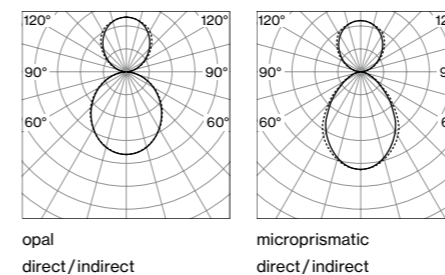

LUMINOUS FLUX value calculated for
 CRI ≥ 80, colour white, cover opal
 microprismatic -13%

MINO 60 direct/indirect suspended

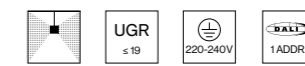

INSTALLATION CHANNEL + LIGHT INSET + LIGHT OPTIC COVER

SYSTEM POWER (MID/HIGH LUMEN)	L (mm)	ORDER CODE
20.1W/31W	872	0 4 6 - 5 0 3 :: □ □ □
26.8W/41W	1172	0 4 6 - 5 0 4 :: □ □ □
34W/51W	1464	0 4 6 - 5 0 5 :: □ □ □
40W/62W	1756	0 4 6 - 5 0 6 :: □ □ □
54W/82W	2344	0 4 6 - 5 0 8 :: □ □ □
26.8W corner / mid lumen	625x625	0 4 6 - 5 0 5 1 :: □ □ □
42W corner / high lumen	625x625	0 4 6 - 5 0 6 1 :: □ □ □

COVER	COLOUR TEMP.	SYSTEM POWER	DIRECT LUMENS	INDIRECT LUMENS	EFFICACY
mid lumen/	3000K	22W/m	1490lm/m	950lm/m	113lm/W
opal high p.	4000K		1440lm/m	1010lm/m	120lm/W
high lumen/	3000K	35W/m	2330lm/m	1520lm/m	108lm/W
opal high p.	4000K		2470lm/m	1610lm/m	115lm/W

BLIND CHANNEL / BLIND COVER

blind channel	custom	E 8 5 0 3 1 □
blind cover	custom	E 8 0 6 3 0 □ B

Accessories



END CAPS	ORDER CODE
TYPE end caps (pair)	0 4 6 - 5 0 1 0 0 1 □

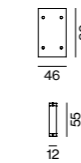

LINEAR CONNECTOR	ORDER CODE
TYPE linear connector (1 piece)	0 0 5 - 4 0 0 4 6
linear connector (10 pieces)	0 0 5 - 4 0 0 4 6 . 1 0
opal cover linear connector	0 0 6 - 1 4 0 0 0

CABLE SUSPENSION / CANOPY

TYPE	L (mm)	ORDER CODE
cable suspension	1500	0 0 5 - 2 1 2 2 1 1 0
canopy / feeder cable 3 × 1.5 mm ²	1500	0 0 5 - 2 2 1 2 3 1 □
canopy / feeder cable 5 × 1.5 mm ²	1500	0 0 5 - 2 2 1 2 4 1 □
cable rail	1200	0 0 5 - 2 4 9 1 1 1 0

for electrical system configuration see luminaire data sheet at xal.com

THROUGH WIRE

TYPE	ORDER CODE
3 × 1.5 mm ² (non DIM, 10 pieces)	0 0 4 - 9 0 0 0 3
5 × 1.5 mm ² (DALI-2, 10 pieces)	0 0 4 - 9 0 0 0 5

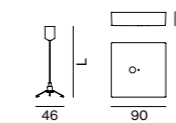



Feucht Mode Innsbruck, AT –
by blocher partners with lighting design
by Hallight Lichtplanung, Andreas Haidegger

Airport Singapore T4 Terminal
Singapore, SG - by Snohetta

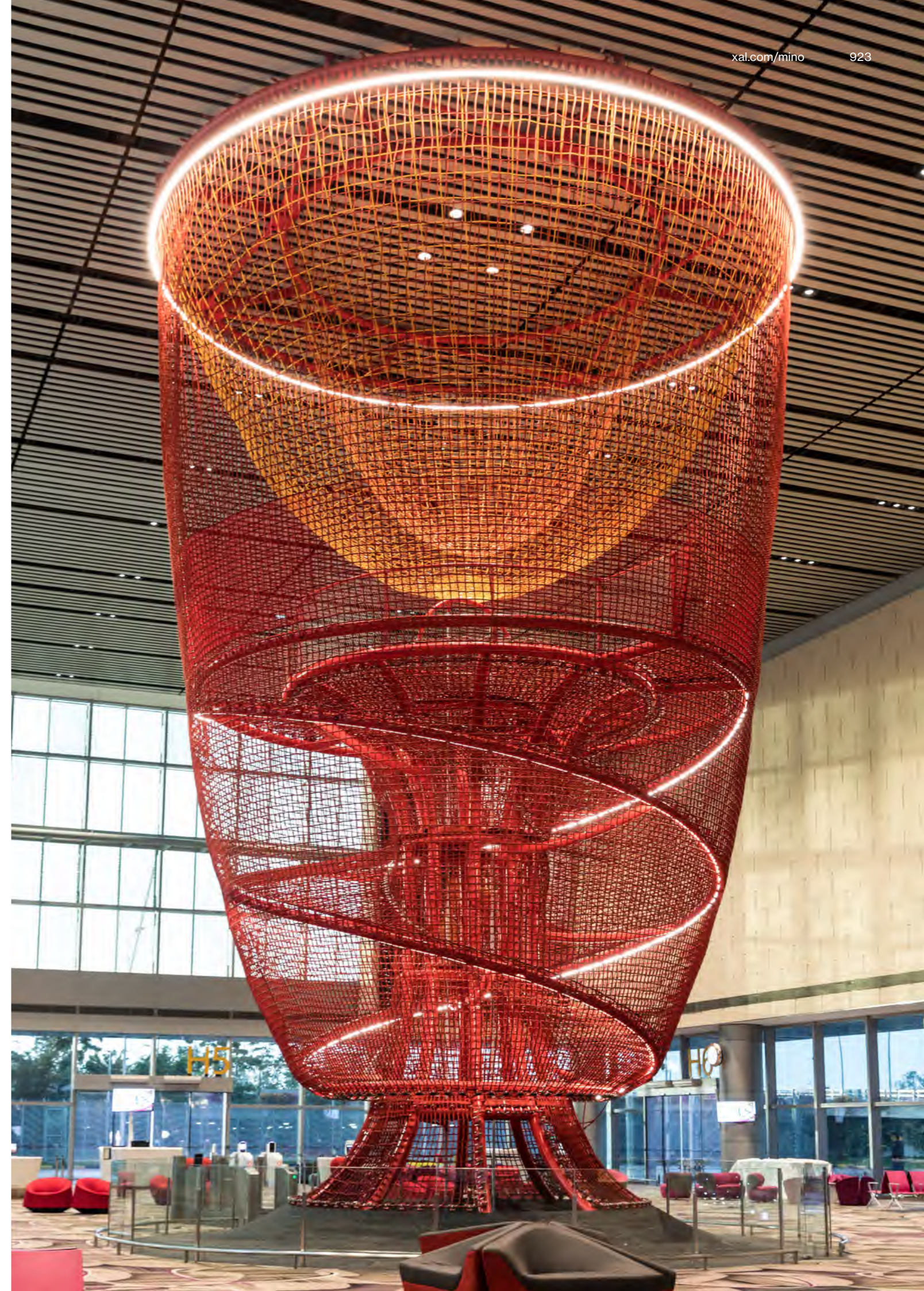
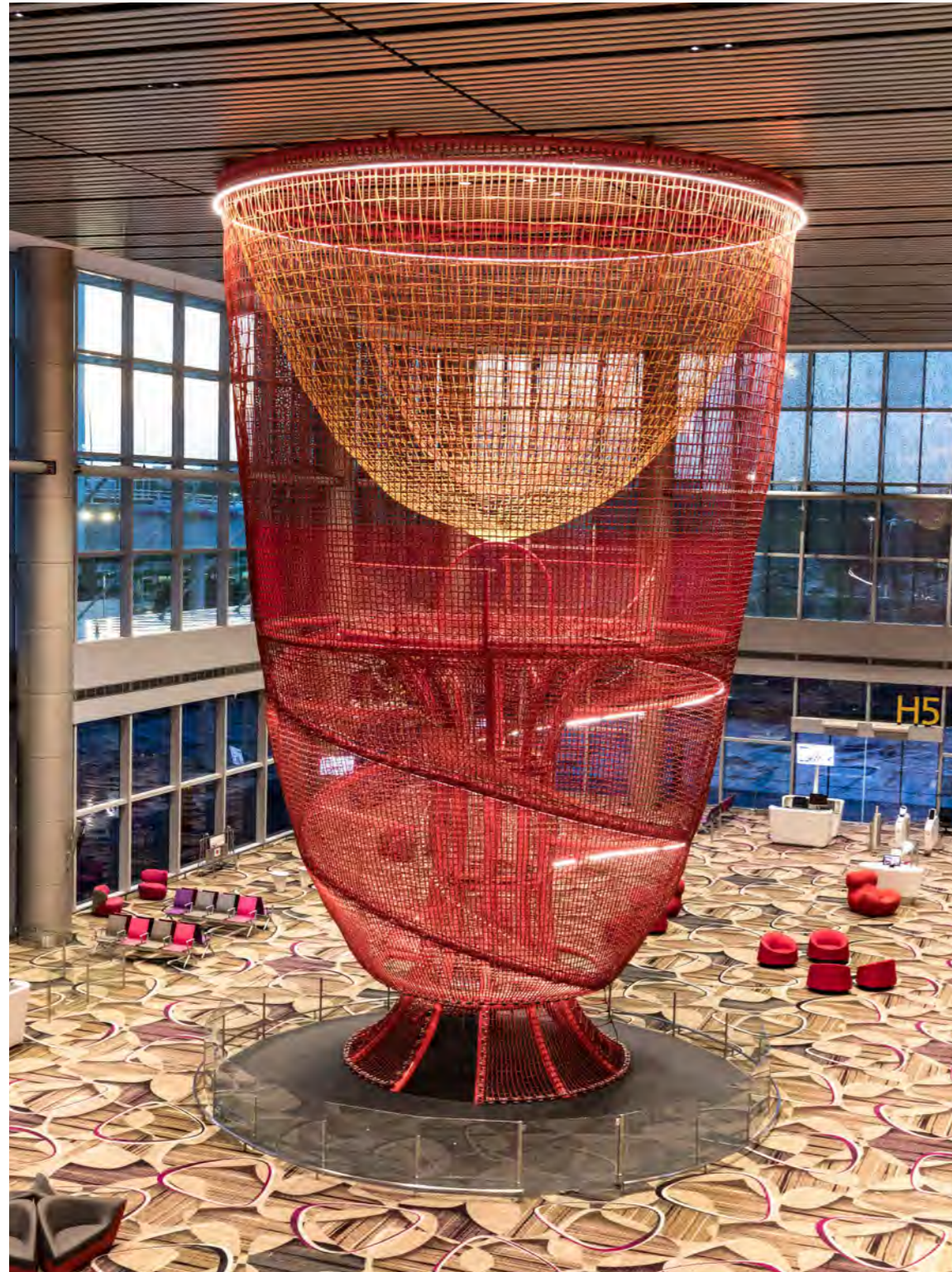



WKO Vienna, AT –
by Architekturconsult with lighting
design by Hailight Lichtplanung,
Andreas Haidegger



← back

MINO 100 system

ceiling / suspended

EN Luminaire housing from extruded aluminium profile, angular design; no visible screws; for lighting systems; powder coated; luminaire profile for mounting available in advance; remaining components mounted without tools; pendant fitting with cable suspension; height adjustment without tools; spring clip attachment to the luminaire; with transparent feeder cable; light inset consisting of highly reflective coated extruded profile for improved thermal management; option: lighting module is versatile in length; HPO (High Performance Opal) cover for uniform illumination; micro prismatic PMMA diffuser incl. diffuser film for homogeneous illumination and reduced luminance; wallwasher light inset; energy-eff. LEDs – very good colour rendering

DE Leuchtenkörper aus Aluminiumstrangpressprofil, kantige Ausführung; keine sichtbaren Schrauben; für Lichtsysteme; pulverbeschichtet; Leuchtenprofil für Montage vorab lieferbar; restl. Komponenten werkzeuglos montierbar; abgependelt mit Seilabhängung; werkzeuglose Höhenverstellung; Federclips-Befestigung an der Leuchte; inkl. transp. Einspeiseleitung; Lichteinsatz bestehend aus hochreflektierend lackiertem Strangpressprofil für verbessertes Thermomanagement; optional flexibel abblängbarer Lichteinsatz; HPO (High Performance Opal) Abdeckung für homogene Ausleuchtung; mikroprismatische PMMA-Abdeckung inkl. Diffusorfolie zur Reduktion der Leuchtdichte bei homogener Ausleuchtung; Wallwasher Lichteinsatz; energieeff. LEDs – sehr gute Farbwiedergabe

Quickinfo

3000K, 4000K, TW
 CRI ≥ 80, CRI ≥ 90, 3 SDCM
 UGR ≤ 19 / 65° ≤ 3000 cd/m²
 up to 3090 lm/m
 up to 140 lm/W
 L90 @ 50 000h
 non DIM, DALI-2
 opal, microprismatic (UGR ≤ 19)

Types

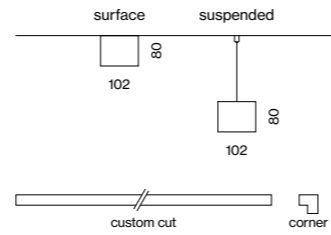

Colours



Light distributions



DiiA® standards
251, 252, 253



single luminaire
(p.552)



wallwasher
inset (p.944)

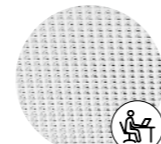

DIN EN 12464-1
UGR ≤ 19



flexible
inset

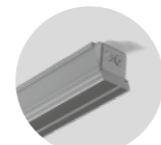

concrete install.
housing (p.946)



tunable white
2700–6500 K

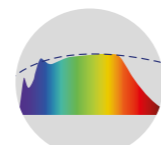

CRI ≥ 98
XPECTRUM

Order options

LED TYPE	
mid lumen	L
high lumen	M

COLOUR TEMPERATURE	
3000 K (CRI ≥ 90)	0
4000 K (CRI ≥ 90)	1
3000 K (CRI ≥ 80)	5
4000 K (CRI ≥ 80)	6
tunable white 2700–6500 K*	

*DALI-2 DT8

CONTROL	
non DIM	1
DALI-2 (only high lumen)	3

MATERIAL COLOUR	
○ pure white RAL 9010	7
● white aluminium RAL 9006	G
● jet black RAL 9005	8
● special colours p.992	X

LIGHT OPTIC COVER	
opal high performance	H
microprismatic	Z
microprismatic (UGR ≤ 19)*	G
blind cover**	B

*UGR ≤ 19 only with mid lumen
 **only for channel corner 90°

EMERGENCY LIGHT	
1h Accupack	N L 1
3h Accupack	N L 3

Options on request

COLOUR RENDERING INDEX	
CRI ≥ 98 XPECTRUM	

LUMINOUS FLUX value calculated for
 CRI ≥ 80, colour white, cover opal
 microprism. Z -8%, microprism. G -10%

MINO 100 ceiling /suspended

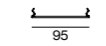
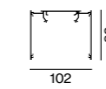

INSTALLATION CHANNEL /CORNER 90°	L (mm)	ORDER CODE
channel	1172	034-0126
channel	1472	034-0156
channel	3000	034-0306
channel	custom	E85050
channel corner 90° + cover	200x200	034-1266

LIGHT OPTIC COVER /BLIND COVER	L (mm)	ORDER CODE
linear	1171	006-12122
linear	1470	006-12152
linear	2997	006-12302
linear	custom	E80650
corner	500x500	006-220C1H
blind cover	3000	006-1130
blind cover	custom	E80650

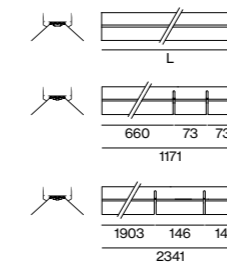
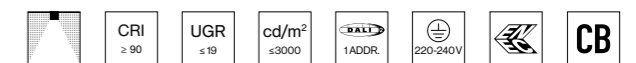

LIGHT INSET 100	L (mm)	ORDER CODE
SYSTEM POWER (MID/HIGH LUMEN)		
8.7 / 13.8 W	571	007-862
13 / 20.6 W	871	007-863
15.3 / 27.5 W	1171	007-864
19.2 / 34 W	1463	007-865
31 / 55 W	2341	007-868
38 / 68 W	2997	007-869
15.3 / 27.5 W flex	660-1171	007-86F
31 / 55 W flex	1903-2341	007-86G

COVER	COLOUR TEMP.	SYSTEM POWER	DELIVERED LUMENS	EFFICACY
mid lumen / opal	3000 K	14 W/m	1770 lm/m	132 lm/W
high performance	4000 K		1870 lm/m	140 lm/W
high lumen / opal	3000 K	24 W/m	2920 lm/m	123 lm/W
high performance	4000 K		3090 lm/m	130 lm/W

LIGHT INSET 100 tunable white 2700–6500 K	L (mm)	ORDER CODE
SYSTEM POWER		
12 W	871	007-8633D37
14.1 W	1171	007-8634D37
17.6 W	1463	007-8635D37
28.2 W	2341	007-8638D37

Accessories

END CAPS	ORDER CODE
TYPE	
end caps (pair)	034-1306

LINEAR CONNECTOR / THROUGH WIRE	ORDER CODE
TYPE	
linear connector (1 piece)	005-40066
linear connector (10 pieces)	005-40066.10
opal cover linear connector	006-10000
through wire 3 × 1.5 mm² (non DIM, 10 pieces)	004-90003
through wire 5 × 1.5 mm² (DALI-2, 10 pieces)	004-90005

CEILING CLIP /CABLE SUSPENSION/CANOPY	L (mm)	ORDER CODE
TYPE		
ceiling clip	10	034-11836
cable suspension	1500	005-2132110
canopy /feeder cable 3 × 1.5 mm²	1500	005-221231
canopy /feeder cable 5 × 1.5 mm²	1500	005-221241
cable rail	1200	005-2491110

for electrical system configuration see luminaire data sheet at xal.com

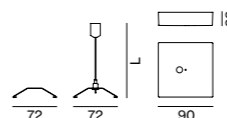



Office Amazon Prague, CZ –
by HLW with lighting design by U1 lighting

**Compound Semiconductor
Applications Catapult**
South Wales, UK –
by Monteith Scott



Adjust your profile system

BASO IP54 system

EN BASO IP54 is a powerful profile luminaire that has been specially adapted to demanding environmental conditions: from public outdoor areas to wet rooms. It has increased dust and insect protection (IP54). BASO IP54 is available as a single luminaire or as a system variant. It is easy to install and suitable for recessed or surface fitting as well as for wall or ceiling mounting. An opal cover delivers homogeneous basic illumination. The luminaire has a colour rendering of up to $\text{CRI} \geq 90$ and can be selected with a dark grey or white housing and in two light colours (3000 K and 4000 K).

DE BASO IP54 ist eine leistungsstarke Profilleuchte, die speziell an fordernde Umgebungsbedingungen angepasst wurde: von öffentlichen Outdoor-Bereichen bis hin zu Nassräumen. Zudem verfügt sie über einen erhöhten Staub- und Insektenschutz (IP54). BASO IP54 ist als Einzelleuchte oder als Systemvariante verfügbar, einfach zu montieren und sowohl für Ein- oder Anbau als auch für Wand- oder Deckenmontage geeignet. Eine Opal-Abdeckung sorgt für homogene Grundausleuchtung. Außerdem verfügt die Leuchte über eine Farbwiedergabe von bis zu $\text{CRI} \geq 90$ und kann mit dunkelgrauem oder weißem Gehäuse sowie in zwei Lichtfarben (3000 K und 4000 K) gewählt werden.

Type



60

Mountings

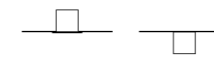
trim
recessed

surface

Configurations



linear

corner

Light distribution

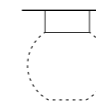

opal

← back



BASO 60 IP54 system

recessed with trim

EN Luminaire housing made of extruded aluminium; recessed luminaire with trim; suitable for ceiling thickness of 8-20 mm; surface powder coated; suitable for wall or ceiling mounting; luminaire profile (end caps come pre-assembled) can be pre-mounted; remaining luminaire components mounted without tools; closed light insert made of PMMA, consisting of converter unit and circuit board unit; light inset with screwed-on, thus maintenance-friendly, transparent end cap in PMMA; HPO (High Performance Opal) cover for uniform illumination; energy-efficient LEDs with very good colour rendering; IP 67 socket connector system for easy and sealed electrical connection

DE Leuchtenkörper aus Aluminiumstrangpressprofil; Einbauleuchte mit umlaufendem Rand; geeignet für Deckenstärken von 8-20 mm; Oberfläche pulverbeschichtet; geeignet für Wand- oder Deckenmontage; Leuchtenprofil (Enddeckel werkseitig vormontiert) vorab montierbar; restliche Leuchtenkomponenten werkzeuglos montierbar; geschlossener Lichteinsatz aus PMMA, bestehend aus Konvertereinheit und Platineneinheit; Lichteinsatz mit verschraubtem, dadurch wartungsfreundlichen, transparenten PMMA Enddeckel; HPO (High Performance Opal) Abdeckung für homogene Ausleuchtung; energieeffiziente LEDs mit sehr guter Farbwiedergabe; IP67-Buchsen-Stecker-system für dichten elektrischen Anschluss

Quickinfo

3000K, 4000K
 CRI ≥ 80, 3 SDCM
 up to 2340 lm/m
 up to 125 lm/W
 L90 @ 50 000h
 DALI-2
 opal, IP 54

Types

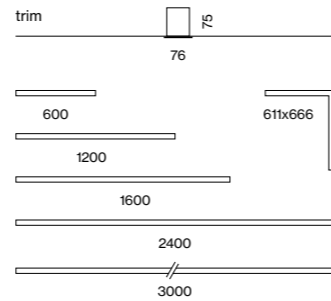

Colours



Light distribution



quick installation

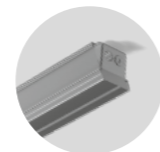

concrete install. housing (p.946)



single luminaire housing (p.558)



dust & splash water protection (IP54)

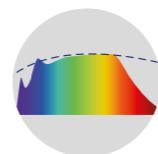

CRI ≥ 98 XPECTRUM

Order options

COLOUR TEMPERATURE	
3000K	5
4000K	6

CONTROL

DALI-2

MATERIAL COLOUR

- traffic white RAL 9016 7
- umbra grey RAL 7022 D

LIGHT OPTIC COVER

opal high performance

Options on request

COLOUR RENDERING INDEX

CRI ≥ 90

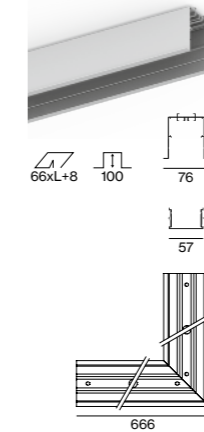

BASO 60 IP54 trim

INSTALLATION CHANNEL / CORNER 90° / BLIND COVER

TYPE	L (mm)	ORDER CODE
channel	600	845-340201
channel	1200	845-340401
channel	1600	845-340501
channel	2400	845-340801
channel	3000	845-340901
corner connector 90°	611x666	845-341121
blind cover	600	006-330601
blind cover	1200	006-331201
blind cover	1600	006-331601
blind cover	2400	006-332401
blind cover	3000	006-333001

order installation channel, light inset + mounting accessories separately

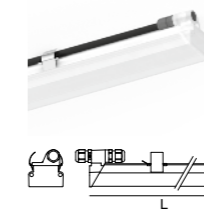

LIGHT INSET 60 IP54



SYSTEM POWER	L (mm)	ORDER CODE
11.2W start/run	599	845-4042::30H
22.4W start/run	1198	845-4044::30H
29.9W start/run	1597	845-4045::30H
45W start/run	2396	845-4048::30H
11.2W end	599	845-4052::30H
22.4W end	1198	845-4054::30H
29.9W end	1597	845-4055::30H
45W end	2396	845-4058::30H

COVER	COLOUR TEMP.	SYSTEM POWER	DELIVERED LUMENS	EFFICACY
opal high performance	3000K	18.8W/m	2210lm/m	118lm/W
	4000K	18.8W/m	2340lm/m	124lm/W

Accessories

END CAPS

TYPE	ORDER CODE
end caps (pair)	845-341001

MOUNTING BRACKET

TYPE	ORDER CODE
mounting bracket (1 piece)	045-3412010
mounting bracket (10 pieces)	045-3412010.10

LINEAR CONNECTOR

TYPE	ORDER CODE
linear connector (1 piece)	045-4011110
linear connector (10 pieces)	045-4011110.10

FEEDER CABLE / EXTENSION CABLE / CONNECTOR

TYPE	L (mm)	ORDER CODE
feeder cable 2x1.5+2x0.75 mm ²	2000	845-4013240
feeder cable 2x1.5+2x0.75 mm ²	4000	845-4013440
extension cable 2x1.5+2x0.75 mm ²	1200	845-4014140
mini connector 4-pole	-	845-4013040

LUMINOUS FLUX value calculated for CRI ≥ 80, colour white, cover opal

SNS Headquarters
Moscow, RU –
by ABD Architects with lighting
design by Light & Design



← back

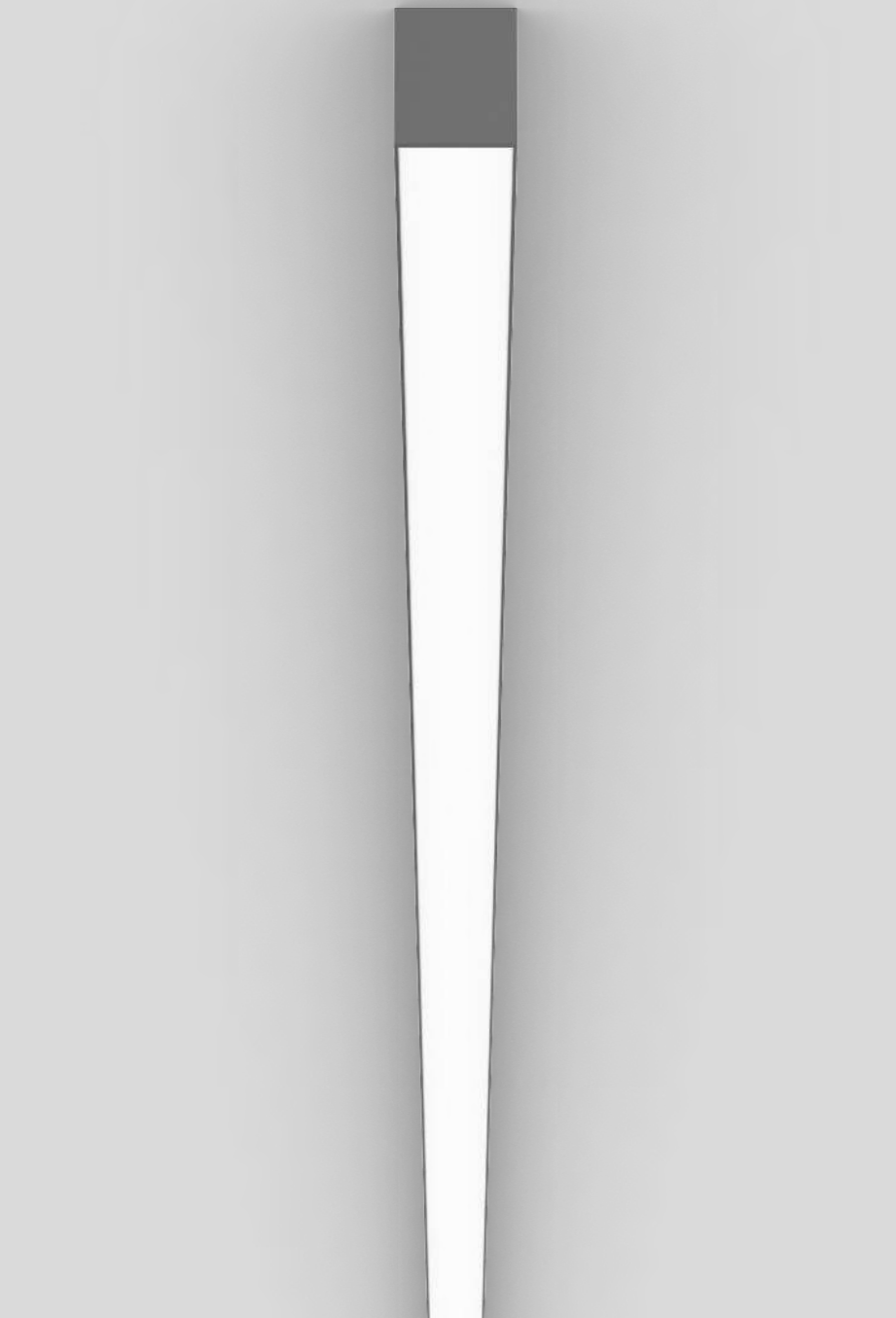

BASO 60 IP54 system surface

EN Luminaire housing from extruded aluminium profile, angular design; light-tight end caps in aluminium, no visible screws; surface powder coated; suitable for wall or ceiling mounting; luminaire profile (end caps come pre-assembled) can be pre-mounted; remaining luminaire components mounted without tools; closed light insert made of PMMA, consisting of converter unit and circuit board unit; light inset with screwed-on, thus maintenance-friendly, transparent end cap in PMMA; HPO (High Performance Opal) cover for uniform illumination; energy-efficient LEDs with very good colour rendering; IP67 socket connector system for easy and sealed electrical connection

DE Leuchtenkörper aus Aluminiumstrangpressprofil, kantige Ausführung; lichtdicht abschließende Enddeckel aus Aluminium, keine sichtbaren Schrauben; Oberfläche pulverbeschichtet; geeignet für Wand- oder Deckenmontage; Leuchtenprofil (Enddeckel werkseitig vormontiert) vorab montierbar; restliche Leuchtenkomponenten werkzeuglos montierbar; geschlossener Lichteinsatz aus PMMA, bestehend aus Konvertereinheit und Platineneinheit; Lichteinsatz mit verschraubtem, dadurch wartungsfreundlichen, transparenten PMMA Enddeckel; HPO (High Performance Opal) Abdeckung für homogene Ausleuchtung; energieeffiziente LEDs mit sehr guter Farbwiedergabe; IP67-Buchsen-Stecker-system für dichten elektrischen Anschluss

Quickinfo

3000K, 4000K
 CRI ≥ 80, 3 SDCM
 up to 2340lm/m
 up to 125lm/W
 L90 @ 50 000h
 DALI-2
 opal, IP54

Types

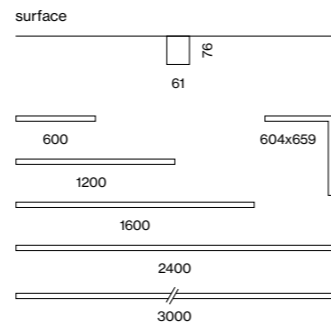

Colours



Light distribution



direct



quick installation

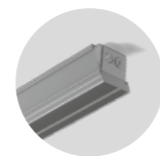

concrete install. housing (p.946)



single luminaire (p.558)



dust & splash water protection (IP54)

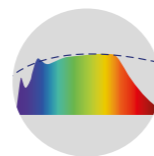

CRI ≥ 98 XPECTRUM

Order options

COLOUR TEMPERATURE	
3000K	5
4000K	6

CONTROL

DALI-2

MATERIAL COLOUR

- traffic white RAL 9016 7
- umbra grey RAL 7022 D

LIGHT OPTIC COVER

opal high performance

Options on request

COLOUR RENDERING INDEX

CRI ≥ 90

MOUNTING

concrete installation housing

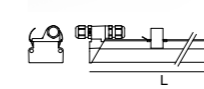
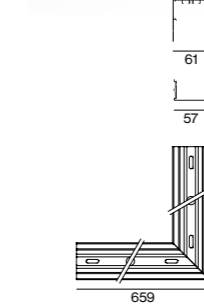
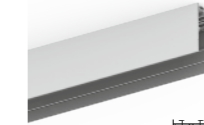

BASO 60 IP54 surface

INSTALLATION CHANNEL / CORNER 90° / BLIND COVER

TYPE	L (mm)	ORDER CODE
channel	600	845-400201
channel	1200	845-400401
channel	1600	845-400501
channel	2400	845-400801
channel	3000	845-400901
corner connector 90°	604x659	845-401121
blind cover	600	006-330601
blind cover	1200	006-331201
blind cover	1600	006-331601
blind cover	2400	006-332401
blind cover	3000	006-333001

order installation channel, light inset + mounting accessories separately

LIGHT INSET 60 IP54



SYSTEM POWER	L (mm)	ORDER CODE
11.2W start/run	599	845-4042::30H
22.4W start/run	1198	845-4044::30H
29.9W start/run	1597	845-4045::30H
45W start/run	2396	845-4048::30H
11.2W end	599	845-4052::30H
22.4W end	1198	845-4054::30H
29.9W end	1597	845-4055::30H
45W end	2396	845-4058::30H

COVER	COLOUR TEMP.	SYSTEM POWER	DELIVERED LUMENS	EFFICACY
opal high performance	3000K	18.8W/m	2210lm/m	118lm/W
	4000K	18.8W/m	2340lm/m	124lm/W

Accessories

END CAPS



TYPE	ORDER CODE
end caps (pair)	845-401001

LINEAR CONNECTOR



TYPE	ORDER CODE
linear connector (1 piece)	045-4011110
linear connector (10 pieces)	045-4011110.10

FEEDER CABLE / EXTENSION CABLE / CONNECTOR

TYPE	L (mm)	ORDER CODE
feeder cable 2x1.5+2x0.75 mm ²	2000	845-4013240
feeder cable 2x1.5+2x0.75 mm ²	4000	845-4013440
extension cable 2x1.5+2x0.75 mm ²	1200	845-4014140
mini connector 4-pole	-	845-4013040

LUMINOUS FLUX value calculated for CRI ≥ 80, colour white, cover opal

Sekundarschule Petermoos
Zurich, CH – by Itten+Brechbühl
AG, Christina Hamming
including lighting design



← back



Quickinfo

3000K, 4000K
 CRI ≥ 80, 3 SDCM
 up to 96lm/W
 L80 @ 50 000h
 non DIM, DALI-2

Types

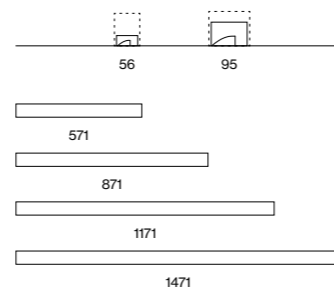

Colours



Light distribution



WALLWASHER

inset 60/100

EN Lighting module with specially computed, asymmetrical high gloss reflector for homogeneous vertical lighting; lighting module in aluminium, powder coated, installation without tools

DE Lichteinsatz mit speziell berechnetem, asymmetrischem Hochglanz-Reflektor für homogene vertikale Beleuchtungen; Lichteinsatz aus pulverbeschichtetem Aluminium werkzeuglos einsetzbar

Order options

COLOUR TEMPERATURE

3000K	5
4000K	6

CONTROL

non DIM	1
DALI-2	3

MATERIAL COLOUR

<input type="radio"/> pure white RAL 9010	7
<input checked="" type="radio"/> white aluminium RAL 9006	G
<input type="radio"/> jet black RAL 9005	8

LIGHT OPTIC

wallwasher

Planning information

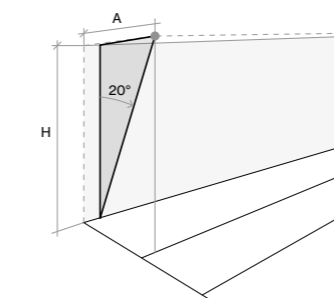

MOUNTING DISTANCE

H (mm)	A (mm)
2750	900
3000	1000
3500	1200

Light distribution

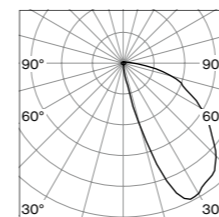

asymmetric

LUMINOUS FLUX value calculated for CRI ≥ 80, colour white, reflector chrome

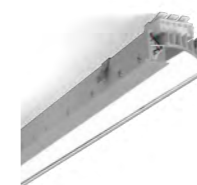

INSET 60 wallwasher



LIGHT INSET only for recessed or surface mounting

SYSTEM POWER	L (mm)	ORDER CODE
10.6 W	571	007-9042
14 W	871	007-9043
18.7 W	1171	007-9044
28 W	1471	007-9045

Technical data

SYSTEM POWER	COLOUR TEMPERATURE	DELIVERED LUMENS	EFFICACY
17 W/m	3000 K	1960 lm/m	121 lm/W
	4000 K	2070 lm/m	128 lm/W

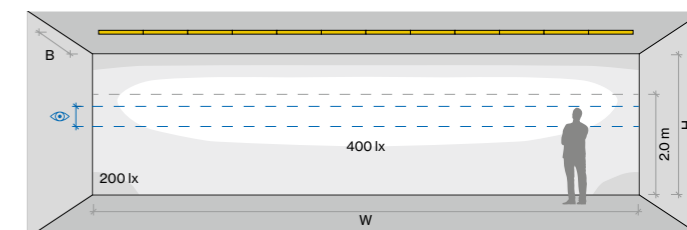

INSET 60 wallwasher, 18.7 W, 3000 K

CALCULATION SURFACE
 Surface dimensions 10.8 × 2.8 m
 Surface height 0 – 2.8 m
 Eye level 1.35 m – 1.75 m

ROOM VALUES

Wall dimensions H = 2.8 m | W = 10.8 m
 Distance to wall B = 1.3 m
 Distance between luminaires continuous
 Reflection factor 0.7 | 0.5 | 0.2
 Maintenance factor 0.8

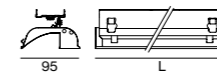

INSET 100 wallwasher



LIGHT INSET

SYSTEM POWER	L (mm)	ORDER CODE
20 W	571	007-9052
30 W	871	007-9053
40 W	1171	007-9054
51 W	1463	007-9055

CABLE SUSPENSION

TYPE	L (mm)	ORDER CODE
inset 100 wallwasher	1500	005-2132310

installation channel is required for mounting

Technical data

SYSTEM POWER	COLOUR TEMPERATURE	DELIVERED LUMENS	EFFICACY
35 W/m	3000 K	2820 lm/m	82 lm/W
	4000 K	2990 lm/m	87 lm/W

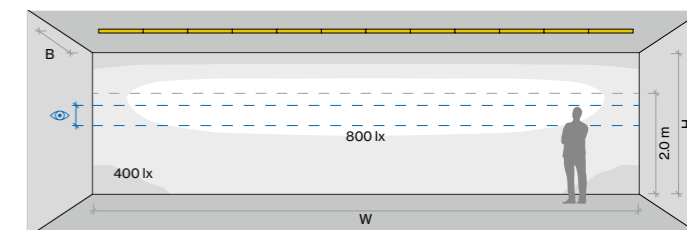

INSET 100 wallwasher, 30 W, 3000 K

CALCULATION SURFACE
 Surface dimensions 10.8 × 2.8 m
 Surface height 0 – 2.8 m
 Eye level 1.35 m – 1.75 m

ROOM VALUES

Wall dimensions H = 2.8 m | W = 10.8 m
 Distance to wall B = 1.3 m
 Distance between luminaires continuous
 Reflection factor 0.7 | 0.5 | 0.2
 Maintenance factor 0.8

← back

Order options

NUMBER OF PIECES	
2 pieces	2
3 pieces	3

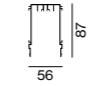

FRAME 40/MINO 40

HOUSING FOR CONCRETE INSTALLATION

TYPE	L (mm)	ORDER CODE
FRAME 40 trim	3010	0 0 5 - 4 1 3 5 6
MINO 40	3010	0 0 5 - 4 1 3 5 6

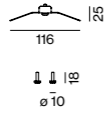

MOUNTING SET

TYPE	ORDER CODE
FRAME 40 trim	0 3 5 - 0 6 0 2
MINO 40	0 3 4 - 0 6 0 2

up to 900 mm: 2 pieces / up to 1500 mm: 3 pieces / up to 3000 mm: 2 x 2 pieces

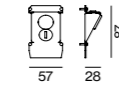

END CAPS

TYPE	ORDER CODE
end caps (pair)	0 0 5 - 4 1 2 3 6

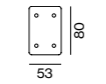

LINEAR CONNECTOR

TYPE	ORDER CODE
linear connector (1 piece)	0 0 5 - 4 1 1 6 6
linear connector (10 pieces)	0 0 5 - 4 1 1 6 6 . 1 0

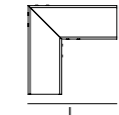

CORNER CONNECTOR 90°

TYPE	L (mm)	ORDER CODE
FRAME 40 trim	140	0 3 5 - 0 6 0 1 6
MINO 40	140	0 3 5 - 0 6 0 1 6

Order options

NUMBER OF PIECES	
2 pieces	2
3 pieces	3



FRAME 60/MINIMAL 60/MINO 60/BASO 60

HOUSING FOR CONCRETE INSTALLATION

TYPE	L (mm)	ORDER CODE
FRAME 60 trim	3000	0 0 5 - 4 1 3 4 6
BASO 60 IP54 trim	3000	0 0 5 - 4 1 3 4 6
MINIMAL 60 trimless	3000	0 0 5 - 4 1 3 4 6
MINO 60 ceiling	3000	0 0 5 - 4 1 4 4 6
BASO 60 IP54 surface	3000	0 0 5 - 4 1 4 4 6

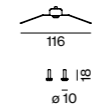

MOUNTING SET

TYPE	ORDER CODE
FRAME 60 trim	0 3 5 - 0 6 0 0
BASO 60 IP54 trim	0 3 5 - 0 6 0 0
MINIMAL 60 trimless	0 3 6 - 0 4 0 0
MINO 60 ceiling	0 3 4 - 0 4 0 0
BASO 60 IP54 surface	0 3 4 - 0 4 0 0

up to 900 mm: 2 pieces / up to 1500 mm: 3 pieces / up to 3000 mm: 2 x 2 pieces



END CAPS

TYPE	ORDER CODE
end caps (pair)	0 0 5 - 4 1 2 4 6



LINEAR CONNECTOR

TYPE	ORDER CODE
linear connector (1 piece)	0 0 5 - 4 1 1 6 6
linear connector (10 pieces)	0 0 5 - 4 1 1 6 6 . 1 0

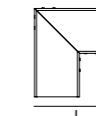

CORNER CONNECTOR 90°

TYPE	L (mm)	ORDER CODE
FRAME 60 trim	142	0 3 5 - 0 4 0 1 6
BASO 60 IP54 trim	142	0 3 5 - 0 4 0 1 6
MINIMAL 60 trimless	146	0 3 6 - 0 4 0 1 6
MINO 60 ceiling	157	0 3 4 - 0 4 0 1 6
BASO 60 IP54 surface	157	0 3 4 - 0 4 0 1 6

FRAME 100/MINIMAL 100/MINO 100

HOUSING FOR CONCRETE INSTALLATION

TYPE	L (mm)	ORDER CODE
FRAME 100 trim	3000	0 0 5 - 4 1 3 6 6
MINIMAL 100 trimless	3000	0 0 5 - 4 1 3 6 6
MINO 100 ceiling	3000	0 0 5 - 4 1 4 6 6

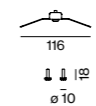

MOUNTING SET

TYPE	ORDER CODE
FRAME 100 trim	0 3 5 - 0 6 0 0
MINIMAL 100 trimless	0 3 6 - 0 5 0 0
MINO 100 ceiling	0 3 4 - 0 4 0 0

up to 900 mm: 2 pieces / up to 1500 mm: 3 pieces / up to 3000 mm: 2x2 pieces



END CAPS

TYPE	ORDER CODE
end caps (pair)	0 0 5 - 4 1 2 6 6



LINEAR CONNECTOR

TYPE	ORDER CODE
linear connector (1 piece)	0 0 5 - 4 1 1 6 6
linear connector (10 pieces)	0 0 5 - 4 1 1 6 6 . 1 0

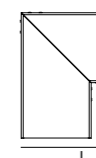

CORNER CONNECTOR 90°

TYPE	L (mm)	ORDER CODE
FRAME 100 trim	202	0 3 5 - 0 5 0 1 6
MINIMAL 100 trimless	207	0 3 6 - 0 5 0 1 6
MINO 100 ceiling	207	0 3 4 - 0 5 0 1 6

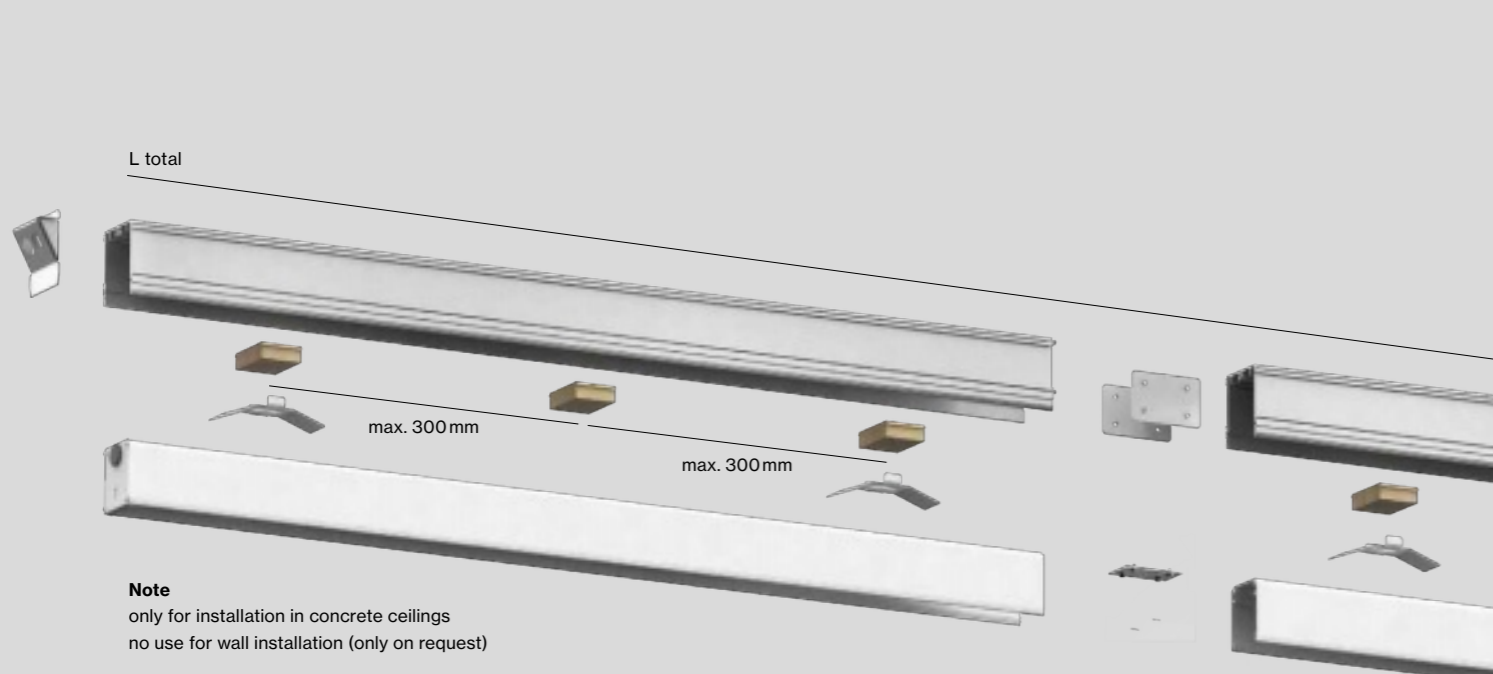

Note
only for installation in concrete ceilings
no use for wall installation (only on request)

CONCRETE installation housing

EN Concrete casting made of aluminium profile, designed for continuous lighting systems

DE Betoneingießgehäuse aus Aluminiumprofil, ausgelegt für durchgehende Lichtsysteme

Perfect allrounder



TUBO system

EN As a system luminaire, TUBO scores as a uniform and pleasant lighting system brought to life by linear connecting elements. The luminaire is available for wall and ceiling mounting, as well as in a suspended pendant version. Thanks to the opal cover, the TUBO System luminaire provides uniform ambient lighting and a pleasant atmosphere in entrance areas, corridors, and public spaces. The characteristic beam angle of up to 340° brightens the ceiling slightly while the available light colours 3000K and 4000K boost this positive room atmosphere.

DE Als Systemleuchte punktet TUBO als einheitliches und angenehmes Lichtsystem, das durch die linearen Verbindungselemente ermöglicht wird. Die Leuchte ist für die Wand- und Deckenmontage als auch in abgehängter Pendelvariante erhältlich. Durch das Opal-Cover sorgt die TUBO Systemleuchte für eine gleichmäßige Grundausleuchtung und ein angenehmes Ambiente in Eingangsbereichen, Korridoren und öffentlichen Bereichen. Der charakteristische Abstrahlwinkel von bis zu 340° sorgt für eine leichte Deckenaufhellung, die erhältlichen Lichtfarben 3000K und 4000K unterstützen diese positive Raumatmosphäre.

Types



60

100

Mountings



surface

suspended

Light distribution



opal

340° light distribution

EN With its 340° beam pattern and opal cover, TUBO System delivers homogeneous illumination as well as slight ceiling brightening. This makes the system luminaire perfect for places where pleasant ambient lighting is desired, such as reception areas, corridors, or foyers.

DE Durch ihre 340° Abstrahlcharakteristik und Opal-Abdeckung erzielt TUBO System eine homogene Beleuchtung sowie eine leichte Deckenaufhellung. Dadurch ist die Systemleuchte perfekt geeignet für Orte, an denen eine angenehme Grundausleuchtung gewünscht ist, wie Empfangsbereiche, Flure oder Foyers.

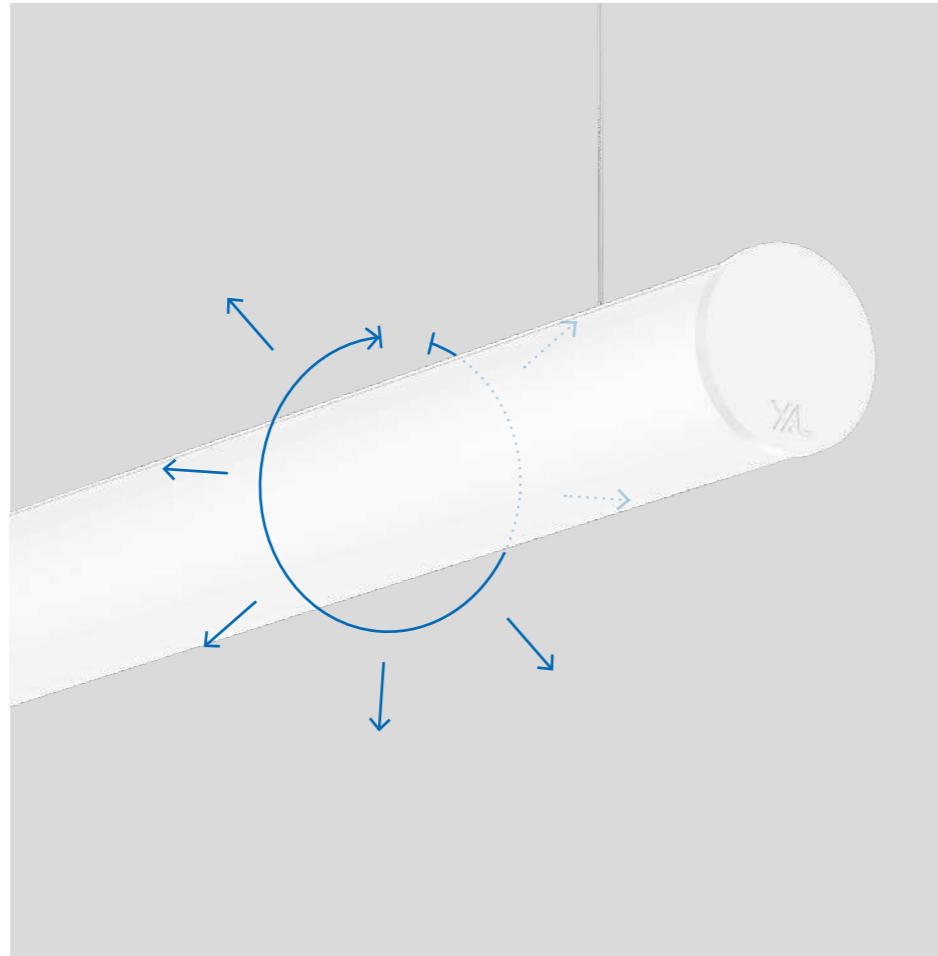

Mounting options

EN The TUBO System can be installed as a surface-mounted version in a continuous lighting system for walls and ceilings, or as a suspended pendant luminaire on the ceiling.

DE Das TUBO System kann als durchgängiges Lichtsystem als Anbauvariante für Decken und Wandmontage bzw. als abgehängte Pendelleuchte an der Decke installiert werden.



Seamless light channel

EN TUBO as a continuous lighting system: Connecting elements can turn individual TUBO luminaires into a seamless channel. This creates a visually uniform lighting system for many different applications – whether as a corridor luminaire, effect luminaire, or visual guidance system.

DE TUBO als durchgängiges Lichtsystem: Verbindungselemente ermöglichen es, aus einzelnen TUBO-Leuchten einen nahtlosen Channel zu machen. Dadurch entsteht ein optisch einheitliches Lichtsystem für viele verschiedene Anwendungsbereiche – ob als Korridor-Leuchte, Effektleuchte oder visuelles Leitsystem.



Easy mounting

EN TUBO 60 system luminaires are electrically connected by a simple plug-in connection. This makes the installation of a complex lighting system simple, quick, and straightforward.

DE TUBO 60 Systemleuchten werden durch eine simple Steckverbindung elektrisch verbunden. Dadurch ist die Montage eines komplexen Lichtsystems denkbar einfach, rasch und unkompliziert durchführbar.

← back



TUBO 60 system

surface / suspended

EN Supporting profile in extruded aluminium; end cap in aluminium; for continuous lighting systems; surface powder coated; surface mounted or suspended luminaire with cable suspension; height adjustment without tools; with transparent feeder cable; electrical connection of the luminaires via plug / socket system; no separate wiring required; light control via high-quality lens system for maximum, homogeneous illumination; completely homogeneously illuminated, cylindrical HPO (High Performance Opal) cover; energy-efficient LEDs with very good colour rendering

DE Tragprofil aus Aluminiumstrangpressprofil; Enddeckel aus Aluminium; für durchgehende Lichtsysteme; Oberfläche pulverbeschichtet; Anbau- bzw. Pendelleuchte mit Seilabhängung; werkzeuglose Höhenverstellung; inkl. transp. Einspeiseleitung; elektrische Verbindung der Leuchten mittels Buchse / Stecker System; keine separate Verdrahtung nötig; Lichtlenkung mittels hochwertiger Linsenoptik für maximale, homogene Ausleuchtung; absolut homogen ausgeleuchtete, zylindrische HPO (High Performance Opal) Abdeckung; energieeffiziente LEDs mit sehr guter Farbwiedergabe

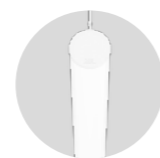

single luminaire (p. 572)

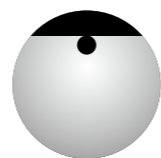

uniform illumination

Quickinfo

3000K, 4000K
CRI ≥ 80, 3 SDCM
up to 3160lm/m
up to 114lm/W
L90 @ 50 000h
non DIM, DALI-2
opal

Types

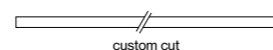
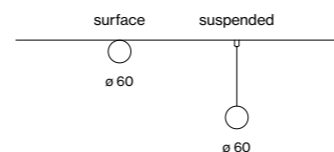

Colour



Light distributions



Order options

COLOUR TEMPERATURE	
3000K	5
4000K	6

CONTROL	
non DIM	1
DALI-2	3

MATERIAL COLOUR

○ pure white RAL 9010

TUBO 60 surface/suspended



INSTALLATION CHANNEL + LIGHT INSET + LIGHT OPTIC COVER				
SYS. POWER	COLOUR TEMP.	LUM. FLUX	L (mm)	ORDER CODE
16.5 W	3000K	1780lm	585	058-3022::70
	4000K	1880lm		
33 W	3000K	3560lm	1185	058-3024::70
	4000K	3760lm		
66 W	3000K	7110lm	2385	058-3028::70
	4000K	7530lm		
82 W	3000K	8890lm	2985	058-3029::70
	4000K	9410lm		

Accessories surface

END CAP / POWER FEEDER

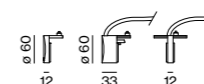

TYPE	ORDER CODE
end cap	058-3010017
end cap power feeder	058-3010217
middle power feeder	058-3011217

LINEAR CONNECTOR

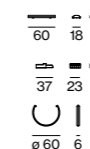

TYPE	ORDER CODE
mechanical	058-3013117
mechanical & electrical	058-3013127
incl. opal cover connector	

CEILING MOUNTING SET



TYPE	L (mm)	ORDER CODE
ceiling mounting set	75	058-3014117

Accessories suspended

END CAP / POWER FEEDER incl. feeder cable and cable suspension 1500mm

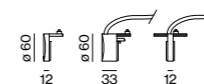

TYPE	ORDER CODE
end cap	058-3010117
end cap power feeder 5 × 1.5mm ²	058-3010317
middle power feeder 5 × 1.5mm ²	058-3011317

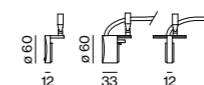

end cap angular max. 60°	058-3010127
end cap power feeder angular max. 60° 5 × 1.5mm ²	058-3010327
middle power feeder angular max. 60° 5 × 1.5mm ²	058-3011327

LINEAR CONNECTOR



TYPE	ORDER CODE
mechanical	058-3013217
mechanical & electrical	058-3013227
incl. opal cover connector	

CABLE SUSPENSION

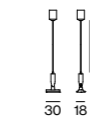

TYPE	L (mm)	ORDER CODE
cable suspension	1500	058-3014210
cable suspension angular max. 60°	1500	058-3014310

CANOPY

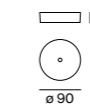

TYPE	Ø-H (mm)	ORDER CODE
non DIM	90-22	005-2600017
DALI-2	90-22	005-2600037

for electrical system configuration see luminaire data sheet at xal.com

LUMINOUS FLUX value calculated for CRI ≥ 80, colour white, cover opal

← back



TUBO 100 system

surface / suspended

EN Supporting profile in extruded aluminium; end cap in aluminium, no visible screws; for lighting systems; powder coated; luminaire profile for mounting available in advance; remaining components mounted without tools; surface mounted or suspended luminaire with cable suspension; height adjustment without tools; spring clip attachment to the luminaire; freely positionable; with transparent feeder cable; light inset consisting of highly reflective coated extruded profile for improved thermal management; cylindrical cover made of satinised PMMA for homogeneous illumination; with 340° light emission and light ceiling illumination; energy-eff. LEDs – very good colour rendering

DE Tragprofil aus Aluminiumstrangpressprofil; Enddeckel aus Aluminium, keine sichtbaren Schrauben; für Lichtsysteme; pulverbeschichtet; Leuchtenprofil für Montage vorab lieferbar; restl. Komponenten werkzeuglos montierbar; Anbau- bzw. Pendelleuchte mit Seilabhängung; werkzeuglose Höhenverstellung; Befestigung an der Leuchte mittels Federclips; frei positionierbar; inkl. transp. Einspeiseleitung; Lichteinsatz bestehend aus hochreflektierend lackiertem Strangpressprofil für verbessertes Thermomanagement; zylindrische Abdeckung aus satiniertem PMMA für homogene Ausleuchtung; mit 340° Lichtabstrahlung und leichter Deckenaufhellung; energieeff. LEDs – sehr gute Farbwiedergabe

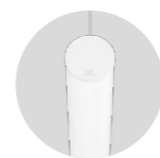

single luminaire (p. 576)

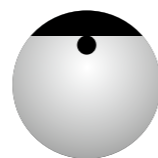

uniform illumination

Quickinfo

3000K, 4000K
CRI ≥ 80, 3 SDCM
up to 4300lm/m
up to 138lm/W
L90 @ 50 000h
non DIM, DALI-2
opal

Types

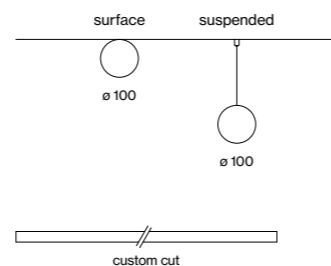

Colour



Light distributions



Order options

COLOUR TEMPERATURE	
3000K	5
4000K	6

CONTROL	
non DIM	1
DALI-2	3

MATERIAL COLOUR

○ pure white RAL 9010

Options on request

CONTROL	
Casambi	

EMERGENCY LIGHT

1h Accupack	
3h Accupack	

only available for length 1463mm

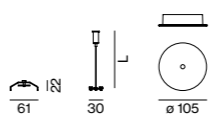

TUBO 100 ceiling / suspended

INSTALLATION CHANNEL

TYPE	L (mm)	ORDER CODE
installation channel	582	029-00667
installation channel	882	029-00967
installation channel	1182	029-01267
installation channel	1482	029-01567
installation channel	2364	029-02567
installation channel	3000	029-03067
installation channel	custom	E85950 ···· 7

LIGHT OPTIC COVER OPAL HIGH PERFORMANCE

TYPE	L (mm)	ORDER CODE
light optic cover	577	006-5205700
light optic cover	877	006-5208700
light optic cover	1177	006-5211700
light optic cover	1477	006-5214700
light optic cover	2359	006-5223400
light optic cover	2995	006-5230000
light optic cover	custom	E85910 ···· 00



LIGHT INSET

SYSTEM POWER	L (mm)	ORDER CODE
18.3 W	571	029-8832 ··· 7
27.5 W	871	029-8833 ··· 7
37 W	1171	029-8834 ··· 7
46 W	1463	029-8835 ··· 7
73 W	2341	029-8838 ··· 7

COVER	COLOUR TEMP.	SYSTEM POWER	DELIVERED LUMENS	EFFICACY
opal high	3000K	31W/m	4060lm/m	131lm/W
performance	4000K		4300lm/m	138lm/W

Accessories

END CAPS

TYPE	ORDER CODE
end caps (pair)	029-14067

LINEAR CONNECTOR

TYPE	ORDER CODE
linear connector (1 piece)	029-12027
linear connector (10 pieces)	029-12027.10
opal cover linear connector	029-12927
anti-slip protection (per cover)	029-00347

MOUNTING

TYPE	L (mm)	ORDER CODE
ceiling mounting set	40	029-00446
cable suspension	1500	005-2142110
angular cable susp. (max. 60°)	1500	005-2142210
canopy / feeder cable 3 × 1.5 mm ²	1500	005-2222317
canopy / feeder cable 5 × 1.5 mm ²	1500	005-2222417
cable rail	1200	005-2491110

for electrical system configuration see luminaire data sheet at xal.com

THROUGH WIRE

TYPE	ORDER CODE
3 × 1.5 mm ² (non DIM, 10 pieces)	004-90003
5 × 1.5 mm ² (DALI-2, 10 pieces)	004-90005

LUMINOUS FLUX value calculated for CRI ≥ 80, colour white, cover opal



UK TV
London, UK –
by PENSON with lighting
design by AECOM

Define the horizon



LINEA system

EN Elegant room accentuation, highest performance. LINEA is a reduced, convertible luminaire for stylish wall, floor, and ceiling illumination. The extraordinarily narrow wall profile is completed by various lighting insets. Different beam patterns can be easily combined. For example, an opal cover for homogeneous illumination and asymmetrical illumination for brightening floors or ceilings. Spotlights can be chosen for elegant accentuation or as reading lights. LINEA is available as an individual decorative luminaire in different lengths, including perpendicular corner elements. Choose between white and black for the profile. The inserts optionally have a colour rendering of up to $\text{CRI} \geq 98$. In addition, the light inserts themselves can be selected in the light colours 2700 K, 3000 K, 4000 K, or as a Tunable White option.

DE Elegante Raumakzentuierung und höchste Performance: LINEA ist eine reduzierte, jedoch wandelbare Leuchte für die stilvolle Wand-, Boden- und Deckenaufhellung. Das außerordentlich schmale Wandprofil wird durch unterschiedliche Lichteinsätze vervollständigt. Verschiedene Abstrahlcharakteristiken lassen sich einfach kombinieren: beispielsweise Opal-Cover für die homogene Ausleuchtung sowie asymmetrische Beleuchtung für Boden- oder Deckenaufhellung. Spots können zur eleganten Akzentuierung oder als Leselicht gewählt werden. LINEA ist als dekorative Systemleuchte in verschiedenen Längen inklusive rechtwinkliger Eckelemente verfügbar. Bei der Profilarbe haben Sie die Wahl zwischen Weiß und Schwarz. Die Inserts verfügen wahlweise über eine Farbwiedergabe von bis zu $\text{CRI} \geq 98$. Außerdem können die Lichteinsätze selbst in den Lichtfarben 2700 K, 3000 K, 4000 K oder als Tunable White Option gewählt werden.

Mounting



wall

Configurations



linear



corner

Light distributions

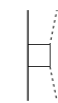
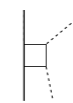
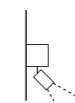
opal
opalasymmetric
opal

spot

← back

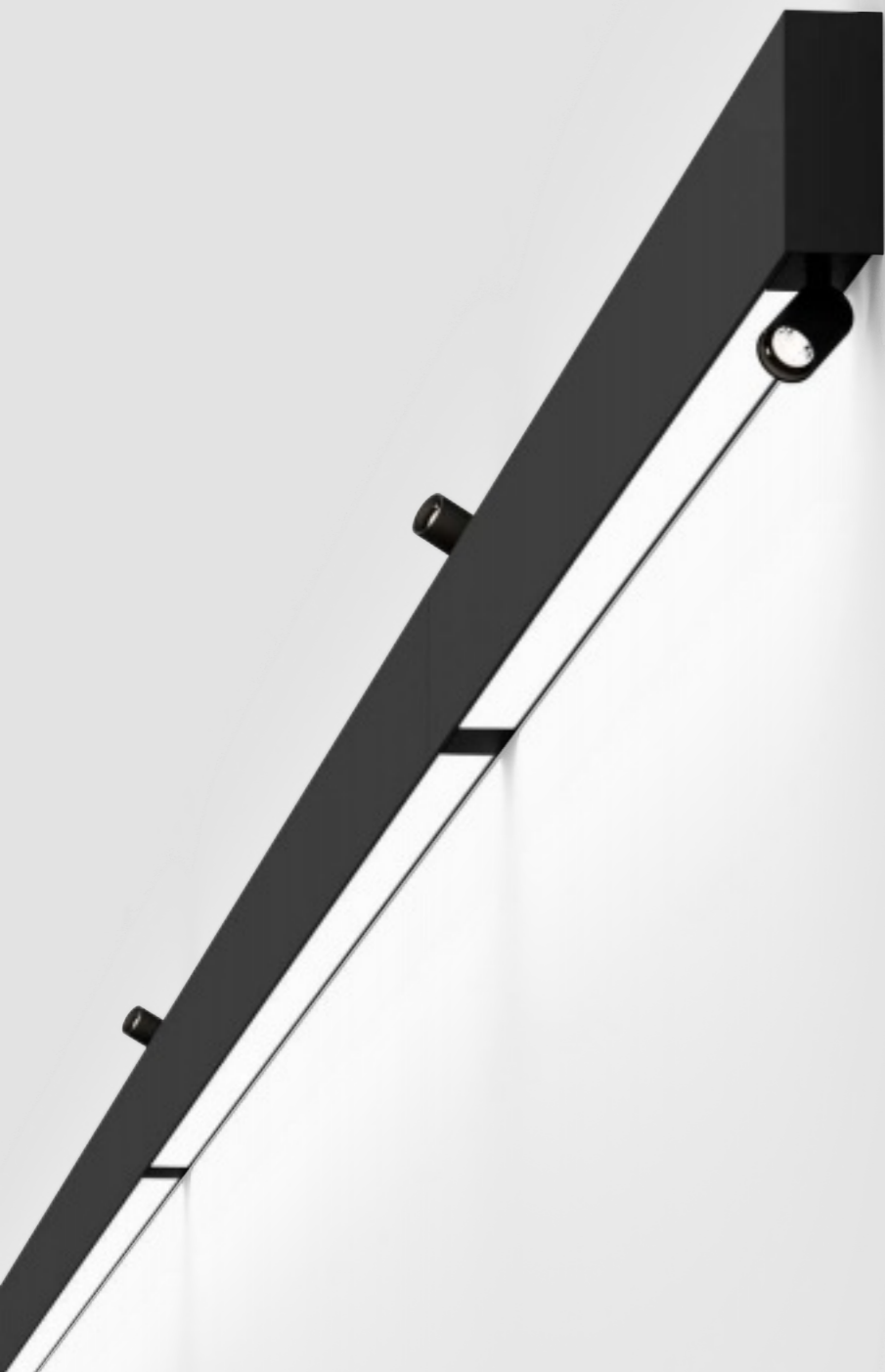

LINEA system wall

EN Luminaire housing and front cover from extruded aluminium profile, angular version; no visible screws; designed for continuous lighting systems, 90° angle connectors for flexible system design; surface powder coated; suitable for wall mounting; homogeneous wall or ceiling illumination through uniform direct/indirect light distribution; HPO (High Performance Opal) cover for uniform illumination; or with specially computed, asymmetrical lens for homogeneous lighting intensity (installation optionally for floor or ceiling illumination); energy-efficient LEDs with very good colour rendering; optionally JUST 26 spotlight module can be installed

DE Leuchtenkörper und Frontabdeckung aus Aluminiumstrangpressprofil, kantige Ausführung; keine sichtbaren Schrauben; ausgelegt für durchgehende Lichtsysteme, 90° Winkelverbinder für flexiblen Systemaufbau; Oberfläche pulverbeschichtet; geeignet für Wandmontage; homogene Wand- bzw. Deckenaufhellung durch gleichmäßige direkt/indirekte Lichtverteilung; HPO (High Performance Opal) Abdeckung für homogene Ausleuchtung; oder mit speziell berechneter, asymmetrischer Linse für homogene Beleuchtungsstärken (Montage wahlweise zur Boden- oder Deckenaufhellung); energieeffiziente LEDs mit sehr guter Farbwiedergabe; wahlweise JUST 26 Strahlereinsatz einsetzbar

Quickinfo

3000K, 4000K, TW
 CRI ≥ 90, 3 SDCM
 up to 117m/W
 L90 @ 50 000h
 non DIM, DALI-2

Types

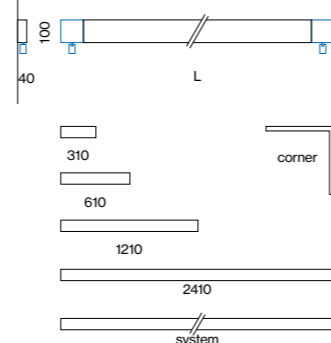

Colours



Light distributions

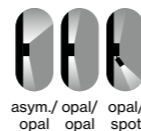

asym./ opal/ opal/ opal opal spot

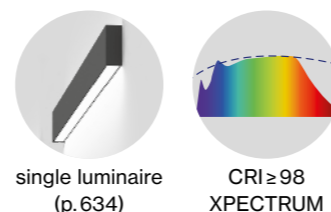

single luminaire (p. 634)

CRI ≥ 98 XPECTRUM

Order options

COLOUR TEMPERATURE	
3000K	5
4000K	6
tunable white 2700–5000K*	D

*available from L 1210mm | DALI-2 DT8

CONTROL	
non DIM	1
DALI-2	3

MATERIAL COLOUR	
○ pure white RAL 9010	7
● jet black RAL 9005	8

SPOTLIGHT ALIGNMENT	
left	B
right	C

spotlight(s) only with 3000K

Options on request

COLOUR RENDERING INDEX	
CRI ≥ 98 XPECTRUM	

COLOUR TEMPERATURE	
2700K	

MATERIAL COLOUR	
special colours	

Light distributions

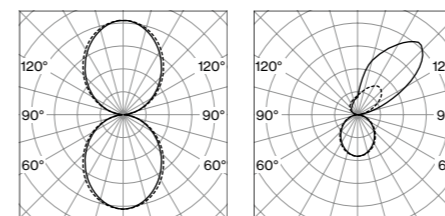

↓ opal high performance
 ↑ opal high performance
 ↓ opal high performance
 ↑ asymmetric

LUMINOUS FLUX value calculated for CRI ≥ 90, colour white, cover opal

LINEA system wall



↓ OPAL HIGH PERFORMANCE / ↑ OPAL HIGH PERFORMANCE

SYS. POWER	COLOUR TEMP.	LUMINOUS FLUX	L (mm)	ORDER CODE
14.7W	3000K	↓ 648/± 648lm	310	058-61411::↓↑AH
	4000K	↓ 715/± 715lm		
29.3W	3000K	↓ 1300/± 1300lm	610	058-61421::↓↑AH
	4000K	↓ 1430/± 1430lm		
59W	3000K	↓ 2590/± 2590lm	1210	058-61441::↓↑AH
	4000K	↓ 2860/± 2860lm		
111W	3000K	↓ 5190/± 5190lm	2410	058-61481::↓↑AH
	4000K	↓ 5720/± 5720lm		
29.3W	3000K	↓ 1300/± 1300lm	633x633	058-61111::↓↑AH
	4000K	↓ 1430/± 1430lm		
29.3W	3000K	↓ 1300/± 1300lm	633x633	058-61121::↓↑AH
	4000K	↓ 1430/± 1430lm		



↓ OPAL HIGH PERFORMANCE / ↑ ASYMMETRIC

SYS. POWER	COLOUR TEMP.	LUMINOUS FLUX	L (mm)	ORDER CODE
14.7W	3000K	↓ 648/± 821lm	310	058-61411::↓↑AA
	4000K	↓ 715/± 906lm		
29.3W	3000K	↓ 1300/± 1640lm	610	058-61421::↓↑AA
	4000K	↓ 1430/± 1810lm		
59W	3000K	↓ 2590/± 3280lm	1210	058-61441::↓↑AA
	4000K	↓ 2860/± 3620lm		
111W	3000K	↓ 5190/± 6570lm	2410	058-61481::↓↑AA
	4000K	↓ 5720/± 7250lm		
29.3W	3000K	↓ 1300/± 1300lm	633x633	058-61111::↓↑AA
	4000K	↓ 1430/± 1430lm		
29.3W	3000K	↓ 1300/± 1300lm	633x633	058-61121::↓↑AA
	4000K	↓ 1430/± 1430lm		



↓ OPAL HIGH PERFORMANCE / 1 SPOTLIGHT

SYS. POWER	COLOUR TEMP.	LUMINOUS FLUX	L (mm)	ORDER CODE
29.3W	3000K	↓ 1300/± 1300lm	710	058-61421::↓↑VH
	4000K	↓ 1430/± 1430lm		
59W	3000K	↓ 2590/± 2590lm	1310	058-61441::↓↑VH
	4000K	↓ 2860/± 2860lm		
111W	3000K	↓ 5190/± 5190lm	2510	058-61481::↓↑VH
	4000K	↓ 5720/± 5720lm		

spotlight alignment left or right

Accessories

END CAPS	
TYPE	ORDER CODE
end caps (pair)	050-254010

CONNECTOR	
TYPE	ORDER CODE
linear connector (1 piece)	050-2551100
linear connector (10 pieces)	050-2551100.10

THROUGH WIRE	
TYPE	ORDER CODE
3 × 1.5 mm ² (non DIM, 10 pieces)	004-90003
5 × 1.5 mm ² (DALI-2, 10 pieces)	004-90005

Bedroom
Visualisation



SNS Headquarters
Moscow, RU –
by ABD Architects with lighting
design by Light & Design



Controls



Controls

DALI-2 control



970

Professional building management

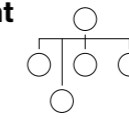

976

Casambi



NEW → 978

DIN rail components

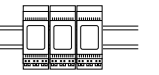

NEW → 980

Know-How



982

← back

Controller Comparison

Controller	Push-Dim	Last Light Level Memory	Grouping	Scenes	Daylight Harvesting	Time Functions	Tunable White (DT8)	Dynamic Scenes Colour Gradients	Circadian CCT Curves
Basic Room Controller	•	•					•		
Advanced DALI-2 Controller	•	•	•	•	•		•		
Professional Building Automation	•	•	•	•	•	•	•	•	•
Casambi	•	•	•	•	•	•	•	•	•

Touchpanel Tablet/ Smartphone	Visualization	Plug and Play	BMS Connectivity (KNX, Modbus, BACnet)	Ethernet	Cloud Connectivity	Customizable Programming	Extendable
•		•					
•	•		•	•	•	•	•
•		•			•		•

Basic Room Controller (p.973)

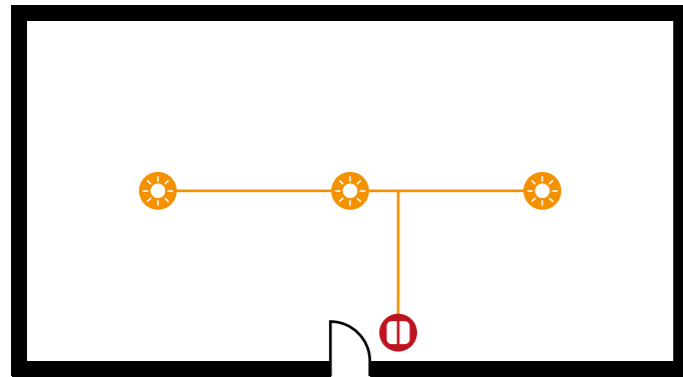

Advanced DALI-2 Controller (p.973)

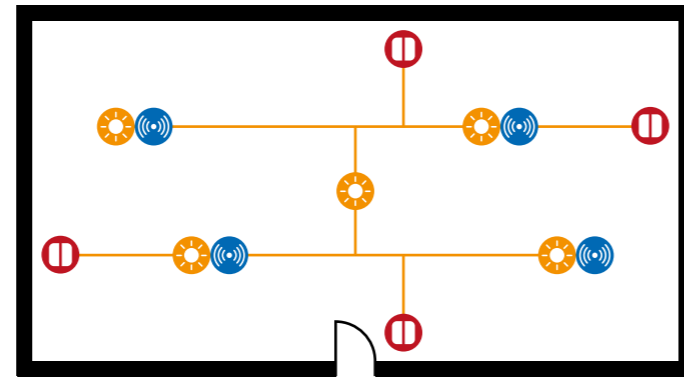

Professional Building Automation (p.977)

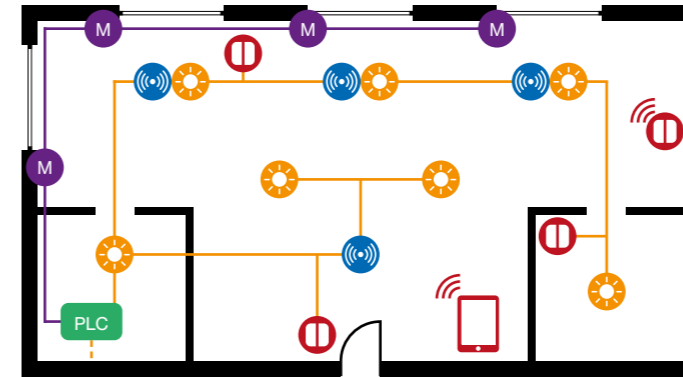

Casambi (p.979)



EN

Applications:
 Conference rooms
 Private living quarters
 Classrooms

Features:
 Operation via standard button and/or rotary dimmer
 Intuitive manual dimming, switching
 Colour temperature adjustment (DT8)
 Broadcast signals to all luminaires
 Basic plug-and-play functionality without start-up
 Integrated DALI power supply
 Lighting control with app via Bluetooth

DE

Anwendungsgebiet:
 Besprechungsräume
 Private Wohnbereiche
 Klassenzimmer

Features:
 Bedienung über Standardtaster bzw. Drehdimmer
 Intuitives manuelles Dimmen, Schalten
 Einstellen der Farbtemperatur (DT8)
 Broadcast Signale an alle Leuchten
 Plug and Play Basisfunktionen ohne Inbetriebnahme
 Integrierte DALI Spannungsversorgung
 Lichtsteuerung mit App über Bluetooth

EN

Applications:
 Offices
 Classrooms
 Shop lighting

Features:
 Operation via standard button
 Intuitive manual dimming, switching
 Create groups and scenes
 Colour temperature adjustment (DT8)
 Upgradeable with DALI-2 sensors
 Full-featured DALI-2 application controller
 Power supply via the DALI Bus
 4 independent potential-free inputs for standard buttons
 Start-up with app via Bluetooth

DE

Anwendungsgebiet:
 Büroräume
 Klassenzimmer
 Shopbeleuchtung

Features:
 Bedienung über Standardtaster
 Intuitives manuelles Dimmen, Schalten
 Erstellen von Gruppen und Szenen
 Einstellen der Farbtemperatur (DT8)
 Erweiterung um DALI-2 Sensoren möglich
 Vollwertiger DALI-2 Application Controller
 Spannungsversorgung über DALI Bus
 4 unabhängige Potentialfreie Eingänge für Standardtaster
 Inbetriebnahme mit App über Bluetooth

EN

Applications:
 Office buildings
 Public buildings
 Sports halls and schools
 Shop lighting

Features:
 Operation via standard button
 Intuitive manual dimming, switching
 Create groups and scenes
 Colour temperature adjustment (DT8)
 Upgradeable with DALI-2 sensors
 Full-featured DALI-2 application controller
 Up to 20 DALI-2 universes
 Connection to building management system
 Interfaces: KNX, Modbus, BACnet, and many more.
 User-specific visualizations
 Flexible upgradeability

DE

Anwendungsgebiet:
 Bürogebäude
 Öffentliche Gebäude
 Sporthallen & Schulen
 Shopbeleuchtung

Features:
 Bedienung über Standardtaster
 Intuitives manuelles Dimmen, Schalten
 Erstellen von Gruppen und Szenen
 Einstellen der Farbtemperatur (DT8)
 Erweiterung um DALI-2 Sensoren möglich
 Vollwertiger DALI-2 Application Controller
 Bis zu 20 DALI-2 Universen
 Anbindung an Gebäudeleittechnik
 Schnittstellen: KNX, Modbus, BACnet uvm.
 Benutzerspezifische Visualisierungen
 Flexibel Erweiterbar

EN

Applications:
 Small offices
 Shop lighting
 Meeting rooms
 Private living quarters

Features:
 Operation via standard button
 Intuitive manual dimming, switching
 Create groups and scenes
 Colour temperature adjustment (DT8)
 Upgradeable with Casambi and DALI-2 Sensors
 Power supply integrated or via DALI bus
 Up to 128 nodes in one Network
 Start-up with app via Bluetooth, no gateway required

DE





Anwendungsgebiet:
 Büroräume
 Shopbeleuchtung
 Besprechungsräume
 Private Wohnbereiche

Features:
 Bedienung über Standardtaster
 Intuitives manuelles Dimmen, Schalten
 Erstellen von Gruppen und Szenen
 Einstellen der Farbtemperatur (DT8)
 Erweiterung um Casambi und DALI-2 Sensoren
 Spannungsversorgung integriert oder über DALI Bus
 Bis zu 128 Knoten im selben Netzwerk
 Inbetriebnahme mit App über Bluetooth

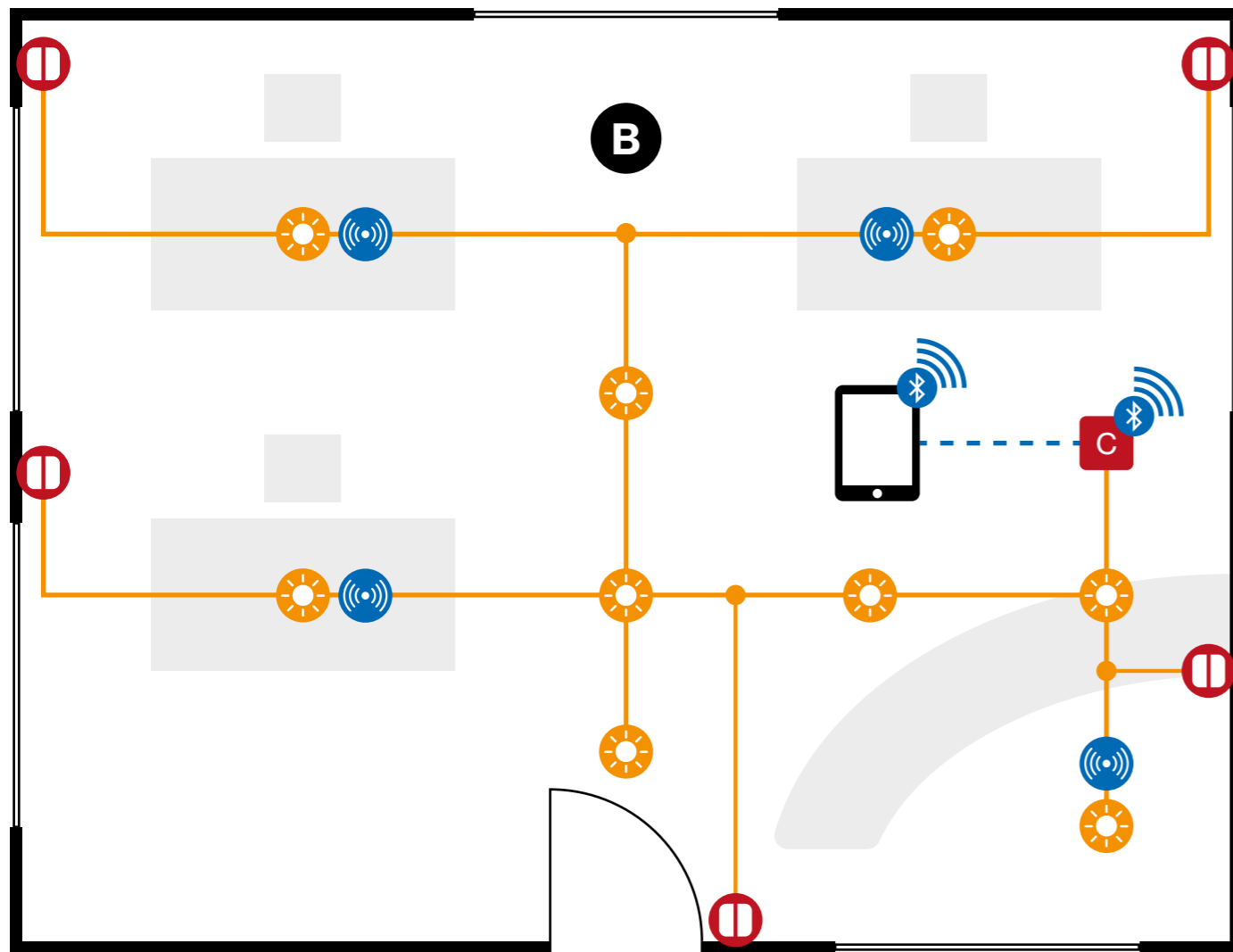
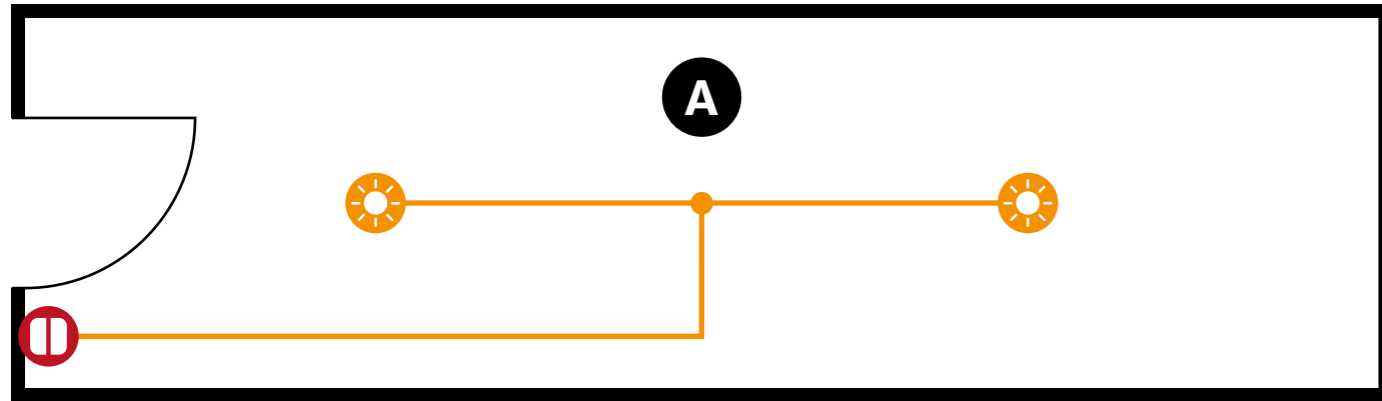
← back

DALI-2 Connection Examples



-  Wall switch DALI
-  Light DALI
-  Sensor DALI
-  Application controller DALI
-  Commissioning device

A Basic Room Controller

EN Push-button interface or rotary switch for intuitive, simple control of up to 32 DALI luminaires; automatic synchronisation between several control units; support of variable colour luminaires (DT8); storage of brightness values; plug and play – no need for set-up; additional functions available by set-up in smartphone App (BT): control by smartphone for grouping, scenes, colour temperature (DT8) and firmware update; DALI power supply integrated; daylight control, presence-dependent control and additional input push-button options using sensors, available separately; maximum push-button line length 50m; maximum DALI cable length 300m

DE Tasterinterface bzw. Drehschalter zur intuitiven, einfachen Steuerung von bis zu 32 DALI Leuchten; Automatische Synchronisation zwischen mehreren Steuereinheiten; Unterstützung von farbveränderlichen Leuchten (DT8); Speicherung von Helligkeitswerten; Plug and Play ohne Inbetriebnahme; Zusätzliche Funktionen durch Inbetriebnahme über Smartphone App (BT) verfügbar: Steuerung über Smartphone, Gruppierung, Szenen, Farbtemperatur (DT8), Firmwareaktualisierung; DALI Spannungsversorgung integriert; Tageslichtregelung, präsenzabhängige Steuerung und zusätzliche Tastereingänge mittels separat erhältlichen Sensoren möglich; maximale Tasterleitungslänge 50m; maximale DALI-Leitungslänge 300m



DALIeco BT 220-240 V			
TYPE	MOUNTING	L-WH (mm)	ORDER CODE
DALI DT8 BT Touch Dim Controller	ceiling insertion	100-79-72	005-5831000
DALI ACU BT 220-240 V			
TYPE	MOUNTING	L-WH (mm)	ORDER CODE
DALI DT8 BT Touch Dim Controller	socket	49-48-22	005-5831100
DALI MCU TW G2 220-240 V			
TYPE	MOUNTING	L-WH (mm)	ORDER CODE
DALI DT8 Rotary Dim Controller	socket	71-71-50	005-5831300

B Advanced DALI-2 Controller

EN DALI-2 application controller for controlling up to 64 DALI lights, 16 sensors and 16 push-button couplers in 16 groups and 16 scenes; 4 inputs for potential-free push-buttons; support of variable colour luminaires (DT8); storage of brightness values; power supply via DALI, DALI power supply available separately; start-up is performed by smartphone App; compact design for installation behind standard push-buttons; maximum push-button cable length 0.5m; compatible with all DALI-2 peripheral components

DE DALI-2 Application Controller zur Steuerung von bis zu 64 DALI Leuchten, 16 Sensoren und 16 Tasterkopplern in 16 Gruppen und 16 Szenen; 4 Eingänge für potenzialfreie Taster; Unterstützung von farbveränderlichen Leuchten (DT8); Speicherung von Helligkeitswerten; Stromversorgung über DALI, DALI Spannungsversorgung separat erhältlich; Inbetriebnahme erfolgt über Smartphone App; kompakte Bauform zum Verbau hinter Standardtastern; maximale Tasterleitungslänge 0,5m; mit allen DALI-2 Peripheriekomponenten kompatibel



DALI sceneCOM S Controller 220-240 V			
TYPE	MOUNTING	L-WH (mm)	ORDER CODE
DALI-2 DT8 BT Controller	socket	48-28-15	005-5841000
DALIeco BT RTC 220-240 V			
TYPE	MOUNTING	L-WH (mm)	ORDER CODE
DALIeco BT RTC	ceiling insertion	100-79-72	005-5841100

← back

DALI-2 Sensors

EN Motion detection and ambient light level measurement; power supply via DALI line; easy and unobtrusive integration into the luminaire portfolio; requires a DALI-2 Application Controller for operation; available in ESSENTIAL (brightness, presence) and SENSE (brightness, presence, temperature, sound pressure, humidity, CO₂) versions

Sensor according to DALI-2 specifications:
 EN 62386-101 Ed.2 General requirements - System components
 EN 62386-103 Ed.1 General requirements - Control devices
 EN 62386-303 Occupancy Sensors
 EN 62386-304 Light Sensors

DE Bewegungserfassung und Messung der Umgebungslichtstärke; Spannungsversorgung über DALI-Leitung; Einfache und unauffällige Integration in das Leuchtenportfolio; Benötigt einen DALI-2 Application Controller für den Betrieb; Verfügbar in ESSENTIAL (Helligkeit & Anwesenheit) und SENSE (Helligkeit, Anwesenheit, Temperatur, Lärmpegel, Luftfeuchtigkeit, CO₂) Ausführung

Sensor nach DALI-2 Spezifikationen:
 EN 62386-101 Ed.2 General requirements – System components
 EN 62386-103 Ed.1 General requirements – Control devices
 EN 62386-303 Occupancy Sensors
 EN 62386-304 Light Sensors

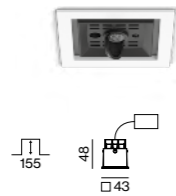

UNICO Q1 sensor recessed



SENSOR INSET

TYPE	ORDER CODE
ESSENTIAL (brightness & presence)	090-7Q10000
SENSE (brightness, presence, temperature, sound pressure, humidity, CO ₂)	090-7Q10010

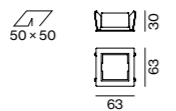

Mounting accessories

MOUNTING SET TRIMLESS for plasterboard ceilings 12.5/15/25 mm

COLOUR	ORDER CODE
○ white	090-7Q10100

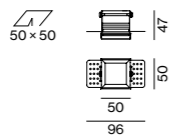

MOUNTING SET WITH TRIM for intermediate ceilings 2-25 mm

COLOUR	ORDER CODE
○ traffic white RAL 9016	090-7Q1020W
● jet black RAL 9005	090-7Q1020B

Order options

INSET COLOUR

○ traffic white RAL 9016	7
● jet black RAL 9005	1

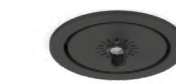

SASSO 60 sensor recessed

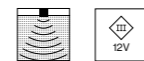

SENSOR INSET

TYPE	ORDER CODE
ESSENTIAL (brightness & presence)	048-269311 <input checked="" type="checkbox"/>
SENSE (brightness, presence, temperature, sound pressure, humidity, CO ₂)	048-269312 <input checked="" type="checkbox"/>

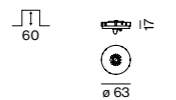

Mounting accessories

MOUNTING SET TRIMLESS for plasterboard ceilings 12.5/15/25 mm

COLOUR	ORDER CODE
○ white	048-2696117

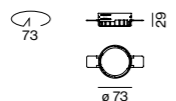

MOUNTING SET WITH TRIM for intermediate ceilings 2-25 mm

COLOUR	ORDER CODE
○ traffic white RAL9016	048-2696317
● jet black RAL 9005	048-2696318



DALI-2 Peripheral components

EN DALI peripheral components can be combined universally with all supported controls; many other components available on request

DE DALI Peripheriekomponenten sind universell mit allen unterstützten Steuerungen kombinierbar; viele weitere Komponenten auf Anfrage verfügbar

RELAYS

TYPE	MOUNTING	L-WH (mm)	ORDER CODE
DALI DT7 Relais 1CH 4A	socket	41-30-11	005-5825000
DALI DT7 Relais 4CH 10A	DIN rail	59-105-90	005-5825100

SWITCH COUPLER

TYPE	MOUNTING	L-WH (mm)	ORDER CODE
DALI Switch Interface 4CH	socket	48-28-15	005-5821000

PHASE DIMMER

TYPE	MOUNTING	L-WH (mm)	ORDER CODE
DALI DT4 Phase Dimmer 300W	ceiling insertion	102-51-30	005-5822000
DALI DT4 Phase Dimmer 1000W	DIN rail	58-70-90	005-5822100

LED-BAND CONTROLLER

TYPE	MOUNTING	L-WH (mm)	ORDER CODE
DALI DT6 Dimmer 1CH 8A 12-48V	ceiling insertion	120-30-22	005-5823000
DALI DT8 Dimmer 2CH TW 16A 12-48V	ceiling insertion	120-30-22	005-5823100
DALI DT8 Dimmer 3CH RGB 16A 12-48V	ceiling insertion	120-30-22	005-5823200
DALI DT8 Dimmer 4CH RGBW 8A 12-48V	ceiling insertion	120-30-22	005-5823300

SENSORS

TYPE	MOUNTING	L-WH (mm)	ORDER CODE
DALI-2 Multisensor 5DPI (Hmax 5m)	ceiling insertion	ø58-65	005-5826000
DALI-2 Multisensor 10DPI (Hmax 10m)	ceiling insertion	ø96-37	005-5826100

REPEATER

TYPE	MOUNTING	L-WH (mm)	ORDER CODE
DALI Repeater	DIN rail	96-72-62	005-5827000







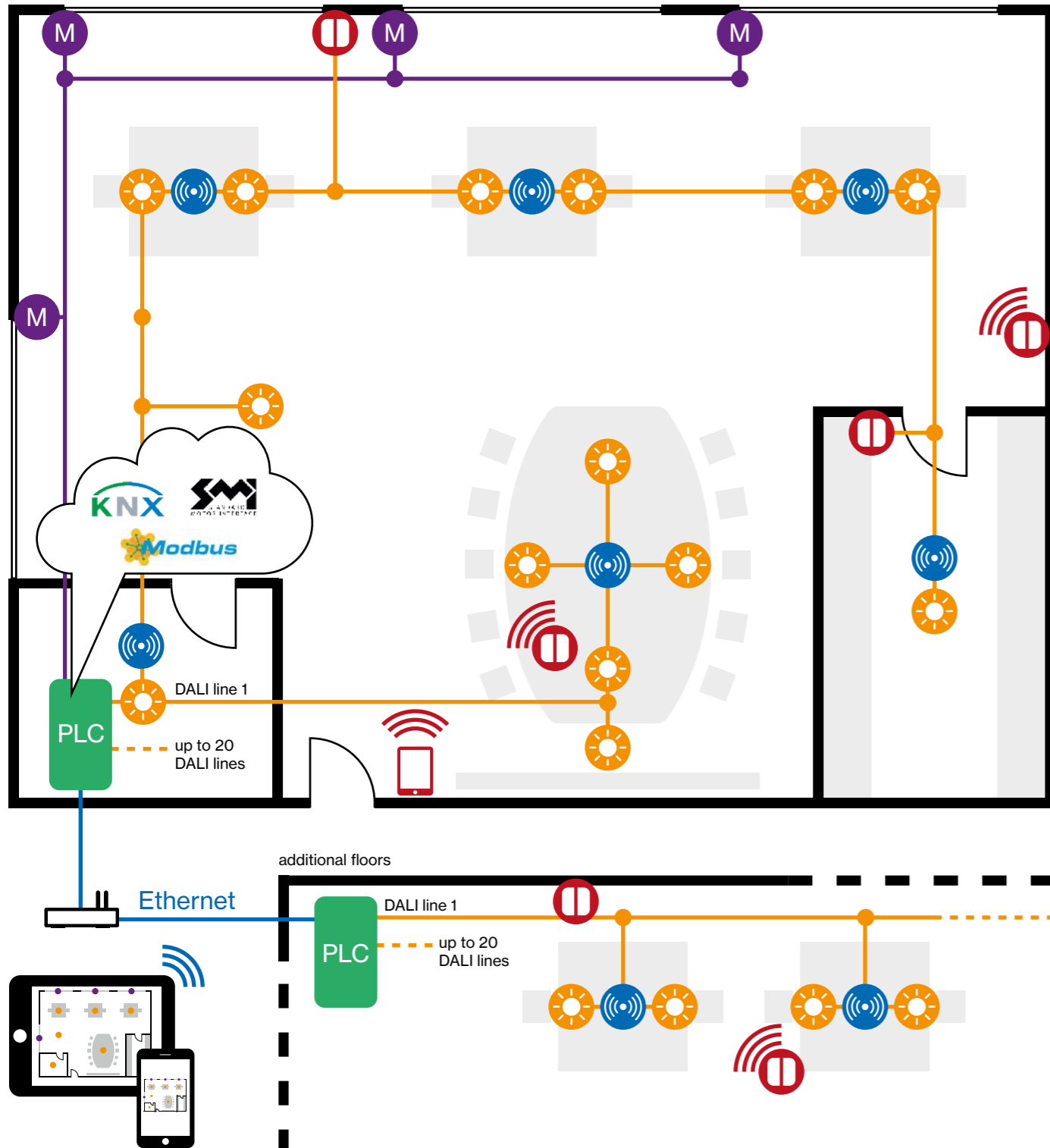

POWER SUPPLY

TYPE	MOUNTING	L-WH (mm)	ORDER CODE
DALI Power Supply 200mA	ceiling insertion	102-51-30	002-59880
DALI Power Supply 240mA	DIN rail	57-36-90	002-59871
DALI Power Supply 70mA	socket	58-30-15	005-5824200

← back

Connection Example



-  Light DALI
-  Sensor DALI
-  Gateway/PLC
-  WLAN router
-  Blinds motor
-  Wall switch DALI
-  Master control
-  Smart device

Professional Building Automation

EN DALI-2 control support, with industrial computer, for up to 10x64 DALI luminaires; flexible expansion options with various interfaces (KNX, Modbus, energy monitoring, digital I/Os); multiple controllers can be linked via network, therefore unlimited system size; support for variable colour luminaires (DT8); groups and scenes across the DALI universe; up to 12 adjustable daylight routines (colour temperature and brightness in % or in Lux with sensor); out-of-the box set-up of the standard application via web interface; detailed user manual; cascading from several controllers via Ethernet possible; Human Centric Lighting (HCL); real time clock via time server; automation functions; reporting; firmware updates regularly available; option for visualisation and expansion up to 20 DALI-2 universes when commissioned by XAL; can be standalone or integrated into IT infrastructure; 24 V controller power supply through external power supply; 18 V DALI-2 interface power supply through external power supply (maximum 5 DALI interfaces per power supply); flexible expansion and free programming options on customer request

DE Industriecomputer gestützte DALI-2 Steuerung von bis zu 10x64 DALI Leuchten; flexibel mit diversen Schnittstellen erweiterbar (KNX, Modbus, Energy Monitoring, digitale Ein- /Ausgänge); mehrere Controller über Netzwerk verknüpfbar daher unbegrenzte Systemgröße; Unterstützung von farbveränderlichen Leuchten (DT8); DALI Universum übergreifende Gruppen und Szenen; bis zu 12 einstellbare Tageslichtverläufe (Farbtemperatur und Helligkeit in % oder in Lux mit Sensor); Inbetriebnahme der Standardapplikation out-of-the-box über Webinterface; ausführliches Benutzerhandbuch; Kaskadierung über Ethernet von mehreren Controllern möglich; Human Centric Lighting (HCL); Echtzeituhr über Timeserver; Automatisierungsfunktionen; Berichterstattung; Firmwareupdates regelmäßig verfügbar; Visualisierungen und Erweiterung auf bis zu 20 DALI-2 Universen bei Inbetriebnahme durch XAL möglich; Standalone oder Einbindung in IT Infrastruktur möglich; Controller Spannungsversorgung 24V durch externes Netzteil; DALI-2 Interface Spannungsversorgung 18V durch externes Netzteil (max 5 DALI Interfaces pro Netzteil); flexible Erweiterungen und freie Programmierung auf Kundenwunsch möglich



INTERFACES			
TYPE	MOUNTING	L-WH (mm)	ORDER CODE
DALI-2 Interface	DIN rail	100-12-69	005-5811100
KNX Interface	DIN rail	100-12-69	005-5811200
Digital Output Interface 8CH	DIN rail	100-12-69	005-5811300
Digital Input Interface 8CH	DIN rail	100-12-69	005-5811400

ENERGY MONITORING			
TYPE	MOUNTING	L-WH (mm)	ORDER CODE
Power Measurement Interface 3-	DIN rail	100-12-69	005-5812000
Current Converter 35A	cable	23-27-46	005-5812100
Current Converter 60A	cable	52-60-81	005-5812200

Extendable Preconfigured Sets

PLC DALI Set custom-made (commissioning required)

TYPE	MOUNTING	ORDER CODE
Customised Solution Basic Set	DIN rail	005-5810100

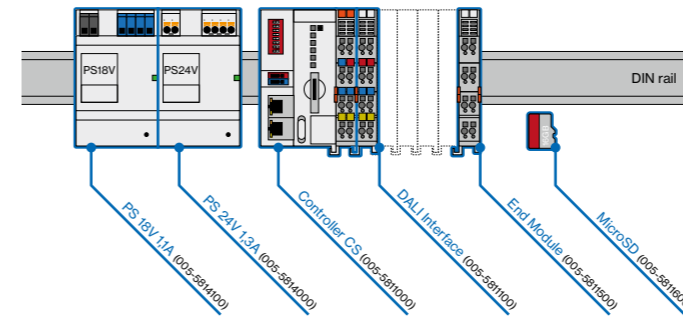

POWER SUPPLY			
TYPE	MOUNTING	L-WH (mm)	ORDER CODE
PS 24V 1,3A (for Controller)	DIN rail	59-54-89	005-5814000
PS 18V 1,1A (for up to 5xDALI-2 Interface)	DIN rail	59-54-89	005-5814100

RELAYS			
TYPE	MOUNTING	L-WH (mm)	ORDER CODE
Blind Relay 16A (30A/4s)	DIN rail	86-15-54	005-5815000
Luminaire Relay 16A (120A/50ms)	DIN rail	86-15-54	005-5815100

PLC DALI Set pre-programmed (Lighting Management)

TYPE	MOUNTING	ORDER CODE
Lighting Management Basic Set	DIN rail	005-5810000

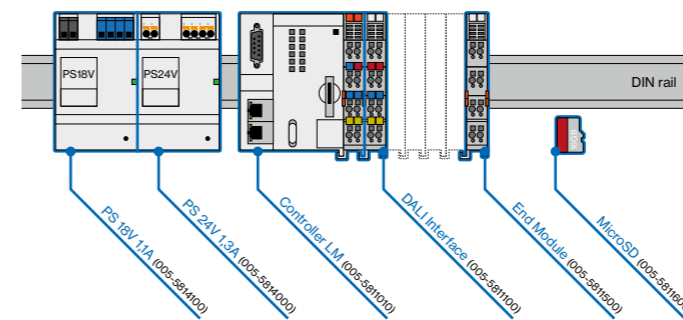

← back

Connection Example

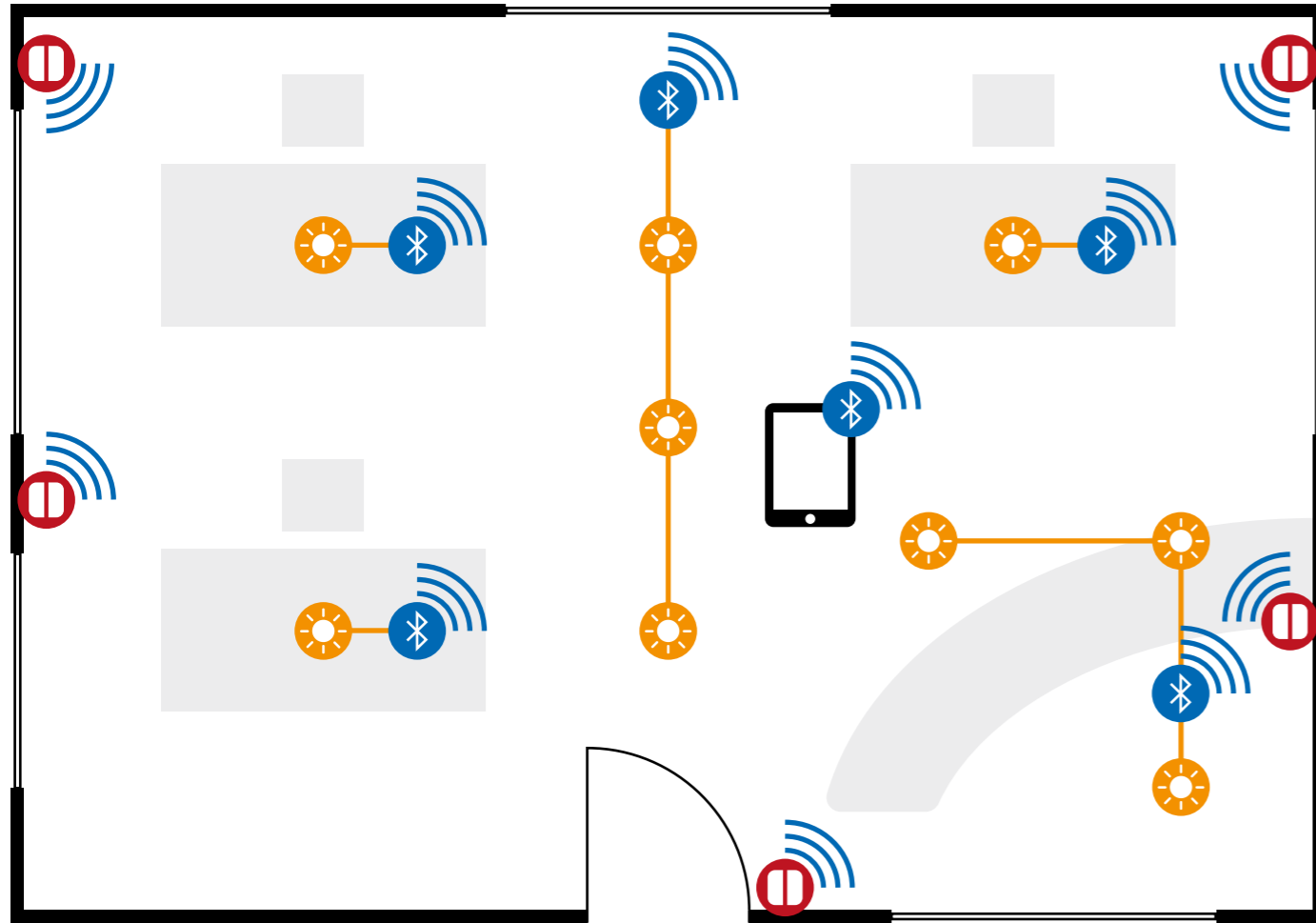

Configuration

<p>Active Module & SR Module</p>	<p>Passive Module</p>
<p>PWM CV Module</p>	<p>Sensor</p>
<p>Switch Piezo & X-Press</p>	<p>XAL Wireless Adapter</p>



Casambi

EN Bluetooth-based mesh network for control of DALI luminaires and LED strips; network size up to 128 nodes; support of colour-changing luminaires (DT8); adjustable daylight gradients and Human-Centric Lighting (HCL) respectively; launch and control via smartphone or tablet via Bluetooth; time functions via integrated clock; system expansion possible via DALI-2 push-button modules and sensors; over-the-air firmware update; power supply either integrated or via DALI bus, depending on module; compatible with all DALI-2 peripherals

DE Bluetooth-basiertes Mesh-Netzwerk zur Steuerung von DALI Leuchten und LED Bändern; Netzwerkgröße bis 128 Knoten; Unterstützung von farbveränderlichen Leuchten (DT8); Einstellbare Tageslichtverläufe bzw. Human Centric Lighting (HCL); Inbetriebnahme und Steuerung mittels Smartphone oder Tablet über Bluetooth; Zeitfunktionen durch Uhrzeitabnahme vom Smart Device; Systemerweiterung über DALI-2 Tastermodule und Sensoren möglich; Over-the-Air Firmwareupdate; Spannungsversorgung je nach Modul entweder integriert oder über DALI Bus; mit allen DALI-2 Peripheriekomponenten kompatibel



ACTIVE MODULE 220-240 V			
TYPE	OUTPUT	L-WH (mm)	ORDER CODE
DALI Single Control	Broadcast Commands	81-30-16	0 0 5 - 5 8 6 1 0 0 0
max. 5 DALI-2 nodes			



SR MODULE 220-240 V			
TYPE	OUTPUT	L-WH (mm)	ORDER CODE
DALI Broadcast Control	Broadcast Commands	119-30-21	0 0 5 - 5 8 6 2 0 0 0
max. 25 DALI-2 nodes / max. 4 DALI-2 groups			



PASSIVE MODULE DALI-2			
TYPE	OUTPUT	L-WH (mm)	ORDER CODE
DALI Group Control without Power Supply	Group / Broadcast Commands	81-30-16	0 0 5 - 5 8 6 3 0 0 0
max. 4 DALI-2 groups			



4CH PWM CV MODULE 12-24 VDC			
TYPE	OUTPUT	L-WH (mm)	ORDER CODE
LED Strip Controller	PWM Voltage	73-30-18	0 0 5 - 5 8 6 4 0 0 0
max. 144 W			



SENSOR 220-240 V			
TYPE	OUTPUT	L-WH (mm)	ORDER CODE
Occupancy / Light Sensor	Casambi Signal	85-85-74	0 0 5 - 5 8 6 5 0 0 0



SWITCH PIEZO Batteryless			
TYPE	OUTPUT	L-WH (mm)	ORDER CODE
2CH white	Casambi	81-81-14	0 0 5 - 5 8 6 7 0 0 7
4CH white	Casambi	81-81-14	0 0 5 - 5 8 6 7 0 0 8



SWITCH X-PRESS CR2430 Battery			
TYPE	OUTPUT	L-WH (mm)	ORDER CODE
4CH white	Casambi	90-90-12	0 0 5 - 5 8 6 6 2 0 0
4CH black	Casambi	90-90-12	0 0 5 - 5 8 6 6 4 0 0



WIRELESS TO DALI-2 CONTROL DEVICE			
TYPE		L-WH (mm)	ORDER CODE
Casambi		111-25-45	0 5 0 - 2 0 6 5 2 3 0
max. 64 DALI-2 nodes / max. 4 DALI-2 groups			

← back

Connection Example

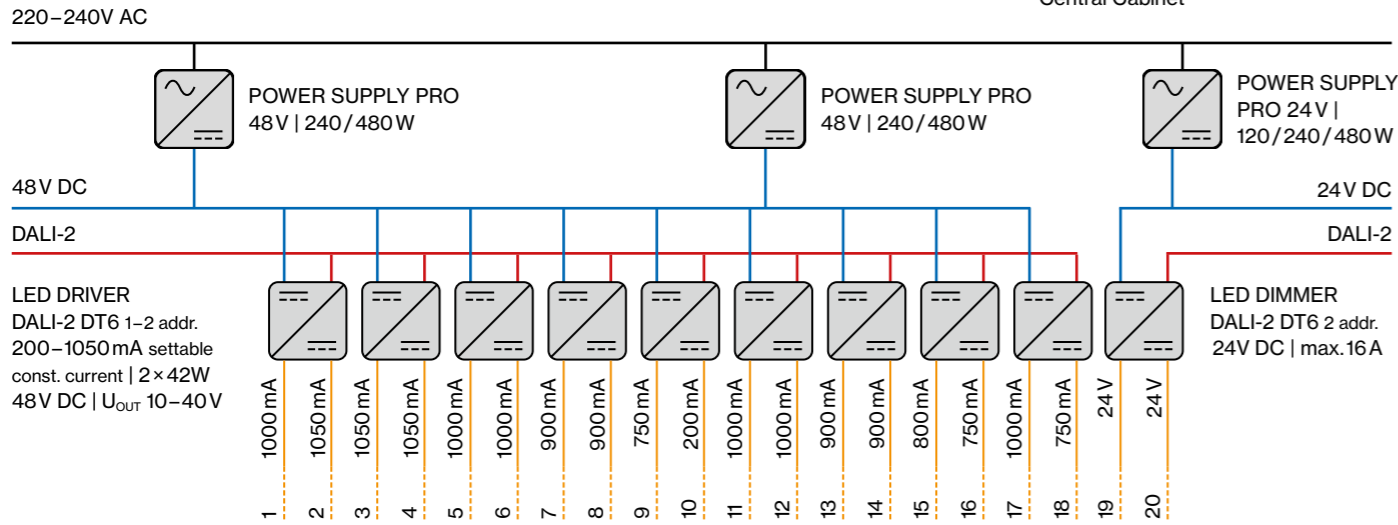

□ Parallel connection
↔ Serial connection

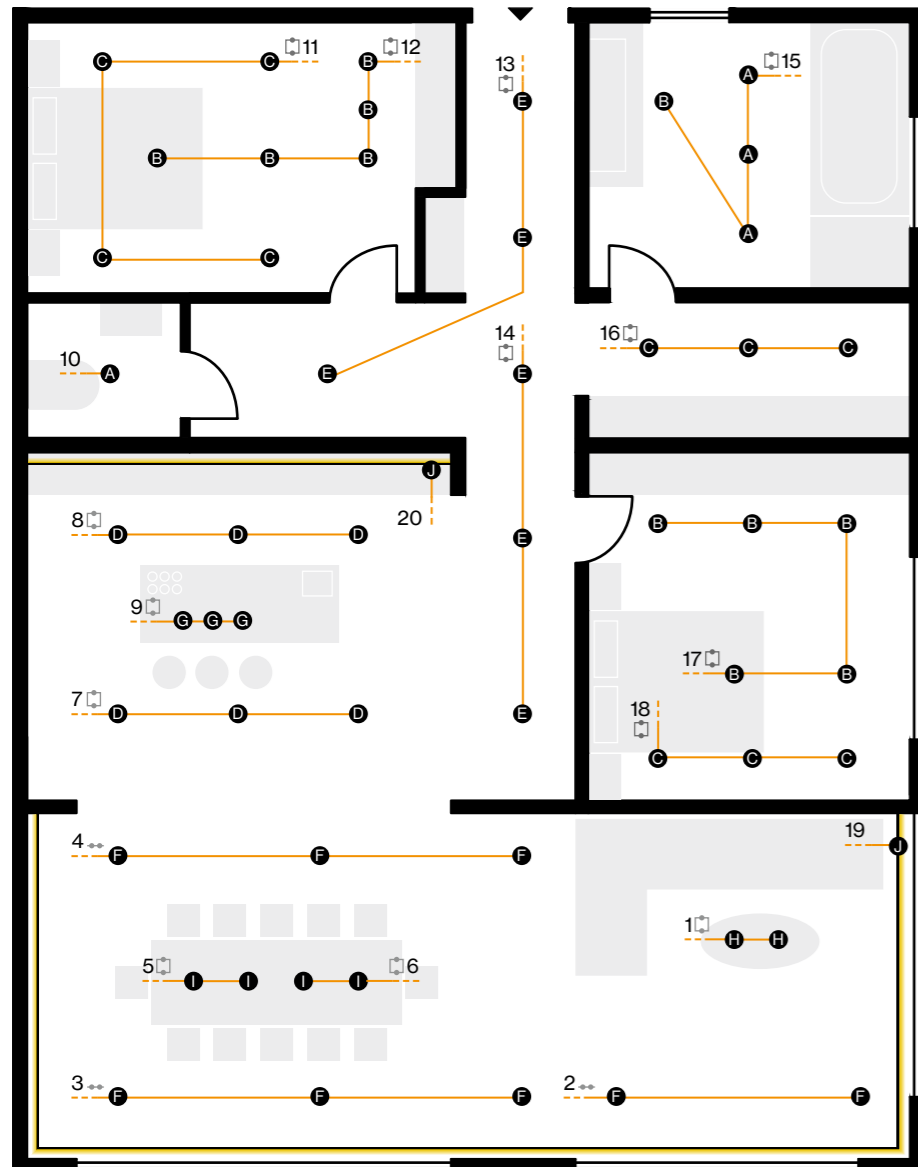

- A** SASSO 40 round recessed downlight 7.4W 36 Vf 200mA
- B** SASSO 40 round recessed adjustable 7.4W 36 Vf 200mA
- C** SASSO 40 round recessed wallwasher 6.8W 27 Vf 250mA
- D** SASSO 60 square recessed downlight 10.7W 36 Vf 300mA
- E** SASSO 60 square semi-recessed 10.7W 36 Vf 300mA
- F** SPIO 60 adjustable 12.2W 12V 1050mA
- G** MOVE IN 32 flex recessed 8.8W 36 Vf 250mA
- H** TULA micro suspended 8.4W 18 Vf 500mA
- I** ARY shade suspended 8.4W 18 Vf 500mA
- J** LED Strip 24V

DIN Rail Components

EN DALI-2 DIN Rail constant current / constant voltage driver for DIN rail mounting; supply voltage 24/48 VDC; output current (constant current) 200–1050 mA; output current (constant voltage) 16 A. The driver is equipped with two output channels, each providing a maximum power of up to 42 W (constant current) or 380 W (constant voltage). Until the maximum power is reached, various combinations of parallel and series connections of constant current LED loads are possible; the DIN Rail driver is located in the central current distribution board and requires a corresponding wiring of the LED loads to the distribution; parallel-added LED loads share the set or maximum output current; Serial loads share the maximum output voltage; active load monitoring prevents failure-related overcurrent of parallel, constant current LED loads.

DE DALI-2 DIN Rail konstant Strom / konstant Spannung Treiber zur Hutschienen Montage; Versorgungsspannung 24/48 VDC; Ausgangsstrom (konstant Strom) 200–1050 mA; Ausgangsstrom (konstant Spannung) 16 A. Der Treiber ist mit zwei Ausgangskanälen ausgestattet die jeweils eine maximale Leistung von bis zu 42 W (konstant Strom) bzw. 380 W (konstant Spannung). Bis zum Erreichen der maximalen Leistung sind verschiedenste Kombinationen aus Parallel- und Serienschaltung von konstant Strom LED-Lasten möglich; Der DIN Rail Treiber findet in der zentralen Elektroverteilung Platz und erfordert eine dementsprechende Verkabelung der LED-Lasten zur Verteilung; Parallel hinzugefügte LED-Lasten teilen sich den eingestellten bzw. maximalen Ausgangsstrom; Serielle Lasten teilen sich die maximale Ausgangsspannung; Aktive Lastüberwachung verhindert ausfallbedingte Überbestromung von parallelen konstant Strom LED-Lasten.

DIN Rail components constant voltage

POWER SUPPLY BASIC 24V
220–240V | 50–60Hz | □ PC II | MTBF @ 55° ambient temperature

TYPE	EFFICIENCY / MTBF	WHD (mm)	ORDER CODE
96W	η 87% / > 150.000h	90-90-60	005-6210010

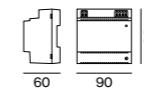

POWER SUPPLY PRO 24V
220–240V | 50–60Hz | ⊕ PC I | MTBF @ 55° ambient temperature cascadable max. 5 devices (120W, 240W) or 3 devices (480W)

TYPE	EFFICIENCY / MTBF	WHD (mm)	ORDER CODE
120W	η 87% / > 400.000h	40-125-100	005-6210010
240W	η 90% / > 350.000h	60-125-100	005-6210110
480W	η 91% / > 250.000h	120-125-100	005-6210210

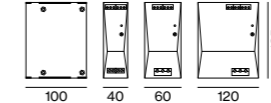

LED DIMMER
DALI-2 DT6 1–4 addr. | 12/24/48V DC | max. 16A (total) MTBF > 100.000h @ 55° ambient temperature

TYPE	WHD (mm)	ORDER CODE
LED Dimmer 1 channel	18-90-57	005-6311010
LED Dimmer 2 channels	18-90-57	005-6311110
LED Dimmer 4 channels	18-90-57	005-6311210



POWER SUPPLY BASIC 48V
220–240V | 50–60Hz | □ PC II | MTBF @ 55° ambient temperature

TYPE	EFFICIENCY / MTBF	WHD (mm)	ORDER CODE
96W	η 89% / > 300.000h	90-90-60	005-6520010

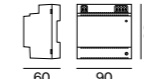

POWER SUPPLY PRO 48V
220–240V | 50–60Hz | ⊕ PC I | MTBF @ 55° ambient temperature cascadable max. 5 devices (240W) or 3 devices (480W)

TYPE	EFFICIENCY / MTBF	WHD (mm)	ORDER CODE
240W	η 92% / > 400.000h	60-125-100	005-6220110
480W	η 93% / > 350.000h	120-125-100	005-6220210

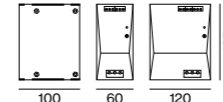

DIN Rail components constant current

LED DRIVER
DALI-2 DT6 1–2 addr. | 200–1050mA settable constant current in 50mA steps 2 × 42W | 48V DC | U_{OUT} 10–40V MTBF ≥ 400.000h @ +55° ambient temperature

TYPE	EFFICIENCY	WHD (mm)	ORDER CODE
LED Driver 2channels	η 93%	36-88-59	005-6121030



MTBF is the mean time between failure

← back

Colour rendering

EN The colour fidelity of light sources is evaluated according to the CIE 13.3 international colour rendering rating. The test light source is compared with a reference light source using 15 selected test colours. The more accurately the test light source reproduces the test colour, the higher the colour rendering index R_a (a for German allgemein, meaning general).

The mean value of the first eight test colours (R1–R8) produces the colour rendering index. This average value is divided into moderately good colour rendering CRI 70–80, e.g. for street lighting; good colour rendering CRI 80–90, e.g. for workplace lighting; and excellent colour rendering CRI 90–100, e.g. for museums, retail, and medical examinations. The minimum requirement defined in lighting standard EN 12464-1 is $CRI \geq 80$. The values of the test colours R9–R15 provide information about the colour fidelity of the saturated colours (R9–R12), skin colour (R13), leaf green (R14), and Asian skin tone (R15). The average value of all 15 test colours, which is called $R(1-15)$, is used when evaluating colour reproduction beyond the minimum normative requirements. Consideration of the $R(1-15)$ value is only sensible if the quality requirements are very high, starting from $CRI \geq 90$. If the $R(1-15)$ value is ≥ 90 when CRI is also ≥ 90 , this is an excellent light source. An $R(1-15)$ of ≥ 95 indicates the highest light quality.

DE Die Farbtreue von Lichtquellen wird nach der internationalen Farbwiedergabebewertung CIE 13.3 bewertet. Dabei wird die Testlichtquelle mit einer Referenzlichtquelle anhand von 15 ausgewählten Testfarben verglichen. Je genauer die Testlichtquelle die Testfarbe wiedergibt, desto höher ist der Farbwiedergabeindex R_a (a für allgemein).

Der Mittelwert der ersten acht Testfarben (R1–R8) ergibt den Farbwiedergabeindex R_a . Dieser Mittelwert wird eingeteilt in: mäßig gute Farbwiedergabe R_a 70–80, z.B. für Straßenbeleuchtung; in gute Farbwiedergabe R_a 80–90, z.B. für Beleuchtung von Arbeitsstätten und in sehr gute Farbwiedergabe für R_a 90–100, z.B. für Museen, Retail und ärztliche Untersuchungen. Die Mindestanforderung der Beleuchtungsnorm EN 12464-1 ist mit $R_a \geq 80$ festgelegt. Die Werte der Testfarben R9–R15 geben Auskunft über die Farbtreue der gesättigten Farben (R9–R12), der Hautfarbe (R13), von Blattgrün (R14) und über den asiatischen Hautfarbton (R15). Um die Farbwiedergabe über die normative Mindestanforderung hinaus zu bewerten, kann der Mittelwert aller 15 Testfarben angegeben werden, der mit R_e bezeichnet wird. Die Betrachtung des R_e -Wertes ist nur bei sehr hohen Qualitätsansprüchen sinnvoll, beginnend mit $R_a \geq 90$. Ist bei einem $R_a \geq 90$ der R_e -Wert auch ≥ 90 handelt es sich um eine sehr gute Lichtquelle. Die höchste Lichtqualität ist mit einem R_e von ≥ 95 angegeben.

CRI / $R_a \geq 80$ (4000K)

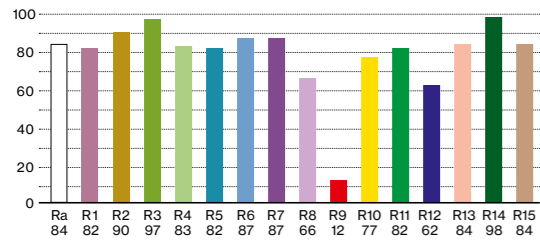

Example

CRI / $R_a \geq 90$ (4000K)

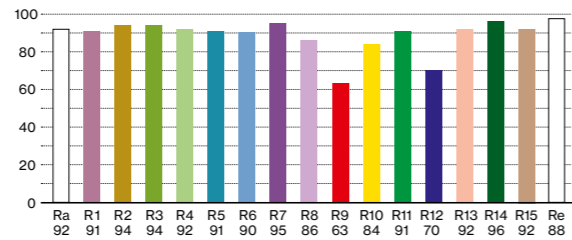

Example

CRI / $R_a \geq 95, R_e \geq 95$ (3000K)

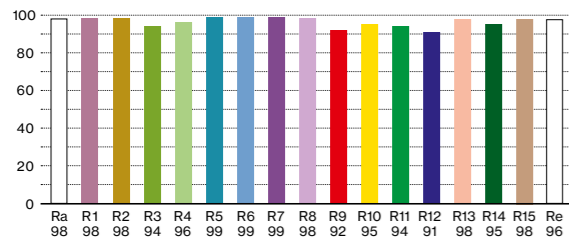

Example

IES TM 30

EN The TM 30 colour-rendering rating is intended to supplement the CIE 13.3 colour-rendering rating and is established primarily in the American-Pacific region. Instead of eight test colours, 99 test colours were selected from daily life. The average of all 99 test colours is output as R_f (f for fidelity). To evaluate the colour saturation, the R_g value (g for gamut) is defined. These two values are determined together. For R_f , the highest value is 100; for R_g , a maximum value of 140 is theoretically possible. As the R_f value approaches the maximum value of 100, the R_g value approaches the maximum of 100.

DE Die Farbwiedergabe Bewertung TM 30 ist als Ergänzung zur Farbwiedergabebewertung CIE 13.3 gedacht und ist vor allem im amerikanisch-pazifischen Raum etabliert. Statt acht Testfarben wurden 99 Testfarben gewählt, die im täglichen Leben vorkommen. Der Mittelwert aus allen 99 Testfarben wird als R_f ausgegeben (f für Fidelity = Farbtreue). Um auch die Farbsättigung bewerten zu können ist der R_g -Wert (g für Gamut = Farbtonumfang) definiert worden. Diese beiden Werte werden gemeinsam ermittelt. Beim R_f ist der höchste Wert 100; bei R_g ist theoretisch ein Maximalwert von 140 möglich. Je näher der R_f -Wert an dem Maximalwert von 100 heranreicht, umso näher liegt auch der R_g -Wert beim Maximum von 100.

TM 30 R_f colour-fidelity rating of a test lamp

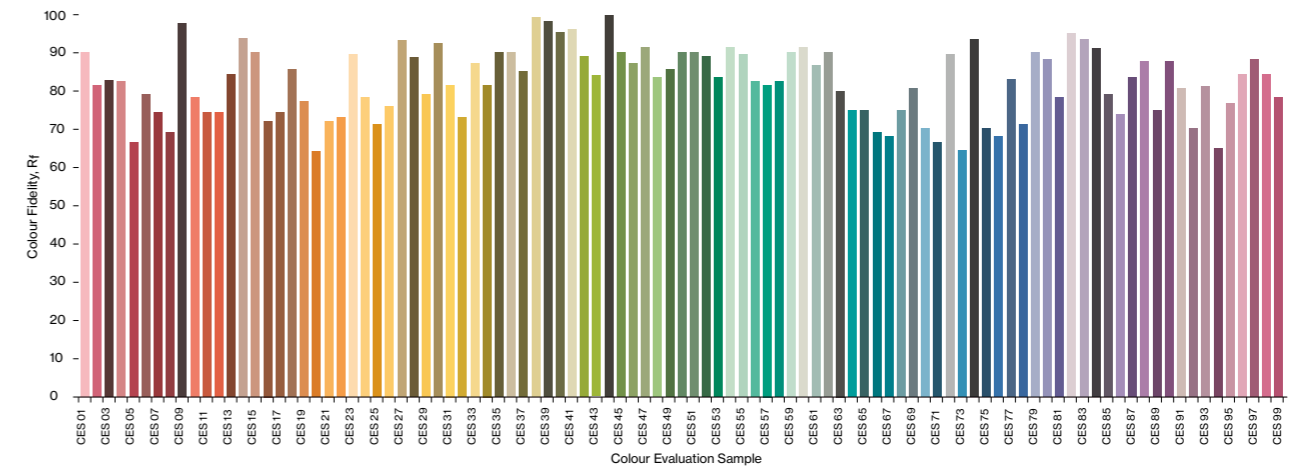

TM 30 R_g colour-saturation rating of a test lamp

Colour vector image

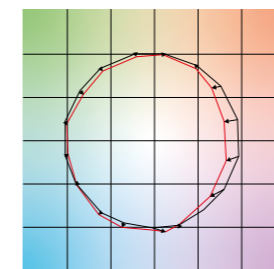

EN The red line indicates the results of the test light source. The deviation from the test light source to the reference is shown and is marked by arrows.

DE Die rote Linie zeigt die Ergebnisse der Test-Lichtquelle. Die Abweichung von Test-Lichtquelle zur Referenz ist erkennbar und wird durch Pfeile markiert.

Colour distortion icon



EN The reference is a white line on a black background. The over-saturation or undersaturation is very clearly visible.

DE Die Referenz ist eine weiße Linie auf schwarzem Grund. Die Über-, bzw. Untersättigung ist sehr klar sichtbar.

TM 30 evaluation matrix

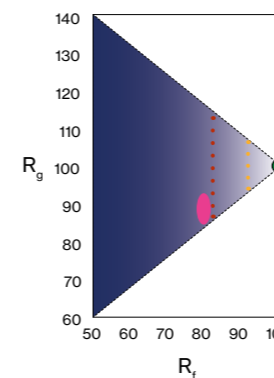

EN Green dot: highest light quality; up to yellow dashed line: very good light quality; up to red dashed line: good light quality. Pink range: typical CRI ≥ 80 lamps are slightly below the value of R_f 80 and have a lower saturation than R_g 80.

DE Grüner Punkt: höchste Lichtqualität; bis gelb strichlierte Linie: sehr gute Lichtqualität; bis rot strichlierte Linie gute Lichtqualität. pinker Bereich: Typische CRI ≥ 80 Leuchtmittel liegen etwas unter dem Wert von R_f 80 und haben eine geringe Sättigung von R_g 80

← back

Full-spectrum LED

EN Our pupil size adapts to the light spectrum. Studies by GAMLIN already showed in 2007 that the eye's pupillary control lies in the cyan region. Standard LEDs have a very high blue content and hardly any cyan wavelengths. As a result, the eye's sensitive cells adjust to low light under these lighting conditions. As a result, the pupil dilates, and excessive blue light reaches the retina. XAL's XPECTRUM LED reproduces the natural daylight spectrum by reducing the blue-light component and increasing the cyan values. This minimises blue light's danger to the eye and brings it to a level similar to daylight.

The effect goes beyond the visual field of vision. The non-visual, or biological effect of light, affects numerous bodily functions, such as hormone release, and is in part responsible for improved sleep and concentration. The biological light effect's evaluation is described in DIN SPEC 5031-100. Melanopic lighting designs can be realised much more energy-efficiently with the new XPECTRUM LEDs.

Furthermore, the full-spectrum LEDs boast excellent colour rendering. The R(1-15) colour-fidelity rating—the average of CRI 97 of all 15 test colours—is 98. The TM 30 colour-rendering evaluation results in a colour fidelity of $R_f = 98$ and a colour gamut of $R_g = 101$. XAL's XPECTRUM LEDs' high colour fidelity delivers improved visual comfort.

DE Die Pupillengröße passt sich entsprechend des Lichtspektrums an. Untersuchungen von GAMLIN zeigten bereits 2007, dass die Pupillensteuerung des Auges im cyanfarbenen Bereich liegt. Standard-LEDs haben einen sehr hohen Blauanteil und kaum cyanfarbene Wellenlängen. Dadurch stellen sich die empfindlichen Zellen des Auges unter diesen Lichtbedingungen auf Dunkelheit ein. Die Folge: Die Pupille weitet sich und eine zu große Menge blaues Licht gelangt auf die Netzhaut. Die XPECTRUM-LED von XAL erreicht das natürliche Tageslichtspektrum indem der Blauanteil reduziert und die Cyan-Werte erhöht werden. Somit wird die Blaulichtgefahr für das Auge minimiert und auf ein tageslichtähnliches Niveau gebracht.

Dabei geht die Wirkung über den visuellen Sehbereich hinaus: Die nicht-visuelle oder biologische Lichtwirkung beeinflusst zahlreiche Körperfunktionen, wie die Hormonausschüttung und ist mitverantwortlich für einen besseren Schlaf und erhöhte Konzentrationsfähigkeit. Die Bewertung dieser biologischen Lichtwirkung wurde in der DIN SPEC 5031-100 beschrieben. Melanopische Lichtplanungen können mit den neuen XPECTRUM-LED's deutlich energieeffizienter realisiert werden.

Zudem erzielen die Vollspektrum-LEDs eine hervorragende Farbwiedergabe von $R_a = 97$. Die Farbtreue-Bewertung der R_e –Mittelwert aller 15 Testfarben– liegt bei 98. Die Farbwiedergabe Bewertung TM 30 ergibt eine Farbtreue $R_f = 98$ und einen Farbtonumfang $R_g = 101$. Dieser hohe Farbtreue-Wert der XPECTRUM-LEDs von XAL ermöglicht einen verbesserten Sehschmerz.

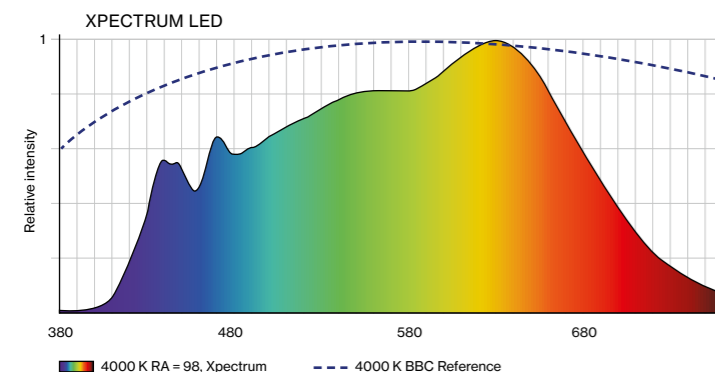

EN The green curve is the human brightness-sensitivity curve v_λ . The blue curve is the sensitivity curve of the retinal ganglion cells, $S_{mel,\lambda}$. The pupil size is controlled by the intensity within the blue curve. The differences in intensity between XPECTRUM LEDs and conventional LEDs are clearly visible.

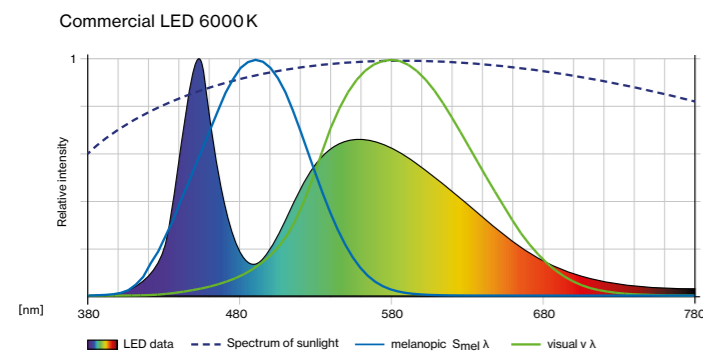

DE Grüne Kurve ist die menschliche Helle-Empfindlichkeits Kurve v_λ . Die blaue Kurve ist die Empfindlichkeitskurve der retinalen Ganglienzellen, $S_{mel,\lambda}$. Die Pupillengröße wird durch die Intensität innerhalb der blauen Kurve gesteuert. Deutlich sind die Intensitätsunterschiede von XPECTRUM-LED zu konventionellen LEDs sichtbar.

TW – Tunable White

EN Tunable White luminaires can independently, and with infinite variability, set the illuminance and the colour temperature between 1800K to 6500K, as desired. Every change in colour temperature and illuminance affects human well-being. The Kruithof comfort curve shows that high illuminance levels should be paired with cool colour temperatures and low illuminance levels with warm colour temperatures. Therefore, to best aid well-being, it is recommended to imitate daylight during the day with cool colour temperatures, and the evening with warm colour temperatures.

DE Mit Tunable White Leuchten lässt sich die Beleuchtungsstärke und Farbtemperatur individuell von 1800K bis 6500K stufenlos unabhängig regulieren. Jede Veränderung der Farbtemperatur und Beleuchtungsstärke beeinflusst das menschliche Wohlbefinden. Laut der Kruithof'schen Behaglichkeitskurve sollten hohe Beleuchtungsstärken eher mit kühlen Farbtemperaturen, niedrige Beleuchtungsstärken bei warmen Farbtemperaturen verwendet werden. Daher empfiehlt es sich, tagsüber mit kühlen Farbtemperaturen und abends mit warmen Farbtemperaturen das Tageslicht nachzubilden, um damit das Wohlbefinden bestmöglich zu unterstützen.

Kruithof curve

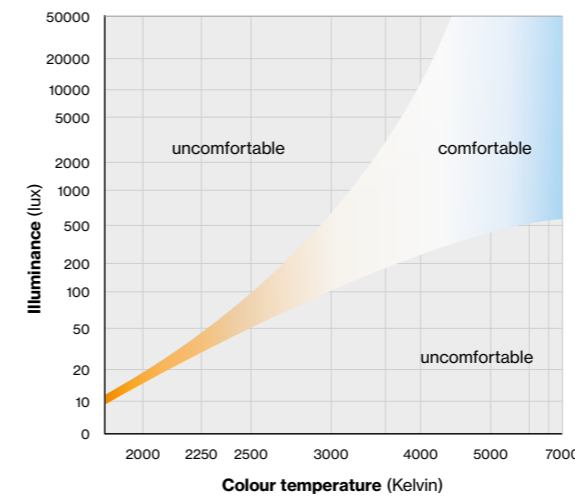

CWD – Colour Warm Dimming

EN With the CWD (Colour Warm Dimming) option, when the light intensity drops, the colour temperature simultaneously changes smoothly from 3000K to 1800K, in a similar manner to the dimming of a filament bulb (see diagram). The reduction in illuminance grants the light a very warm hue. This variable illuminance delivers a balanced working light during the day and a relaxing lighting mood in the evening. The CWD colour temperature curve runs within the comfort zone (see Kruithof curve).

DE Mit der CWD-Option (Colour Warm Dimming) erfolgt bei einer Reduzierung der Lichtintensität gleichzeitig eine stufenlose Veränderung der Farbtemperatur von 3000K auf 1800K –ähnlich der Dimmcharakteristik einer Glühlampe (siehe Grafik). Die Reduzierung der Beleuchtungsstärke ermöglicht einen sehr warmen Farbton des Lichts. Somit sind wahlweise tagsüber ein ausgewogenes Arbeitslicht und abends eine entspannende Lichtstimmung möglich. Die CWD-Farbtemperaturkurve verläuft innerhalb des Wohlfühlbereiches (siehe Kruithof-Kurve).

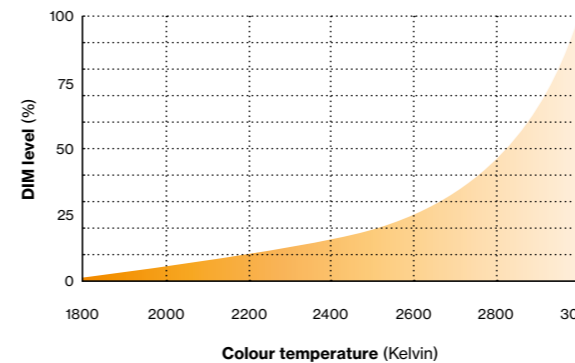

[← back](#)

Low flicker

EN TLA (Temporal Light Artifacts) is irritating to the human eye and is therefore always perceived as disturbing. In nature, the eye has adapted over millions of years to a gradual increase and decrease in light intensity. Rapid light intensity changes are unnatural. Even the flickering of a candle can be unsettling.

Electrically operated luminaires always have at least some light intensity changes in the luminous flux due to the 50Hz alternating current. To limit these to a tolerable level, the EU's Ecodesign Directive has been in force since 1st September 2021.

The following specifications must be observed for light sources:

Output P st LM (at full load) ≤ 1

Explanation: "st" for "short term" and "LM" for "light flicker measurement method". For frequencies from 0 to 80 Hz.

Output SVM (at full load) ≤ 0.9 (from 1st September 2024 ≤ 0.4)

Explanation: "SVM" for "Stroboscopic Effect Visibility Measure". For frequencies from 80 Hz to 2,000 Hz. Frequencies above 2,000 Hz usually do not result in any adverse effects on the viewer and are therefore not included in the directive.

The EU directive only refers to the light source, but not to the surrounding product (e.g. luminaire).

XAL goes a step further and applies this specification to the light source and also to any surrounding product, i.e. to all luminaires. All XAL luminaires placed on the market after 1st September 2021 comply with the EU directive 2019/2020 (of 1st October 2019) to define ecodesign requirements for light sources and separate operating devices according to Directive 2009/125/EC of the European Parliament.

However, the Ecodesign Directive only refers to values that must be undercut under full load. Light modulations caused by luminaires in a dimmed state are not covered by the directive.

DE Zeitliche Lichtmodulation, TLA (Temporal Light Artifacts) ist eine Irritation für das menschliche Auge und wird somit immer als störend empfunden. Das Auge hat sich in der Natur über Jahrmillionen an eine allmähliche Zu- und Abnahme der Lichtintensität angepasst. Schnelle Licht-Intensitätsänderungen sind unnatürlich. Selbst das Flackern einer Kerze kann beunruhigend wirken.

Elektrisch betriebene Leuchtmittel haben, auf Grund des 50Hz Wechselstroms, immer eine mehr oder weniger große Licht-Intensitätsänderung im Lichtstrom. Um diese auf ein erträgliches Maß zu begrenzen, gilt seit 01. September 2021 die Ökodesign-Verordnung der EU.

Folgende Vorgaben müssen für Lichtquellen eingehalten werden:

Output P st LM (at full load) ≤ 1

Erklärung: „st“ (short term) für „Kurzzeit“ und „LM“ für „Licht-Flimmermessmethode“. Für Frequenz von 0 bis 80Hz.

Output SVM (at full load) $\leq 0,9$ (ab 01.09.2024 $\leq 0,4$)

Erklärung: SVM Stroboscopic Effect Visibility Measure, stroboskopische Sichtbarkeitsmessung. Für Frequenz von 80Hz bis 2.000Hz.

Frequenzen über 2.000Hz führen i.d.R. zu keinen Beeinträchtigungen des Betrachters und werden daher in die Verordnung nicht mit einbezogen.

Die EU-Verordnung bezieht sich nur auf die Lichtquelle, jedoch nicht auf das umgebende Produkt (z.B. Leuchte).

XAL geht einen Schritt weiter und wendet diese Vorgabe nicht nur auf die Lichtquelle, sondern auch auf jedes umgebende Produkt, d.h. auf alle Leuchten an. Alle, nach dem 01. September 2021 auf den Markt gebrachte XAL-Leuchten entsprechen der Verordnung (EU) 2019/2020 Der Kommission (vom 01. Okt. 2019) zur Festlegung von Ökodesign-Anforderungen an Lichtquellen und separaten Betriebsgeräten gemäß der Richtlinie 2009/125/EG des Europäischen Parlaments.

Die Ökodesign-Verordnung bezieht sich jedoch nur auf Werte, die unter Vollast (full load) unterschritten werden müssen. Lichtmodulationen, die durch Leuchten in gedimten Zustand verursacht werden, sind in der Verordnung nicht erfasst.

Photobiological safety in lighting

EN Photobiological safety refers to the potential risk of photochemical damage to the eye's retina triggered by strong electromagnetic radiation from light sources, primarily in the wavelength range between 380nm and 500nm.

Legal framework

For the assessment of the photobiological safety of the optical radiation generated by lamps, there are measurement regulations and evaluation standards that are specified in the EN 62471:2008 European standard. It is in accordance with the European Directive 2006/25/EC.

Assessment of the blue light hazard from light sources

Unlike UV radiation, which is already absorbed in the outer tissue layers of the eye, blue light rays pass through the cornea and are imaged on the retina. Small light sources with high luminance create a locally high risk, while the identical radiant power is distributed in a large-area light source, creating a lower risk.

Risk classification of lamps and luminaires

For all types of hazards, there are measurement methods as well as limit values for radiance or irradiance. The luminaires are classified into risk groups of levels 0 to 3 accordingly.

DE Fotobiologische Sicherheit bezieht sich auf das potenzielle Risiko einer fotochemischen Schädigung der Netzhaut des Auges, ausgelöst durch starke elektromagnetische Strahlung von Lichtquellen, in erster Linie im Wellenlängenbereich zwischen 380nm und 500nm.

Gesetzliche Rahmenbedingungen

Zur Beurteilung der fotobiologischen Sicherheit, der durch Lampen erzeugten, optischen Strahlung bestehen Messvorschriften und Bewertungsmaßstäbe, die in der europäischen Norm EN 62471:2008 festgelegt sind. Sie steht in Übereinstimmung mit der europäischen Richtlinie 2006/25/EG.

Beurteilung der Blaulichtgefährdung durch Lichtquellen

Anders als die UV- Strahlung, die bereits in den äußeren Gewebeschichten des Auges absorbiert wird, durchdringen blaue Lichtstrahlen die Hornhaut und werden auf der Netzhaut abgebildet. Kleine Lichtquellen mit hoher Leuchtdichte erzeugen ein lokal hohes Risiko, während die identische Strahlungsleistung sich bei einer großflächigen Lichtquelle verteilt und dadurch ein geringeres Risiko darstellt.

Risikoklassifizierung von Lampen und Leuchten

Für alle Gefährdungsarten existieren Messverfahren sowie Grenzwerte der Strahldichte oder der Bestrahlungsstärke, entsprechend derer die Leuchtmittel in Risikogruppen der Stufen 0 bis 3 eingeteilt werden.

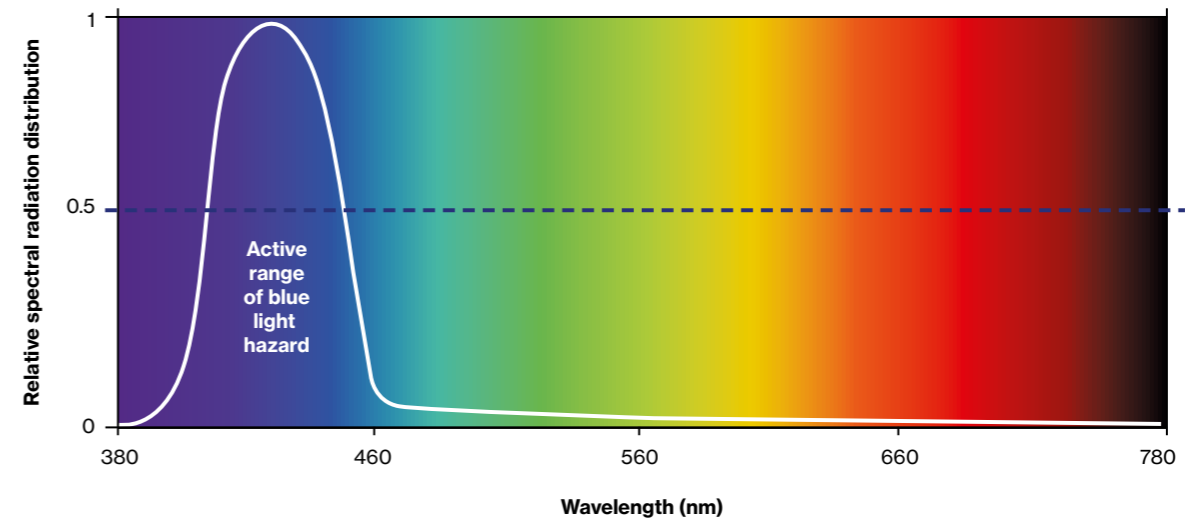

Conventional light panels correspond to risk group 0. Spotlights often fall into risk group 1. Powerful spotlights can also fall into risk group 2. Luminaires in risk group 2 must be marked with a warning.

For more information visit xal.com/know-how

Übliche Flächenleuchten entsprechen der Risikogruppe 0. Strahler fallen oft in die Risikogruppe 1. Leistungsstarke Strahler können auch in die Risikogruppe 2 fallen. Leuchten der Risikogruppe 2 müssen mit einem Warnhinweis gekennzeichnet werden.

Mehr Informationen finden Sie unter xal.com/know-how

[←](#) back



IoT ready

EN Unlike DALI-2 or Zigbee 3.0, IoT ready is not a standard, but instead demonstrates the possibility of equipping a luminaire with various sensors (presence, brightness, temperature, air quality, acoustics, etc.) and addressing them wirelessly. Existing standards ensure that our customers retain full control. An IoT ready luminaire can become an active part of the Internet of Things. In addition to its primary task of illuminating a room, it can send the building management system essential data about the room and its use or user preferences. Data collected in the IoT can guide direct control and optimise a wide range of functions such as lighting, HVAC (heating, ventilation, and air conditioning), cleaning, security, and much more.

DE IoT ready ist im Gegensatz zu DALI-2 oder Zigbee 3.0 kein Standard, sondern zeigt die Möglichkeit auf, eine Leuchte mit diverser Sensorik (Präsenz, Helligkeit, Temperatur, Luftqualität, Akustik usw.) auszustatten und diese auch drahtlos anzusprechen. Dabei werden bestehende Standards verwendet, um unsere KundInnen bei der Ansteuerung nicht einzuschränken. Eine IoT ready Leuchte kann aktiver Teil des Internet-of-Things werden und neben ihrer primären Aufgabe, einen Raum auszuleuchten, auch das Building Management System mit essentiellen Daten über den Raum und dessen Nutzung bzw. Präferenzen des Nutzers versorgen. Daten, welche im IoT gesammelt werden, können direkt zum Steuern und Optimieren unterschiedlichster Gewerke wie Beleuchtung, HVAC (Heating, Ventilation and Air Conditioning), Reinigung, Sicherheit uvm. verwendet werden.



DALI lighting control

EN The DALI-2 (Digital Addressable Lighting Interface) control protocol is a standard in building automation to govern lighting control gear. The new version of the DALI standard, DALI-2, defines control devices (e.g. push buttons, light and motion sensors) uniformly in the standard. DALI-2, therefore, makes it possible, inter alia, to share control functions across manufacturers. Up to 64 luminaire control units and 64 control units can be operated together on one DALI line in a DALI-2 system.

DE Das Steuerungsprotokoll DALI-2 (Digital Addressable Lighting Interface) ist in der Gebäudeautomatisierung ein Standard zur Steuerung von lichttechnischen Betriebsgeräten. Mit der Neufassung der DALI-Norm – DALI-2 – werden Geräte des Typs Steuerungen (bspw. Taster, Licht- und Bewegungssensoren) in der Norm einheitlich definiert. DALI-2 macht es daher unter anderem möglich, auch Steuerungsfunktionen herstellerübergreifend zu kommunizieren. Somit können in einem DALI-2 System 64 Leuchtenbetriebsgeräte und 64 Steuergeräte gemeinsam auf einer DALI-Linie betrieben werden.



Wireless Zigbee lighting control

EN The Zigbee wireless protocol has become an essential standard in the smart home sector, especially in lighting control. Since Zigbee's latest version 3.0, the previously individual profiles have been combined into a multifunctional and uniform protocol. The new protocol enables flexible and straightforward networking of different device types from different manufacturers. This network capability allows luminaires, sensors, and buttons, for example, to be controlled and set intuitively via the mobile app. XAL luminaires equipped with a Zigbee 3.0 module certified by the Zigbee Alliance meet the highest safety standards and compatibility criteria:

- leading wireless standard in smart lighting
- no additional wiring required
- sophisticated security mechanisms
- easy control and set-up via the app
- long range thanks to the mesh network
- low energy consumption

DE Das Funkprotokoll Zigbee hat sich im Smart-Home-Bereich und insbesondere in der Lichtsteuerung zu einem wichtigen Standard entwickelt. Seit der neuesten Zigbee-Version 3.0 wurden die bisher einzelnen Profile zu einem multifunktionalen und uniformen Protokoll zusammengefasst. Dies ermöglicht ein flexibles und unkompliziertes Vernetzen verschiedener Gerätetypen unterschiedlicher Hersteller. Damit lassen sich z.B. Leuchten, Sensoren und Taster intuitiv per Mobile App ansteuern und einstellen. XAL-Leuchten, die mit einem durch die Zigbee-Alliance zertifizierten Zigbee-3.0-Modul ausgestattet sind, erfüllen die höchsten Sicherheitsstandards und Kompatibilitätskriterien:

- führender Funkstandard im Smart Lighting
- keine zusätzliche Verkabelung nötig
- ausgereifte Sicherheitsmechanismen
- einfache Steuerung und Einrichtung per App
- hohe Reichweiten dank Mesh-Netzwerk
- niedriger Energieverbrauch

Technical information

Glossary

EN Luminous Flux

Luminous flux, with the unit of one lumen, denotes the total light emission of a luminaire. The information on the luminous flux in this catalogue is subject to a tolerance of $\pm 10\%$.

EN System Power

System power is the total power consumption of a luminaire in watts including any necessary ballasts. The values in this catalogue are rated values which may be exceeded by a maximum of 10 % in individual cases. For selected luminaires we indicate the inset power instead of the system power; if so, a separate remark can be found on the product's page.

EN Colour Temperature

Colour temperature, with the unit of one Kelvin (K), describes the appearance given by a light source. As an approximation, it is specified as the correlated colour temperature, or CCT; it is also dependent on minimum variation under operation. The colour point lies at least within 3 SDCM.

EN Electromagnetic Compatibility (EMC)

Electromagnetic compatibility (EMC) is the property of an electrical device to function in its environment without affecting other devices. XAL not only tests single luminaires, but also representative lighting configurations in the system network. The test set-up complies with the high requirements of the relevant directives and standards.

Abbreviations

EN lm (lumen)

The lumen is the unit of luminous flux. Luminous flux describes the light energy in the visible band radiated from a light source in all directions.

EN lx (lux)

The lux is the unit of illuminance. The illuminance describes the total luminous flux incident on a given surface. Lux is equal to Lumen per m² (lx=lm/m²).

EN cd (candela)

Candela is the unit of luminous intensity. The luminous intensity describes the luminous flux per illuminated solid angle (cd = lm/sr).

EN UGR (Unified Glare Rating)

UGR is a procedure for the evaluation of discomfort glare from artificial lighting in indoor spaces. Depending on the difficulty of visual tasks, the corresponding limits should not be exceeded. The UGR limit values are defined in the standard EN 12464 for activities and visual tasks. UGR = 19 is permitted as the maximum value for office spaces.

EN cd/m²

Luminance is the intensity of light reaching the eye from the surface being viewed.

EN LGP (Light Guiding Prism)

Light-guiding structures in illuminated, transparent material that ensure the desired distribution of light when light is introduced from the side.

Erläuterungen

DE Lichtstrom

Der Lichtstrom mit der Einheit Lumen bezeichnet die gesamte Lichtemission einer Leuchte. Die Angaben zum Lichtstrom in diesem Katalog unterliegen einer Toleranz von $\pm 10\%$.

DE Systemleistung

Unter der Systemleistung versteht man die gesamte Leistungsaufnahme einer Leuchte in Watt inklusive der notwendigen Vorschaltgeräte. Die Angaben in diesem Katalog sind Bemessungswerte, die im Einzelfall um maximal 10 % überschritten werden dürfen. Bei ausgewählten Leuchten geben wir statt der Systemleistung die Inset-Leistung an; wenn ja, finden Sie einen gesonderten Hinweis auf der Produktseite.

DE Farbtemperatur

Die Farbtemperatur mit der Einheit Kelvin (K) beschreibt die Erscheinung einer Lichtquelle. Die Farbtemperatur wird als CCT, also näherungsweise, angegeben; sie ist außerdem abhängig von konstanten Betriebsbedingungen. Der Farbort liegt mindestens innerhalb von 3 SDCM.

DE Elektromagnetische Verträglichkeit (EMV)

Unter elektromagnetischer Verträglichkeit (EMV) versteht man die Eigenschaft einer elektrischen Einrichtung, in ihrer Umgebung zu funktionieren, ohne andere Einrichtungen zu beeinflussen. XAL testet nicht nur Einzelleuchten, sondern auch repräsentative Leuchtenkonfigurationen im Systemverbund. Der Testaufbau entspricht den hohen Anforderungen der einschlägigen Richtlinien und Normen.

Abkürzungen

DE lm (Lumen)

Lumen ist die Einheit des Lichtstroms. Der Lichtstrom beschreibt die von einer Lichtquelle in alle Richtungen abgestrahlte Leistung im sichtbaren Bereich.

DE lx (Lux)

Lux ist die Einheit der Beleuchtungsstärke. Die Beleuchtungsstärke beschreibt den Lichtstrom, der auf eine bestimmte Fläche trifft. Lux ist Lumen pro m² (lx=lm/m²).

DE cd (candela)

Candela ist die Einheit der Lichtstärke. Die Lichtstärke beschreibt den Lichtstrom innerhalb eines Steradianens (cd = lm/sr).

DE UGR (Unified Glare Rating)

UGR ist ein Verfahren zur Bewertung der psychologischen Direktblendung der künstlichen Beleuchtung in Innenräumen. Je nach Schwierigkeit von Sehaufgaben sollen die entsprechenden Grenzwerte nicht überschritten werden. Die UGR-Grenzwerte sind in der Norm EN 12464 für Tätigkeiten und Sehaufgaben festgelegt. Für Büroräume ist UGR = 19 als oberster Wert zugelassen.

DE cd/m²

Die Leuchtdichte ist die Lichtstärke, die von der gesehenen Fläche ins Auge trifft.

DE LGP (Light Guiding Prism)

Lichtlenkende Strukturen in lichtführendem, transparentem Material, die bei seitlicher Lichteinkopplung für die gewünschte Lichtverteilung sorgen.

 back

Symbols



EN Specifies the rotation and pivoting capability of the spotlight.



EN A colour rendering index greater than 90 indicates very good colour reproduction, which is applied in museums and high-quality retail areas.



EN High-quality LED sorting with minimal colour location deviation. The centre of binning is located in the centre of the ANSI C78.377-2015 binning system. With 2-SDCM scale the chromaticity coordinates are within a range of < 70 K.



EN Glare-free workplace luminaire according to DIN EN 12464-1.



EN Workplace luminaire suitable for VDUs. The luminance is above the downward-radiating light cone with an aperture angle of ± 65°, ≤ 1500 cd/m² (necessary for black screen for CAD activities) or ≤ 3000 cd/m² for white screen for office activities.



EN According to the international standard IEC 62471 the luminaire presents no photobiological hazard. No damage is caused to the eyes even when continuously looking directly in the direction of the light source (unrestricted duration of exposure).



EN Indicates the number of DALI addresses of a luminaire.



EN Protection classes provide information on how well a luminaire is protected against the risks of a current surge due to contact.



PC I: Protective earthing

PC II: Reinforced or double protective insulation

PC III: Safety extra-low voltage



EN The CE marking indicates a declaration of the manufacturer that the luminaire complies with all applicable European requirements.



EN This includes an external review of the product and all applicable European requirements. A CB (Certification Body) test certificate facilitates the acquisition of other national certification marks.



EN Luminaires that are allowed to carry the ENEC certificate are tested according to the strict ENEC standards. Compliance is guaranteed by annual product and factory inspections.



EN Degree of protection for recessed luminaires. The upper specification refers to the built-in housing part; the lower one refers to the visible part of the lamp.

Symbole

DE Gibt die Dreh- und Schwenkbarkeit der Strahler an.

DE Der Farbwiedergabeindex größer 90 steht für eine sehr gute Farbwiedergabe, die in Museen und im hochwertigen Retail-Bereich Anwendung findet.

DE Hochwertige LED Sortierung mit minimaler Farbortabweichung. Der Mittelpunkt des Binning liegt im Zentrum des ANSI C78.377-2015 Bin-systems. Bei 2 SDCM Scale liegen die Farborte innerhalb einer Range von < 70 K.

DE Entblendete Arbeitsplatzleuchte gemäß DIN EN 12464-1.

DE Bildschirmtaugliche Arbeitsplatzleuchte. Die Leuchtdichte ist oberhalb des nach unten strahlenden Lichtkegels mit Öffnungswinkel ± 65°, ≤ 1500 cd/m² (notwendig für schwarzen Bildschirm bei CAD Tätigkeiten) oder ≤ 3000 cd/m² für weißen Bildschirm bei Office Tätigkeiten.

DE Gemäß der internationalen Norm IEC 62471 stellt die Leuchte keine fotobiologische Gefahr dar. Es kommt zu keiner Schädigung des Auges, auch bei dauerhaftem Blick in Richtung Lichtquelle (unbegrenzte Expositions-dauer).

DE Gibt die Anzahl der DALI-Adressen einer Leuchte an.

DE Schutzklassen geben Auskunft darüber, inwieweit eine Leuchte gegen die Risiken eines Stromschlags durch Berührung geschützt ist.

SK I: Schutzerdung

SK II: verstärkte oder zweifache Schutzisolation

SK III: Schutzkleinspannung

DE Mit der CE-Kennzeichnung erklärt der Hersteller, dass die Leuchte allen geltenden europäischen Anforderungen entspricht.

DE Eine externe Überprüfung des Produkts und aller geltenden europäischen Anforderungen. Ein CB-Zertifikat erleichtert den Erwerb anderer nationaler Prüfzeichen.

DE Leuchten, die das ENEC-Zertifikat führen dürfen, sind nach den strengen ENEC-Richtlinien geprüft. Die Einhaltung wird durch jährliche Produkt- und Werksinspektionen gewährleistet.

DE Schutzart für Einbauleuchten. Die obere Angabe bezieht sich auf den eingebauten Gehäuseteil, die untere auf den sichtbaren Teil der Leuchte.



EN Degree of protection (IP codes) according to DIN EN 60529. IP (Ingress Protection) indicates a level of protection against intrusion. The first digit of the IP code refers to the protection against the penetration of solid particles and dust. The second digit of the IP code refers to the protection against ingress of water and moisture.



Protection against foreign objects with a diameter ≥ 12 mm



Protection against foreign objects with a diameter ≥ 2.5 mm



Protection against foreign objects with a diameter ≥ 1 mm



Full contact protection, against dust deposits internally



Full contact protection, protection against ingress of dust



No water protection



Protected against vertical falling water droplets



Protected against diagonal falling water droplets



Protected against water spray



Protected against water splashing



Protected against water jets (from all directions)



Protected against ingress of water with transient flooding



Protected against ingress of water with submersion



EN IK type protection is a measure of the resistance of electrical equipment housings to mechanical stress (impact loads) and is determined by the standard test method according to IEC 62262.
IK07: up to 2 joules impact strength
IK09: up to 10 joules impact strength
IK10: up to 20 joules impact strength



EN Light source replaceable by an authorized professional.



EN Light source replaceable by end-user.



EN Light source not replaceable.



EN Control gear replaceable by an authorized professional.



EN Control gear replaceable by end-user.



EN Control gear not replaceable.

DE Schutzarten (IP-Codes) nach DIN EN 60529. IP (Ingress Protection) steht für Schutz gegen Eindringen. Die erste Kennziffer des IP-Codes bezieht sich auf den Schutz gegen das Eindringen von festen Fremdkörpern und Staub. Die zweite Kennziffer bezieht sich auf den Schutz gegen Wasser und Feuchtigkeit.

Kennziffer 1 für Berührungsschutz

Schutz gegen Fremdkörper mit Durchmesser ≥ 12 mm

Schutz gegen Fremdkörper mit Durchmesser ≥ 2,5 mm

Schutz gegen Fremdkörper mit Durchmesser ≥ 1 mm

Vollständiger Berührungsschutz, Schutz gegen Staubablagerungen im Inneren

Vollständiger Berührungsschutz, Schutz gegen Eindringen von Staub

Kennziffer 2 für Wasserschutz

Kein Wasserschutz

Geschützt gegen senkrecht fallende Wassertropfen

Geschützt gegen schräg fallende Wassertropfen

Geschützt gegen Sprühwasser

Geschützt gegen Spritzwasser

Geschützt gegen Strahlwasser (aus allen Richtungen)

Geschützt vor eindringendem Wasser bei vorübergehender Überflutung

Geschützt vor eindringendem Wasser beim Eintauchen

DE Die IK-Schutzart ist ein Maß für die Widerstandsfähigkeit von Gehäusen elektrischer Betriebsmittel gegen mechanische Beanspruchung (Stoßbeanspruchung) und wird durch die genormte Prüfmethode nach IEC 62262 nachgewiesen.
IK07: bis zu 2 Joule Stoßfestigkeit
IK09: bis zu 10 Joule Stoßfestigkeit
IK10: bis zu 20 Joule Stoßfestigkeit

DE Lichtquelle durch autorisierte Fachleute austauschbar.

DE Lichtquelle durch Endverbraucher austauschbar.

DE Nicht austauschbare Lichtquelle.

DE Betriebsgerät durch autorisierte Fachleute austauschbar.

DE Betriebsgerät durch Endverbraucher austauschbar.

DE Nicht austauschbares Betriebsgerät.

← back

Classic colours

RAL 9003 signal white B01F	RAL 9016 traffic white C01F	RAL 9002 grey white C02F	RAL 1035* bronze/ pearl beige C04F	RAL 260-M* gold dust C05F	RAL 080 60 30* brass gold C06F
RAL 9010 pure white A01F	RAL 085 80 10 velvet beige B02F	RAL 7044 silk grey A04F	RAL 7048 pearl mouse grey C07F	RAL 8014 sepia brown A08F	RAL 330-M* copper C17F
RAL 9006 white aluminium A06F	RAL 9007 grey aluminium A07F	RAL 9023 dark pearl grey C03F	RAL 7022 umbra grey A02F	RAL 9004 signal black B04F	RAL 9005 jet black A05F

Trend colours

RAL 5014 pigeon blue C08F	RAL 230 60 10 kingfisher grey B05F	RAL 7000 squirrel grey C09F	RAL 2002 vermillion C15F	RAL 3016 coral red C16F	RAL 050 40 40 madeira brown B03F
RAL 6019 pastel green C10F	RAL 6027 light green C11F	RAL 5018 turquoise blue C12F	RAL 3015 light pink C18F	RAL 3014 antique pink C19F	RAL 2000 yellow orange C20F
RAL 100 50 20 green woodpecker olive B06F	RAL 6018 yellow green C13F	RAL 5005 signal blue C14F	RAL 1016 sulphur yellow C21F	RAL 1018 zinc yellow C22F	RAL 1032 broom yellow C23F

Acoustic colours

royal yellow F02N	spring green F03N	bottle green F04N	bright blue F05N	indigo blue F06N	anthracite F09N		
lime stone F14N	autumn red F11N	oxide red F12N	aubergine F13N	white	marble grey	felt grey	black

PRODUCT COLOURS

	standard	available
ARY cable / rod suspended	7 8	
ARY shades	C T L G W B	
BASO 60 IP54 recessed, surface	7 D	
BETO circle suspended	7 8	
BETO suspended	7 8	
BETO free standing	7 8	
BETO ceiling / suspended system	7 8	
BO semi-recessed / surface / intrack	7 8	
BO track	7 8	
CANYON 60 recessed	7 8	
CAVO round / square / linear	7 8	
CAVO JUST spotlight insets	7 8 9	
COMBO trim	7	
CORNER surface	7 G 8	
DESO suspended	7	
FLOW surface	7 G 8	
FRAME 60 / 100 trim	7 G	
HEX-O ceiling / suspended	7 8	
HEX-O acoustic elements	W D G L	
INO circle / square suspended	7 G 8	
JANE semi-rec. / surface / suspended	7 8	
LENO semi-recessed / surface / susp.	7 8	
LENO recessed	7	
LINEA wall	7 8	
LITO 60 suspended	7 G 8	
MINIMAL 60 / 100 trimless	7	
MINO 40 / 60 / 100 surface / susp.	7 G 8	
MINO 40 / 60 / 100 system	7 G 8	
MINO CIRCLE ceiling / suspended	7 G 8	
MINO CIRCLE acoustic elements	W D L	
MITA circle ceiling	7 8	
MITA circle / square recessed	7 8	
MOVE IT 25 / 25 S / 45 trimless	8	
MOVE IT 25 / 25 S / 45 surf. / susp.	8 9 10	
MOVE IT 25 / 25 S / 45 susp. indirect	8 9 10	
MOVE IT FLEXTRACK extension	8 9 10	
MOVE IT JUST spotlight inset	7 8	
MOVE IT PAL suspended dec. inset	7 8	
MOVE IT PIVOT graphic light inset	8	
MOVE IT LINEAR insets	8	
MOVE IT system - acoustic elements	W L	
MOVE IT wästberg w203 dec. inset	7 8	
MOVE IN housing	7 G 8	
MOVE IN inset	7 8	
MUSE double light / light / baffle	B G P E	
PABLO track	7 8	

Classic colours & Trend colours

Acoustic colours

PRODUCT COLOURS

	standard	available
RECOVER wall	7	
SASSO base / wall - housing	7 1	
SASSO base / wall - inset	7 4 1 9	
SASSO 40 recessed - mounting set	7 8	
SASSO 60 / 100 rec. - mounting set	7 G 8	
SASSO recessed - inset	7 4 1 9	
SASSO semi-rec. / ceiling - housing	7 1	
SASSO semi-rec. / ceiling - inset	7 4 1 9	
SASSO suspended - housing	7 1	
SASSO suspended - inset	7 4 1 9	
SASSO PRO mounting set	7 8	
SASSO PRO inset	7 8	
SETA ceiling / suspended system	7 8	
SETA suspended	7 8	
SONIC absorber	W D L	
SONIC free standing / suspended	7 6	
SONIC soundcap	W D G L	
SONO recessed / surface	7	
SONO LOOP surface	7 D	
SPADO round / square	7 8	
SPIO recessed	7	
SQUADRO wallwasher recessed	7 8	
SQUADRO wallwasher track	7 8	
STRETTA surface	7 8	
STRETTA end caps	7 8 9	
TASK acoustic elements	W D G L	
TASK circle / angular suspended	7 8	
TASK round / square / surface / susp.	7 8	
TASK S suspended	7 8	
TASK S suspended system	7 8	
TASK free standing	7 6 8	
TASK table / wall	7 8	
TRACK recessed	7 8	
TRACK surface / suspended	7 6 8	
TRACK high surface / suspended	7 8	
TRACK round surface / suspended	7 8	
TUBO 60 / 100 surface / suspended	7	
TULA suspended	4 7 8	
TWIST mounting set	7 8	
TWIST inset	7 8	
UNICO recessed	W B	
UNICO ceiling	W G B 9	
UNICO wall recessed	W B	
UNICO wall surface	W G B	
VARO track	7 8	
VELA surface / suspended	7 G 8	

Photographer overview

Kris Dekeijser (Cover | p. 19-23 | 66-67 | 68-69 | 73 | 148-149 | 154-155 | 242-243 | 246-247 | 286-287 | 292-293 | 298-299 | 390-391 | 468-469 | 608-609 | 622-623 | 680-681 | 709 | 714-715 | 716-717 | 745 | 762-763 | 770-771 | 782 | 794-795 | 848-849), Lilly Mörz (p. 10 | 12 | 14 | 16 | 403 | 811 | 966-967), Paul Ott (p. 13 | 166-167 | 338-339 | 358 | 378-379 | 502-503 | 524-525 | 620-621 | 688-689 | 896-897 | 906-907), Mathias Kniepeiss (p. 13 | 422-423), Michael Königshofer (p. 14 | 657), Hufton+Crow (p. 25), Andy Perkins (p. 26-29), serge brison (p. 31-35), Nate Cook Photography (p. 37-39 | 798-799), Paul Karalius (p. 56-57 | 830-831), rené riller fotografie (p. 58-59 | 162-163 | 366 | 388-389 | 726-727 | 804-805), Philipp Schuster (p. 60-61 | 98), Kurt Kuball (p. 76-77 | 322-323 | 359 | 367 | 444–445 | 474-475 | 478-479 | 480-481 | 514-515 | 592-593 | 630-631 | 640-641 | 657 | 668-669 | 796-797 | 800-801 | 846-847), Corinna Klug (p. 102-103 | 138-139), KA2 Light Architecture (p. 106-107 | 818-819 | 832-833), Martin Steinthaler (p. 118-119), Billy Bolton (p. 40-41 | 126-127 | 128-129 | 760-761), Thilo Ross (p. 130-131 | 550-551 | 571 | 574-575), Zooey Braun (p. 132-133 | 144-145 | 204-205 | 732-733 | 766-767 | Markus Tollhopf (p. 146-147), Bruno Helbling (p. 158-159), Oberpollinger | The KaDeWe Group (p. 176-177 | 178-179 | 225 | 240-241), Gerald Liebming (p. 182), raumpixel.at (p. 188-189 | 340-341 | 636-637), Daniel Pfeffer (p. 192-193), Jens Pfisterer (p. 198-199 | 260-261), Adrian Bischoff Fotografie (p. 206-207), Obrist interior AG (p. 214-215), Z. Gataric Fotografie (p. 218 | 220-221 | 350-351 | 540-541 | 604-605 | 776-777 | 924-925 | 942-943), Dan Preston Studio (p. 219), Reinhard Zimmermann (p. 228-229), Schreyer David (p. 230-231), Andreas Lühmann (p. 232-233), elena egger (p. 236-237), Huy Nguyen (p. 252-253), Joachim Grothus (p. 254-255 | 310-311 | 412-413 | 614-615 | 690-691 | 920-921), Purnesh Dev Nikhanj (p. 256-257), Porsche Vietnam (p. 262-263), Linus Lintner (p. 272-273 | 276-277), Johannes Roloff (p. 284-285), atelier.j.ka (p. 294-295), Dominik München (p. 309 | 398-399 | 426-427 | 626-627), Tim Ertl (p. 318-319 | 324-325 | 466-467 | 482-483), Külling Optik (p. 346-347), Gruschwitz GmbH (p. 352-353), Martin Baitinger (p. 354-355), Romana Fürnkranz (p. 362-363), Roman Weyeneth (p. 368-369), Barbara Ziegelböck (p. 372-373), Gregor Graf (p. 386-387), Mato Johannik (p. 392-393), Markus Käch (p. 406-407), Stephan Baumann (p. 408-409), Sourbron fotografie (p. 414-415), Marcel Kohnen (p. 418-419), Fotomohito (p. 430-431 | 722-723 | 816-817), Meran und Hauser (p. 434-435 | 894-895), Stefan Zauner (p. 442-443 | 530-531), Werner Huthmacher (p. 448-449 | 542-543), Yvonne Schmedemann Fotografie (p. 450-451), pierer.net (p. 454-455 | 562-563 | 926-927), Werner Krug Fotografie (p. 463 | 836), Miquel Llonch (p. 472-473 | 586-587 | 789 | 844-845), Katherine Lu (p. 494-495 | 864-865), Kim Forssén (p. 498-499), Studio De Nooyer (p. 506-507), Martin Lugger (p. 538-539), Egon Gade Photography (p. 546-547 | 578 | 718-719), Konstantinos Karampatakis (p. 560-561), Angelo Kaunat (p. 566-567), David Barbour (p. 571 | 956-957), Lennart Søgård-Høyer (p. 579), Walter Luttenberger (p. 588-589), Dian Stanchev (p. 600-601 | 756-757), Maria Miklaszewska (p. 602-603), Justin Hession (p. 628-629), Marek & Beier Fotografen (p. 641), Thomas A. Berger, www.diebergerdesigner.de (p. 644-645), PION Studio (p. 650-651), Tönu Tunnel (p. 652-653), Schneider & Schütz GmbH (p. 660-661), peal GmbH (p. 662-663), Andrew Alberts (p. 666-667), Nick Rezendes (p. 697), tschinkersten Fotografie (p. 712-713), Gavriil Papadiotis (p. 724-725), Paloma Pacheco Turnes (p. 728-729), Irina Boersma (p. 738-739), Studio DZ GmbH, Dario Zimmerli (p. 740-741), Catherine Roider (p. 746-747 | 774-775), Andrii Shurpenkov (p. 758-759), Ditz Fejer (p. 781), Richard Kiely (p. 811 | 824-825 | 932-933), teamgnesda (p. 815 | 828-829), ROOM Communicatioon GmbH (p. 822-823), walter schießwohl (p. 861 | 872-873), Kurt Härting Kufstein (p. 868-869), Donal Murphy (p. 884-885), Luis Hevia (p. 886-887), Baptiste Lobjoy (p. 900-901), Studio Filipa Peixeiro (p. 911), Fkontract (p. 911), Frank Pinckers (p. 922-923), Aleš Jungmann (p. 930-931), Sergio (p. 938-939 | 964-965)

Imprint

Graphic Design

Albert Exergian

Lukas Hochenwarter

Laura Gautsch

Jürgen Kurzmann

Nicole Praus

Print Production

Rene Zavadilik

Lithography

Volker Waldhauser

Organisation

Rene Zavadilik

Melina Fuchs

Helena Bäuchler

Cover

Kris Dekeijser

Printing

Druck Styria GmbH & Co KG

© 2022-05

Legal notes

^{EN} The details provided in this catalogue were correct at the time of publication. They do not constitute any kind of obligation on our part and are for information only. We shall not be held liable for any discrepancies between the illustrations or descriptions given and the actual product. The power input of the LEDs is calculated with driver electronic and control gear. We reserve the right to make alterations to our products at any time. All orders will be carried out in accordance with the relevant versions of our General Terms and Conditions. These can be viewed at www.xal.com.

^{DE} Die Angaben in diesem Katalog entsprechen dem Stand bei Drucklegung, sind unverbindlich und sollen ausschließlich Informationszwecken dienen. Für Abweichungen eines Produkts von Abbildungen oder Angaben wird keine Haftung übernommen. Die Leistungsaufnahme der LEDs wird mit Treiberelektronik und Betriebsgerät berechnet. Wir behalten uns vor, jederzeit Änderungen an unseren Produkten vorzunehmen. Alle Aufträge werden ausschließlich zu unseren Allgemeinen Geschäfts- und Lieferbedingungen, die unter www.xal.com eingesehen werden können, in der gültigen Fassung entgegengenommen.

[← back](#)

Contacts

XAL headquarters

XAL GmbH
Auer-Welsbach-Gasse 36
8055 Graz
AUSTRIA
T +43.316.3170
office@xal.com

International Sales
T +43.316.3170
office.export@xal.com

XAL branches

XAL GmbH
St. Veiter Straße 146
9020 Klagenfurt
AUSTRIA
T +43.316.3170.8000
office.kaernten@xal.com

XAL Sarl
10, Rue Pecquay
75004 Paris
FRANCE
T +33.1.40.29.98.82
office.fr@xal.com

XAL Srl
Via Enrico Fermi 20
39100 Bolzano
ITALY
T +39.3476.401293
office.it@xal.com

XAL Schweiz GmbH
Zentweg 9
3006 Bern
SWITZERLAND
T +41.31.938.80.90
office.bern@xal.com

XAL GmbH
Dr. Herbert-Sperl-Ring 2,
Top 4, 2. OG
4060 Leonding
AUSTRIA
T +43.316.3170.8572
office.oberoesterreich@xal.com

XAL GmbH
GSG Hof, Helmholtzstraße 2-9
10587 Berlin
GERMANY
T +49.303.974.329.0
office.berlin@xal.com

XAL B.V.
Cruquiusweg 111L
1019 AG Amsterdam
NETHERLANDS
T +31.20.229.6001
office.nl@xal.com

XAL Schweiz GmbH
Avenue de l'Avant-Poste 7
1005 Lausanne
SWITZERLAND
T +41.21.310.11.90
office.lausanne@xal.com

XAL GmbH
Römerstraße 16
6065 Thaur
AUSTRIA
T +43.316.3170.8562
office.oewest@xal.com

XAL GmbH
Schanzenstraße 36 Geb. 234a
51063 Cologne
GERMANY
T +49.2211.2071.740
office.koeln@xal.com

XAL AS
Drammensveien 288
0283 Oslo
NORWAY
T +47.24.07.61.11
office.no@xal.com

XAL Schweiz GmbH
Unterlachenstrasse 19
6005 Lucerne
SWITZERLAND
T +41.41.269.80.90
office.luzern@xal.com

XAL GmbH
Marxergasse 1B
1030 Vienna
AUSTRIA
T +43.1.5264784
office.vienna@xal.com

XAL GmbH
Europa-Allee 33-35
60327 Frankfurt am Main
GERMANY
T +49.69.2102959.0
office.frankfurt@xal.com

XAL Sp. z.o.o.
Ul. Posag 7 Panien 1a
02-495 Warsaw
POLAND
T +48.73.033.03.58
office.pl@xal.com

XAL Schweiz GmbH
Hohlstrasse 517
8048 Zurich
SWITZERLAND
T +41.44.245.80.90
office.ch@xal.com

XAL Belgium
Spinnerijstraat 99/21,
8500 Kortrijk
BELGIUM
T +32.56.49.28.00
office@xal.com

XAL GmbH
Ruhrstraße 11a/ Im Phoenixhof
22761 Hamburg
GERMANY
T +49.408.5179.2830
office.hamburg@xal.com

XAL Eastern Europe k.s.
Varsavská 5
83103 Bratislava
SLOVAKIA
T +421.2.326.602.80
office.sk@xal.com

XAL Middle East DMCC
HDS Business Center
Office No. 704, Cluster M
Jumeirah Lakes Towers, Dubai
PO Box 336603
UNITED ARAB EMIRATES
T +971.4.436.2347
office.dubai@xal.com

XAL Hong Kong
RM. 1413, Block A,
Sea View Estate,
2 Watson Road,
North Point Hong Kong
CHINA
T +852.2590.9468
office@xal.com

XAL GmbH
Wilhelm-Wagenfeld-Straße 16
80807 Munich
GERMANY
T +49.89.323.7380
office.de@xal.com

XAL Creative Lab
Plaça Duc de Medinaceli 5
08002 Barcelona
SPAIN
T +34.935.95.17.80
office.es@xal.com

XAL Ltd.
23 Batemans Row
London EC2A 3HH
UNITED KINGDOM
T +44.20.3174.0177
office.uk@xal.com

XAL Finland Oy
Sörnäistenkatu 1
00580 Helsinki
FINLAND
T +358.40.0700975
office.fi@xal.com

XAL GmbH
Hohnerstraße 23
70469 Stuttgart
GERMANY
T +49.711.8060.7590
office.stuttgart@xal.com

XAL Sales Office
Madrid
SPAIN
office.es@xal.com

XAL Inc.
133 West, 19th Street, 9th Floor
New York, NY 10011
USA
T +1.212.343.8100
office.us@xal.com
xalusa.com

XAL Sarl
36 Rue Juliette Récamier
Place Deroudille
69006 Lyon
FRANCE
T +33.4.72.81.11.99
office.fr@xal.com

XAL India Pvt. Ltd.
Plot No.13, F-II Block
MIDC, Pimpri
Pune 411040
INDIA
T +91.20.3006.5566
office.in@xal.com

XAL SE
Hårdvällsgatan 18
11546 Stockholm
SWEDEN
M +46.7.084.484.84
office.se@xal.com

XAL USA factory
150 Hawley Road
Oxford, CT 06478
USA
T +1.203.262.9990

XAL Schweiz GmbH
Max Kämpf-Platz 2
4058 Basel
SWITZERLAND
T +41.61.206.80.90
office.basel@xal.com

