

XAL 23

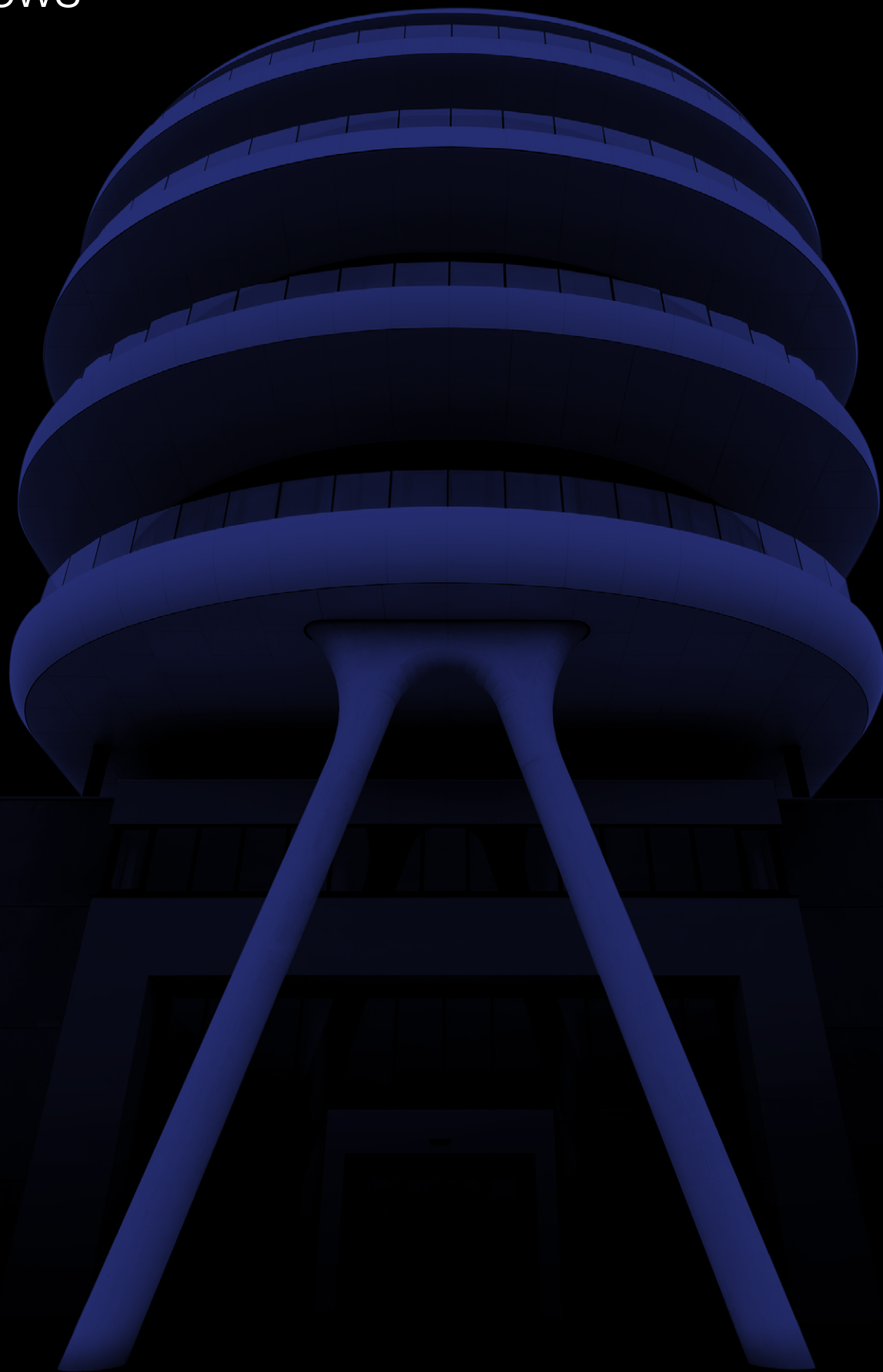

EN DE

News

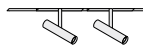

# Contents

## MOVE IT 10 installation track

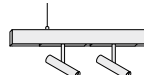
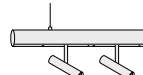
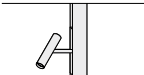
				
recessed trimless <b>12</b>	surface square <b>12</b>	suspended square <b>14</b>	suspended round <b>14</b>	pole square/round <b>16</b>

4

## linear insets

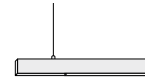
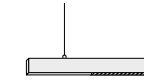
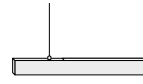
			
SPOT LINE direct <b>20</b>	OPAL direct <b>20</b>	DARKLIGHT direct <b>20</b>	indirect <b>20</b>

## decorative insets

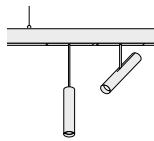
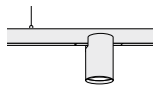
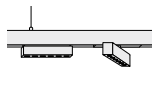
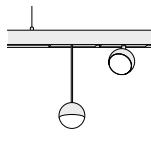
			
TILA <b>24</b>	TARO <b>32</b>	GIRA <b>36</b>	NOBA <b>40</b>

## TUBO 60 surface

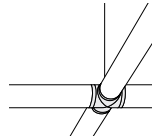
		suspended		
system <b>48</b>	CONEX system <b>48</b>		system <b>48</b>	CONEX system <b>48</b>

44

## SETA ceiling

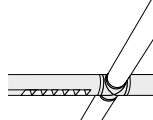
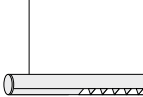
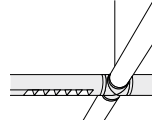
		suspended		
system <b>48</b>	CONEX system <b>48</b>		system <b>48</b>	CONEX system <b>48</b>



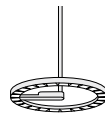

44

## MITA ceiling

	suspended	
circle <b>58</b>		suspended <b>64</b>

54

## SPIO recessed

			
20 downlight <b>72</b>	20 wallwasher <b>72</b>	60 downlight <b>76</b>	60 adjustable <b>76</b>

68

## SQUADRO recessed

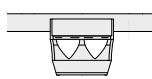
	track	
wallwasher <b>84</b>		wallwasher <b>88</b>

80

**BO**  
intrack

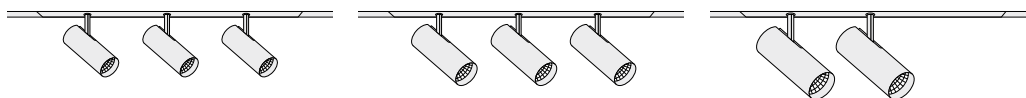

32  
2/3 lamps  
**96**

45  
2/3 lamps  
**96**

55  
1/2 lamps  
**96**

**92**

**VARO**  
track

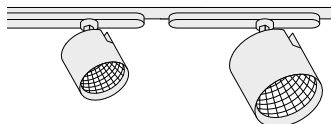

80 S  
**104**

110 S  
**108**

**102**

**MILA**  
ceiling



system  
**116**

**112**

**FRAME 40**  
recessed  
trim

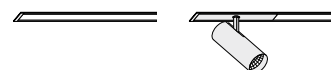

system  
**124**

system  
**130**

**120**

**MINO 40**  
ceiling

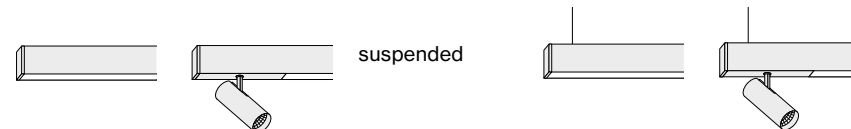

system  
**128**

system  
**130**

40 system  
**128**

40 system  
**130**

**120**

# Elegance on track

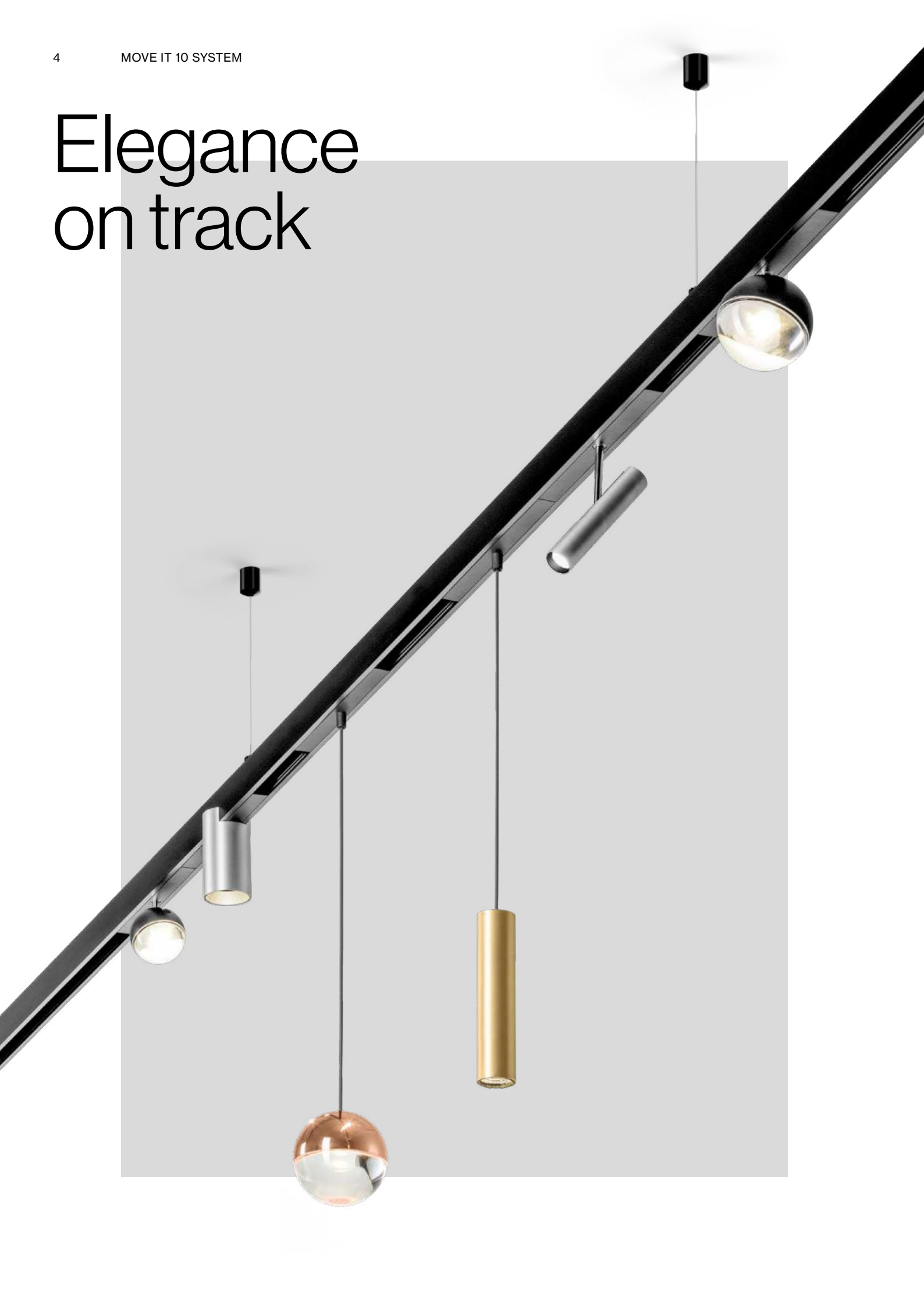



# MOVE IT 10 system

**EN** MOVE IT 10 is a particularly slim track system. The dimmable low-voltage track, available as a recessed, surface-mounted, suspended or pole version, is impressive thanks to its unusually slender cross-section. Both the round and square forms have a clear width of only 10 mm. MOVE IT 10's design is minimalistic. The insets' adapter are fully hidden in the track. The tracks are available in black, white and chrome (standard for the round version). They are connected by Corner or Curve elements for an edgy or softly rounded appearance. Extend MOVE IT 10 with various linear or design-oriented insets for maximum planning freedom for your interior concept.

**DE** Eine besonders schlanke Stromschiene – das ist MOVE IT 10. Die dimmbare Niedervolt-Stromschiene, als Einbau-, Anbau-, abgehängte oder Pole Variante verfügbar, besticht durch ihren ungewöhnlich schlanken Querschnitt: Sowohl in runder als auch in eckiger Form misst ihre lichte Breite lediglich 10 mm. Das minimalistische Design setzt sich auch in den Adaptern fort, die vollständig in den Schienen verschwinden. Die Schienen sind in den Farben Schwarz, Weiß und Chrom (bei der runden Variante) erhältlich. Verbunden werden sie durch Corner-, oder Curve-Elemente zu wahlweise klaren Ecken oder weichen Rundungen. MOVE IT 10 kann mit verschiedenen linearen oder designorientierten Einsätzen erweitert werden – für größte Freiheit bei der Planung Ihres Interior Konzepts.

## Types



square      round

## Mountings

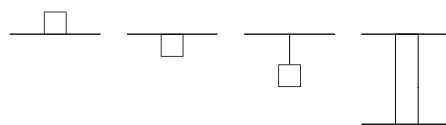

recessed      surface      suspended      pole

## Configurations



linear      curve      L-connector      T-connector      X-connector      level connector      ceiling to wall connector

## Light distributions

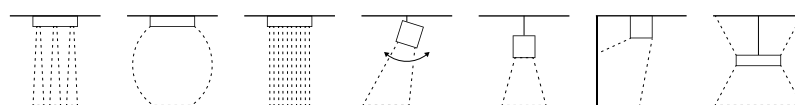

spot line      opal      darklight      spotlight      decorative      wallwasher floor      direct indirect

## Mounting options

**EN** Depending on the desired appearance and installation, the 48V track system is available as a trimless recessed-mounted, surface-mounted, suspended or pole version.

**DE** Je nach gewünschter Erscheinung und Montage ist das 48V-Stromschienensystem als randlose Einbau-, Anbau-, abgehängte oder als Pole Variante verfügbar.



## Create individual arrangements

**EN** Let your creativity run wild and arrange MOVE IT 10 at will. Special Curve and Corner elements enable the straight tracks to be connected to form harmonious curves or precise corners. Since all elements fit together, you can configure your ideal bespoke system.

**DE** Lassen Sie Ihrer Kreativität freien Lauf und arrangieren Sie MOVE IT 10 nach Ihren Vorstellungen. Durch spezielle Curve- und Corner-Elemente lassen sich die geradlinigen Schienen zu harmonischen Kurven oder präzisen Ecken verbinden. Da alle Elemente zueinander passen, können Sie das System individuell nach Wunsch und verfügbarem Platz konfigurieren.

## Track shapes

**EN** In both the round and square form, the track opens options for flexible application. Their track diameter is only 29mm, presenting a reduced and sleek appearance. Many insets offer an optional flush adapter to create an even, visually calm ceiling appearance.

**DE** In runder und eckiger Form bietet die Stromschiene flexible Einsatzmöglichkeiten. Ihr Durchmesser misst bis zu 29 mm – für eine reduzierte und edle Optik. Viele Insets verfügen über einen bündigen Adapter, wodurch ein ebenes, optisch ruhiges Deckenbild entsteht.

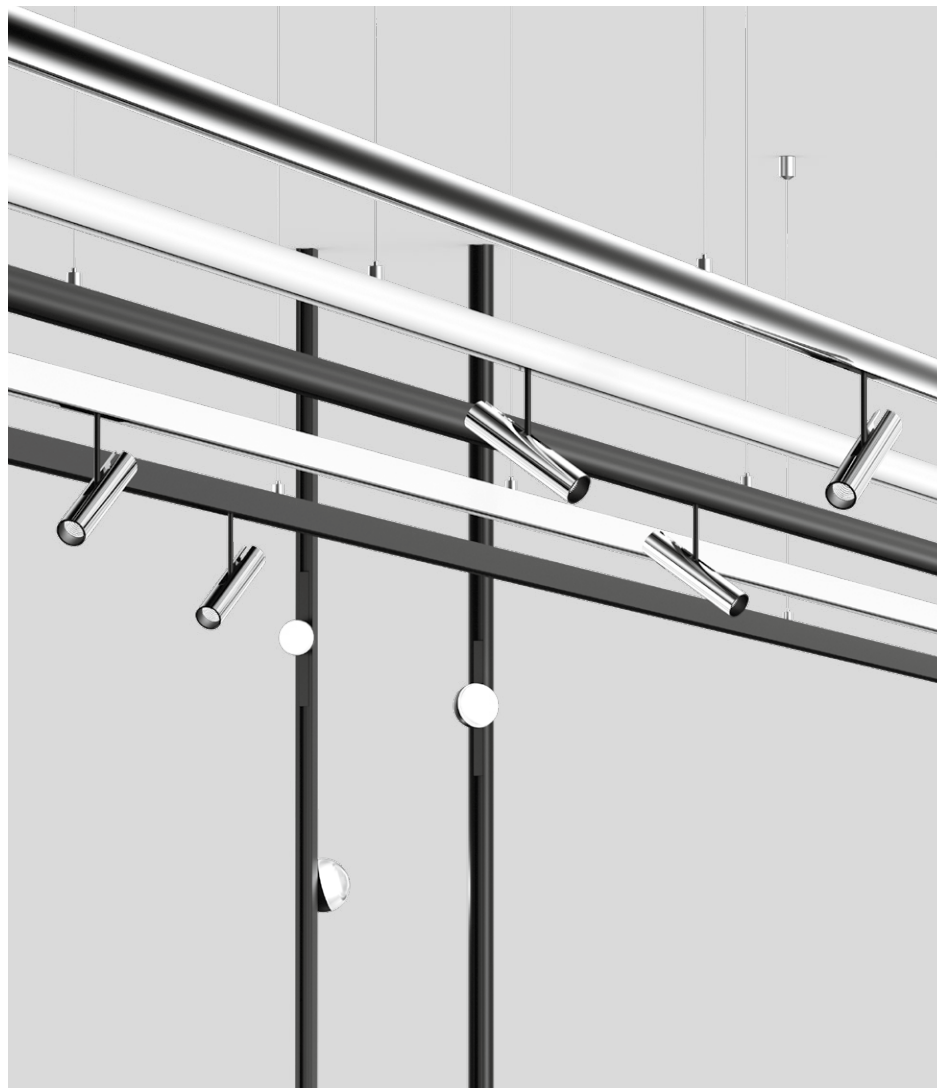
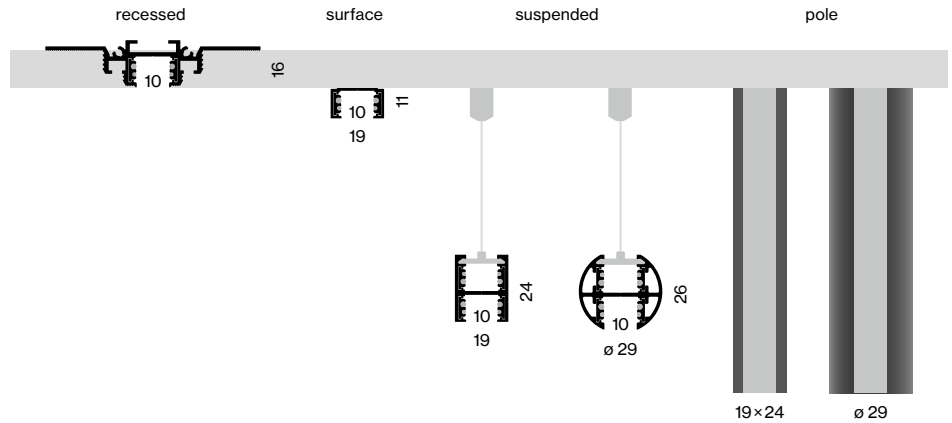

## Colour variety

**EN** The tracks are available in the colours black and white, delivering discreet elegance. The round track comes additionally in chrome. In addition, for some insets you have the choice between the trend colours chrome, rose gold, gun metal, brushed aluminium and brushed brass.

**DE** Dezentere Eleganz: Die Stromschiene sind in den Farben Schwarz und Weiß erhältlich. Die runde Schiene ist zudem in der Farbe Chrom verfügbar. Zusätzlich haben Sie bei einigen Insets die Wahl zwischen den Trendfarben Chrom, Roségold, Gun Metal, Aluminium gebürstet und Messing gebürstet.

### Installation tracks

<b>recessed square</b>	<input type="radio"/>	<input checked="" type="radio"/>	<input type="radio"/>
<b>surface square</b>	<input type="radio"/>	<input checked="" type="radio"/>	<input type="radio"/>
<b>suspended square</b>	<input type="radio"/>	<input checked="" type="radio"/>	<input type="radio"/>
<b>suspended round</b>	<input type="radio"/>	<input checked="" type="radio"/>	<input checked="" type="radio"/>
<b>pole square</b>	<input type="radio"/>	<input checked="" type="radio"/>	<input type="radio"/>
<b>pole round</b>	<input type="radio"/>	<input checked="" type="radio"/>	<input checked="" type="radio"/>

### Decorative insets

<b>GIRA</b>	<input type="radio"/>	<input checked="" type="radio"/>	<input type="radio"/>	<input type="radio"/>	<input type="radio"/>	<input type="radio"/>	<input type="radio"/>
<b>NOBA</b>	<input type="radio"/>	<input checked="" type="radio"/>	<input type="radio"/>	<input type="radio"/>	<input type="radio"/>	<input type="radio"/>	<input type="radio"/>
<b>TARO</b>	<input type="radio"/>	<input checked="" type="radio"/>	<input type="radio"/>	<input type="radio"/>	<input type="radio"/>	<input type="radio"/>	<input type="radio"/>
<b>TILA</b>	<input type="radio"/>	<input checked="" type="radio"/>	<input type="radio"/>	<input type="radio"/>	<input type="radio"/>	<input type="radio"/>	<input type="radio"/>



white



black

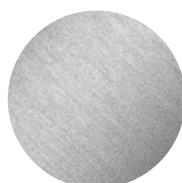

brushed aluminium

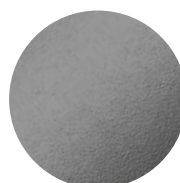

gun metal



brushed brass

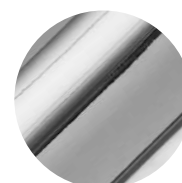

chrome

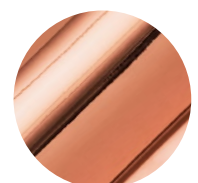

rose gold





## Mounting variety

**EN** With precise corners or harmonious curves, the MOVE IT 10 system sets no limits to creativity. Elegant insets for different applications make the track system even more flexible.

**DE** Egal ob mit präzisen Ecken oder harmonischen Kurven, das MOVE IT 10 System setzt der Kreativität keine Grenzen. Elegante Insets für verschiedene Anwendungen machen das Schienensystem noch flexibler.

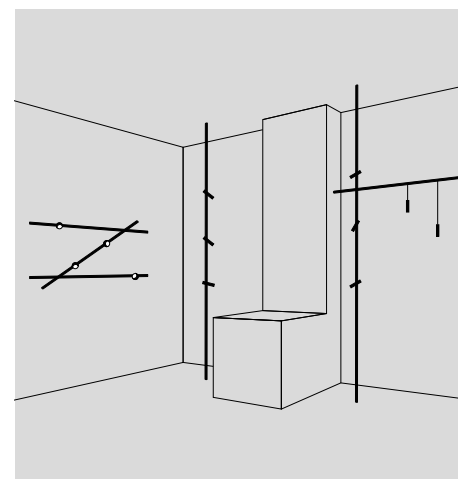
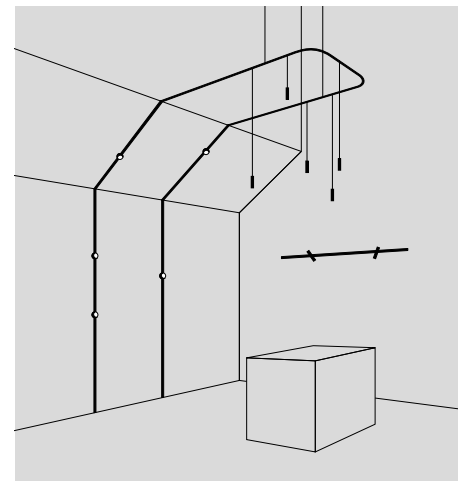
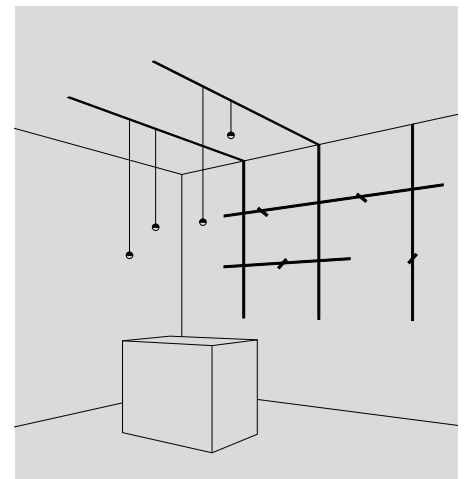



## Connector overview

**EN** A large selection of different connectors – in L-, T-, X-shape – provides even more flexibility. With the Ceiling to Wall Connector, roof slopes with different angles can also be realised.

**DE** Für noch mehr Flexibilität sorgt eine große Auswahl an unterschiedlichen Verbindern – in L-, T-, X-Form. Mit dem Ceiling to Wall Connector lassen sich zudem Dachschrägen mit verschiedenen Winkeln realisieren.

### 1 Linear Connector



### 2 L-Connector



### 3 T-Connector



### 4 X-Connector



### 5 Flex Connector

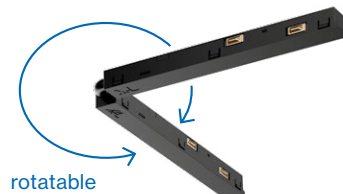

### 6 Ceiling to Wall Connector

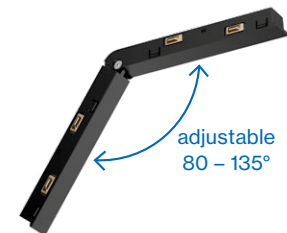

### 7 Level Connector

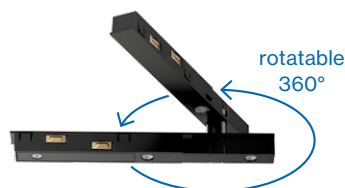

### 8 Pass Through Connector



**EN** With the Level Connector, two tracks that are placed on top of each other can now be mechanically and electrically connected to each other. This creates new application possibilities.

**DE** Mit dem Level Connector können nun zwei Schienen, die übereinander geführt werden, mechanisch und elektrisch miteinander verbunden werden. Dadurch entstehen spannende neue Anwendungsmöglichkeiten.

**EN** With the Pass Through Connector (patent pending) the direct and indirect light insets in the H-track can be electrically connected to each other.

**DE** Mit dem, zum Patent angemeldeten, Pass Through Connector können die direkten und indirekten Lichteinsätze in der H-Schiene elektrisch miteinander verbunden werden.

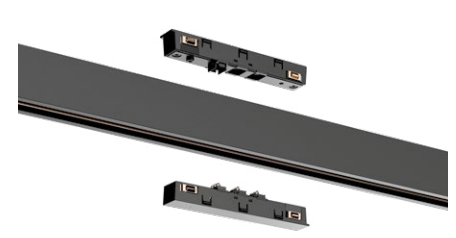
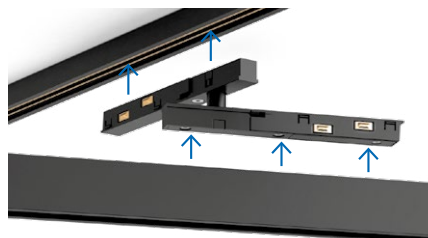

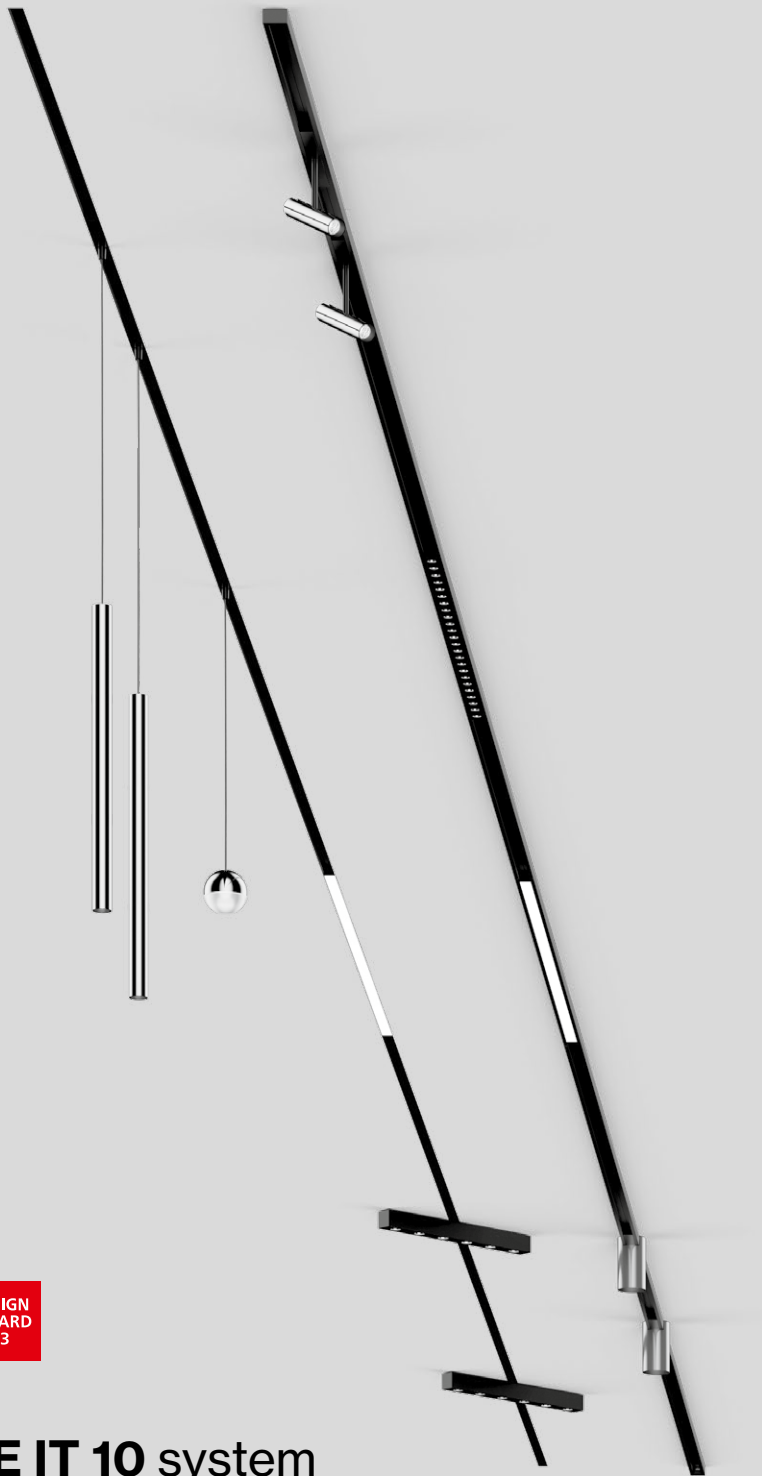

## MOVE IT 10 system

recessed trimless/surface

**EN** Thin extruded aluminium profile with 16 mm (trimless) or 11 mm (surface) height and 10 mm width groove; optionally for trimless installation in plasterboard ceilings (wall or ceiling mounting) with 12.5 mm ceiling thickness; MOVE IT 10 trimless profile with processing protection against penetration of filler; or for wall-/ceiling surface mounting; designed for continuous lighting systems; flexible system design through L, T or X connectors or by means of FLEX or LEVEL connectors; with integrated power track profile for take off of supply voltage and DALI-2 signal; surface anodised or powder coated; insets can be installed flexibly and without tools by means of clip mount

**DE** Niedriges Aluminiumstrangpressprofil mit 16 mm (trimless) bzw. 11 mm (surface) Höhe und 10 mm Fugenbreite; wahlweise für den randlosen Einbau in Gipskartondecken (Wand- oder Deckenmontage) mit 12,5 mm Deckenstärke; MOVE IT 10 trimless Profil mit Verarbeitungsschutz gegen Eintrinken von Spachtelmasse; oder für Wand-/Deckenanbaumontage; ausgelegt für durchgehende Lichtsysteme; flexibler Systemaufbau durch L-, T- oder X-Verbinder bzw. mittels FLEX- oder LEVEL-Verbinder; mit integriertem Stromschieneprofil für Abnahme von Versorgungsspannung und DALI-2 Signal; Oberfläche eloxiert bzw. pulverbeschichtet; flexible und werkzeuglose Montage der Einsätze durch Clipverschluss

### Quickinfo

2700K, 3000K, 4000K  
CRI ≥ 90  
L90 @ 50 000h  
DALI-2

### Types

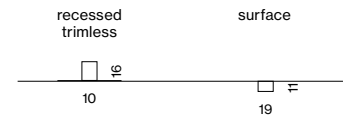

### Configurations

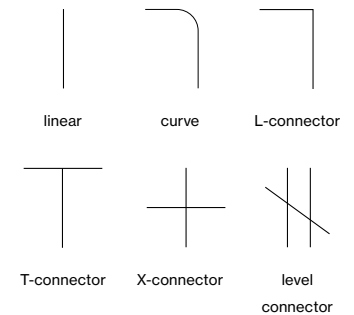

### Colours

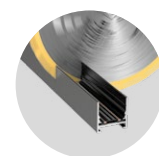

custom cut on building site



## Order options

### CONTROL

DALI-2

### MATERIAL COLOUR

- traffic white RAL 9016 7
- jet black RAL 9005 8

## Options on request

### CONNECTOR

T connector mechanical

T connector electrical

X connector mechanical

X connector electrical

only for recessed trimless

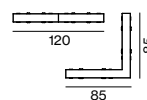
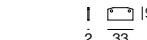
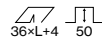

## MOVE IT 10 trimless

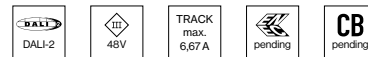

### INSTALLATION TRACK

#### L (mm)

1100	channel
2100	channel
3100	channel
custom cut	channel

#### ORDER CODE

030-1113038
030-1115038
030-1117038
E83610 ····8

\*incl. plasterin protection cover

### END CAPS / CONNECTORS

#### TYPE

end caps (pair)
linear connector electrical
L connector electrical
linear connector mechanical
L connector mechanical

#### ORDER CODE

030-1120018
030-210113
030-211113
030-1134018
030-1135018

more electrical and mechanical connectors see p. 19

## MOVE IT 10 surface

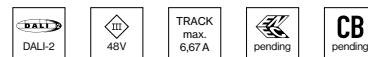

### INSTALLATION TRACK

#### L (mm)

1100	channel
2100	channel
3100	channel
custom cut	channel
R 300	curve channel
R 500	curve channel

#### ORDER CODE

030-121303
030-121503
030-121703
E83620 ····
030-123103
030-123203

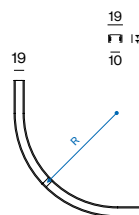

### END CAPS / CONNECTORS

#### TYPE

end caps (pair)
linear connector electrical
L connector electrical
T connector electrical
X connector electrical
linear connector mechanical
L connector mechanical
T connector mechanical
X connector mechanical

#### ORDER CODE

030-122001
030-210113
030-211113
030-212113
030-213113
030-123401
030-123501
030-123601
030-123701

more electrical and mechanical connectors see p. 19

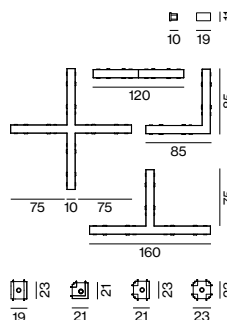

## Accessories

### BLIND COVER

#### L (mm)

1100	blind cover
2100	blind cover
3100	blind cover
custom cut	blind cover

#### ORDER CODE

030-100301
030-100501
030-100701
E83600 ····

### ELECTRICAL ACCESSORIES

#### TYPE

power feeder (only for surface)
internal power feeder (incl. cable 2000 mm)

#### ORDER CODE

030-252303
030-252503

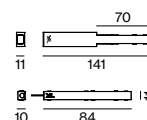

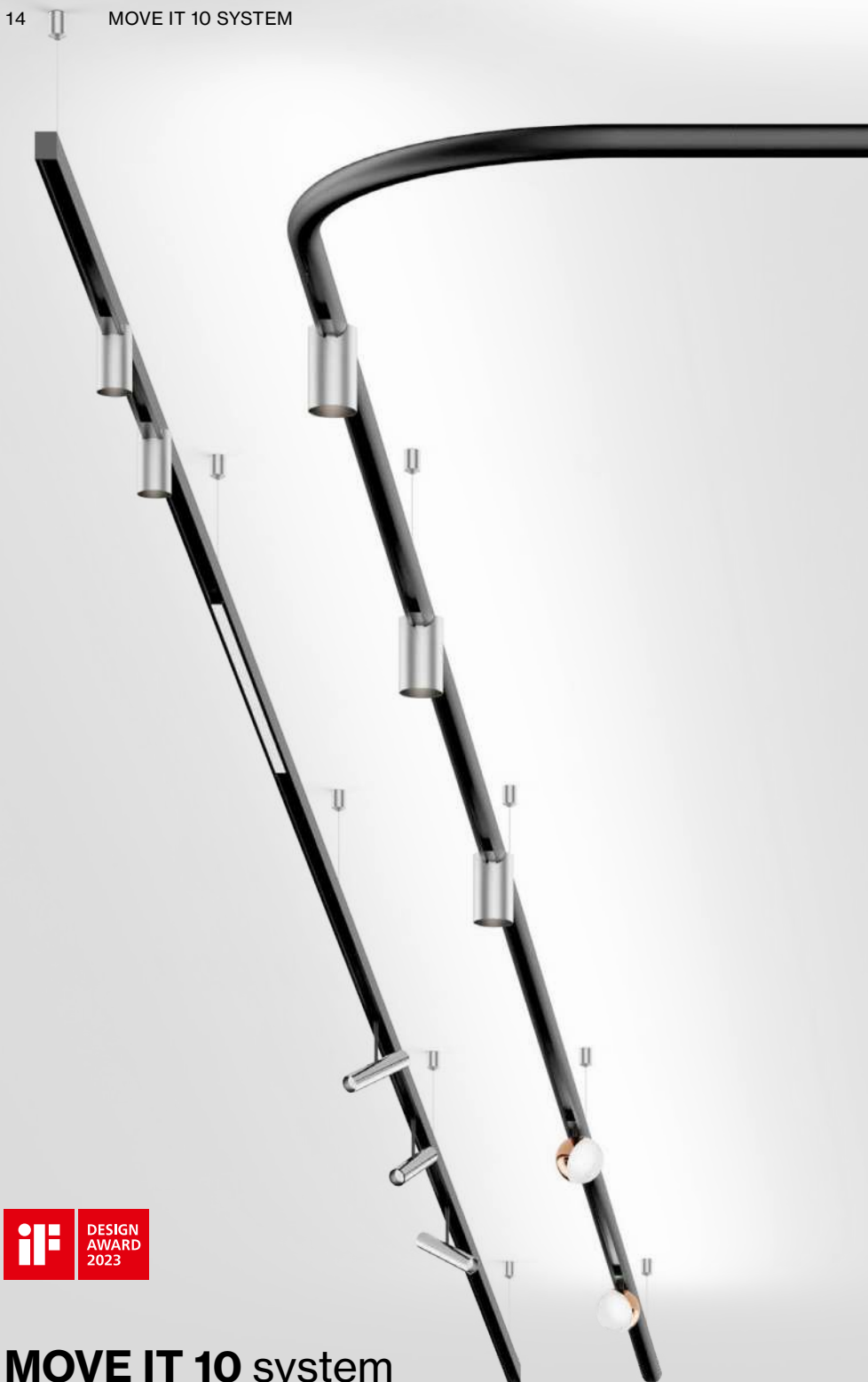

## MOVE IT 10 system

suspended

**EN** Thin extruded aluminium profile with 10 mm width groove; choice of angular (38 mm height) or tubular (28 mm height) design; for suspended mounting (cable suspension, height adjustment without tools, incl. black feed); with integrated power track profile on both sides for take off of supply voltage and DALI-2 signal; power supply and DALI-2 signal for both power tracks with only one feed by means of pass-through connector; designed for continuous lighting systems; flexible system design through L, T or X connectors or by means of LEVEL connectors; surface anodised or powder coated; insets can be installed flexibly and without tools by means of clip mount

**DE** Niedriges Aluminiumstrangpressprofil mit 10 mm Fugenbreite; wahlweise kantige (38 mm Höhe) bzw. tubulare (28 mm Höhe) Bauform; für abgehängte Montage (Seilabhängung, werkzeuglose Höhenverstellung, inkl. schwarzer Einspeiseleitung); mit beidseitig integriertem Stromschienenprofil für Abnahme von Versorgungsspannung und DALI-2 Signal; Spannungsversorgung und DALI-2 Signal für beide Stromschienen mit nur einer Einspeisung durch pass through Verbinder; ausgelegt für durchgehende Lichtsysteme; flexibler Systemaufbau durch L-, T- oder X-Verbinder bzw. mittels LEVEL-Verbinder; Oberfläche eloxiert bzw. pulverbeschichtet; flexible und werkzeuglose Montage der Einsätze durch Clipverschluss

### Quickinfo

2700K, 3000K, 4000K  
CRI ≥ 90  
L90 @ 50 000h  
DALI-2

### Types

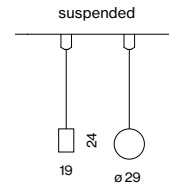

### Configurations

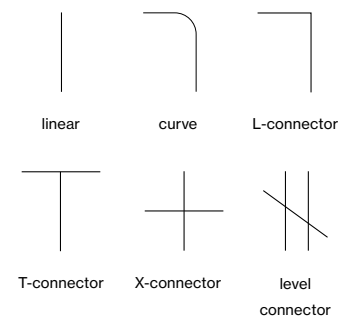

### Colours

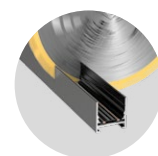

custom cut on building site

### Order options

#### CONTROL

DALI-2

#### MATERIAL COLOUR

- traffic white RAL 9016 7
- jet black RAL 9005 8

#### MATERIAL COLOUR

#### CABLE SUSPENSION

- chrome 4
- jet black RAL 9005 8

### Options on request

#### MATERIAL COLOUR

#### MOVE IT 10 ROUND

- chrome

### MOVE IT 10 square suspended

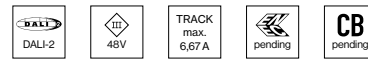

#### INSTALLATION TRACK

L (mm)		ORDER CODE
1100	channel	030-131303
2100	channel	030-131503
3100	channel	030-131703
custom cut	channel	E83630
R 300	curve channel	030-133103
R 500	curve channel	030-133203

#### END CAPS / CONNECTORS

TYPE	ORDER CODE
end caps (pair)	030-132001
linear connector electrical	030-210113
L connector electrical	030-211113
T connector electrical	030-212113
X connector electrical	030-213113
linear connector mechanical	030-133401
L connector mechanical	030-133501
T connector mechanical	030-133601
X connector mechanical	030-133701

more electrical and mechanical connectors see page 19

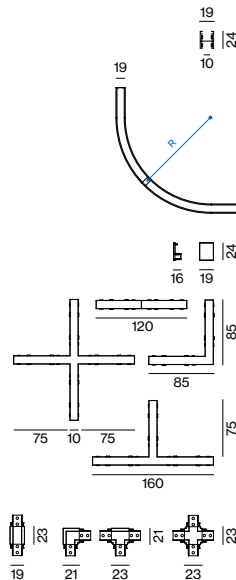

### MOVE IT 10 round suspended

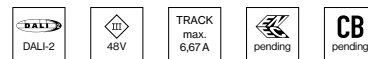

#### INSTALLATION TRACK

L (mm)		ORDER CODE
1100	channel	030-141303
2100	channel	030-141503
3100	channel	030-141703
custom cut	channel	E83640
R 300	curve channel	030-143103
R 500	curve channel	030-143203

#### END CAPS / CONNECTORS

TYPE	ORDER CODE
end caps (pair)	030-142001
linear connector electrical	030-210113
L connector electrical	030-211113
T connector electrical	030-212113
X connector electrical	030-213113
linear connector mechanical	030-143401
L connector mechanical	030-143501
T connector mechanical	030-143601
X connector mechanical	030-143701

more electrical and mechanical connectors see page 19

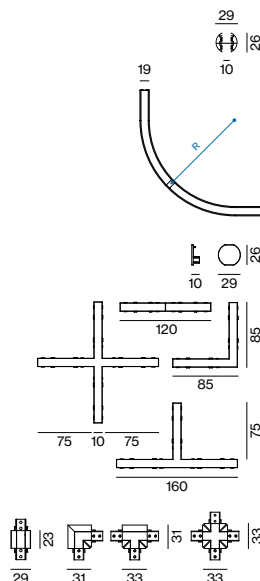

### Accessories

**BLIND COVER** see page 17

**INDIRECT LIGHT INSET** see page 17

#### CABLE SUSPENSION / CANOPY / ELECTRICAL ACCESSORIES

TYPE	L (mm)	ORDER CODE
cable suspension	1500	030-223001
cable susp. linear connector	1500	030-221001
cable susp. linear conn. electrical	1500	030-222001
canopy square	90-90-22	005-231121
canopy round	ø90-22	005-260003
internal power feeder (incl. cable 2000 mm)		030-252503
pass through connector electrical (pair)		030-217113

more electrical and mechanical connectors see page 19

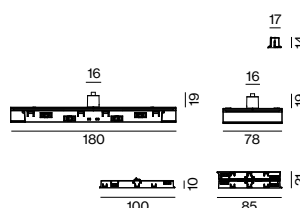



## MOVE IT 10 system

pole

**EN** Thin extruded aluminium profile with 10 mm width groove; choice of angular (38 mm height) or tubular (28 mm height) design; for vertical and horizontal mounting; easy installation of the mounting set, incl. feed; with integrated power track profile on both sides for take off of supply voltage and DALI-2 signal; power supply and DALI-2 signal for both power tracks with only one feed by means of pass-through connector; designed for continuous lighting systems; flexible system design through L, T or X connectors or by means of LEVEL connectors; surface anodised or powder coated; insets can be installed flexibly and without tools by means of clip mount

**DE** Niedriges Aluminiumstrangpressprofil mit 10 mm Fugenbreite; wahlweise kantige (38 mm Höhe) bzw. tubulare (28 mm Höhe) Bauform; für vertikale und horizontale Montage; einfache Installation des Montagesets, inkl. Einspeisung; mit beidseitig integriertem Stromschienenprofil für Abnahme von Versorgungsspannung und DALI-2 Signal; Spannungsversorgung und DALI-2 Signal für beide Stromschienen mit nur einer Einspeisung durch pass through Verbinder; ausgelegt für durchgehende Lichtsysteme; flexibler Systemaufbau durch L-, T- oder X-Verbinder bzw. mittels LEVEL-Verbinder; Oberfläche eloxiert bzw. pulverbeschichtet; flexible und werkzeuglose Montage der Einsätze durch Clipverschluss

### Quickinfo

2700K, 3000K, 4000K  
CRI ≥ 90  
L90 @ 50 000h  
DALI-2

### Types

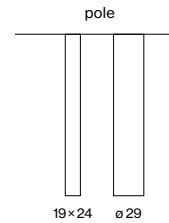

### Mounting types

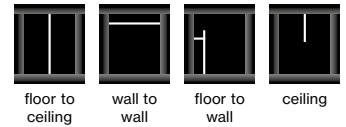

### Colours

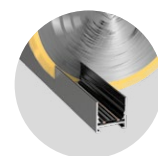

custom cut on building site

## Order options

### COLOUR TEMPERATURE

2700 K	4
3000 K	5
4000 K	6

### CONTROL

DALI-2

### MATERIAL COLOUR

○ traffic white RAL 9016	7
● jet black RAL 9005	8

## Options on request

### MATERIAL COLOUR

#### MOVE IT 10 ROUND

● chrome

## MOVE IT 10 square pole



### INSTALLATION TRACK

L (mm)		ORDER CODE
1100	channel	030-131303
2100	channel	030-131503
3100	channel	030-131703
custom cut	channel	E83630



### MOUNTING SET

TYPE	ORDER CODE
floor to ceiling set (pair)	030-134101
wall to wall set (pair)	030-134101
floor to wall set (wall bracket 400 mm incl. end cap)	030-134201
ceiling set (incl. end cap)	030-134301

## MOVE IT 10 round pole

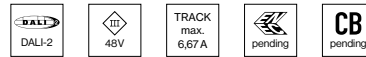

### INSTALLATION TRACK

L (mm)		ORDER CODE
1100	channel	030-141303
2100	channel	030-141503
3100	channel	030-141703
custom cut	channel	E83640



### MOUNTING SET

TYPE	ORDER CODE
floor to ceiling set (pair)	030-144101
wall to wall set (pair)	030-144101
floor to wall set (wall bracket 400 mm incl. end cap)	030-144201
ceiling set (incl. end cap)	030-144301

## LIGHT INSET 10

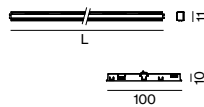

### INDIRECT incl. feeder

INS. POWER	COLOUR TEMP.	LUM. FLUX	L (mm)	ORDER CODE
15 W	2700 K	1370 lm	1000	030-6330
	3000 K	1450 lm		
	4000 K	1530 lm		
30 W	2700 K	2750 lm	2000	030-6370
	3000 K	2900 lm		
	4000 K	3050 lm		

## Accessories

### BLIND COVER

L (mm)		ORDER CODE
1100	blind cover	030-100301
2100	blind cover	030-100501
3100	blind cover	030-100701
custom cut	blind cover	E83600

**INSET POWER** is the current consumption excluding any ballast  
**LUMINOUS FLUX** value calculated for CRI ≥ 90, colour black

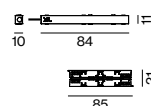

### ELECTRICAL ACCESSORIES

TYPE	ORDER CODE
internal power feeder (incl. cable 2000 mm)	030-252503
pass through connector electrical (pair)	030-217113



## Types

- 1 Linear Connector
- 2 L-Connector
- 3 T-Connector
- 4 X-Connector
- 5 Flex Connector
- 6 Ceiling to Wall Connector
- 7 Level Connector
- 8 Pass Through Connector

## Configurations

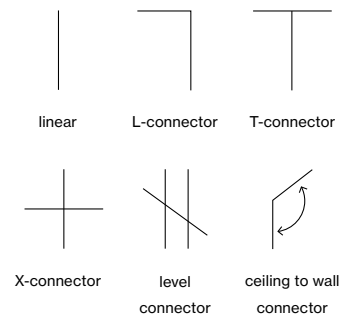

## Colours



# ELECTRICAL accessories

MOVE IT 10 system

**EN** Mechanical and electrical connectors to MOVE IT 10 system; in L-, T- or X-shape; or FLEX-, CEILING TO WALL or LEVEL connectors, as well as PASS THROUGH connectors; for flexible system design; different converters for the entire MOVE IT system

**DE** Mechanische und elektrische Verbinder zu MOVE IT 10 system; in L-, T- oder X-Form; bzw. FLEX-, CEILING TO WALL- oder LEVEL-Verbinder, sowie PASS THROUGH-Verbinder; für flexiblen Systemaufbau; unterschiedliche Konverter für gesamtes MOVE IT system



### Order options

CONNECTOR MECHANICAL	T
recessed*	1
surface	2
suspended square	3
suspended round	4

\*T- and X-connector on request

CONTROL
DALI-2

MATERIAL COLOUR	☑
○ traffic white* RAL 9016	7
● jet black RAL 9005	8

\*not for mechanical recessed trimless

### Options on request

CONNECTOR
T connector electrical
T connector mechanical
X connector electrical
X connector mechanical

only for recessed trimless

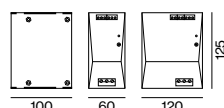
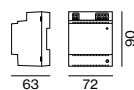
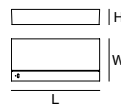
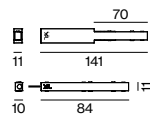
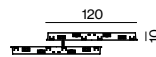
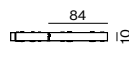
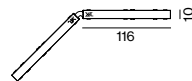
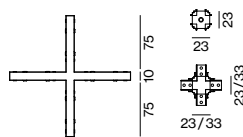
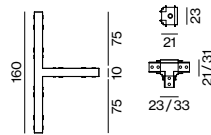
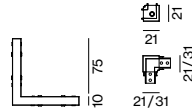
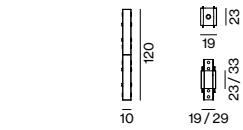

### Electrical accessories

#### LINEAR CONNECTOR

TYPE	ORDER CODE
linear connector electrical	030-210113
linear connector mechanical	030-1T3401

#### L CONNECTOR

TYPE	ORDER CODE
L connector electrical	030-211113
L connector mechanical	030-1T3501

#### T CONNECTOR

TYPE	ORDER CODE
T connector electrical	030-212113
T connector mechanical	030-1T3601

#### X CONNECTOR

TYPE	ORDER CODE
X connector electrical	030-213113
X connector mechanical	030-1T3701

#### FLEX CONNECTOR

TYPE	ORDER CODE
flex connector electrical	030-214113

#### CEILING TO WALL CONNECTOR

TYPE	ORDER CODE
ceiling to wall connector electrical	030-216113

#### LEVEL CONNECTOR

TYPE	ORDER CODE
level connector electrical	030-215113

#### PASS THROUGH CONNECTOR

TYPE	ORDER CODE
pass through connector electrical (pair)	030-217113

electrical connection from direct to indirect and vice versa

#### POWER FEEDER

TYPE	ORDER CODE
power feeder (only for surface)	030-252303
internal power feeder (incl. cable 2000mm)	030-252503

#### POWER SUPPLY EXTERNAL supply 220-240 V AC, 48V, 50-60 Hz

TYPE	EFFICIENCY	MOUNTING	L-W-H (mm)	ORDER CODE
60W □ PC II η88%	external	163-43-32	002-62133	
150W □ PC II η92%	external	350-30-18	002-62135	
250W □ PC II η93%	external	400-40-22	002-62139	

ENEC approved, incl. feeder cable 2000 mm

#### POWER SUPPLY BASIC 48V

220-240V | 50-60 Hz | □ PC II | Lifetime @ 120W, 45° ambient temp. cascable max. 3 devices

TYPE	EFFICIENCY/LIFETIME	W-H-D (mm)	ORDER CODE
160W η94.5% / > 100.000h	72-90-63	005-6520210	

#### DIN RAIL POWER SUPPLY PRO 48V

220-240V | 50-60 Hz | ⊕ PC I | MTBF @ 55° ambient temperature cascable max. 5 devices (240W) or 3 devices (480W)

TYPE	EFFICIENCY/MTBF	W-H-D (mm)	ORDER CODE
240W η92% / > 400.000h	60-125-100	005-6220110	
480W η93% / > 350.000h	120-125-100	005-6220210	

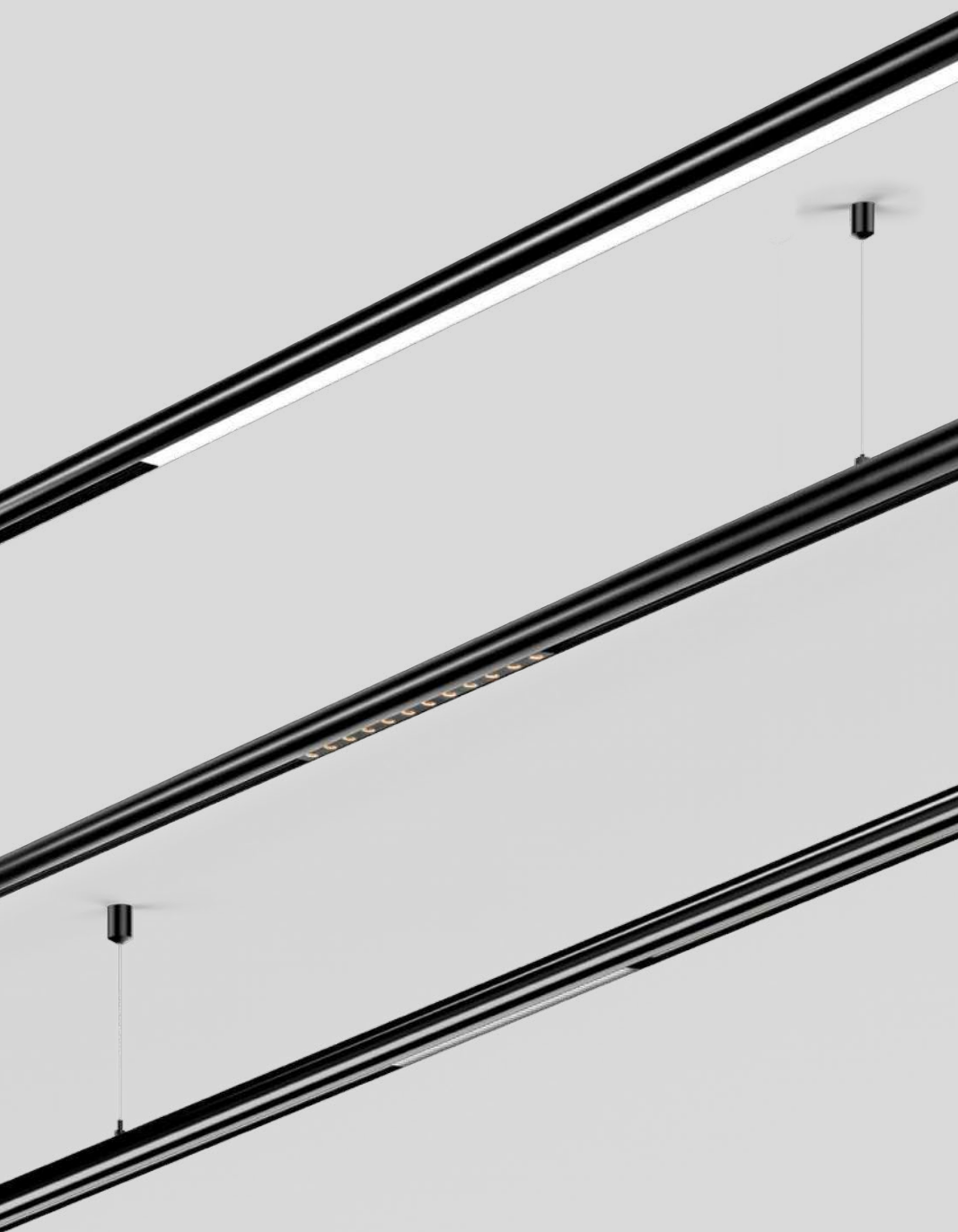

## Quickinfo

2700 K, 3000 K, 4000 K  
 CRI ≥ 90  
 up to 105 lm/W  
 DALI-2

## Types

spot line

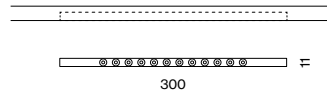

opal

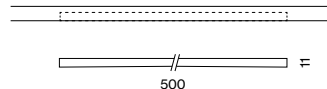

darklight

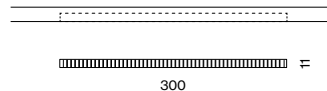

indirect

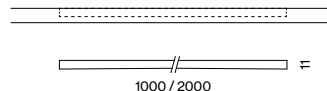

## Colour



## Light distributions



spot line

opal

darklight



indirect



# SPOT LINE / OPAL / DARKLIGHT

linear inset 10

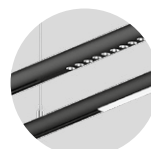

flush  
mounted



## Order options

### COLOUR TEMPERATURE

2700 K	4
3000 K	5
4000 K	6

### CONTROL

DALI-2

### MATERIAL COLOUR

● jet black RAL 9005

### LIGHT OPTIC

spot line  
opal high performance  
darklight  
indirect

## LIGHT INSET 10

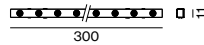

### SPOT LINE

INS. POWER	COLOUR TEMP.	LUM. FLUX	L (mm)	ORDER CODE
8.5 W	2700 K	420 lm	300	0 30 - 6 1 1 0 :: 3 8 M
	3000 K	460 lm		
	4000 K	480 lm		

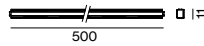

### OPAL HIGH PERFORMANCE

INS. POWER	COLOUR TEMP.	LUM. FLUX	L (mm)	ORDER CODE
5 W	2700 K	520 lm	500	0 30 - 6 1 2 0 :: 3 8 H
	3000 K	520 lm		
	4000 K	525 lm		

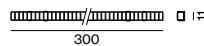

### DARKLIGHT

INS. POWER	COLOUR TEMP.	LUM. FLUX	L (mm)	ORDER CODE
5.7 W	2700 K	280 lm	300	0 30 - 6 2 1 0 :: 3 8 M
	3000 K	280 lm		
	4000 K	285 lm		

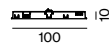
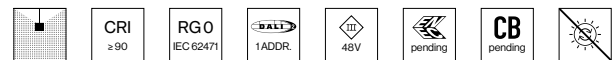

### INDIRECT incl. feeder

INS. POWER	COLOUR TEMP.	LUM. FLUX	L (mm)	ORDER CODE
15 W	2700 K	1370 lm	1000	0 30 - 6 3 3 0 :: 3 8 M
	3000 K	1450 lm		
	4000 K	1530 lm		
30 W	2700 K	2750 lm	2000	0 30 - 6 3 7 0 :: 3 8 M
	3000 K	2900 lm		
	4000 K	3050 lm		

**INSET POWER** is the current consumption excluding any ballast  
**LUMINOUS FLUX** value calculated for CRI ≥ 90, colour black

**Private Residence**  
Visualisation









**Quickinfo**

2700 K, 3000 K, 4000 K  
 CRI ≥ 90  
 up to 81lm/W  
 DALI-2

**Types**

adjustable rod

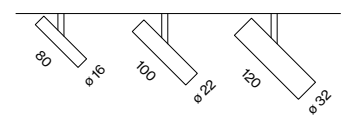

suspended

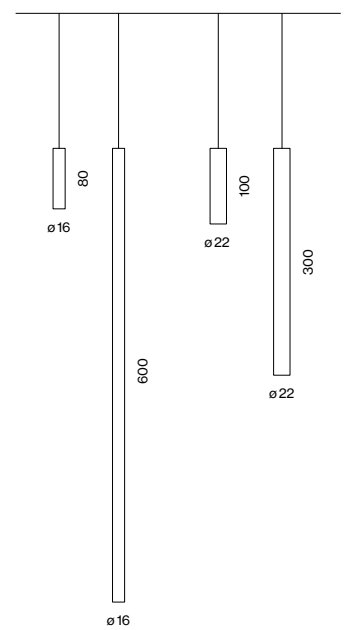

**Colours**



**Light distributions**

TILA 16



TILA 22/32

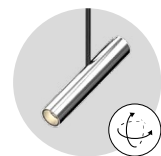

365° rotatable  
 135° tiltable

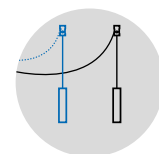

free positioning by  
 cable and hook



flush adapter  
 mounting



**TILA**  
 decorative inset 10

## Order options

HOUSING HEIGHT TILA 16	L
80 mm	0
600 mm	1

HOUSING HEIGHT TILA 22	L
100 mm	3
300 mm	4

COLOUR TEMPERATURE	••
2700 K	4
3000 K	5
4000 K	6

### CONTROL

DALI-2	
--------	--

MATERIAL COLOUR	▣
○ traffic white RAL 9016	7
● jet black RAL 9005	8
● brushed aluminium	6
● chrome	4

MATERIAL COLOUR ACCESSORIES	■
○ traffic white RAL 9016	7
● jet black RAL 9005	8

BEAM ANGLE TILA 16	▲
medium 20°	M
flood 40°	F

BEAM ANGLE TILA 22/32	▲
spot 14°	S
medium 24°	M
flood 45°	F

## Options on request

MATERIAL COLOUR	
● gun metal	
● brushed brass	
● rose gold	

## TILA 16

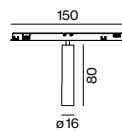

### ADJUSTABLE

INSET POWER	COLOUR TEMP.	LUMINOUS FLUX	ORDER CODE
5 W	2700 K	230lm	0 30 - 6 5 0 0 : 3 ▲
	3000 K	240lm	
	4000 K	250lm	

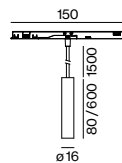

### SUSPENDED

INSET POWER	COLOUR TEMP.	LUMINOUS FLUX	ORDER CODE
5 W	2700 K	230lm	0 30 - 6 6 L 0 : 3 ▲
	3000 K	240lm	
	4000 K	250lm	

## TILA 22

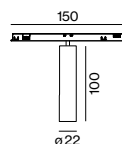

### ADJUSTABLE

INSET POWER	COLOUR TEMP.	LUMINOUS FLUX	ORDER CODE
10.5 W	2700 K	415lm	0 30 - 6 5 3 0 : 3 ▲
	3000 K	440lm	
	4000 K	460lm	

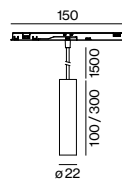

### SUSPENDED

INSET POWER	COLOUR TEMP.	LUMINOUS FLUX	ORDER CODE
10.5 W	2700 K	415lm	0 30 - 6 6 L 0 : 3 ▲
	3000 K	440lm	
	4000 K	460lm	

## TILA 32

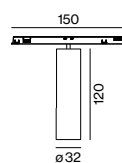

### ADJUSTABLE

INSET POWER	COLOUR TEMP.	LUMINOUS FLUX	ORDER CODE
11 W	2700 K	720lm	0 30 - 6 5 6 0 : 3 ▲
	3000 K	850lm	
	4000 K	900lm	

## Mounting accessories

### HOOK ceiling mounted

TYPE	Ø-H (mm)	ORDER CODE
hook	16-30	0 30 - 1 0 0 0 0 1 ■



## Optical accessories

### HONEYCOMB LOUVER

TYPE	Ø-H (mm)	ORDER CODE
TILA 22	20-3	0 0 7 - 1 9 6 5 1 1 8
TILA 32	30-3	0 0 7 - 1 9 6 5 1 6 8

**INSET POWER** is the current consumption excluding any ballast  
**LUMINOUS FLUX** value calculated for CRI≥90, colour white, medium

**Jewellery Shop**  
Visualisation





**Private Residence**  
Visualisation







**Private Residence**  
Visualisation







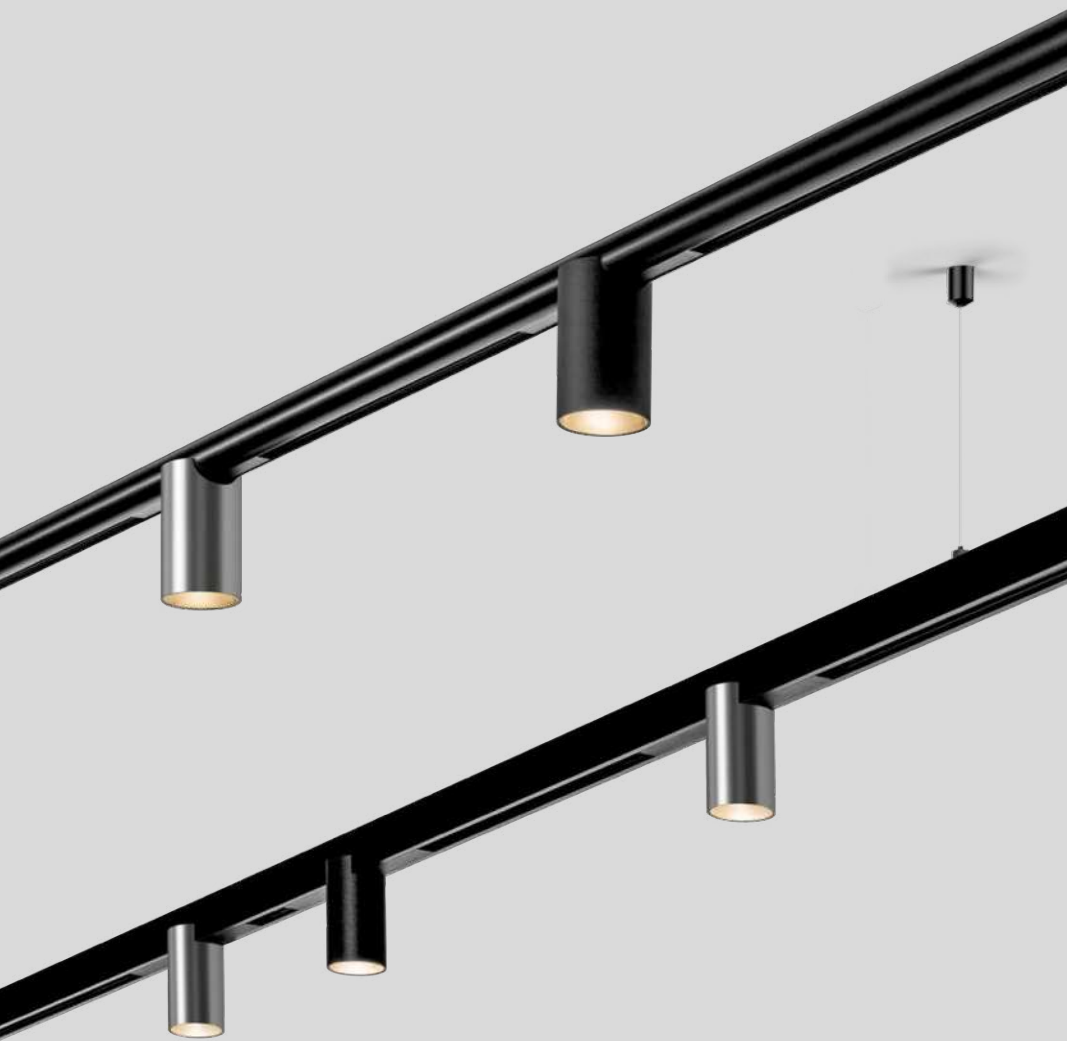

### Quickinfo

2700 K, 3000 K, 4000 K  
CRI ≥ 90  
up to 83 lm/W  
DALI-2

### Types

square track

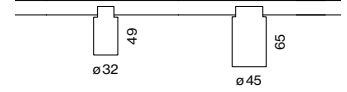

round track

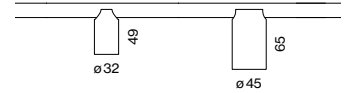

### Colours



### Light distributions

TARO 32



spot med. flood

TARO 45



med. flood wall  
floor



# TARO

decorative inset 10



wallwasher floor  
360° rotatable



wallwasher  
floor

## Order options

COLOUR TEMPERATURE	
2700 K	4
3000 K	5
4000 K	6

CONTROL	
DALI-2	

MATERIAL COLOUR	
○ traffic white RAL 9016	7
● jet black RAL 9005	8
● brushed aluminium	6
● chrome	4

BEAM ANGLE TARO 32	
spot 18°	S
medium 23°	M
flood 37°	F

BEAM ANGLE TARO 45	
medium 24°	M
flood 39°	F

## Options on request

MATERIAL COLOUR	
● gun metal	
● brushed brass	
● rose gold	

## TARO 32

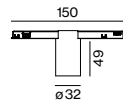
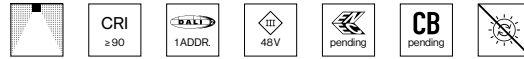

### DOWNLIGHT SQUARE TRACK

INSET POWER	COLOUR TEMP.	LUMINOUS FLUX	ORDER CODE
11W	2700 K	720lm	0 30 - 6 7 0 0 :: 3 ▣ ▲
	3000 K	860lm	
	4000 K	900lm	

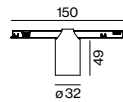

### DOWNLIGHT ROUND TRACK

INSET POWER	COLOUR TEMP.	LUMINOUS FLUX	ORDER CODE
11W	2700 K	720lm	0 30 - 6 7 4 0 :: 3 ▣ ▲
	3000 K	860lm	
	4000 K	900lm	

## TARO 45

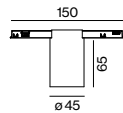
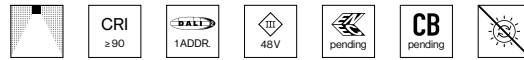

### DOWNLIGHT SQUARE TRACK

INSET POWER	COLOUR TEMP.	LUMINOUS FLUX	ORDER CODE
15W	2700 K	1000lm	0 30 - 6 7 1 0 :: 3 ▣ ▲
	3000 K	1100lm	
	4000 K	1150lm	

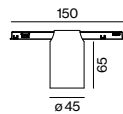

### DOWNLIGHT ROUND TRACK

INSET POWER	COLOUR TEMP.	LUMINOUS FLUX	ORDER CODE
15W	2700 K	1000lm	0 30 - 6 7 5 0 :: 3 ▣ ▲
	3000 K	1100lm	
	4000 K	1150lm	

## TARO 45 wallwasher floor

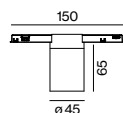

### DOWNLIGHT SQUARE TRACK

INSET POWER	COLOUR TEMP.	LUMINOUS FLUX	ORDER CODE
9W	2700 K	530lm	0 30 - 6 7 8 0 :: 3 ▣ W
	3000 K	570lm	
	4000 K	580lm	

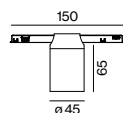

### DOWNLIGHT ROUND TRACK

INSET POWER	COLOUR TEMP.	LUMINOUS FLUX	ORDER CODE
9W	2700 K	530lm	0 30 - 6 7 9 0 :: 3 ▣ W
	3000 K	570lm	
	4000 K	580lm	

## Optical accessories

### HONEYCOMB LOUVER

TYPE	Ø-H (mm)	ORDER CODE
TARO 32	30·4	0 0 7 - 1 9 6 5 1 6 8
TARO 45	42·3	0 0 7 - 1 9 6 5 1 8 8

**INSET POWER** is the current consumption excluding any ballast  
**LUMINOUS FLUX** value calculated for CRI≥90, colour white, medium

**Jewellery Shop**  
Visualisation

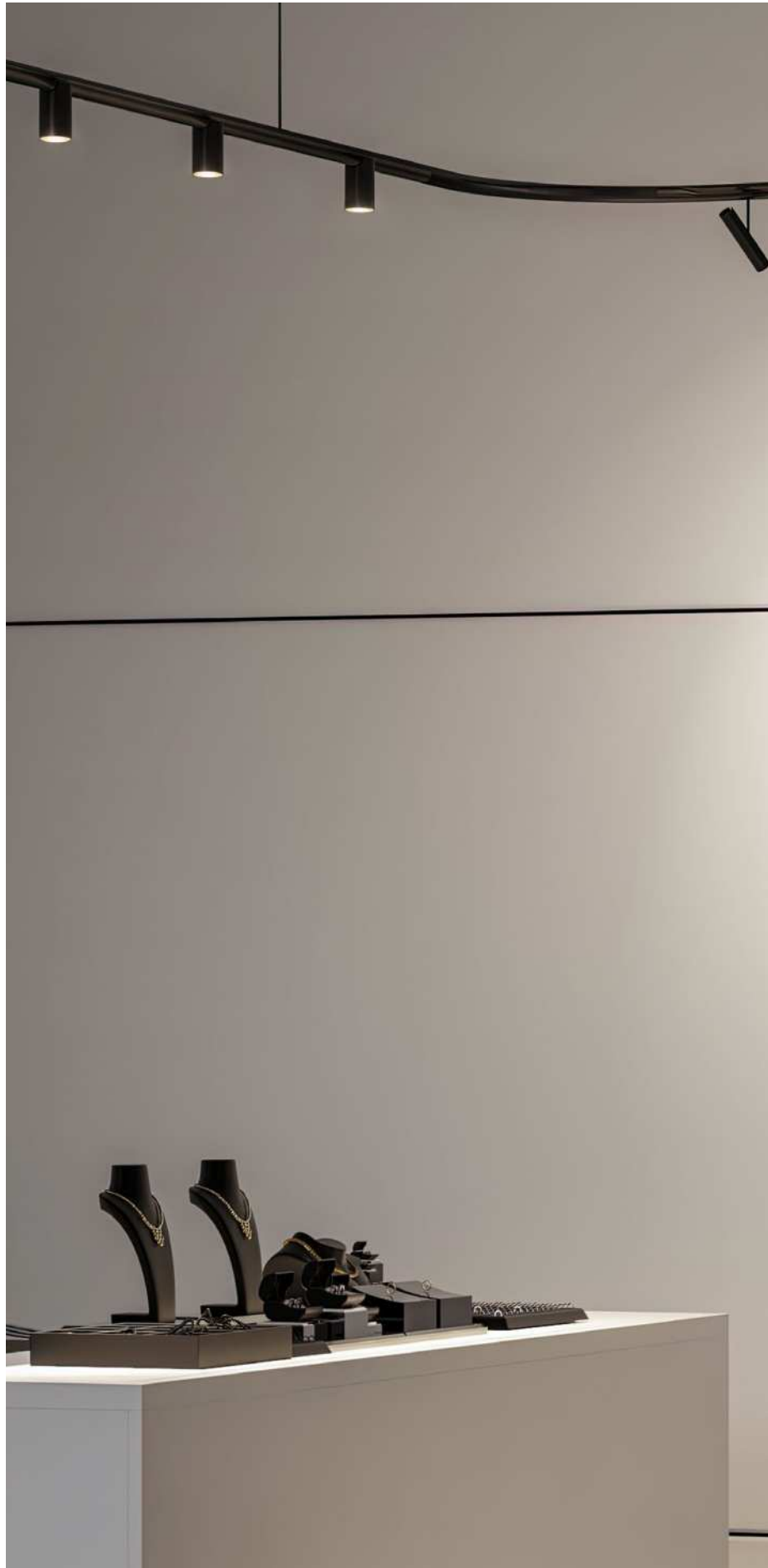



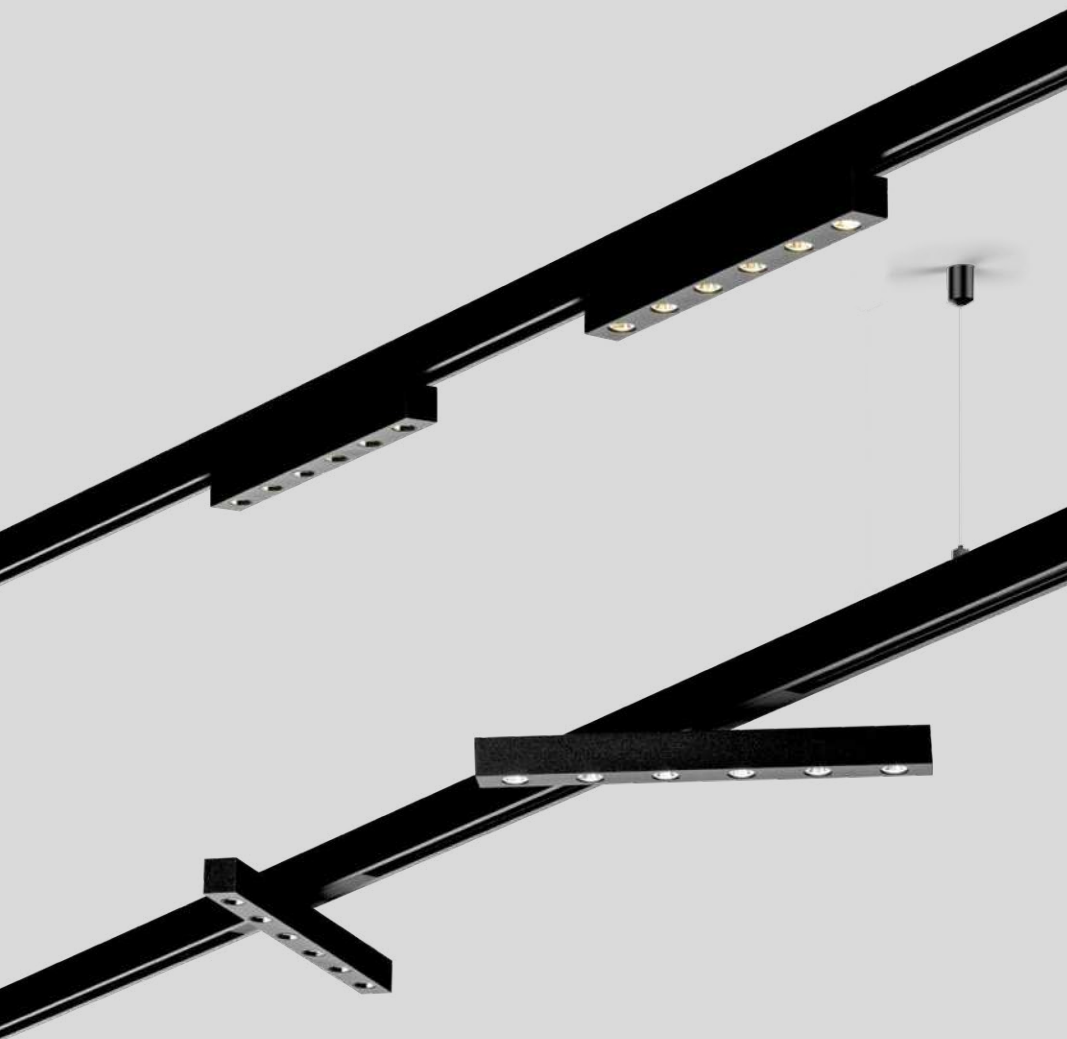

### Quickinfo

2700 K, 3000 K, 4000 K  
 CRI ≥ 90  
 up to 79 lm/W  
 DALI-2

### Type

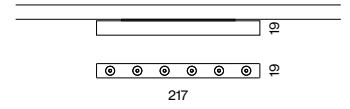

### Colours



### Light distributions



**GIRA**  
 decorative inset 10



360°  
 rotatable



wallwasher  
 floor



## Order options

### COLOUR TEMPERATURE

2700 K	4
3000 K	5
4000 K	6

### CONTROL

DALI-2

### MATERIAL COLOUR

<input type="radio"/> traffic white RAL 9016	7
<input checked="" type="radio"/> jet black RAL 9005	8



### BEAM ANGLE

medium 20°	M
flood 40°	F

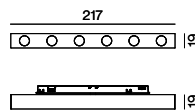
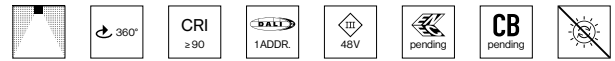
## GIRA





### DOWNLIGHT ROTATABLE

INSET POWER	COLOUR TEMP.	LUMINOUS FLUX	ORDER CODE
19 W	2700 K	1350 lm	0 3 0 - 6 4 1 0 :: 3  
	3000 K	1400 lm	
	4000 K	1450 lm	

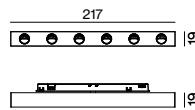
## GIRA wallwasher floor



### WALLWASHER FLOOR ROTATABLE

INSET POWER	COLOUR TEMP.	LUMINOUS FLUX	ORDER CODE
11 W	2700 K	730 lm	0 3 0 - 6 4 3 0 :: 3   W
	3000 K	770 lm	
	4000 K	800 lm	

**INSET POWER** is the current consumption excluding any ballast  
**LUMINOUS FLUX** value calculated for CRI ≥ 90, colour white, medium

**Private Residence**  
Visualisation



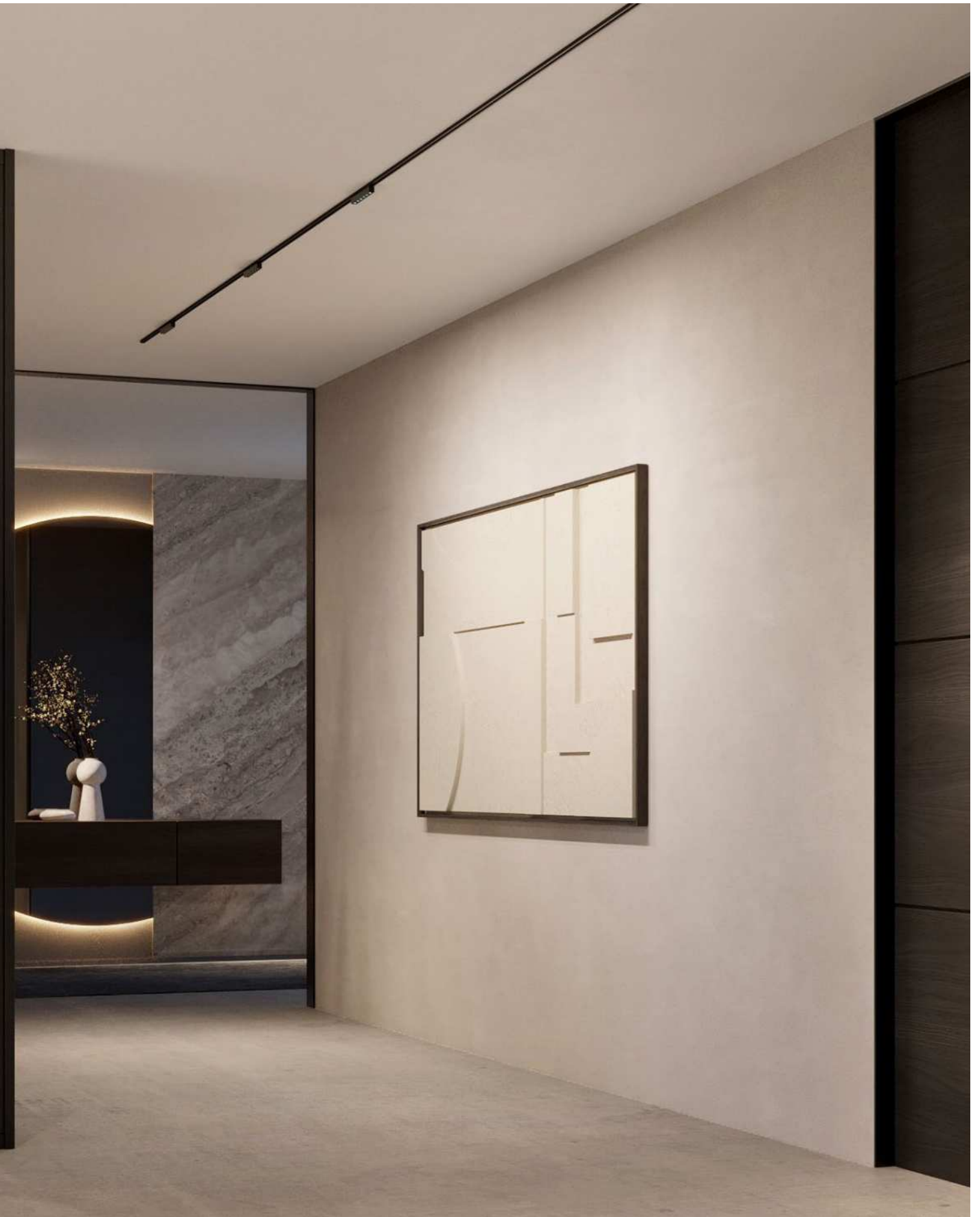



### Quickinfo

2700 K, 3000 K, 4000 K  
 CRI ≥ 90  
 up to 110 lm/W  
 DALI-2

### Types

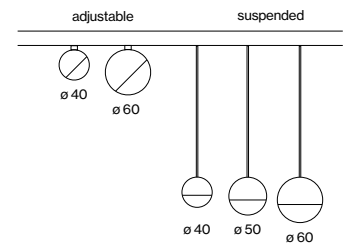

### Colours



### Light distribution



365° rotatable  
 90° tiltable

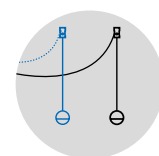

free positioning by  
 cable and hook



high quality  
 glass lens



## NOBA

decorative inset 10

## Order options

### COLOUR TEMPERATURE

2700 K	4
3000 K	5
4000 K	6

### CONTROL

DALI-2	
--------	--

### MATERIAL COLOUR

○ traffic white RAL 9016	7
● jet black RAL 9005	8
● brushed aluminium	6
● chrome	4

### MATERIAL COLOUR

#### ACCESSORIES

○ traffic white RAL 9016	7
● jet black RAL 9005	8

### BEAM ANGLE

direct 80°	
------------	--

## Options on request

### MATERIAL COLOUR

● gun metal	
● brushed brass	
● rose gold	

## NOBA 40

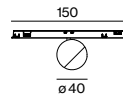

### SPOTLIGHT ADJUSTABLE

INSET POWER	COLOUR TEMP.	LUMINOUS FLUX	ORDER CODE
4.5 W	2700 K	465 lm	0 30-6 800 :: 3
	3000 K	480 lm	
	4000 K	500 lm	

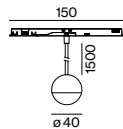

### DOWNLIGHT SUSPENDED

INSET POWER	COLOUR TEMP.	LUMINOUS FLUX	ORDER CODE
4.5 W	2700 K	465 lm	0 30-6 900 :: 3
	3000 K	480 lm	
	4000 K	500 lm	

## NOBA 50

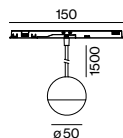

### DOWNLIGHT SUSPENDED

INSET POWER	COLOUR TEMP.	LUMINOUS FLUX	ORDER CODE
9 W	2700 K	695 lm	0 30-6 910 :: 3
	3000 K	725 lm	
	4000 K	760 lm	

## NOBA 60

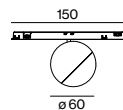

### SPOTLIGHT ADJUSTABLE

INSET POWER	COLOUR TEMP.	LUMINOUS FLUX	ORDER CODE
10 W	2700 K	715 lm	0 30-6 820 :: 3
	3000 K	745 lm	
	4000 K	780 lm	

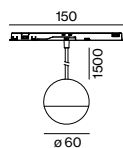

### DOWNLIGHT SUSPENDED

INSET POWER	COLOUR TEMP.	LUMINOUS FLUX	ORDER CODE
10 W	2700 K	715 lm	0 30-6 920 :: 3
	3000 K	745 lm	
	4000 K	780 lm	

## Mounting accessories



### HOOK ceiling mounted

TYPE	Ø-H (mm)	ORDER CODE
hook	16-30	0 30-1 000 0 1

**INSET POWER** is the current consumption excluding any ballast  
**LUMINOUS FLUX** value calculated for CRI≥90, colour white

**Private Residence**  
Visualisation

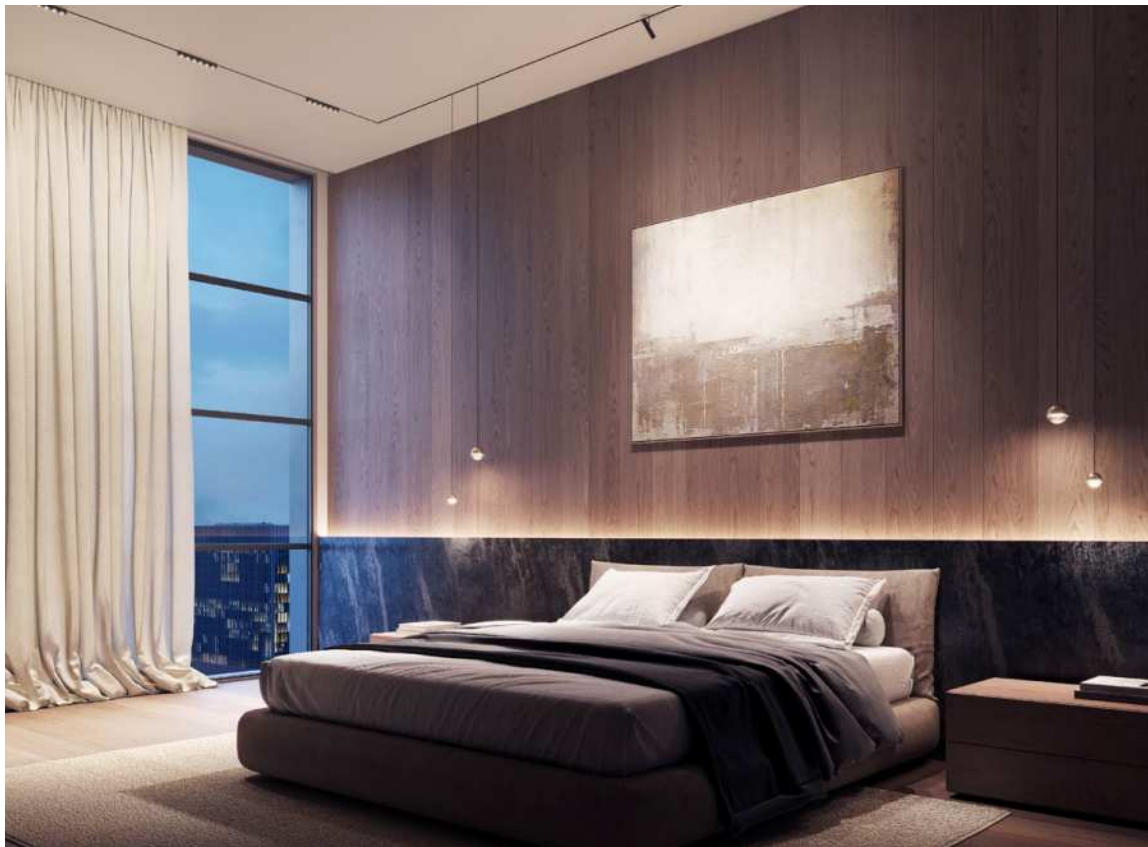





# Perfect allrounder





## TUBO/SETA 60 CONEX system

**EN** TUBO and SETA make a name for themselves as uniform and minimalist lighting system luminaires that can be flexibly joined by various connecting elements. The luminaires are available for wall and ceiling mounting, as well as in suspended pendant versions. Thanks to their opal cover, the TUBO system luminaire delivers uniform ambient illumination and the characteristic beam angle of up to 340° ensures a soft ceiling illumination that helps build a pleasant room atmosphere. SETA system luminaire's reflectors are particularly noteworthy and have been optimised for office spaces and designed for working at screens. The indirect light component creates a pleasant, homogeneous ceiling illumination for every work area. The CONEX connector (patent pending) grants the system a high degree of flexibility. As a mechanical and electrical L-, T-, and X-shaped connecting element, it allows implementation of geometric shapes over several levels.

**DE** Als Systemleuchten punkten TUBO und SETA als einheitliche und minimalistische Lichtsysteme, die durch verschiedene Verbindungselemente flexibel aneinandergereiht werden können. Die Leuchten sind für Wand- und Deckenmontage als auch in abgehängten Pendelvarianten erhältlich. Durch das Opal-Cover sorgt die TUBO Systemleuchte für eine gleichmäßige Grundausleuchtung und der charakteristische Abstrahlwinkel von bis zu 340° sorgt für eine leichte Deckenaufhellung, welche eine positive Raumatmosphäre unterstützt. Besonders hervorzuheben sind die eigens für Büroräumlichkeiten optimierten Reflektoren der SETA Systemleuchte, die speziell für Bildschirmarbeit konzipiert wurde. Durch den Indirektlichtanteil entsteht eine für jeden Arbeitsbereich angenehme, homogene Deckenaufhellung. Der zum Patent angemeldete CONEX Verbinder verleiht dem System hohe Flexibilität. Als mechanisches und elektrisches Verbindungselement in L-, T- und X-Form lassen sich geometrische Formen über mehrere Ebenen realisieren.

### Type



60

### Mountings

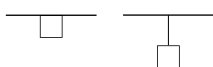

surface

suspended

### System configurations



linear

L

T

X

### Light distributions

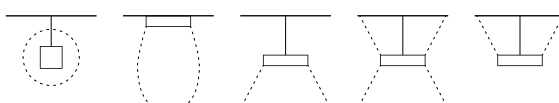

opal

reflector  
(UGR $\leq$ 19)

direct

direct  
indirect

indirect

## Connector CONEX

**EN** The patent pending CONEX connector system for the TUBO 60 system now offers even more design freedom. With the flexible lighting system, geometric shapes or exciting light sculptures can be created. Thanks to the mechanical and electrical connectors in L, T and X shapes, a visually uniform lighting system is created. In combination with the SETA system, various areas of application are possible - whether as corridor, office luminaire or visual guidance system.

**DE** Das zum Patent angemeldete CONEX Verbindungssystem für das TUBO 60 System bietet nun noch mehr Gestaltungsfreiraum. Mit dem flexiblen Beleuchtungssystem lassen sich geometrische Formen oder spannende Lichtskulpturen kreieren. Dank der mechanischen und elektrischen Verbindungselemente in L-, T- und X-Form entsteht ein optisch einheitliches Lichtsystem. In Kombination mit dem SETA System erschließen sich verschiedene Anwendungsbereiche – ob als Korridor-, Office-Leuchte oder visuelles Leitsystem.

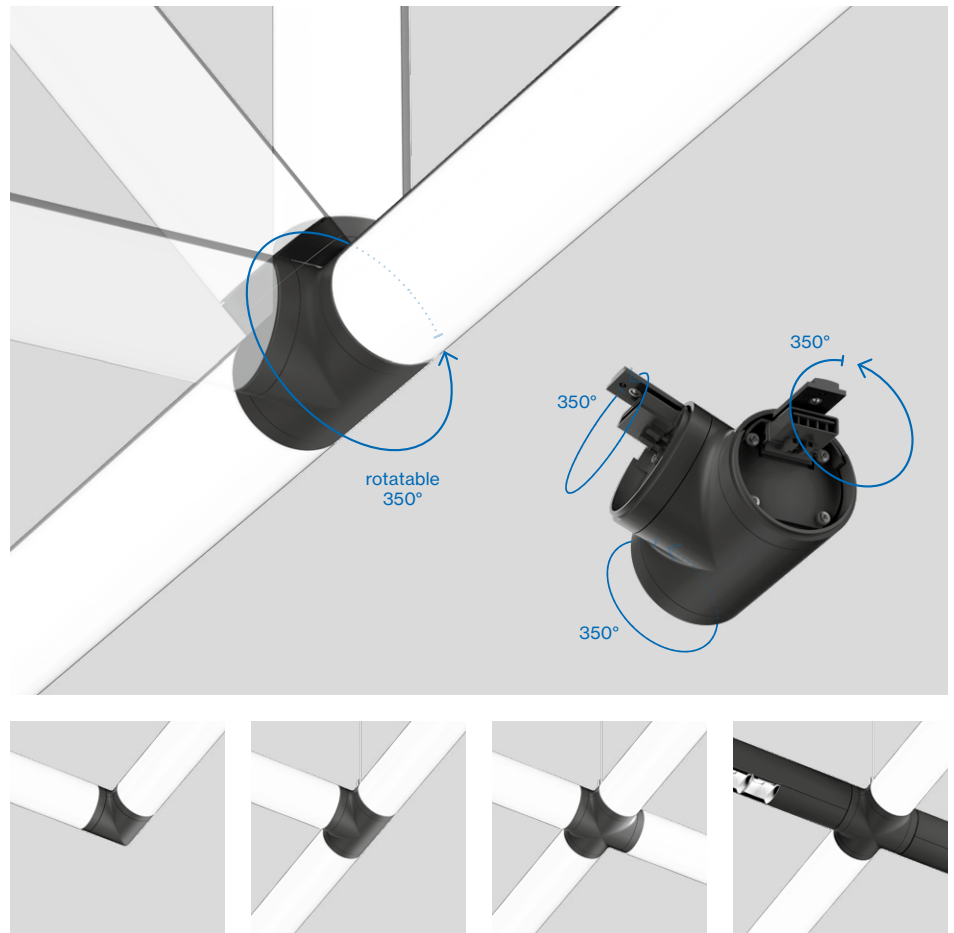

## Easy mounting

**EN** CONEX system luminaires are electrically and mechanically connected by a simple plug-in connection. This makes the installation of a complex lighting system simple, quick, and straightforward.

**DE** CONEX Systemleuchten werden durch eine simple Steckverbindung elektrisch und mechanisch verbunden. Dadurch ist die Montage eines komplexen Lichtsystems denkbar einfach, rasch und unkompliziert durchführbar.

## 340° light distribution

**EN** With its 340° beam pattern and opal cover, TUBO System delivers homogeneous illumination as well as slight ceiling brightening. This makes the system luminaire perfect for places where pleasant ambient lighting is desired, such as reception areas, corridors, or foyers.

**DE** Durch ihre 340° Abstrahlcharakteristik und Opal-Abdeckung erzielt TUBO System eine homogene Beleuchtung sowie eine leichte Deckenaufhellung. Dadurch ist die Systemleuchte perfekt geeignet für Orte, an denen eine angenehme Grundausleuchtung gewünscht ist, wie Empfangsbereiche, Flure oder Foyers.

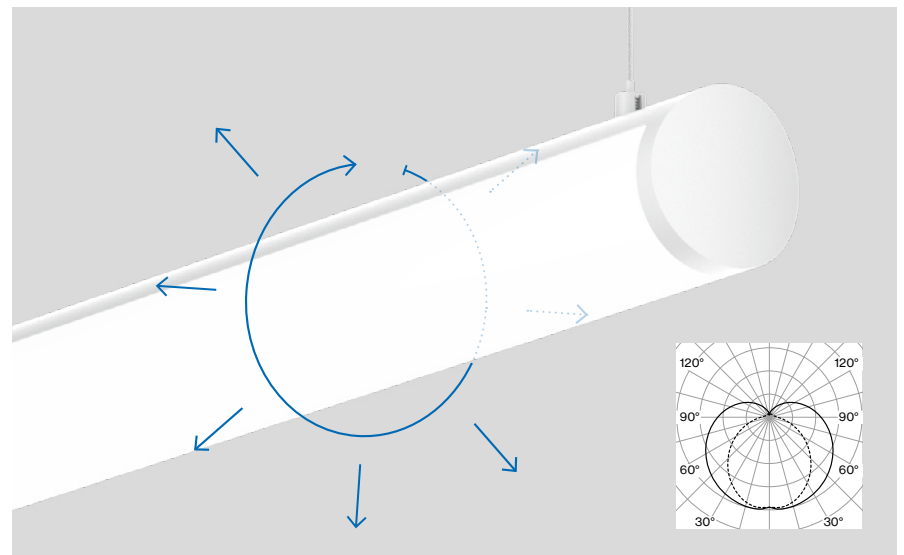

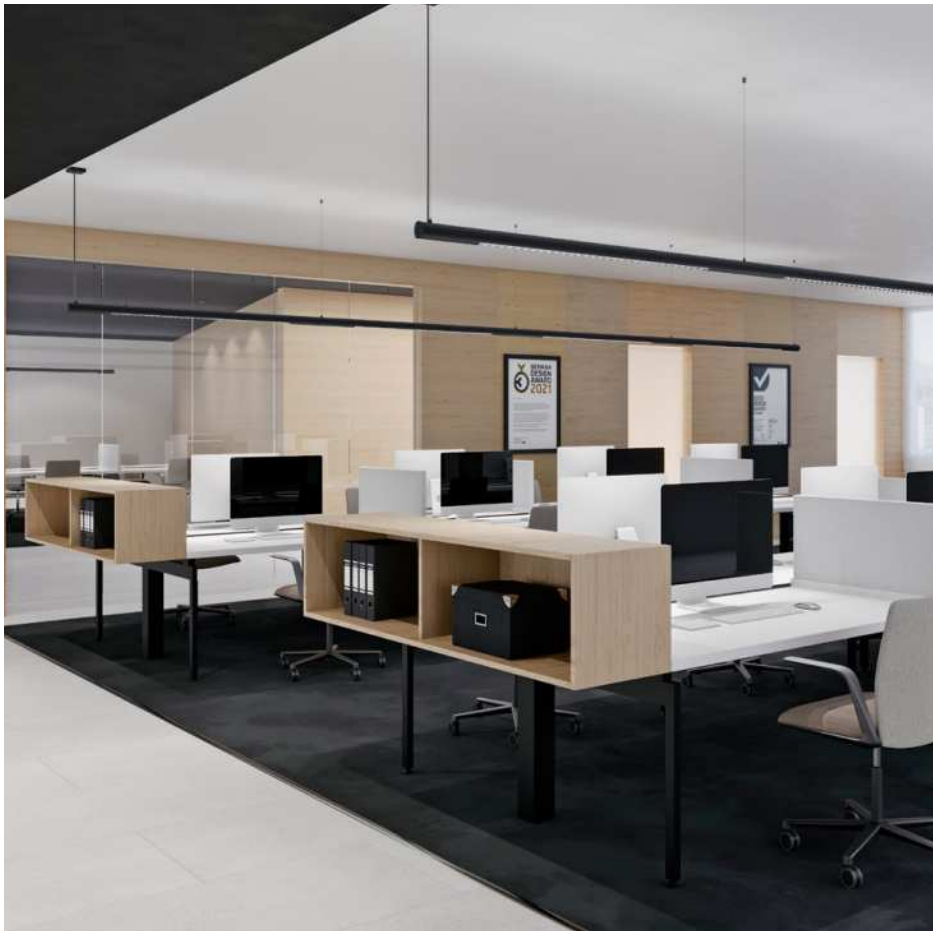

## Work-friendly light

**EN** As an office luminaire, SETA guarantees illumination that is compliant with workplace standards (up to  $UGR \leq 16$ ). Custom glare-free reflectors and the selected use of blind covers direct the light precisely to the work surface and reduce reflections. The direct/indirect version comes with special lens technology that distributes the indirect light component homogeneously and broadly towards the ceiling.

**DE** SETA als Office-Leuchte garantiert eine normgerechte Ausleuchtung von Arbeitsplätzen (bis zu  $UGR \leq 16$ ). Speziell entblendete Reflektoren und der gezielte Einsatz von Blind-Covers richten das Licht zielgenau auf die Arbeitsfläche und reduzieren Spiegelungen. Bei der direkt/indirekt Variante, verteilt eine spezielle Linsentechnik den sehr breit ausstrahlenden Indirektlichtanteil homogen an der Decke.

## Advanced sensor technology

**EN** Special sensors expand the product family SETA with smart lighting control and collection of insightful data. The ESSENTIAL sensor enables dynamic adjustment of the lighting to ambient brightness and room activity. The SENSE version also measures values such as temperature, air quality, humidity and noise level. These data not only provide important insights into the ambient conditions and use of rooms, but also support energy savings in the long term.

**DE** Spezielle Sensoren erweitern die Produktfamilie SETA um smarte Lichtsteuerung. Der ESSENTIAL-Sensor ermöglicht die dynamische Anpassung der Beleuchtung an Umgebungshelligkeit und Raumaktivität. Die SENSE-Variante misst außerdem Werte wie Temperatur, Luftqualität, Luftfeuchtigkeit und Geräuschpegel. Diese Daten liefern nicht nur wichtige Erkenntnisse über die Umgebungsbedingungen und Nutzung von Räumen, sondern unterstützen langfristig Energieeinsparungen.

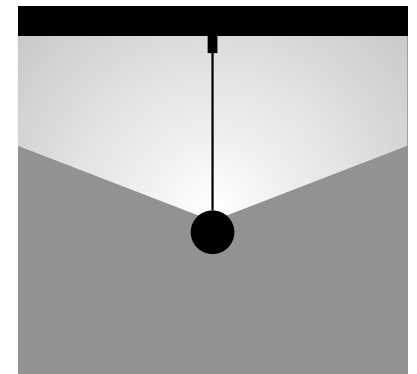

## Indirect version

**EN** SETA indirect stands for the minimalist design of the product family and expands it with an indirect luminaire that provides homogeneous ceiling lighting. This creates a pleasant room feeling and the possibility to illuminate ceiling patterns harmoniously.

**DE** Die SETA indirect steht für das minimalistische Design der Produktfamilie und erweitert diese um eine Indirekt-Leuchte, welche für eine homogene Deckenaufhellung sorgt. So entsteht ein angenehmes Raumgefühl und die Möglichkeit, Deckenmuster harmonisch zu beleuchten.



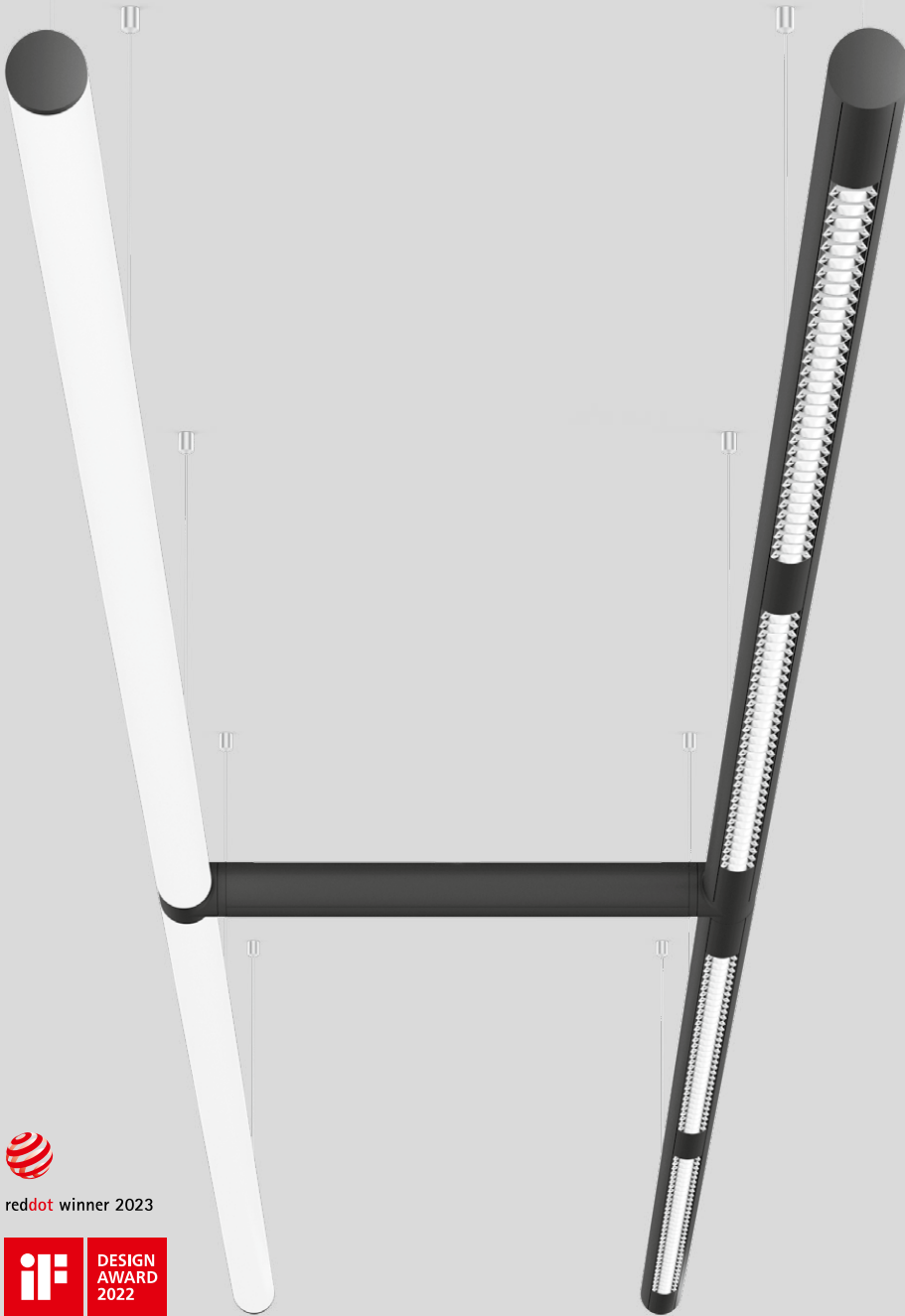

reddot winner 2023



## TUBO/SETA 60 CONEX system

surface / suspended

**EN** Cylindrical lighting system in aluminium; powder coated; ceiling surface mounting or suspended mounting; height adjustment without tools; with transparent feeder cable; electrical connection of the luminaires via plug/socket system; optionally connectors (L-, T- or X-shape); luminaire connection rotatable around its own axis, which means that any spatial angle can be realized; optionally cylindrical HPO (High Performance Opal) cover or high gloss reflector with faceted design; light control via high quality lens system for homogeneous illumination (HPO); direct, indirect or direct / indirect light distribution (reflector); indirect light component with integrated PCBs and high quality lens system for homog. ceiling illumination, separately controllable; energy-eff. LEDs - very good colour rendering

**DE** Zylindrisches Lichtsystem aus Aluminium; pulverbeschichtet; Deckenanbau oder abgehängte Montage; werkzeuglose Höhenverstellung; inkl. transp. Einspeiseleitung; elektrische Verbindung der Leuchten mittels Buchse/Stecker System; optionale Verbinder (L-, T- oder X-Form); Leuchtenverbindung um eigene Achse drehbar, dadurch beliebige Raumwinkel realisierbar; wahlweise zylindr. HPO (High Performance Opal) Abdeckung oder hochglänzender Reflektor mit Facettenoptik; Lichtlenkung mittels hochwertiger Linsenoptik für homogene Ausleuchtung (HPO); direkte, indirekte bzw. direkt / indirekte Abstrahlcharakteristik (Reflektor); Indirektlichtanteil mit eigenen Platinen u. hochwertiger Linsenoptik für homog. Deckenaufhellung, separat steuerbar; energieeff. LEDs - sehr gute Farbwiedergabe

### Quickinfo

3000K, 4000K  
 CRI ≥ 80, 3 SDCM  
 UGR ≤ 19 / 65° ≤ 3000 cd/m<sup>2</sup>  
 opal up to 3230 lm/m  
 up to 160 lm/W  
 L90 @ 50000h  
 DALI-2  
 opal, reflector (UGR ≤ 19)

### Types

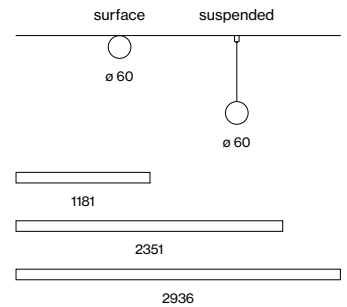

CONEX connector

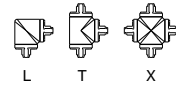

### Colours



### Light distributions

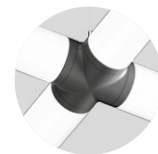
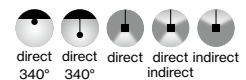

connector  
CONEX

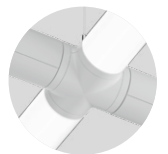

combinable with  
TUBO & SETA



up to 160 lm/W  
(high efficiency)



DIN EN 12464-1  
UGR ≤ 19

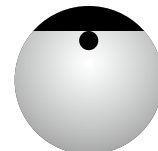

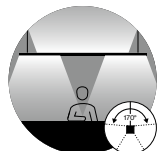

TUBO: direct  
340° uniform  
illumination



SETA: direct  
and 170° indirect  
illumination

## Order options

### THROUGH WIRE TYPE

standard 	2
CONEX L/T/X 	3

between two CONEX connectors  
one CONEX luminaire or blind channel  
is needed

### COLOUR TEMPERATURE

3000K	5
4000K	6

### CONTROL

DALI-2

### MATERIAL COLOUR

○ pure white RAL 9010	7
● jet black RAL 9005	8

### REFLECTOR COLOUR









✓ chrome	R
● dark chrome	B



## TUBO 60 surface/suspended



### OPAL 340° DIRECT



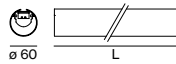





SYS. POWER	COLOUR TEMP.	LUM. FLUX	L (mm)	ORDER CODE
33 W	3000K	3560lm	1181	0 5 8 - 3 0  4  3  0
	4000K	3760lm		
66 W	3000K	7110lm	2351	0 5 8 - 3 0  8  3  0
	4000K	7530lm		
82 W	3000K	8890lm	2936	0 5 8 - 3 0  9  3  0
	4000K	9410lm		



## SETA 60 surface/suspended











### REFLECTOR DIRECT

SYS. POWER	COLOUR TEMP.	LUM. FLUX	L (mm)	ORDER CODE
19.3 W	3000K	2670lm	1181	0 5 8 - 4 0  4  3  ■
	4000K	3040lm		
45 W	3000K	6240lm	2351	0 5 8 - 4 0  8  3  ■
	4000K	7100lm		
58 W	3000K	8020lm	2936	0 5 8 - 4 0  9  3  ■
	4000K	9130lm		







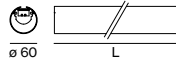



### REFLECTOR DIRECT/INDIRECT

SYS. POWER	COLOUR TEMP.	LUM. FLUX	L (mm)	ORDER CODE
45 W (2×DALI)	3000K	↓ 2670/± 3530lm	1181	0 5 8 - 4 1  4  3  ■
	4000K	↓ 3040/± 4010lm		
92 W (2×DALI)	3000K	↓ 6240/± 7050lm	2351	0 5 8 - 4 1  8  3  ■
	4000K	↓ 7100/± 8030lm		
116 W (2×DALI)	3000K	↓ 8020/± 8820lm	2936	0 5 8 - 4 1  9  3  ■
	4000K	↓ 9130/± 10000lm		











### INDIRECT

SYS. POWER	COLOUR TEMP.	LUM. FLUX	L (mm)	ORDER CODE
26.1 W	3000K	3530lm	1181	0 5 8 - 4 2  4  3  ■
	4000K	4010lm		
52 W	3000K	7050lm	2351	0 5 8 - 4 2  8  3  ■
	4000K	8030lm		
65 W	3000K	8820lm	2936	0 5 8 - 4 2  9  3  ■
	4000K	10000lm		



### BLIND CHANNEL incl. through wiring

L (mm)	ORDER CODE
585	0 5 8 - 4 9  2 0 3  ■
1185	0 5 8 - 4 9  4 0 3  ■
2351	0 5 8 - 4 9  8 0 3  ■
2936	0 5 8 - 4 9  9 0 3  ■

## Accessories

see next page

**Configuration example**

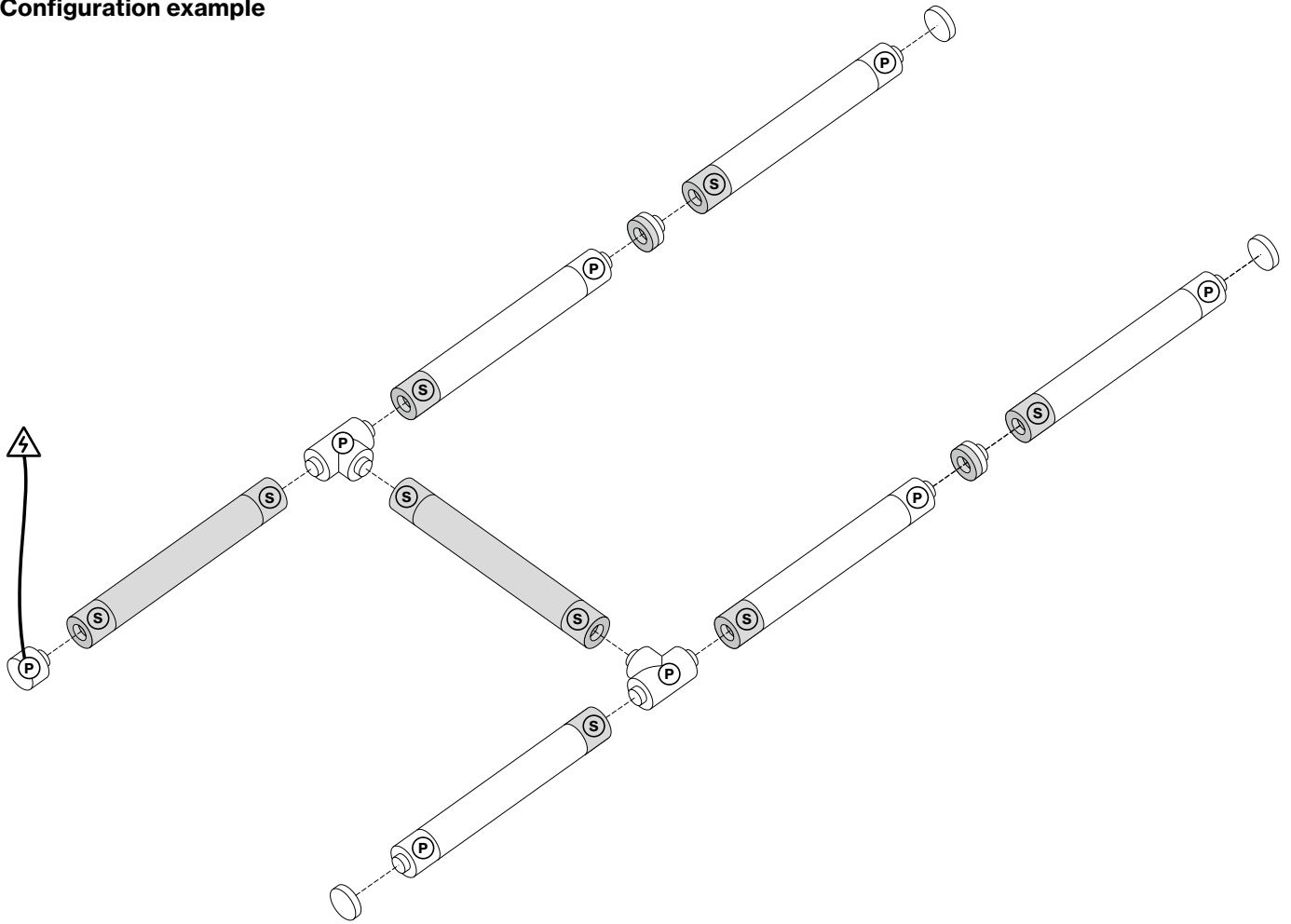

**Components**

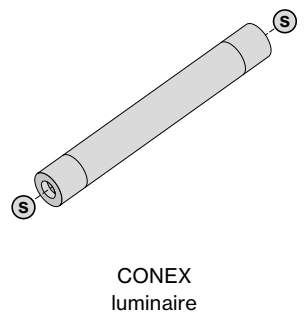
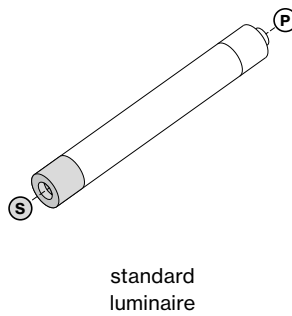
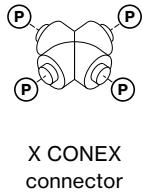
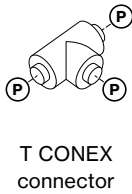
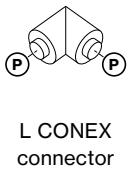
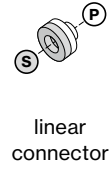
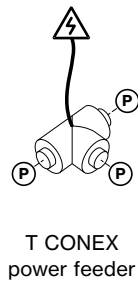
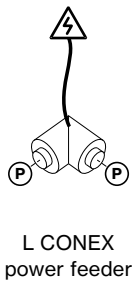
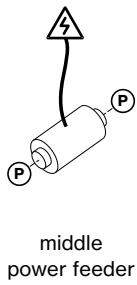
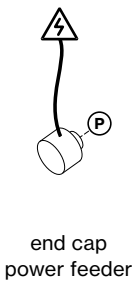



## Order options

MATERIAL COLOUR		<input checked="" type="checkbox"/>
○ pure white RAL 9010	7	
● jet black RAL 9005	8	

MATERIAL COLOUR		<input checked="" type="checkbox"/>
CABLE SUSPENSION		
↗ chrome	0	
● black	8	



## Accessories

### END CAP

TYPE	ORDER CODE
end cap	058-301001 <input checked="" type="checkbox"/>

### POWER FEEDER SURFACE

TYPE		ORDER CODE
end cap power feeder	Ⓟ	058-301021 <input checked="" type="checkbox"/>
middle power feeder*	ⓅⓅ	058-301121 <input checked="" type="checkbox"/>

\*incl. feeder cable 5×1.5mm<sup>2</sup>

### POWER FEEDER SUSPENDED incl. feeder cable 5×1.5mm<sup>2</sup>

TYPE	L (mm)	ORDER CODE
end cap power feeder	1500	058-301041 <input checked="" type="checkbox"/>
middle power feeder*	1500	058-301131 <input checked="" type="checkbox"/>
L CONEX power feeder**	1500	058-301873 <input checked="" type="checkbox"/>
T CONEX power feeder**	1500	058-301883 <input checked="" type="checkbox"/>

\*order cable suspension separately; \*\*order CONEX cable suspension separately

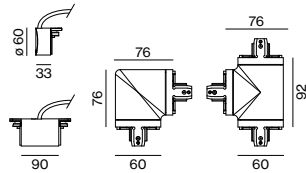

### LINEAR CONNECTOR

TYPE	ORDER CODE
linear connector mechanical	058-301311 <input checked="" type="checkbox"/>
linear connector mechanical & electrical	ⓅⓈ 058-301312 <input checked="" type="checkbox"/>

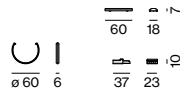

### LINEAR CONNECTOR SUSPENDED incl. cable suspension 1500mm

TYPE	L (mm)	ORDER CODE
linear connector mechanical	1500	058-301321 <input checked="" type="checkbox"/>
linear connector mech. & electr.	1500	ⓅⓈ 058-301322 <input checked="" type="checkbox"/>

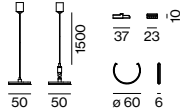

### CONEX CONNECTOR

TYPE	ORDER CODE
L CONEX connector mech. & electr.	ⓅⓅ 058-301872 <input checked="" type="checkbox"/>
T CONEX connector mech. & electr.	ⓅⓅⓅ 058-301882 <input checked="" type="checkbox"/>
X CONEX connector mech. & electr.	ⓅⓅⓅⓅ 058-301892 <input checked="" type="checkbox"/>

order CONEX cable suspension separately

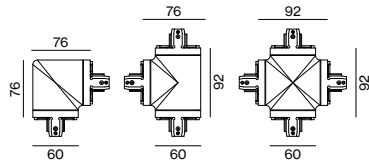

### MOUNTING SET

TYPE	L (mm)	ORDER CODE
ceiling mounting set	75	058-301411 <input checked="" type="checkbox"/>
cable suspension	1500	058-301421 <input checked="" type="checkbox"/>
cable suspension angular max. 60°	1500	058-301431 <input checked="" type="checkbox"/>
CONEX cable suspension	1500	058-301811 <input checked="" type="checkbox"/>

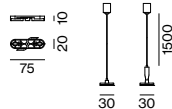

### CANOPY

TYPE	Ø-H (mm)	ORDER CODE
canopy	90-22	005-260003 <input checked="" type="checkbox"/>

for electrical system configuration see luminaire data sheet at xal.com

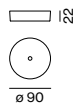

### SENSOR DALI-2

TYPE	ORDER CODE
ESSENTIAL (brightness & presence)	ⓅⓅ 058-301911 <input checked="" type="checkbox"/>
SENSE (brightness, presence, temperature, sound pressure, humidity, CO <sub>2</sub> )	ⓅⓅ 058-301921 <input checked="" type="checkbox"/>

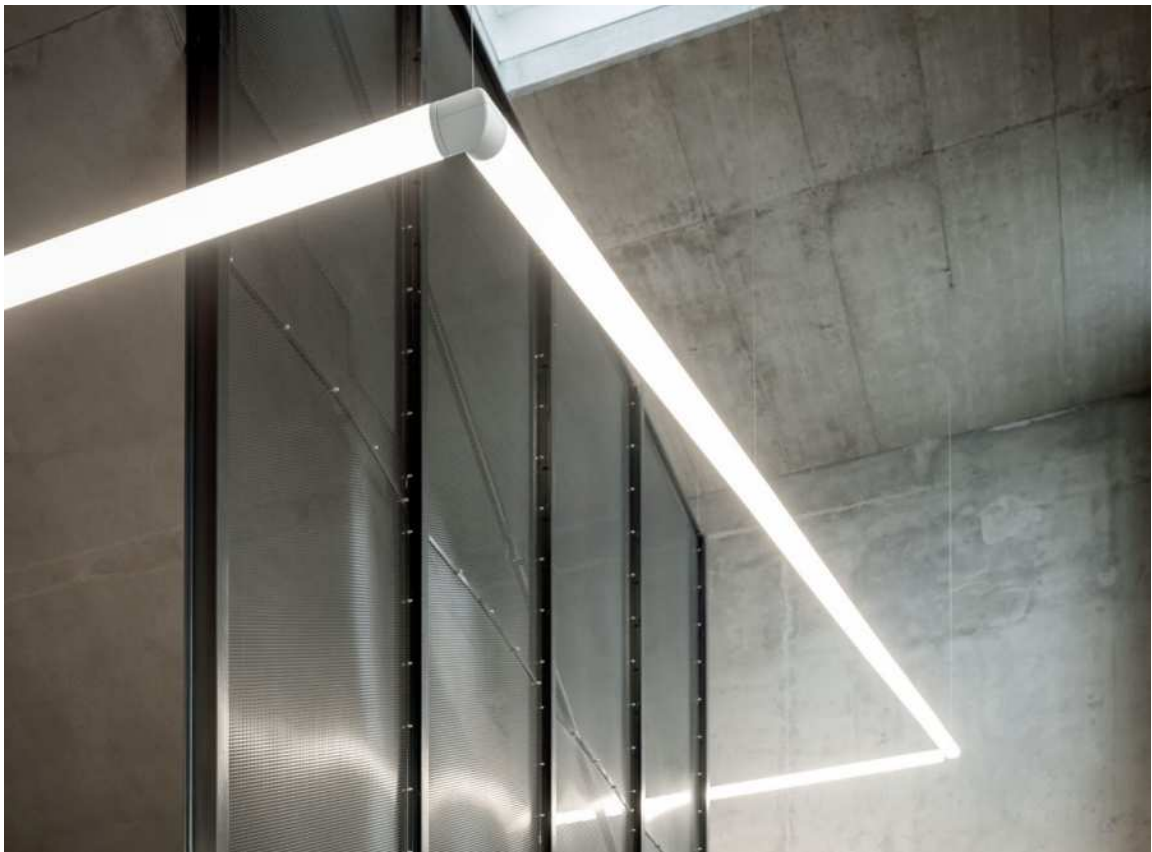
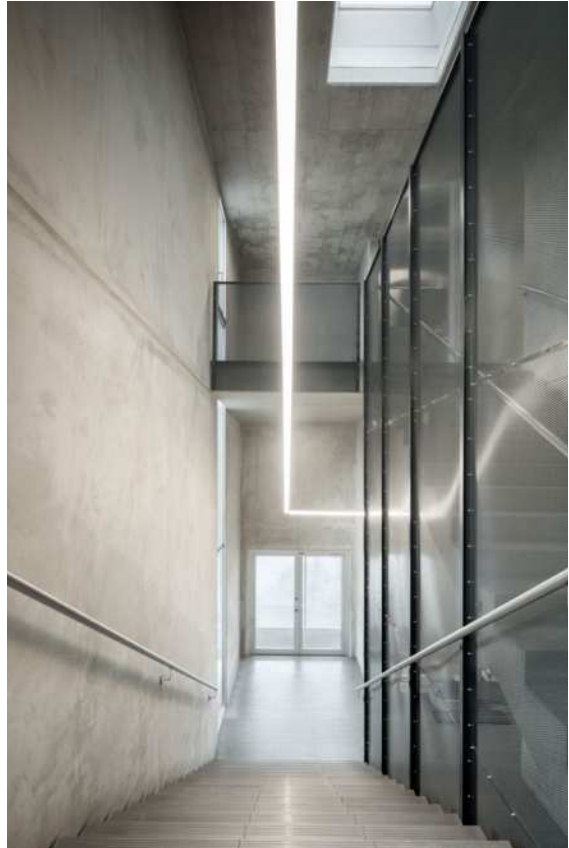

**XAL Headquarters** Graz, AT



# Discreet perfection



# MITA

**EN** MITA combines high performance with a slim design language and its wide range of applications is impressive. The product family is available as recessed or surface-mounted luminaire in a round or square design as well as suspended version. All the versions of the luminaire have special reflectors for the best screen-compatible work lighting – perfect for use in offices or meeting rooms. The product family is available in the light colours 3000 K, 4000 K, or Tunable White. Optionally, the luminaire can be equipped with a presence and brightness sensor.

**DE** MITA vereint Leistungsstärke mit schlanker Formensprache und besticht durch vielfältige Einsatzmöglichkeiten. Die Produktfamilie ist als Einbau- oder Anbauleuchte in runder oder quadratischer Ausführung sowie als abgehängte Variante verfügbar. In allen Ausführungen verfügt die Leuchte über spezielle Reflektoren für bestes, bildschirmtaugliches Arbeitslicht – perfekt für den Einsatz in Büros oder Meetingräumen. Die Produktfamilie ist in den Lichtfarben 3000 K, 4000 K oder als Tunable White Option erhältlich. Optional kann die Leuchte mit einem Anwesenheits- und Helligkeitssensor ausgestattet werden.

## Types

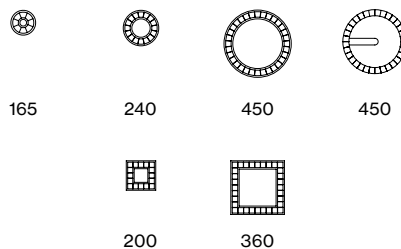

## Mountings

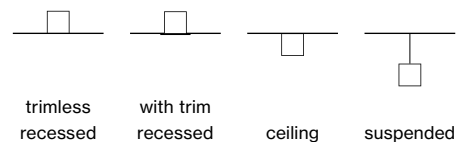

## Light distributions

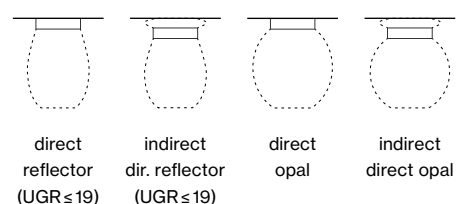





## Variety

**EN** MITA is characterised by an elegant design language with maximum efficiency and versatile application possibilities. The MITA product family is available as a recessed or surface-mounted luminaire in round and square versions, as well as a suspended variant. For a uniform ceiling appearance, the cover can simply be attached magnetically and is available as a reflector or opal cover.

**DE** MITA zeugt von eleganter Formensprache bei höchster Effizienz und besticht darüber hinaus durch ihre vielseitigen Einsatzmöglichkeiten. Die MITA Produktfamilie ist als Einbau- oder Anbauleuchte in runder sowie quadratischer Ausführung oder als abgehängte Variante erhältlich. Zudem ist MITA als Reflektor- oder Opal-Cover-Variante verfügbar. Für ein einheitliches Deckenbild kann die Abdeckung einfach magnetisch befestigt werden.

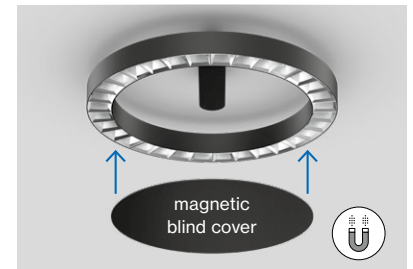



## Advanced sensor technology

**EN** Special sensors expand the MITA product family with smart lighting control and collection of insightful data. The ESSENTIAL sensor enables dynamic adjustment of the lighting to ambient brightness and room activity. The SENSE sensor also measures values such as temperature, air quality, humidity and noise level. These data not only provide important insights into the ambient conditions and use of rooms, but also support energy savings in the long term.

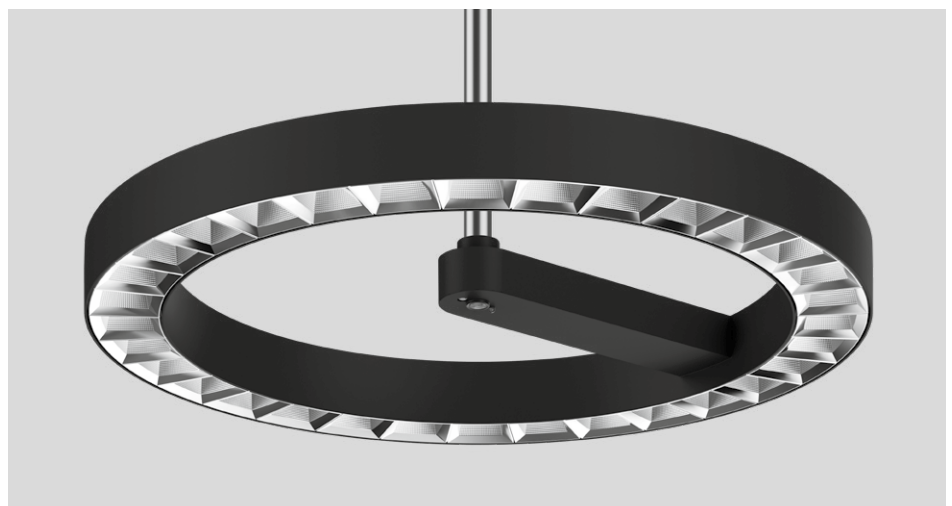





**DE** Spezielle Sensoren erweitern die MITA Produktfamilie um smarte Lichtsteuerung. Der ESSENTIAL Sensor ermöglicht die dynamische Anpassung der Beleuchtung an Umgebungshelligkeit und Raumaktivität. Der SENSE Sensor misst außerdem Werte wie Temperatur, Luftqualität, Luftfeuchtigkeit und Geräuschpegel. Diese Daten liefern nicht nur wichtige Erkenntnisse über die Umgebungsbedingungen und Nutzung von Räumen, sondern unterstützen langfristig Energieeinsparungen.



### ESSENTIAL sensor

-  brightness
-  presence

### SENSE sensor

-  brightness
-  presence
-  temperature
-  humidity
-  sound pressure
-  CO<sub>2</sub>



## Light distribution

**EN** As an office luminaire, MITA guarantees the best possible working light. Special, glare-reduced reflectors direct the light precisely onto the work surface and reduce reflections. The opal cover ensures homogeneous room illumination. With the direct/indirect power version of the suspended luminaire, the indirect light component has a very wide beam and distributes the light evenly across the ceiling. The direct/indirect soft light component of the surface-mounted version produces a gentle and light ceiling illumination, making the luminaire appear to almost float.

**DE** Als Office-Leuchte garantiert MITA bestes Arbeitslicht. Speziell entblendete Reflektoren richten das Licht zielgenau auf die Arbeitsfläche und reduzieren Spiegelungen. Mit der Opal Abdeckung ist eine homogene Raumausleuchtung gegeben. Bei der direkt/indirekt power Variante der abgehängten Leuchte ist der Indirektlichtanteil sehr breit ausstrahlend und verteilt das Licht gleichmäßig an der Decke. Der direkt/indirekt soft Lichtanteil der Anbauvariante bewirkt eine sanfte und leichte Deckenaufhellung und lässt die Leuchte optisch beinahe schweben.

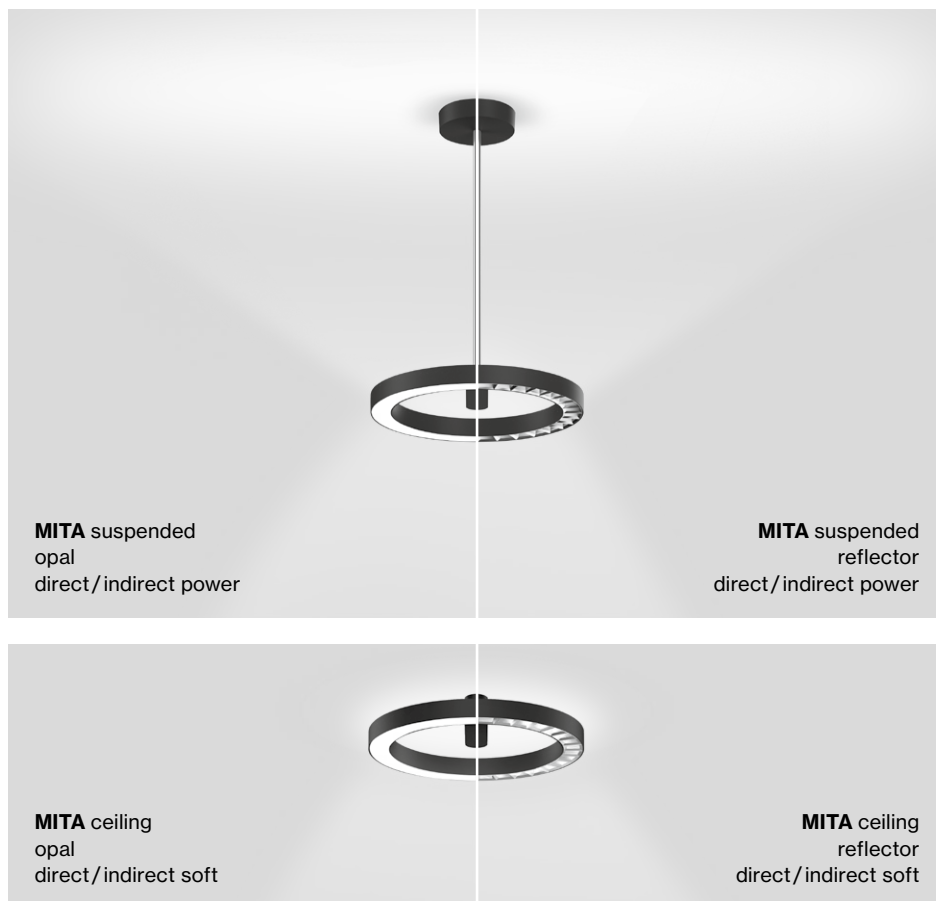

## Discreet accentuation

**EN** MITA sets discreet accents for a pleasant room atmosphere. The product is available in black or white, and with or without a cover. The magnetic cover attaches easily and the indirect component provides gentle and light ceiling brightening.

**DE** MITA ceiling setzt diskrete Akzente für eine angenehme Raum Atmosphäre. Sie ist erhältlich in Schwarz oder Weiß und wahlweise mit Abdeckung. Das Cover ist einfach magnetisch zu befestigen. Der Indirektanteil bewirkt eine sanfte und leichte Deckenaufhellung und lässt die Leuchte optisch beinahe schweben.

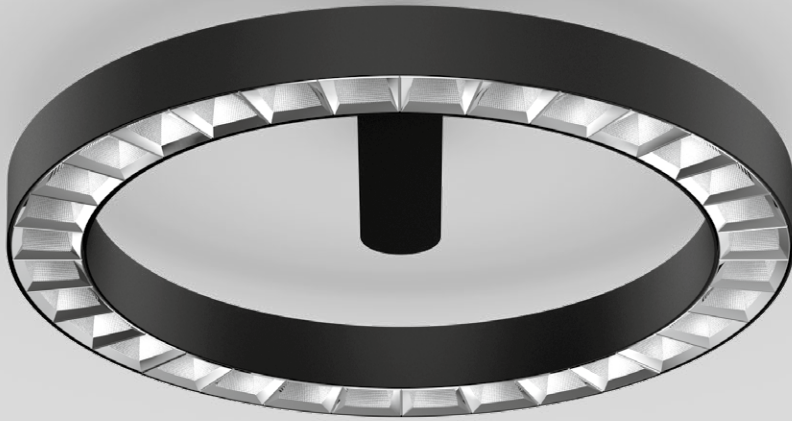

## MITA circle

ceiling

**EN** Ring shaped luminaire housing in die-cast aluminium; extremely slim design; surface powder coated; luminaire housing set away from ceiling; electronic operating unit installed in the surface mounted housing; surface mounted housing aligned from the ring to the center; optional: blind cover to cover the cut-out, held by magnet, available as an accessory; high-gloss reflector with faceted design; HPO (High Performance Opal) cover for uniform illumination; either with direct or direct/indirect light distribution; energy-efficient LEDs with very good colour rendering

**DE** Ringförmiger Leuchtenkörper aus Aluminiumdruckguss; extrem schlanke Bauform; Oberfläche pulverbeschichtet; Leuchtenkörper von der Decke abgesetzt; elektronisches Betriebsgerät im Anbauehäuse verbaut; Anbauehäuse vom Ring ins Zentrum ausgerichtet; optional: Blindabdeckung, mittels Magnet im Innenausschnitt befestigt, als Zubehör erhältlich; hochglänzender Reflektor mit Facettenoptik; HPO (High Performance Opal) Abdeckung für homogene Ausleuchtung; wahlweise mit direkter bzw. direkt/indirekter Abstrahlcharakteristik; energieeffiziente LEDs mit sehr guter Farbwiedergabe

### Quickinfo

3000 K, 4000 K  
 CRI ≥ 80, 3 SDCM  
 UGR ≤ 19 / 65° ≤ 1500 cd/m<sup>2</sup>  
 up to 158 lm/W  
 L90 @ 50 000h  
 DALI-2, DALI-2 sensor  
 reflector (UGR ≤ 19), opal

### Types

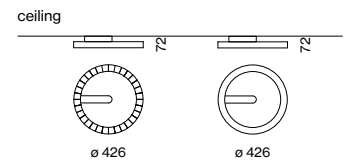

### Colours



### Light distributions

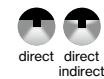

dark chrome  
reflector option



up to 158 lm/W  
(high efficiency)

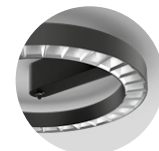

sensor version  
available



version with  
opal cover



magnetic  
blind cover



DIN EN 12464-1  
UGR ≤ 19

### Order options

COLOUR TEMPERATURE	
3000K	5
4000K	6

CONTROL	
DALI-2	3
DALI-2 ESSENTIAL sensor (brightness & presence)	B
DALI-2 SENSE sensor (brightness, presence, temp., sound pressure, humidity, CO <sub>2</sub> )	P

MATERIAL COLOUR	
○ traffic white RAL 9016	7
● jet black RAL 9005	8

REFLECTOR COLOUR	
✓ chrome	R
● dark chrome	B

LIGHT OPTIC COVER	
reflector (UGR ≤ 19)	
opal	

### Options on request

COLOUR RENDERING INDEX	
CRI ≥ 90	

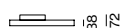
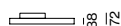

### MITA circle 450 ceiling



#### REFLECTOR DIRECT

SYSTEM POWER	COLOUR TEMP.	LUMINOUS FLUX	ORDER CODE
30 W	3000K	4210lm	0 7 4 - 7 5 1 1
	4000K	4790lm	
40 W	3000K	5470lm	0 7 4 - 7 5 2 1
	4000K	6230lm	

#### OPAL DIRECT

SYSTEM POWER	COLOUR TEMP.	LUMINOUS FLUX	ORDER CODE
24.9 W	3000K	2770lm	0 7 4 - 7 5 1 1
	4000K	3150lm	



#### REFLECTOR DIRECT / INDIRECT SOFT

SYSTEM POWER	COLOUR TEMP.	LUMINOUS FLUX	ORDER CODE
30 W	3000K	↓ 4220 / ± 72lm	0 7 4 - 7 5 3 1
	4000K	↓ 4800 / ± 82lm	
40 W	3000K	↓ 5490 / ± 94lm	0 7 4 - 7 5 6 1
	4000K	↓ 6240 / ± 107lm	

#### OPAL DIRECT / INDIRECT SOFT

SYSTEM POWER	COLOUR TEMP.	LUMINOUS FLUX	ORDER CODE
24.9 W	3000K	↓ 2700 / ± 136lm	0 7 4 - 7 5 3 1
	4000K	↓ 3080 / ± 155lm	

### Accessories

#### BLIND COVER

TYPE	ORDER CODE
MITA circle 450 ceiling	0 7 4 - 8 9 1 1 6 2
MITA circle 450 ceiling sensor	0 7 4 - 8 9 1 1 6 3

### Light distribution

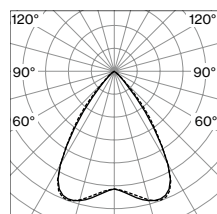

reflector (UGR ≤ 19)  
direct

LUMINOUS FLUX value calculated for  
CRI ≥ 80, colour white, reflector chrome

**Meeting room**  
Visualisation







**Hallway**  
Visualisation









## MITA circle

suspended

**EN** Ring shaped luminaire housing in die-cast aluminium; extremely slim design; surface powder coated; suspended; with height adjustable rod suspension (chrome), feed in rod; electronic operating unit installed in the canopy; optional: blind cover to cover the cut-out, held by magnet, available as an accessory; high gloss reflector with faceted design; HPO (High Performance Opal) cover for uniform illumination; either with direct or direct/indirect light distribution; energy-efficient LEDs with very good colour rendering

**DE** Ringförmiger Leuchtenkörper aus Aluminiumdruckguss; extrem schlanke Bauform; Oberfläche pulverbeschichtet; abgependelt; mit kürzbarer Pendelrohrabhangung (chrom), Einspeiseleitung in Pendelrohr; elektronisches Betriebsgerat im Baldachin verbaut; optional: Blindabdeckung, mittels Magnet im Innenausschnitt befestigt, als Zubehor erhaltlich; hochglanzender Reflektor mit Facettenoptik; HPO (High Performance Opal) Abdeckung fur homogene Ausleuchtung; wahlweise mit direkter bzw. direkt/indirekter Abstrahlcharakteristik; energieeffiziente LEDs mit sehr guter Farbwiedergabe

### Quickinfo

3000 K, 4000 K  
 CRI  $\geq$  80, 3 SDCM  
 UGR  $\leq$  19 /  $65^\circ \leq 1500$  cd/m<sup>2</sup>  
 up to 160 lm/W  
 L90 @ 50 000h  
 DALI-2, DALI-2 sensor  
 reflector (UGR  $\leq$  19), opal

### Types

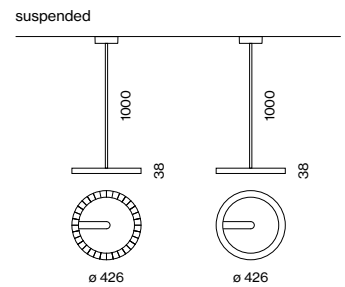

### Colours



### Light distributions

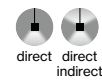

dark chrome  
reflector option



up to 160 lm/W  
(high efficiency)

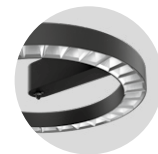

sensor version  
available



version with  
opal cover



magnetic  
blind cover



DIN EN 12464-1  
UGR  $\leq$  19

## Order options

### SUSPENSION

rod 1000 mm

### COLOUR TEMPERATURE

3000K	5
4000K	6

### CONTROL

DALI-2	3
DALI-2 ESSENTIAL sensor (brightness & presence)	B
DALI-2 SENSE sensor (brightness, presence, temp., sound pressure, humidity, CO <sub>2</sub> )	P

### MATERIAL COLOUR

○ traffic white RAL 9016	7
● jet black RAL 9005	8

### REFLECTOR COLOUR

↗ chrome	R
● dark chrome	B

### LIGHT OPTIC COVER

reflector (UGR ≤ 19)  
opal

## Options on request

### SUSPENSION

rod 1000 mm white  
rod 1000 mm black

### COLOUR RENDERING INDEX

CRI ≥ 90

### COLOUR TEMPERATURE

tunable white 2700–6500K

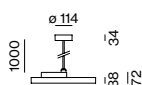
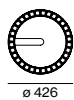
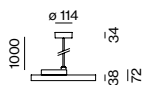
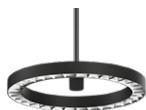

## MITA circle 450 suspended



UGR  
≤ 19

cd/m<sup>2</sup>  
≤ 1500

DALI  
1ADDR.

220-240V

X-PERT

X-PERT

### REFLECTOR DIRECT

SYSTEM POWER	COLOUR TEMP.	LUMINOUS FLUX	ORDER CODE
30W	3000K	4210lm	074-7611
	4000K	4790lm	
41W	3000K	5470lm	074-7621
	4000K	6230lm	

### OPAL DIRECT

SYSTEM POWER	COLOUR TEMP.	LUMINOUS FLUX	ORDER CODE
25.1W	3000K	2770lm	074-7611
	4000K	3060lm	



UGR  
≤ 19

cd/m<sup>2</sup>  
≤ 1500

DALI  
1ADDR.

220-240V

X-PERT

X-PERT

### REFLECTOR DIRECT / INDIRECT POWER

SYSTEM POWER	COLOUR TEMP.	LUMINOUS FLUX	ORDER CODE
58W	3000K	↓ 4030 / ↑ 3780lm	074-7651
	4000K	↓ 4600 / ↑ 4310lm	

### OPAL DIRECT / INDIRECT POWER

SYSTEM POWER	COLOUR TEMP.	LUMINOUS FLUX	ORDER CODE
58W	3000K	↓ 3140 / ↑ 3780lm	074-7651
	4000K	↓ 3570 / ↑ 4310lm	

## Accessories

### BLIND COVER

TYPE	ORDER CODE
MITA circle 450 suspended	074-891162
MITA circle 450 suspended sensor	074-891163

**ALLPLAN Österreich GmbH**  
Graz, AT







# Hidden talent





# SPIO

**EN** Round, recessed SPIO spotlights bring special lighting to your rooms. The luminaire provides an impressive lighting effect, trimless or with a trim. The housing can be painted over, allowing the spotlight to blend seamlessly into the ceiling. The small light aperture of 10 mm makes the SPIO itself appear almost hidden – but the equally effective and calm overall impression is anything but invisible. The round, recessed spotlight is available with beam angles of 35° or 44° and can be rotated 360° in the housing and pivoted 30° in all directions. In addition, SPIO 20 is available with Wallwasher Floor optic, which creates a uniform wall illumination. These different lighting options mean that versatile designs for interiors are possible. SPIO is available in the light colours 2700 K, 3000 K, and 4000 K.

**DE** Mit den runden SPIO Einbaustrahlern bringen Sie eine besondere Beleuchtung in Ihre Räume. Die Leuchte sorgt für eine beeindruckende Lichtwirkung, randlos oder mit umlaufendem Rand. Das Gehäuse kann einfach überstrichen werden, wodurch sich der Strahler nahtlos ins Deckenbild einfügt. Die geringe Lichtaustrittsöffnung von 10 mm lässt SPIO selbst beinahe verborgen erscheinen – der effektvolle und ruhige Gesamteindruck ist jedoch alles andere als unsichtbar. Der runde Einbau-Spot ist mit den Ausstrahlwinkel von 35° oder 44° verfügbar und ist im Gehäuse um 360° drehbar und in alle Richtungen 30° schwenkbar. Zudem ist SPIO 20 mit Wallwasher Floor Optik verfügbar, wodurch eine gleichmäßige Wandaufhellung entsteht. Dadurch ergibt sich eine vielseitige Raumgestaltung mit unterschiedlichen Beleuchtungsmöglichkeiten. SPIO ist in den Lichtfarben 2700 K, 3000 K und 4000 K erhältlich.

## Types



20

60

## Mountings

trimless  
recessedwith trim  
recessed

## Light distributions

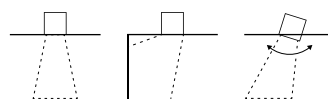

downlight

floor  
wallwasher

spotlight

## High-efficiency lens

**EN** Large light output – almost unnoticed. SPIO has a special LFO lens, which is mounted at an exact distance from the light-emission surface, thus ensuring that no light beam appears on the inner surface of the housing. This reduces the light-emission surface, and SPIO illuminates the room almost unnoticed.

**DE** Großer Lichtoutput – nahezu unbemerkt. SPIO verfügt über eine spezielle LFO Linse, welche in einem exakten Abstand zur Lichtaustrittsfläche montiert wird. Dieser ist so bemessen, dass kein Lichtstrahl an der Innenfläche des Gehäuses auftritt. Dadurch wird die Lichtaustrittsfläche reduziert und SPIO beleuchtet den Raum nahezu unbemerkt.

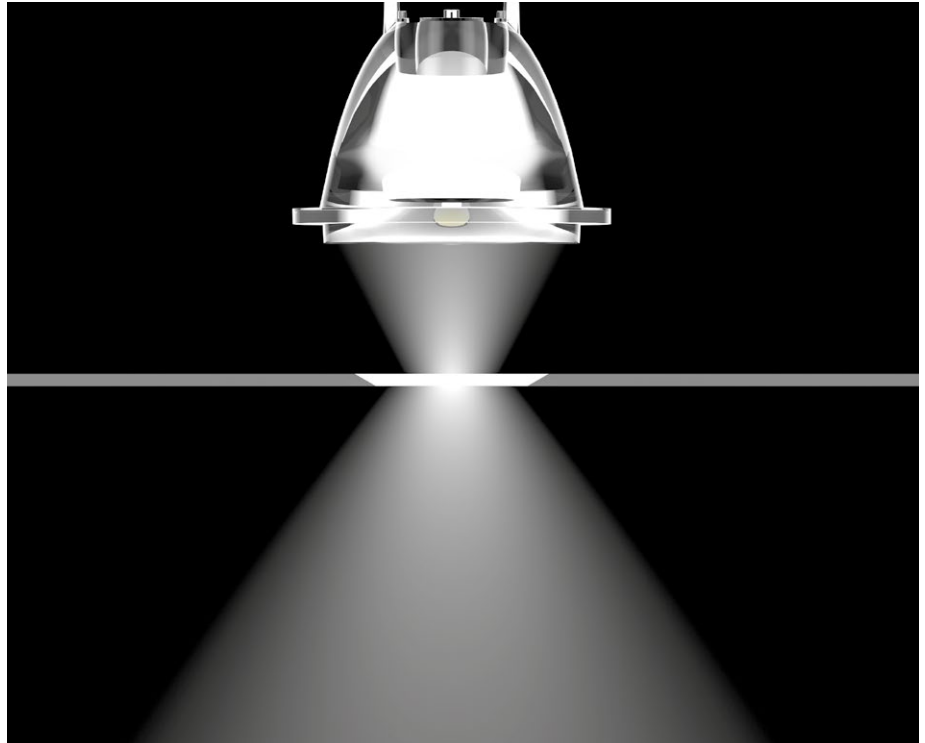

## Homogeneous appearance

**EN** SPIO is the right choice for a uniform ceiling appearance. Thanks to its extremely small light aperture of 10 mm, the recessed spotlight appears almost invisible. The effective lighting is rounded off by its minimalist design language.

**DE** Für ein einheitliches Deckenbild ist SPIO die richtige Wahl. Dank seiner ausgesprochen geringen Lichtaustrittsöffnung von 10 mm ist der Einbaustrahler beinahe unsichtbar. Die effektive Lichtwirkung wird abgerundet durch seine minimalistische Formensprache.

## Light distribution

**EN** Despite its small emission surface, the recessed spotlight achieves a beam angle of either 35° or 44°. SPIO 20 is also available with Wallwasher Floor optic, which creates a homogeneous wall brightening effect. SPIO thus provides glare-free light and skilfully stages objects.

**DE** Trotz seiner geringen Austrittsfläche erreicht der Einbaustrahler einen Ausstrahlwinkel von wahlweise 35° oder 44°. SPIO 20 ist zudem mit Wallwasher Floor Optik erhältlich, wodurch eine homogene Wandaufhellung entsteht. Dadurch gibt SPIO blendfreies Licht und setzt Objekte gekonnt in Szene.

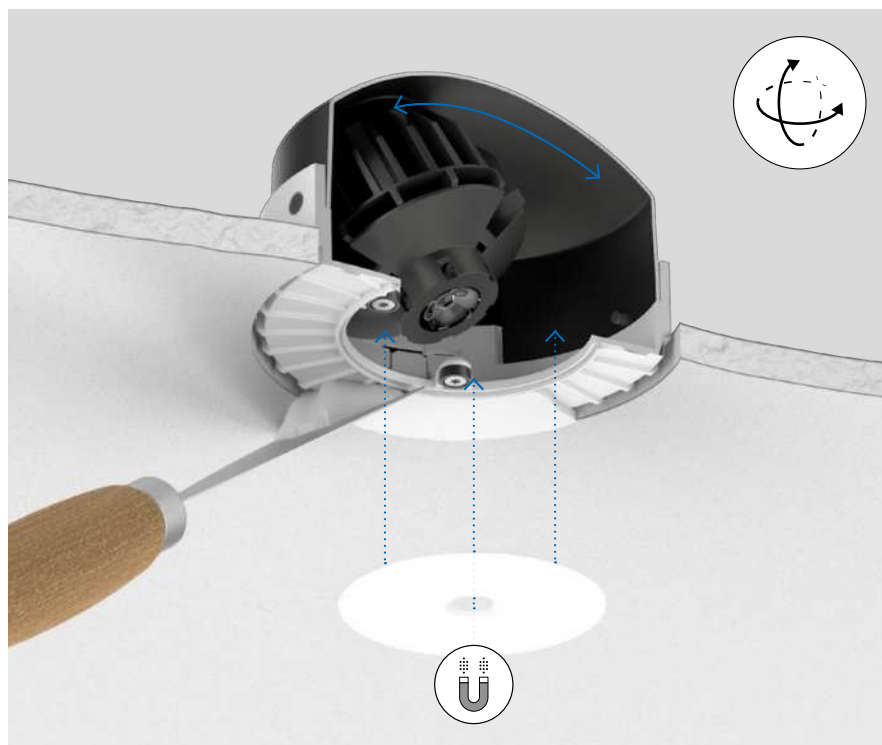
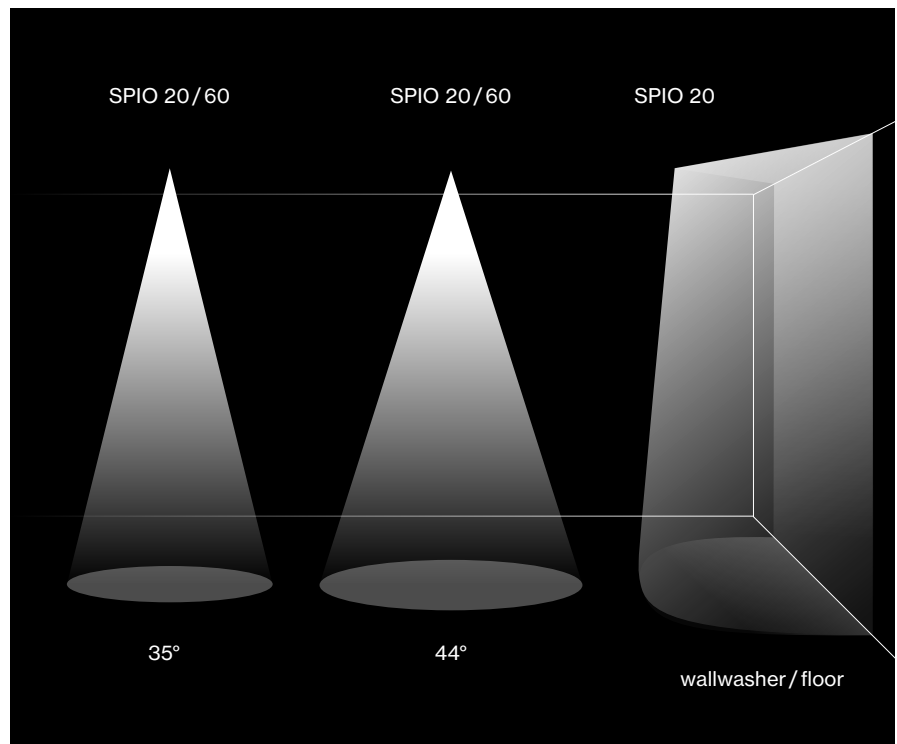

## Precise light adjustment

**EN** The adjustable version of SPIO 60, patent pending, can be moved in all directions thanks to a magnetic plate. The spotlight can thus both be rotated 360° and pivoted up to 30° in all directions. As a result, it offers the greatest flexibility in directing and guiding light exactly where it is desired.

**DE** Die zum Patent angemeldete adjustable Version von SPIO 60 kann aufgrund eines magnetischen Strahlerkopfes in alle Richtungen bewegt werden. Der Strahler kann zudem nicht nur um 360° gedreht, sondern auch um bis zu 30° in alle Richtungen geschwenkt werden. Dadurch bietet er größte Flexibilität in der Ausrichtung und Lenkung des Lichtes genau dorthin, wo es gewünscht ist.

## Smooth and invisible

**EN** The trimless SPIO 60 version can easily be maintained and adjusted thanks to its magnetic cover. The spotlight is completely fitted into a plasterboard ceiling. The recessed housing and ceiling can subsequently be painted over. The spots thus appear "invisible", creating a homogeneous, effective overall impression.

**DE** Die randlose Variante von SPIO 60 ist durch die magnetische Abdeckplatte einfach zu warten und zu adjustieren. Der Strahler wird vollkommen in einer Gipskartondecke verbaut. Anschließend kann das Einbaugeschäule gemeinsam mit der Zimmerdecke überstrichen werden. Die Spots wirken dadurch „unsichtbar“ – es entsteht ein homogener wirkungsvoller Gesamteindruck.



## SPIO 20

recessed

**EN** Round recessed spotlight in die-cast aluminium; installation without tools in mounting set with ball catch system or using snap spring closure; special mounting tool for easy installation of the trimless housing available as an accessory; for trimless installation in plasterboard ceilings; paintable light inset; shadow joint between light inset and mounting set optionally fillable; or with trim; with optional high quality lens system with precise radiation characteristic; or high quality, aluminium, vapour deposition coated reflector with faceted design; precise radiation characteristics with different beam angles; uncluttered ceiling look through recessed lighting level; reduced light-emitting surface - only  $\varnothing 10$  mm (DOWNLIGHT) or  $\varnothing 13$  mm (WALLWASHER/FLOOR); no multiple shadows; energy-eff. LEDs - very good colour rendering

**DE** Runder Einbaustrahler aus Aluminiumdruckguss; werkzeuglose Montage im Montageset durch Kugelschnappsystem bzw. Schnappfederverschluss; spezielles Montagewerkzeug zur einfachen Installation des randlosen Gehäuses als Zubehör erhältlich; für randlosen Einbau in Gipskartondecken; überstreichbarer Lichteinsatz; Schattenfuge zwischen Lichteinsatz und Montageset optional verspachtelbar; oder mit umlaufendem Rand; wahlweise mit hochwertiger Linsenoptik mit präziser Abstrahlcharakteristik; oder hochwertiger, aluminiumbedampfter Reflektor mit Facettenoptik; präzise Abstrahlcharakteristik mit verschiedenen Ausstrahlwinkeln; ruhiges Deckenbild durch zurückversetzte Leuchtenebene; reduzierte Lichtaustrittsfläche - nur  $\varnothing 10$  mm (DOWNLIGHT) bzw.  $\varnothing 13$  mm (WALLWASHER/FLOOR); keine Mehrfachschatten; energieeff. LEDs - sehr gute Farbwiedergabe

### Quickinfo

2700 K, 3000 K  
CRI  $\geq 90$ , 3 SDCM  
up to 70 lm/W  
L95 @ 50000h  
non DIM, DALI-2

### Types



### Colours



### Light distributions



version with trim available



10 mm light output area



trimless installation

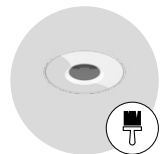

paintable cover

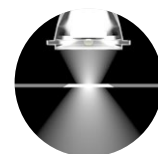

LFO lens technology



wallwasher floor

## Order options

<b>COLOUR TEMPERATURE</b>	☼☼
2700 K	4
3000 K	5

<b>MATERIAL COLOUR</b>	☑
○ traffic white RAL 9016	7
● jet black RAL 9005	8

<b>REFLECTOR COLOUR</b>	
● jet black RAL 9005	
paintable cover	

<b>BEAM ANGLE</b>	▲
flood 35°	F
wide flood 44°	W

## Options on request

<b>COLOUR RENDERING INDEX</b>	
CRI ≥ 95, 2 SDCM	

<b>COLOUR TEMPERATURE</b>	
4000 K	

<b>CONCRETE HOUSING</b>	
primed concrete ceiling	
exposed concrete ceiling	

<b>REFLECTOR COLOUR</b>	
○ traffic white* RAL9016	
*only for wallwasher / floor	

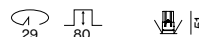
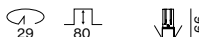

## SPIO 20 downlight



### DOWNLIGHT TRIMLESS

<b>INSET POWER</b>	<b>LUMINOUS FLUX</b>	<b>ORDER CODE</b>
6.5 W 12 Vf 600mA	435lm	0 4 8 - 1 7 1 0 ☼☼ 1 0 ▲

### TRIMLESS MOUNTING SET for plasterboard ceilings 9–25 mm

<b>COLOUR</b>	<b>ORDER CODE</b>
○ traffic white RAL9016	0 4 8 - 1 6 9 8 1 0 7

### DOWNLIGHT TRIM

<b>INSET POWER</b>	<b>LUMINOUS FLUX</b>	<b>ORDER CODE</b>
6.5 W 12 Vf 600mA	435lm	0 4 8 - 1 6 1 0 ☼☼ 1 ▲

## SPIO 20 wallwasher / floor



### WALLWASHER / FLOOR TRIMLESS

<b>INSET POWER</b>	<b>LUMINOUS FLUX</b>	<b>ORDER CODE</b>
5.9 W 5.6 Vf 1050mA	414lm	0 4 8 - 1 7 3 0 ☼☼ 1 0 8 W

### TRIMLESS MOUNTING SET for plasterboard ceilings 9–25 mm

<b>COLOUR</b>	<b>ORDER CODE</b>
○ traffic white RAL9016	0 4 8 - 1 6 9 8 1 0 7

### WALLWASHER / FLOOR TRIM

<b>INSET POWER</b>	<b>LUMINOUS FLUX</b>	<b>ORDER CODE</b>
5.9 W 5.6 Vf 1050mA	414lm	0 4 8 - 1 6 3 0 ☼☼ 1 ▲ 8 W

## Mounting accessories

### SPECIAL MOUNTING TOOL

<b>TYPE</b>	<b>Ø-H (mm)</b>	<b>ORDER CODE</b>
SPIO 20	73-107	0 4 8 - 1 6 9 0 0 0 0

necessary to install mounting housing trimless

## Electrical accessories

### POWER SUPPLY 220-240 V AC, 50-60Hz, □ PC II

TYPE	EFFICIENCY	L-W-H (mm)	ORDER CODE
600 mA   max. 43 V   non DIM	η 85 %	147-44-22	0 0 2 - 9 0 7 8 3
600 mA   max. 46 V   DALI-2	η 85 %	143-43-30	0 0 2 - 9 0 7 8 4
1050 mA   max. 25 V   non DIM	η 85 %	111-38-28	0 0 2 - 9 0 7 8 7
1050 mA   max. 42 V   DALI-2	η 85 %	143-43-30	0 0 2 - 9 0 7 8 8

revision opening required

### DIN RAIL COMPONENTS

TYPE	W-H-D (mm)	ORDER CODE
POWER SUPPLY 220-240 V AC	72-90-63	0 0 5 - 6 5 2 0 2 1 0
160 W   48 V DC constant voltage		
LED DRIVER DALI-2 DT6 1-2 addr.	36-88-59	0 0 5 - 6 1 2 1 0 3 0
200-1050 mA settable const. current		
2 × 42 W   48 V DC   U <sub>OUT</sub> 10-40 V		

for more details and components see XAL 22 catalog, page 980

**INSET POWER** is the current consumption excluding any ballast

**LUMINOUS FLUX** value calculated for 3000 K, CRI ≥ 90, colour white, lens wide flood, 2700 K -3 %

**Private Residence**  
Visualisation







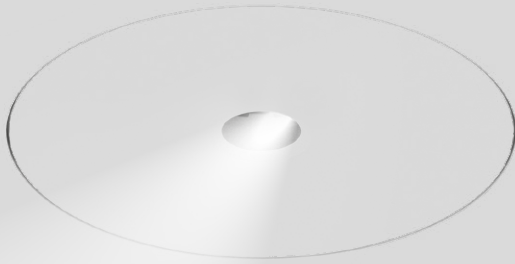

reddot winner 2022



## SPIO 60

recessed

**EN** Round recessed spotlight in die-cast aluminium; installation without tools in mounting set with ball catch system or with magnetic attachment; for trimless installation in plaster-board ceilings; paintable cover; shadow joint between cover and mounting set optionally fillable; or with trim; choice of adjustable or fixed symmetric radiation characteristic; high quality lens system; uncluttered ceiling look through recessed lighting level; reduced light-emitting surface (only  $\varnothing 10$  mm); no multiple shadows; efficient LEDs with very good colour rendering

**DE** Runder Einbaustrahler aus Aluminiumdruckguss; werkzeuglose Montage im Montageset durch Kugelschnappsystem oder mittels Magnetbefestigung; für randlosen Einbau in Gipskartondecken; überstreichbare Abdeckplatte; Schattenfuge zwischen Abdeckplatte und Montageset optional verspachtelbar; oder mit umlaufendem Rand; wahlweise einstellbar oder starr symmetrische Abstrahlcharakteristik; hochwertige Linsenoptik; ruhiges Deckenbild durch zurückversetzte Leuchtenebene; reduzierte Lichtaustrittsfläche (nur  $\varnothing 10$  mm); keine Mehrfachschatten; effiziente LEDs mit sehr guter Farbwiedergabe

### Quickinfo

2700 K, 3000 K  
CRI  $\geq 90$ , 3 SDCM  
up to 60 lm/W  
L95 @ 50000h  
non DIM, DALI-2

### Types

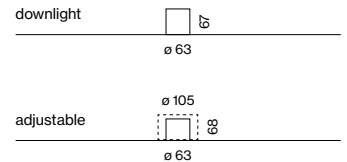

### Colours



### Light distributions



version with trim available



10mm light output area



trimless installation

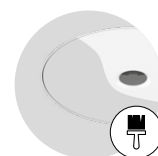

paintable cover

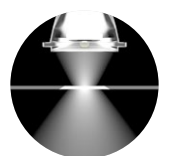

LFO lens technology

### Order options

<b>COLOUR TEMPERATURE</b>	••
2700 K	4
3000 K	5

<b>MATERIAL COLOUR</b>
○ traffic white RAL9016
paintable cover

<b>BEAM ANGLE</b>	▲
flood 35°	F
wide flood 44°	W

### Options on request

<b>COLOUR TEMPERATURE</b>
4000 K

<b>CONCRETE HOUSING</b>
primed concrete ceiling
exposed concrete ceiling

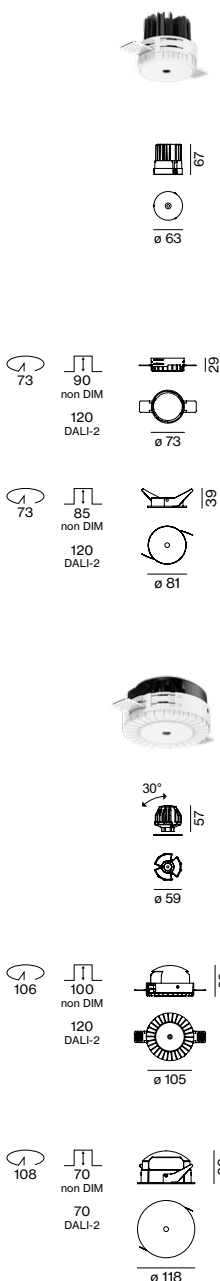

### SPIO 60 downlight



#### DOWNLIGHT

<b>INSET POWER</b>	<b>LUMINOUS FLUX</b>	<b>ORDER CODE</b>
11.9W 12Vf 1050mA	718lm	048-1510••17▲

### Mounting accessories

**TRIMLESS MOUNTING SET** for plasterboard ceilings 12.5/15/25 mm

<b>COLOUR</b>	<b>ORDER CODE</b>
○ traffic white RAL9016	048-2696117

**MOUNTING SET WITH TRIM** for intermediate ceilings 2–25 mm

<b>COLOUR</b>	<b>ORDER CODE</b>
○ traffic white RAL9016	048-1597207
● jet black RAL 9005	048-1597208

### SPIO 60 adjustable



#### ADJUSTABLE

<b>INSET POWER</b>	<b>LUMINOUS FLUX</b>	<b>ORDER CODE</b>
11.9W 12Vf 1050mA	685lm	048-1520••17▲

### Mounting accessories

**TRIMLESS MOUNTING SET** for plasterboard ceilings 12.5/15/25 mm

<b>COLOUR</b>	<b>ORDER CODE</b>
○ traffic white RAL9016	048-1598107

**MOUNTING SET WITH TRIM** for intermediate ceilings 2–25 mm

<b>COLOUR</b>	<b>ORDER CODE</b>
○ traffic white RAL9016	048-1597107
● jet black RAL 9005	048-1597108

### Electrical accessories

**POWER SUPPLY** 220-240V AC, 50-60Hz, □ PC II

TYPE	EFFICIENCY	L-W-H (mm)	ORDER CODE
1050 mA   non DIM	η 85 %	111-38-28	002-90787
1050 mA   DALI-2	η 85 %	143-43-30	002-90788

#### DIN RAIL COMPONENTS

TYPE	W-H-D (mm)	ORDER CODE
POWER SUPPLY 220-240V AC	72-90-63	005-6520210
160W   48V DC constant voltage		
LED DRIVER DALI-2 DT6 1–2 addr.	36-88-59	005-6121030
200–1050 mA settable const. current		
2 × 42W   48V DC   U <sub>OUT</sub> 10–40V		

for more details and components see XAL 22 catalog, page 980

**INSET POWER** is the current consumption excluding any ballast  
**LUMINOUS FLUX** value calculated for 3000 K, CRI ≥ 90, colour white, lens wide flood, 2700 K -5%

**Private Residence**  
Visualisation







# High-precision shelf lighting

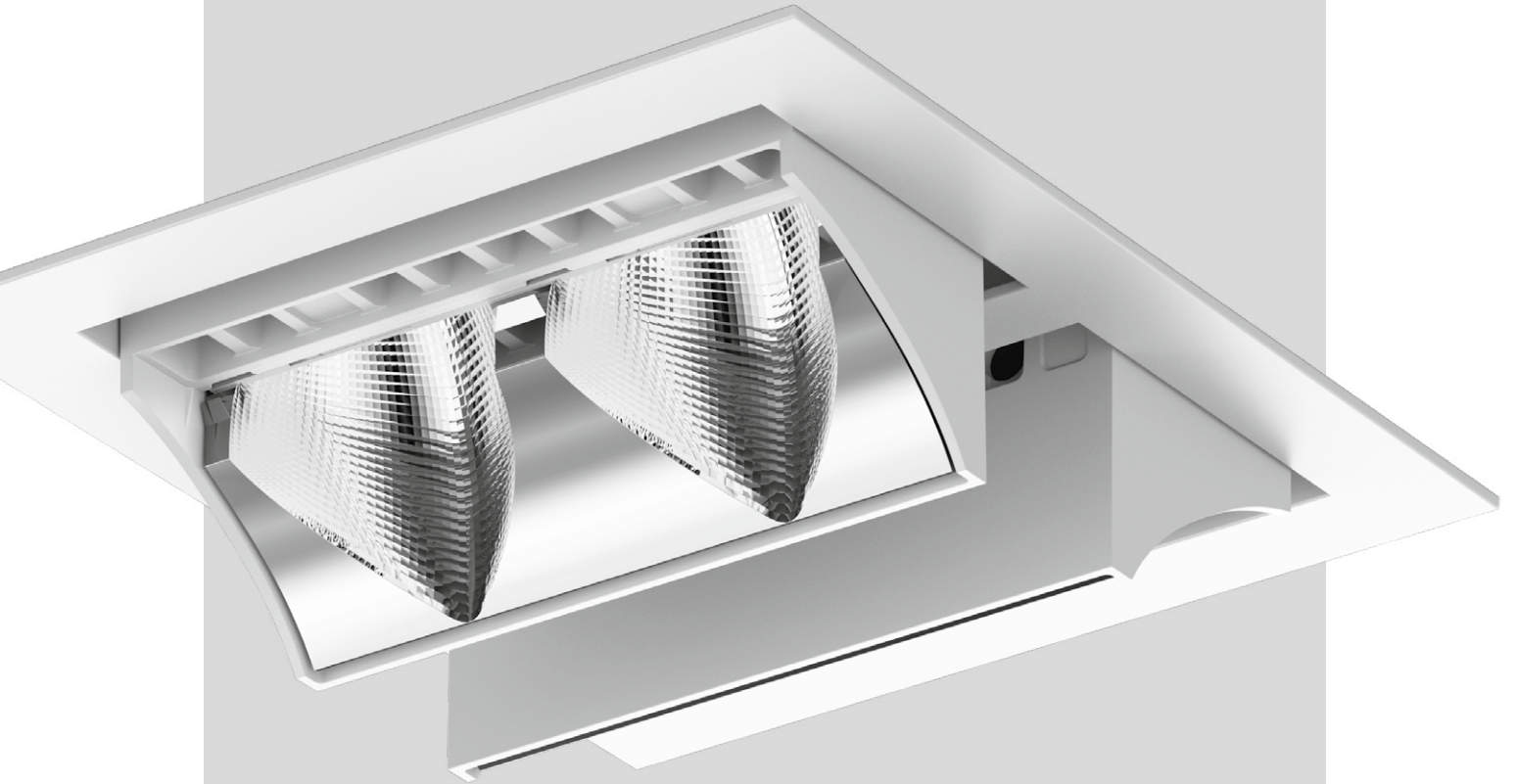



# SQUADRO

**EN** SQUADRO is a track-mounted and recessed spotlight, in a two-lamp single- or double-sided version, for the retail sector that bundles six essential retail requirements in one luminaire. Free-form reflectors with faceted optics make a polished presentation of goods possible. These reflectors direct the light precisely into shelves or aisle zones. Directed light creates a modelling effect on the products and delivers attractive staging. Swivelling light modules illuminate specific shelf levels or billboards while providing plenty of basic lighting. SQUADRO spotlights are completely glare-free, both transversely and longitudinally. They are highly efficient in their energy balance with an efficiency of over 90 %.

**DE** SQUADRO ist ein Stromschienen- und Einbaustrahler, in zweiflamiger einseitiger oder zweiseitiger Ausführung, für den Retailbereich, der sechs wichtige Retail-Anforderungen in einer Leuchte bündelt. Die brillante Präsentation von Waren gelingt dank Freiformflächenreflektoren mit Facettenoptik: Diese lenken das Licht punktgenau und hochpräzise in Regale oder Gangzonen. Gerichtetes Licht erzeugt einen Modelling-Effekt auf den Waren und schafft eine attraktive Inszenierung. Schwenkbare Lichtmodule beleuchten gezielt Regalebenen oder Plakatwände und sorgen gleichzeitig für ausreichende Grundbeleuchtung. SQUADRO Strahler sind dabei komplett quer- und längsentblendet und dennoch in ihrer Energiebilanz mit einem Wirkungsgrad von über 90% höchst effizient.

## Types



single-sided 1×2    double-sided 2×2    single-sided 1×2    double-sided 2×2

## Mountings

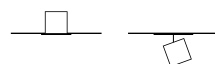

recessed    track

## Light distributions

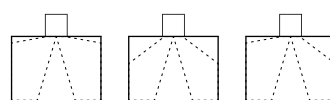

wall floor    shelf floor    wall/shelf floor

## 6-in-1 Lighting solution

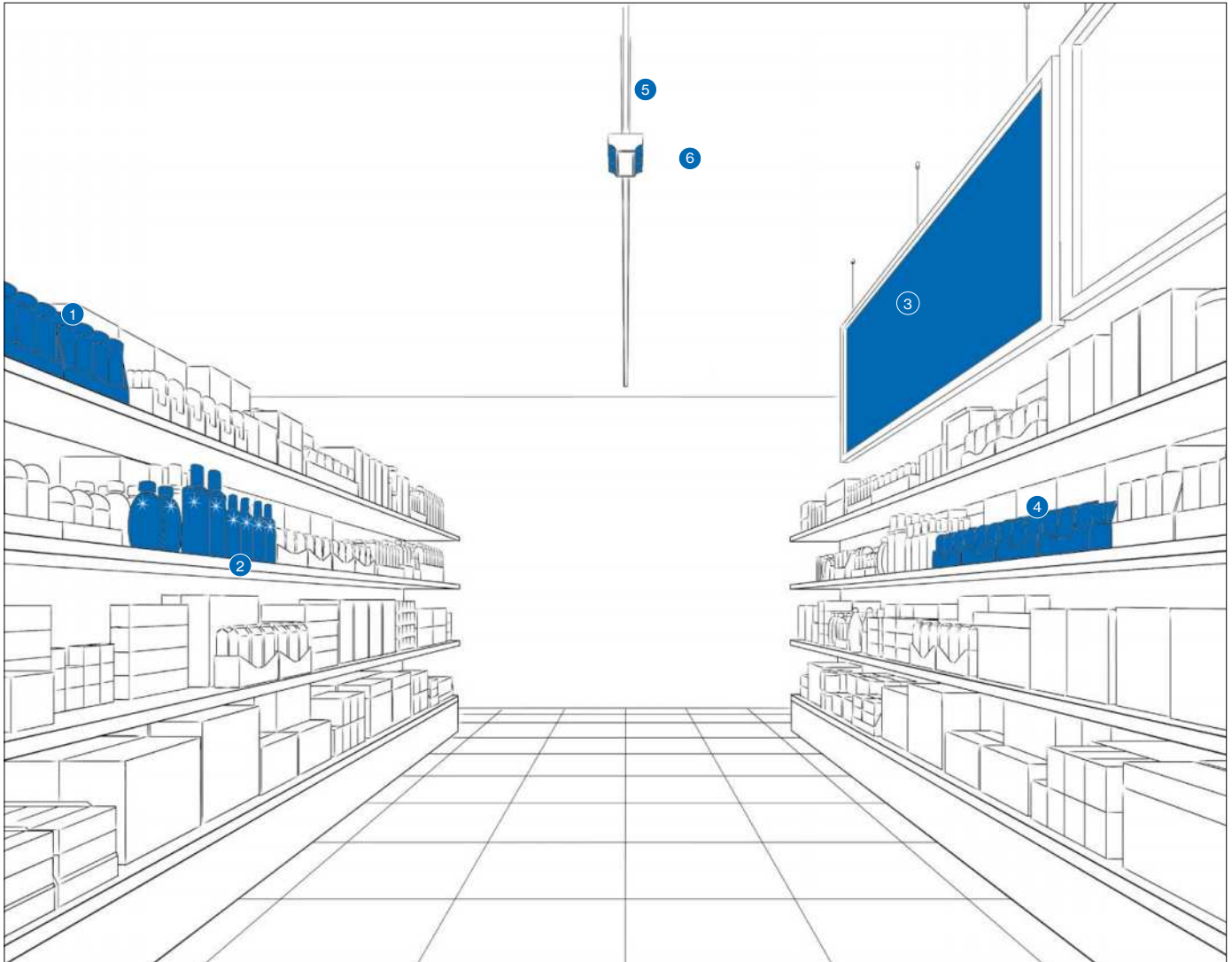

**EN** SQUADRO combines all the advantages of traditional retail lighting solutions in one luminaire. The spotlights are transversely and longitudinally glare-free and direct the light precisely onto the goods – into the heights and depths of the shelves. This achieves a strong product presentation. Thanks to proper light distribution, no additional light source is required for basic lighting.

**DE** SQUADRO bündelt alle Vorteile klassischer Retail-Lichtlösungen in einer Leuchte. Die Strahler sind quer- und längsblendfrei und richten das Licht präzise auf die Ware – bis in die Höhen und Tiefen der Regale. Das erzielt eine starke Produktpräsentation. Dank guter Lichtverteilung ist keine zusätzliche Lichtquelle für die Grundbeleuchtung nötig.

**1** **EN** The highest illuminance is on the upper two presentation levels.

**DE** Die höchste Beleuchtungsstärke liegt auf den oberen beiden Präsentationsebenen.

**2** **EN** Highlights on premium goods create a brilliant staging.

**DE** Speziell exklusive Ware wird durch Glanzpunkte attraktiv inszeniert.

**3** **EN** Directed light creates accents on billboards and subjects.

**DE** Gerichtetes Licht erzeugt Akzente auf Werbetafeln und Sujets.

**4** **EN** The high depth effect gives food high colour contrasts and attractiveness.

**DE** Durch die hohe Tiefenwirkung erhalten Lebensmittel hohe Farbkontraste und Glanzpunkte.

**5** **EN** Due to longitudinal glare control, the lighting system is barely perceptible to the customer in the direction of the aisle.

**DE** Durch die Längsblendung ist die Beleuchtungsanlage für den Kunden in Gangrichtung kaum wahrnehmbar.

**6** **EN** Transverse glare control additionally prevents glare from any viewing direction.

**DE** Die Querblendung verhindert zusätzlich Blendung aus jeder Blickrichtung.

## Five versions

**EN** SQUADRO's five variants with diverse beam characteristics respond to different shop layouts and requirements. Perfect alignment ensures that minimal luminaires radiate as much light as possible onto the merchandise. SQUADRO adapts to the conditions and illuminates selectively and without scatter loss. All goods are thus attractively presented regardless of the size or interior design of the shop.

**DE** SQUADRO antwortet auf unterschiedliche Shop-Layouts und Anforderungen mit fünf Varianten mit verschiedenen Abstrahlcharakteristiken. Damit wenige Leuchten so viel Licht wie möglich auf die Ware strahlen, zählt die perfekte Ausrichtung. SQUADRO passt sich den Gegebenheiten an und beleuchtet punktuell und ohne Streuverluste. So werden alle Waren, unabhängig von Größe oder Innenarchitektur des Shops, ansprechend in Szene gesetzt.

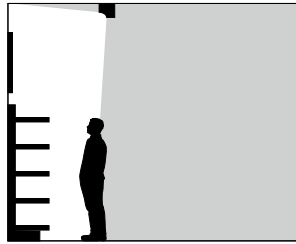

Wall Floor (single-side)

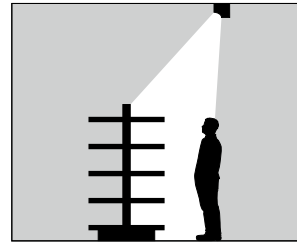

Shelf Floor (single-side)

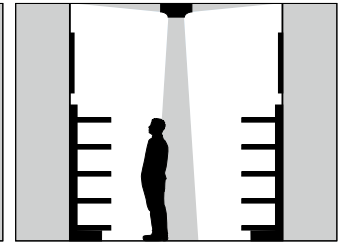

Wall Floor (double-side)

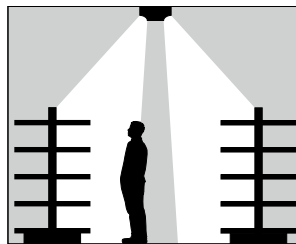

Shelf Floor (double-side)

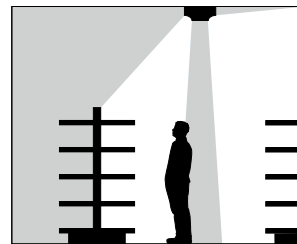

Shelf / Wall Floor

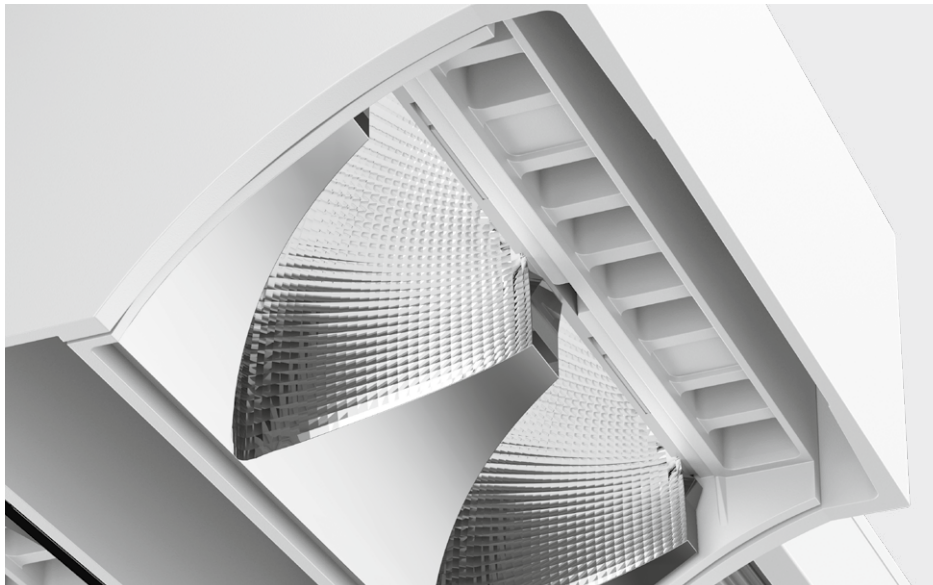

## Unique reflector technology

**EN** Custom free-form reflectors ensure high-precision light control; each SQUADRO achieves an efficiency of over 90 per cent. The spotlights enjoy optimum glare control through the curved shape and secondary reflector technology.

**DE** Spezielle Freiflächenreflektoren sorgen für hochpräzise Lichtlenkung; jeder SQUADRO erzielt einen Wirkungsgrad von über 90 Prozent. Optimale Entblendung gelingt durch die gekrümmte Form und Sekundärreflektortechnik der Strahler.

## Effective lighting

**EN** Branches of the same chain often differ in their shop architecture. Shelf heights and aisle widths may vary from one location to another. The solution is step-adjustable light modules. The elements can be tilted from  $-15^\circ$  to  $+20^\circ$ . Each module can be tilted asymmetrically, allowing precise alignment and thus optimum light control.

**DE** Filialen derselben Kette unterscheiden sich häufig in der Shop-Architektur. Regalhöhen und Gangbreiten können sich je nach Standort unterscheiden. Die Lösung: stufenverstellbare Lichtmodule. Die Elemente sind von  $-15^\circ$  bis zu  $+20^\circ$  kippbar. Jedes Modul kann asymmetrisch geneigt werden und ermöglicht eine präzise Ausrichtung und damit eine optimale Lichtlenkung.



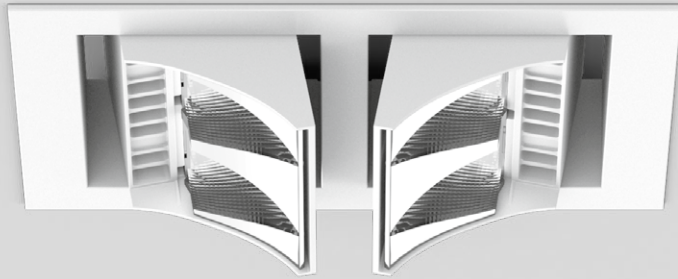

## SQUADRO wallwasher

recessed

**EN** Recessed ceiling spotlight in die cast aluminium in two different types (2 lamps or 2×2 lamps) and with 2 types of light modules (for shelf floor washer and wall floor washer); with trim; surface powder coated; installation without tools using snap spring closure; aisle spotlight with special, multi-free-form, facet effect surface reflectors for high precision light control; precise shelf and aisle zone lighting, optimum longitudinal glare control for high viewing comfort in the aisle zone, adjustable light modules; COB (Chip on Board) technology for maximum efficiency; efficient LEDs with very good colour rendering; IP40 protection glass available as an accessory

**DE** Deckeneinbaustrahler aus Aluminiumdruckguss in 2 verschiedenen Varianten (2-flammig bzw. 2×2-flammig) und mit 2 verschiedenen Lichtmodulen (für shelf floor washer und wall floor washer); mit umlaufendem Rand; Oberfläche pulverbeschichtet; werkzeuglose Montage mittels Schnappfederverschluss; Gangzonenstrahler mit speziellen Multi-Freiformflächenreflektoren mit Facettenoptik zur äußerst präzisen Lichtlenkung; punktgenaue Regal- und Gangzonenausleuchtung, optimale Längsentblendung für hohen Sehkomfort in der Gangzone, einstellbare Lichtmodule; COB (Chip on Board) Technologie für höchste Effizienz; effiziente LEDs mit sehr guter Farbwiedergabe; IP40-Schutzglas als Zubehör erhältlich

### Quickinfo

3000 K, 4000 K  
CRI ≥ 90, 3 SDCM  
up to 134 lm/W  
L80 @ 50 000 h  
non DIM, DALI-2

### Types

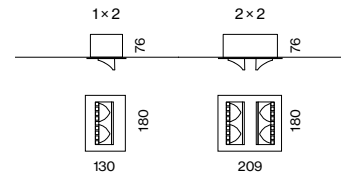

### Colours



### Light distributions



DiiA® standards  
251, 252, 253



up to 134 lm/W  
(high efficiency)

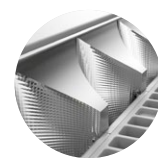

glare-free reflector  
longitudinally &  
transversely

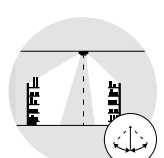

+20° up to -10°  
tiltable

### Order options

<b>COLOUR TEMPERATURE</b>	☐☐
3000K	0
4000K	1

<b>CONTROL</b>	⬆️⬆️
non DIM	1
DALI-2	3

<b>MATERIAL COLOUR</b>	☑️
○ traffic white RAL 9016	7
● jet black RAL 9005	8

<b>REFLECTOR</b>	▲
shelf floor washer	S
wall floor washer	A
1× shelf / 1× wall floor washer*	B

\*only for 2×2 lamps

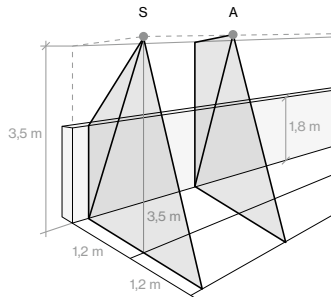

### Options on request

<b>COLOUR RENDERING INDEX</b>
CRI ≥ 80

### Light distributions

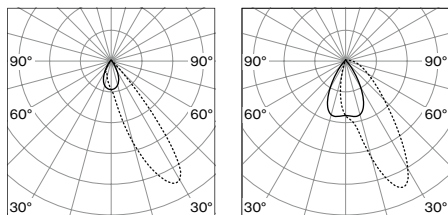

1×2 lamps  
shelf floor washer

1×2 lamps  
wall floor washer

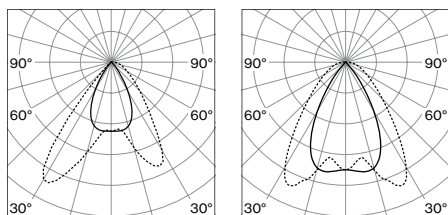

2×2 lamps  
1× shelf / 1× wall floor washer

2×2 lamps  
wall floor washer

**LUMINOUS FLUX** value calculated for 4000K  
CRI ≥ 90, colour white, wall floor washer  
3000K -5%

### SQUADRO wallwasher trim



#### 1×2 LAMPS SINGLE-SIDED

<b>SYSTEM POWER</b>	<b>LUMINOUS FLUX</b>	<b>ORDER CODE</b>
36 W	4720 lm	0 4 9 - 2 0 1 2 ☐☐▲



#### 2×2 LAMPS DOUBLE-SIDED

<b>SYSTEM POWER</b>	<b>LUMINOUS FLUX</b>	<b>ORDER CODE</b>
72 W	2 × 4720 lm	0 4 9 - 2 0 2 0 ☐☐▲

### Optical accessories

#### IP 40 PROTECTION GLASS

<b>TYPE</b>	<b>ORDER CODE</b>
1×2 lamps/single-sided	0 4 9 - 2 9 1 0 0 1 0
2×2 lamps/double-sided	0 4 9 - 2 9 2 0 0 1 0

### Technical data

#### SQUADRO 1×2 lamps, shelf wall washer, trim, 36 W, 3000 K

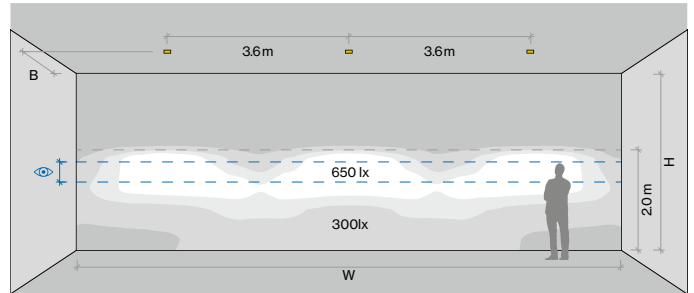

#### SQUADRO 1×2 lamps, wall floor washer, trim, 36 W, 3000 K

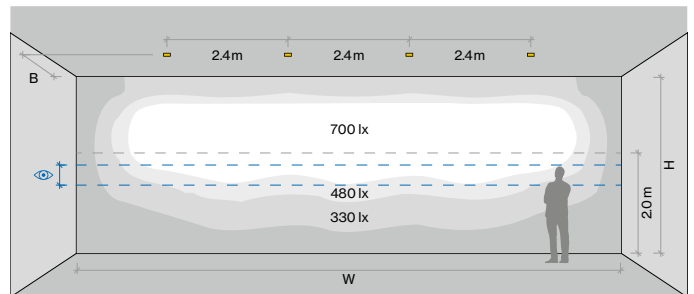

#### ROOM VALUES

Wall dimensions	H = 3.5 m   W = 10.8 m
Distance to wall	B = 1.3 m
Aisle width	2.6 m
Reflection factor	0.7   0.7   0.2
Maintenance factor	0.9

#### CALCULATION SURFACE

Surface dimensions	10.8 × 3.5 m
Surface height	0 – 3.5 m
Eye level	1.35 m – 1.75 m



**Euroshop** Dusseldorf, DE –  
by blocher partners





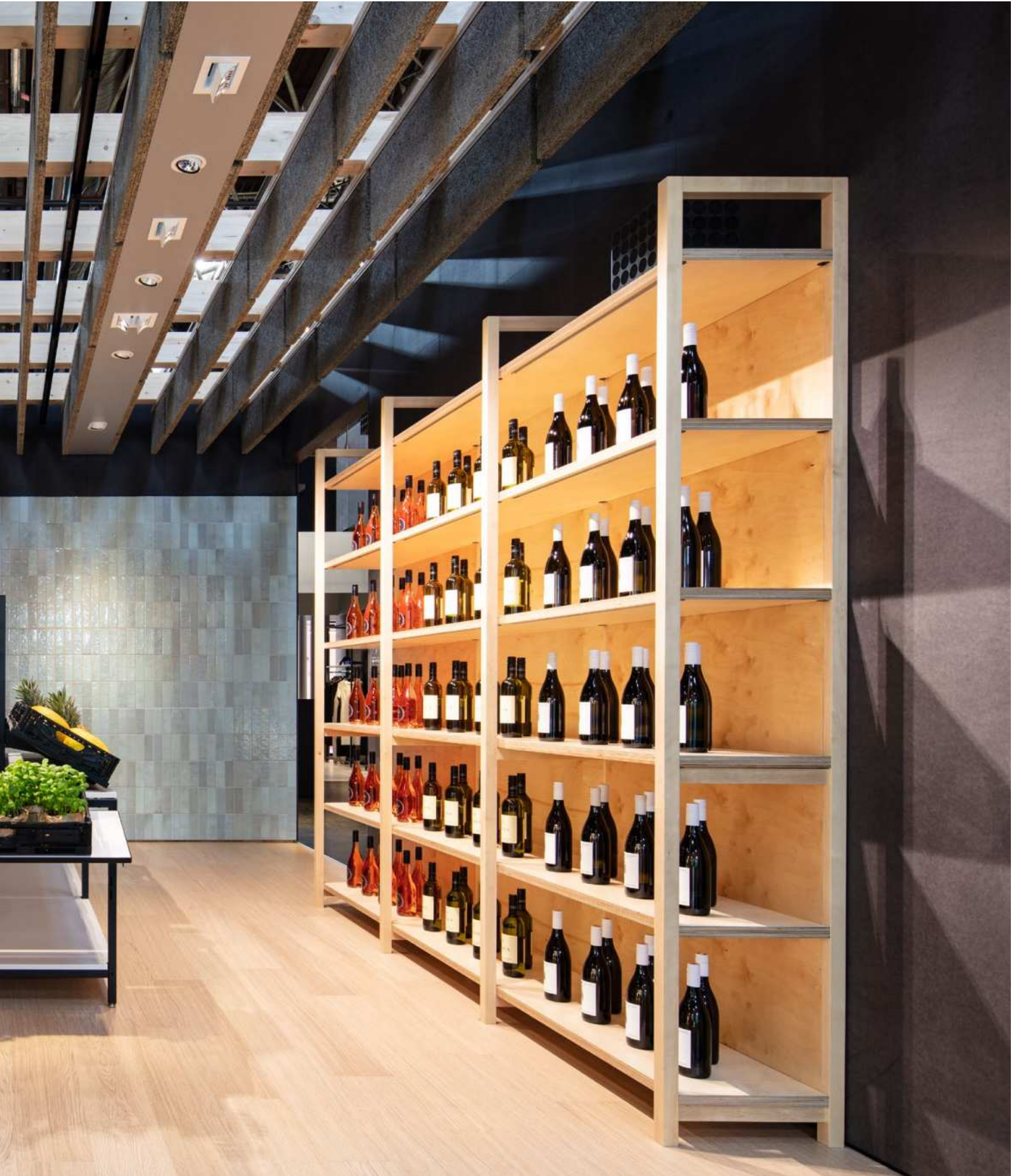



### Quickinfo

3000K, 4000K  
 CRI ≥ 90, 3 SDCM  
 up to 134lm/W  
 L80 @ 50000h  
 non DIM, DALI-2

### Types

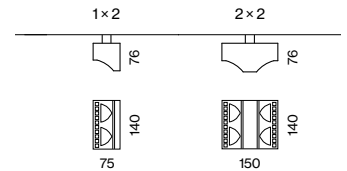

### Colours



### Light distributions

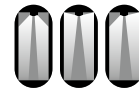

shelf floor wall floor shelf wall floor

## SQUADRO wallwasher

track

**EN** Track light in die cast aluminium in two different types (2 lamps or 2×2 lamps) and with 2 types of light modules (for shelf floor washer and wall floor washer); surface powder coated; aisle spotlight with special, multi-free-form, facet effect surface reflectors for high precision light control; precise shelf and aisle zone lighting, optimum longitudinal glare control for high viewing comfort in the aisle zone, adjustable light modules; COB (Chip on Board) technology for maximum efficiency; efficient LEDs with very good colour rendering; IP40 protection glass available as an accessory; including attachment for linear alignment of the spotlights

**DE** Stromschienenstrahler aus Aluminiumdruckguss in 2 verschiedenen Varianten (2-flammig bzw. 2×2-flammig) und mit 2 verschiedenen Lichtmodulen (für shelf floor washer und wall floor washer); Oberfläche pulverbeschichtet; Gangzonenstrahler mit speziellen Multi-Freiformflächenreflektoren mit Facettenoptik zur äußerst präzisen Lichtlenkung; punktgenaue Regal- und Gangzonenbeleuchtung, optimale Längsentblendung für hohen Sehkomfort in der Gangzone, einstellbare Lichtmodule; COB (Chip on Board) Technologie für höchste Effizienz; effiziente LEDs mit sehr guter Farbwiedergabe; IP40-Schutzglas als Zubehör erhältlich; inklusive Aufsatz zur linearen Ausrichtung der Strahler



DiiA® standards  
 251, 252, 253



up to 134lm/W  
 (high efficiency)

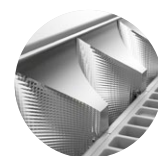

glare-free reflector  
 longitudinally &  
 transversely

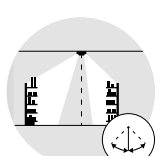

+20° up to -10°  
 tiltable

**Order options**

**COLOUR TEMPERATURE** ⬢⬢

3000K	0
4000K	1

**CONTROL** ⬢

non DIM	1
DALI-2	3

**MATERIAL COLOUR** ▣

○ traffic white RAL 9016	7
● jet black RAL 9005	8

**REFLECTOR** ▲

shelf floor washer	S
wall floor washer	A
1×shelf/1×wall floor washer*	B

\*only for 2×2 lamps

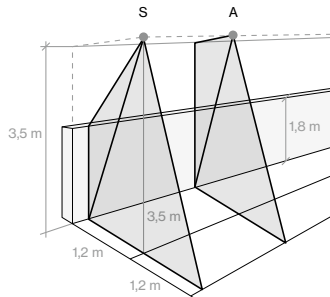

**Options on request**

**COLOUR RENDERING INDEX**

CRI ≥ 80
----------

**CONTROL**

DALI-2 (2×2 lamps)
--------------------

**Light distributions**

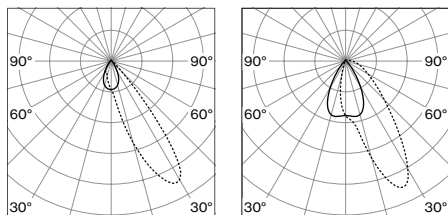

1×2 lamps  
shelf floor washer

1×2 lamps  
wall floor washer

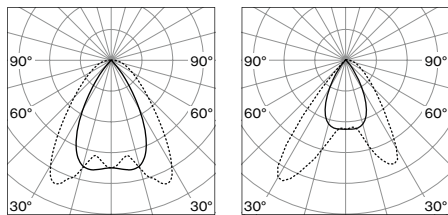

2×2 lamps  
wall floor washer

2×2 lamps  
1×shelf/1×wall floor washer

**LUMINOUS FLUX** value calculated for 4000K  
CRI ≥ 90, colour white, wall floor washer  
3000K -5%

**SQUADRO wallwasher track**



**1×2 LAMPS SINGLE-SIDED**

<b>SYSTEM POWER</b>	<b>LUMINOUS FLUX</b>	<b>ORDER CODE</b>
36W	4720lm	149-2210 <span style="color: blue;">⬢⬢▲</span>



**2×2 LAMPS DOUBLE-SIDED**

<b>SYSTEM POWER</b>	<b>LUMINOUS FLUX</b>	<b>ORDER CODE</b>
72W	2×4720lm	149-2220 <span style="color: blue;">⬢⬢▲</span>

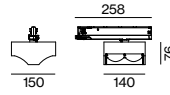
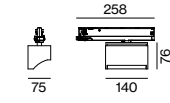

**Optical accessories**

**IP 40 PROTECTION GLASS**

<b>TYPE</b>	<b>ORDER CODE</b>
1×2 lamps/single-sided	049-2910010
2×2 lamps/double-sided	049-2920010

**Technical data**

**SQUADRO 1×2 lamps, shelf wall washer, trim, 36W, 3000K**

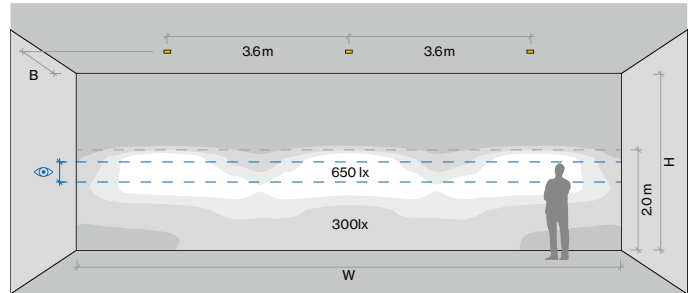

**SQUADRO 1×2 lamps, wall floor washer, trim, 36W, 3000K**

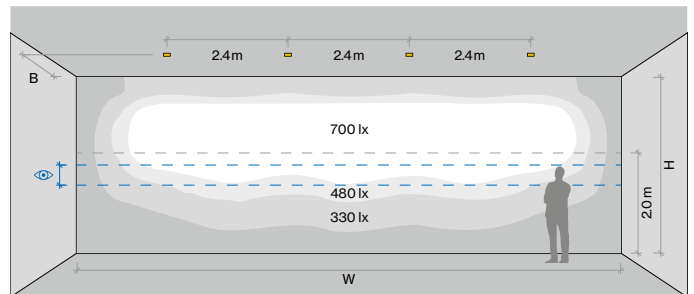

<b>ROOM VALUES</b>		<b>CALCULATION SURFACE</b>	
Wall dimensions	H = 3.5m   W = 10.8m	Surface dimensions	10.8 × 3.5m
Distance to wall	B = 1.3m	Surface height	0 – 3.5m
Aisle width	2.6m		
Reflection factor	0.7   0.7   0.2	Eye level	1.35m – 1.75m
Maintenance factor	0.9		



**Jelmoli Store**  
Zurich, CH

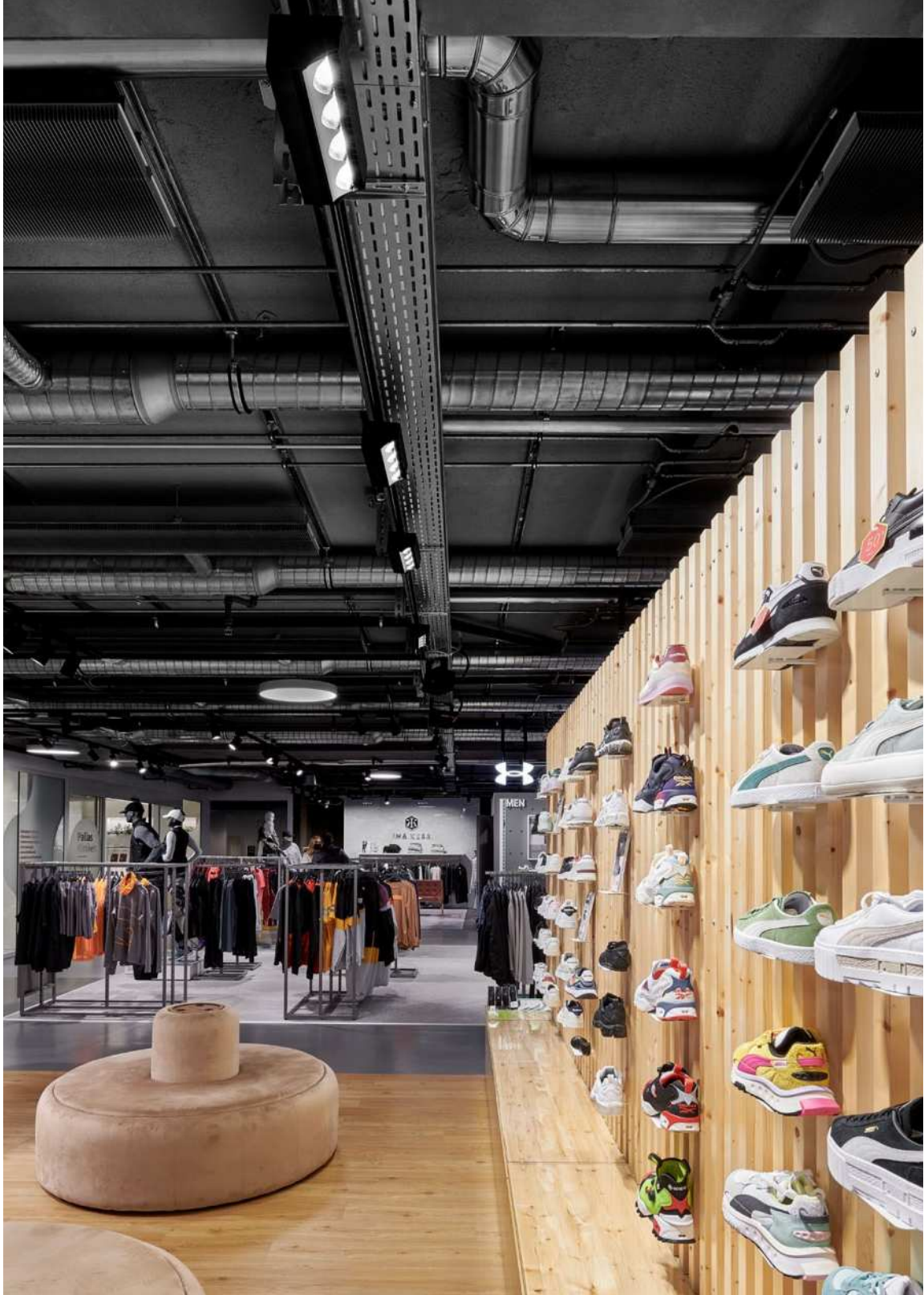



Oasis Store Melbourne, AU –  
by Sync Design



# In the spotlight

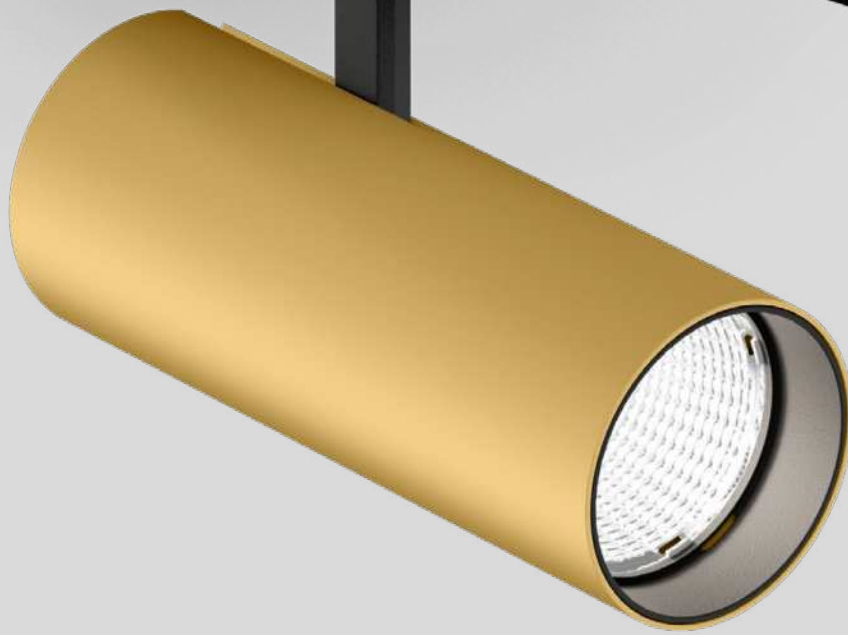

## BO intrack

**EN** Elegant and flexible – this is what characterises the BO track spotlight series. Several sizes and different beam angles offer enormous freedom in setting the scene. The Intrack versions are available as one-, two-, or three-flame spotlights. In addition, the spots can be rotated and pivoted at different angles, making BO an ideal spotlight for shops and staging areas. Different housing and light colours (2700 K, 3000 K, or 4000 K) offer flexibility in different architectural concepts and promise very good colour rendering of up to  $\text{CRI} \geq 95$  (2-SDCM).

**DE** Formschön und flexibel: das zeichnet die Strahlschienenstrahlerreihe BO aus. Durch mehrere Größen und verschiedene Ausstrahlwinkel haben Sie große Freiheit bei der Inszenierung. Die Intrack Varianten sind als ein-, zwei- oder dreiflammiger Strahler erhältlich. Zusätzlich sind die Spots in verschiedenen Winkeln dreh- und schwenkbar und machen BO zu einem idealen Strahler für Shops und Präsentationsflächen. Verschiedene Gehäuse- und Lichtfarben (2700 K, 3000 K oder 4000 K) bieten Flexibilität in unterschiedlichen architektonischen Konzepten und versprechen eine sehr gute Farbwiedergabe von bis zu  $\text{CRI} \geq 95$  (2-SDCM).

### Types

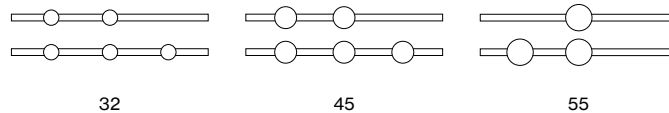

### Mounting



track

### Light distribution



spotlight



## Matched proportions

**EN** Elegance in the right measure: All BO product family spotlights are characterised by their decorative and simple aesthetics. Thanks to their reduced design and precisely coordinated proportions, all BO models can be combined with each other.

**DE** Eleganz im richtigen Maß: Alle Strahler der BO Produktfamilie zeichnen sich durch ihre dekorative und schlichte Ästhetik aus. Dank ihres reduzierten Designs und den exakt aufeinander abgestimmten Proportionen sind sämtliche BO-Varianten miteinander kombinierbar.

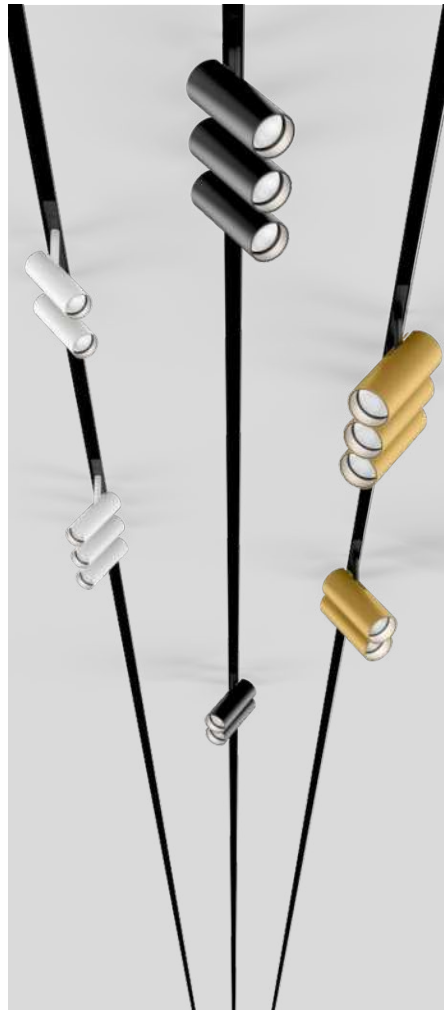

## Colour variety

**EN** BO is available in standard white and black. For even more design freedom, additional colour options are available so that you can tailor BO to your individual project. Learn more about our colour palette at [xal.com/colours](http://xal.com/colours).

**DE** BO ist in den Standardfarben Weiß und Schwarz erhältlich. Für noch mehr Gestaltungsfreiraum stehen weitere Farbvarianten zur Verfügung – so können Sie BO Ihrem individuellen Projekt anpassen. Mehr zu unserer Farbpalette erfahren Sie auf [xal.com/colours](http://xal.com/colours).



[xal.com/colours](http://xal.com/colours)

## Variety

**EN** The BO Intrack versions are available as single-, double-, or triple-flame spotlights. The spotlight heads are available in three different diameters and different housing and light colours (2700 K, 3000 K, or 4000 K), offering even more flexibility for unique projects. The multi-flame version of the Inset requires only one control gear, which means that the individual spotlights are closer together. This makes these variants not only space-saving but also more cost-efficient.

**DE** Die BO Intrack Varianten sind als ein-, zwei- oder dreiflammiger Strahler erhältlich. Die Strahlerköpfe in drei unterschiedlichen Durchmessern und verschiedene Gehäuse- und Lichtfarben (2700 K, 3000 K oder 4000 K) bieten noch mehr Flexibilität für einzigartige Projekte. Die mehrflammige Ausführung des Insets benötigt lediglich ein Betriebsgerät, wodurch die einzelnen Strahler näher beieinander sitzen. Dadurch sind diese Varianten nicht nur platzsparend, sondern auch kosteneffizienter.

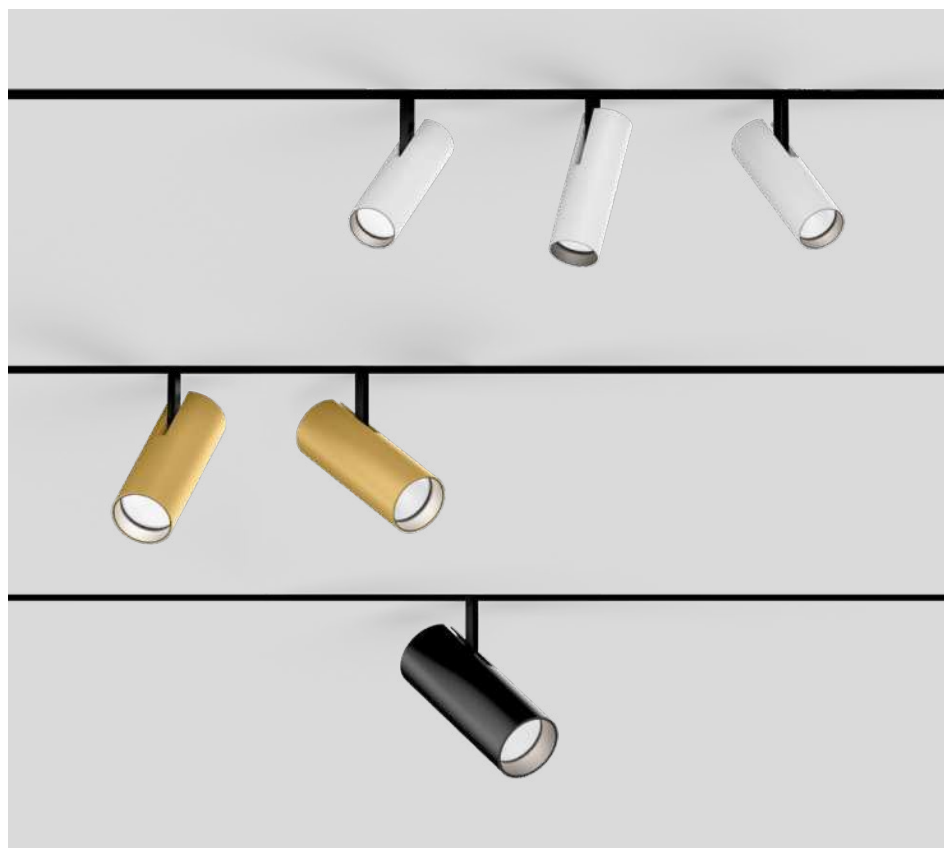



## Intrack

**EN** Flexible adjustment – easy installation: In the track version, BO combines different sizes and beam angles. Thus, ever new lighting scenarios can be implemented: from the selective presentation of goods and products to the staging of art objects and home accessories. The converter disappears elegantly into the track.

**DE** Flexible Adjustierung – einfache Montage: In der Track-Variante vereint BO unterschiedliche Größen und Ausstrahlwinkel. So lassen sich immer wieder neue Lichtinszenierungen realisieren: von der punktuellen Waren- und Produktpräsentation bis zur Inszenierung von Kunstobjekten und Wohnaccessoires. Der Konverter verschwindet elegant in der Schiene.

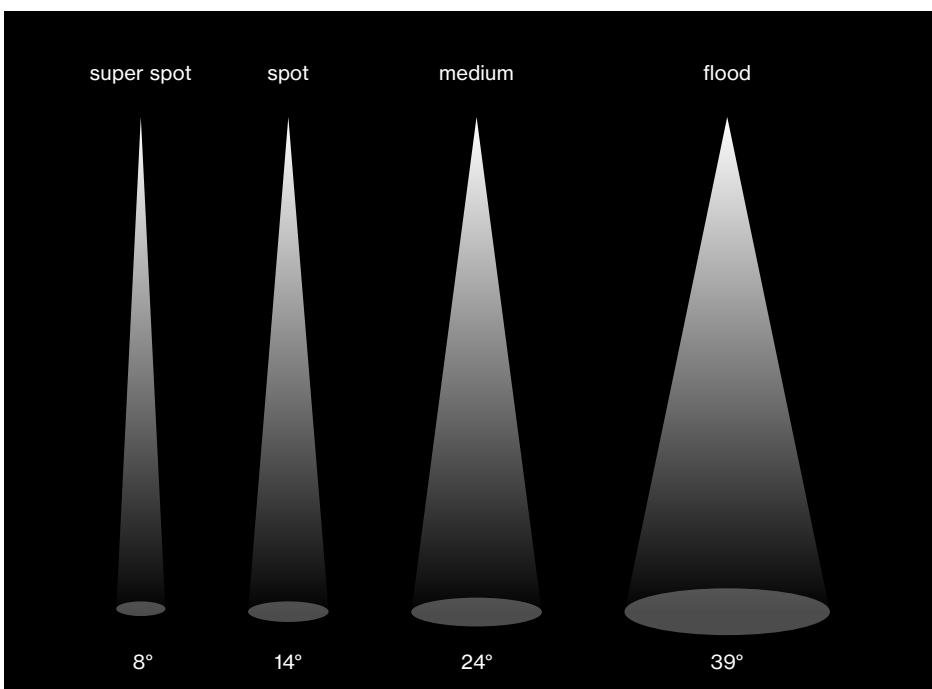

## Flexible adjustment

**EN** BO adapts to the requirements to ensure that objects are presented in the best possible light. The spotlight comes in different beam angles and is rotatable by at least 360°, as well as 90° tiltable.

**DE** Damit Objekte bestmöglich in Szene gesetzt sind, passt sich BO den Anforderungen an. Der Strahler ist nicht nur in verschiedenen Ausstrahlwinkeln verfügbar sondern auch um mindestens 360° dreh- sowie 90° schwenkbar.





## BO 32 / 45 / 55

intrack

**EN** Track light made of die-cast aluminium; powder coated; spotlight head rotates 360° and tilts 90°; choice of single lamp, double lamps or triple lamp; converter in the adapter; with optional high quality lens system with precise radiation characteristic; or high quality, aluminium, vapour deposition coated reflector with faceted design; precise radiation characteristics with different beam angles; good glare reduction due to recessed light point plane; optical attachments as accessories; COB (Chip on Board) technology or high power LEDs - maximum efficiency; no multiple shadows; energy-eff. LEDs - very good colour rendering; adapter for toolless insertion or movement on a variety of 3-phase power tracks; adapter flush with the power track

**DE** Stromschienenstrahler aus Aluminiumdruckguss; pulverbeschichtet; Strahlerkopf 360° dreh- und 90° schwenkbar; wahlweise ein-, zwei- oder dreiflammig; Konverter im Adapter; wahlweise mit hochwertiger Linsenoptik mit präziser Abstrahlcharakteristik; oder hochwertiger, aluminiumbedampfter Reflektor mit Facettenoptik; präzise Abstrahlcharakteristik mit verschiedenen Ausstrahlwinkeln; gute Entblendung durch zurückversetzte Lichtpunktenebene; optische Aufsätze als Zubehör; COB (Chip on Board) Technologie bzw. High-Power-LEDs - höchste Effizienz; keine Mehrfachschatten; energieeff. LEDs - sehr gute Farbwiedergabe; Adapter für werkzeugloses Einsetzen bzw. Verschieben in verschiedenen 3-Phasen Stromschienen; Adapter bündig mit Stromschiene abschließend

### Quickinfo

2700 K, 3000 K, 4000 K  
 CRI ≥ 90, 2 SDCM  
 BO 32 up to 69lm/W  
 BO 45 up to 91lm/W  
 BO 55 up to 85lm/W  
 L80 @ 50 000 h  
 DALI-2

### Types

BO 32	BO 45	BO 55

### Colours



### Light distributions

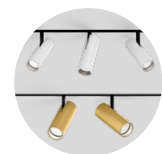
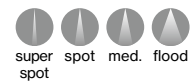

only one adapter  
with 2 or 3 lamps



360° rotatable  
90° tiltable



glare control via  
honeycomb louver

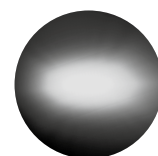

oval lens for oval  
light illumination



CRI ≥ 95  
2 SDCM

## Order options

<b>COLOUR TEMPERATURE</b>	☼☼
2700 K	4
3000 K	5
4000 K	6

### CONTROL

DALI-2

### MATERIAL COLOUR

○ traffic white RAL 9016	7
● jet black RAL 9005	8
🌈 special colours	X

### BEAM ANGLE BO 32

spot 18°	S
medium 23°	M
flood 37°	F

### BEAM ANGLE BO 45

super spot 8°	V
spot 14°	S
medium 24°	M
flood 39°	F

### BEAM ANGLE BO 55

spot 17°	S
medium 23°	M
flood 37°	F

## Options on request

### COLOUR RENDERING INDEX

CRI ≥ 95, 2 SDCM

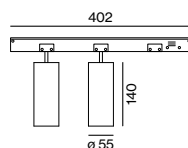
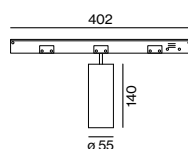
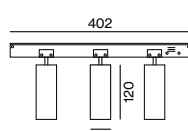
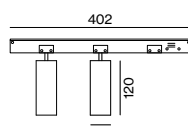
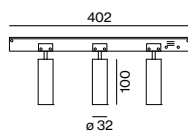
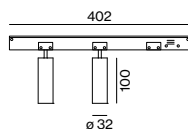

## BO 32 intrack



### TRACK LIGHT

TYPE	SYS. POWER	LUMINOUS FLUX	ORDER CODE
2 lamps	20.5 W	1440 lm	180-7140::3☑▲
3 lamps	28.8 W	2020 lm	180-7150::3☑▲

## BO 45 intrack



### TRACK LIGHT

TYPE	SYS. POWER	LUMINOUS FLUX	ORDER CODE
2 lamps	14.2 W	super spot 2 × 320 lm	180-7240::3☑V
	30 W	spot 2 × 1020 lm	180-7240::3☑S
3 lamps	32 W	med., flood 2 × 1330 lm	180-7240::3☑▲
	45 W	spot 3 × 1020 lm	180-7250::3☑S
	42 W	med., flood 3 × 1180 lm	180-7250::3☑▲

## BO 55 intrack



### TRACK LIGHT

TYPE	SYS. POWER	LUMINOUS FLUX	ORDER CODE
1 lamp	24.8 W	1940 lm	180-7330::3☑▲
2 lamps	43 W	3460 lm	180-7340::3☑▲

## Optical accessories

### HONEYCOMB LOUVER

TYPE	Ø-H (mm)	ORDER CODE
BO 32	30·3	007-1965168
BO 45	42·3	007-1965188
BO 55	50·3	007-1965598

### OVAL LENS

TYPE	Ø-H (mm)	ORDER CODE
BO 32	30·3	007-1965860
BO 45	42·3	007-1965880
BO 55	50·3	007-1965890

### SOFT LENS

TYPE	Ø-H (mm)	ORDER CODE
BO 32	30·3	007-1965960
BO 45	42·3	007-1965980
BO 55	50·3	007-1965990

LUMINOUS FLUX value calculated for 3000 K, CRI ≥ 90, colour white, flood 2700 K -5%, 4000 K +7%

**Euroshop**  
Dusseldorf, DE –  
by blocher partners











BALMAIN  
PARIS



**Oberpollinger | The KaDeWe Group**  
Munich, DE – by Licht Kunst Licht AG  
including lighting design



# Universal expert



# VARO

**EN** As a track-mounted spotlight, VARO focuses on the essentials and can be used universally. It is available in two different sizes and, thanks to its 355° rotation and 90° swivelling capability, is extremely flexible in use. This flexibility is supported by the fact that the spotlights can be inserted and moved along the track without tools. It is ideal for use in shops whose interior design is continually evolving. In addition, the powerful VARO provides maximum efficiency for the illumination of products. The high-quality reflector from VARO ensures a particularly precise beam characteristic at different angles, all with an excellent colour rendering up to  $\text{CRI} \geq 90$ . Depending on the desired spatial effect, you can choose between the 3000 K and 4000 K light colours.

**DE** Als Stromschienenstrahler fokussiert VARO auf das Wesentliche und ist universell einsetzbar. Er ist in zwei verschiedenen Größen verfügbar und durch 355° Dreh- und 90° Schwenkbarkeit höchst beweglich im Einsatz. Unterstützt wird diese Flexibilität durch werkzeugloses Einsetzen und Verschieben der Strahler in der Stromschiene: ideal für den Einsatz in Shops, deren Innenarchitektur sich immer wieder verändert. Zudem bietet der leistungsstarke VARO höchste Effizienz bei der Beleuchtung von Waren. Der hochwertige Reflektor von VARO sorgt für eine besonders präzise Abstrahlcharakteristik in verschiedenen Winkeln – und das bei sehr guter Farbwiedergabe von bis zu  $\text{CRI} \geq 90$ . Je nach gewünschter Raumwirkung haben Sie die Wahl zwischen den Lichtfarben 3000 K und 4000 K.

## Types



80



110

## Mounting



track

## Light distribution

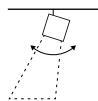

spotlight



## VARO 80 S

track

**EN** Track light made of die-cast aluminium; surface powder coated; spotlight head 355° rotatable and 90° tiltable; integrated converter in the plastic adapter; high quality reflector with spherical facet finish; precise radiation characteristics with different beam angles; installed and exchanged without tools; optical attachments as accessories; optical attachments can be combined; COB (Chip on Board) technology for maximum efficiency; variants with > 120 lm/W available; no multiple shadows; energy-efficient LEDs with very good colour rendering; adapter for toolless insertion or movement on a variety of 3-phase power tracks

**DE** Stromschienenstrahler aus Aluminiumdruckguss; Oberfläche pulverbeschichtet; Strahlerkopf 355° dreh- und 90° schwenkbar; Konverter im Kunststoffadapter integriert; hochwertiger Reflektor mit sphärischer Facetenoptik; präzise Abstrahlcharakteristik mit verschiedenen Ausstrahlwinkeln; werkzeuglos einsetz- bzw. austauschbar; optische Aufsätze als Zubehör; optische Aufsätze miteinander kombinierbar; mit COB (Chip on Board) Technologie für höchste Effizienz; Varianten mit > 120 lm/W verfügbar; keine Bildung von Mehrfachschatten; energieeffiziente LEDs mit sehr guter Farbwiedergabe; Adapter für werkzeugloses Einsetzen bzw. Verschieben in verschiedenen 3-Phasen Stromschienen

### Quickinfo

3000 K, 4000 K  
CRI ≥ 90, 3 SDCM  
up to 129 lm/W  
L95 / 50 000 h  
non DIM, DALI-2

### Type

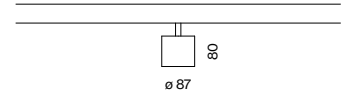

### Colours



### Light distributions



up to 129 lm/W  
(high efficiency)



355° rotatable  
90° tiltable

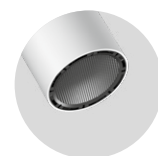

optical  
accessories



combine 2 optical  
accessories



## Order options

COLOUR TEMPERATURE	
3000K	0
4000K	1

CONTROL	
non DIM	1
DALI-2	3

MATERIAL COLOUR	
○ traffic white RAL 9016	7
● jet black RAL 9005	8

BEAM ANGLE	
spot 17°	S
medium 28°	M
flood 38°	F

## Options on request

COLOUR RENDERING INDEX	
CRI ≥ 80	

CONTROL	
Casambi	
DALI-2 (high efficiency)	

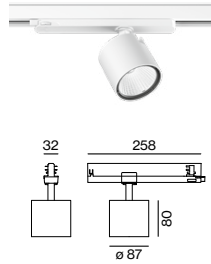

## VARO 80 S track



### TRACK LIGHT

SYSTEM POWER	LUMINOUS FLUX	ORDER CODE
28.5W	2600lm	180-6420
45W	3610lm	180-6421

### HIGH EFFICIENCY

SYSTEM POWER	LUMINOUS FLUX	ORDER CODE
21.3W	2730lm	180-6422
25.4W	3160lm	180-6423

## Optical accessories

### LENSES AND HONEYCOUMB LOUVER

TYPE	Ø-H (mm)	ORDER CODE
linear prismatic lens	75-9	080-6402110P
honeycomb louver	75-9	080-6401118

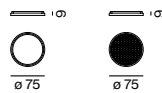

### SNOOT

TYPE	Ø-H (mm)	ORDER CODE
short	66-23	080-6403118
medium	66-38	080-6403218
angle	66-38	080-6403318

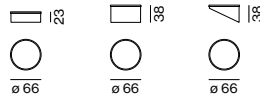

possibility to combine different optical accessories (max. 2 pieces)

**s.Oliver Store** Munich, DE –  
by Kitzig Interior Design GmbH  
including lighting design









## VARO 110 S

track

**EN** Track light made of die-cast aluminium; surface powder coated; spotlight head 355° rotatable and 90° tiltable; integrated converter in the plastic adapter; high quality reflector with spherical facet finish; precise radiation characteristics with different beam angles; installed and exchanged without tools; optical attachments as accessories; optical attachments can be combined; COB (Chip on Board) technology for maximum efficiency; variants with > 120 lm/W available; no multiple shadows; energy-efficient LEDs with very good colour rendering; adapter for toolless insertion or movement on a variety of 3-phase power tracks

**DE** Stromschienenstrahler aus Aluminiumdruckguss; Oberfläche pulverbeschichtet; Strahlerkopf 355° dreh- und 90° schwenkbar; Konverter im Kunststoffadapter integriert; hochwertiger Reflektor mit sphärischer Facettenoptik; präzise Abstrahlcharakteristik mit verschiedenen Ausstrahlwinkeln; werkzeuglos einsetz- bzw. austauschbar; optische Aufsätze als Zubehör; optische Aufsätze miteinander kombinierbar; mit COB (Chip on Board) Technologie für höchste Effizienz; Varianten mit > 120 lm/W verfügbar; keine Bildung von Mehrfachschatten; energieeffiziente LEDs mit sehr guter Farbwiedergabe; Adapter für werkzeugloses Einsetzen bzw. Verschieben in verschiedenen 3-Phasen Stromschienen

### Quickinfo

3000 K, 4000 K  
CRI ≥ 90, 3 SDCM  
up to 132 lm/W  
L95 / 50 000 h  
non DIM, DALI-2

### Type

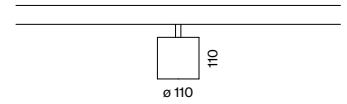

### Colours



### Light distributions



up to 132 lm/W  
(high efficiency)

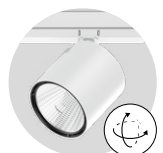

355° rotatable  
90° tiltable

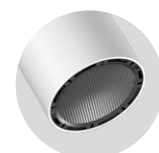

optical  
accessories



combine 2 optical  
accessories



## Order options

<b>COLOUR TEMPERATURE</b>	☼☼
3000K	0
4000K	1

<b>CONTROL</b>	⬆️⬆️
non DIM	1
DALI-2	3

<b>MATERIAL COLOUR</b>	☑️
○ traffic white RAL 9016	7
● jet black RAL 9005	8

<b>BEAM ANGLE</b>	▲
spot 17°	S
medium 28°	M
flood 38°	F
wide flood 65°	W

## Options on request

<b>LUMINOUS FLUX</b>
> 5000lm

<b>CONTROL</b>
Casambi
DALI-2 (high efficiency)

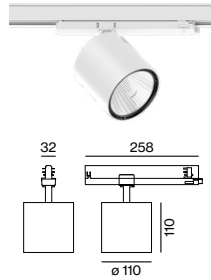

## VARO 110 S track



### TRACK LIGHT

SYSTEM POWER	LUMINOUS FLUX	ORDER CODE
29.6W	3370lm	180-6520 ☼☼▲
39W	4300lm	180-6521 ☼☼▲

### HIGH EFFICIENCY

SYSTEM POWER	LUMINOUS FLUX	ORDER CODE
25.7W	3400lm	180-6530 ☼☼▲
36W	4520lm	180-6531 ☼☼▲

## Optical accessories

### LENSES AND HONEYCOUMB LOUVER

TYPE	Ø-H (mm)	ORDER CODE
oval lens	106-9	080-6502210
wide flood lens	106-9	080-6502110W
honeycomb louver	106-9	080-6501118

### SNOOT

TYPE	Ø-H (mm)	ORDER CODE
short	97-23	080-6503118
medium	97-38	080-6503218
angle	97-38	080-6503318



possibility to combine different optical accessories (max. 2 pieces)

**Kastner & Öhler, Kaufhaus Tyrol**  
Innsbruck, AT – by DIOMA AG /  
WHIR3 / K&Ö Bauabteilung  
with lighting design by  
VEDDER.LICHTMANAGEMENT







# Versatile profile

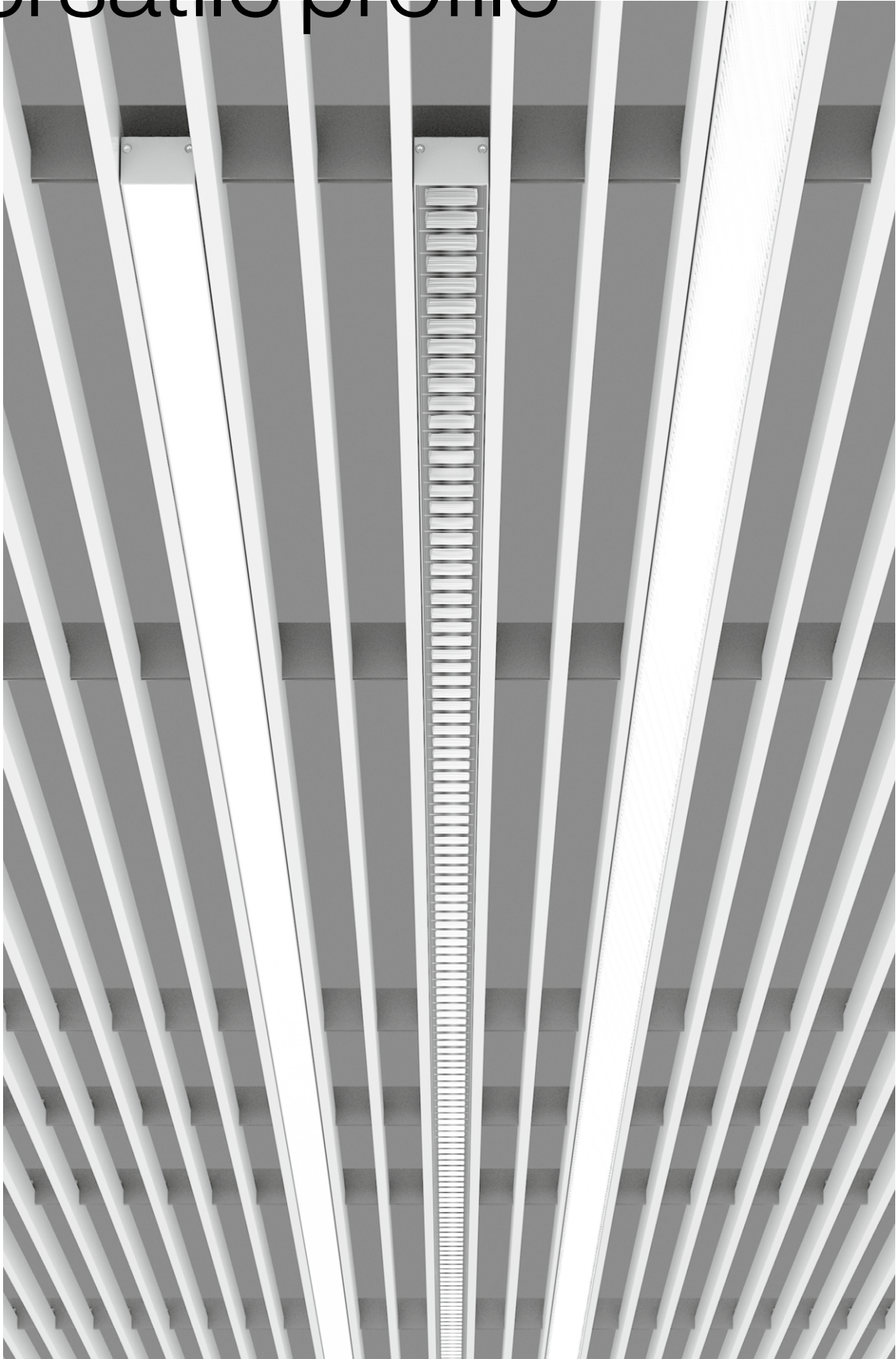



## MILA system

**EN** The MILA system luminaire was specially designed for use with slat ceilings and blends seamlessly into the respective room concept in entrance halls and office buildings. In meeting rooms and offices, the luminaire creates an ideal, screen-appropriate work light thanks to the optional addition of reflectors. In the opal cover variant, MILA is suitable for homogeneous room illumination; a reduced glare value is achieved with the optional microprismatic cover. For continuous lighting systems, the flexible Continuous Cover is the best choice. By adding special sensors, the MILA system luminaire becomes a smart lighting system. The sensors can be freely placed in the slatted ceiling and quickly integrated at a later stage. The collected room utilisation data helps to save energy over the long term.

**DE** Die MILA Systemleuchte wurde speziell für den Einsatz von Lamellendecken konzipiert und fügt sich in Eingangshallen sowie Bürogebäuden nahtlos in das jeweilige Raumkonzept ein. In Meetingräumen und Büros schafft die Leuchte ein ideales bildschirmtaugliches Arbeitslicht dank der wahlweisen Ergänzung durch Reflektoren. In der Opal-Cover-Variante eignet sich MILA für eine homogene Raumausleuchtung, ein reduzierter Blendwert wird mit der optionalen mikroprismatischen Abdeckung erreicht. Für durchgängige Lichtsysteme ist das flexible Continues Cover die beste Wahl. Durch die Erweiterung mit speziellen Sensoren wird die MILA Systemleuchte zum smarten Beleuchtungssystem. Die Sensoren können in der Lamellendecke frei platziert und nachträglich schnell integriert werden. Die hier gesammelten Daten zur Raumnutzung.

### Type



38

### Mounting



ceiling

### Configuration



linear

### Light distributions

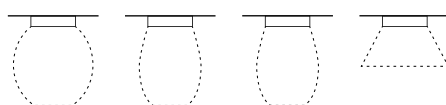

opal

micro-  
prismatic

reflector  
(UGR ≤ 19)

direct



## Advanced sensor technology

**EN** By adding special sensors, the MILA system luminaire becomes a smart lighting system. The sensors can be placed freely and flexibly in the slatted ceiling, and can also be integrated quickly and easily at a later stage. With the ESSENTIAL sensor, the lighting dynamically adapts to the ambient brightness and room activity. In addition, the SENSE sensor measures values for temperature, air quality, humidity, and noise level. These data not only provide important insights into the ambient conditions, but also support energy savings over the long term.

**DE** Durch die Erweiterung mit speziellen Sensoren wird die MILA Systemleuchte zum smarten Beleuchtungssystem. Die Sensoren können in der Lamellendecke frei und flexibel platziert werden und auch nachträglich schnell und einfach integriert werden. Mittels ESSENTIAL Sensor passt sich die Beleuchtung dynamisch an die Umgebungshelligkeit und Raumaktivität an. Ergänzend werden, mit dem SENSE Sensor, Werte zu Temperatur, Luftqualität, Luftfeuchtigkeit und Geräuschpegel gemessen. Diese Daten liefern nicht nur wichtige Erkenntnisse über die Umgebungsbedingungen, sondern unterstützen langfristig Energieeinsparungen.

## Continuous Cover

**EN** Both the opal and the microprismatic cover are available as continuous versions for the MILA system luminaires. This results in remarkable flexibility, as the length of the cover can be adapted exactly to the system. During installation, the Continuous Cover is simply integrated into the profile, avoiding interfering joints, and creating a pleasantly continuous lighting system.

**DE** Sowohl das opale als auch das mikroprismatische Cover stehen für die MILA Systemleuchten als Continuous Version zur Verfügung. Dadurch ergibt sich eine besondere Flexibilität, denn die Länge des Covers kann exakt an das System angepasst werden. Bei der Montage wird das Continuous Cover einfach in das Profil integriert, wodurch störende Stoßstellen vermieden werden und ein angenehm durchgehendes Lichtsystem entsteht.

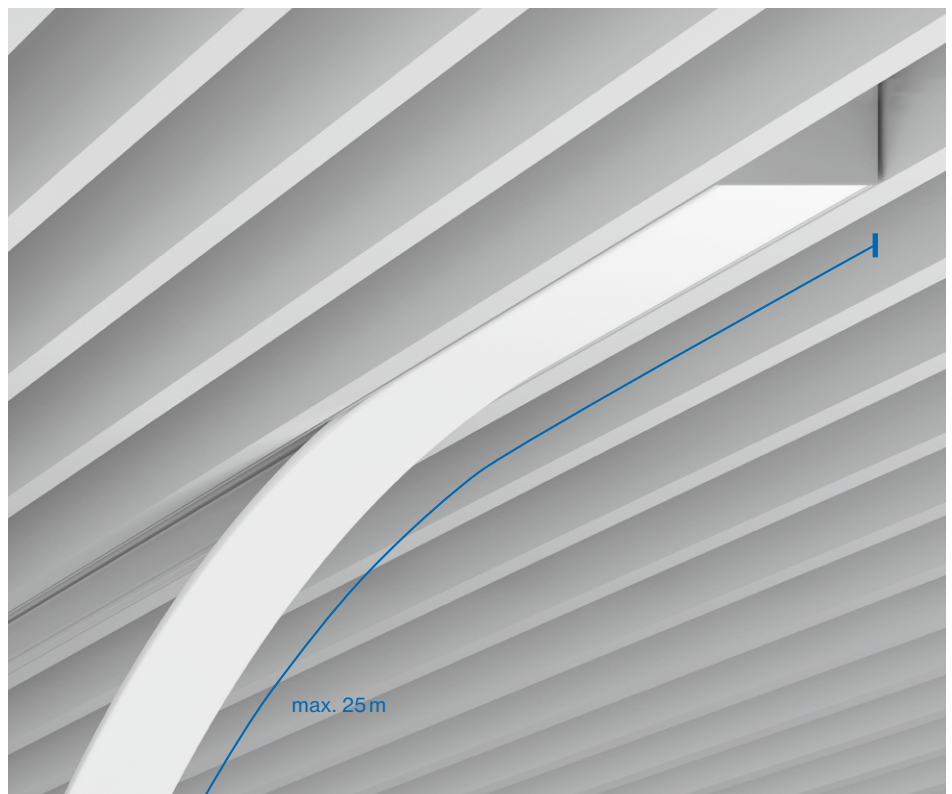

## Inset variety

**EN** Whether workplace lighting or general building areas – the MILA system luminaire can be adapted depending on the area of application. For screen-appropriate task lighting, the  $UGR \leq 19$  glare-reduced reflectors are the right choice. The optionally available opal cover is suitable for homogeneous ambient illumination. The microprismatics with reduced glare value are ideal for pleasantly illuminating entrance areas and corridors.

**DE** Ob Arbeitsplatzbeleuchtung oder allgemeine Gebäudebereiche – die MILA Systemleuchte lässt sich je nach Einsatzgebiet variieren. Für die bildschirmtaugliche Arbeitsplatzbeleuchtung sind die  $UGR \leq 19$  entblendeten Reflektoren die richtige Wahl. Das wahlweise erhältliche Opal-Cover ist für eine homogene Grundausleuchtung geeignet. Die Mikroprismatik mit reduziertem Blendwert ist ideal, um Eingangsbereiche und Gänge angenehm zu beleuchten.

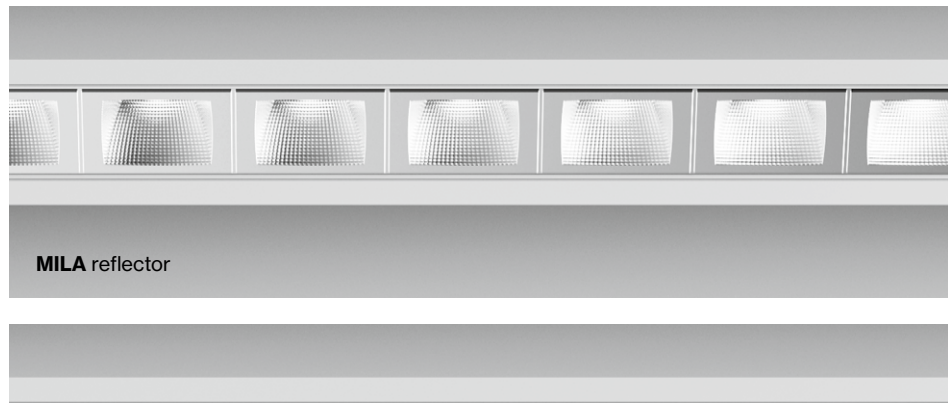

**MILA reflector**

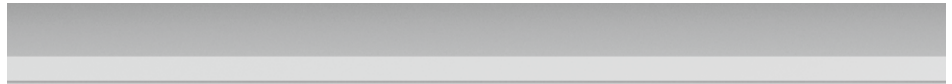

**MILA opal**



**MILA microprismatic**

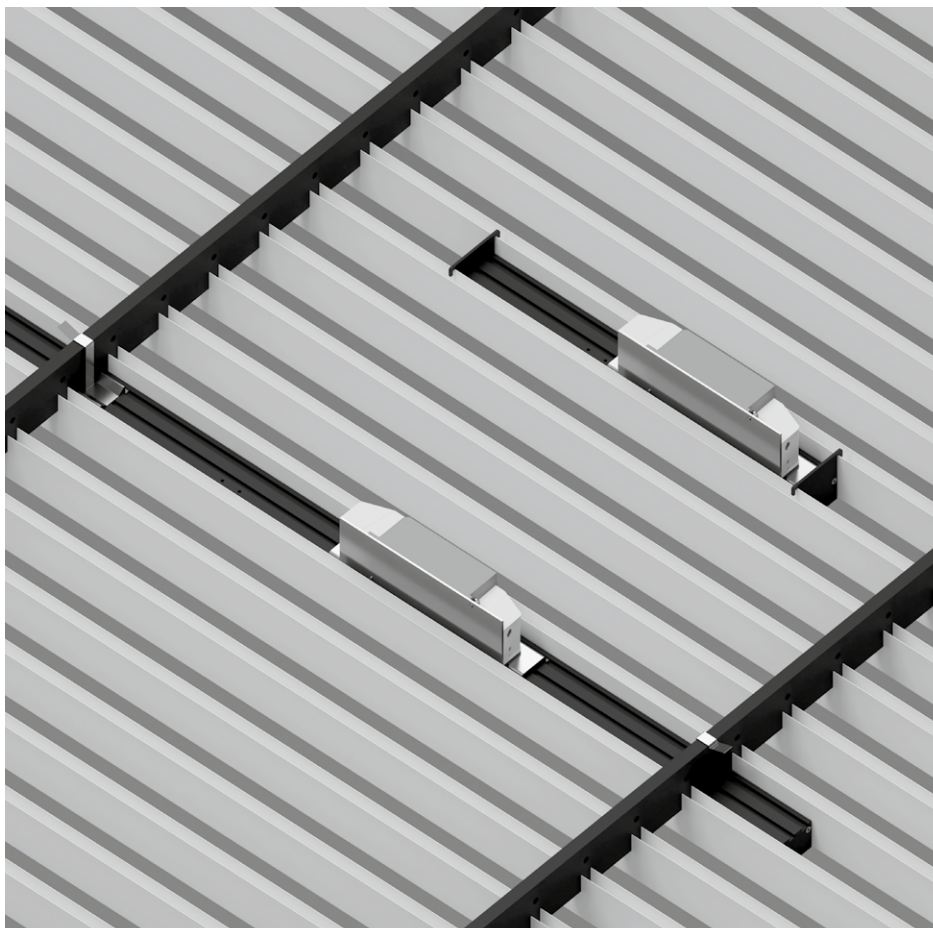

## Mounting

**EN** MILA can provide the right lighting in any room via sturdy mounting brackets that are hooked into the slatted ceiling. The brackets can be flexibly moved along the luminaire and can thus be positioned as required, or subsequently adjusted. Converters with wiring-through function facilitate electrical installation, as wiring can thus be carried out easily and quickly from one luminaire to another. In addition, the free movement of the converter allows a flexible response to ceiling conditions.

**DE** Über stabile Befestigungsklammern, welche an der Lamellendecke eingehängt werden, kann MILA in jedem Raum für die passende Beleuchtung sorgen. Die Klammern sind entlang der Leuchte flexibel verschiebbar und können so bedarfsorientiert platziert oder nachträglich angepasst werden. Konverter mit through wiring Funktion erleichtern die elektrische Montage, da die Verdrahtung so einfach und schnell von Leuchte zu Leuchte durchgeführt werden kann. Außerdem kann durch die freie Verschiebbarkeit des Converters flexibel auf die Deckengegebenheiten reagiert werden.



**HAUFE**  
DECKENSYSTEME

## MILA system

ceiling

**EN** Luminaire housing from extruded aluminium profile, angular design; designed for continuous lighting systems; suitable for installation in the HAUFE louvre ceiling system; surface powder coated; HPO (High Performance Opal) cover or microprismatic cover in the length of the light inset or continuous cover (both separately available); optional high gloss reflector with faceted design; converter flexible positionable on the luminaire profile; converter suitable for through-wiring; energy-efficient LEDs with very good colour rendering; optionally sensor inset (ESSENTIAL or SENSE) available as accessory

**DE** Leuchtenkörper aus Aluminiumstrangpressprofil, kantige Ausführung; ausgelegt für durchgehende Lichtsysteme; geeignet für den Einbau in das HAUFE Lamellendeckensystem; Oberfläche pulverbeschichtet; HPO (High Performance Opal) Abdeckung oder mikroprismatische Abdeckung in Lichteinsatzlänge oder durchgängige Abdeckung (beide separat zu bestellen); optional hochglänzender Reflektor mit Facettenoptik; Konverter flexibel am Leuchtenprofil positionierbar; Konverter für Weiterverdrahtung geeignet; energieeffiziente LEDs mit sehr guter Farbwiedergabe; wahlweise Sensor-Einsatz (ESSENTIAL oder SENSE) als Zubehör erhältlich

### Quickinfo

3000K, 4000K  
CRI  $\geq$  90, 3 SDCM  
UGR  $\leq$  19 / 65°  $\leq$  1500 cd/m<sup>2</sup>  
up to 115 lm/W  
up to 103 lm/m  
L90 @ 50 000h  
DALI-2  
opal, microprismatic  
reflector (UGR  $\leq$  19)

### Types

opal / microprismatic

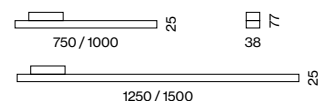

reflector

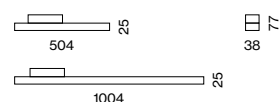

### Colours



### Light distribution



direct



DiiA® standards  
251, 252, 253



suitable for  
HAUFE ceilings

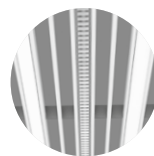

continuous  
lighting system

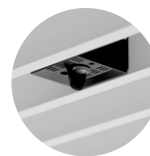

sensor for  
single mounting



DIN EN 12464-1  
UGR  $\leq$  19



up to 115 lm/W  
(high efficiency)

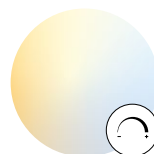

tunable white  
2700-6500K

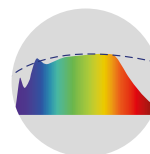

CRI  $\geq$  98  
XPECTRUM



## Order options

<b>COLOUR TEMPERATURE</b>	<input type="checkbox"/>
3000K	0
4000K	1

<b>CONTROL</b>	
DALI-2	

<b>MATERIAL COLOUR</b>	<input checked="" type="checkbox"/>
<input type="radio"/> traffic white RAL 9016	7
<input checked="" type="radio"/> jet black RAL 9005	8

<b>LIGHT OPTIC COVER</b>	<input checked="" type="checkbox"/>
opal	H
microprismatic	Z
reflector (UGR ≤ 19)	

## Options on request

<b>COLOUR RENDERING INDEX</b>	
CRI ≥ 98 XPECTRUM	

<b>COLOUR TEMPERATURE</b>	
tunable white 2700–6500K	

<b>SLAT CEILING SOLUTION</b>	
Hunter Douglas	
Interalu SAPPceiling	

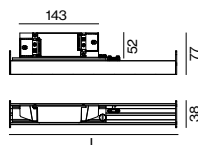

## MILA opal / microprismatic ceiling



### SYSTEM LUMINAIRE

SYSTEM POWER	L (mm)	ORDER CODE
15.8W	750	0 45 - 9 0 2 2 :: 3 <input checked="" type="checkbox"/>
21W	1000	0 45 - 9 0 2 3 :: 3 <input checked="" type="checkbox"/>
25W	1250	0 45 - 9 0 2 4 :: 3 <input checked="" type="checkbox"/>
31W	1500	0 45 - 9 0 2 5 :: 3 <input checked="" type="checkbox"/>

### COVER

TYPE	L (mm)	ORDER CODE
linear	750	0 0 6 - 4 1 0 7 5 1 0 <input type="checkbox"/>
linear	1000	0 0 6 - 4 1 1 0 0 1 0 <input type="checkbox"/>
linear	1250	0 0 6 - 4 1 1 2 5 1 0 <input type="checkbox"/>
linear	1500	0 0 6 - 4 1 1 5 0 1 0 <input type="checkbox"/>
continuous linear	6000	0 0 6 - 2 1 0 6 0 1 0 <input type="checkbox"/>
continuous linear	25000	0 0 6 - 2 1 2 5 0 1 0 <input type="checkbox"/>

LIGHT OPTIC COVER	COLOUR TEMPERATURE	SYSTEM POWER	DELIVERED LUMENS	EFFICACY
opal	3000 K	21W/m	2200lm/m	105lm/W
	4000 K		2420lm/m	115lm/W
microprismatic	3000 K	21W/m	2090lm/m	100lm/W
	4000 K		2300lm/m	110lm/W

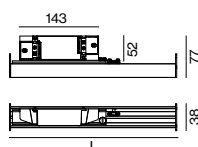

## MILA reflector ceiling

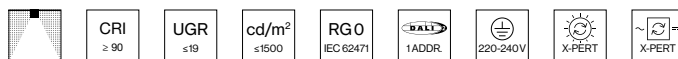

### SYSTEM LUMINAIRE

SYSTEM POWER	L (mm)	ORDER CODE
11W	504	0 4 5 - 9 1 2 1 :: 3 <input checked="" type="checkbox"/> R
22W	1004	0 4 5 - 9 1 2 3 :: 3 <input checked="" type="checkbox"/> R

LIGHT OPTIC COVER	COLOUR TEMPERATURE	SYSTEM POWER	DELIVERED LUMENS	EFFICACY
reflector (UGR ≤ 19)	3000 K	22W/m	2790lm/m	126lm/W
	4000 K		2950lm/m	133lm/W

## Accessories

### END CAPS

TYPE	ORDER CODE
end caps (pair)	0 4 5 - 9 0 9 0 0 1 <input checked="" type="checkbox"/>

### LINEAR CONNECTOR

TYPE	ORDER CODE
mechanical linear connector	0 4 5 - 9 0 9 1 0 1 0

### SENSOR DALI-2

TYPE	ORDER CODE
ESSENTIAL (brightness & presence)	0 4 5 - 9 0 9 6 0 1 <input checked="" type="checkbox"/>
SENSE (brightness, presence, temperature, sound pressure, humidity, CO <sub>2</sub> )	0 4 5 - 9 0 9 6 0 2 <input checked="" type="checkbox"/>

**Viega GmbH** Attersee, AT –  
by ATP Planungs- und Beteiligungs AG with  
lighting design by Andreas Haidegger







# Spotlight your profile





## FRAME/MINO 40 system

**EN** The FRAME 40 and MINO 40 system luminaires set no limits on profile-based ambient lighting. Thanks to special Flex Insets, the system luminaires can be shortened on-site and thus adapted to all conditions. Corner connectors create continuous lighting systems. For particularly uniform room illumination, the profile luminaires are fitted with an opal cover. In addition, spotlight insets can be selected for elegant accent lighting in corridors or entrance areas. Select a light colour of 3000K, 4000K, or optionally Tunable White, and a colour rendering of up to  $\text{CRI} \geq 98$  (XPECTRUM).

**DE** Mit der FRAME 40 und MINO 40 Systemleuchte sind Ihnen in puncto profilbasierter Grundausleuchtung keine Grenzen gesetzt. Aufgrund spezieller Flex-Insets können die Systemleuchten vor Ort gekürzt und somit an alle Gegebenheiten angepasst werden. Durch Eckverbinder entstehen so durchgängige Lichtsysteme. Für eine besonders einheitliche Raumausleuchtung wurden die Profilleuchten mit einer Opal-Abdeckung ausgestattet. Zusätzlich können Spots Insets zur eleganten Akzentuierung in Gängen oder Eingangsbereichen gewählt werden. Die Lichtfarbe ist aus 3000K, 4000K und wahlweise Tunable White und einer Farbwiedergabe von bis zu  $\text{CRI} \geq 98$  (XPECTRUM) wählbar.

### Type



40

### Mountings

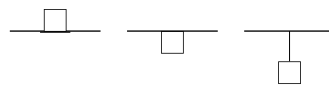
with trim  
recessed

surface

suspended

### Configurations



linear

corner

### Light distributions

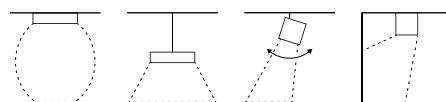

opal

direct

spotlight

wallwasher  
floor

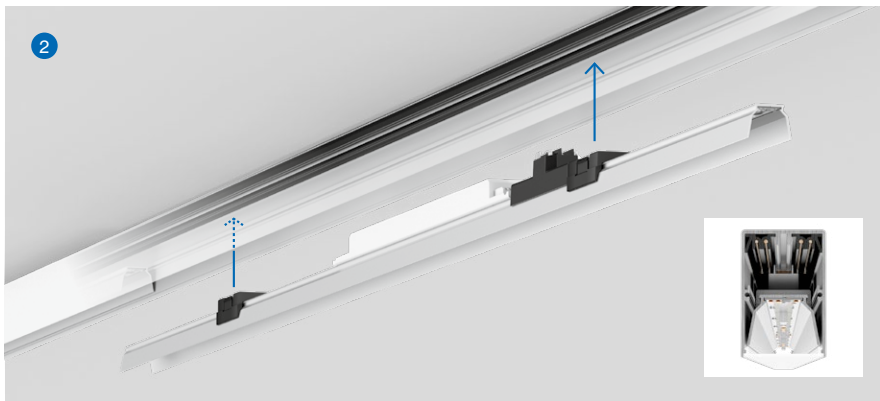
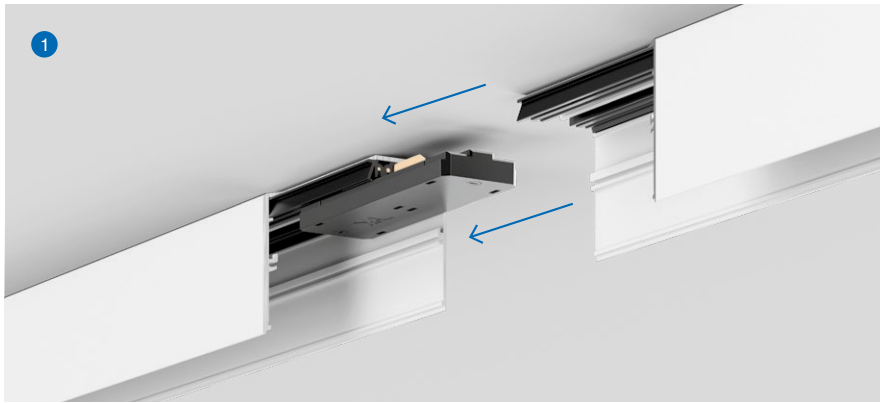

## Easy Mounting

**EN** MINO 40/FRAME 40 is based on a profile with an integrated track, which makes only one power feed point necessary.

(1) Two profiles are connected to each other with mechanical and electrical connectors.

(2) The patent-pending snap-in system allows the inset to be quickly and easily mounted in the profile. This simplifies the installation and maintenance of the system.

(3) The flexible Continuous Cover can be adjusted exactly to the length of the system and simply installed in the profile during mounting. This creates a continuous lighting system without disturbing joints.

**DE** MINO 40/FRAME 40 basiert auf einem Profil mit integrierter Stromschiene, wodurch lediglich eine Einspeisungsstelle benötigt wird.

(1) Mittels mechanischen und elektrischen Steckverbindern werden zwei Profile einfach miteinander verbunden.

(2) Durch das, zum Patent angemeldete, Snap-In System lässt sich das Inset schnell und unkompliziert in das Profil einsetzen. Dies vereinfacht die Montage und Wartung des Systems.

(3) Das flexible Continuous Cover kann exakt auf die Länge des Systems angepasst und einfach bei der Montage in das Profil eingebaut werden. Dadurch entsteht ein durchgängiges Lichtsystem ohne störende Stoßstellen.

## Full-spectrum LED

**EN** XAL's new XPECTRUM LEDs deliver healthy, biologically effective light. The reduced blue light component and increased cyan values reduce the blue light hazard for the eye to daylight-equivalent levels. The resulting non-visual, so-called melanopic light effect, improves concentration and increases sleep quality. The excellent colour rendering of IES TM 30-15  $R_f=98$  and  $R_g=101$  further helps visual comfort.

**DE** Die neue XPECTRUM LED von XAL sorgt für gesundes, biologisch wirksames Licht. Der reduzierte Blaulichtanteil sowie die erhöhten Cyan-Werte minimieren die Blaulichtgefahr für das Auge auf ein tageslichtähnliches Niveau. Die daraus resultierende nichtvisuelle, auch melanopische Lichtwirkung genannt, fördert die Konzentration und steigert die Schlafqualität. Die hervorragende Farbwiedergabe von IES TM 30-15  $R_f=98$  und  $R_g=101$  ermöglicht zudem einen verbesserten Sehkomfort.

### XPECTRUM LED

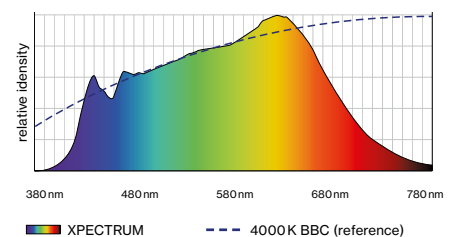

### Commercially available LED 4000 K

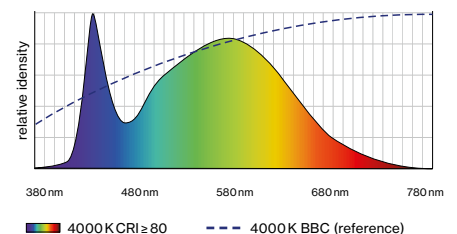

## Precise planning with flex insets

**EN** Your lighting system can be easily adapted to existing room dimensions. You can determine bespoke lengths for MINO 40 / FRAME 40. The special flex insets are precisely and flexibly adapted on-site during assembly. Boards are simply cut off at prefabricated break-points. These are positioned at 62.5mm or 125mm, depending on the length of the profile. This gives you a free hand and minimal restrictions in the lighting design.

**DE** Ihr Lichtsystem lässt sich einfach an vorhandene Raumdimensionen anpassen. Für MINO 40 / FRAME 40 können Sie individuelle Längen bestimmen. Die speziellen Flex-Insets werden vor Ort bei der Montage exakt und flexibel angepasst: Platinen werden einfach an vorgefertigten Bruchstellen abgetrennt. Diese befinden sich je nach Länge des Profils bei 62,5mm oder 125mm. Dadurch haben Sie freie Hand und kaum Einschränkungen bei der Lichtplanung.

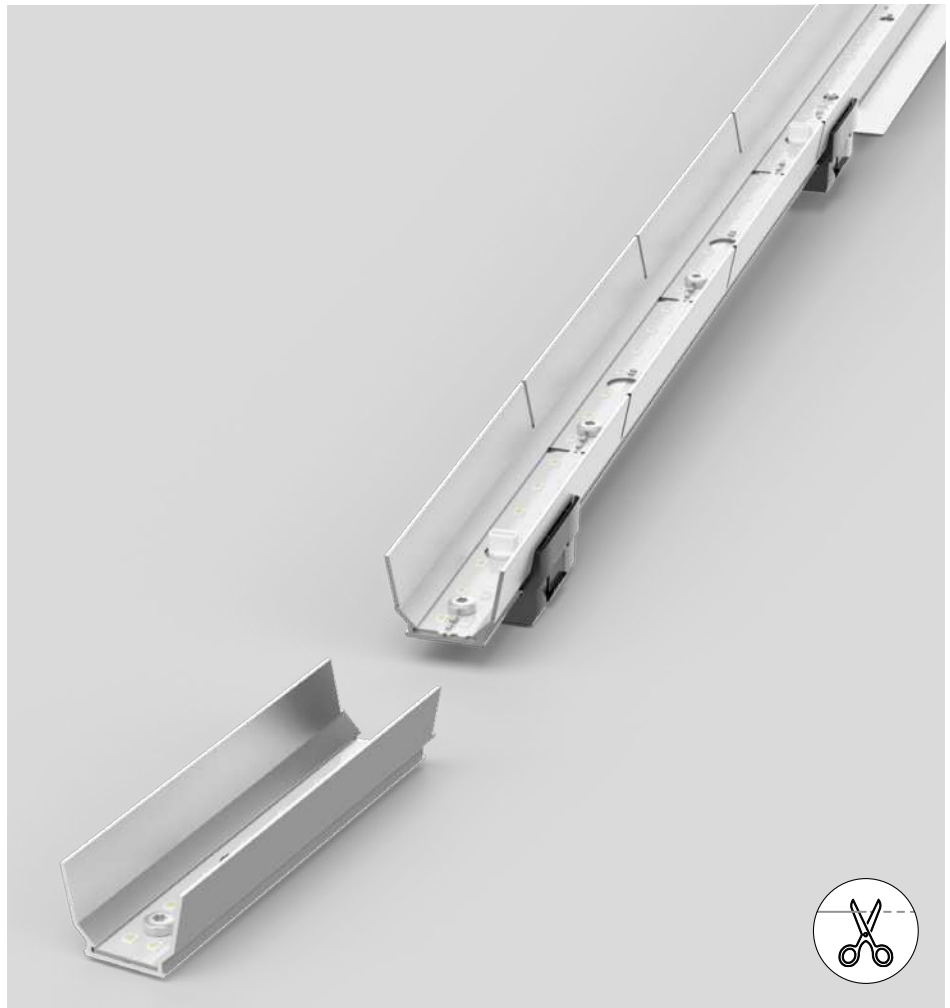

## Spot Insets

**EN** Elegant room accentuation and reduced design: with the new Spot Insets, the system luminaires become convertible luminaires for stylish wall, floor, and ceiling accentuation. In addition, the Wallwasher Floor light inset is perfect for uniform illumination of a blackboard in the classroom, or a corridor. The tool-free installation of the insets is completed in one move, the spotlights can be simply unlocked and snapped into place.

**DE** Elegante Raumakzentuierung und reduziertes Design: Mit den neuen Spot Insets werden die Systemleuchten zu wandelbaren Leuchten für eine stilvolle Wand-, Boden- und Deckenakzentuierung. Zudem eignet sich der Wallwasher Floor Lichteinsatz perfekt für eine gleichmäßige Ausleuchtung einer Tafel im Klassenzimmer oder eines Korridors. Die werkzeuglose Montage der Insets erfolgt durch einen Handgriff, die Strahler können einfach entriegelt und eingearastet werden.



## FRAME 40 system

recessed with trim

**EN** Luminaire housing made of extruded aluminium; recessed luminaire with trim; designed for continuous lighting systems; suitable for ceiling thickness of 8-25 mm; surface powder coated; luminaire profile for mounting available in advance; remaining luminaire components mounted without tools; HPO (High Performance Opal) cover in the length of the light inset or continuous cover (both separately available); pre-assembled power rail for power supply in luminaire profile; voltage tap of the light inset on the power rail; light inset consisting of highly reflective coated extruded profile for improved thermal management; energy-efficient LEDs with very good colour rendering; optionally spotlight modules can be installed

**DE** Leuchtenkörper aus Aluminiumstrangpressprofil; Einbauleuchte mit umlaufendem Rand; ausgelegt für durchgehende Lichtsysteme; geeignet für Deckenstärken von 8-25 mm; Oberfläche pulverbeschichtet; Leuchtenprofil für Montage vorab lieferbar; restliche Leuchtenkomponenten werkzeuglos montierbar; HPO (High Performance Opal) Abdeckung in Lichteinsatzlänge oder durchgängige Abdeckung (beide separat zu bestellen); vormontierte Stromschiene zur Spannungsversorgung im Leuchtenprofil; Lichteinsatz-Spannungsabgriff an der Stromschiene; Lichteinsatz bestehend aus hochreflektierend lackiertem Strangpressprofil für verbessertes Thermomanagement; energieeffiziente LEDs mit sehr guter Farbwiedergabe; wahlweise Strahlereinsätze einsetzbar

### Quickinfo

3000 K, 4000 K  
 CRI ≥ 90, 3 SDCM  
 up to 2420 lm/m  
 up to 123 lm/W  
 L85 @ 50 000 h  
 DALI-2

### Types

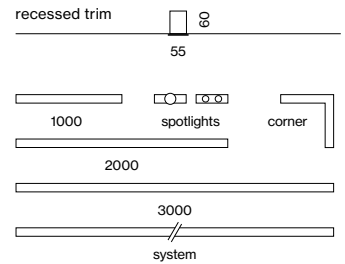

### Colours



### Light distributions

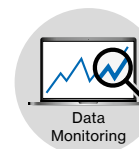

DiiA® standards  
251, 252, 253

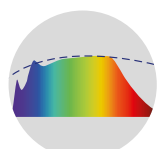
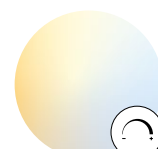



**Order options**

LED TYPE	
mid lumen	1
high lumen	2

COLOUR TEMPERATURE	
3000K	0
4000K	1

CONTROL	
DALI-2	

MATERIAL COLOUR	
○ traffic white RAL 9016	7
● white aluminium RAL 9006	G
● jet black RAL 9005	8

LENGTH	
1000 mm	1
2000 mm	2
3000 mm	3

LIGHT OPTIC COVER	
opal high performance	

**Options on request**

COLOUR RENDERING INDEX	
CRI ≥ 98 XPECTRUM	

COLOUR TEMPERATURE	
tunable white 2700–6500K	

LIGHT OPTIC COVER	
microprismatic	

**FRAME 40 trim**

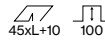

**INSTALLATION CHANNEL**

TYPE	L (mm)	ORDER CODE
channel	1000	042-700201
channel	2000	042-700401
channel	3000	042-700601
channel corner 90°/opal cover	500x500	042-700C01

**LIGHT OPTIC COVER 40**

TYPE	L (mm)	ORDER CODE
linear cover	see left	006-42 L0010H
continuous linear cover	6000	006-2206010H
continuous linear cover	30000	006-2230010H
blind cover	see left	006-42 L001B



**LIGHT INSET 40**

SYSTEM POWER (MID/HIGH LUMEN)	L (mm)	ORDER CODE
12.4/20.1W	1000	042-01 2 37
24.8/40W	2000	042-01 4 37
37/60W	3000	042-01 6 37
12.4/20.1W flex	500–1000	042-01 F 37
24.8/40W flex	1500–2000	042-01 G 37

LED TYPE / COVER	SYSTEM POWER	DELIVERED LM	EFFICACY
mid lumen/opal/4000K	12.4W/m	1430lm/m	116lm/W
high lumen/opal/4000K	20.1W/m	2240lm/m	112lm/W

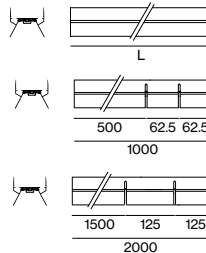

**Spotlight Insets**

see page 130

**Accessories**

**END CAPS**

TYPE	ORDER CODE
end caps (pair)	042-709001



**POWER FEEDER UNIT**

TYPE	ORDER CODE
power feeder unit	042-1093230

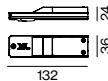

**LINEAR CONNECTOR**

TYPE	ORDER CODE
mechanical linear connector	042-7091110
mechanical & electrical linear connector	042-7091230
opal cover linear connector	042-1091910

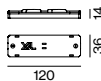

**MOUNTING BRACKET**

TYPE	CEILING THICKNESS (mm)	ORDER CODE
mounting bracket (1 piece)	8-25	042-7092110
mounting bracket (25 pieces)	8-25	042-7092110.25

number of brackets required: length of your system in metres+1

LUMINOUS FLUX value calculated for 4000K, CRI ≥ 90, colour white, cover opal 3000K -5%

**Psychiatrische Klinik Königshof** Krefeld, DE –  
by alsh sander.hofrichter architekten GmbH



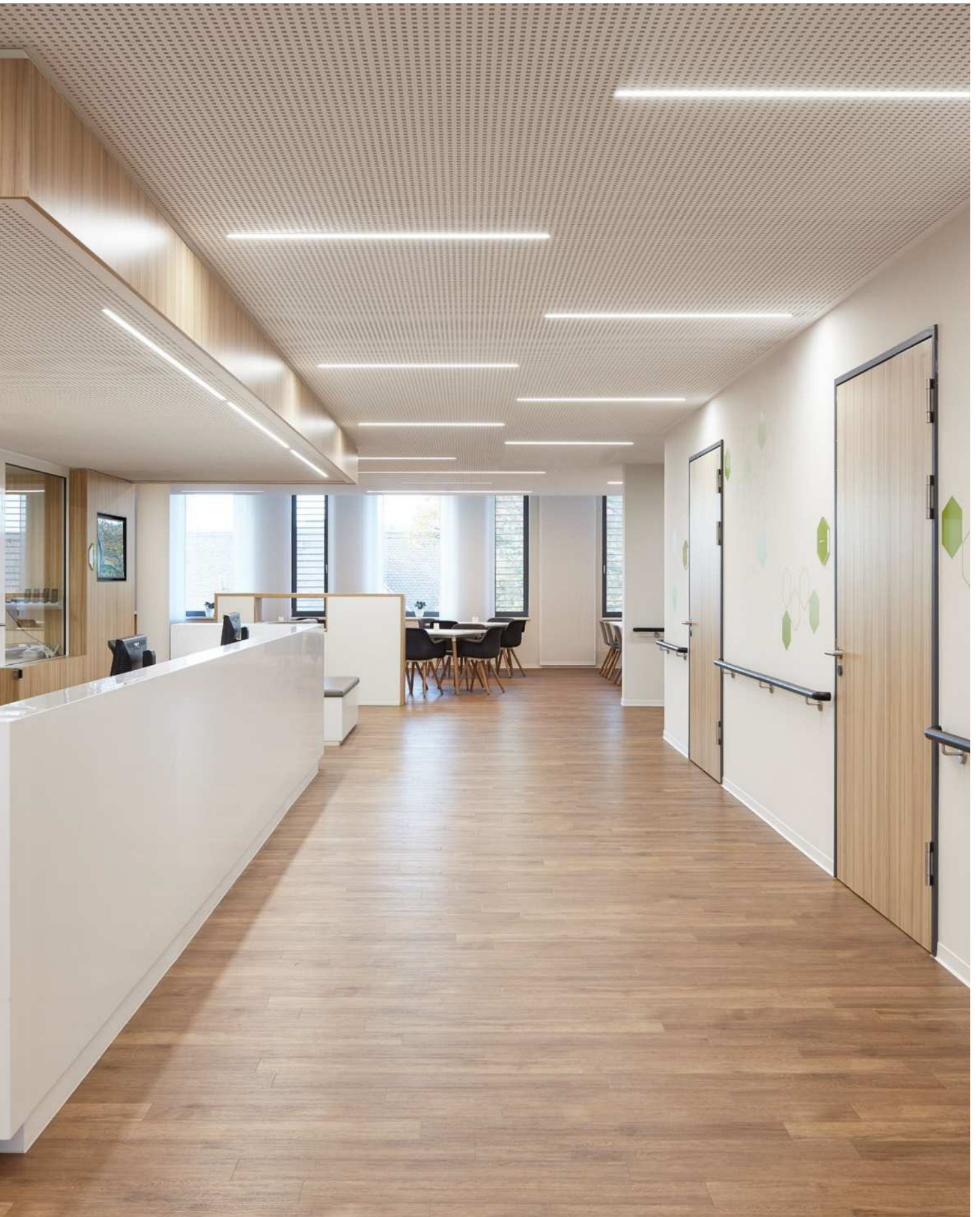



## MINO 40 system

ceiling / suspended

**EN** Luminaire housing from extruded aluminium profile, angular design; no visible screws; for lighting systems; powder coated; luminaire profile for mounting available in advance; remaining luminaire components mounted without tools; HPO (High Performance Opal) cover in the length of the light inset or continuous cover (both separately available); pre-assembled power rail for power supply in luminaire profile; voltage tap of the light inset on the power rail; ceiling surface mounting or suspended mounting; height adjustment without tools; with transparent feeder cable; light inset consisting of highly reflective coated extruded profile, improved thermal management; energy-eff. LEDs - very good colour rendering; optionally spotlight modules can be installed

**DE** Leuchtenkörper aus Aluminiumstrangpressprofil, kantige Ausführung; keine sichtbaren Schrauben; für Lichtsysteme; pulverbeschichtet; Leuchtenprofil für Montage vorab lieferbar; restliche Leuchtenkomponenten werkzeuglos montierbar; HPO (High Performance Opal) Abdeckung in Lichteinsatzlänge oder durchgängige Abdeckung (beide separat zu bestellen); vormontierte Stromschiene zur Spannungsversorgung im Leuchtenprofil; Lichteinsatz-Spannungsabgriff an der Stromschiene; Deckenanbau oder abgehängte Montage; werkzeuglose Höhenverstellung; inkl. transp. Einspeiseleitung; Lichteinsatz aus hochreflektierend lackiertem Strangpressprofil, verbessertes Thermomanagement; energieeff. LEDs - sehr gute Farbwiedergabe; wahlweise Strahlereinsätze einsetzbar

### Quickinfo

3000 K, 4000 K  
CRI ≥ 90, 3 SDCM  
up to 2420 lm/m  
up to 123 lm/W  
L85 @ 50 000 h  
DALI-2

### Types

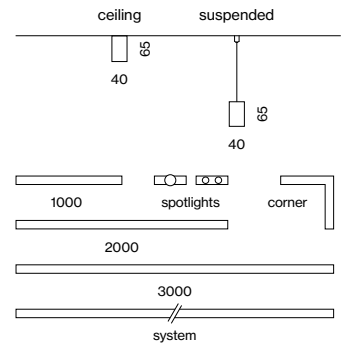

### Colours



### Light distributions

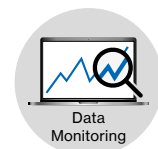

DiiA® standards  
251, 252, 253



snap-in system  
(patent pending)



spotlight  
insets (p.130)



breakable  
flex insets

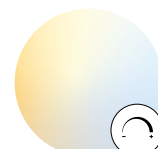

tunable white  
2700–6500 K

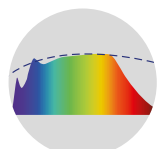

CRI ≥ 98  
XPECTRUM



**Order options**

<b>LED TYPE</b>	
mid lumen	1
high lumen	2

<b>COLOUR TEMPERATURE</b>	
3000K	0
4000K	1

<b>CONTROL</b>	
DALI-2	

<b>MATERIAL COLOUR</b>	
<input type="radio"/> pure white RAL 9010	7
<input checked="" type="radio"/> white aluminium RAL 9006	G
<input type="radio"/> jet black RAL 9005	8
special colours	X

<b>LENGTH</b>	
1000mm	1
2000mm	2
3000mm	3

<b>LIGHT OPTIC COVER</b>	
opal high performance	

<b>ACCESSORY COLOUR</b>	
<input type="radio"/> pure white RAL 9010	7
<input checked="" type="radio"/> jet black RAL 9005	8

**Options on request**

<b>COLOUR RENDERING INDEX</b>	
CRI ≥ 98 XPECTRUM	

<b>COLOUR TEMPERATURE</b>	
tunable white 2700–6500K	

<b>LIGHT OPTIC COVER</b>	
microprismatic	

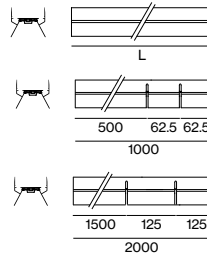

**MINO 40 ceiling/suspended**

**INSTALLATION CHANNEL**

TYPE	L (mm)	ORDER CODE
channel	1000	0 4 2 - 1 0 0 2 0 1
channel	2000	0 4 2 - 1 0 0 4 0 1
channel	3000	0 4 2 - 1 0 0 6 0 1
channel corner 90°/opal cover	500×500	0 4 2 - 1 0 0 C 0 1

**LIGHT OPTIC COVER 40**

TYPE	L (mm)	ORDER CODE
linear cover	see left	0 0 6 - 4 2 L 0 0 1 0 H
continuous linear cover	6000	0 0 6 - 2 2 0 6 0 1 0 H
continuous linear cover	30000	0 0 6 - 2 2 3 0 0 1 0 H
blind cover	see left	0 0 6 - 4 2 L 0 0 1



**LIGHT INSET 40**

SYSTEM POWER (MID/HIGH LUMEN)	L (mm)	ORDER CODE
12.8/21W	1000	0 4 2 - 0 1  2  3 7
25.6/42W	2000	0 4 2 - 0 1  4  3 7
38/63W	3000	0 4 2 - 0 1  6  3 7
12.8/21W flex	500–1000	0 4 2 - 0 1  F  3 7
25.6/42W flex	1500–2000	0 4 2 - 0 1  G  3 7

LED TYPE / COVER	SYSTEM POWER	DELIVERED LM	EFFICACY
mid lumen/opal/4000K	12.8W/m	1560lm/m	122lm/W
high lumen/opal/4000K	21W/m	2420lm/m	115lm/W

**Spotlight Insets**

see page 130

**Accessories**

**END CAPS**

TYPE	ORDER CODE
end caps (pair)	0 4 2 - 1 0 9 0 0 1



**POWER FEEDER UNIT**

TYPE	ORDER CODE
power feeder unit	0 4 2 - 1 0 9 3 2 3 0

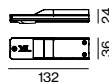

**LINEAR CONNECTOR**

TYPE	ORDER CODE
mechanical linear connector	0 4 2 - 7 0 9 1 1 1 0
mechanical & electrical linear connector	0 4 2 - 7 0 9 1 2 3 0
opal cover linear connector	0 4 2 - 1 0 9 1 9 1 0

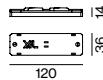

**CEILING FASTENER/CABLE SUSPENSION/CANOPY**

TYPE	L (mm)	ORDER CODE
ceiling fastener	10	0 5 0 - 2 0 4 1 1 1
cable suspension	1500	0 0 5 - 2 1 5 2 1 1 0
canopy		0 0 5 - 2 3 1 1 2 1
feeder cable (transparent)		0 0 5 - 2 4 1 2 4 1 0

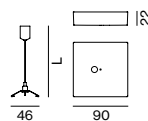

for electrical system configuration see luminaire data sheet at xal.com

LUMINOUS FLUX value calculated for 4000K, CRI ≥ 90, colour white, cover opal 3000K -5%



## SPOTLIGHT insets

profiles 40

**EN** Cylindrical spotlight made of aluminium; powder coated; spotlight can be installed without tools in MINO 40 system or FRAME 40 system; choice of single lamp or double lamps; spotlight head rotatable (WALLWASHER/FLOOR) or rotatable and tiltable (SPOTLIGHT); converter in the adapter; with optional high quality lens system with precise radiation characteristic; or high quality, aluminium, vapour deposition coated reflector with faceted design; precise radiation characteristics with different beam angles; optional asym. light distribution; good glare reduction due to recessed light point plane; optical attachments as accessories; COB (Chip on Board) technology or high power LEDs - maximum efficiency; no multiple shadows; energy-eff. LEDs - very good colour rendering

**DE** Zylindrischer Strahler aus Aluminium; pulverbeschichtet; Strahler in MINO 40 system oder FRAME 40 system werkzeuglos einsetzbar; wahlweise einflamig oder zweiflamig; Strahlerkopf drehbar (WALLWASHER/FLOOR) bzw. dreh- und schwenkbar (SPOTLIGHT); Konverter im Adapter; wahlweise mit hochwertiger Linsenoptik mit präziser Abstrahlcharakteristik; oder hochwertiger, aluminiumbedampfter Reflektor mit Facettenoptik; präzise Abstrahlcharakteristik mit verschiedenen Ausstrahlwinkeln; optional asym. Lichtverteilung; gute Entblendung durch zurückversetzte Lichtpunktebene; optische Aufsätze als Zubehör; COB (Chip on Board) Technologie bzw. High-Power-LEDs - höchste Effizienz; keine Mehrfachschatten; energieeff. LEDs - sehr gute Farbwiedergabe

### Quickinfo

3000K, 4000K  
CRI ≥ 90, 2 SDCM  
spotlight 32 up to 79 lm/W  
spotlight 45 up to 85 lm/W  
L80 @ 50000h  
DALI-2

### Types

SPOTLIGHT 32

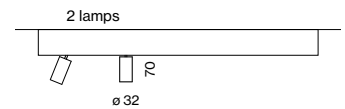

SPOTLIGHT 45

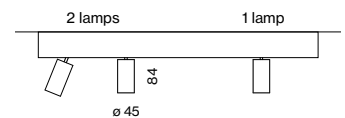

SPOTLIGHT 45 wallwasher floor



### Colours



### Light distributions



DiiA® standards  
251, 252, 253



snap-in system  
(patent pending)



wallwasher floor  
360° rotatable



wallwasher  
floor

## Order options

<b>COLOUR TEMPERATURE</b>	☼☼
3000K	0
4000K	1

<b>CONTROL</b>	
DALI-2	

<b>MATERIAL COLOUR</b>	☑
○ traffic white RAL 9016	7
● jet black RAL 9005	8

<b>BEAM ANGLE</b>	
<b>SPOTLIGHT 32</b>	▲
spot 18°	S
medium 23°	M
flood 37°	F

<b>BEAM ANGLE</b>	
<b>SPOTLIGHT 45</b>	▲
spot 14°	S
medium 24°	M
flood 39°	F

## SPOTLIGHT 32

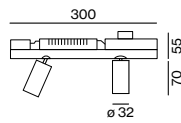

### 2 LAMPS

<b>SYSTEM POWER</b>	<b>LUMINOUS FLUX</b>	<b>ORDER CODE</b>
20.6 W	2 × 810 lm	0 4 2 - 0 6 1 0 :: 3 ▲
honeycomb louver		0 0 7 - 1 9 6 5 1 8 8

## SPOTLIGHT 45

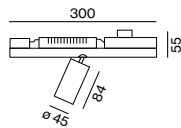
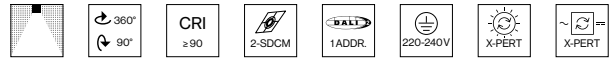

### 1 LAMP

<b>SYSTEM POWER</b>	<b>LUMINOUS FLUX</b>	<b>ORDER CODE</b>
15 W	spot 1060 lm	0 4 2 - 0 5 2 0 :: 3 ▲ S
15.9 W	medium, flood 1340 lm	0 4 2 - 0 5 2 0 :: 3 ▲
honeycomb louver		0 0 7 - 1 9 6 5 1 8 8

### 2 LAMPS

<b>SYSTEM POWER</b>	<b>LUMINOUS FLUX</b>	<b>ORDER CODE</b>
30 W	spot 2 × 1060 lm	0 4 2 - 0 6 2 0 :: 3 ▲ S
32 W	medium, flood 2 × 1340 lm	0 4 2 - 0 6 2 0 :: 3 ▲
honeycomb louver		0 0 7 - 1 9 6 5 1 8 8

## SPOTLIGHT 45 wallwasher / floor

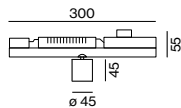

### 1 LAMP

<b>SYSTEM POWER</b>	<b>LUMINOUS FLUX</b>	<b>ORDER CODE</b>
9 W	659 lm	0 4 2 - 0 5 2 0 :: 3 ▲ W

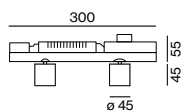

### 2 LAMPS

<b>SYSTEM POWER</b>	<b>LUMINOUS FLUX</b>	<b>ORDER CODE</b>
15.9 W	2 × 659 lm	0 4 2 - 0 6 2 0 :: 3 ▲ W

**Corridor**  
Visualisation





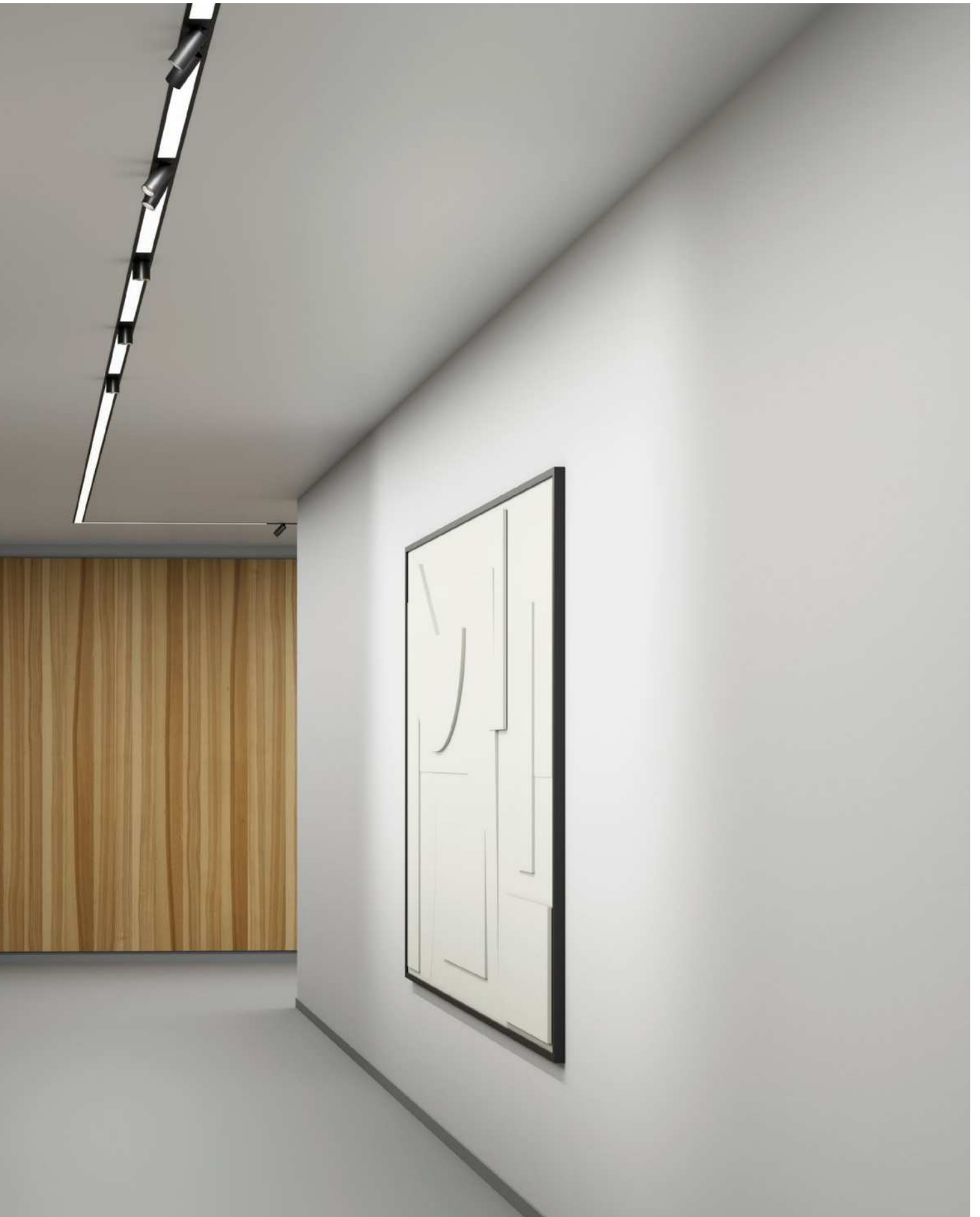

## Get in contact

EN We develop and perfect projects in dialogue with the architects and planners to make them unique. We see ourselves as your partner. From lighting design, the right product selection and control system to commissioning and maintenance, we are at your side throughout your project. Let's talk about your project: [office@xal.com](mailto:office@xal.com)

DE Wir haben es uns zu unserer Aufgabe gemacht, gemeinsam mit den ArchitektInnen und PlanerInnen die Projekte im Dialog zu entwickeln, zu perfektionieren und sie einzigartig zu machen. Wir sehen uns als Ihr Partner. Von der Lichtplanung über die richtige Produktauswahl und von der Steuerung bis hin zur Inbetriebnahme und Wartung stehen wir Ihnen in allen Phasen Ihres Projektes zur Seite. Reden wir über Ihr Projekt: [office@xal.com](mailto:office@xal.com)

### **XAL Headquarters**

XAL GmbH  
Auer-Welsbach-Gasse 36  
8055 Graz  
**AUSTRIA**  
T +43.316.3170  
[office@xal.com](mailto:office@xal.com)

All locations:  
[xal.com/contacts](http://xal.com/contacts)

## List of photographers

Kris Dekeijser (Cover), Kurt Kuball (p. 52-53 | 86-87 | 98-99 | 118-119), Tim Ertl (p. 66-67), Z. Gataric Fotografie (p. 90), Dan Preston (p. 91), Oberpollinger | The KaDeWe Group (p. 95 | 100-101), Jens Pfisterer (p. 110-111), Huy Nguyen (p. 106-107), Markus Bachmann (p. 126-127)

## Legal notices

**EN** Information in this catalogue was valid at the time of printing, is non-binding, and should be used for information purposes only. We are not liable for products that differ from illustrations or information. We reserve the right to make changes to our products at any time. All orders will be accepted exclusively in accordance with our general terms and conditions of business and delivery. The latest version of these terms and conditions is available at [www.xal.com](http://www.xal.com).

**DE** Die Angaben in diesem Katalog entsprechen dem Stand bei Drucklegung, sind unverbindlich und sollen ausschließlich Informationszwecken dienen. Für Abweichungen eines Produkts von Abbildungen oder Angaben wird keine Haftung übernommen. Wir behalten uns vor, jederzeit Änderungen an unseren Produkten vorzunehmen. Alle Aufträge werden ausschließlich zu unseren Allgemeinen Geschäfts- und Lieferbedingungen, die unter [www.xal.com](http://www.xal.com) eingesehen werden können, in der gültigen Fassung entgegengenommen.

